

e-chain

igus.com ... e-chains® and e-chain systems® ... plastics for longer life® ... 36 month guarantee

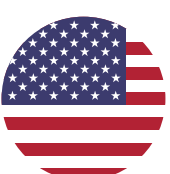
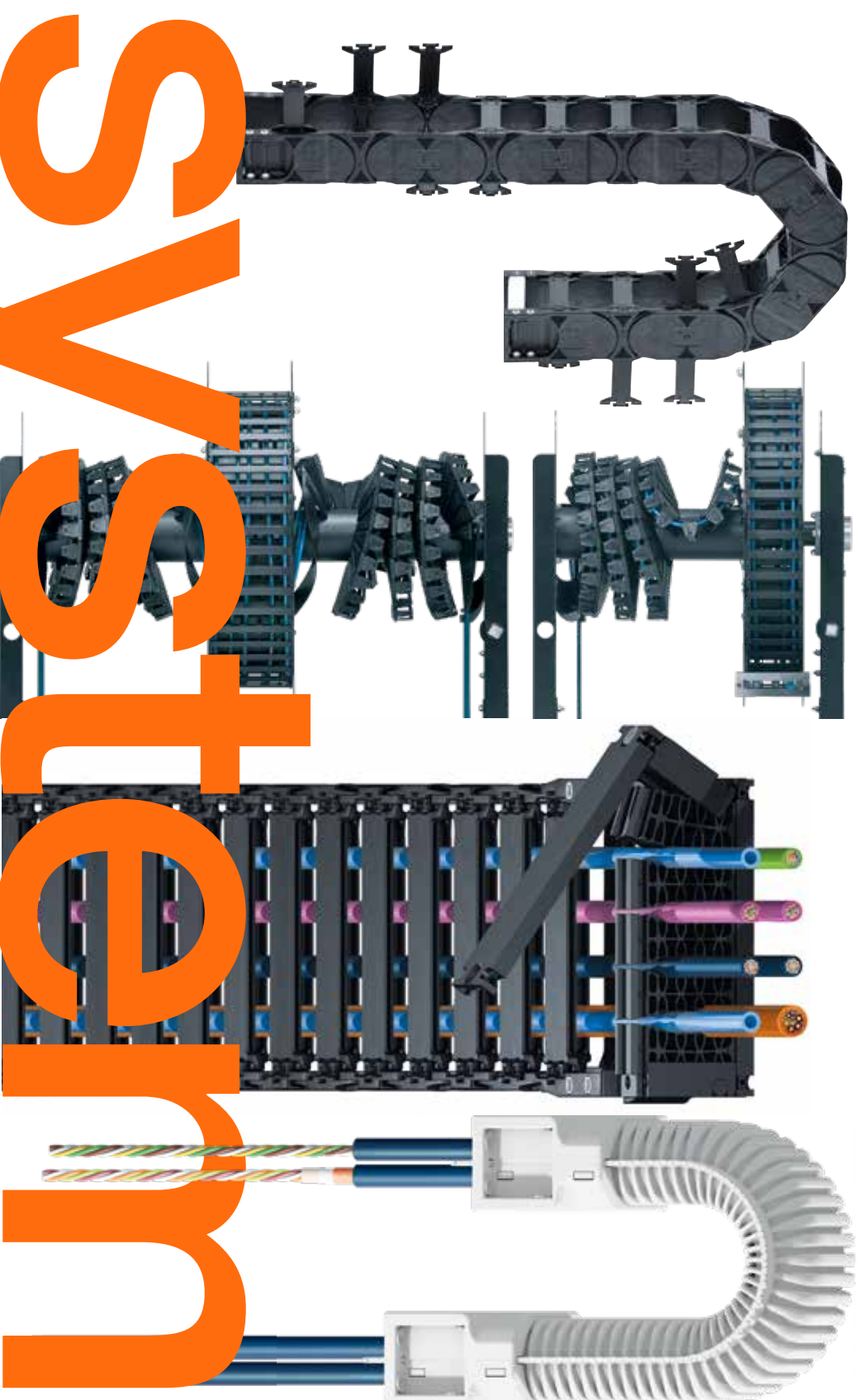

Same day shipping
from Rhode Island

Systems Plastics®

motion? plastics!

Increase service life and reduce costs ...

... the goal of all igus® products is to always offer at least one of these. Other benefits are the fast delivery time, shipped in as little as 24 hours, plus the service life calculation for nearly all product lines. We will be happy to send you free sample parts for your testing and prototypes. Tested and proven service life. Calculate and order online.



Over 600,000 feet of e-chain ...
Over 4,000,000 feet of cable ...
available from stock
from our Corporate Headquarters
located in East Providence, RI

*On average 90% of orders ship same day.



36 month Guarantee

e-chain® and chainflex guarantee according to service life calculator**
www.igus.com/info/e-chain-guarantee



e-chain Test Drive Program

Qualified customers can receive a working system to test drive.
Call for details 800-521-2747



online chat! - igus® product experts available for chat on our website, weekdays 8:00 am to 8:00 pm



Online shop - Discover 100,000 products in our online shop and order around-the-clock! www.igus.com



Installation & inspection services

igus® has a team of dedicated engineers ready to assist you during every phase of installation & inspection.



No minimum order!

No surcharges!
You can find our prices online at www.igus.com



Schedule a visit! - Contact your local salesperson to schedule a Lunch-n-Learn, in-house Traveling Tradeshow or have the igus® Roadshow Trailer visit your facility. www.igusontour.com



Virtual visits! Digital consultation made easy. Assembly tips, on-site machine visits, interactive presentations.

www.igus.com/info/virtual-visit



Calculate and configure online

Download 3D CAD models free of charge. Quickly find the product you are looking for with our product finders and configurators. www.igus-cad.com



For questions or more information

contact us
Weekdays 8 am to 8 pm
Phone 800-521-2747
Fax 401-438-7270



Contact an igus expert

www.igus.com/info/contact-igus



Free samples

www.igus.com/samples

** The e-chain® service life guarantee is valid for the indicated number of double strokes calculated according to the igus® online service life calculator or for a maximum of 36 months after the delivery date, whichever comes first.



Designing with igus® e-chains® - calculation tools, diagrams, applications

readychain® and readycable®,
igus® installation service with guarantee

► From page

1.1



igus® solutions for simple applications

e-rib, E1, snapchain, office e-chain®

► From page

2.1

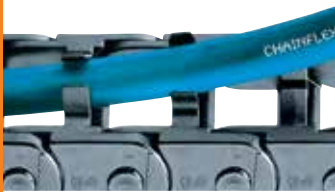

Cost-effective, easy to fill e-chains® with "easy" design

E-Z chain®

► From page

2.41



Zip-open, easy to fill e-chains®

zipper e-chains® and e-tubes

► From page

3.1



All-rounder e-chains® and e-tubes micro ... mini ... medium

E2 micro, mini, E2.1 micro, E2.1, E2/000

► From page

4.1



Protection against dirt and chips openable igus® e-tubes

E2 e-tubes - series E2 R100, E2 R, R2.1, RX

► From page

5.1



E4 - universal modular kit - e-chains® and e-tubes for any application

E4.1L, E4.1, E4/light

► From page

6.1



Cleanroom e-chains® and e-tubes low noise, low vibration and high dynamics

T3, E3, E6-1, E6, e-skin®

► From page

7.1

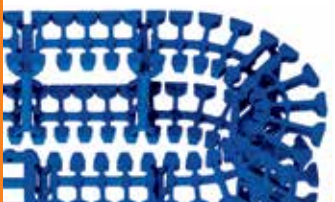

e-chain® designed according to hygienic principles - FDA and EU-compliant materials

System TH3

► From page

7.149

Register now for the igus® newsletter ...



Call igus®
800.521.2747



Avoid cable failure with
chainflex
Cables

Why cable bend radius factor matters

Have you ever wondered what a bend radius factor is for cables? [Watch](#) as Product Manager Don Nestor and Regional Product Manager Timothy Maran explain the concept and our promise of cost down, life up! And don't forget that all chainflex® cables are guaranteed to last 30 months or 10 million cycles.



Watch the video

Choose between 1.4K cables

igus® offers the largest selection of continuous-flex cables with nearly 1,400 types available, including robotic, bus, fiber optic and motor cables. All chainflex® cables are designed for use inside energy chains and are engineered to reduce the cost of your cabling system and increase the lifetime of your application. [Visit your chainflex® cables legend](#)



Learn More

[Click here to email product experts for more information or application-specific advice.](#)

- Information on our latest products
- Free samples and services
- Invitations to trade fairs and free entry tickets
- Webinars on current topics around plastics technology
- Exclusive insights into our test laboratories and test results
- Real-world application examples

Register here:

► www.igus.com/newsletter



SEARCH & GO WITH RESULTS

igus® | Shopping Cart (0)

Home | Applications | Product Information | Solutions | Resources | Company | About Us | Contact Us













igus® > e-chain®

e-chain® cable carriers

Discover the best e-chain® solution

Plastic energy chains reduce downtime & increase service life of cables

e-chain® carriers are offered in all the forms of modern machinery. These plastic cable carriers ensure a safe means of energy and data while under constant motion. They can be made with different materials, both as steel or plastic, but most carriers may require regular maintenance, which, depending on the frequency and application, can be time-consuming, costly and dangerous. Additionally, growing concern over the weight of many components has opened an increase in the use of lighter-weight plastic cable carriers.

<p>Small energy chains</p>  <p>Steel heights: 21 - 30mm</p>	<p>Medium energy chains</p>  <p>Steel heights: 21 - 40mm</p>	<p>Large energy chains</p>  <p>Steel heights: 21 - 100mm</p>	<p>For robotics</p>  <p>Steel heights: 12 - 40, 60mm</p>
<p>Protection against dirt and chips</p>  <p>Steel heights: 21 - 70mm</p>	<p>Smooth running, cleanroom</p>  <p>Steel heights: 12 - 80mm</p>	<p>Long travels and heavy duty</p>  <p>Steel heights: 12 - 80mm</p>	<p>Simple, static applications</p>  <p>Steel heights: 6 - 40mm</p>
<p>3D movements, non-robotics</p>  <p>Steel heights: 12 - 100mm</p>	<p>Circular, rotary or spiral movements up to 7500°</p>  <p>Steel heights: 6 - 100mm</p>	<p>Corrugated tube and corrugated tube accessories</p>  <p>Steel heights: 12 - 80mm</p>	<p>Accessories</p>  <p>Steel heights: 6 - 100mm</p>

Quickly find, configure, calculate and order the best e-chain®

► online.igus.com



**e-chains® for robotic and 3D,
circular and spiral movements**
triflex® R, retraction systems, easy triflex®,
triflex®, twisterchain, twisterband

▶ From page

8.1



Solutions for multi-axis motion
e-spool - the alternative to cable reeling drums

▶ From page

9.6



Solutions for vertical motion
liftband, guidelok slimline P

▶ From page

9.26



Solutions for horizontal motion
guidelok horizontal, basic flizz®, micro flizz®

▶ From page

9.38



**Predictive maintenance, condition
monitoring and engineered projects**
isense smart plastics , PPDS, modular projects and systems

▶ From page

9.57

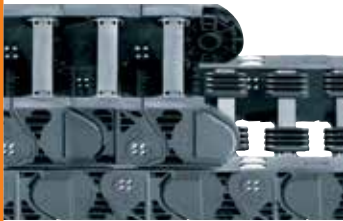

e-chains® for long travel applications
E4/4HD, system P4, rol e-chains®, autoglide

▶ From page

9.80



**Guide troughs for long travels
for standard and heavy-duty applications**
Aluminum SuperTrough and steel guide trough

▶ From page

9.180



Other guide trough systems
Steel and aluminum support tray, guidefast,
guidelite, tubular trough, snap-in trough

▶ From page

9.244



**chainfix strain relief
for maximum holding force**
Clamps, tiwrap plates, honeycomb strain relief, etc.

▶ From page

10.1

the-chain - moving energy made easy

**Lightweight, strong and long service life:
igus® e-chain systems® for every type of
movement**

Millions of igus® e-chains® are working in customer applications worldwide - from beverage dispensers to steelworks. They have a modular design and are therefore easy to assemble. They are resistant to different media and are ideal for very small bend radii as well as for large, heavy cables and hoses.

e-chains® are the umbilical cord of modern machines. They are constantly moving and supply power, data and energy. igus® has been developing, producing and testing polymer e-chains® since 1971. Our expert knowledge is continuously refined with the help of our customers to constantly improve our product range.

**Tested and proven service life.
Calculate and order online.**

Universal installation

- Various movement and length options
- For high dynamic loads and tough service life requirements
- For different environments and climates
- Innovative products that can be assembled quickly
- Large range of products - find the right solution quickly
- System quotes, including made-to-measure harnessing and "turnkey" assembly

 **More information**
▶ www.igus.com/e-chain



The award-winning igus® e-chain systems® are certified and tested

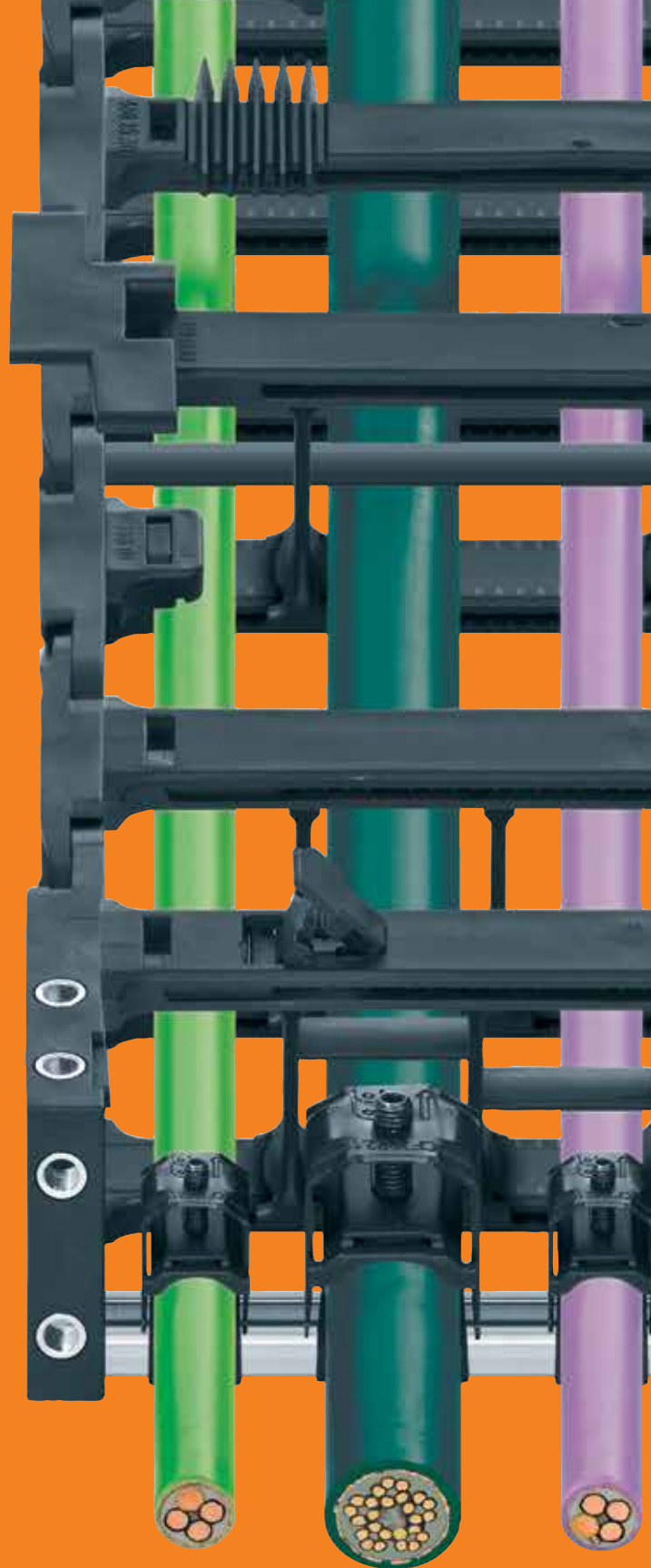

From batch size 1 to ...

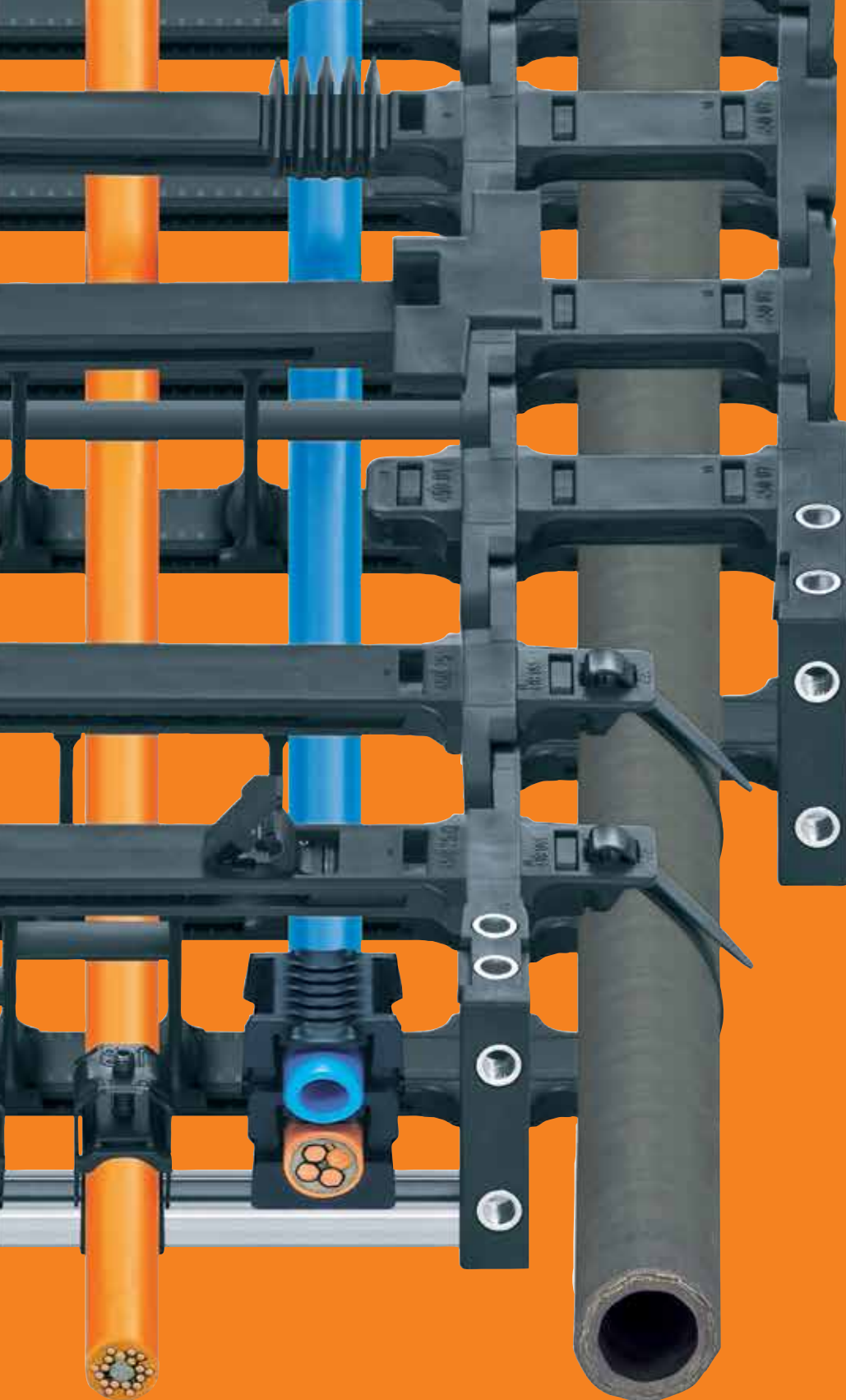

Assembled to your exact requirements - shipped in 1-3 days!



... "turnkey" systems for your sector - igus® the-chain

readychain® - pre-assembled e-chain systems®



Ready-to-install energy supply systems - reduce assembly and harnessing time by 95%

Ready-made energy supply systems are developed, fitted with connectors and delivered tailor-made. The customers can forego maintaining their own storage space for e-chains®, cables and connectors, saving time and space for internal logistics and for assembly and installation of their energy supply system. The ready-made modules reduce processing costs for our customers by up to 80% and accelerate cycle times radically. Machine downtimes are also minimized. To achieve this, we supply the systems worldwide from 12 assembly and logistics centers.

- Eliminate storage costs for cables, e-chains® and connectors
 - Cut turnaround times in half
 - Reduce the number of suppliers and orders by 75%
 - Minimize your machine downtime
- www.igus.com/readychain



basic
e-chain® with fitted
cables - strain relief
in the system



standard
e-chain® with cables
and connectors



standard+
Pre-assembled
e-chain system® with
sheet-metal parts

... other igus® services



Engineering - customer-specific developments with many solutions from the modular kit

► www.igus.com/info/engineering-services

premium
Ready-to-install
complete system
with transport rack



Installation - predictable installation time for your system at your premises: helps you plan and contributes to high plant availability
▶ www.igus.com/info/field-services-offered

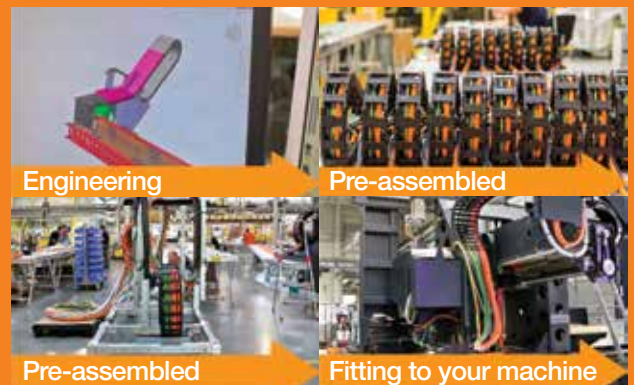

Engineering

Pre-assembled

Pre-assembled

Fitting to your machine

Open-Space - save valuable time for engineering while reducing processing costs

▶ www.igus.com/info/engineering-services

Reduce processing costs: configure igus® e-chains® online

Simplifying processes for customers is our primary goal. For almost every igus® product you will find further details, data and facts online. These include:

- Online tools for calculating service life
- Online configuration tools
- Comparisons and selection tools
- 3D and 2D CAD files
- PDF-files, data sheets and more
- Application pictures and videos
- Assembly instructions
- Personal support
- Catalog and sample ordering
- Online price list and online shop

Over 30 helpful online tools to quickly find, configure and calculate your product. No registration necessary. 3D CAD models available online to download. Easy to use.

Visit our website and make use of all the advantages.

► www.igus.com/online



Create your complete e-chain system® in just a few clicks

► www.igus.com/quickchain100

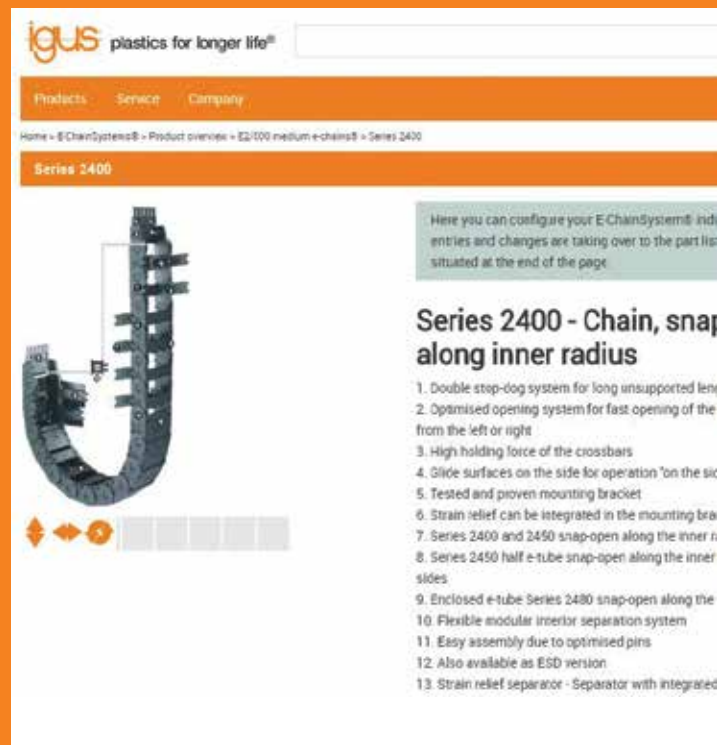

Example:

► www.igus.com/2400



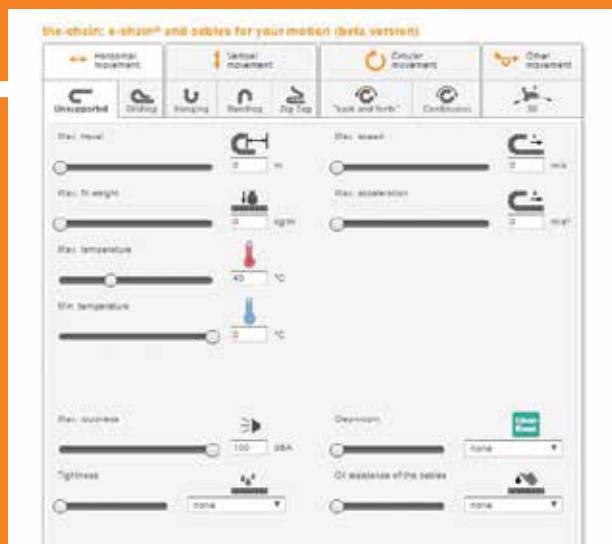
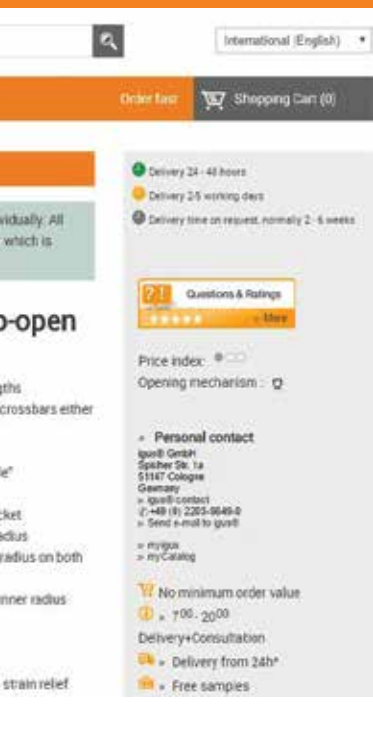

"Search" - the-chain product finder and configurator

- Find the right e-chain® quickly and easily by entering your application data and parameters.



"Calculate e-chain® length"

- Calculate the e-chain® length and see all installation dimensions.

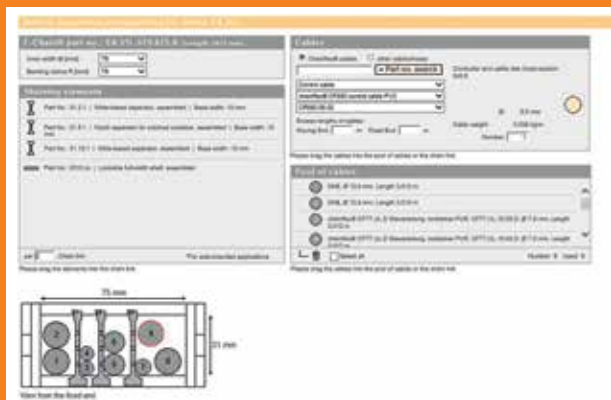

"Configure" e-chains® with the interior separator configurator

- Quickly and easily determine interior separation for the selected e-chain®; just drag and drop
- The configuration can be transferred automatically to your part list

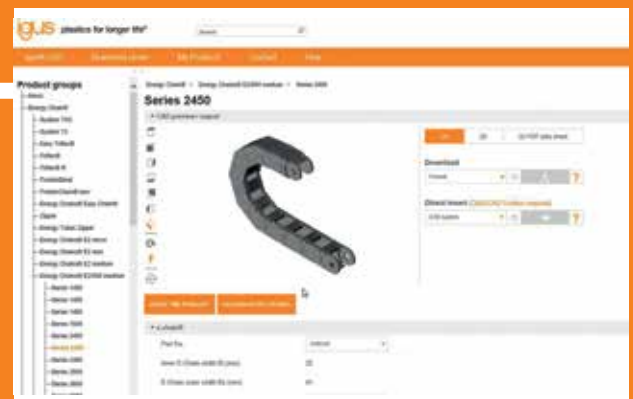

"Generate 3D file"

- e-chain® CAD library
 - Download and save CAD data free of charge without having to register
 - Nearly 30 different 3D and 2D formats available
 - Data on all products are updated and extended on a regular basis.
- www.igus-CAD.com

Quality from the igus[®] laboratory

Tested and proven every day.

Applications involving high duty cycles, speeds and accelerations, or demanding environmental conditions require proven systems especially for e-chains[®], cables, plain bearings, and linear bearings and slides. igus[®] constantly conducts tests under real-world conditions inside our 41,000 ft² laboratory in Cologne, Germany. Every year, we run more than 4,100 tests on e-chains[®] and cables and over 12,000 tests on plain bearings. These tests focus on push/pull forces, friction values and wear rates. Other factors like speed, load, dirt, weathering, cold and impact are also tested. Our laboratory is also at your disposal. If we don't have data for your type of application, we can conduct a test representative of your requirements.

► www.igus.com/testlab



Electronic checking and archiving for every e-chain[®] production batch



Long-term wear and service life test



igus[®] system warranty - every application is different. igus[®] warranty certificates can be issued for your individual application. Ask for the igus[®] warranty: "chain, cable, guarantee"



All products are tested and available from a single source. Examples of test certificates and quality seals for igus[®] products ... more upon request





Noise level test inside an igus® acoustic cell



igus® dynamic bending test



Speeds up to 10m/s, acceleration up to 200m/s² are tested



Long travel test facility - 125m travel length, speed 300m/min



41,000 ft² igus® lab. The largest test lab in the energy chain industry with 65 e-chain® test machines and about 7,515 test results per year. 253 simultaneous tests for e-chain® and chainflex® cables with more than 10 billion e-chain® cycles (in the e-chains® and chainflex® lab per year) ensure reliable energy supply systems for all industries and installation types.

Worldwide, quick and reliable. The igus® service

Delivery and consultation

Mon-Fri from 7am-8pm

Innovation and service are the focus of our corporate philosophy. Therefore we put together an extensive package of services for you: no minimum order quantity, speedy delivery from 24hrs, and more than 100,000 products from stock. Order an iglide® bearing or a harnessed standard portal from stock in 24 hours at no extra cost. Rapid delivery worldwide guaranteed. Spare parts are delivered from stock in the shortest amount of time.

Take advantage of more services at igus®:

- **Free samples:** we will be happy to send you free samples for testing in your application. Order here
▶ www.igus.com/samples
- The **monthly newsletter** keeps you regularly informed about new igus® solutions. Register here
▶ www.igus.com/newsletter

Order at igus®:
no minimum order quantities, no surcharges.

24_{hrs}

Single components

For example: One e-chain® link, 13.12 ft (6m) of e-chain®, 3 strain relief elements, etc.

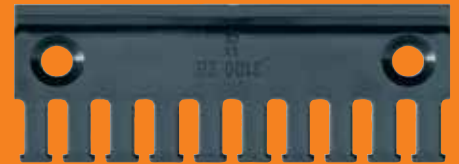

24-48hrs

Customized e-chain systems®

For example: 37.6 ft (11.46m) of e-chains® with interior separators, mounting brackets and strain relief elements according to your specifications. Also with loose accessories: chainflex® cables, guide troughs, mounting brackets and strain reliefs.



3-5 business days

Pre-assembled systems

For example: readychain® "basic" Simple, harnessed e-chain systems® including installed cables without connectors, labeled and tail lengths to your specifications.

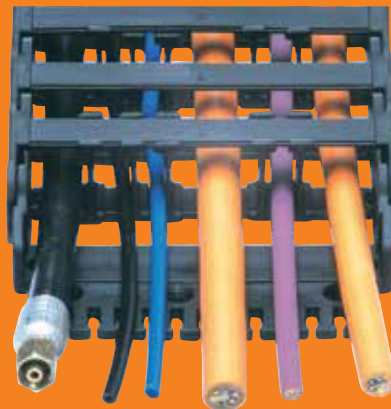

10 business days

Complex pre-assembled systems

For example: readychain® "Premium" Customized pre-assembled e-chain system® including cables, connectors, mounting brackets and other components to your specifications.

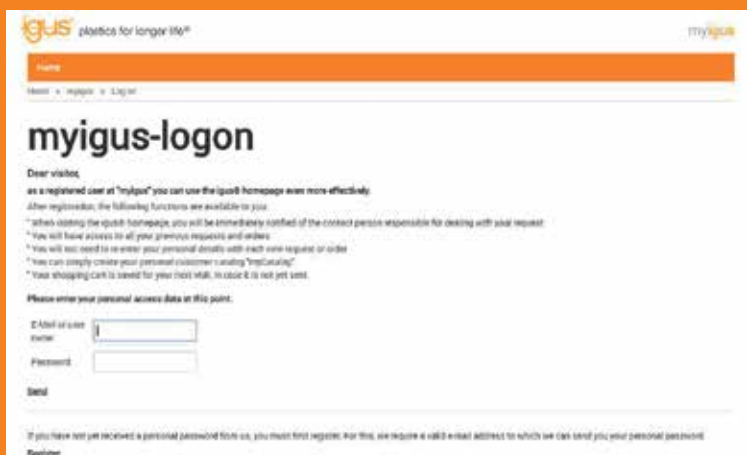

myigus space online

The igus[®] factory

Investments in better technology and faster delivery times

Nearly 200,000 customers worldwide trust "plastics for longer life[®]" - manufacturing products at low-cost, while also ensuring quality. We have been developing, making and selling our products according to this principle for years. Plastics are becoming increasingly affordable and technical benefits continue to grow. In view of the potential of plastic technology, we offer a wide range of tribo components. Wear resistant parts as catalog items are on stock to allow us to complete customer requests within hours. igus[®] is continuing to grow and is focusing more than ever on sophisticated yet simpler solutions for all applications and budgets.



Material preparation



Assembly factory

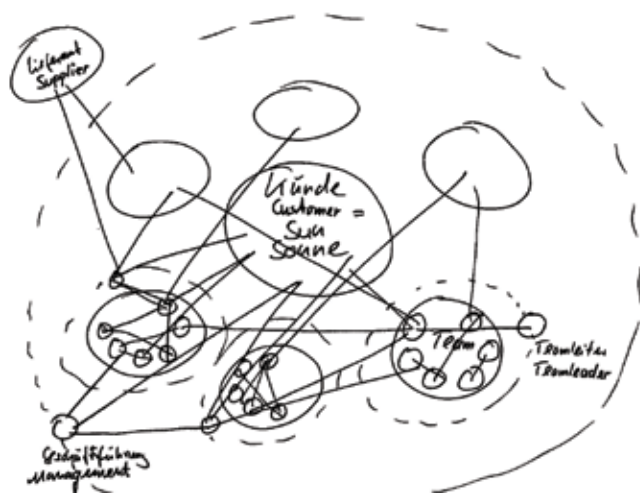

"For us, customers have the same significance as the sun to life on earth. The sun gives light, warmth and energy; our customers give us ideas, work and money."





Injection molding



Warehouse



Toolmaking



Open offices



Global standards - igus[®] is close to you

Worldwide individual consultation: by phone or at your premises. 35 subsidiaries worldwide.

A large network of sales engineers are at your disposal in Germany and worldwide. We will gladly provide consultation, supply assembly instructions and tools, measure installation spaces, and check environmental conditions at your premises. There are 4,150 employees between Germany and our 35 international subsidiaries. Plus distributors in another 55 countries guarantee rapid delivery.

- Customer-specific projects and special solutions: for every challenge, we will work with you to find a solution and provide a sample for your application free of charge
- We are wherever you need us: numerous e-chain[®] and polymer bearing consultants are at your disposal at any time
- Hands-on with our products at 200 trade shows worldwide
- Individually at your premises with our mobile exhibition



In a face-to-face meeting



igus[®] at trade shows





Technical consultation at your premises



Worldwide open offices - for example in China



igus® mobile exhibition



Worldwide modular factories - for example in the USA



igus® Offices
 igus® Distributors

All addresses on last page.

igus® - close to the customer since 1964

From a garage to the global market with tribopolymers

What began in 1964 with a single injection molding machine in a garage in Cologne has become a global enterprise within half a century. It all started more than 50 years ago when Günter Blase, who established the company, had an idea about the potential of polymer materials. A mere one year after the company was established, an injection molding machine about the size of a sewing machine was used to make the very first products. In 1971, igus® delivered the first e-chain®. The company's own design engineering team has been developing the range of plastic chains since 1983. In accordance with the igus® slogan, "Moving energy made easy", the company configures, produces and assembles the appropriate energy chain system - the "umbilical cord" of all modern machines - in line with the wishes of the customer. Throughout its history, igus® gradually grew to become a systems supplier. In 1989, the company developed the CF1, which was its first chainflex® cable specially designed for use in energy chains®.

Today, the 4,150 employees come up with new ideas daily, make high-quality products, ensure streamlined processes and delivery times and, above all, stay close to the customer. On average, igus® dispatches around 5,500 consignments per day. In order to ensure speedy and individual delivery, the customers receive exactly the product they need for their application from 14 storage and assembly/installation centers worldwide – as a single component or as a complete system, also installed or assembled on site upon request.

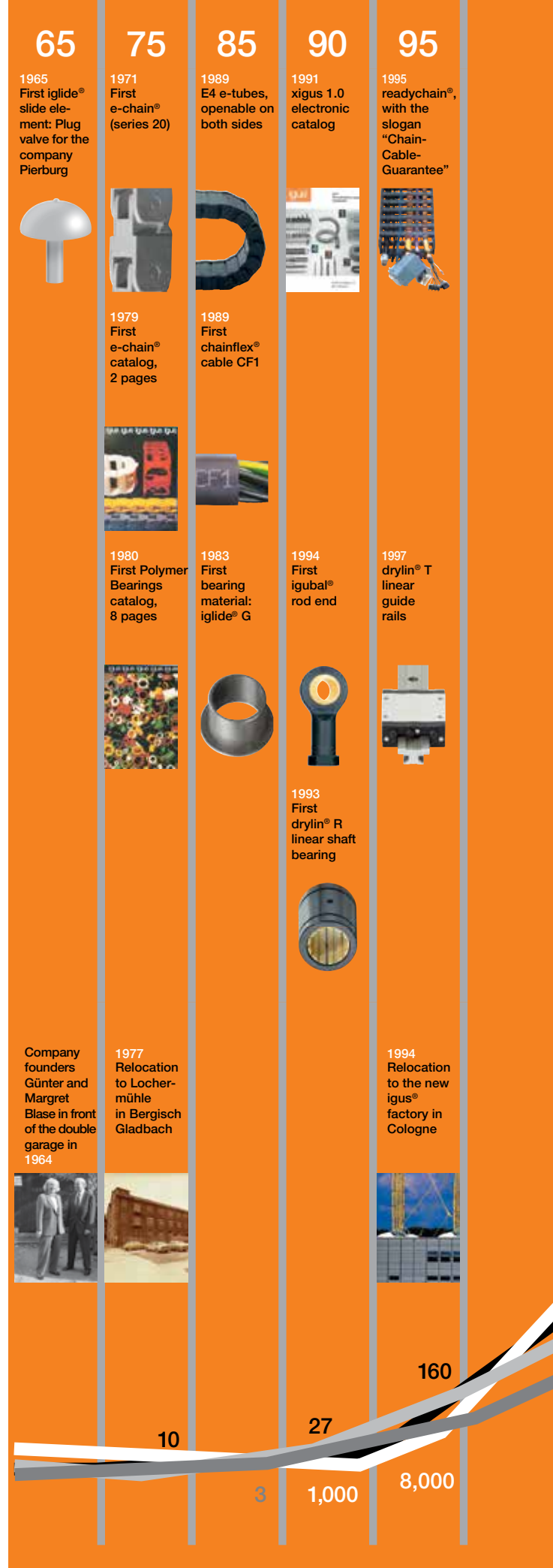

2000

2001 Low-vibration e-chains®: system E6



2003 triflex® R 3D e-chains®



2001 drylin® N low profile linear slides



2003 drylin® W modular linear guide systems



05

2006 rol e-chain®: System P4



2007 "One for all": system E4.1 e-chains®



2005 iglide® PRT slewing ring bearings



2007 drylin® ZLW Toothed belt axes



08

2009 Chip-proof: RX e-tube



2008 E4.350: largest polymer e-chain®



2008 xiros® polymer ball bearings



2009 robotlink® joints



2010

2010 twisterband: turn 7000°



2010 For Pick & Place: pikchain®



2010 iglide® bar stocks for custom design: Ø 10-100 mm



2011 drylin® E - linear axes with stepper motor



12

2012 The alternative to the cable reeling drum: the modular e-spool system



2012 Flip open chain links on triflex® TRLF



2012 Individual design: igubal® coupling bars



2013 High efficiency: dryspin® high helix lead screws

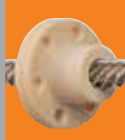

14

2014 The first plug-in energy chain: readychain® speed 2.0



2014 Cost-effective chainflex® M cables



2014 Versatile: iglide® Tribo-Tape



2014 iglide® Tribo-Filament for 3D printing

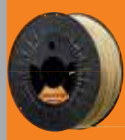

16

2016 100% stable, filled in seconds: easy chain® HD



2016 Predictive maintenance with smart plastics



2016 3D printing service for wear resistant components



2016 drylin® carriage for curved rail



2017

2017 Plastic energy chain according to "Hygienic Design Guidelines"

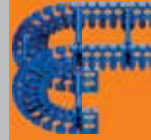

2017 Angle adapter ibow for priceless flexibility



2017 "Eco series" linear modules - with 3D printed parts



2017 robotlink® low-cost robot: modular ... build or buy



100,000

95,000

80,000

3,180

45,000

2,950

1,200

1,800

552 million

690 million

303 million

30

36

16

2009 60% factory extension in Cologne



2012 2nd factory extension in Cologne



2014 50 years igus 30 years of spin

2015 Guarantee igus chainflex 36 month guarantee



Change your bearing now: www.igus.com/iglide

Moving energy made easy - for any industry

Solutions with igus® e-chain systems®

The task of igus® e-chain systems® is to reliably supply energy and data to moving equipment. Such equipment is constantly in motion and has to function reliably in difficult ambient conditions as well as under high loads and at high speeds. e-chain systems® can be used universally in these kind of applications.

More exciting application examples

► www.igus.com/applications



More information

► www.igus.com/info/energy-chain-applications



Harnessed "readychain®" energy chains reduce costs sustainably



Tunneling machine - reliable E4.1 energy supply despite dirt and vibration



For example: machine tools, woodworking equipment, cranes, material handling systems and robots ...





The world's longest e-chain® travels 2017.8 ft. (615 m) with igus® rol e-chains® and chainflex® cables in a power plant



igus® e-chain systems® replace conventional energy supply solutions for cranes



Long travel, side-mounted installation using the vibration-free and low-noise series E6.29 in a camera application



igus® triflex® R e-chains® for robots that machine molded plastic parts



The world's largest plastic e-chain® (as of 05/2015), the igus® E4.1 series E4.350. Equipped with rollers, it travels reliably and is energy efficient. In this case on a slurry vacuum application. 492 ft. (150 m) travel, 67 lbs/ft. (100 kg/m) filling weight

Find references online ... take a look at over 60 industry branches

Different industries need different solutions. Whether in mechanical engineering, automobile manufacturing or in the robot industry - igus® offers customized support for special applications. igus® already has many years of experience and specialized resources for many industries.

► www.igus.com/industry

Quickly find and configure products and calculate service life - all online.

Using our online product finders, you can find the right igus® product and predict the service life. You can also download 3D CAD files for free and shop around the clock.

► www.igus.com/online

Legal information: the information in this catalog, and the data in the Design section in particular, is based on our current knowledge of the products described. A legally binding assurance of certain properties or the suitability for a certain application cannot be derived. igus® is unable to assume liability of any nature for damage, loss or injury resulting from application of the products. Due to constant technical development, we reserve the right at all times to make technical changes and improvements to the products. Subject to printing errors. Our offers are exclusively directed to dealers / resellers. The delivery times indicated correspond to the time until the goods are dispatched, whereby transport costs are not included in the price. We recommend that you always check the suitability of the products for a particular purpose in a practical trial. Please avail of our consulting services.

All products that are marked "New" in the catalog have been added since the last version of the catalog published in 2017.

The terms "igus", "Apiro", "chainflex", "CFRIP", "conprotect", "CTD", "drylin", "dry-tech", "dryspin", "easy chain", "e-chain", "e-chain systems", "e-ketten", "e-kettensysteme", "e-skin", "flizz", "ibow", "iglide", "iglidur", "igubal", "manus", "motion plastics", "plastics for longer life", "pikchain", "readychain", "readycable", "ReBeL", "roboLink", "speedigus", "triflex", and "xiros" are protected by trademark laws in the Federal Republic of Germany and internationally, where applicable.

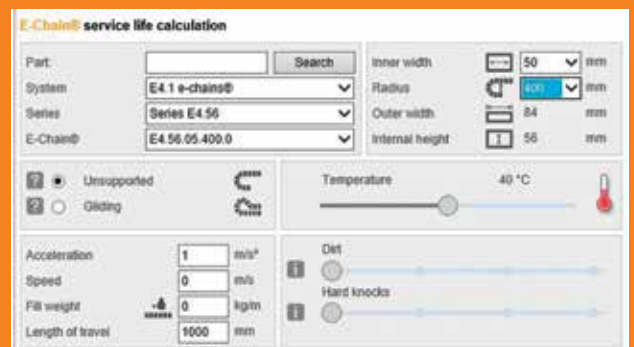
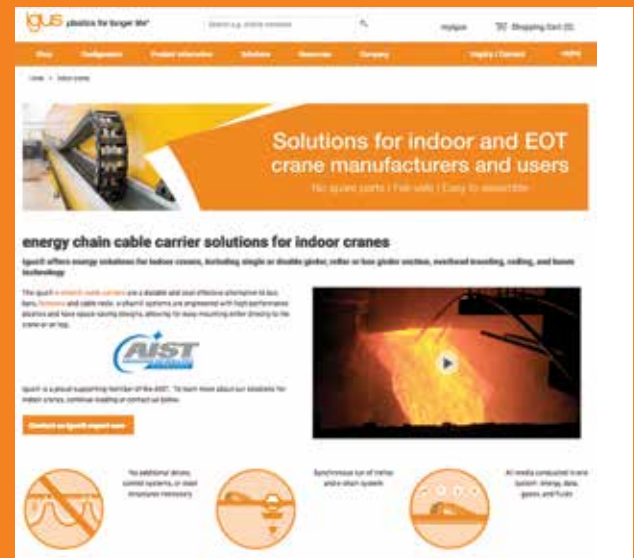
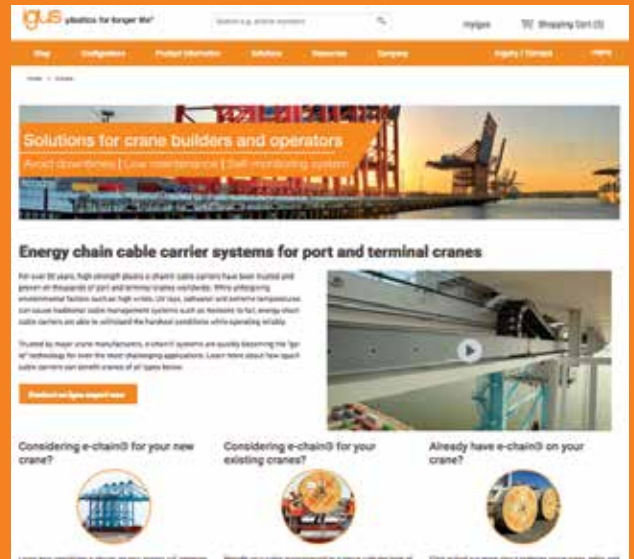

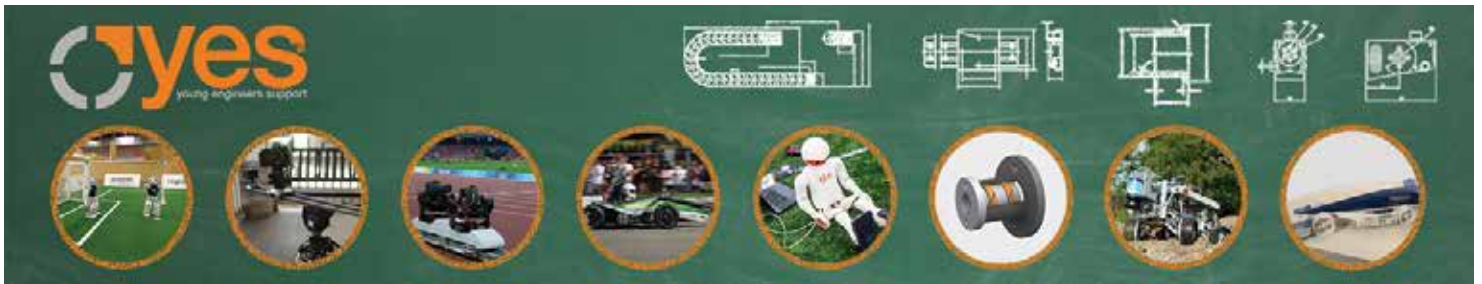

In 2005, igus® unveiled the Young Engineers Support Program, designed to foster the mechanical design ideas and inventions of students who have a passion for engineering. The Y.E.S. Program aims to not only support students and engineers, but also educate them on the merits and benefits of plastic components. Free donations are available to students and engineering competitions across the U.S., Canada and Mexico.

Through the **yes** Program, igus®:

- offers free product donations to students, engineers and professors for use in various design competitions, school projects and engineering curriculum;
- supports the visions of various robotics competitions by donating products, technical support and other resources;
- revitalizes students' interest in engineering; and
- helps make the design ideas of students and engineers a reality.

yes Facts

- The **yes** Program is open to students of all ages and grade levels
- The **yes** Program sponsors competitions such as *FIRST*® Robotics, BEST™ Robotics, Botball and Rube Goldberg.
- The **yes** Program offers lecture engagements presented by bearings and cable carrier experts at schools and universities.

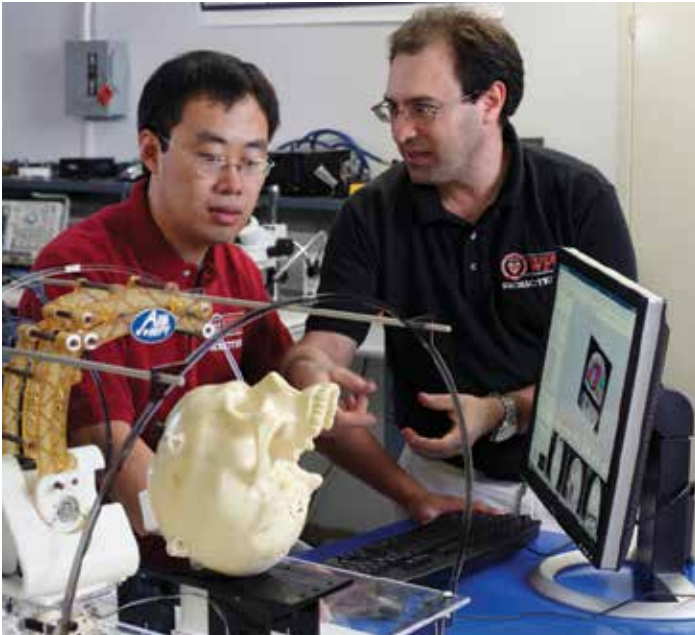

Hao Su, PhD candidate, and Professor Gregory Fischer from the Worcester Polytechnic Institute used iglide® plastic bushings and a drylin® linear guide system for their MRI-guided needle placement robot, which will improve the way prostate cancer is detected and treated.



The Giant Diencephalic BrainSTEM Robotics Team scored the most points on record during in the 2018 *FIRST*® Tech Challenge: Relic Recovery. Each team's robot was required to collect foam cubes in various patterns, retrieve and transfer various items, park on balancing stones, and navigate to specific parts of the playing field.

Interested in becoming part of the **yes** Program?

Contact yes@igus.com or visit www.igus.com/company-yes-ca

System e-rib, E-1, SnapChain, office Chain

- Legend**
- Standard
 - Suitable to only a limited extent
 - ▲ Optional
 - Especially suitable
 - * In preparation / on request

Series	Inner height <i>hi</i> in. (mm) ø cable max. in.	Inner width <i>Bi</i> in. (mm) from - to	Outer height <i>ha</i> in. (mm)	Outer width <i>Ba</i> in. (mm) from - to	Bending radii <i>R</i> in. (mm) from - to	Pitch in. (mm)	Unsupported fill weight max lbs/ft (kg/m)	Unsupported length max ft. (m)	Long travel max ft. (m)	Opening design	Interior separation possibilities...			ESD/ATEX	Cleanroom	UL-V2	Low noise	Price index	Page

e-rib - reinforcement for existing corrugated tube systems

Reinforcement for corrugated tubes - simply clip onto a corrugated hose



EL.00.23.0	nominal width	NW23	1.10 (28)	1.18 (30)	1.61 (41)	-	-	-	-	-		-	-	-	-	-	○	-	●●●●	2.11
EL.01.29.0	nominal width	NW29	1.06 (27)	1.38 (35)	1.75 (44.5)	-	-	-	-	-		-	-	-	-	-	○	-	●●●●	2.12
EL.00.36.0	nominal width	NW36	1.65 (42)	1.69 (43)	2.20 (56)	-	-	-	-	-		-	-	-	-	-	○	-	●●●●	2.13
EL.00.48.0	nominal width	NW48	2.13 (54)	2.13 (54)	2.68 (68)	-	-	-	-	-		-	-	-	-	-	○	-	●●●●	2.14

E1 - cost-effective, one piece strip design for simple applications

e-chains®, openable along the outer radius



E1-10	.39 (10)	ø .35	.51 (13)	.61 (15.5)	.72-2.29 (16.5)	.71 (018)	.79 (20)	upon request	-	-		-	-	-	○	●	▲	●	●●●●	2.23
E1-17	.67 (17)	ø .59	.83-1.73 (21-44)	.98 (25)	1.02-1.93 (26-49)	1.10 (028)	1.00 (25.5)	upon request	-	-		-	-	-	○	●	▲	●	●●●●	2.24
E1-18	.71 (18)	ø .63	.59 (15)	1.02 (26)	.79 (20)	1.10 (028)	.99 (25.25)	upon request	-	-		-	-	-	○	●	▲	●	●●●●	2.25
E1-20	.79 (20)	ø .71	.59 (15)	1.06 (27)	.87 (22)	1.10 (028)	.98 (25)	upon request	-	-		-	-	-	○	●	▲	●	●●●●	2.26

SnapChain - Guide cable bundles quickly and easily

e-chains®, Loops to be opened along the outer radius



TE14-50	Loop Length: 50 mm	-	-	-	1.10-4.92 (028-125)	1.20 (30.5)	-	-	-	-		-	-	-	-	-	▲	●	●●●●	2.30
TE26-120	Loop Length: 120 mm	-	-	-	2.48-7.87 (063-200)	2.20 (56)	-	-	-	-		-	-	-	-	-	▲	●	●●●●	2.32

e-tubes, Loops to be opened along the inner radius



TZ14-50	Loop Length: 50 mm	-	-	-	1.10-4.92 (028-125)	1.20 (30.5)	-	-	-	-		-	-	-	-	-	▲	●	●●●●	2.30
TZ26-120	Loop Length: 120 mm	-	-	-	2.48-7.87 (063-200)	2.20 (56)	-	-	-	-		-	-	-	-	-	▲	●	●●●●	2.32

office e-chain® energy supply for offices and furniture

e-chains®, E-Z design, split crossbar along the inner radius



ZF14	.83 (21)	ø .55	1.50 (38)	.98 (25)	1.83 (46.6)	1.10 (028)	1.20 (30.5)	-	-	-		-	-	-	▲	▲	●	▲	●●●●	2.37
------	----------	-------	-----------	----------	-------------	------------	-------------	---	---	---	--	---	---	---	---	---	---	---	------	------

System E-Z Chain

- Legend**
- Standard
 - Suitable to only a limited extent
 - ▲ Optional
 - Especially suitable
 - * In preparation / on request

Series	Inner height <i>hi</i> in. (mm) ø cable max. in.	Inner width <i>Bi</i> in. (mm) from - to	Outer height <i>ha</i> in. (mm)	Outer width <i>Ba</i> in. (mm) from - to	Bending radii <i>R</i> in. (mm) from - to	Pitch in. (mm)	Unsupported fill weight lbs/ft (kg/m)	Unsupported length max ft. (m)	Long travel max ft. (m)	Opening design	Interior separation possibilities...			ESD/ATEX	Cleanroom	UL-V2	Low noise	Price index	Page
											Separators	Full-width shelves	Shelves						

E-Z Chain - easy to fill and cost-effective

E-Z Chain, E-version, split crossbar along the outer radius



Series	Inner height <i>hi</i> in. (mm) ø cable max. in.	Inner width <i>Bi</i> in. (mm) from - to	Outer height <i>ha</i> in. (mm)	Outer width <i>Ba</i> in. (mm) from - to	Bending radii <i>R</i> in. (mm) from - to	Pitch in. (mm)	Unsupported fill weight lbs/ft (kg/m)	Unsupported length max ft. (m)	Long travel max ft. (m)	Opening design	Separators	Full-width shelves	Shelves	ESD/ATEX	Cleanroom	UL-V2	Low noise	Price index	Page
1-chamber																			
E03	.20 (5)	ø .12	.20-.39 (5-10)	.31 (8)	.34-.54 (8.7-13.7)	.39-1.10 (010-028)	.39 (10)	.161 (0.24)	1.31 (0.40)	-	-	-	-	○	■	●	■	●●●●	2.47
E04	.28 (7)	ø .18	.28 (7)	.39 (10)	.51 (13)	.59-1.89 (015-048)	.66 (16.7)	.235 (0.35)	1.80 (0.55)	-	-	-	-	▲	■	●	●	●●●●	2.51
E045	.37 (9.4)	ø .22	.63 (16)	.49 (12.5)	.63-.91 (16-23)	.71-1.50 (018-038)	.51 (13)	.168 (0.25)	1.31 (0.40)	-	-	-	-	▲	■	●	■	●●●●	2.55
E06	.42 (10.7)	ø .26	.39-.79 (10-20)	.59 (15)	.65-1.04 (16.5-26.5)	.71-1.50 (018-038)	.79 (20)	.302 (0.45)	1.80 (0.55)	-	-	-	-	▲	■	●	■	●●●●	2.61
E065	.44 (11.3)	ø .28	.63 (16)	.59 (15)	.98 (24.8)	.71-1.50 (018-038)	.59 (15)	.302 (0.45)	1.97 (0.60)	-	-	-	-	▲	■	●	■	●●●●	2.65
E08	.57 (14.6)	ø .39	.39-1.97 (10-50)	.76 (19.3)	.72-2.29 (18.2-58.2)	1.10-1.89 (028-048)	.79 (20)	.504 (0.75)	3.28 (1.00)	-	-	-	-	▲	■	●	●	●●●●	2.71
E14	.75 (19)	ø .51	.59-1.57 (15-50)	.98 (25)	1.06-2.44 (27-62)	1.10-4.92 (028-125)	1.20 (30.5)	.336 (0.5)	2.13 (0.65)	-	-	-	-	▲	■	●	●	●●●●	2.75
E200	.96 (24.3)	ø .79	2.24 (57)	1.38 (35)	2.93 (74.4)	2.17-7.87 (055-200)	1.81 (46)	1.34 (2.0)	5.74 (1.75)	-	-	-	-	▲	■	●	●	●●●●	2.79
E16	1.26 (32)	ø .98	.91-3.94 (23-100)	1.54 (39)	1.48-4.54 (37.5-115.3)	1.57-3.94 (040-100)	1.20 (30.5)	.504 (0.75)	3.28 (1.00)	-	-	-	-	▲	■	●	●	●●●●	2.85
E26	1.44 (36.5)	ø 1.10	2.95 (75)	1.97 (50)	3.62 (92)	2.48-9.84 (063-250)	2.20 (56)	2.69 (4.0)	7.87 (2.00)	-	-	-	-	▲	■	●	●	●●●●	2.89
E300	1.91 (48.5)	ø 1.38	2.95 (75)	2.52 (64)	3.74 (95)	2.95-11.81 (075-300)	2.64 (67)	5.38 (8.0)	7.38 (2.25)	-	-	-	-	▲	■	●	●	●●●●	2.95
2-chamber																			
E045-2	.37 (9.4)	ø .22	.28-.35 (7-9)	.49 (12.5)	.91-1.06 (23-27)	.71-1.50 (018-038)	.51 (13)	.168 (0.25)	1.31 (0.40)	-	●	-	-	▲	■	●	●	●●●●	2.55
E065-2	.44 (11.3)	ø .28	.35 (9)	.59 (15)	1.15 (29.3)	.71-1.50 (018-038)	.59 (15)	.302 (0.45)	1.97 (0.60)	-	●	-	-	▲	■	●	●	●●●●	2.65
E200-2	.96 (24.3)	ø .79	1.46-1.97 (37-50)	1.38 (35)	3.72-4.74 (94.4-120.4)	2.17-7.87 (055-200)	1.81 (46)	1.34 (2.0)	5.74 (1.75)	-	●	-	-	▲	■	●	●	●●●●	2.79
E26-2	1.46 (37.1)	ø 1.10	1.89 (48)	1.97 (50)	4.6 (117)	2.48-9.84 (063-250)	2.20 (56)	2.69 (4.0)	7.87 (2.00)	-	●	-	-	▲	■	●	●	●●●●	2.89
E300-2	1.91 (48.5)	ø 1.38	1.89 (48)	2.52 (64)	4.72 (120)	2.95-11.81 (075-300)	2.64 (67)	5.38 (8.0)	7.38 (2.25)	-	●	-	-	▲	■	●	●	●●●●	2.95
3-chamber																			
E045-3	.37 (9.4)	ø .22	.35 (9)	.49 (12.5)	1.46 (37)	.71-1.50 (018-038)	.51 (13)	.168 (0.25)	1.31 (0.40)	-	●	-	-	▲	■	●	●	●●●●	2.55
E065-3	.44 (11.3)	ø .28	.35 (9)	.59 (15)	1.55 (39.3)	.71-1.50 (018-038)	.59 (15)	.302 (0.45)	1.97 (0.60)	-	●	-	-	▲	■	●	●	●●●●	2.65
E26-3	1.46 (37.1)	ø .79	1.85 (47)	1.97 (50)	6.57 (167)	2.48-9.84 (063-250)	2.20 (56)	2.69 (4.0)	7.87 (2.00)	-	●	-	-	▲	■	●	●	●●●●	2.89
E300-3	1.91 (48.5)	ø 1.38	1.81 (46)	2.52 (64)	6.69 (170)	2.95-11.81 (075-300)	2.64 (67)	5.38 (8.0)	7.38 (2.25)	-	●	-	-	▲	■	●	●	●●●●	2.95
4-chamber																			
E065-4	.44 (11.3)	ø .28	.35 (9)	.59 (15)	1.94 (49.3)	.71-1.50 (018-038)	.59 (15)	.302 (0.45)	1.97 (0.60)	-	●	-	●	▲	■	●	●	●●●●	2.65

E-Z Chain, Z-version, split crossbar along the inner radius



Series	Inner height <i>hi</i> in. (mm) ø cable max. in.	Inner width <i>Bi</i> in. (mm) from - to	Outer height <i>ha</i> in. (mm)	Outer width <i>Ba</i> in. (mm) from - to	Bending radii <i>R</i> in. (mm) from - to	Pitch in. (mm)	Unsupported fill weight lbs/ft (kg/m)	Unsupported length max ft. (m)	Long travel max ft. (m)	Opening design	Separators	Full-width shelves	Shelves	ESD/ATEX	Cleanroom	UL-V2	Low noise	Price index	Page
1-chamber																			
Z045	.37 (9.4)	ø .22	.63 (16)	.49 (12.5)	.63-.91 (16-23)	.71-1.50 (018-038)	.51 (13)	.168 (0.25)	1.31 (0.40)	-	-	-	-	▲	■	●	■	●●●●	2.55
Z06	.42 (10.7)	ø .26	.39-.79 (10-20)	.59 (15)	.65-1.04 (16.5-26.5)	.71-1.50 (018-038)	.79 (20)	.302 (0.45)	1.80 (0.55)	-	-	-	-	▲	■	●	■	●●●●	2.61
Z08	.57 (14.6)	ø .39	.39-1.97 (10-50)	.76 (19.3)	.72-2.29 (18.2-58.2)	1.10-1.89 (028-048)	.79 (20)	.504 (0.75)	3.28 (1.00)	-	-	-	-	▲	■	●	●	●●●●	2.71
Z14	.75 (19)	ø .51	.59-1.57 (15-50)	.98 (25)	1.06-2.44 (27-62)	1.10-4.92 (028-125)	1.20 (30.5)	.336 (0.5)	2.13 (0.65)	-	-	-	-	▲	■	●	●	●●●●	2.75
Z200	.96 (24.3)	ø .79	2.24 (57)	1.38 (35)	2.93 (74.4)	2.17-7.87 (055-200)	1.81 (46)	1.34 (2.0)	5.74 (1.75)	-	-	-	-	▲	■	●	●	●●●●	2.79
Z16	1.26 (32)	ø .98	.91-3.94 (23-100)	1.54 (39)	1.48-4.54 (37.5-115.3)	1.57-3.94 (040-100)	1.20 (30.5)	.504 (0.75)	3.28 (1.00)	-	-	-	-	▲	■	●	●	●●●●	2.85
Z26	1.44 (36.5)	ø 1.10	2.95 (75)	1.97 (50)	3.62 (92)	2.48-9.84 (063-250)	2.20 (56)	2.69 (4.0)	7.87 (2.00)	-	-	-	-	▲	■	●	●	●●●●	2.89
Z300	1.91 (48.5)	ø 1.38	2.95 (75)	2.52 (64)	3.74 (95)	2.95-11.81 (075-300)	2.64 (67)	5.38 (8.0)	7.38 (2.25)	-	-	-	-	▲	■	●	●	●●●●	2.95
2-chamber																			
Z045-2	.37 (9.4)	ø .22	.28-.35 (7-9)	.49 (12.5)	.91-1.06 (23-27)	.71-1.50 (018-038)	.51 (13)	.168 (0.25)	1.31 (0.40)	-	●	-	-	▲	■	●	●	●●●●	2.55
Z200-2	.96 (24.3)	ø .79	1.46-1.97 (37-50)	1.38 (35)	3.72-4.74 (94.4-120.4)	2.17-7.87 (055-200)	1.81 (46)	1.34 (2.0)	5.74 (1.75)	-	●	-	-	▲	■	●	●	●●●●	2.79
Z26-2	1.46 (37.1)	ø 1.10	1.89 (48)	1.97 (50)	4.6 (117)	2.48-9.84 (063-250)	2.20 (56)	2.69 (4.0)	7.87 (2.00)	-	●	-	-	▲	■	●	●	●●●●	2.89
Z300-2	1.91 (48.5)	ø 1.38	1.89 (48)	2.52 (64)	4.72 (120)	2.95-11.81 (075-300)	2.64 (67)	5.38 (8.0)	7.38 (2.25)	-	●	-	-	▲	■	●	●	●●●●	2.95
3-chamber																			
Z045-3	.37 (9.4)	ø .22	.35 (9)	.49 (12.5)	1.46 (37)	.71-1.50 (018-038)	.51 (13)	.168 (0.25)	1.31 (0.40)	-	●	-	-	▲	■	●	●	●●●●	2.55
Z065-3	.44 (11.3)	ø .28	.35 (9)	.59 (15)	1.55 (39.3)	.71-1.50 (018-038)	.59 (15)	.302 (0.45)	1.97 (0.60)	-	●	-	-	▲	■	●	●	●●●●	2.65
Z26-3	1.46 (37.1)	ø .79	1.85 (47)	1.97 (50)	6.57 (167)	2.48-9.84 (063-250)	2.20 (56)	2.69 (4.0)	7.87 (2.00)	-	●	-	-	▲	■	●	●	●●●●	2.89
Z300-3	1.91 (48.5)	ø 1.38	1.81 (46)	2.52 (64)	6.69 (170)	2.95-11.81 (075-300)	2.64 (67)	5.38 (8.0)	7.38 (2.25)	-	●	-	●	▲	■	●	●	●●●●	2.95

System Zipper Chain, E2 micro

- Legend**
- Standard
 - Suitable to only a limited extent
 - ▲ Optional
 - Especially suitable
 - * In preparation / on request

Series	Inner height <i>hi</i> in. (mm) ø cable max. in.	Inner width <i>Bi</i> in. (mm) from - to	Outer height <i>ha</i> in. (mm)	Outer width <i>Ba</i> in. (mm) from - to	Bending radii <i>R</i> in. (mm) from - to	Pitch in. (mm)	Unsupported fill weight max lbs/ft (kg/m)	Unsupported length max ft. (m)	Long travel max ft. (m)	Opening design	Interior separation possibilities...			ESD/ATEX	Cleanroom	UL-V2	Low noise	Price index	Page
											Separators	Full-width shelves	Shelves						

Zipper Chain - Zipper fastening e-chains® and e-tubes!

e-chains®, zip-open along the outer radius

	047	.35 (9)	ø .28	.39-.63 (10-16)	.49 (12.5)	.63-.87 (16-22)	.71-1.50 (18-38)	.51 (13)	.168 (0.25)	1.31 (0.40)	-		-	-	-	▲	●	▲	■	●●●	3.7
	07	.41 (10.3)	ø .31	.24-2.52 (6-64)	.59 (15)	.49-2.80 (12.5-71)	.71-1.50 (18-38)	.79 (20)	.27 (0.4)	1.80 (0.55)	-		-	-	-	▲	●	▲	■	●●●	3.11
	09	.59 (15)	ø .51	.39-1.97 (10-50)	.76 (19.3)	.72-2.29 (18.2-58.2)	1.10-1.89 (28-48)	.79 (20)	.504 (0.75)	3.28 (1.00)	-		●	●	-	▲	●	▲	■	●●●	3.19
	15	.67 (17)	ø .59	.59-3.94 (15-100)	.94 (24)	1.02-4.45 (26-113)	1.50-7.09 (38-180)	1.20 (30.5)	1.01 (1.5)	3.94 (1.20)	-		●	●	-	▲	●	▲	■	●●●	3.27
	17	1.26 (32)	ø 1.10	.59-3.94 (15-100)	1.54 (39)	1.02-4.45 (26-113)	2.48-4.92 (63-125)	1.20 (30.5)	.67 (1.0)	3.28 (1.00)	-		●	●	-	▲	●	▲	■	●●●	3.39

e-tubes, zip-open along the inner radius

	R07	.41 (10.3)	ø .31	.39-1.97 (10-50)	.59 (15)	.65-2.24 (16.5-57)	1.50-1.89 (38-48)	.79 (20)	.27 (0.4)	1.80 (0.55)	-		-	-	-	▲	●	▲	■	●●●	3.15
	R09	.59 (15)	ø .49	.39-1.97 (10-50)	.76 (19.3)	.72-2.29 (18.2-58.2)	1.89-3.94 (48-100)	.79 (20)	.504 (0.75)	3.28 (1.00)	-		-	-	-	▲	●	▲	■	●●●	3.23
	R15	.67 (17)	ø .59	.98-3.15 (25-80)	.94 (24)	1.42-3.70 (36-94)	2.48-7.09 (63-180)	1.20 (30.5)	1.10 (1.5)	.81 (1.2)	-		●	●	-	▲	●	▲	■	●●●	3.33
	R17	1.26 (32)	ø 1.10	.59-2.48 (15-63)	1.54 (39)	1.02-2.99 (26-76)	2.48-4.92 (63-125)	1.20 (30.5)	1.01 (1.5)	.81 (1.2)	-		●	●	-	▲	●	▲	■	●●●	3.45

E2 Micro - smallest inner heights and bending radii

In new e2.1 section

e-chains®, non snap-open

	03	.20 (5)	ø .14	.20-.39 (5-10)	.31 (8)	.34-.54 (8.7-13.7)	.39-1.10 (10-28)	.39 (10)	.16 (0.24)	1.31 (0.40)	-		-	-	-	○	○	●	■	●●●	4.7
	04	.28 (7)	ø .20	.28-1.18 (7-30)	.39 (10)	.47-1.38 (12-35)	.59-1.89 (15-48)	.66 (16.7)	.25 (0.375)	1.64 (0.50)	-		-	-	-	▲	○	▲	●	●●●	4.11
	05	.39 (10)	ø .31	.24-2.52 (6-64)	.47 (12)	.39-2.68 (10-68)	.71-1.50 (18-38)	.51 (13)	.25 (0.375)	1.64 (0.50)	-		-	-	-	▲	○	▲	●	●●●	4.15
	045	.41 (10.3)	ø .31	.24-2.52 (6-64)	.49 (12.5)	.47-2.76 (12-70)	.71-1.50 (18-38)	.79 (20)	.17 (0.25)	1.64 (0.50)	-		-	-	-	▲	○	▲	■	●●●	4.19
	06	.41 (10.5)	ø .31	.24-2.52 (6-64)	.59 (15)	.49-2.80 (12.5-71)	.71-1.50 (18-38)	.79 (20)	.32 (0.48)	1.97 (0.60)	-		-	-	-	▲	○	▲	●	●●●	4.23
	E2C-10	.41 (10.6)	ø .31	.24-1.97(6-50)	.59(15)	.53-2.26 (13.4-57.4)	.71-1.50 (18-38)	.79 (20)	.47 (0.70)	2.46 (0.75)	-		▲	-	-	▲	○	▲	●	●●●	4.27
	E2C-15	.59 (14.9)	ø .49	.39-1.97(10-50)	.76 (19.3)	.70-2.28 (17.8-57.8)	1.10-2.95 (28-75)	.79 (20)	.84 (1.25)	4.27 (1.30)	-		-	-	-	▲	○	▲	●	●●●	4.41
	08	.59 (15)	ø .47	.39-1.97 (10-50)	.76 (19.3)	.72-2.29 (18.2-58.2)	1.10-1.89 (28-48)	.79 (20)	.50 (0.74)	3.28 (1.00)	-		-	-	-	▲	○	▲	●	●●●	4.47

e-chains®, snap-open along the inner radius

	E2i-10	.41 (10.6)	ø .31	.24-1.97(6-50)	.59(15)	.53-2.26 (13.4-57.4)	.71-1.50 (18-38)	.79 (20)	.47 (0.70)	2.46 (0.75)	-		▲	-	-	▲	○	▲	●	●●●	4.27
	E2i-15	.59 (14.9)	ø .49	.39-1.97(10-50)	.76 (19.3)	.70-2.28 (17.8-57.8)	1.10-2.95 (28-75)	.79 (20)	.84 (1.25)	4.27 (1.30)	-		-	-	-	▲	○	▲	●	●●●	4.41

e-chains®, snap-open along the outer radius

	E2-10	.41 (10.6)	ø .31	.24-1.97(6-50)	.59(15)	.53-2.26 (13.4-57.4)	.71-1.50 (18-38)	.79 (20)	.47 (0.70)	2.46 (0.75)	-		▲	-	-	▲	○	▲	●	●●●	4.27
	B07	.41 (10.3)	ø .31	.63-1.57 (16-40)	.59 (15)	.89-1.85 (22.5-47)	.71-1.50 (18-38)	.79 (20)	.27 (0.40)	1.80 (0.55)	-		-	-	-	○	●	▲	■	●●●	4.33
	B09	.56 (14.3)	ø .49	.63-1.57 (16-40)	.76 (19.3)	.95-1.90 (24.2-48.2)	1.10-1.89 (28-48)	.79 (20)	.47 (0.70)	3.28 (1.00)	-		●	●	-	○	●	▲	■	●●●	4.37
	E2-15	.59 (14.9)	ø .49	.39-1.97(10-50)	.76 (19.3)	.70-2.28 (17.8-57.8)	1.10-2.95 (28-75)	.79 (20)	.84 (1.25)	4.27 (1.30)	-		-	-	-	▲	○	▲	●	●●●	4.41

Add new E2i.26, .38 and .48 in new e2.1 section





System E2 Mini, E2/000

- Legend**
- Standard
 - Suitable to only a limited extent
 - ▲ Optional
 - Especially suitable
 - * In preparation / on request





Series	Inner height <i>hi</i> in. (mm) ø cable max. in.	Inner width <i>Bi</i> in. (mm) from - to	Outer height <i>ha</i> in. (mm)	Outer width <i>Ba</i> in. (mm) from - to	Bending radii <i>R</i> in. (mm) from - to	Pitch in. (mm)	Unsupported fill weight max lbs/ft (kg/m)	Unsupported length max ft. (m)	Long travel max ft. (m)	Opening design	Interior separation possibilities...			ESD/ATEX	Cleanroom	UL-V2	Low noise	Price index	Page
											Separators	Full-width shelves	Shelves						

E2 Mini - small and medium sizes



e-chains®, non snap-open

	10	.71 (18)	ø .63	.59-3.94 (15-100)	.91 (23)	1.02-4.45 (26-113)	1.10-7.09 (028-180)	1.20 (30.5)	1.01 (1.50)	3.94 (1.20)	-		●	-	-	▲	○	▲	●	●●●●	4.57
	11.031	.91 (23)	ø .83	1.22 (31)	1.10 (28)	1.62 (41.2)	1.77-2.76 (045-070)	1.20 (30.5)	1.01 (1.50)	4.43 (1.35)	-		-	-	-	▲	○	▲	●	●●●●	4.63
	11.080	1.10 (28)	ø .98	3.15 (80)	1.31 (33.4)	3.66 (93)	1.50-2.56 (038-065)	1.20 (30.5)	1.01 (1.50)	4.92 (1.50)	-		-	-	-	▲	○	▲	●	●●●●	4.67
	11.1/11.2	1.61 (41)	ø .89	.59-.98 (15-25)	1.81 (46)	1.00-1.40 (25.5-35.5)	1.57-3.94 (040-100)	1.20 (30.5)	1.01 (1.50)	4.43 (1.35)	-		-	-	-	▲	○	▲	●	●●●●	4.71

e-chains®, snap-open along the inner radius





	14**	.79 (20)	ø .63	.59-1.97 (15-50)	.98 (25)	1.02-2.40 (26-61)	1.10-4.92 (028-125)	1.20 (30.5)	.34 (0.50)	2.13 (0.65)	-		-	-	-	▲	■	●	●	●●●●	4.75
	B15i	.67 (17)	ø .55	.59-3.94 (15-100)	.91 (23)	1.02-4.45 (26-113)	1.50-7.09 (038-180)	1.20 (30.5)	1.01 (1.50)	3.94 (1.20)	-		●	●	-	▲	●	▲	●	●●●●	4.79
	B17i	1.26 (32)	ø 1.10	1.50 (38)	1.54 (39)	1.40-1.91 (35.5-48.5)	1.89-4.92 (048-125)	1.20 (30.5)	.67 (1.00)	3.28 (1.00)	-		●	●	-	▲	○	▲	●	●●●●	4.85
	F17**	1.26 (32)	ø .55	.59 (15)	1.54 (39)	1.02 (26)	1.89 (048)	1.20 (30.5)	1.01 (1.50)	3.94 (1.20)	-		●	●	-	▲	○	●	●	●●●●	4.91

e-chains®, snap-open along the outer radius







	B15	.67 (17)	ø .55	.59-3.94 (15-100)	.91 (23)	1.02-4.45 (26-113)	1.50-7.09 (038-180)	1.20 (30.5)	1.01 (1.50)	3.94 (1.20)	-		●	●	-	▲	●	▲	●	●●●●	4.79
	B17	1.26 (32)	ø 1.10	.59-3.94 (15-100)	1.54 (39)	1.00-1.40 (25.5-113)	1.89-4.92 (048-125)	1.20 (30.5)	.67 (1.00)	3.28 (1.00)	-		●	●	-	▲	○	▲	●	●●●●	4.85

E2/000 - general purpose e-chain® for a wide range of applications





e-chains®, snap-open along the inner radius

	1400	.83 (21)	ø .71	.59-4.92 (15-125)	1.10 (28)	1.12-5.45 (28.5-138.5)	1.38-7.09 (035-180)	1.31 (33.3)	1.34 (2)	5.74 (1.75)	246 (75) ¹⁾		●	●	-	▲	■	▲	●	●●●●	4.103
	2400	.98 (25)	ø .91	.98-4.92 (25-125)	1.38 (35)	1.61-5.55 (41-141)	2.16-9.84 (055-250)	1.81 (46)	3.36 (5)	7.38 (2.25)	328 (100) ¹⁾		●	●	●	▲	■	▲	●	●●●●	4.121
	2600	1.38 (35)	ø 1.26	1.97-7.87 (50-200)	1.97 (50)	2.60-7.63 (66-194)	2.48-.984 (063-250)	2.20 (56)	5.37 (8)	9.02 (2.75)	3.94 (120) ¹⁾		●	●	●	▲	●	▲	●	●●●●	4.141
	3400	1.77 (45)	ø 1.65	1.97-9.84 (50-250)	2.52 (64)	2.76-10.63 (70-270)	2.95-11.81 (075-300)	2.64 (67)	8.74(13)	9.84 (3.00)	492 (150) ¹⁾		●	●	●	▲	●	▲	●	●●●●	4.161





e-chains®, snap-open along the outer radius

	1500	.83 (21)	ø .71	.59-4.92 (15-125)	1.10 (28)	1.12-5.45 (28.5-138.5)	1.38-7.09 (035-180)	1.31 (33.3)	1.34 (2)	5.74 (1.75)	246 (75)		●	●	-	▲ ²⁾ ■	■	▲	●	●●●●	4.103
	2500	.98 (25)	ø .91	.98-4.92 (25-125)	1.38 (35)	1.61-5.55 (41-141)	2.16-9.84 (055-250)	1.81 (46)	3.36 (5)	7.38 (2.25)	328 (100)		●	●	●	▲ ²⁾ ■	■	▲	●	●●●●	4.121
	2700	1.38 (35)	ø 1.26	1.97-7.87 (50-200)	1.97 (50)	2.60-8.62 (66-219)	2.48-.984 (063-250)	2.20 (56)	5.37 (8)	9.02 (2.75)	3.94 (120)		●	●	●	▲ ²⁾ ■	●	▲	●	●●●●	4.141
	3500	1.77 (45)	ø 1.65	1.97-9.84 (50-250)	2.52 (64)	2.76-10.63 (70-270)	2.95-11.81 (075-300)	2.64 (67)	8.74(13)	9.84 (3.00)	492 (150)		●	●	●	▲	●	▲	●	●●●●	4.161
	255	.94 (24)	ø .87	1.50-4.06 (38-103)	1.38 (35)	2.13-4.69 (54-119)	2.16-9.84 (055-250)	1.09 (27.8)	1.34 (2)	5.91 (1.80)	328 (100)		●	●	●	▲	●	▲	■	●●●●	4.181

Half e-tubes, snap-open along the inner radius

	1450	.83 (21)	ø .71	.59-4.92 (15-125)	1.10 (28)	1.12-5.45 (28.5-138.5)	2.95-7.09 (075-180)	1.31 (33.3)	1.34 (2)	5.74 (1.75)	246 (75) ¹⁾		●	●	-	●	■	▲	●	●●●●	4.113
	2450	.98 (25)	ø .91	.98-4.92 (25-125)	1.38 (35)	1.61-5.55 (41-141)	2.95-9.84 (075-250)	1.81 (46)	3.36 (5)	7.38 (2.25)	328 (100) ¹⁾		●	●	▲	●	■	▲	●	●●●●	4.131
	2650	1.38 (35)	ø 1.26	1.97-7.87 (50-200)	1.97 (50)	2.60-8.62 (66-219)	3.94-.984 (100-250)	2.20 (56)	5.37 (8)	9.02 (2.75)	3.94 (120) ¹⁾		●	●	●	●	●	▲	●	●●●●	4.151
	3450	1.77 (45)	ø 1.65	1.97-9.84 (50-250)	2.52 (64)	2.76-10.63 (70-270)	4.92-11.81 (125-300)	2.64 (67)	8.74(13)	9.84 (3.00)	492 (150) ¹⁾		●	●	●	▲	●	▲	●	●●●●	4.171

e-tubes, snap-open along the inner radius

	1480	.83 (21)	ø .71	.59-4.92 (15-125)	1.10 (28)	1.12-5.45 (28.5-138.5)	1.38-7.09 (035-180)	1.31 (33.3)	1.34 (2)	5.74 (1.75)	246 (75) ¹⁾		●	●	-	▲	■	▲	○	●●●●	4.113
	2480	.98 (25)	ø .91	.98-4.92 (25-125)	1.38 (35)	1.61-5.55 (41-141)	2.16-9.84 (055-250)	1.81 (46)	3.36 (5)	7.38 (2.25)	328 (100) ¹⁾		●	●	▲	▲	■	▲	○	●●●●	4.131
	2680	1.38 (35)	ø 1.26	1.97-7.87 (50-200)	1.97 (50)	2.60-8.62 (66-219)	2.48-.984 (063-250)	2.20 (56)	5.37 (8)	9.02 (2.75)	3.94 (120) ¹⁾		●	●	●	▲	●	▲	○	●●●●	4.151
	3480	1.77 (45)	ø 1.65	1.97-9.84 (50-250)	2.52 (64)	2.76-10.63 (70-270)	4.92-11.81 (125-300)	2.64 (67)	8.74(13)	9.84 (3.00)	492 (150) ¹⁾		●	●	●	▲	●	▲	○	●●●●	4.171

** One piece openable along the inner radius with film-hinge

1) Conditionally suitable in inner radii





System E2 tubes

- Legend**
- Standard
 - Suitable to only a limited extent
 - ▲ Optional
 - Especially suitable
 - * In preparation / on request





Series	Inner height <i>hi</i> in. (mm)		Inner width <i>Bi</i> in. (mm)		Outer height <i>ha</i> in. (mm)		Outer width <i>Ba</i> in. (mm)		Bending radii <i>R</i> in. (mm)		Pitch in. (mm)		Unsupported fill weight max lbs/ft (kg/m)		Unsupported length max ft. (m)		Long travel max ft. (m)		Opening design		Interior separation possibilities...			ESD/ATEX	Cleanroom	UL-V2	Low noise	Price index	Page
	<i>hi</i>	ø cable max. in.	<i>Bi</i>	from - to	<i>ha</i>		<i>Ba</i>	from - to	<i>R</i>												Separators	Full-width shelves	Shelves						

E2 R100 - Protection against dirt and debris, cost-effective

E2 R100, Hinged, snap-open on both sides of the inner radius





	R117	.83 (21)	ø .67	.79-3.94 (20-100)	1.10 (28)	1.26-4.41 (32-112)	2.48-7.09 (63-180)	1.20 (30.5)		.154 (0.23)	1.31 (0.40)	-		●	-	-	-	○	▲	○	●	●	●	●	●	●	●	5.9
	R157	1.57 (40)	ø 1.46	1.57-7.87 (40-200)	1.97 (50)	2.20-8.50 (56-216)	3.94-9.84 (100-250)	1.81 (46)		.188 (0.28)	1.80 (0.55)	-		●	●	●	▲	○	▲	○	●	●	●	●	●	●	●	5.15
	R167	1.97 (50)	ø 1.81	1.97-9.84 (50-250)	2.52 (64)	2.67-10.55 (68-268)	3.94-11.81 (100-300)	2.31 (58.8)		.168 (0.25)	1.31 (0.40)	-		●	●	●	▲	○	▲	○	●	●	●	●	●	●	●	5.23

E2 R100, Hinged, snap-open on both sides of the inner radius

	R118	.83 (21)	ø .67	.79-3.94 (20-100)	1.10 (28)	1.26-4.41 (32-112)	2.48-7.09 (63-180)	1.20 (30.5)		1.01 (1.5)	3.93 (1.20)	-		●	-	-	-	○	▲	○	●	●	●	●	●	●	●	5.9
	R158	1.57 (40)	ø 1.46	1.57-7.87 (40-200)	1.97 (50)	2.20-8.50 (56-216)	3.94-9.84 (100-250)	1.81 (46)		5.38 (8.0)	7.38 (2.25)	-		●	●	●	▲	○	▲	○	●	●	●	●	●	●	●	5.15
	R168	1.97 (50)	ø 1.81	1.97-9.84 (50-250)	2.52 (64)	2.67-10.55 (68-268)	3.94-11.81 (100-300)	2.31 (58.8)		6.72 (10.0)	8.20 (2.50)	-		●	●	●	▲	○	▲	○	●	●	●	●	●	●	●	5.23



E2 R - Chip protection at higher speeds and smooth running

E2 R, Removable lids along the outer radius

	R48	.98 (25)	ø .87	.98-5.12 (25-130)	1.42 (36)	1.42-5.55 (36-141)	2.36-9.84 (60-250)	1.19 (30.3)		.67 (1.0)	4.92 (1.50)	-		●	▲	-	▲	○	▲	●	●	●	●	●	●	●	5.33
	R58	1.38 (35)	ø 1.26	1.97-7.87 (50-200)	1.97 (50)	2.60-8.50 (66-216)	2.95-9.84 (75-250)	1.31 (33.3)		5.38 (8.0)	7.55 (2.30)	-		●	●	●	▲	○	▲	●	●	●	●	●	●	●	5.41
	R68	1.77 (45)	ø 1.65	1.97-9.84 (50-250)	2.52 (64)	2.68-10.55 (68-268)	3.94-11.81 (100-300)	1.42 (36)		6.72 (10.0)	8.20 (2.50)	-		●	●	●	▲	○	▲	●	●	●	●	●	●	●	5.49





R2.1 - Cost effective chip protection

R2.1, lids openable along the outer radius from both sides

	R2.75	2.95 (75)	ø 2.36	4.37-7.87 (111-200)	3.54 (90)	5.31-8.82 (135-224)	5.12-9.84 (130-250)	2.36 (60)		8.06 (12)	9.84 (3)	-		●	▲	●	▲	○	▲	●	●	●	●	●	●	●	5.61
--	-------	-----------	--------	---------------------	-----------	---------------------	---------------------	-----------	--	-----------	----------	---	---	---	---	---	---	---	---	---	---	---	---	---	---	---	------

RX - Extremely chip repellent e-tubes

System RX, Openable along the outer radius

	RX32	1.65 (42)	ø 1.46	3.15 (80)	2.20 (56)	3.87 (98.4)	3.15-5.91 (80-150)	1.26 (32)		2.69 (4)	5.58 (1.7)	-		-	-	-	▲	○	▲	●	●	●	●	●	●	●	5.73
	RX40	2.05 (52)	ø 1.89	3.94 (100)	2.76 (70)	4.84 (123)	3.94-11.81 (100-300)	1.57 (40)		4.03 (6)	5.91 (1.8)	-		-	-	-	▲	○	▲	●	●	●	●	●	●	●	5.77
	RX48	2.44 (62)	ø 2.20	4.72 (120)	3.31 (84)	5.81 (147.5)	4.72-5.91 (120-150)	1.89 (48)		6.05 (9)	7.25 (2.1)	-		●	●	-	▲	○	▲	●	●	●	●	●	●	●	5.81
	RX56	2.87 (73)	ø 2.56	5.51 (140)	3.86 (98)	6.78 (172.2)	5.51 (140)	2.20 (56)		7.39 (11)	7.54 (2.3)	-		●	●	-	▲	○	▲	●	●	●	●	●	●	●	5.85

System E4-1

- Legend**
- Standard
 - Suitable to only a limited extent
 - ▲ Optional
 - Especially suitable
 - * In preparation / on request

Series	Inner height <i>hi</i> in. (mm) ø cable max. in.		Inner width <i>Bi</i> in. (mm) from - to		Outer height <i>ha</i> in. (mm)		Outer width <i>Ba</i> in. (mm) from - to		Bending radii <i>R</i> in. (mm) from - to		Pitch in. (mm)	Unsupported fill weight max lbs/ft (kg/m)	Unsupported length max ft. (m)	Long travel max ft. (m)	Opening design	Interior separation possibilities...			ESD/ATEX 	Cleanroom 	UL-V2 	Low noise 	Price index	Page
	Separators	Full-width shelves	Shelves																					

E4-1 - one e-chain® series for almost any applications

E4-1 e-chains®, crossbars every link - robust version



E4-21	.83 (21)	ø .71	1.18-4.72 (30-120)	1.10 (28)	1.73-5.27 (44-134)	1.50-7.87 (38-200)	1.20 (30.5)		2.69 (4)	8.20 (2.5)	394 (120)		●	●	-	▲ ² ■	▲■	▲	▲■	●●●	6.9
E4-28	1.10 (28)	ø .98	1.57-11.81 (40-300)	1.65 (42)	2.36-12.60 (60-320)	2.16-9.84 (55-250)	1.81 (46)		6.72 (10)	8.20 (2.5)	656 (200)		●	●	●	▲ ² ■	▲	▲	▲■	●●●	6.15
E4-32	1.26 (32)	ø 1.10	1.97-15.75 (50-400)	2.13 (54)	2.87-16.65 (73-423)	2.48-11.81 (63-300)	2.20 (56)		10.08 (15.0)	10.83 (3.3)	656 (200)		●	-	●	▲ ² ■	▲■	▲	▲■	●●●	6.27
E4-42	1.65 (42)	ø 1.50	1.97-15.75 (50-400)	2.52 (64)	2.99-16.77 (76-426)	2.95-13.78 (75-350)	2.64 (67)		24.86 (37.0)	13.12 (4.0)	984 (300)		●	-	●	▲ ² ■	▲	▲	▲■	●●●	6.41
E4-56	2.20 (56)	ø 1.97	1.97-23.62 (50-600)	3.31 (84)	3.31-24.96 (84-634)	5.31-19.69 (135-500)	3.58 (91)		42.00 (62.5)	16.41 (5.0)	1312 (400)		●	-	●	▲ ² ■	▲	▲	▲■	●●●	6.57
E4-80	3.15 (80)	ø 2.91	1.97-23.62 (50-600)	4.25 (108)	3.94-25.59 (100-650)	5.91-39.37 (150-1000)	4.37 (111)		53.76 (80.0)	20.34 (6.2)	1312 (400)		●	-	●	▲ ² ■	▲	▲	▲■	●●●	6.73
E4-112	4.41 (112)	ø 3.94	1.97-23.62 (50-600)	5.51 (140)	3.31-24.96 (84-634)	7.87-23.62 (200-600)	5.63 (143)		33.60 (50.0)	14.76 (4.5)	1312 (400)		●	-	●	▲■	▲	▲	▲■	●●●	6.89
E4-162	6.38 (162)	ø 5.71	7.87-23.62 (200-600)	7.68 (195)	10.08-25.83 (256-656)	9.84-39.37 (250-1000)	7.87 (200)		60.48 (90)	22.31 (6.8)	1476 (450)		●	-	●	▲	○	▲	■	●●●	6.103
600	4.25 (108)	ø 3.92	7.87-23.62 (200-600)	5.51 (140)	9.92-25.67 (252-652)	7.87-39.37 (200-1000)	5.63 (143)		43.68 (65.0)	22.97 (7.0)	1476 (450)		●	-	●	▲	○	-	■	●●●	6.109
800	7.87 (200)	ø 7.44	7.87-23.62 (200-600)	9.29 (236)	10.23-25.98 (260-660)	12.80-39.37 (325-1000)	9.84 (250)		60.48 (90.0)	26.25 (8.0)	1,476 (450)		●	-	●	▲	○	▲	■	●●●	6.117
840	8.03 (204)	ø 7.24	3.94-22.17 (100-563)	9.29 (236)	6.30-24.53 (160-623)	12.79-39.37 (325-1000)	9.84 (250)		60.48 (90.0)	26.25 (8.0)	1,476 (450)		●	-	-	▲	○	▲	■	●●●	6.123
E4-350	13.78 (350)	ø 12.40	15.75-31.50 (400-800)	17.72 (450)	21.26 37.01 (540-940)	19.69-39.37 (500-1000)	18.50 (470)		403.18 (600)	20.34 (6.2)	-		●	-	●	▲	-	▲	-	●●●	6.131

H4-1 e-chains®, crossbars every 2nd link - standard version



H4-32	1.26 (32)	ø 1.10	1.97-15.75 (50-400)	2.13 (54)	2.87-16.65 (73-423)	2.48-11.81 (63-300)	2.20 (56)		10.08 (15.0)	10.83 (3.3)	656 (200)		●	-	●	▲■	■	▲■	▲■	●●●	6.27
H4-42	1.65 (42)	ø 1.50	1.97-15.75 (50-400)	2.52 (64)	2.99-16.77 (76-426)	2.95-13.78 (75-350)	2.64 (67)		24.86 (37.0)	13.12 (4.0)	984 (300)		●	-	●	▲■	▲	▲	▲■	●●●	6.41
H4-56	2.20 (56)	ø 1.97	1.97-23.62 (50-600)	3.31 (84)	3.31-24.96 (84-634)	5.31-19.69 (135-500)	3.58 (91)		42.00 (62.5)	16.41 (5.0)	1,312 (400)		●	-	●	▲■	▲	▲	▲■	●●●	6.57
H4-80	3.15 (80)	ø 2.91	1.97-23.62 (50-600)	4.25 (108)	3.94-25.59 (100-650)	5.91-39.37 (150-1000)	4.37 (111)		53.76 (80.0)	20.34 (6.2)	1,312 (400)		●	-	●	▲■	▲	▲	▲■	●●●	6.73
601	4.25 (108)	ø 3.82	7.87-23.62 (200-600)	5.51 (140)	9.92-25.67 (252-652)	7.87-39.37 (200-1000)	5.63 (143)		43.68 (65.0)	22.97 (7.00)	1476 (450)		●	-	●	▲	○	-	■	●●●	6.109

R4-1 e-tubes, Fully enclosed - protection against chips, dust and dirt



R4-28	1.10 (28)	ø .98	1.97-11.81 (50-300)	1.65 (42)	2.76-12.60 (70-320)	2.95-9.84 (75-250)	1.81 (46)		6.72 (10.0)	8.20 (2.5)	656 (200)		●	●	●	▲■	▲	▲	▲■	●●●	6.15
R4-32	1.26 (32)	ø 1.10	1.97-11.81 (50-300)	2.13 (54)	2.87-16.65 (73-323)	4.92-11.81 (125-300)	2.20 (56)		10.08 (15.0)	10.83 (3.3)	656 (200)		●	-	●	▲■	▲■	▲	▲■	●●●	6.27
R4-42	1.65 (42)	ø 1.50	1.97-11.81 (50-300)	2.52 (64)	2.99-16.77 (76-326)	4.92-13.78 (125-350)	2.64 (67)		24.86 (37.0)	13.12 (4.0)	984 (300)		●	-	●	▲■	▲	▲	▲■	●●●	6.41
R4-56	2.20 (56)	ø 1.97	2.95-18.19 (75-462)	3.31 (84)	4.29-19.57 (109-497)	5.91-19.69 (150-500)	3.58 (91)		42.00 (62.5)	16.41 (5.0)	1,312 (400)		●	-	●	▲■	▲	▲	▲■	●●●	6.57
R4-80	3.15 (80)	ø 2.91	7.87-15.75 (200-400)	4.25 (108)	9.84-15.75 (250-450)	7.87-39.37 (200-1000)	4.37 (111)		53.76 (80.0)	20.34 (6.2)	1,312 (400)		●	-	●	▲■	▲	▲	▲■	●●●	6.73
R4-112	4.25 (108)	ø 3.94	7.87-19.69 (200-500)	5.51 (140)	9.92-21.73 (252-552)	9.84-39.37 (250-1000)	5.63 (143)		57.12 (85.0)	21.33 (6.5)	1,476 (450)		●	-	●	▲■	▲	▲	▲■	●●●	6.89
R608	4.25 (108)	ø 3.92	7.87-15.75 (200-400)	5.51 (140)	9.92-17.80 (252-452)	9.84-39.37 (250-1000)	5.63 (143)		43.68 (65.0)	22.97 (7.00)	1476 (450)		●	-	●	▲	○	-	■	●●●	6.109

System E4.1L, E4/light

- Legend**
- Standard
 - Suitable to only a limited extent
 - ▲ Optional
 - Especially suitable
 - * In preparation / on request

Series	Inner height <i>hi</i> in. (mm) ø cable max. in.	Inner width <i>Bi</i> in. (mm) from - to	Outer height <i>ha</i> in. (mm)	Outer width <i>Ba</i> in. (mm) from - to	Bending radii <i>R</i> in. (mm) from - to	Pitch in. (mm)	Unsupported fill weight max lbs/ft (kg/m)	Unsupported length max ft. (m)	Long travel max ft. (m)	Opening design	Interior separation possibilities...			ESD/ATEX	Cleanroom	UL-V2	Low noise	Price index	Page
											Separators	Full-width shelves	Shelves						

E4.1L - low weight, easy assembly and cable friendly design

e-chains®, crossbars openable along the inner and outer radius, from both sides

	E4-31L	1.22 (31)	ø 1.10	1.57-6.89 (40-175)	1.65 (42)	2.13-7.44 (54-189)	2.17-9.84 (055-250)	1.81 (46)		4.70 (7)	6.56 (2)	262 (80)		●	-	●	▲	▲	▲	▲■	●●●	6.143
	E4-38L	1.50 (38)	ø 1.34	1.97-11.81 (50-300)	2.13 (54)	2.60-10.63 (66-270)	2.48-11.81 (063-300)	2.20 (56)		8.73 (13)	9.02 (2.75)	262 (80)		●	-	●	▲	▲	▲	▲■	●●●	6.153
	E4-48L	1.89 (48)	ø 1.69	1.97-11.81 (50-300)	2.52 (64)	2.76-10.63 (70-270)	2.95-13.78 (075-350)	2.64 (67)		17.47 (26)	12.30 (3.75)	328 (100)		●	-	●	▲	▲	▲	▲■	●●●	6.165
	E4-64L	2.52 (64)	ø 2.24	3.43-7.87 (87-200)	3.31 (84)	4.45-7.91 (113-201)	3.94-15.75 (100-400)	3.58 (91)		1.57 (40)	13.45 (4.10)	394 (120)		●	-	●	▲	▲	▲	▲■	●●●	6.179

e-tubes, fully enclosed, lids openable along the inner and outer radius, from both sides

	R4-31L	1.22 (31)	ø 1.10	1.97-3.94 (50-100)	1.65 (42)	2.52-4.49 (64-114)	2.95-9.84 (075-250)	1.81 (46)		4.70 (7)	6.56 (2)	262 (80)		●	-	●	▲	-	▲	▲■	●●●	6.143
	R4-38L	1.50 (38)	ø 1.34	1.97-9.84 (50-250)	2.13 (54)	2.60-10.47 (66-266)	4.92-11.81 (125-300)	2.20 (56)		8.73 (13)	9.02 (2.75)	262 (80)		●	-	●	▲	-	▲	▲■	●●●	6.153
	R4-48L	1.89 (48)	ø 1.69	2.95-6.89 (75-175)	2.52 (64)	3.74-7.68 (95-195)	4.92-13.78 (125-350)	2.64 (67)		17.47 (26)	12.30 (3.75)	328 (100)		●	-	●	▲	-	▲	▲■	●●●	6.165

E4/light - light, strong and cost-effective

e-chains®, crossbars every 2nd link - standard version

	14040	2.20 (56)	ø 1.97	1.97-23.62 (50-600)	3.31 (84)	2.99-24.65 (76-626)	5.31-19.69 (135-500)	3.58 (91)		26.88 (40.0)	13.12 (4.0)	492 (150)		●	-	●	▲■	○	▲	●	●●●	6.193
	14240	2.44 (62)	ø 2.20	1.97-15.75 (50-400)	3.31 (84)	2.99-16.77 (76-426)	5.31-19.69 (135-500)	3.58 (91)		26.88 (40.0)	13.12 (4.0)	492 (150)		●	-	●	▲■	○	▲	●	●●●	6.205
	14550	2.76 (70)	ø 2.44	1.97-23.62 (50-600)	3.86 (98)	3.03-24.68 (77-627)	5.91-23.62 (150-600)	3.58 (91)		36.96 (55.0)	13.78 (4.2)	820 (250)		●	-	●	▲■	○	▲	●	●●●	6.217
	15050	3.15 (80)	ø 2.91	1.97-23.62 (50-600)	4.25 (108)	3.15-24.80 (80-630)	5.91-23.62 (150-600)	3.58 (91)		36.96 (55.0)	15.09 (4.6)	820 (250)		●	-	●	▲■	○	▲	●	●●●	6.227
	15250	3.39 (86)	ø 2.95	1.97-15.75 (50-400)	4.25 (108)	3.15-16.93 (80-430)	5.91-23.62 (150-600)	3.58 (91)		36.96 (55.0)	15.09 (4.6)	820 (250)		●	-	●	▲■	○	▲	●	●●●	6.241
	1640	4.41 (112)	ø 3.94	1.97-23.62 (50-600)	5.51 (140)	3.31-24.96 (84-634)	7.87-23.62 (200-600)	5.63 (143)		33.60 (50.0)	14.76 (4.5)	1,312 (400)		●	-	●	▲■	○	▲	●	●●●	6.251

e-chains®, crossbars every link - robust version

	14140	2.20 (56)	ø 1.97	1.97-23.62 (50-600)	3.31 (84)	2.99-24.65 (76-626)	5.31-19.69 (135-500)	3.58 (91)		26.88 (40.0)	13.12 (4.0)	492 (150)		●	-	●	▲■	○	▲	●	●●●	6.193
	14340	2.44 (62)	ø 2.20	1.97-15.75 (50-400)	3.31 (84)	2.99-16.77 (76-426)	5.31-19.69 (135-500)	3.58 (91)		26.88 (40.0)	13.12 (4.0)	492 (150)		●	-	●	▲■	○	▲	●	●●●	6.205
	14650	2.76 (70)	ø 2.44	1.97-23.62 (50-600)	3.86 (98)	3.03-24.68 (77-627)	5.91-23.62 (150-600)	3.58 (91)		36.96 (55.0)	13.78 (4.2)	820 (250)		●	-	●	▲■	○	▲	●	●●●	6.217
	15150	3.15 (80)	ø 2.91	1.97-23.62 (50-600)	4.25 (108)	3.15-24.80 (80-630)	5.91-23.62 (150-600)	3.58 (91)		36.96 (55.0)	15.09 (4.6)	820 (250)		●	-	●	▲■	○	▲	●	●●●	6.227
	15350	3.39 (86)	ø 2.95	1.97-15.75 (50-400)	4.25 (108)	3.15-16.93 (80-430)	5.91-23.62 (150-600)	3.58 (91)		36.96 (55.0)	15.09 (4.6)	820 (250)		●	-	●	▲■	○	▲	●	●●●	6.241

e-tubes, Fully enclosed - protection against chips, dust and dirt

	R18840	2.20 (56)	ø 1.97	2.95-18.19 (75-462)	3.31 (84)	3.98-19.25 (101-489)	5.91-19.69 (150-500)	3.58 (91)		26.88 (40.0)	13.12 (4.0)	492 (150)		●	-	●	▲■	○	▲	●	●●●	6.193
	R19050	2.76 (70)	ø 2.44	2.95-18.19 (75-462)	3.86 (98)	4.02-19.25 (102-489)	7.87-23.62 (200-600)	3.58 (91)		36.96 (55.0)	13.78 (4.2)	820 (250)		●	-	●	▲■	○	▲	●	●●●	6.217
	R19850	3.15 (80)	ø 2.91	2.95-18.19 (75-462)	4.25 (108)	4.13-19.41 (105-493)	7.87-23.62 (200-600)	3.58 (91)		36.96 (55.0)	15.09 (4.6)	820 (250)		●	-	●	▲■	○	▲	●	●●●	6.227
	R1608	4.41 (112)	ø 3.94	7.87-15.75 (200-400)	5.51 (140)	9.21-17.09 (234-434)	9.84-24.96 (250-600)	5.63 (143)		33.60 (50.0)	14.76 (4.5)	1,312 (400)		●	-	●	▲■	○	▲	●	●●●	6.251

System T3, E3, E6-1, E6

- Legend**
- Standard
 - Suitable to only a limited extent
 - ▲ Optional
 - Especially suitable
 - * In preparation / on request

Series	Inner height		Inner width		Outer height	Outer width		Bending radii	Pitch in. (mm)	Unsupported fill weight max lbs/ft (kg/m)	Unsupported length max ft. (m)	Long travel max ft. (m)	Opening design	Interior separation possibilities...			EDS/ATEX	Cleanroom	UL-V2	Low noise	Price index	Page
	hi in. (mm)	ø cable max. in.	Bi in. (mm)	from - to		Ba in. (mm)	from - to							R in. (mm)	Separators	Full-width shelves						

T3 - Smooth running "T-band", quiet, cost effective

e-chains®, Crossbars removable along the inner and outer radius

	T3-29	1.14 (29)	ø .98	1.18-5.51 (30-140)	1.38 (35)	2.17-5.71 (55-145)	1.50 (038)	.59 (15)		.67 (1.00)	4.75 (1.45)	-		●	●	●	▲	■	▲	■	●●●	7.11
--	-------	-----------	-------	--------------------	-----------	--------------------	------------	----------	--	------------	-------------	---	--	---	---	---	---	---	---	---	-----	------

E3 - Highly dynamic and cleanroom compatible

e-chains®, crossbars on a strip, zip-open along the outer radius

	E3-10	.39 (10)	ø .31	.79-2.36 (20-60)	.59 (15)	1.26-2.83 (32-72)	.59-1.89 (015-48)	.66 (16.7)		0.20 (0.30)	2.46 (0.75)	-		●	-	-	-	■	▲	■	●●●	7.23
	E3-15	.59 (15)	ø .51	.79-2.36 (20-60)	.79 (20)	1.26-2.83 (32-72)	1.26-2.95 (032-75)	.66 (16.7)		0.47 (0.70)	2.95 (0.90)	-		●	▲	-	-	■	▲	■	●●●	7.27
	E3-22	.87 (22)	ø .79	.79-2.36 (20-60)	1.06 (27)	1.26-2.83 (32-72)	1.73-2.95 (044-75)	.66 (16.7)		0.57 (0.85)	3.94 (1.20)	-		●	▲	-	-	■	▲	■	●●●	7.31

E6-1 - low noise 32dB(A), dynamic, light and cleanroom suitable

e-chains®, crossbars openable along the inner and outer radius, from both sides

	E61-29	1.14 (29)	ø .98	1.18-5.51 (30-140)	1.38 (35)	1.73-5.67 (44-144)	2.17-5.91 (055-150)	.87 (22)		2.35 (3.5)	4.92 (1.50)	-		●	●	●	▲	■	▲	■	●●●	7.41
--	--------	-----------	-------	--------------------	-----------	--------------------	---------------------	----------	--	------------	-------------	---	--	---	---	---	---	---	---	---	-----	------

e-chains®, crossbars removable along the inner and outer radius

	EF61-29	1.14 (29)	ø .98	1.18-5.51 (30-140)	1.38 (35)	1.73-6.06 (44-154)	2.17-5.91 (055-150)	.87 (22)		2.02 (3.0)	5.74 (1.75)	-		●	●	●	▲	■	▲	■	●●●	7.41
	E61-35	1.38 (35)	ø 1.22	1.18-5.51 (30-140)	1.65 (42)	1.81-6.14 (46-156)	2.17-3.94 (055-150)	.98 (25)		4.03 (6.0)	6.23 (1.90)	-		●	●	●	▲	■	▲	■	●●●	7.47
	E61-40	1.57 (40)	ø 1.42	1.57-11.81 (40-300)	2.13 (54)	2.20-12.44 (56-316)	2.48-7.87 (063-200)	1.09 (27.8)		6.72 (10.0)	9.02 (2.75)	197 (60)*		●	●	●	▲	■	▲	■	●●●	7.53
	E61-52	2.05 (52)	ø 1.81	1.57-11.81 (40-300)	2.56 (65)	2.52-12.76 (64-324)	2.95-5.91 (075-150)	1.18 (30)		10.08 (15.0)	9.84 (3.00)	262 (80)*		●	●	●	▲	■	▲	■	●●●	7.61

E6 - Extremely low noise 37dB(A), low vibration and abrasion, cleanroom suitable

e-chains®, crossbars every 2nd link - crossbars removable along the inner and outer radius

	E6-29	1.14 (29)	ø .98	1.18-5.51 (30-140)	1.38 (35)	1.81-6.14 (46-156)	2.17-5.91 (055-150)	.87 (22)		2.02 (3.0)	5.74 (1.75)	-		●	●	●	▲	■	▲	■	●●●	7.71
	E6-35	1.38 (35)	ø 1.22	1.18-5.51 (30-140)	1.65 (42)	1.97-6.30 (50-160)	2.17-3.94 (055-150)	.98 (25)		4.03 (6.0)	6.23 (1.90)	-		●	●	●	▲	■	▲	■	●●●	7.81
	E6-40	1.57 (40)	ø 1.42	1.57-11.81 (40-300)	2.13 (54)	2.36-12.60 (60-320)	2.48-7.87 (063-200)	1.09 (27.8)		6.72 (10.0)	9.02 (2.75)	197 (60)*		●	●	●	▲	■	▲	■	●●●	7.87
	E6-52	2.05 (52)	ø 1.81	1.57-11.81 (40-300)	2.56 (65)	2.52-12.76 (64-324)	2.95-9.84 (075-250)	1.18 (30)		10.08 (15.0)	9.84 (3.00)	262 (80)*		●	●	●	▲	■	▲	■	●●●	7.97
	E6-62	2.44 (62)	ø 2.13	1.97-15.75 (50-400)	3.31 (84)	3.39-17.17 (86-436)	4.53-13.78 (115-350)	1.97 (50)		28.90 (43.0)	13.12 (4.00)	328 (100)		●	●	●	▲	■	▲	■	●●●	7.107
	E6-80	3.15 (80)	ø 2.83	1.97-23.62 (50-600)	4.25 (108)	3.94-25.59 (100-650)	5.91-17.72 (150-450)	2.56 (65)		37.63 (56.0)	17.23 (5.25)	394 (120)		●	-	●	▲	■	▲	■	●●●	7.115
	E6-80L	3.15 (80)	ø 2.83	3.43-21.65 (87-550)	4.25 (108)	4.53-22.76 (115-578)	5.91-17.72 (150-450)	2.56 (65)		16.80 (25.0)	8.20 (2.50)	-		●	-	●	▲	■	▲	■	●●●	7.125

e-tubes, Fully enclosed

	R6-29	1.10 (28)	ø .98	1.18-4.72 (30-120)	1.38 (35)	1.81-5.35 (46-136)	2.17-5.91 (055-150)	.87 (22)		2.02 (3.0)	4.92 (1.50)	-		●	-	-	▲	■	▲	■	●●●	7.77
	R6-40	1.57 (40)	ø 1.42	1.97-4.92 (50-125)	2.13 (54)	2.76-5.71 (70-145)	2.48-7.87 (063-200)	1.09 (27.8)		6.72 (10.0)	9.02 (2.75)	197 (60)*		●	-	-	▲	■	▲	■	●●●	7.93
	R6-52	2.05 (52)	ø 1.81	1.97-6.89 (50-175)	2.56 (65)	2.91-7.83 (74-199)	2.95-9.84 (075-250)	1.18 (30)		10.08 (15.0)	9.84 (3.00)	262 (80)*		●	-	-	▲	■	▲	■	●●●	7.103

System e-skin, TH3

- Legend**
- Standard
 - Suitable to only a limited extent
 - ▲ Optional
 - Especially suitable
 - * In preparation / on request

Series	Inner height <i>hi</i> in. (mm) ø cable max. in.	Inner width <i>Bi</i> in. (mm) from - to	Outer height <i>ha</i> in. (mm)	Outer width <i>Ba</i> in. (mm) from - to	Bending radii <i>R</i> in. (mm) from - to	Pitch in. (mm)	Unsupported fill weight max lbs/ft (kg/m)	Unsupported length max ft. (m)	Long travel max ft. (m)	Opening design	Interior separation possibilities...			EDS/ATEX	Cleanroom	UL-V2	Low noise	Price index	Page
											Separators	Full-width shelves	Shelves						

e-skin - novel corrugated hose energy supply system for cleanrooms

Oval design - Can be opened and closed like a zipper

	SK28	1.10 (28)	ø .98	2.68 (68)	1.57 (40)	3.74 (95)	-	-	.67 (1.0)	2.41 (.75)	-		●	●	-	-	■	-	■	●●●	7.141
	SK40	1.50 (38)	ø 1.18	3.35 (85)	2.24 (57)	4.65 (118)	-	-	1.01 (1.5)	4.10 (1.25)	-		●	●	-	-	■	-	■	●●●	7.145

TH3 - e-chain® designed according to hygienic principles

Open design - easy to clean

	2-Segment																				
	TH3.25.2/26	1.00 (25.5)	ø .92/.72	2.76 (70)	1.38 (35)	3.38 (86)	2.76 (070)	2.20 (56)	1.21 (1.8)	3.94 (1.2)	-	●	-	-	▲	■	●	■	●●●	7.153	
	TH3.45.2/20	2 x 20 (.79)	ø .71	2.76 (70)	2.24 (57)	3.54 (90)	3.54 (090)	3.80 (96.5)	1.34 (2.0)	4.59 (1.4)	-	●	-	-	▲	■	●	●	●●●	7.159	
	3-Segment																				
	TH3.25.3/26	1.00 (25.5)	ø .92/.72	3.74 (95)	1.38 (35)	4.37 (111)	2.76 (070)	2.20 (56)	1.21 (1.8)	3.94 (1.2)	-	●	-	-	▲	■	●	■	●●●	7.153	
	TH3.45.3/20	2 x 20 (.79)	ø .71	3.74 (95)	2.24 (57)	4.53 (115)	3.54 (090)	3.80 (96.5)	1.34 (2.0)	4.59 (1.4)	-	●	-	-	▲	■	●	●	●●●	7.159	
	4-Segment																				
	TH3.25.4/26*	1.00 (25.5)	ø .92/.72	2.76 (70)	1.38 (35)	5.35 (136)	2.76 (070)	2.20 (56)	1.21 (1.8)	3.94 (1.2)	-	●	-	-	▲	■	●	■	●●●	7.153	
	TH3.45.4/20*	2 x 20 (.79)	ø .71	2.76 (70)	2.24 (57)	5.51 (140)	3.54 (090)	3.80 (96.5)	1.34 (2.0)	4.59 (1.4)	-	●	-	-	▲	■	●	●	●●●	7.159	
	5-Segment																				
	TH3.25.5/26*	1.00 (25.5)	ø .92/.72	2.76 (70)	1.38 (35)	6.34 (161)	2.76 (070)	2.20 (56)	1.21 (1.8)	3.94 (1.2)	-	●	-	-	▲	■	●	■	●●●	7.153	
	TH3.45.5/20	2 x 20 (.79)	ø .71	2.76 (70)	2.24 (57)	6.50 (165)	3.54 (090)	3.80 (96.5)	1.34 (2.0)	4.59 (1.4)	-	●	-	-	▲	■	●	●	●●●	7.159	





- Legend**
- Standard
 - Suitable to only a limited extent
 - ▲ Optional
 - Especially suitable
 - * In preparation / on request

Series	Inner height <i>hi</i> in. (mm) ø cable max. in.	Inner width <i>Bi</i> in. (mm) from - to	Outer height <i>ha</i> in. (mm)	Outer width <i>Ba</i> in. (mm) from - to	Bending radii <i>R</i> in. (mm) from - to	Pitch in. (mm)	Unsupported fill weight max lbs/ft (kg/m)	Unsupported length max ft. (m)	Long travel max ft. (m)	Opening design	Interior separation possibilities...			EDS/ATEX	Cleanroom	UL-V2	Low noise	Price index	Page
											Separators	Full-width shelves	Shelves						

triflex® R - for multi-axis movement and robots

TRC, closed design

	TRC-30	.47/.39 (12/10)	ø .39	.47/.39 (12/10)	1.36 (34.5)	1.36 (34.5)	1.97 (050)	.44 (11.3)	-	-	-		●	-	-	1)	○	●	●	●●●●	8.13
	TRC-40	.59/.51 (15/13)	ø .51	.59/.51 (15/13)	1.69 (43)	1.69 (43)	2.28 (058)	.55 (13.9)	-	-	-		●	-	-	▲ ²	○	●	●	●●●●	8.13
	TRC-50	.74/.64 (18.8/16.2)	ø .55	.74/.64(18.8/16.2)	2.13 (54)	2.13 (54)	3.15 (080)	.69 (17.4)	-	-	-		●	-	-	▲ ²	○	●	●	●●●●	8.13
	TRC-60	.89/.77 (22.5/19.5)	ø .81	.89/.77 (22.5/19.5)	2.56 (65)	2.56 (65)	3.43 (087)	.80 (20.4)	-	-	-		●	-	-	▲ ²	○	●	●	●●●●	8.13
	TRC-70	1.10/.94 (28/24)	ø 1.02	1.10/.94 (28/24)	3.19 (81)	3.19 (81)	4.33 (110)	1.01 (25.6)	-	-	-		●	-	-	▲ ²	○	●	●	●●●●	8.13
	TRC-85	1.30/1.10 (33/28)	ø 1.22	1.30/1.10 (33/28)	3.72 (94.5)	3.72 (94.5)	5.31 (135)	1.20 (30.6)	-	-	-		●	-	-	▲	○	●	●	●●●●	8.13
	TRC-100	1.48/1.28 (37.5/32.5)	ø 1.40	1.48/1.28 (37.5/32.5)	4.25 (108)	4.25 (108)	5.71 (145)	1.41 (35.7)	-	-	-		●	-	-	▲	○	●	●	●●●●	8.13
	TRC-125	1.70/1.70 (43.3/43.3)	ø 1.40	1.70/1.70 (43.3/43.3)	5.31 (135)	5.31 (135)	7.17 (182)	1.76 (44.6)	-	-	-		●	-	-	○	○	●	●	●●●●	8.13

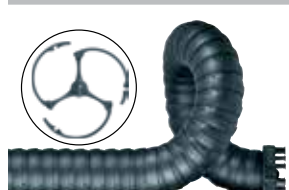
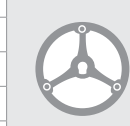

TRCF, closed design with snap-lock mechanism

	TRCF-65	.88 (22.3)	ø .79	.88 (22.3)	2.76 (70.2)	2.76 (70.2)	3.94 (100)	.91 (23.1)	-	-	-		●	-	-	1)	○	●	●	●●●●	8.17
	TRCF-85	1.18 (30)	ø 1.10	1.18 (30)	3.72 (94.5)	3.72 (94.5)	5.31 (135)	1.20 (30.6)	-	-	-		●	-	-	1)	○	●	●	●●●●	8.17
	TRCF-85*	1.18 (30)	ø 1.10	1.18 (30)	3.72 (94.5)	3.72 (94.5)	9.45 (240)	1.20 (30.6)	-	-	-		●	-	-	1)	○	●	●	●●●●	8.17
	TRCF-100	1.35 (34.3)	ø 1.26	1.35 (34.3)	4.25 (108)	4.25 (108)	5.71 (145)	1.36 (34.5)	-	-	-		●	-	-	1)	○	●	●	●●●●	8.17

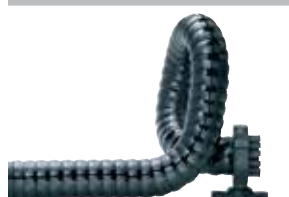
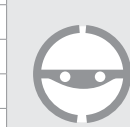
TRE, "E-Z" design for fast installation of cables and hoses

	TRE-30	.47/.39 (12/10)	ø .39	.47/.39 (12/10)	1.36 (34.5)	1.36 (34.5)	1.97 (050)	.44 (11.3)	-	-	-		●	-	-	-	○	●	●	●●●●	8.15
	TRE-40	.59/.51 (15/13)	ø .51	.59/.51 (15/13)	1.69 (43)	1.69 (43)	2.28 (058)	.55 (13.9)	-	-	-		●	-	-	-	○	●	●	●●●●	8.15
	TRE-50	.74/.64 (18.8/16.2)	ø .55	.74/.64(18.8/16.2)	2.13 (54)	2.13 (54)	3.15 (080)	.69 (17.4)	-	-	-		●	-	-	-	○	●	●	●●●●	8.15
	TRE-60	.89/.77 (22.5/19.5)	ø .81	.89/.77 (22.5/19.5)	2.56 (65)	2.56 (65)	3.43 (087)	.80 (20.4)	-	-	-		●	-	-	-	○	●	●	●●●●	8.15
	TRE-70	1.10/.94 (28/24)	ø 1.02	1.10/.94 (28/24)	3.19 (81)	3.19 (81)	4.33 (110)	1.01 (25.6)	-	-	-		●	-	-	-	○	●	●	●●●●	8.15
	TRE-85	1.30/1.10 (33/28)	ø 1.22	1.30/1.10 (33/28)	3.72 (94.5)	3.72 (94.5)	5.31 (135)	1.20 (30.6)	-	-	-		●	-	-	-	○	●	●	●●●●	8.15
	TRE-100	1.48/1.28 (37.5/32.5)	ø 1.40	1.48/1.28 (37.5/32.5)	4.25 (108)	4.25 (108)	5.71 (145)	1.41 (35.7)	-	-	-		●	-	-	-	○	●	●	●●●●	8.15
	TRE-125	1.70/1.70 (43.3/43.3)	ø 1.40	1.70/1.70 (43.3/43.3)	5.31 (135)	5.31 (135)	7.17 (182)	1.76 (44.6)	-	-	-		●	-	-	-	○	●	●	●●●●	8.15

TRL, light version with "E-Z" design

	TRL-30	.47/.39 (12/10)	ø .39	.47/.39 (12/10)	1.36 (34.5)	1.36 (34.5)	1.97 (050)	.44 (11.3)	-	-	-		●	-	-	1)	○	●	●	●●●●	8.19
	TRL-40	.59/.51 (15/13)	ø .51	.59/.51 (15/13)	1.77 (45)	1.77 (45)	2.28 (058)	.55 (13.9)	-	-	-		●	-	-	1)	○	●	●	●●●●	8.19
	TRL-60	.89/.77 (22.5/19.5)	ø .83	.89/.77 (22.5/19.5)	2.56 (65)	2.56 (65)	3.43 (087)	.80 (20.4)	-	-	-		●	-	-	1)	○	●	●	●●●●	8.19
	TRL-70	1.10/.94 (28/24)	ø 1.02	1.10/.94 (28/24)	3.19 (81)	3.19 (81)	4.33 (110)	1.01 (25.6)	-	-	-		●	-	-	1)	○	●	●	●●●●	8.19
	TRL-100	1.48/1.28 (37.5/32.5)	ø 1.40	1.48/1.28 (37.5/32.5)	4.25 (108)	4.25 (108)	5.71 (145)	1.41 (35.7)	-	-	-		●	-	-	1)	○	●	●	●●●●	8.19

TRLF, light version with snap-lock mechanism

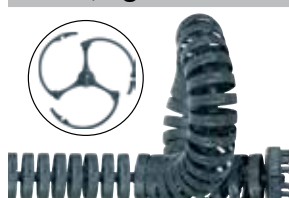
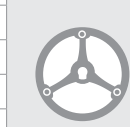
	TRLF-65	.96 (24.4)	ø .87	.96 (24.4)	2.76 (70.2)	2.76 (70.2)	3.94 (100)	.91 (23.1)	-	-	-		●	-	-	-	○	●	●	●●●●	8.21
	TRLF-85	1.29 (32.8)	ø 1.18	1.29 (32.8)	3.72 (94.5)	3.72 (94.5)	5.31 (135)	1.22 (31)	-	-	-		●	-	-	-	○	●	●	●●●●	8.21
	TRLF-100	1.48 (37.5)	ø 1.40	1.48 (37.5)	4.25 (108)	4.25 (108)	5.71 (145)	1.36 (34.5)	-	-	-		●	-	-	-	○	●	●	●●●●	8.21
	TRLF-125	1.84 (46.8)	ø 1.75	1.84 (46.8)	5.31 (135)	5.31 (135)	7.17 (182)	1.74 (44.1)	-	-	-		●	-	-	-	○	●	●	●●●●	8.21

- Legend**
- Standard
 - Suitable to only a limited extent
 - ▲ Optional
 - Especially suitable
 - * In preparation / on request

Series	Inner height <i>hi</i> in. (mm) ø cable max. in.	Inner width <i>Bi</i> in. (mm) from - to	Outer height <i>ha</i> in. (mm)	Outer width <i>Ba</i> in. (mm) from - to	Bending radii <i>R</i> in. (mm) from - to	Pitch in. (mm)	Unsupported fill weight max lbs/ft (kg/m)	Unsupported length max ft. (m)	Long travel max ft. (m)	Opening design	Interior separation possibilities...			ESD/ATEX	Cleanroom	UL-V2	Low noise	Price index	Page
											Separators	Full-width shelves	Shelves						

E-Z triflex[®] - For simple, closed 3D applications

“E-Z” design for fast installation of cables and hoses



E331-25	.98 (25)	ø .35	.98 (25)	1.34 (34)	1.34 (34)	1.89-7.87 (48-200)	.57 (14.5)	-	-	-		●	-	-	▲	○	●	●	●	●	8.90
E331-32	1.26 (32)	ø .47	1.26 (32)	1.97 (50)	1.97 (50)	2.95-9.84 (75-250)	.98 (25)	-	-	-		●	-	-	▲	○	●	●	●	●	8.90
E331-50	1.97 (50)	ø .83	1.97 (50)	2.68 (68)	2.68 (68)	3.94-9.84 (100-250)	1.18 (30)	-	-	-		●	-	-	▲	○	●	●	●	●	8.90
E331-75	2.95 (75)	ø 1.30	2.95 (75)	3.78 (96)	3.78 (96)	5.51-11.81 (140-300)	1.42 (36)	-	-	-		●	-	-	▲	○	●	●	●	●	8.90
E332-25	.98 (25)	ø .35	.98 (25)	1.34 (34)	1.34 (34)	1.89-7.87 (48-200)	.57 (14.5)	-	-	-		●	-	-	▲	○	●	●	●	●	8.91
E332-32	1.26 (32)	ø .47	1.26 (32)	1.97 (50)	1.97 (50)	2.95-9.84 (75-250)	.98 (25)	-	-	-		●	-	-	▲	○	●	●	●	●	8.91
E332-50	1.97 (50)	ø .83	1.97 (50)	2.68 (68)	2.68 (68)	3.94-9.84 (100-250)	1.18 (30)	-	-	-		●	-	-	▲	○	●	●	●	●	8.91
E332-75	2.95 (75)	ø 1.30	2.95 (75)	3.78 (96)	3.78 (96)	5.51-11.81 (140-300)	1.42 (36)	-	-	-		●	-	-	▲	○	●	●	●	●	8.91
E333-25	.98 (25)	ø .35	.98 (25)	1.34 (34)	1.34 (34)	1.89-7.87 (48-200)	.57 (14.5)	-	-	-		●	-	-	▲	○	●	●	●	●	8.93
E333-32	1.26 (32)	ø .47	1.26 (32)	1.97 (50)	1.97 (50)	2.95-9.84 (75-250)	.98 (25)	-	-	-		●	-	-	▲	○	●	●	●	●	8.93
E333-50	1.97 (50)	ø .83	1.97 (50)	2.68 (68)	2.68 (68)	3.94-9.84 (100-250)	1.18 (30)	-	-	-		●	-	-	▲	○	●	●	●	●	8.93
E333-75	2.95 (75)	ø 1.30	2.95 (75)	3.78 (96)	3.78 (96)	5.51-11.81 (140-300)	1.42 (36)	-	-	-		●	-	-	▲	○	●	●	●	●	8.93

triflex[®] - For simple, closed 3D applications

Closed design



331-16	.63 (16)	ø .55	.63 (16)	1.02 (26)	1.02 (26)	1.50-3.94 (38-100)	.52 (13.3)	-	-	-		-	-	-	▲	○	▲	○	●	●	8.103
331-32	1.26 (32)	ø 1.10	1.26 (32)	1.97 (50)	1.97 (50)	2.95-9.84 (75-250)	.98 (25)	-	-	-		●	-	-	▲	○	▲	○	●	●	8.103
331-50	1.97 (50)	ø 1.77	1.97 (50)	2.68 (68)	2.68 (68)	3.94-9.84 (100-250)	1.18 (30)	-	-	-		●	-	-	▲	○	▲	○	●	●	8.103
331-75	2.95 (75)	ø 2.64	2.95 (75)	3.78 (96)	3.78 (96)	5.51-11.81 (140-300)	1.42 (36)	-	-	-		●	-	-	▲	○	▲	○	●	●	8.103
332-16	.63 (16)	ø .55	.63 (16)	1.02 (26)	1.02 (26)	1.50-3.94 (38-100)	.52 (13.3)	-	-	-		-	-	-	▲	○	▲	○	●	●	8.104
332-32	1.26 (32)	ø 1.10	1.26 (32)	1.97 (50)	1.97 (50)	2.95-9.84 (75-250)	.98 (25)	-	-	-		●	-	-	▲	○	▲	○	●	●	8.104
332-50	1.97 (50)	ø 1.77	1.97 (50)	2.68 (68)	2.68 (68)	3.94-9.84 (100-250)	1.18 (30)	-	-	-		●	-	-	▲	○	▲	○	●	●	8.104
332-75	2.95 (75)	ø 2.64	2.95 (75)	3.78 (96)	3.78 (96)	5.51-11.81 (140-300)	1.42 (36)	-	-	-		●	-	-	▲	○	▲	○	●	●	8.104
333-16	.63 (16)	ø .55	.63 (16)	1.02 (26)	1.02 (26)	1.50-3.94 (38-100)	.52 (13.3)	-	-	-		-	-	-	▲	○	▲	○	●	●	8.105
333-32	1.26 (32)	ø 1.10	1.26 (32)	1.97 (50)	1.97 (50)	2.95-9.84 (75-250)	.98 (25)	-	-	-		●	-	-	▲	○	▲	○	●	●	8.105
333-50	1.97 (50)	ø 1.77	1.97 (50)	2.68 (68)	2.68 (68)	3.94-9.84 (100-250)	1.18 (30)	-	-	-		●	-	-	▲	○	▲	○	●	●	8.105
333-75	2.95 (75)	ø 2.64	2.95 (75)	3.78 (96)	3.78 (96)	5.51-11.81 (140-300)	1.42 (36)	-	-	-		●	-	-	▲	○	▲	○	●	●	8.105

Snap-open



351-50	1.97 (50)	ø 1.77	1.97 (50)	2.68 (68)	2.68 (68)	3.94-9.84 (100-250)	1.18 (30)	-	-	-		●	-	-	▲	○	▲	○	●	●	8.103
352-50	1.97 (50)	ø 1.77	1.97 (50)	2.68 (68)	2.68 (68)	3.94-9.84 (100-250)	1.18 (30)	-	-	-		●	-	-	▲	○	▲	○	●	●	8.104
353-50	1.97 (50)	ø 1.77	1.97 (50)	2.68 (68)	2.68 (68)	3.94-9.84 (100-250)	1.18 (30)	-	-	-		●	-	-	▲	○	▲	○	●	●	8.105

twisterchain, twisterband

- Legend**
- Standard
 - Suitable to only a limited extent
 - ▲ Optional
 - Especially suitable
 - * In preparation / on request

Series	Inner height		Inner width		Outer height	Outer width		Bending radii		Pitch	Fill weight up to 360° max lbs/ft (kg/m)	Unsupported length max ft. (m)	Long travel max ft. (m)	Opening design	Interior separation possibilities...			ESD/ATEX	Cleanroom	UL-V2	Low noise	Price index	Page
	<i>hi</i> in. (mm)	∅ cable max. in.	<i>Bi</i> in. (mm)	from - to	<i>ha</i> in. (mm)	<i>Ba</i> in. (mm)	from - to	<i>R</i> in. (mm)	in. (mm)	Separators					Full-width shelves	Shelves							

twisterchain - Circular and spiral movements up to 360° from stock (up to 540° upon request)

e-chains® - Crossbars removable along the inner and outer radius



									180°	360°												
2208	1.10 (28)	∅ .98	2.07-4.43 (52.5-112.5)	1.65 (42)	3.15-5.51 (80-140)	2.17-5.91 (055-150)	1.73 (44)	.67 (1)	1.01 (1.5)	-	-		●	●	●	▲	○	▲	●	●●●●	8.115	
TC32	1.26 (32)	∅ 1.10	3.44-5.91 (87.5-150)	2.13 (54)	4.27-6.73 (108.5-171)	3.94-9.84 (100-250)	2.20 (56)	2.69 (4)	1.34 (2)	-	-		●	●	●	▲	○	▲	●	●●●●	8.117	
TC42	1.65 (42)	∅ 1.50	3.44-5.91 (87.5-150)	2.52 (64)	4.35-8.78 (110.5-223)	3.94-9.84 (100-250)	2.64 (67)	2.42 (3.6)	2.42 (3.6)	-	-		●	●	●	▲	○	▲	●	●●●●	8.119	
TC56	2.20 (56)	∅ 1.97	4.92-7.87 (125-200)	3.31 (84)	6.10-9.06 (155-230)	5.91-15.75 (150-400)	3.58 (91)	3.36 (5)	3.36 (5)	-	-		●	●	●	▲	○	▲	●	●●●●	8.121	

twisterband up to 7000°* rotary movements in the smallest spaces

e-chains® - Openable with film-hinge or can be opened with "E-Z" design





TB12-23-09	.36 (9)	∅ .28	.91 (23)	-	-	.94-1.38 (024- 035)	-	-	-	-	-		-	-	-	○	○	●	●	●●●●	8.137
TB20-44-12	.47 (12)	∅ .36	1.73 (44)	-	-	1.34- 2.24 (034-057)	-	-	-	-	-		-	-	-	○	○	●	●	●●●●	8.137
TB20-44-18	.71 (18)	∅ .55	1.73 (44)	-	-	1.34-2.24 (034-057)	-	-	-	-	-		●	-	-	○	○	●	●	●●●●	8.137
TB29-27-22	.87 (22)	∅ .67	1.06 (27)	-	-	2.72-3.23 (069-082)	-	-	-	-	-		●	-	-	○	○	●	●	●●●●	8.137
TB30-75-22	.87 (22)	∅ .67	2.95 (75)	-	-	1.73-3.03 (044-077)	-	-	-	-	-		●	-	-	○	○	●	●	●●●●	8.137

e-chains® - links with strong pin and hook connection - openable with film-hinge

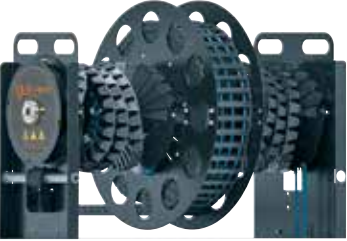

TBHD30.75.22	.87 (22)	∅ .67	2.95 (75)	-	-	1.73-3.03 (044-077)	-	-	-	-	-		●	-	-	○	○	●	●	●●●●	8.141
TBHD42.135.30	1.18 (30)	∅ .79	5.31 (135)	-	-	2.20-4.69 (056-119)	-	-	-	-	-		●	-	-	○	○	●	●	●●●●	8.141

Special solutions for multi-axis movements

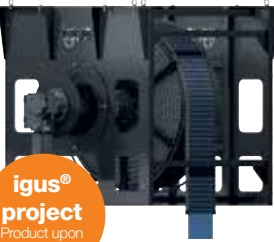
	Description	Suitable industries and applications	travel max ft. (m)	Travel speed max ft. (m)	Price index	Page
E-Spool - The cable drum without a slip ring						
e-spool standard and HD - flexible use						
	<ul style="list-style-type: none"> ● Flexible energy supply - guidance of different media in one system ● Flexible use - energy supply in any direction is possible ● Cost-effective - twisterband enables rotary movement ● Space-saving - e-chain® retracts into a compact unit ● No tensile load on the cables ● Cables can be retrospectively added or changed 	<ul style="list-style-type: none"> ● Telescopic /retractable applications ● Theater, stage and lighting technology ● Space-saving alternative to zig-zag solutions 	≤ 45.93 (14)	≈ 4.92 (1.5)	●●●	9.7
e-spool compact - Space-saving, spring-driven						
	<ul style="list-style-type: none"> ● Compact, space-saving cable reel without slip ring ● Different media (power, air data and fluids) can be routed together in one system ● Energy supply in all directions ● Space-saving ● Very lightweight design (SP1.240 series made from aluminum) ● Extension lengths up to 6.56 and 13.12 ft. (2 and 4m) ● Cables can be retrospectively added or changed 	<ul style="list-style-type: none"> ● Small Circular movements ● Retractable applications - linear or rotary 	≤ 13.12 (4)	≈ 4.92 (1.5)	●●●	9.15
e-spool for manual operation - Reliable and space-saving						
	<ul style="list-style-type: none"> ● For applications where only one cable or hose is pulled out manually ● Compact, space-saving cable reel without slip ring ● Integrated ratchet to lock/release the retraction ● Also suitable for media or air hoses ● Handle with mounting option and strain relief 	<ul style="list-style-type: none"> ● Robot teach pendants ● Workstations ● Assembly lines 	≤ 16.41 (5)	≈ 4.92 (1.5)	●●●	9.19
e-spool power - Motor driven for long extension lengths						
 <div data-bbox="74 1598 180 1709" style="background-color: orange; color: white; padding: 2px; border-radius: 50%; display: inline-block;"> igus® project Product upon request </div>	<ul style="list-style-type: none"> ● Travel distances up to 114.8 ft. (35m) ● Solid tubular steel construction ● Flexible filling with electrical and fiber optic cables, and pneumatic hoses ● Future-proof, additions and upgrades possible ● No tensile load on the cables 	<ul style="list-style-type: none"> ● Theater, stage and lighting technology ● Indoor cranes ● Cranes 	≤ 114.84 (35)	≈ 4.92 (1.5)	●●●	9.23

Special solutions for vertical motion

Description	Suitable industries and applications	travel max ft. (m)  ≤m	Travel speed max ft. (m) 	Price index ●●●	Page
-------------	--------------------------------------	---	---	--------------------	------

liftband - Cable guidance up to 42.6 ft. (13 m) height with limited installation space

Vertical guidance

 <ul style="list-style-type: none"> ● For high vertical applications that need a compact solution ● Modular, silent, space-saving; vertical guidance for energy, data and media ● Maximum extension length 42.65 ft. (13m) ● Available in 2 sizes ● Alternative to zig-zag solution, but lighter and requires less installation space ● Vertical applications implemented with ease 		<ul style="list-style-type: none"> ● Theater and stage technology ● Indoor cranes ● Mobile telescoping antennas 	42.65 (13)	3.28 (1)	●●●	9.26
---	--	--	------------	----------	-----	------

guidelok slimline P/P.S - Safe vertical guidance

Vertical guidance

 <ul style="list-style-type: none"> ● Up to 22.9 ft/s (7 m/s) and 32.8 ft/s (10 m/s²) ● Up to 80% less trough required, saving costs and weight ● For hanging systems up to 164 ft. (50 m) ● No swinging of the e-chain®, high reliability due to the lock mechanism and guiding rails ● Faster and easier installation ● Reduced noise ● Easy access for servicing ● Low weight due to plastic construction ● Energy and data and all kinds of media are safely 		<ul style="list-style-type: none"> ● Storage and retrieval units for high-bay warehouses ● Lifts ● Elevators ● Construction and crane lifts ● Hoists ● Automatic miniload warehouses 	164 (50)	13.12 (4)	●●●	9.32
---	--	--	----------	-----------	-----	------

Special solutions for horizontal motion

Description	Suitable industries and applications	travel max ft. (m)  ≤m	Travel speed max ft. (m) 	Price index ●●●	Page
-------------	--------------------------------------	--	---	--------------------	------

guidelok horizontal - upper run guide, unsupported in chip areas

Upper run guide



- Unsupported travels up to 164 ft. (50 m) are possible
- Chips cannot get stuck between the upper and lower run
- Modular system with few parts (also possible without lateral trough)
- Enormous increase of unsupported lengths for e-chains®
- Lower push/pull forces (smaller e-chains®, unsupported and rollers = energy efficient)
- Lower cost than most steel chains or gliding systems
- Open guide trough design, chips can fall through

- Machine tools
- Heavy chip environments
- Wherever a gliding application is not recommended

42.65 (13) 3.28 (1) ●●● 9.38

basic flizz® - cost-effective, enclosed solution for long travels

Enclosed trough



- Low maintenance system for travels up to 328 ft. (100m)
- Protection against weather and dirt exposure
- Cost-effective and fully enclosed complete system
- Standardized and modular design
- Easy installation using a bracket with different mounting options
- Cable lengths up to 50% shorter than festoons, low profile installation
- Cables are guided with a defined bend radius so tensile forces are absorbed by the e-chain®
- Cables cannot tangle or get damaged, no slip ring contact, cables or hoses can be easily retrofitted
- Reduce power costs - directly driven by the scraper, no additional drives needed
- Optionally available moving end arm (e.g. as mechanical connection for scraper trolley)
- Available in 2 sizes, each also available in HD version for even higher push/pull forces

- Wastewater and sewage treatment plants
- Longitudinal scrapers
- Sand traps
- Grease traps
- Electroplating facilities
- Cranes
- Plant construction
- River locks

164 (50) 32.81 (10) ●●● 9.42

micro flizz® - unsupported, small e-chains® in aluminum profiles

e-chains® in aluminum profiles



- e-chain® is guided in special slots, no gliding
- Control option via stationary switch cabinet
- Accelerations up to (50m/s²), speeds up to (6 m/s) and data rates up to 10Gbit/s
- Fast assembly due to preconfigured modular system
- Less space required
- Also available as pre-assembled system
- Smooth running due to ball bearings in the guide carriages
- Also available with an ESD chain material version (upon request)
- 3 sizes available

- Storage and retrieval units for high-bay warehouses
- Indoor cranes
- Industrial gates
- Workplace equipment
- Wastewater and sewage treatment plants
- Camera systems
- Sliding doors
- Operator panels
- Measuring systems
- Studio equipment
- Material handling

246 (75) 19.69 (6) ●●● 9.46

e-chains® for long travels - E4/4HD, P4, Rol e-chain®

- Legend**
- Standard
 - Suitable to only a limited extent
 - ▲ Optional
 - Especially suitable
 - * In preparation / on request

Series	Inner height <i>hi</i> in. (mm) ∅ cable max. in.	Inner width <i>Bi</i> in. (mm) from - to	Outer height <i>ha</i> in. (mm)	Outer width <i>Ba</i> in. (mm) from - to	Bending radii <i>R</i> in. (mm) from - to	Pitch in. (mm)	Unsupported fill weight max lbs/ft (kg/m)	Unsupported length max ft. (m)	Long travel max ft. (m)	Opening design	Interior separation possibilities...			ESD/ATEX	Cleanroom	UL-V2	Low noise	Price index	Page

E4/4HD - Heavy Duty - For extremely high additional fill weights on long travels

e-chains®, Heavy-Duty, crossbars every link - extra robust version

	4040HD	2.20 (56)	∅ 1.97	1.97-23.62 (50-600)	3.31 (84)	4.09-25.75 (104-654)	5.31-11.81 (135-300)	3.58 (91)	10.75 (16)	-	> 1,148 (350)		●	●	●	○	○	▲	-	●●●	9.87
	5050HD	3.15 (80)	∅ 2.91	1.97-23.62 (50-600)	4.25 (108)	4.33-25.98 (110-660)	7.87-19.69 (200-500)	3.58 (91)	40.32 (60)	-	> 1,641 (500)		●	●	●	○	○	▲	-	●●●	9.99

e-chains®, Heavy-Duty, fully enclosed-protection against chips, dust and dirt - extra robust version

	8840HD	2.20 (56)	∅ 1.97	2.95-18.19 (75-462)	3.31 (84)	5.08-20.31 (129-516)	5.91-11.81 (150-300)	3.58 (91)	10.75 (16)	-	> 1,148 (350)		●	●	●	○	○	▲	-	●●●	9.87
	9850HD	3.15 (80)	∅ 2.91	2.95-18.19 (75-462)	4.25 (108)	5.31-20.55 (135-522)	7.87-19.69 (200-500)	3.58 (91)	40.32 (60)	-	> 1,641 (500)		●	●	●	○	○	▲	-	●●●	9.99

P4 profile Rol e-chain® - 57% less energy consumption

P4 profile Rol e-chain®, crossbars every link

	P4-32	1.26 (32)	∅ 1.10	3.94-7.87 (100-200)	2.13 (54)	5.20-9.13 (132-232)	5.91-9.84 (150-250)	2.20 (56)	4.03 (6)	-	> 1,641 (500)		●	●	●	○	▲	▲	-	●●●	9.117
	P4-42	1.65 (42)	∅ 1.50	3.94-7.87 (100-200)	2.52 (64)	6.06-10.00 (154-254)	3.94-13.78 (100-350)	2.64 (67)	4.70 (7)	-	> 1,969 (600)		●	●	●	○	▲	▲	-	●●●	9.121
	P4-56	2.20 (56)	∅ 1.97	7.36-15.75 (187-400)	3.31 (84)	10.12-18.50 (257-470)	9.84-13.78 (250-350)	3.58 (91)	8.74 (13)	-	> 2,625 (800)		●	●	●	○	▲	▲	-	●●●	9.125
	P4-80	3.15 (80)	∅ 2.83	7.36-15.75 (187-400)	4.25 (108)	10.35-18.74 (263-476)	9.84-13.78 (250-350)	3.94 (100)	20.16 (30)	-	> 2,625 (800)		●	●	●	○	▲	▲	-	●●●	9.129

Rol e-chain® - Long travels up to 2,624 ft. (800 m), rolling instead of gliding

e-chains®, crossbars every link

	2828R	1.26 (32)	∅ 1.10	1.97-15.75 (50-400)	2.13 (54)	2.91-16.69 (74-424)	4.92-11.81 (125-300**)	2.20 (56)	4.03 (6)	-	> 820 (250)		●	●	●	○	○	▲	-	●●●	9.139
	3838R	1.65 (42)	∅ 1.50	1.97-15.75 (50-400)	2.52 (64)	3.03-16.81 (77-427)	5.91-13.78 (150-350**)	2.64 (67)	4.70 (7)	-	> 1,082 (330)		●	●	●	○	○	▲	-	●●●	9.141
	4040R	2.20 (56)	∅ 1.97	1.97-23.62 (50-600)	3.31 (84)	3.39-25.04 (86-636)	7.87-15.75 (200-400**)	3.58 (91)	8.74 (13)	-	> 1,641 (500)		●	●	●	○	○	▲	-	●●●	9.143
	5050R	3.15 (80)	∅ 2.83	1.97-23.62 (50-600)	4.25 (108)	3.94-25.59 (100-650)	9.84-19.69 (250-500**)	3.94 (100)	10.75 (16)	-	> 1,969 (600)		●	●	●	○	○	▲	-	●●●	9.147

e-tubes, fully enclosed - protection against chips, dust and dirt

	7728R	1.26 (32)	∅ 1.10	1.97-11.81 (50-300)	2.13 (54)	2.91-12.76 (74-324)	5.91-11.81 (150-300)	2.20 (56)	4.03 (6)	-	> 820 (250)		●	●	●	○	○	▲	-	●●●	9.139
	7838R	1.65 (42)	∅ 1.50	1.97-11.81 (50-300)	2.52 (64)	3.03-16.81 (77-427)	7.87-13.78 (200-350)	2.64 (67)	4.70 (7)	-	> 1,082 (330)		●	●	●	○	○	▲	-	●●●	9.141
	8840R	2.20 (56)	∅ 1.97	2.95-18.19 (75-462)	3.31 (84)	4.37-19.65 (111-499)	11.81-15.75 (300-400)	3.58 (91)	8.74 (13)	-	> 1,641 (500)		●	●	●	○	○	▲	-	●●●	9.143
	9850R	3.15 (80)	∅ 2.83	2.95-18.19 (75-462)	4.25 (108)	4.92-20.20 (125-513)	11.81-19.69 (300-500)	3.94 (100)	10.75 (16)	-	> 1,969 (600)		●	●	●	○	○	▲	-	●●●	9.147

Rol e-chain® RHD Heavy-Duty - Particularly high additional loads

e-chains®, crossbars every link

	4040RHD	2.20 (56)	∅ 1.97	1.97-23.62 (50-600)	3.31 (84)	4.09-25.75 (104-654)	11.81-15.75 (300-400)	3.58 (91)	10.75 (16)	-	> 1,969 (600)		●	●	●	○	○	▲	-	●●●	9.145
	5050RHD	3.15 (80)	∅ 2.83	1.97-23.62 (50-600)	4.25 (108)	4.33-25.98 (110-660)	9.84-19.69 (250-500)	3.94 (100)	20.16 (30)	-	> 2,625 (800)		●	●	●	○	○	▲	-	●●●	9.149

e-chains® for long travels - autoglide

- Legend**
- Standard
 - Suitable to only a limited extent
 - ▲ Optional
 - Especially suitable
 - * In preparation / on request

Series	Inner height <i>hi</i> in. (mm) ø cable max. in.	Inner width <i>Bi</i> in. (mm) from - to	Outer height <i>ha</i> in. (mm)	Outer width <i>Ba</i> in. (mm) from - to	Bending radii <i>R</i> in. (mm) from - to	Pitch in. (mm)	Unsupported fill weight max lbs/ft (kg/m)	Unsupported length max ft. (m)	Long travel max ft. (m)	Opening design	Interior separation possibilities...			ESD/ATEX	Cleanroom	UL-V2	Low noise	Price index	Page
											Separators	Full-width shelves	Shelves						

autoglide - save on long travels with self-guiding e-chains®

Version 01 - for E4-1, self-guiding e-chains®



E4-32AG	1.26 (32)	ø 1.10	4.41-10.31 (112-262)	2.12 (54)	5.35-11.26 (136-286)	3.94-11.81 (100-300)	2.20 (56)	3.36-4.70 (5.0-7.0**)	-	196.9 (60)		●	●	●	○	○	▲	-	●●●	9.155
E4-42AG	1.65 (42)	ø 1.50	4.41-10.31 (112-262)	2.52 (64)	5.47-11.38 (139-289)	4.92-13.78 (125-350)	2.64 (67)	2.69-6.45 (4.0-9.6**)	-	229.7 (70)		●	●	●	○	○	▲	-	●●●	9.157
E4-56AG	2.20 (56)	ø 1.97	5.91-9.84 (150-250)	3.31 (84)	7.24-11.18 (184-284)	5.91-19.69 (150-500)	3.58 (91)	4.30-8.06 (6.4-12**)	-	262.5 (80)		●	●	●	○	○	▲	-	●●●	9.159

Version 02 - for E2/000, self-guiding e-chains®



2400AG	.98 (25)	ø .91	2.24-3.03 (57-77)	1.38 (35)	2.87-3.66 (73-93)	2.95-9.84 (075-250)	1.81 (46)	1.34 (2.0)	-	131.2 (40)		●	●	●	○	○	▲	-	●●●	9.163
2600AG	1.38 (35)	ø 1.26	1.97-2.95 (50-75)	1.97 (50)	2.60-3.58 (66-91)	2.95-9.84 (075-250)	2.20 (56)	1.68 (2.5)	-	196.9 (60)		●	●	●	○	○	▲	-	●●●	9.165
3400AG	1.77 (45)	ø 1.65	2.95-3.94 (75-100)	2.52 (64)	3.74-4.72 (95-120)	3.94-11.81 (100-300)	2.64 (67)	3.36-5.38 (5.0-8.0**)	-	229.7 (70)		●	●	●	○	○	▲	-	●●●	9.167

Version 03 - for E-Z Chain, self-guiding e-chains®



EA16	1.26 (32)	ø 1.12	1.89 (48)	1.54 (39)	2.36 (60)	2.56-3.94 (065-100)	1.20 (30.5)	2.69 (4.0)	-	65.6 (20)		●	●	●	○	○	▲	-	●●●	9.171
EA25	.98 (25)	ø .89	1.97 (50)	.99 (25.2)	2.36 (60)	2.95-3.94 (075-100)	.98 (25)	2.69 (4.0)	-	65.6 (20)		●	●	●	○	○	▲	-	●●●	9.172

Version 04 - with special glide elements, self-guiding e-chains®



2400/2500.AG	.98 (25)	ø .91	2.24-4.92 (57-125)	1.38 (35)	2.87-5.55 (73-141)	2.17-9.84 (055-250)	1.81 (46)	1.08 (1.6)	-	65.6 (20)		●	●	●	○	○	▲	-	●●●	9.175
2600/2700.AG	1.38 (35)	ø 1.26	1.97-9.84 (50-250)	1.97 (50)	2.59-7.64 (66-194)	2.95-9.84 (075-250)	2.20 (56)	1.34 (2.0)	-	98.4 (30)		●	●	●	○	○	▲	-	●●●	9.177

Guide Troughs - For long travels

- Legend**
- Aluminum, seawater resistant
 - Galvanized steel
 - ▲ Galvanized steel/plastic
 - Stainless steel upon request

Series/ Product	Outer height Trough side part in. (mm)	Zipper Chains	Series E2 mini	Series E2/000 <small>*Conditionally suitable in inner radii</small>	System E2 Tubes	System E4-1	System E4/Light	System E4-1 Light	System E4/4	System E4/00	System E6 <small>please consult igus® for long travels</small>	Side part material <small>See legend</small>	Price index	Page
-----------------	--	---------------	----------------	--	-----------------	-------------	-----------------	-------------------	-------------	--------------	---	---	-------------	------

Super Aluminum Trough - Basic version, for general use

Openable from both sides along the inner radius



970-30-SL / 970-31-SL	3.03 (77)	15	10/B15	-	-	-	-	-	-	-	-	●	●●●	9.197
970-30-SL / 970-32-SL	3.03 (77)	-	-	1400*/1450*/1480*/1500	-	-	-	-	-	-	-	●	●●●	9.199
971-30-SL / 971-31-SL	3.43 (87)	-	-	2400*/2450*/2480*/2500/255	-	-	-	-	-	-	E6-29/R6-29	●	●●●	9.201
972-02-30-SL / 972-02-31-SL	4.61 (117)	-	-	-	-	E4-28/R4-28	-	-	2828/2928/R7728	220/R760	E6-35	●	●●●	9.203
972-30-SL / 972-31-SL	4.61 (117)	-	-	-	-	E4-32/H4-32/R4-32	-	E4-38L/R4-38L	2828/2928/R7728	280/290/R770	E6-40/R6-40	●	●●●	9.205
972-30-SL / 972-32-SL	4.61 (117)	-	-	2600*/2650*/2680*/2700	R58	-	-	-	-	-	-	●	●●●	9.207
973-30-SL / 973-31-SL	5.67 (144)	-	-	3400*/3450*/3480*/3500	R68	E4-42/H4-42/R4-42	-	E4-38L/R4-38L	3838/3938/R7838	380/390/R780	E6-52/R6-52	●	●●●	9.209
974-30-SL / 974-31-SL	7.24 (184)	-	-	-	-	E4-56/H4-56/R4-56	14040/14140/R18840/14240/14340	-	4040/4140/R8840	400/410/R880	E6-62	●	●●●	9.211
975-30-SL / 975-31-SL	9.29 (236)	-	-	-	-	-	15050/15150/R19850/15250/15350	-	5050/5150/R9850	-	E6-80	●	●●●	9.213

Super Aluminum Trough - Heavy-duty version, for heavy-duty use

Snap-open with film-hinge or can be opened with "E-Z" design



971-30-SL / 971-31-SL	3.43 (87)	-	-	2400*/2450*/2480*/2500/255	R48	-	-	-	-	-	E6-29/R6-29	●	●●●	9.202
972-02-30-SL / 972-02-31-SL	4.61 (117)	-	-	-	-	E4-28/R4-28	-	-	-	220/R760	E6-35	●	●●●	9.204
972-30-SL / 972-31-SL	4.61 (117)	-	-	-	-	E4-32/H4-32/R4-32	-	E4-38L/R4-38L	2828/2928/R7728	280/290/R770	E6-40/R6-40	●	●●●	9.206
972-30-SL / 972-32-SL	4.61 (117)	-	-	2600*/2650*/2680*/2700	R58	-	-	-	-	-	-	●	●●●	9.208
973-30-SL / 973-31-SL	5.67 (144)	-	-	3400*/3450*/3480*/3500	R68	E4-42/H4-42/R4-42	-	E4-38L/R4-38L	3838/3938/R7838	380/390/R780	E6-52/R6-52	●	●●●	9.210
974-30-SL / 974-31-SL	7.24 (184)	-	-	-	-	E4-56/H4-56/R4-56	14040/14140/R18840/14240/14340	-	4040/4140/R8840	400/410/R880	E6-62	●	●●●	9.212
975-30-SL / 975-31-SL	9.29 (236)	-	-	-	-	-	15050/15150/R19850/15250/15350	-	5050/5150/R9850	-	E6-80	●	●●●	9.214

Steel Trough - For harsh environments

Snap-open with film-hinge or can be opened with "E-Z" design



92-30 / 92-01	2.76 (70)	-	-	2480	-	-	-	-	-	-	E6-29/R6-29	○ ■	●●●	9.223
95-30 / 92-01	3.94 (100)	-	-	2680	R58	-	-	-	-	-	-	○ ■	●●●	9.225
96-30 / 92-01	3.94 (100)	-	-	-	-	E4-28/R4-28	-	-	-	220/R760	E6-35	○ ■	●●●	9.227
98-30 / 92-01	5.12 (130)	-	-	-	-	E4-32/H4-32/R4-32	-	-	2828/2928/R7728	280/290/R770	E6-40/R6-40	○ ■	●●●	9.229
93-30 / 93-01	5.12 (130)	-	-	3480	R68	E4-42/H4-42/R4-42	-	-	3838/3938/R7838	380/390/R780	E6-52/R6-52	○ ■	●●●	9.231
94-30 / 93-01	6.69 (170)	-	-	-	-	E4-56/H4-56/R4-56	14040/14140/R18840/14240/14340	-	4040/4140/R8840	400/410/R880	E6-62	○ ■	●●●	9.233
94-14450-30/94-14450-31	6.69 (170)	-	-	-	-	-	14550/14650/R19050	-	-	-	-	○ ■	●●●	9.235
99-30 / 93-01	6.69 (170)	-	-	-	-	E4-80	15050/15150/R19850	-	5050/5150/R9850	-	E6-80	○ ■	●●●	9.237
97-30 / 93-01	11.81 (300)	-	-	-	-	E4-112/H4-112/R4-112	1640/R1608	-	-	600/601/R608/640	-	○ ■	●●●	9.239
90-30 / 90-20	18.90 (480)	-	-	-	-	-	-	-	-	800/840	-	○ ■	●●●	9.241

Steel guide trough - One-piece, U-shaped, special solution for Series 10, B15, 15

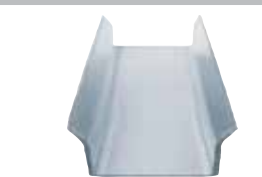

91-10 to 91-71	1.89 (48)	-	-	-	-	-	-	-	-	-	-	○ ■	●●●	9.222
----------------	-----------	---	---	---	---	---	---	---	---	---	---	-----	-----	-------

Guide Troughs - For long travels

- Legend**
- Steel, powder coated
 - Galvanized steel
 - Galvanized steel/plastic
 - Stainless steel upon request

Series/ Product	Outer height Trough side part in. (mm)	Zipper Chains	Series E2 mini	System E2/000 <small>*Conditionally suitable in inner radii</small>	System E2 tubes	System E4.1L	System E4-1	System E4/Light	System E6.1	System E6	Side part material <small>See legend</small>	Price index	Page
-----------------	--	---------------	----------------	--	-----------------	--------------	-------------	-----------------	-------------	-----------	---	-------------	------

Support tray tool kit - For support of the lower run

Support tray - Type 01



S9-010/011-05-	1.69 (43)	-	-	2500.../2700...	-	E4.38L/R4.38L	E4.21/E4.28/E4.32	14040/14240/14550/15050/15250	E61.29/E61.35/E61.40	E6.29/E6.35/E6.40	<input type="checkbox"/>	●●●	9.247
S9-010/011-07-	1.69 (43)	-	-	2500.../2700...	-	E4.38L/R4.38L	E4.21/E4.28/E4.32	14040/14240/14550/15050/15250	E61.29/E61.35/E61.40	E6.29/E6.35/E6.40	<input type="checkbox"/>	●●●	9.247
S9-010/011-10-	1.69 (43)	-	-	2500.../2700...	-	E4.38L/R4.38L	E4.21/E4.28/E4.32	14040/14240/14550/15050/15250	E61.29/E61.35/E61.40	E6.29/E6.35/E6.40	<input type="checkbox"/>	●●●	9.247
S9-010/011-15-	1.69 (43)	-	-	2700...	-	E4.38L/R4.38L	E4.28/E4.32	14040/14240/14550/15050/15250	E61.40	E6.40	<input type="checkbox"/>	●●●	9.247

Support tray - Type 02



S9-020/021-10-	2.09 (53)	-	-	3400...	-	E4.38L/R4.38L	E4.42/E4.56/E4.80	E4.38L/R4.38L	E61.52/E61.62/E61.80	E6.52/E6.62/E6.80	<input type="checkbox"/>	●●●	9.249
S9-020/021-15-	2.09 (53)	-	-	3400...	-	E4.38L/R4.38L	E4.42/E4.56/E4.80	E4.38L/R4.38L	E61.52/E61.62/E61.80	E6.52/E6.62/E6.80	<input type="checkbox"/>	●●●	9.249
S9-020/021-20-	2.09 (53)	-	-	3400...	-	E4.38L/R4.38L	E4.42/E4.56/E4.80	E4.38L/R4.38L	E61.52/E61.62/E61.80	E6.52/E6.62/E6.80	<input type="checkbox"/>	●●●	9.249
S9-020/021-25-	2.09 (53)	-	-	3400...	-	E4.38L/R4.38L	E4.42/E4.56/E4.80	E4.38L/R4.38L	E61.52/E61.62/E61.80	E6.52/E6.62/E6.80	<input type="checkbox"/>	●●●	9.249

Aluminum support tray - Flexible support of the lower run

Modular system



9AT.35.SL / 9AT.35.SLA	1.38 (35)	-	-	2500.../2700...	-	E4.38L/R4.38L	E4.42/E4.56/E4.80	E4.38L/R4.38L	E61.29/E61.35/E61.40	E6.29/E6.35/E6.40	●	●●●	9.251
------------------------	-----------	---	---	-----------------	---	---------------	-------------------	---------------	----------------------	-------------------	---	-----	-------

Guidefast - Energy supply for crane girders

Economical energy supply for crane girders and indoor cranes



GF91-30/31-025-	2.40 (61)	-	-	1500	-	-	-	-	-	-	○	●●●	9.257
GF91-30/31-050-	2.40 (61)	-	-	1500	-	-	-	-	-	-	○	●●●	9.257
GF92-30/31-03-	2.95 (75)	-	-	2500/255	R48	-	-	-	-	-	○	●●●	9.257
GF92-30/31-05-	2.95 (75)	-	-	2500/255	-	-	-	-	-	-	○	●●●	9.257
GF92-30/31-07-	2.95 (75)	-	-	2500/255	-	-	-	-	-	-	○	●●●	9.257
GF92-30/31-09-	2.95 (75)	-	-	2500/255	R58	-	-	-	-	-	○	●●●	9.257
GF92-30/31-10-	2.95 (75)	-	-	2500/255	R68	-	-	-	-	-	○	●●●	9.257
GF95-30/31-05-	4.13 (105)	-	-	2700	-	-	-	-	-	-	○	●●●	9.257
GF95-30/31-07-	4.13 (105)	-	-	2700	-	-	-	-	-	-	○	●●●	9.257
GF95-30/31-10-	4.13 (105)	-	-	2700	-	-	-	-	-	-	○	●●●	9.257

Guidelite - Realize long travels up to (150 m), quick and cost-effective

Efficient long travel set











9GL-64-50-450-XX	145	-	-	2500 / 2700 / 3500	-	-	E4.21/E4.28/E4.32	-	-	-	▲	●●●	9.261
9GL-64-50-LLL	145	-	-	1500/ 2500 / 2700 / 3500	-	-	E4.21/E4.28/E4.32	-	-	-	▲	●●●	9.261

Chainfix strain relief

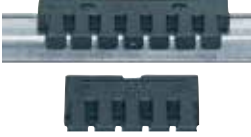
igus® strain relief

Series

Quick Selection 

		Pitch in. (mm)	For Series E-Z Chain	For Series E2/000	For Series E2 e-tubes	For Series E4-1/E4-1 Light	For Series E4/Light	For Series E6/E6-1	Page
Clamps and stainless steel clamps - for maximum pull forces									
	CFX ¹⁾ Single, double, triple standard clamps	.24-1.65 (6-42)	-	X	-	X	X	X	10.17
	CFXL ¹⁾ Single, double, triple clamps with wide base for maximum pull forces	.24-1.65 (6-42)	-	X	-	X	X	X	10.18
	Saddle elements - bottom and stacker saddles	.24-1.65 (6-42)	-	X	-	X	X	X	10.19
	Chainfix Multi-clamps ¹⁾	.24-.47 (6-12)	-	X	-	X	X	X	10.20
Tiewrap plates - for universal tiewrap, bolted or clip-on									
	Option 1A: Tiewrap plates as single part - Series 2000 + cable tiewraps	max. 1.42 (36)	-	X	-	X	X	X	10.21
	Option 1B: Tiewrap plates as single part - Series 3000 + cable tiewraps	max. 1.42 (36)	-	X	-	X	X	X	10.22
Tiewrap plates - with clip-on connection for the profile rail									
	Option 1: Tiewrap plates with clip-on connection for the profile rail		X	X	X	X	X	X	10.23
	Option 2: Integrated strain relief for E2 e-tubes - Series R		X	X	X	X	X	X	10.23
	Option 3: Tiewrap plates for fixed crossbars								10.24
	Option 4: Tiewrap plates for opening crossbars								10.25
CFU honeycomb strain relief - assembled in seconds									
	Simply insert cables and hoses into honeycomb and close - strain relief for different cables in one slot		-	X	X	X	X	X	10.26
Strain relief separators - with integrated teeth									
	Separator with integrated strain relief - Easy strain relief with tiewrap	.79-1.18 (20-30)	-	X	-	X	X	X	10.27
Strain relief element - outside of the e-chain® cross section									
	Easy strain relief for cables, even in enclosed tubes. With stepped, integrated teeth		-	X	-	X	-	-	10.31
Strain relief Nuggets - for profile rail									
	Simple and universal cable attachment, for cable diameters of .79" (20 mm) and 1.18" (30 mm)	≤ 1.18 (30)	-	X	-	X	X	X	10.32
	Clips onto standard profile rail	≤ 1.18 (30)	-	X	-	X	X	X	10.32
Strain relief connector system - modular and customizable									
	CFB plastic strain relief connector system, many cables in a very confined space	.17-.55 (4.3-14)							10.33
						Please consult igus® for individual designing			

¹⁾ Standard material zinc-coated steel. Stainless-steel (1.4301) version also available.

PMA cable protection

Product	Description	Page
---------	-------------	------

PMAFLEX Conduits - cable protection



PACOF	Flexible, medium, split	11.5
PPCOF	Very Flexible, medium, split	11.6
LN	Two-part lock nuts	11.7
LNO	One-piece split connectors	11.7
VCS	Flexible, heavy	11.8
PIS/PIH	Highly flexible, medium	11.9
CYL	Very flexible, medium	11.10

PMAFIX Connectors - safety and sealing systems



IP66 - stat., IP54 dyn.	Universal safety clip	11.11
IP68 - stat., IP67 dyn.	Oval clip	11.11
PMAFIX / PMAFLEX	Connectors	11.12
PMAFIX connectors VW	90° elbow, metric & PG	11.13
PMAFIX connectors VA	45° elbow, metric & PG	11.14
PMAFIX connectors VN	Straight, metric	11.15
PMAFIX connectors VN	Straight, PG	11.16
PMAFIX connectors VB	90° curved elbow, metric & PG	11.17
PMAFIX connectors VO	Flange 90°	11.18

PMA - Accessories



PMAFIX FH-O	One-piece system support	11.19
PMA VH	System supports	11.19
PMA GPS	One-piece system supports	11.20
PMA MN	Hexagonal lock nuts, metric & PG	11.20
PMA SGB	Tube clamps	11.21
PMA 514	Plug screws, metric & PG	11.22



7



8



9



4



5



6



1



2



3



0



.



=



Designing with igus[®]

Calculation tools, diagrams,
and application examples

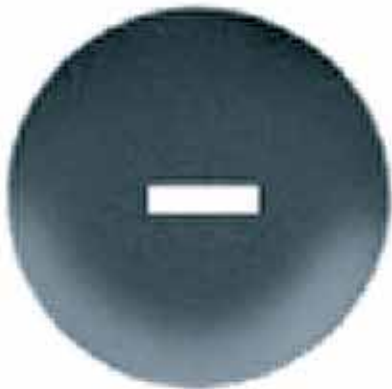

e-chain system® Design

Table of Contents

Introduction

Designing with igus®	page 1.4
Application examples.....	page 1.5
igus® terminology	page 1.7
Calculation of e-chain® lengths	page 1.8
Camber	page 1.8
System Analysis Worksheet	page 1.9

Applications

Unsupported applications

Short travels	page 1.11
Noise-optimized	page 1.14

Unsupported short travel load charts

e-chains® with fill weights up to 1.01 lbs/ft (1.5 kg/m).....	page 1.15
e-chains® with fill weights up to 6.05 lbs/ft (9.0 kg/m).....	page 1.17
e-chains® with fill weights up to 60.48 lbs/ft (90.0 kg/m).....	page 1.19

Gliding - long travel	page 1.21
Vertical hanging	page 1.25
Vertical standing.....	page 1.27
Zig-zag / liftband	page 1.28
Side-mounted	page 1.29
Rotary motion.....	page 1.31

Filling and Strain Relief

Filling

Cable and hose packages, General Rules	page 1.35
Cable and hose packages, Distribution Rules.....	page 1.36
Strain relief elements - Chainfix.....	page 1.39

Technical Data

igus® Material Data.....	page 1.41
igumid Material	page 1.42
ESD & ATEX	page 1.43
Cleanroom and ESD.....	page 1.45
Dirty Environment.....	page 1.46
Material Data / igumid Colors.....	page 1.47
Chemical Resistance.....	page 1.48
Standards and Certificates	page 1.49

igus® readychain®

readychain® - Ready-to-install pre-assembled e-chain Systems®	page 1.50
readycable - Cable assemblies	page 1.59

igus® Assembly Service

Assembly service - save time and money	page 1.61
--	-----------

e-chain system® Design

Designing with igus®

Introduction

An all-in-one energy supply system - **the-chain**

There are many options to supply your equipment and systems with energy and data. But there is hardly a solution as universal and durable as the e-chain system®. Whether you have a circular motion, a suspended or upright application, a long travel distance, high loads or large cables and hoses - igus® plastic e-chains® will help you solve nearly any type of energy supply problem, quickly, safely and with ease. Whether you wish to reliably guide many large hoses for any type of media, sensitive fiber optic signals over long distances, disruption-free data in torsional movements, or only air at high accelerations, igus® can supply you with the matching energy supply system in addition to the optimally matched chainflex® cables. By tapping into the extensive igus® construction kit, you will find the solution to match your needs and application: from the individual components to the completed installation at your facility. We have developed an online tool to help you find these resources with greater ease ► www.igus.com/the-chain. Should you have trouble finding exactly the product you need, our engineers are always at your disposal to help you design **the-chain**.

On the following pages, we offer important guidelines which are to be taken into consideration when designing safe e-chain systems®. All specifications are based on test results from the igus® laboratory and our field experience since 1971.

In addition, we strongly encourage you to take advantage of our free design service. Simply fill in the "igus® system design" fax sheet on page 1.5 of this catalog, log onto the igus web site at <http://www.igus.com> and e-mail us your technical specifications, or call us at 1-800-521-2747.

We will provide a comprehensive quote by the end of the next business day.



Laboratory tests and practical experience

Our calculations and analyses are based on the result of ongoing practical tests in our Technical Center and our experience with gliding applications. The focal points of our tests are push-pull forces, friction values and abrasion under widely varying conditions and speeds, as well as factors such as dirt, weathering or impact and bumps. We test all system components such as cables, hoses, strain relief and other accessories, in addition to the e-chains® or e-tubes and Guide Troughs.



E-Chain System® Design Application Examples



Long travels 1,447 ft. (441 m) with igus® rol e-chain® long travel applications

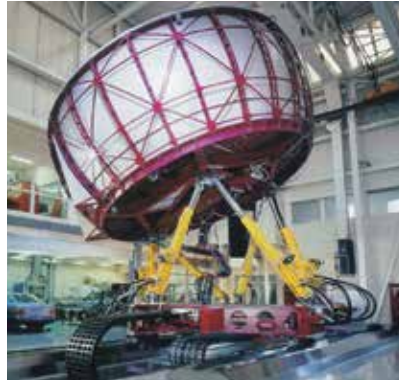

High fill weights 40.3 lbs/ft (60 kg/m) with System E4. fill weights/load diagrams



Multi-axis E-Chains® E-Z triflex® on a production line, combined movements



readychain® under water. System E4 and chainflex® CF9, readyChain®



readyChain® with combined motions on tooling machines



Series E6-52 high speed 49.2 ft/s (15 m/s) low noise operation, optimized noise level



Crash test unit: 72.2 ft/s (22 m/s) speed and 2,572 ft/s² (784 m/s²) acceleration, travel speed



Complex movements with igus® triflex® R, combined movements



Cleanroom and triflex® R technical environment



Extension links for E2 and E4 for large conduits, cable and hoses



Zig-zag movements, 118 ft. (36 m) height with E4/4



igus® System E6 - High acceleration and ESD safety, ESD & ATEX

E-Chain System® Design Application Examples



Unsupported application System E4, up to 164 ft/s (50 m/s) speed

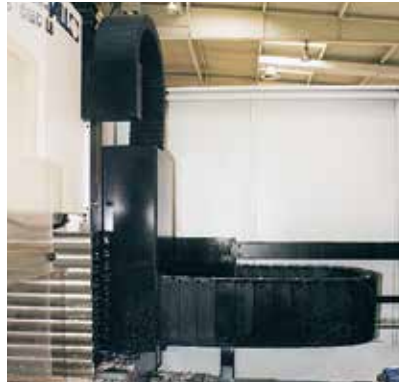

Unsupported, side-mounted E4 Series R188



Unsupported nested application System E4



Gliding application System E4, up to 1641 ft (500 m) realized



Gliding, side-mounted Series E4/4



Gliding application System E4



Vertical, standing Series E4/light, up to 19.69 ft (6 m) possible



Rotary movement System E4



e-chains® side by side as individual or "multiband" j21 Series Zipper



Vertical, hanging Series E4 up to 131 ft (40 m) possible



Spiral and rotary movement twisterchain®

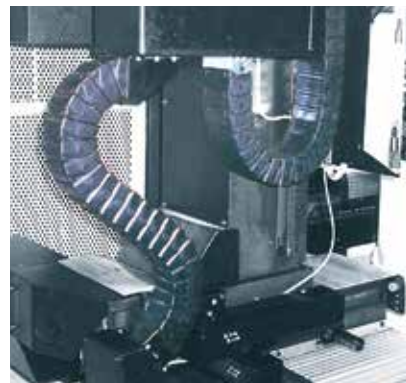

Combined movement Series triflex®

e-chain system® Design igus Terminology and Formulas

Application-Icons

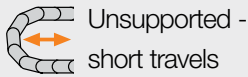

Unsupported -
short travels

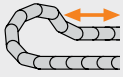

Gliding -
long travels



Vertical
hanging



Vertical
standing



Zig-zag



Side-mounted



Rotary
motion

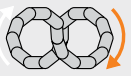

Continuously
revolving



Horizontal
and vertical



Nested



Side by
side



Combined
motions

Throughout this catalog you will find the following terms and formulas:

Short cut	Description	
α	= The rotation angle of the rotating machine element	(°)
ΔM	= Deviation of the center point	(in.)
a	= Acceleration	(ft/s ²)
AR	= Outer radius, e-chain®	(in.)
Ba	= Outer e-chain® width	(in.)
Bi	= Inner e-chain® width	(in.)
B_{Ra}	= Guide trough outer width	(in.)
B_{Ri}	= Guide trough inner width	(in.)
D	= Over length e-chain® radius in final position	(in.)
D_2	= Over length for long travels gliding	(in.)
FL_B	= Unsupported length with sag	(ft)
FL_G	= Unsupported straight length	(ft)
FL_U	= Unsupported lower run	(ft)
FZ_{max}	= Maximum additional load	(lbs/ft)
H	= Nominal clearance height	(in.)
ha	= Outer e-chain® height	(in.)
H_F	= Required clearance height	(in.)
hi	= Inner e-chain® height	(in.)
H_{Ra}	= Outer trough height	(in.)
H_{Ri}	= Inner trough height	(in.)
IR	= Inner radius, e-chain®	(in.)
K	= Add-on for bending radius (K is taken from the data tables of the individual igus® Series)	(in.)
K_2	= Further add-on if the mounting bracket location is set lower (for long travels)	(in.)
L_K	= e-chain® length	(in.)
n	= Number of links	(1)
n_{Mon}	= Number of installation sets (left/right)	(1)
n_{Ri}	= Number of trough-sets (left/right)	(1)
R	= Bending radius	(in.)
RBR	= "Reverse bending radius"	(in.)
S	= Length of travel	(in.)
$S/2$	= Half length of travel	(in.)
T	= Pitch	(in.)
v	= Speed (travel)	(ft/s)
X_1	= Inner machine-construction space (twisterchain®)	(in.)
X_2	= Outer radius chain, including clearance (twisterchain®)	(in.)

Formula	Description
$2 \times FL_B$	= Calculation of maximum travel length, unsupported with sag
$2 \times FL_G$	= Calculation of maximum travel length, unsupported straight
$B_{Ri} \geq Ba + .20 (5mm)$	= Calculation of the minimum guide trough width
$H_{Ri} \geq 2 \times ha$	= Calculation of the minimum guide trough height
$K = \pi \times R$	= Add-on for bending radius
$L_K = S/2 + \Delta M + K$	= Calculation of chain lengths for all types of applications, fixed end is outside the center of travel, except rotary movements and most long travels
$L_K = S/2 + K$	= Calculation of chain lengths for all types of applications, fixed end in the center of travel, except rotary movements and most long travels
$L_K = S/2 + K_2$	= Calculation of chain lengths for long travel gliding applications fixed end in the center of travel

e-chain® Design

Calculation of e-chain® Lengths

Camber

Calculation of e-chain® lengths

If the fixed end of the e-chain® is located in the center of the travel, the chain length " L_K " is calculated by using half the length of travel and adding the value " K " for the curve length. (You can obtain the value " K " from the tables in the catalog.) Placing the fixed end in the **center** of the travel is the most **cost-effective solution** because it requires the shortest e-chain®, cables and hoses.

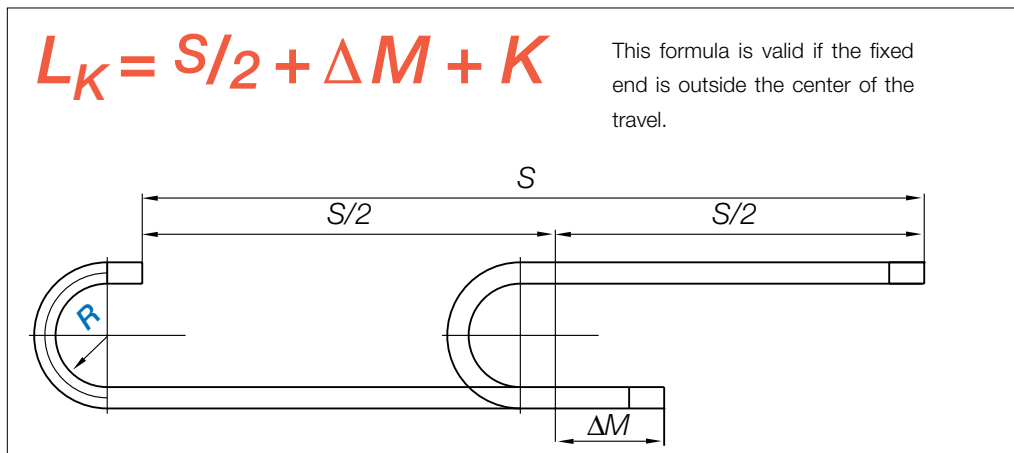
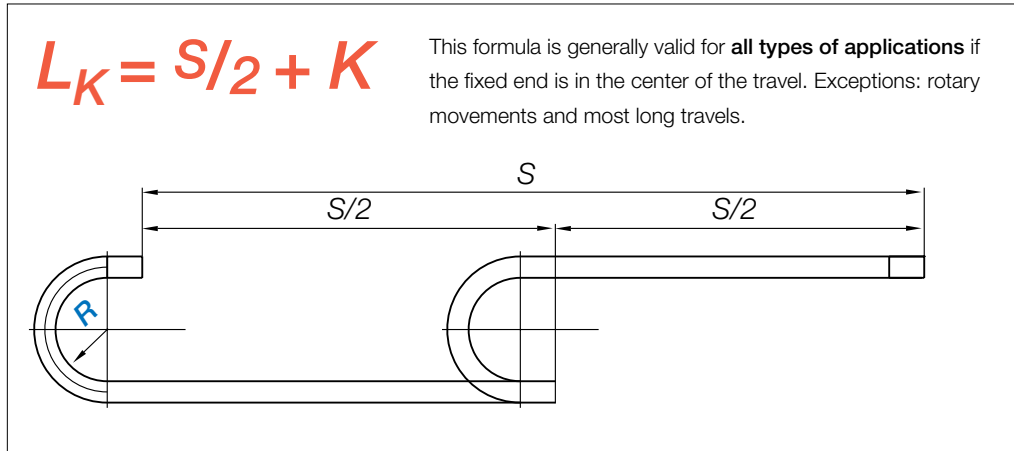

Camber

"Camber" is the curve of the upper run along its unsupported length. **All igus® e-chains are manufactured with camber, special "no camber" (NC) e-chains® are available upon request.** The camber allows for longer unsupported lengths and increases service life and operating safety. In the **Installation Dimensions** section of each respective e-chain® description, you will find the measurement H_F , which specifies the **necessary clearance height**, taking the camber into account. The camber allows for longer unsupported lengths and increases service life and operating safety. Upon request, we can deliver e-chains® without camber for restricted space applications; however, these "no camber" chains do not have the same load-bearing capacity. Please consult igus®.

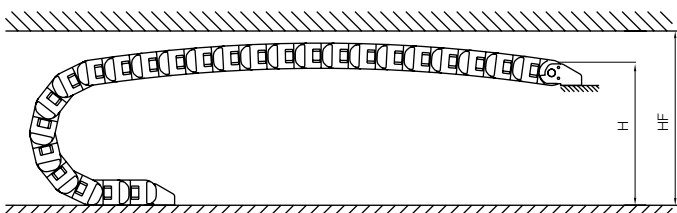

Principle of camber for igus® e-chains® H_F = required installation height



The fixed end in the center of the travel is the most favorable solution

L_K = e-chain® length
 S = Length of travel
 R = Bending radius
 ΔM = Deviation from the center point
 $K = \pi \cdot R +$ "safety buffer"
 Add-on for bending radius (K is taken from the data tables of the individual igus® series)



"No camber" - Special "NC" e-chains® with no camber are also available. Please consult igus®

H = Nominal clearance height
 H_F = Required clearance height

Necessary clearance height depends on the camber of the e-chain®. Find values for necessary clearance height " H_F " on each product page.

e-chain system® Design System Analysis Worksheet

Please supply us with as much application data as possible. Items highlighted in red must be filled out for analysis. You will receive a complete analysis with cable/hose layout proposal and quote by the end of the next business day. Please contact us if you have any questions.

Installation space

Travel: _____ in. Fixed end: center of the travel yes
or _____ inches from the center

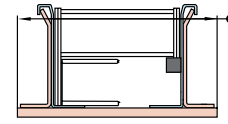
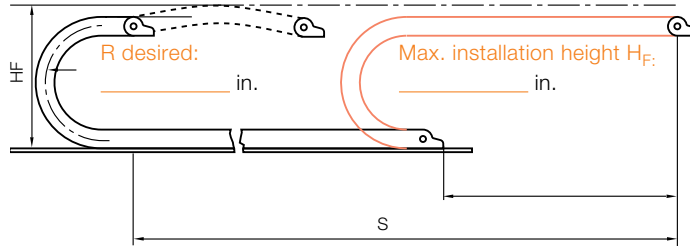

Max. width permitted
(if applicable):
_____ in.

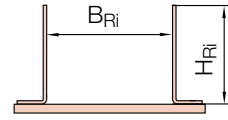

Guide trough?
 yes; if yes, which:
Dimensions:
 B_{Ri} _____ in.
Dimensions:
 H_{Ri} _____ in.

Assembly point (floor, wall, console, etc.): _____

Span (Standard = 6.5 ft.): _____ in.

Dynamics

Speed: _____ (f/s)

Acceleration: _____ (f/s²)

Cycles/Day: _____

Days/Year: _____

Outer diameter: _____

Environment

Temperature (°F): _____

Humidity (%): _____

Dust, dirt, chips: _____

Special parameters: _____

Cables/Hoses

Number	Manufacturer/Type, No.	Conductor/AWG	Outer Dia.	Weight lbs/ft.	Bending radius

Further individual components desired:

- | | | | |
|--|--------------------------|-------------------------|--------------------------|
| e-chains® / e-tubes | <input type="checkbox"/> | e-chain® | <input type="checkbox"/> |
| chainflex® cables/special conduits | <input type="checkbox"/> | e-tube | <input type="checkbox"/> |
| Guide troughs | <input type="checkbox"/> | To be opened: | |
| Strain relief | <input type="checkbox"/> | On both sides | <input type="checkbox"/> |
| Harnessing | <input type="checkbox"/> | Along the outer radius | <input type="checkbox"/> |
| On-site assembly | <input type="checkbox"/> | Along the inner radius | <input type="checkbox"/> |
| Other: _____ | | Special requests: _____ | |
| Please copy, fill in and fax. Thank you. | | igus® System guarantee? | <input type="checkbox"/> |

e-chain system® Design
Use this page for your drawings

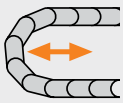

e-chain system® Design

Unsupported, Short Travel Applications



The FL_G type of installation always generates the longest service life and can be operated with the maximum values for speed and acceleration.

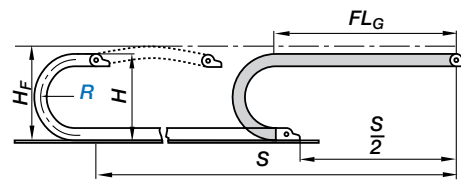

FL_G unsupported straight length

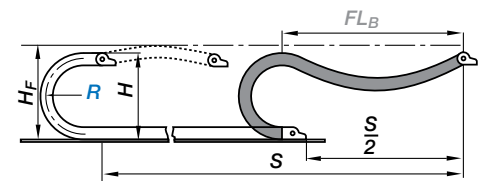

FL_B unsupported length with sag

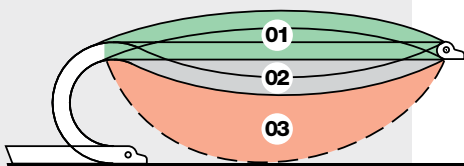

- 01) Unsupported with straight upper run FL_G

Unsupported applications

If the upper run of the e-chain® operates without touching the lower run over the entire travel, it is called and “unsupported” application. The distance between the moving end and the beginning of the radius curve of the e-chain® is called the “unsupported length”. The unsupported application is the most common. igus® e-chains® are very well suited for high dynamics and long service life. The maximum unsupported length is dependent upon the fill weight and the type of e-chain® or e-tube. As a result, we differentiate among three types of unsupported length:

01) Unsupported with “straight” upper run FL_G

The FL_G e-chain® applies when the upper run either has camber, is straight, or has a maximum of .39”-1.97” (10-50 mm) sag, depending on the size of the chain. The FL_G type of installation is always preferred. The e-chain® runs quietly and is not exposed to any additional vibration.

02) Unsupported with permitted sag FL_B

The FL_B e-chain® applies when the sag amounts to more than .39”-1.97” (10-50 mm), depending on the chain size, and less than a defined maximum sag. This maximum sag is dependent on the type of chain. The FL_B application is technically permissible in many cases. It becomes problematic if the acceleration and the travel frequency are high.

03) “Critical Sag”

If the sag is greater than permissible for FL_B , then we refer to it as “critical sag.” An installation with critical sag must be avoided or reserved for extreme circumstances. An e-chain® should never be installed with critical sag. There are applications which, after a very long period of use, reach the stage of critical sag. The e-chain®/tube should be replaced at that time.

e-chain system® Design

Unsupported, Short Travel Applications

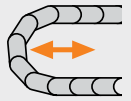

For every igus e-chain®/tube, you will find the values for “FL_G” and “FL_B” in two locations: On the following pages in this chapter as an overview and within every individual series’ chapter. These values are essential for:

- Finding a suitable e-chain® for your fill weight and travel distance
- Identifying the maximum load for the selected e-chain®



Example of unsupported with FL_B sag

What to do if the unsupported length is insufficient:

If your application, fill weight and travel fall outside the “unsupported length” parameters of the desired e-chain®, you have the following options:

- Select a more stable igus® e-chain®
- Support the chain in the unsupported area (this possibility has restrictions for acceleration, speed and noise as a consequence; three fundamental examples are detailed below; please consult igus® if you are considering this possibility we will gladly provide you with a detailed proposal)
- Use a “multiband” chain or “nest” two e-chains® inside one another (please consult igus® regarding these options)
- Design the travel distance as a “gliding application” (see page 1.x).

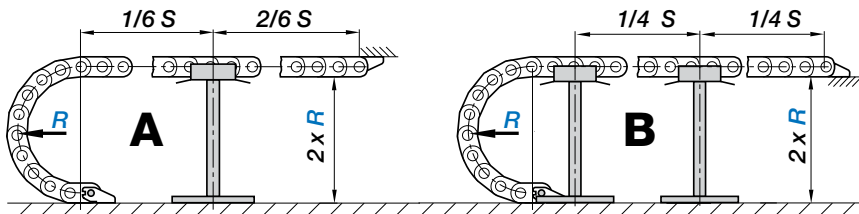

Support of the “FL_G” area.

- A) The overall “straight, unsupported travel can be increased along the upper run by a maximum of 50% of the FL_G and
- B) along the lower run by a maximum of 100%.

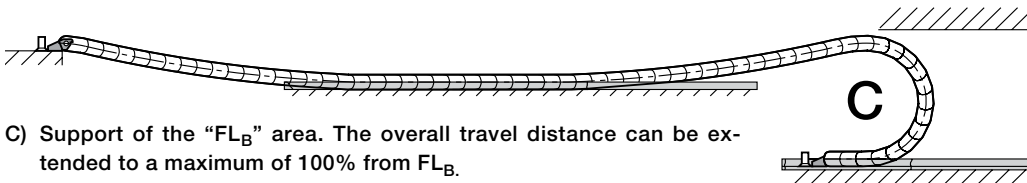

- C) Support of the “FL_B” area. The overall travel distance can be extended to a maximum of 100% from FL_B.

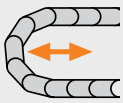

e-chain system® Design

Unsupported, Short Travel Applications



We recommend pivoting mounting brackets as standard. We also recommend locking mounting brackets as standard if high speeds > 65.6 ft/s (20 m/s) or accelerations > 65.6 ft/s² (20 m/s²)



Standard values of maximum speed and acceleration

Unsupported	FL_G	FL_B
v max ft/s (m/s)	65.6 (20)	9.84 (3)
v peak ft/s (m/s)	164 (50)	–
a max ft/s ² (m/s ²)	656 (200)	19.69 (6)
a peak ft/s ² (m/s ²)	2572 (784)	–

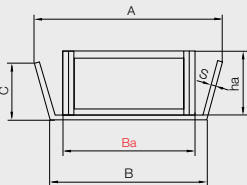

- Ba = chain outer width
- A = B + .39" (10)
- B = ba + .20" (5)
- C = ha/.08" (2)
- S = .06" - .12" (1.5 - 3)

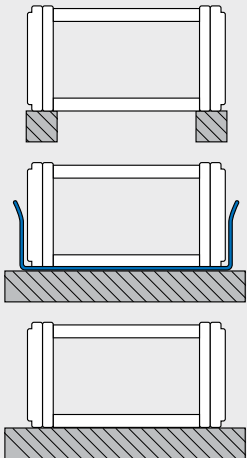

Different surfaces and guide troughs are possible

Speed and acceleration, service life

For unsupported applications, the acceleration (a), is the critical parameter. High acceleration can cause the e-chain® to vibrate and reduce its service life. This is a particular danger if the e-chain® already has a sag greater than the FL_G value. Maximum values for acceleration speed and service life are achieved only with e-chains® incorporating the FL_G (unsupported, straight) design. FL_G designed igus e-chain systems® can sustain very high loads. To date, a peak acceleration of 2,572 ft/s² (784 m/s²) has been achieved during continuous use. Through ongoing testing in the igus® laboratory and from practical experience, standard values for service life have been formulated (see graphs). Our tests confirm that these standard values apply to all igus e-chains® and e-tubes. It is crucial to determine whether the application will be designed as unsupported, straight FL_G or unsupported, with sag FL_B .

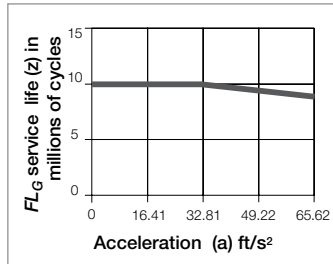

Standard values on service life for "FL_G" dependent on acceleration

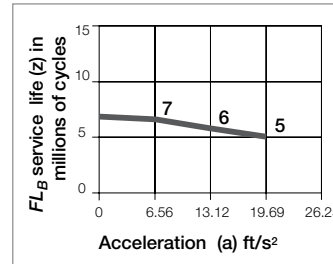

Standard values of service life for "FL_B" dependent on acceleration

Load-bearing surfaces

Unsupported e-chains® normally require some type of surface on which the lower portion of the chain runs. As the drawings on the left demonstrate, a wide range of configurations are available. Many material options are feasible: Metals, polymers, stone, wood, concrete, glass, etc. **We also have solutions to minimize the noise generated by the carrier's lower portion. Please consult igus®.** When selecting the running surface, be sure dirt and debris cannot collect in the e-chain® path.

Mounting Brackets

We recommend pivoting mounting brackets as standard for unsupported applications. Pivoting mounting brackets compensate for the camber, can be installed more easily and decrease the load on the first e-chain® link in operation. **Exception:** If the acceleration is greater than 65.6 ft/s² (20 m/s²) or if the height is limited to the H_f measurement, locking mounting brackets keep the e-chain under the H_f measurement.

Horizontal Inverted

e-chains® without support along the lower run have restricted use. An e-chain® is said to be "horizontal inverted" when the stationary end is positioned on the top and the moving end is positioned on the bottom. Care must be taken to assure the maximum unsupported inverted span (FL_u) is not exceeded. A support plate behind the moving end bracket may be necessary to prevent cantilevered loading and potential wear or breakage. If the lower run of the e-chain® cannot be supported over the whole length of travel, please contact igus® with your application information and we will be happy to specify a chain for you.



System E4 partially unsupported - please consult igus regarding this type of configuration.

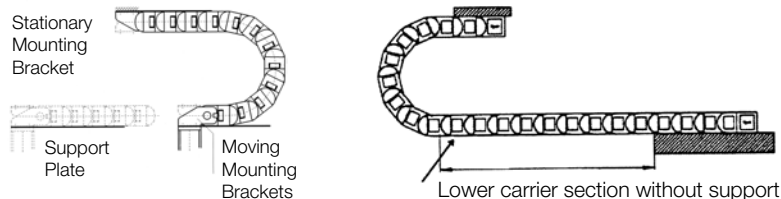

e-chain system® Design Unsupported, Noise-Optimized

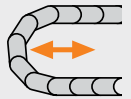

Unsupported, noise optimized

The igus® program offers you optimal noise-reduction e-chains®. The table below briefly illustrates the differences in noise levels among various e-chains®. In addition to the e-chain®, the running surface, the dynamics and the cable and hose package all play a role in overall noise generation. Have our specialists design the quietest e-chain system® for your application.

System T3 ≤ 33 dB(A)

Optimal smoothness of motion was the prime development goal, as well as making it an economic solution. The igus® T3 e-chain® is very flexible and runs -due to the special geometry- very smooth. A measurement indicates a value of ≤ 33 dB(A) at 1 m/s and with an unsupported length with series **T3.29.050.038.0**, and all this with a sound pressure level generated by external noise.

System E3 ≤ 38 dB(A)

Long-term tests in the igus® acoustic laboratory showed reductions of 19-20 db(A) compared with standard e-chains®, measured at a speed of 1.8 m/s and an acceleration of 3 m/s². Figure determined in the igus® laboratory in accordance with DIN 45635, taking into consideration background noises, for the series **E3.22.060.044.0**.

System E6 ≤ 46 dB(A)

A measurement conducted by the Rhineland Technical Inspection Authority (TÜV Rheinland) in May 2002 indicates a value of ≤ 46 dB(A) at 6.56 ft/s (2 m/s) and with an unsupported length of 4.92 ft (1.5 m) with **Series E6-52-10-100-0**, and all this with at least 10 dB(A) sound pressure level generated by external noise. The System E6 runs very smooth due to the short link pitch.

System E4 ≤ 46 dB(A)

A measurement by the Rhineland Technical Inspection Authority (TÜV Rheinland) for **System E4/101, Series 220-100-200-0** indicates a value of 46 dB(A) at 4.92 ft/s (1.5 m/s) with an unsupported length.

igus® Series	System	Average of the corrected sound pressure levels	Test method (unsupported)
E61-29	E6-1	= 32 dB(A)	3.28 ft/sec (1.0 m/s)
T3-29	T3	= 33 dB(A)	3.28 ft/sec (1.0 m/s)
E3-22	E3	= 38 dB(A)	5.91 ft/sec (1.8 m/s)
E6-52	E6	= 46 dB(A)	6.56 ft/sec (2.0 m/s)
ES4-42	E4-1	= 46 dB(A)	3.28 ft/sec (1.0 m/s)
E4-42	E4-1	= 50 dB(A)	3.28 ft/sec (1.0 m/s)
255	E2 Medium	= 53 dB(A)	4.92 ft/sec (1.5 m/s)
Competitors Product		Average sound levels	Test method (unsupported)
Chain 1 Third party product		= 77 dB(A)	6.56 ft/sec (2.0 m/s)
Chain 2 Third party product		= 68 dB(A)	6.56 ft/sec (2.0 m/s)
Chain 3 Third party product		= 73 dB(A)	6.56 ft/sec (2.0 m/s)

Source: TÜV Rheinland, except series E3-22 - source: igus® laboratory



A reduction of 3 dB(A) sounds like a 50% reduction in the noise level to the human ear

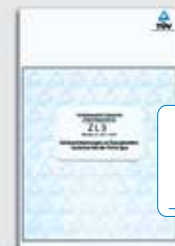

We have received an official certificate from the Rhineland Technical Inspection Authority (TÜV Rhineland Berlin Brandenburg). A copy is available upon request.

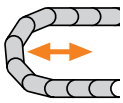

e-chain system® Design

Unsupported, Straight FL_G

Fill weights up to 1.01 lbs/ft (1.5 kg/m)

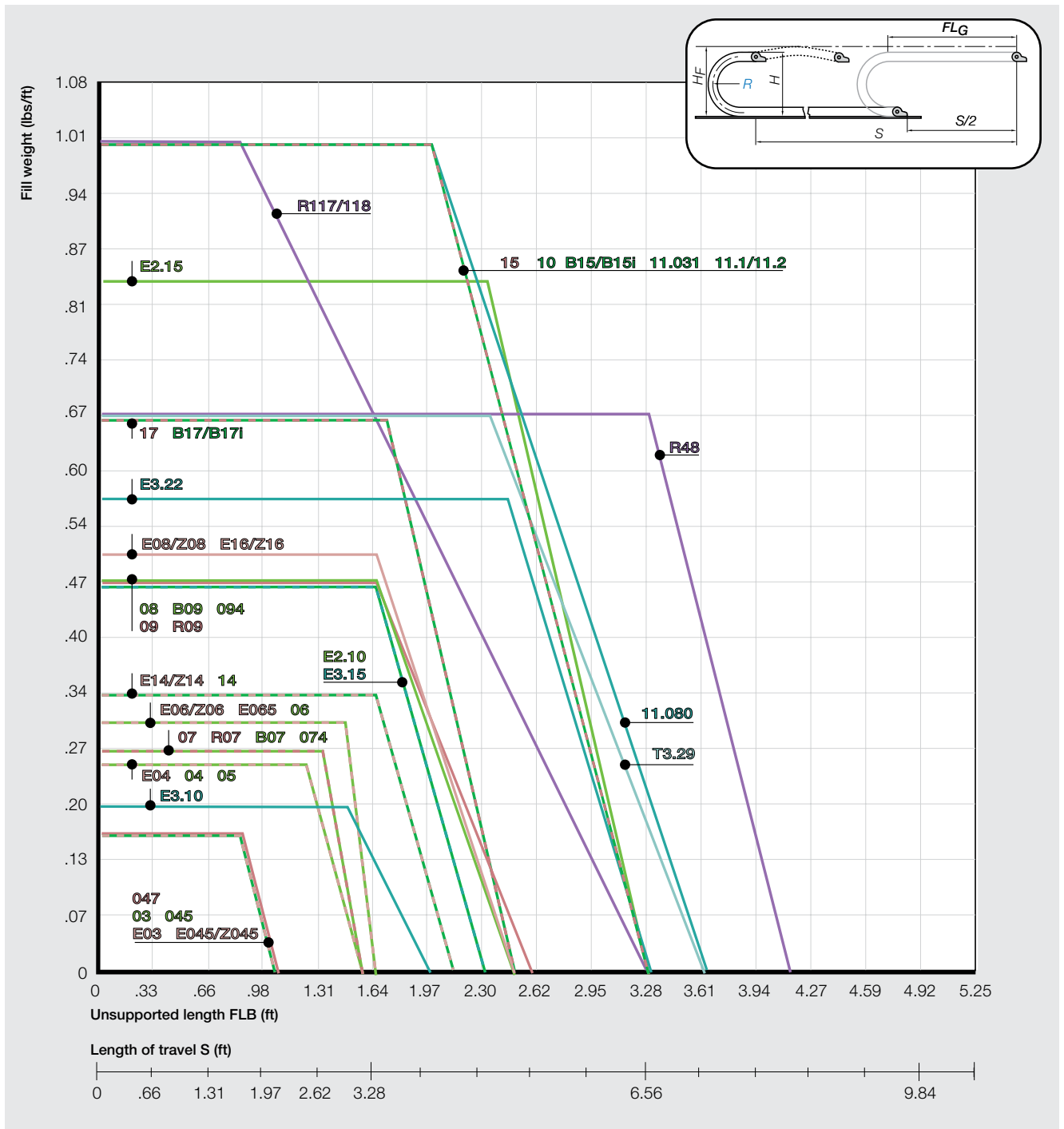

i Important information

- Fill weight - Weight of all cables and hoses, including contents (for media hoses) within the e-chain®, typically given (lbs/ft)
- FL_G - unsupported e-chain® with straight upper run
- FL_B - unsupported e-chain® with permitted sag
- To the right of the FL_B graph of the diagram, the application is shown in "critical sag", **which must be avoided!**

These values are essential for:

- Finding a suitable e-chain® for your fill weight and travel distance
- Identifying the max. load for the selected e-chain®.

If you cannot meet your application demands using these parameters, keep in mind these specifications are conservative maximum values. In individual cases, they can be exceeded by up to 30%. Special solutions are also possible. Please consult igus®, we will be happy to assist you with your application.

e-chain system® Design
Unsupported, Sag FL_B
Fill weights up to 1.01 lbs/ft (1.5 kg/m)

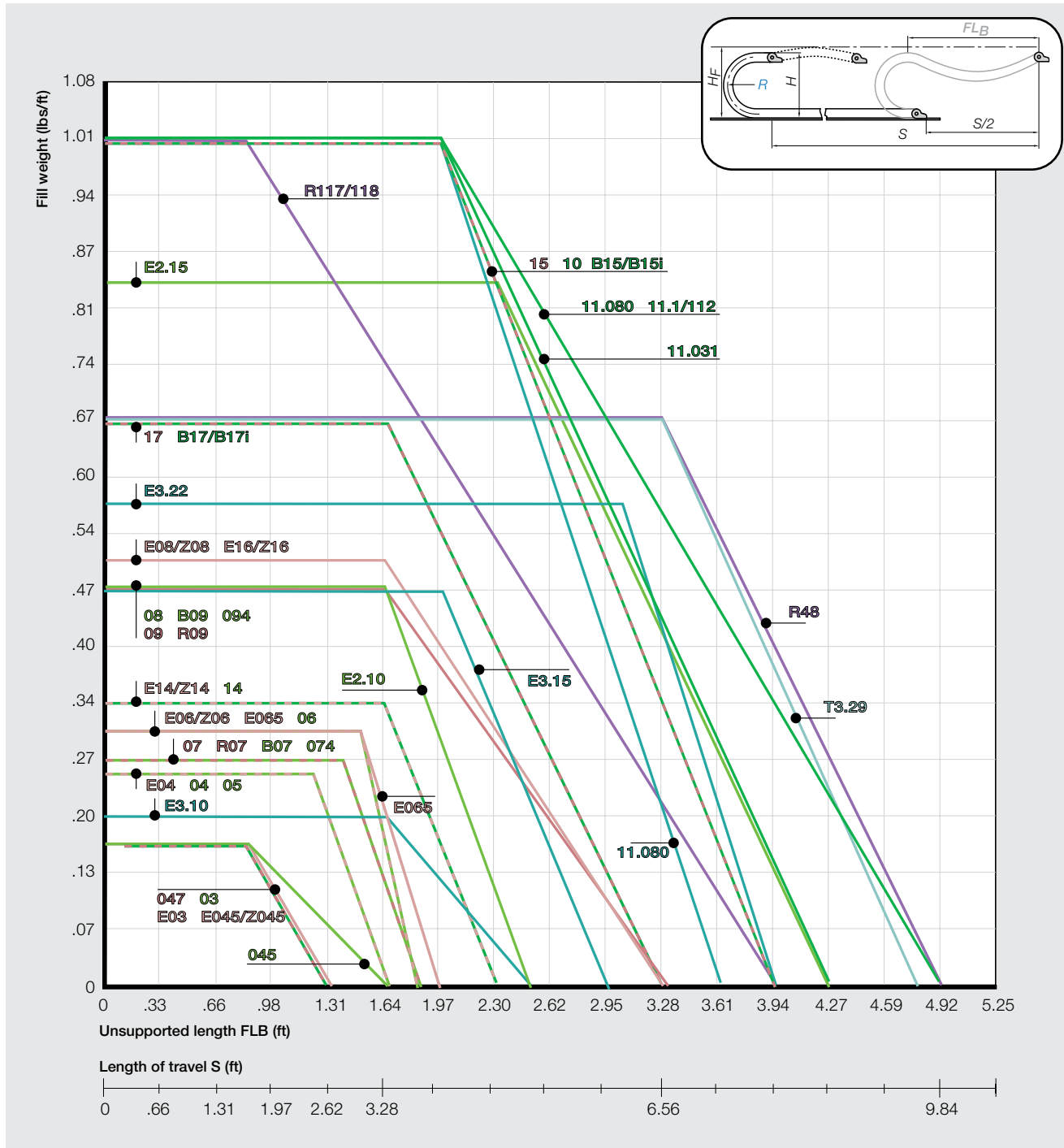
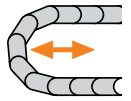

The maximum travel -always amounts to $2 \times 2 \times FL_G$ or FL_B if the fixed end is in the center of the travel. In this case, the following applies:

e-chain® length: $L_K = S/2 + K$

S = Length of travel

R = Bending radius

H = Nominal clearance height

H_F = Required clearance height

$K = \pi \cdot R +$ "safety buffer" Add-on for bending radius

(K is taken from the data tables of the individual igus® series)

Diagram Series

E1	chapter	E2R100	chapter	E3	chapter
E-Zchain®	chapter	E2R	chapter	E6-1	chapter
zipper	chapter	R2-1	chapter	E6	chapter
E2 micro	chapter	RX	chapter	e-skin®	chapter
E2 mini	chapter	E4-1L	chapter	TH3	chapter
E2-1 micro	chapter	E4-1	chapter		
E2-1	chapter	E4/light	chapter		
E2/000	chapter	T3	chapter		

You will find the diagrams for each series listed individually in the catalog

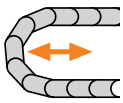

e-chain system® Design

Unsupported, Straight FL_G

Fill weights up to 6.05 lbs/ft (9.0 kg/m)

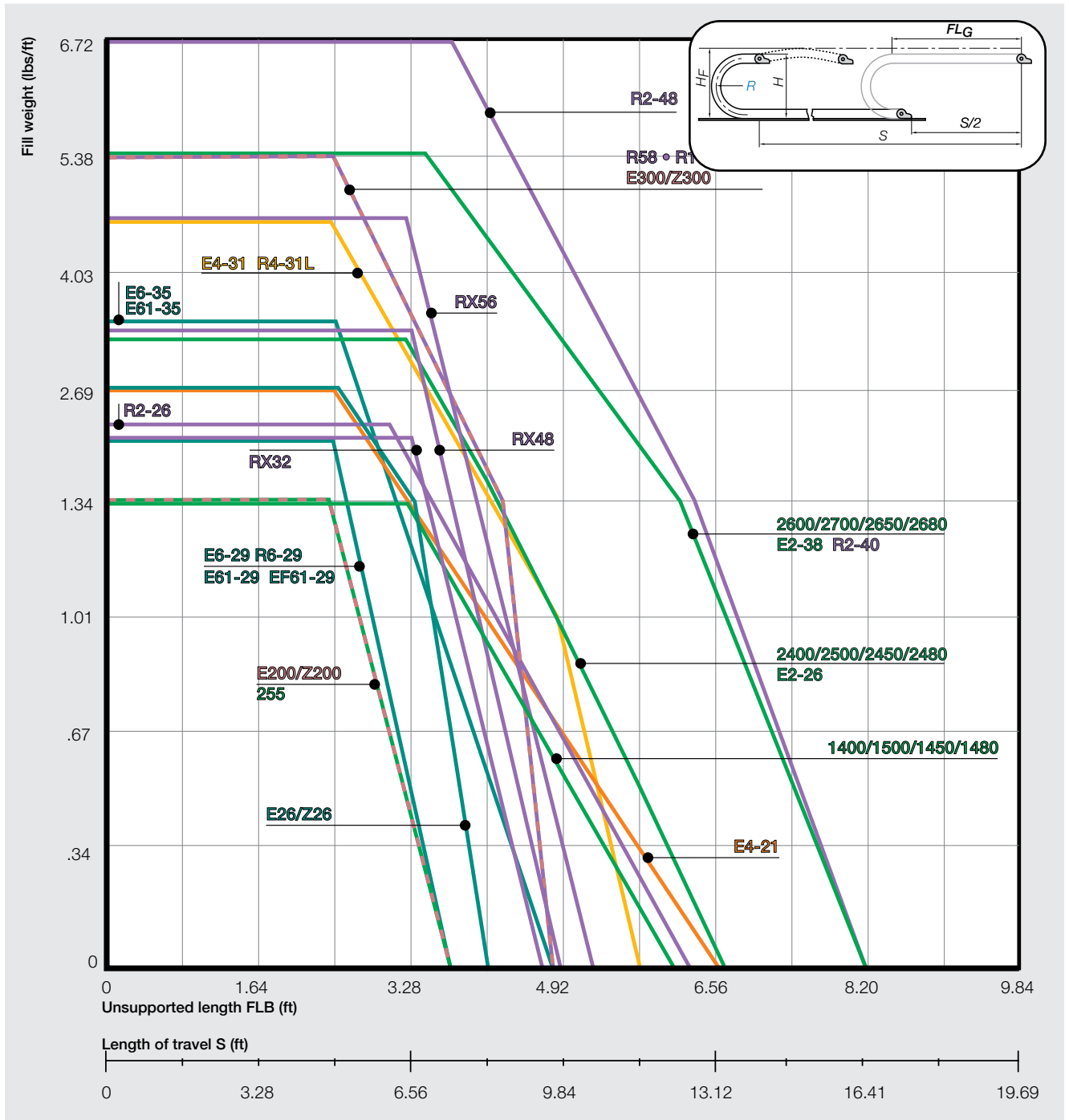

Important information

- Fill weight - Weight of all cables and hoses, including contents (for media hoses) within the e-chain®, typically given (lbs/ft)
- FL_G - unsupported e-chain® with straight upper run
- FL_B - unsupported e-chain® with permitted sag
- To the right of the FL_B graph of the diagram, the application is shown in "critical sag", **which must be avoided!**

These values are essential for:

- Finding a suitable e-chain® for your fill weight and travel distance
- Identifying the max. load for the selected e-chain®.

If you cannot meet your application demands using these parameters, keep in mind these specifications are conservative maximum values. In individual cases, they can be exceeded by up to 30%. Special solutions are also possible. Please consult igus®, we will be happy to assist you with your application.

e-chain system® Design
 Unsupported, Sag FL_B
 Fill weights up to 6.05 lbs/ft (9.0 kg/m)

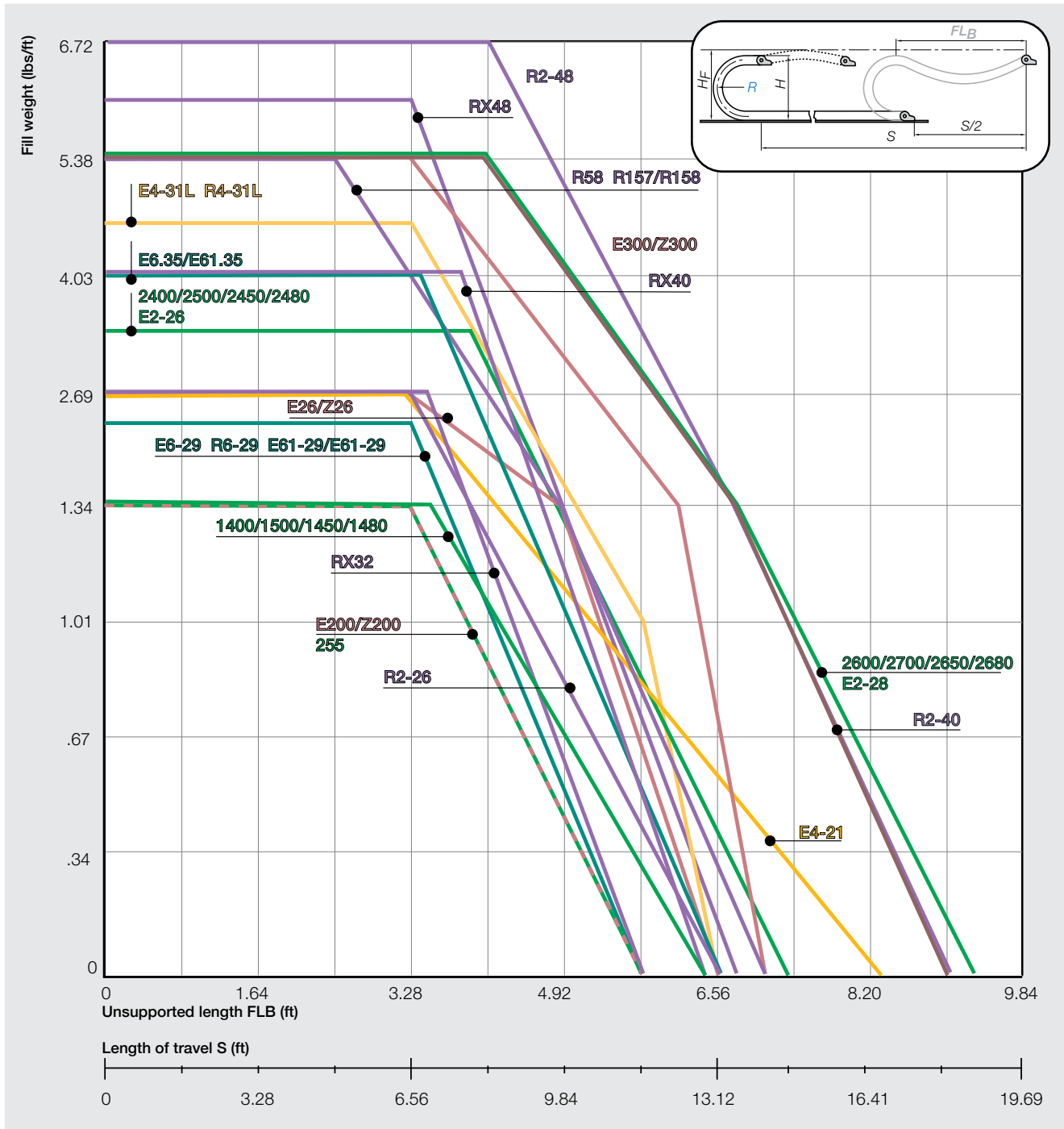
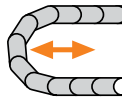

The maximum travel -always amounts to $2 \times 2 \times FL_G$ or FL_B if the fixed end is in the center of the travel. In this case, the following applies:

e-chain® length: $L_K = S/2 + K$

S = Length of travel

R = Bending radius

H = Nominal clearance height

H_F = Required clearance height

$K = \pi \cdot R +$ "safety buffer" Add-on for bending radius

(K is taken from the data tables of the individual igus® series

Diagram Series

E1	chapter	E2R100	chapter	E3	chapter
E-Zchain®	chapter	E2R	chapter	E6-1	chapter
zipper	chapter	R2-1	chapter	E6	chapter
E2 micro	chapter	RX	chapter	e-skin®	chapter
E2 mini	chapter	E4-1L	chapter	TH3	chapter
E2-1 micro	chapter	E4-1	chapter		
E2-1	chapter	E4/light	chapter		
E2/000	chapter	T3	chapter		

You will find the diagrams for each series listed individually in the catalog

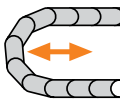

e-chain system® Design

Unsupported, Straight FL_G

Fill weights up to 60.48 lbs/ft (90.0 kg/m)

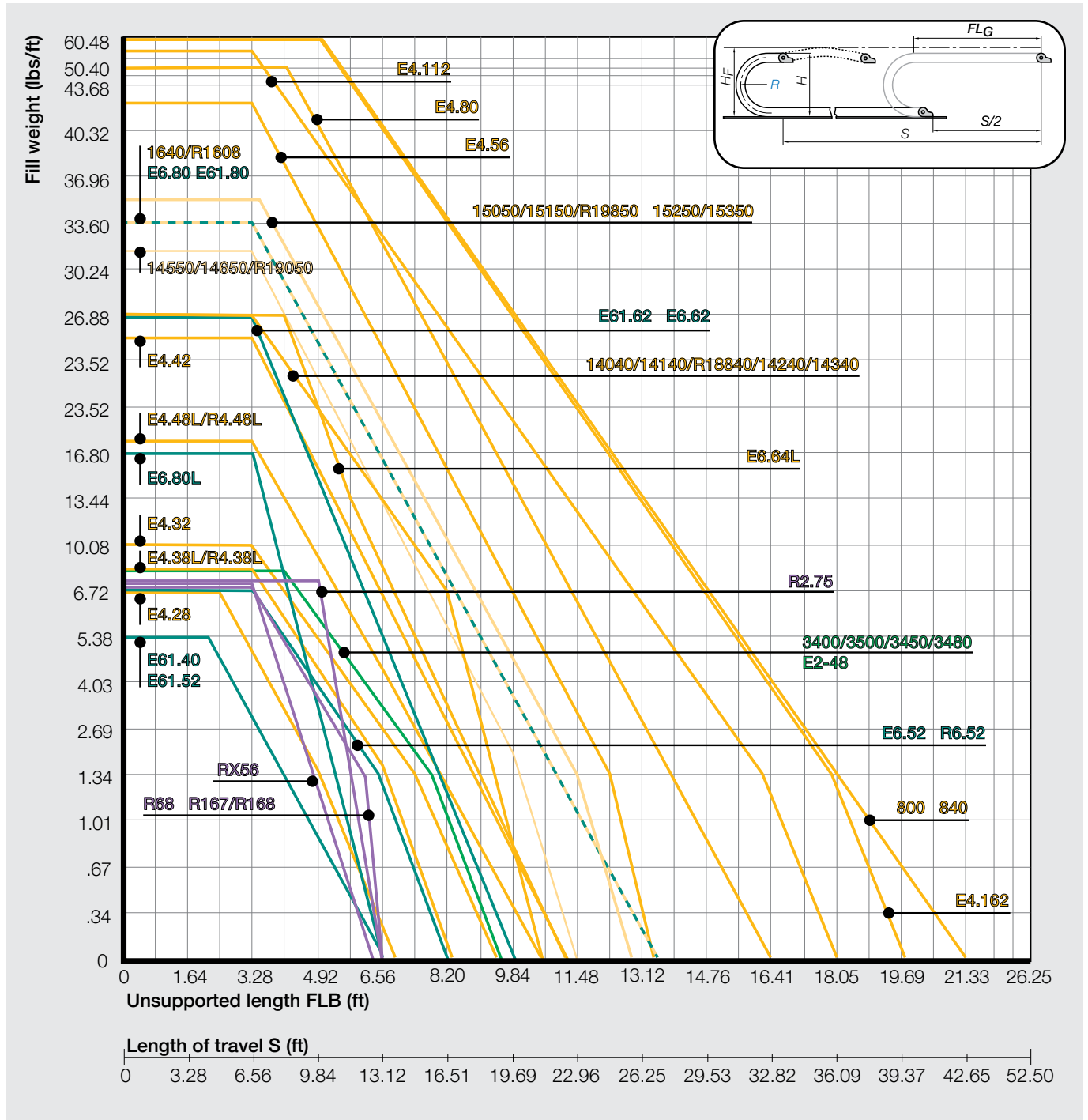

Important information

- Fill weight - Weight of all cables and hoses, including contents (for media hoses) within the e-chain®, typically given (lbs/ft)
- FL_G - unsupported e-chain® with straight upper run
- FL_B - unsupported e-chain® with permitted sag
- To the right of the FL_B graph of the diagram, the application is shown in "critical sag", **which must be avoided!**

These values are essential for:

- Finding a suitable e-chain® for your fill weight and travel distance
- Identifying the max. load for the selected e-chain®.

If you cannot meet your application demands using these parameters, keep in mind these specifications are conservative maximum values. In individual cases, they can be exceeded by up to 30%. Special solutions are also possible. Please consult igus®, we will be happy to assist you with your application.

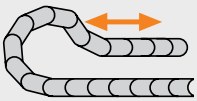

e-chain system® Design Gliding, Long Travel Applications



Recommended ratio of e-chain® inner width B_i and bending radii R (on long travels)

The minimum inner widths of an e-chain® on long travels depends on the bending radii of the e-chain®.

igus® specifies: $B_{i_{min.}} = R/4$

Please contact igus® if you have large bending radii on long travel lengths.



Example of lowered mounting height

Gliding applications principle

For long travels, the upper run of the igus® e-chains® rests on the lower run. The upper run glides partially on the lower run and partially at the same height on a glide bar. The illustrations shown below depict the gliding application principle. For lateral guidance, a guide trough is necessary. If the stationary mounting bracket and the fixed end of the cables and hoses can be placed in the center, the e-chain® length is calculated as follows: $L_K = S/2 + K_2$. Depending on the technical data and the selected e-chain®, the mounting point of the moving end of the e-chain® must be lowered on some units.

Lowered mounting height: In our system analysis for long travels, we give exact details for your specific application.

For center mounted applications, e-chain® length:

$$L_K = S/2 + K$$

- S = Length of travel
- $S/2$ = half Length of travel
- R = Bending radius
- H_{Ri} = Trough inner height
- H_F = Required clearance height
- K_2 = Add-on if the mounting bracket location is set lower (specified by igus®)
- D_2 = Over length for long travels gliding
- H_2 = Installation height with lowered mounting



Long travel with E4 rol e-chain®, guided in a igus® steel guide trough

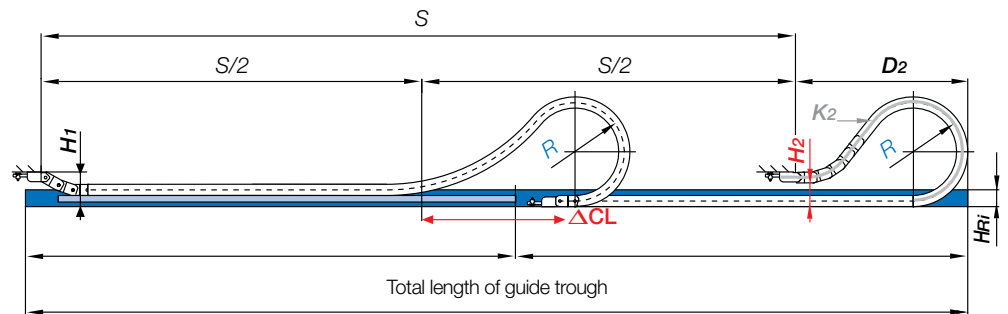

The function of an e-chain system® for gliding applications (schematically)
The fixed end of the e-chain® is located in the center of the travel distance

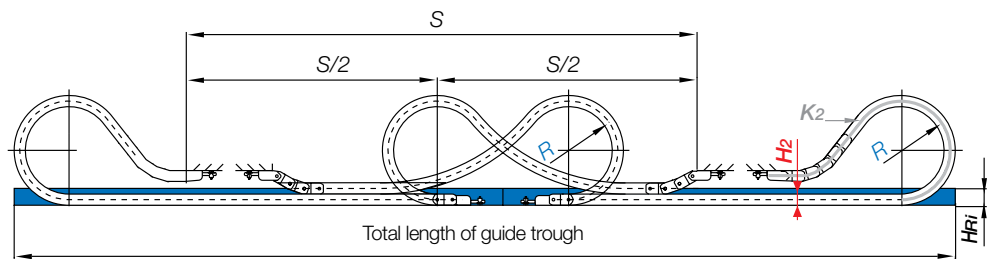

For a configuration involving two opposed e-chains®, the travel is measured as shown and selected when these factors apply: ● Restricted space ● High loads



Advantages lowered moving end:

- Space saving
- Longer travels possible
- Higher service life due to less wear

e-chain system® Design

Gliding, Long Travel Applications

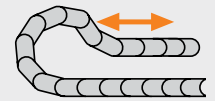

Advantages for long travel applications with igus® e-chains®

- Travels over 1312 ft (400 m)
- Gliding speeds up to 16.4 ft/s (5 m/s) (more in individual cases)
- Service life of 10 years and more with igus® e-chain systems®

Further advantages of the design are:

- Many different types of cables and hoses can operate side by side in the same system (i.e. electrical, data, fiber optic cables with hydraulic and pneumatic hoses)
- Space-saving installation
- Quiet operation
- High accelerations
- Durable in wind, weather, dirt, and chemicals
- Simple assembly of the modular system on the spot
- Rapid assembly and replacement of cables and hoses



E4 e-chain® with extension links for many cables and large hoses on a long travel application

Design assistance, free of charge

We recommend that igus® calculate every gliding application for you. We will always offer the most cost-effective solution, taking the technical requirements and operating safety into consideration. The system solution designed by us is also automatically given an igus® system guarantee.

To be able to advise you accurately, we require the following specifications:

- | | |
|---|---|
| ● Travel in (ft) or (m) | ● Type and number of cables and hoses |
| ● Travel speed (ft/min) or (ft/s) | ● Required bending radius (in.) or (mm) |
| ● Acceleration (ft/s ²) | ● Cycle frequency (n/day or n/hour) |
| ● Fill weight (lbs/ft) | ● Technical environment. |
| ● Maximum cable/hose outer diameter (in.) or (mm) | |

Please call us and within hours you will receive a detailed system proposal!

Trends in long travel applications

New developments are currently being tested:

- Travels up to 2,625 ft (800 m). We break through the 1,312 ft (400 m) barrier by means of special components. Please ask us for more specific information.
- Long travel systems “off the reel.” Complete made-to-spec e-chain systems® - with cables, connectors, strain relief - are delivered on the reel and “rolled off” into the pre-assembled guide troughs. Travel distances up to 328 ft (100 m) are delivered this way today, with longer travels possible.
- Long travel **without** guide troughs. Our AUTO-GLIDE system consists of self-guiding e-chains®. We have recently extended this technology to large e-chains® and currently offer travels up to 328 ft (100 m).
- Long travels with very small e-chains, for example, the igus “flizz” offers the guidance of a single bus cable inside a small e-chain with high acceleration on long travel applications.



Longest igus® travel of 2,018 ft (615 m) with rol-e-chain and chainflex® cables



Gliding applications = pivoting mounting brackets



Please call us and within hours you will receive a detailed system proposal

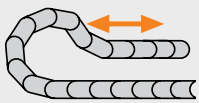

e-chain system® Design Gliding, Long Travel Applications



If the fixed point is in the center of the travel, use half of the guide trough with glide bars and the other half of the guide trough without glide bars

$$H_{Ri} \geq 2 \times h_a$$

$$B_{Ri} \geq Ba + .20'' (5 \text{ mm})$$



Ba = e-chain® outer width

Bi = e-chain® inner width

ha = e-chain® outer height

H_{Ri} = inner trough height

B_{Ri} = inner trough width

(depending on Ba)

$$H_{Ri} \geq 2 \times ha$$

$$B_{Ri} = Ba + 4$$

(Aluminum SuperTrough)

$$B_{Ri} = Ba + 5$$

(Steel guide trough)



Guide troughs

Guide troughs are used for long travels. They allow igus® e-chains® and e-tubes to continue smooth low-friction operation in these long travel situations. Diagrams are shown below. The height of the trough must be at least twice the total chain link height. The sides must provide a chamfered opening. The trough inner width is the same as the chain outer width, plus .16 (4 mm) for Aluminum SuperTrough and plus .20" (5 mm) for Steel Guide Trough. When the upper run cannot glide on the lower run, glide bars must be installed along the sides of the trough. igus® recommends the use of polymer glide bars. They are optimally matched to the chain material and achieve the lowest values for friction, noise and wear. Guide troughs with and without glide bars can be obtained for almost all igus e-chains®.

Important: When assembling the trough parts, the following points must be given particular attention:

- Properly align all trough parts upon installation
- All screw heads should be flush with the trough
- Smooth leveled transition between the end of the chain and the glide bars
- Solid connection with the glide surface

These points must be observed when using assembly-friendly igus® guide troughs

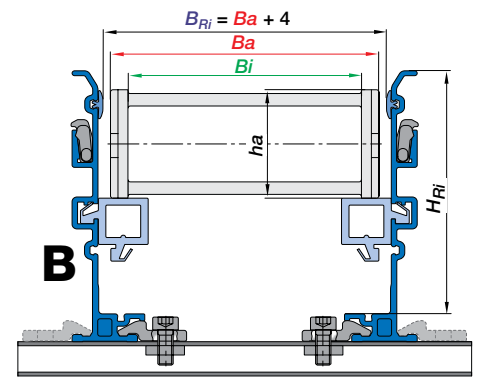
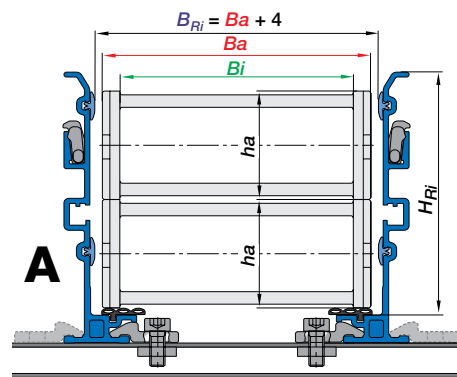

A) Aluminium SuperTrough without glide bars - upper run glides on the lower run

B) Aluminium SuperTrough with glide bars.

We recommend the use of igus® polymer glide bars. They are optimally matched to the e-chain® material and achieve the lowest values for friction, noise and wear.

Glide friction values for igus e-chains® made of igamid G and various glide bars:

igamid G	igus® Polymer Glide Bar	Galvanized Sheet Steel	Anodized Aluminum	Stainless Steel
Friction value (dynamic)	0.19	0.45	0.54	0.48

Source: igus® Laboratory

e-chain system® Design

Gliding, Long Travel Applications

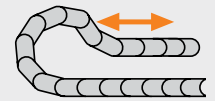

Travel speeds and accelerations

Travel speeds up to 19.7 ft/s (6 m/s) in continuous operation are possible and in use on current applications. In special cases, up to (10 m/s) are possible after consultation with igus®. For example, E4 Series e-chains® achieve **speeds of 72 ft/s (22 m/s) and accelerations of 2,572 ft/s² (784 m/s²)** in crash test units. (Only a few thousand cycles per year are required in this situation.) Acceleration plays a large role in the calculation. Differentiations must be made between normal operational acceleration and a sudden jolt of acceleration such as unexpected stops or so-called “E-stops.” Even in these situations, igus® e-chains® prove to be very durable.



Automated storage/retrieval system with System E2 and chainflex® cables - travels up to 262 ft (80 m) and speed of 14.8 ft/s (4.5 m/s)

Service Life

We offer service life calculations for your application based on our extensive gliding application experience. As developers of plastic bearings, we possess vast material behavior knowledge which we apply to the development of e-chains® as well. Units with 656 ft (200 m) travels have been in operation for 8 years with minimum maintenance. Units up to 197 ft (60 m) travels have been in operation for 15 years with almost no maintenance. (Please consult igus® for references and calculations for your project.) The maintenance-free aspects of igus® e-chain systems® over long periods and under harsh operating conditions is often the deciding factor in choosing igus. Our system guarantee (depends on the application) provides additional peace of mind.

Technical environment

Long travel applications using igus e-chains® run in water, in dirt, in the tropics, in explosion risk areas (with special design features) and many other conditions. Guide troughs can be supplied in corrosion-free materials. You will find more details in the **Technical Environment** section of this chapter.

Calculation

Comprehensive tests place us in the position of knowing our products precisely. Important factors in these tests are:

- Push-pull forces under both ambient and extreme temperatures
- Humidity and dirt
- Friction values of the polymers, alone and against various glide surfaces
- Behavior of electrical cables under push-pull conditions
- Behavior of hydraulic and media hoses under push-pull conditions
- Service life, and noise generation.

If we cannot calculate your application based on these factors, we will perform a practical test for you in our laboratory. Please consult igus®.

Technical data - gliding applications

Travel max	1,969 - 2,625 ft (600-800m)	
Travel speed max	32.8 ft/s (10 m/s)	
Travel acceleration max	164 ft/s² (50 m/s²)	depending on application, please consult igus®
Fill weight max	47.04 lbs/ft (70 kg/m)	depending on application, please consult igus®



Corrosion-free guide troughs are available in the material:

- Normally galvanized
- Stainless steel
- Seawater resistant
- Aluminum



Long travel “off the reel.” Up to 328 ft (100 m) travel pre-assembled and ready to install

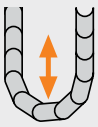

e-chain system® Design Vertical, Hanging Applications



We recommend **locking mounting brackets** for hanging applications. In restricted spaces, other solutions are possible with consultation.

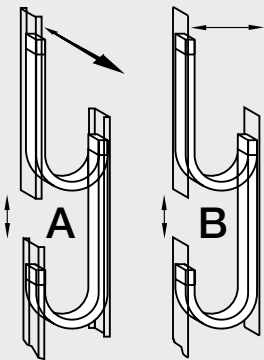
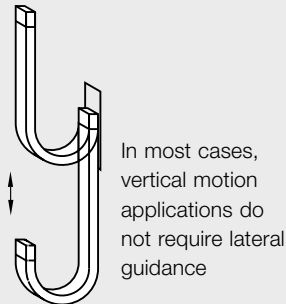

If lateral acceleration will occur in two directions, guidance is necessary

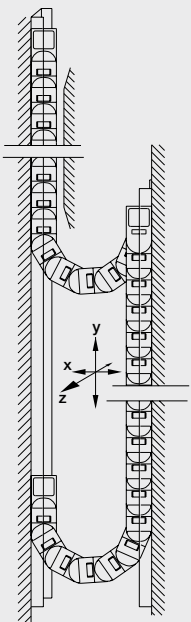

Principle of a hanging igus® e-chain® with lateral guidance, lateral accelerations in both directions are contained



Vertical, hanging applications

In accordance with the principle of hanging applications, heights of over 328 ft (100 m) are possible with igus® e-chains®. e-chains® with interior separation allow many different types of cables/hoses to operate together in the same system without becoming entangled.

Cables and hoses

Two important factors in vertical hanging applications are how the cables and/or hoses lay in the e-chain® and how they are secured at the end points: all cables and hoses must bear their own weight when hung. The e-chain® should house and protect the cables and should not absorb any further tensile forces. igus® interior separation elements should be used for distinct division of all cables and hoses. The cables and hoses must be secured carefully to both end points of the e-chain®. The strain relief must be designed so that the opposite run cannot catch. Safe strain relief and clear separation of the cables/hoses are the basic prerequisites for hanging installations. **Cables and hoses must be able to move freely and bear their own weight.**



Vertical motion without lateral acceleration

If the application involves vertical motion without lateral acceleration, the e-chain® can be installed without lateral support. If the space restrictions are severe, an igus e-chain® with no camber must be specified.

Vertical motion with lateral acceleration

In most cases where lateral acceleration occurs, lateral guidance of the e-chain® must be provided. The diagram shows an example of such guidance. Partial guidance is also an option, however, it must at least cover the area in which the e-chain® may sway. Lateral acceleration can occur in two directions. Lateral guidance must be installed accordingly. If you have a choice, the layout in **Figure A** is preferred. Additional guidance along the side of the e-chain® helps to stabilize the chain further.

Hanging assembly with one-sided U profile

e-chain system® Design Vertical, Hanging Applications guidelok Slimline P

No camber version with igus® special NC e-chains®

A normal igus® e-chain® with camber is suitable for hanging use if enough space is available. Camber contributes to the quiet operation of the e-chain®, required by the slightly bulbous appearance a little more space. If there is not enough room, a “no camber” e-chain® must be installed. This is frequently the case with storage and retrieval systems in narrow aisles. igus® offers numerous NC versions without camber. With igus® E4-1 it is easy to create a NC-version. Simply rotate the e-chain® outer link 180°. (NCST - No Camber Standard)

Order example: **E4-32-10-175-0-NCST** (No Camber)



The E4-1 system is one of igus® best solutions for hanging applications

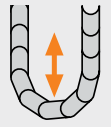

With E4-1 it's easy to create a NC-version. Simply rotate the e-chain® outer link

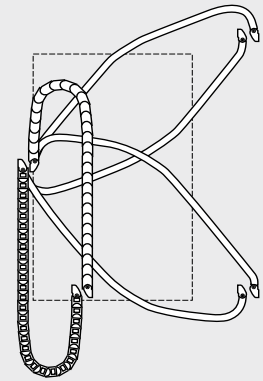
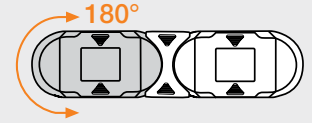

Hanging and standing igus® e-chain systems® can reach different points

Technical data - vertical, hanging

Travel height max.	328 ft (100 m)	
v max.	65.6 ft/s (20 m/s)	dependent on height and strength of the e-chain®
a max.	164 ft/s ² (50 m/s ²)	dependent on height and strength of the e-chain®

Special solution guidelok slimline P - safe and fast vertical guidance

- Up to 23 ft/s (7 m/s) and 32.8 ft/s² (10 m/s²)
- Up to 80% less trough required, saving costs and weight
- For hanging systems up to 164 ft. (50 m)
- No swinging of the e-chain®, high reliability due to the locking mechanism and guiding rails
- Faster and easier installation
- Reduced noise
- Easy access for servicing
- Energy and data and all kinds of media are safely guided



More information ► Chapter 9



igus® guidelok slimline P vertical guidance in a high-bay warehouse



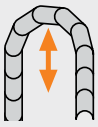

e-chain system® Design Vertical Standing Applications



We recommend locking mounting brackets for standing applications

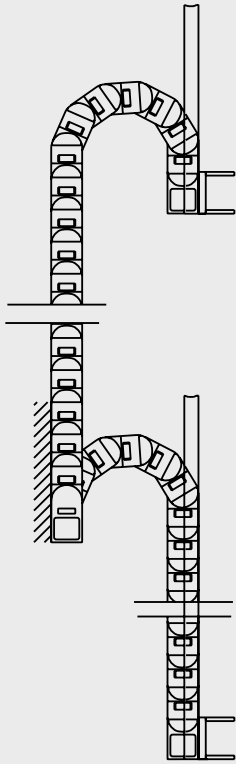

Options for a standing application with support of the first chain links: on the left, with U-shaped guidance; on the right, with the support of the first chain links.

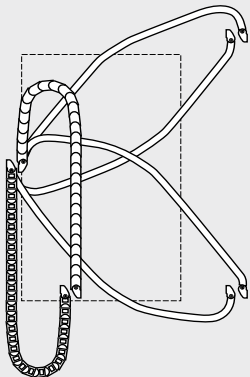

Hanging and standing igus® e-chain systems® can reach different points



Locking KMA mounting brackets can be directly attached flush to the machine



Standing application with support of the first chain links; R68 e-tube

Vertical standing applications

Standing applications are standard on many machines and plants. Cables will be guided safely in vertical strokes.

Mounting brackets

The mounting brackets must be attached so that the e-chain® cannot bow out.

The igus® program offers locking or one-sided locking mounting brackets for almost all types of e-chains®. Locking KMA mounting brackets are highly recommended because they can be attached flush to the machine.

Cables and hoses

Cables and hoses must be laid in the chain so that they can bend freely. For precise guidance of the cables and hoses, we strongly recommend igus® interior separation elements. Cables must be strain relieved at both ends

Lateral acceleration

If lateral acceleration occurs, the e-chain® should be supported along the outer radius. For higher chain heights, it is generally recommended that at least the first three links on the outer radius be supported. For maximum heights and weights, the entire distance must often be supported. Due to the wide variety of combinations involving weights, stroke heights, e-chain® types and bending radii, we strongly recommend you consult igus® for design assistance.

Combined movements

Combined vertical and horizontal movements are possible with igus e-chains® for a cost-saving solution.



For higher e-chain® stroke heights, it is generally recommended that at least the first three links along the outer radius be supported.

For maximum heights and strokes, the whole chain must often be supported.

With lateral acceleration, the e-chain® must be supported and, depending on the direction of this acceleration, be guided along the side.

Technical data - vertical, standing

Max. stroke height		
- without support	≈ 13 ft (4 m)	
- with support of the first e-chain® links	≈ 19.7 ft (6 m)	
- with full support	≈ 65.6 ft (20 m)	
v max	65.6 ft/s (20 m/s)	dependent on stroke height and weight
a max	164 ft/s ² (50 m/s ²)	dependent on stroke height and weight

e-chain system® Design

Zig-Zag - liftband

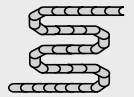

Decommissioning of a nuclear power station. Zig-zag application with igus® e-chains®

Zig-zag design

The modular design of igus® e-chains® facilitates this space-saving and unconventional solution. For modern platform technology, such as performance stages, a variety of cables/hoses which adjust the stage height must be accommodated. Lack of space almost invariably presents difficulties. The photo above shows an e-chain® in a zig-zag configuration produced by incorporating reverse bend radii or **RBR**. The unextended e-chain® is stored in a basket. When the platform is raised, the e-chain® unfolds, generating little to no noise. This construction is possible with E4-1 System as well as many other e-chain® systems. Please consult igus® for these kinds of applications.



We recommend pivoting mounting brackets for zig-zag applications

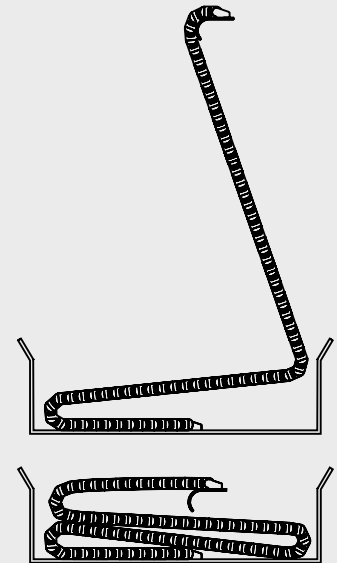

Space-saving solution - stroke heights of over 65.6 ft. (20 m) are possible

Technical data - zig-zag

Travel max.	131 ft (40 m)	
v max.	1.31 ft/s (0.4 m/s)	depending on application, please consult igus®
a max.	3.28 ft/s ² (1.0 m/s ²)	depending on application, please consult igus®

Special solution

liftband -

vertical guidance with limited space

Modular, silent, space saving - vertical guidance for energy, data and media. High vertical applications that have plenty of space horizontally but allow only for little system height can be implemented with the liftband.

- Available in 2 sizes
- Alternative to Zig-Zag solution
- Lighter and smaller installation space
- Vertical applications implemented with ease
- Maximum expansion length: 42.7 ft. (13m)



More information ► Chapter 9

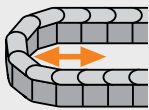

We recommend locking mounting brackets for side-mounted applications



Side-mounted e-chains® - are strongly recommended if the installation height is restricted.



E4 e-chains® assembled in an unsupported manner on the traveling column machine. The Y and Z axes have a travel of 314.9" (8,000 mm) and 68.9" (1,750 mm) at a speed of 82 ft/min (25 m/min).

e-chain system® Design Side Mounted Applications



e-chain®, side-mounted, supported
System E4

Short travels with or without support

igus® e-chains® placed on their side can be used unsupported to a limited extent. The turned "unsupported length" in this case is dependent on the following factors:

- Fill weight
- Width of the e-chain®
- Bending radius
- Parallel placement

The greater the fill weight of the e-chain®, the shorter the available unsupported length. When placed on its side, the chain width, in effect, becomes the height. As this "height" increases, the e-chain system® becomes proportionally more stable. Small bending radii provide greater stability. If further movement in a second axis is added to the parallel motion of two chains, the unsupported length is impaired. For applications with low fill weight, the standard mounting brackets are adequate. If, however, the fill weight is high and the travels are long, the e-chain® must then be supported either in whole or in part. Due to the variety of application possibilities, we strongly recommend you make use of our consulting services.

Example load diagrams for e-chains® side-mounted at 90°

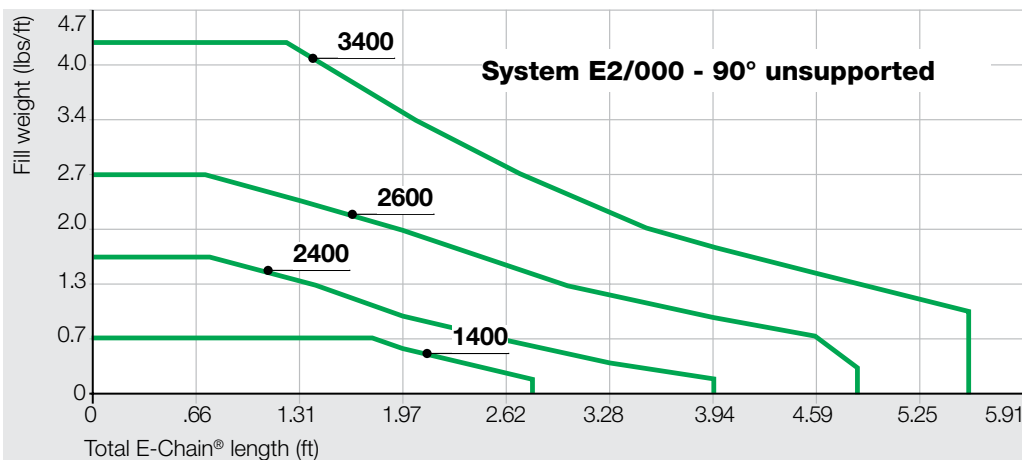
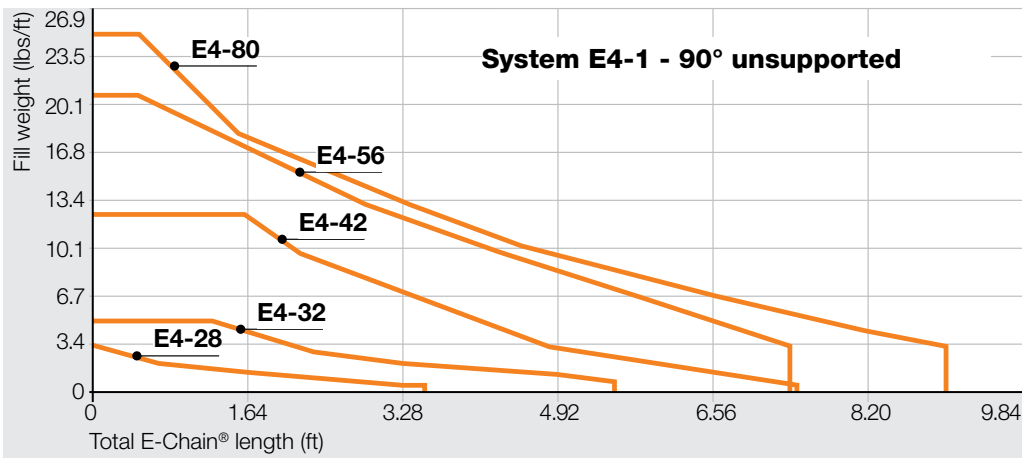

The unsupported lengths can be extended by supporting the links next to the mounting brackets. Please consult igus® for more series and details

e-chain system® Design Side Mounted Applications

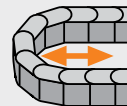

System E4 e-tube in direct chip area E4/light

Long travel, gliding

Side-mounted e-chains® can travel over 328 ft (100 m) with adequate guidance. All chain types are designed to operate gliding on their side. The corresponding glide surface is usually an igus® polymer, stainless steel or galvanized steel, depending on how high the demands on the travel speed and service life are. Roller and ball bearings or additional gliding elements are not necessary for igus® e-chains®.

Cables and hoses

Cables and hoses must be guided so that the e-chain system® can move freely at all times. The igus® modular separation options offers numerous possibilities, such as separators and spacers, to keep these cables/hoses separated and bending freely for maximum service life. igus® will gladly provide an application analysis, free of charge.

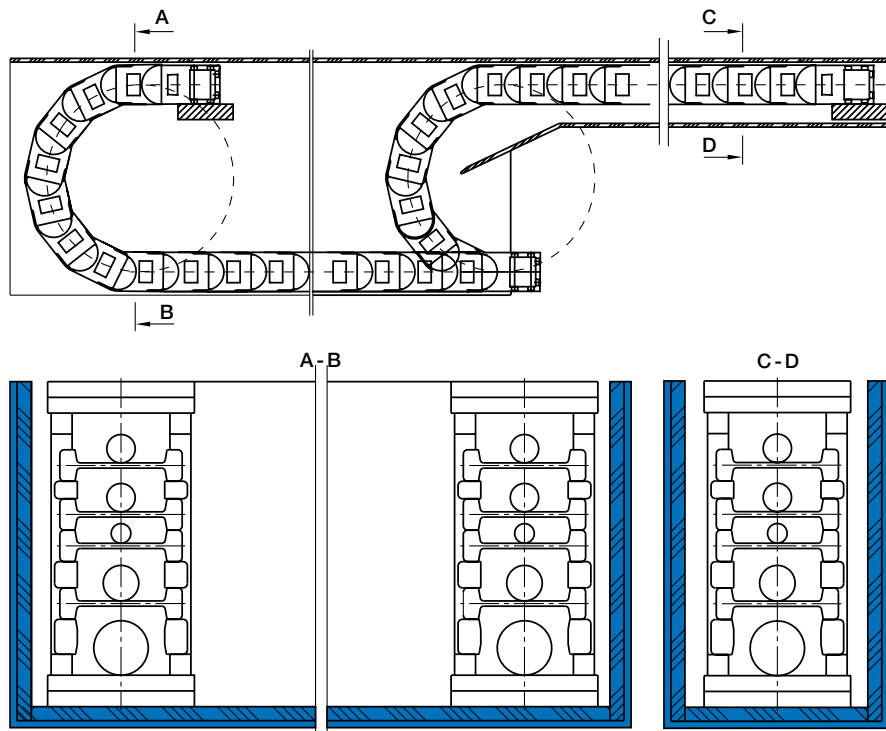

Principle of a guide trough for long travel, side-mounted



igus® - Series E4 with partial support



Unsupported - System E4



e-chain system® Design Rotary Motion - RBR - Applications



We recommend pivoting mounting brackets for most applications with rotary motions

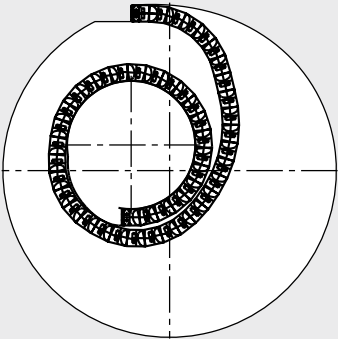
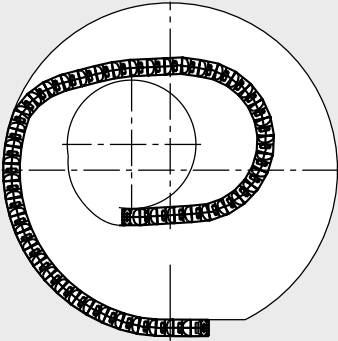
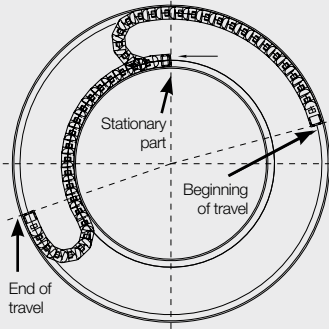

Standard E2/000 e-chain®
angle of rotation 225°



RBR-rotary movement with igus® System E4, installed on a crane



Rotary motion with a standard igus® e-chain®



Circular motion of 180° with standard e-chain® on a crane turret drive

Rotary motion with an “RBR”

RBR is “reverse bending radius” and means that the e-chain® can bend in two directions. Each igus® e-chain® can incorporate **RBR** designs, with the exception of several radii, for the e-tubes R117 to R9850 and for the Series 07, 09, 14, 15, and 17. The **RBR** does not necessarily need to be identical to the normal bending radius of an e-chain®. For example: Part No. E4-32-15-100/425-0, describes a Series E4-32 e-chain® with an inner width of 5.91 (150 mm), standard bending radius of 3.94 (100 mm) and **RBR** of 16.73 (425 mm).

Most rotary motions can be achieved with the **RBR** option. **Angles of rotation up to 540°** have been achieved. Below is an example of rotary motion using an **RBR** e-chain®. Please consult igus for your particular application.

Rotary movements require less installation height. The e-chains® glide mostly on surfaces made of polymer, stainless steel or steel and are guided through channels into a rotary movement. (See “side-mounted” for further design tips.) Bending radius, circular radii and e-chain® widths are variable with this product line.

Rotary motion with standard e-chains®

The photo to the left shows an application which was achieved using “standard” e-chains® (standard, in this case, means that the e-chain® only bends in one direction). Such solutions are possible if a **great deal of space** is available and if the angles of rotation are limited to a maximum of 450°. All igus® e-chains®, e-tubes and chainflex® cables are appropriate for this situation.

Technical data - rotary motion RBR

Max. angle of rotation	540°	more upon request
v max	6.56 ft/s (2.0 m/s)	more upon request, depending on the application
a max	65.6 ft/s ² (20 m/s ²)	more upon request, depending on the application

e-chain system® Design

Rotary Motion - RBR - Applications



System E2 medium with 360° RBR rotary motion on a robot

Product range for rotary motions with RBR

e-chains® with **RBR** are available as standard from stock for the complete Triflex® range. In addition, we supply a number of e-chains® which are molded with **RBR**. For all other types, **RBR** requires modification. We will be more than willing to offer you this option.

The e-chain® Series appearing in the table are **RBR** versions available from stock. Almost all igus® e-chains® can be delivered as a **RBR** version. Please contact us for a special inquiry.

- chainflex® cables with TPE outer jacket are specially suited for e-chains® with **RBR** option
- Please use for e-chains® with **RBR** option a strain relief only for the moving end

Table of RBR e-chains® available from stock

Part Number	Series	Part Number	Series
03-05-10/70	E2 micro	10-4-038/600	E2 mini
03-10-010/070-0	E2 micro	10-4-048/048	E2 mini
05-16-018/018	E2 micro	10-4-048/400	E2 mini
06-20-018/018	E2 micro	10-4-075/220	E2 mini
06-20-038/350	E2 micro	B15i-050-100/460	E2 mini
06-30-018/018	E2 micro	1400-050-075/075-0	E2/000
06-64-018/018	E2 micro	1400-068-038/038-0	E2/000
10-1-028/028	E2 mini	1500-038-075/450-0	E2/000
10-1-038/600	E2 mini	2400-09-055/250	E2/000
10-1-048/048	E2 mini	2700-15-150/090	E2/000
10-1-075/220	E2 mini	250-05-060/060	E2 medium
10-2-028/028	E2 mini	250-07-060/060	E2 medium
10-2-038/600	E2 mini	E/Z14-1-038/038	E-Z Chain®
10-2-048/048	E2 mini	E/Z14-2-038/038	E-Z Chain®
10-2-075/220	E2 mini	E/Z14-3-038/038	E-Z Chain®
10-3-028/028	E2 mini	E/Z14-3-075/075	E-Z Chain®
10-3-038/600	E2 mini	E/Z14-4-038/038	E-Z Chain®
10-3-048/048	E2 mini	TE14-50-028/028	SnapChain
10-3-075/220	E2 mini	TE26-120-063/063	SnapChain
10-4-028/028	E2 mini		



Many igus® e-chains® are available with **RBR** -reverse bending radius. Please see the 'Product Range' for relevant series.



Vertical rotary motion of an E2 e-chain®



The e-chain® series appearing in the table at the left are **RBR** versions available from stock. Almost all other igus® e-chains® can be special ordered as **RBR**. Please contact us for any special inquiry.



e-chain system® Design Rotary Motion - RBR - Guide Troughs



Rotary motion with **RBR**, diameter 236.2" (6,000 mm), with **RBR** the inner ring rotates



Guide troughs for rotary applications

igus® guide troughs - standard modular system RM

For rotary motions up to 540° igus® offers a modular system of guiding trough systems. Those systems are divided into an inner and an outer ring. Since one ring is moving together with the e-chain® there is no relative movement between e-chain® and trough, so the wear is reduced to an absolute minimum. Depending on the application they are made from galvanized steel or stainless steel.

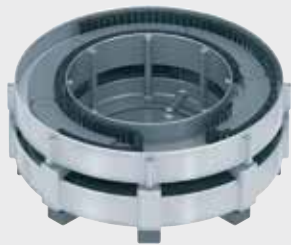

Typical application areas:
offshore, stacker/reclaimer, bucket-wheel excavators, rotary cranes, other rotating applications

Realize 900° and more with igus® Multi Rotation Modules (MRM)

igus® Multi Rotation Modules help to realize rotating movements up to 900° and more. Thanks to stackable add-on modules the angle of rotation can be extended "virtually" indefinitely. The Multi Rotation Modules are also ideally suited for rotary motions with high fill weights and limited space.

- Several individual systems are stacked on each other and form a complete system
- The maximum rotation of the individual levels can easily be added, thereby enabling rotary motions up to 900 degrees and more
- Compact design enables the operation even in tight spaces, and can be extended as needed
- High fill weights possible
- e-chains® can be assembled easily
- Peripheral speeds up to 3.28 ft/s (1 m/s)
- One layer for rotation movements up to 540°, two layers for up to 900°, higher rotation angle possible with more layers

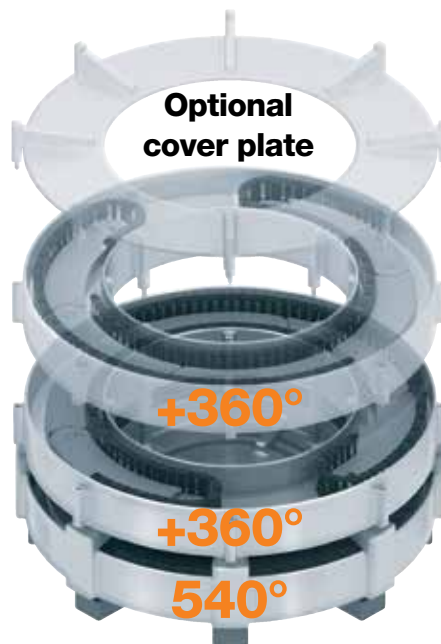

Functional principle

- As the defined rotation angle of the lower layer is reached, the next upper module is carried along automatically due to an integrated connection system
- The construction minimizes potential interference. The Multi-Rotation Module-System is ideal for rotary applications, heavy loads and for harsh environments
- Unlike other systems using sliding contacts, the e-chain® can also guide hoses for air, gas or fluids, as well as bus and fiber optic cables

e-chain system® Design

twisterchain® - twisterband - e-spool



Circular and spiral movements up to 540° - twisterchain®

- Higher loads and smoother running
- igus® 2nd generation of twisterchain® circular e-chains® significantly improved smoothness, stability and strength
- The twisterchain® has a modular construction for width, height and radius
- Stronger with intermediate link - more fill weight possible
- 25% less weight than existing twisterchain®
- Rotary speeds up to 3.28 ft/s (1 m/s) and more, rotary/spiral movements up to 540°
- Highly dynamic and smoother running (with the guide trough Type 01)

More information ► see Chapter 8



Rotary movements in small spaces - twisterband

- Compact
- Cost effective
- Low wear and low maintenance in a confined space
- Energy (in the process), data and media are kept secure
- Rotary movements up to 7000° (Installation position, vertical: up to 3000°, horizontal: 7000° and more possible)
- Rotary speeds up to 360°/s possible
- Minimum installation space, fits closely around the rotary axis
- Can be reliably used in various installation positions (horizontal or vertical)
- Compact, modular and lightweight

More information ► see Chapter 8



Special solutions for multi-axis motion

The cable reeling drum without a slip ring - igus® e-spool

- Route many different cables in very narrow spaces
- Different media and diameters possible in one drum
- No tensile load of the cables
- Energy supply in all possible directions (horizontal, vertical, diagonal)
- Space-saving, no "e-chain® junction" - e-chain® rolled into the home position, access paths remain free
- Cable diameters up to .67" (17 mm)
- Cables can be retrospectively added or changed
- Alternative to zig-zag solutions
- Maximum deployment and retract speed: 3.28 ft/s (1 m/s)

More information ► see Chapter 8

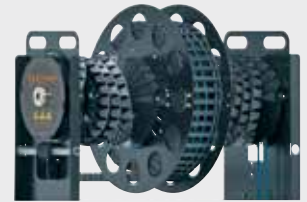

e-spool standard and HD - flexible use



e-spool compact - space saving, spring-driven



e-spool for manual operation - cost-effective



e-spool power - motor-driven for long extension lengths



igus® e-spool and zig-zag solutions in a theatre. Space-saving and maintenance-free: guide all kind of energy, data and media safely, in all directions

More Information ► www.igus.com



e-chain system® Design Cable and Hose Packages General Rules



Rules for:

- Maximum conduit diameters
- Shelving
- Bend radius



Electrical cables need at least 10% reserve space all around, hydraulic hoses require 20%

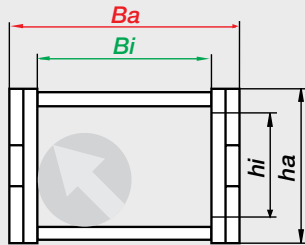

The maximum conduit diameter is specified for each series in its respective chapter



Hydraulics and electric cables are separated from one another in this example

specific requirements of each respective application. In this chapter, we give you detailed recommendations. Due to the variety of the application parameters, we strongly recommend you take advantage of our free consultation services. Simply give us a list of your cable requirements (or merely the required electrical or other services) and you will receive our recommendation by the end of the next business day.

Maximum cable and hose diameters

The maximum cable and/or hose diameter corresponds to the inner height of the selected e-chain®/e-tube, with additional minimum clearance. This minimum clearance would be, for example, 10% for electrical round cables, 20% for hydraulic hoses. An e-chain® is ideal if a minimum lateral gap to the next cable or hose has been factored in. Depending on the nature of the cables, the dynamics, and the expected service life, more clearance must be allowed. In specific cases, clearances may be altered further. Please consult igus®.



Neatly laid cables with igus® interior separation

General rules for cables and hoses in e-chains®

The key advantage of an igus® e-chain system® is the safe accommodation of various forms of data cables and energy suppliers in one system. We recommend the optimal separation layout of the cables/hoses in the carrier, but you, the customer, are still afforded the final choice. It is possible, for instance, to maintain minimum distances between bus and motor cables and mix pneumatics, electric and hydraulics in the same compartments. In addition to the quality of the cables used, the arrangement of each cable/hose within the chain and the space allowed, are important for the service life of the system. Various separation options enable the adaptation of the e-chains® to the

e-chain® Interior separation

Cables and hoses with very different diameters should be laid separately. The separation is achieved using modular separators. Cables and hoses must **under no circumstances** have the opportunity to tangle. Therefore, the clearance height of a compartment with several similar cables or hoses next to one another **must not amount to more than one and a half times the cable/hose diameter**.



The igus® modular e-chain system® solves all known requirements for interior separation

e-chain[®] Design Cable and Hose Packages Distribution Rules



Reasons for distribution rules

The cables and hoses must be laid so that they can move freely at all times and so that no tensile force is exerted at the radius of the e-chains[®]. For high-speed applications and high cycles, cables or hoses must not be laid on top of each other without horizontal separation. The standard values for this are: Travel speed over 1.64 ft/s (0.5 m/s) and cycles over 10,000 per year. igus[®] interior separation offers a safe solution for this situation.

Further guidelines for distribution

The cable or hose weight should be symmetrically distributed along the width of the e-chain[®]. Cables and hoses with different outer jacket materials must not be allowed to “stick” together. If necessary, they must be laid separately. All igus[®] chainflex[®] cables can be combined with each other and all other brands of cable or hose. The cables and hoses should always be fixed at the moving end. The fixed end should always involve strain relief. Exceptions are made only for certain hydraulic hoses with length compensation issues or other high pressure hoses. Generally, the faster and more frequently the e-chain[®] operates, the more important the exact positioning of the cables and hoses inside the chain. Due to the wide variety of the possibilities, we strongly recommend you take advantage of our free consultation services for your specific applications.

Bend radius *R*

The bend radius of our e-chain[®] depends on the thickest or stiffest cable or hose in your application. The bend radii of the e-chains[®] should be adjusted to the recommendations of the cable or hose manufacturer. The selection of a larger radius than the minimum will positively affect service life. The specification of minimum bend radii for cables and hoses refers to use at normal temperatures; other bend radii may be recommended. Please ask your cable or hose supplier for details. We recommend complete e-chain systems[®] - where bend radii for all cables and hoses, interior separation and service life are optimally matched. igus[®] chainflex[®] cables permit a small bend radius of 4 x d for one million strokes

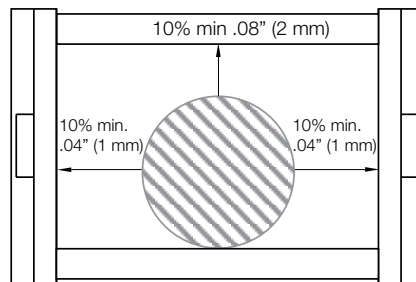
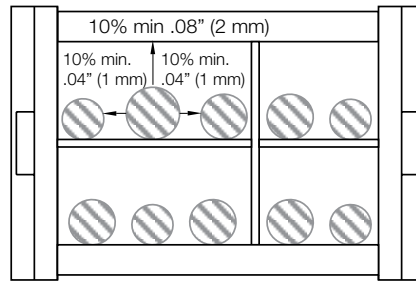
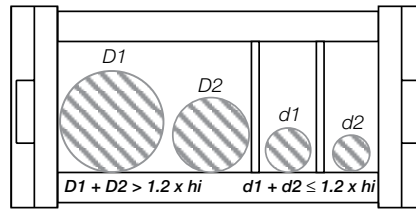

Clearance space “all-around” for round electrical cables



e-chain[®] with extension links supports a smaller e-chain[®] with electric cables

i Distribution Rules

$D1 + D2 > 1.2 \times hi$
Rule 1: If $D1 + D2 > 1.2 \times hi$ chain inner height, no separation between the two cables/hoses is necessary. Two cables or hoses should never be left unguided on top of one another or be allowed to become tangled.

$D1 + D2 \leq 1.2 \times hi$
Rule 2: If $d1 + d2 \leq 1.2 \times hi$ chain inner height, a vertical separator or a horizontal shelf must be used to reduce the inner height, thereby preventing the entanglement of $d1$ and $d2$.

Clearance space in %

Electrical round cables	10
Electrical flat cables	10
Pneumatics	5-10
Hydraulics	20
Media hoses	15-20

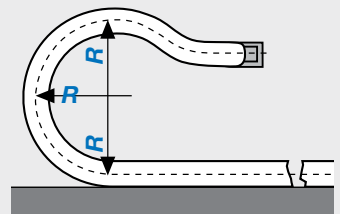

Pinciple sketch - bending radius *R*



e-chain system® Design Cable and Hose Packages Distribution Rules



Corkscrewing: an effect of improper cable and hose placement in an e-chain®

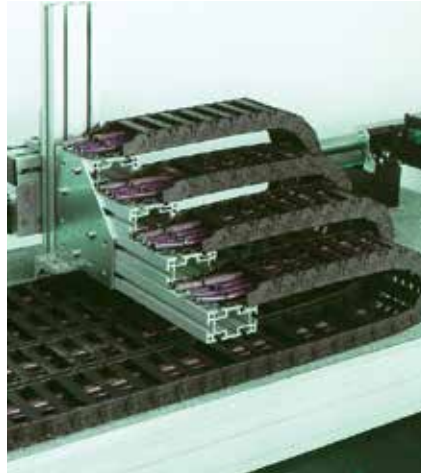

Example from igus® test laboratory: continuous development and testing of chainflex® round electrical cables

Round Electrical Cables

For electrical cables, the round cable is a safe, modular and cost-effective solution for e-chain systems®. We recommend the following criteria for selecting the proper round electrical cables:

- Small minimum bending radii and mounting heights
- Strain relief integrated directly into the mounting bracket
- Uncomplicated installation process - no hanging, laying out, etc. of cables
- Long service life at minimum bending radius
- Service life expectations for your application (short or long travel, hanging, etc.)
- Test data on service life from realistic tests
- Flexible shields for shielded cables
- Abrasion-resistant and non-adhesive outer jackets
- Large selection to avoid expensive custom designs

For bus cables and fiber optic cable, special attention must be paid to how effective transmission rates and shielding remain after millions of cycles at the minimum bending radius.

Installation and strain relief of round electrical cables

1. The cables must be laid straight, without twisting. Cables must not be uncoiled from the top of the spool. igus® chainflex® cables are immediately ready for placement directly into the e-chain®. They need not be disconnected or laid out before installation.
2. The cables must be laid so that each individual cable can move freely from side to side.
3. The cables must be able to move freely along the radius. This must be double-checked if the upper run operates at the cable's maximum bending radius.
4. The division of the carrier's interior using shelves or igus® interior separators is necessary if several cables and/or hoses with varying diameters are laid out. It is important to prevent cables and hoses from tangling.
5. For cables and hoses with different jacket materials, it is important to prevent them from "sticking" to one another. If necessary, they should be separated. igus® chainflex® cables can be combined with all others.
6. Round electrical cables must be secured with strain relief at both ends. In exceptional cases, the cables may be fixed with strain relief at the moving end of the e-chain® only. A gap of 10-30 x cable diameter between the end of the bending segment and the fixed point is recommended for most cables. chainflex® cables can, on the other hand, be secured directly to the mounting bracket with strain relief (this has been confirmed with testing).

We will be pleased to provide you with recommendations for complete e-chain systems® - where bending radii for all cables and hoses, interior separation and service life are optimally matched

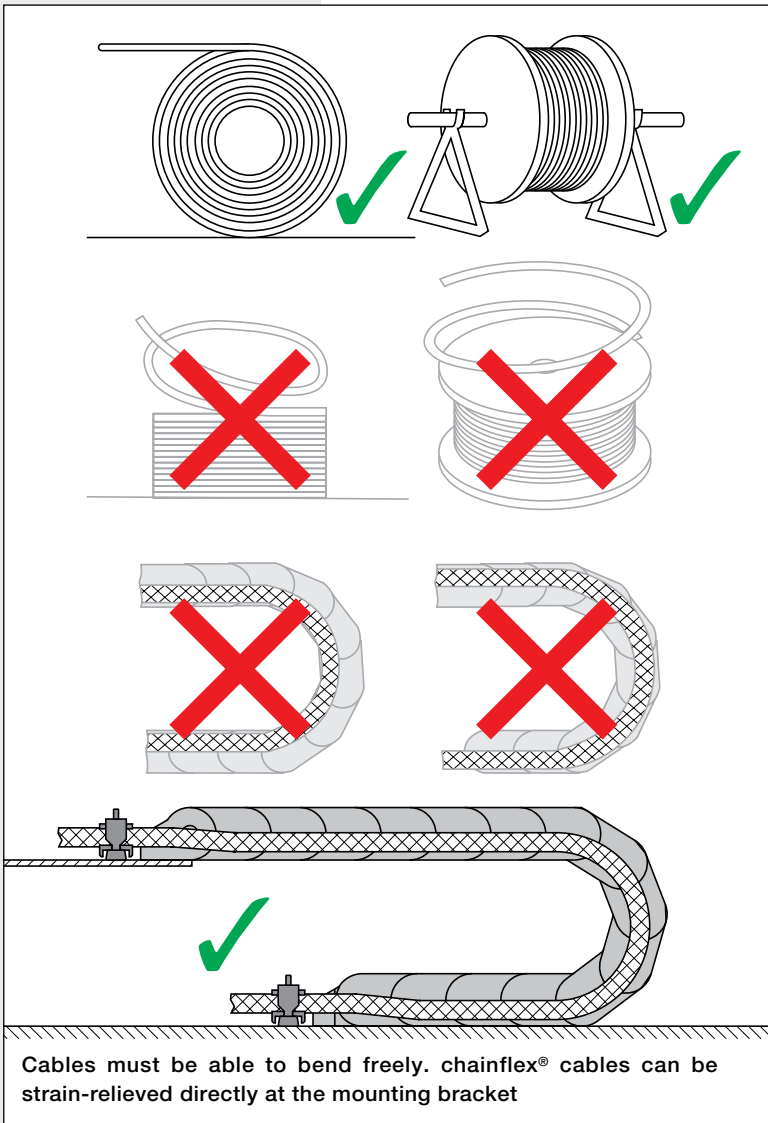

e-chain system® Design Cable and Hose Packages Distribution Rules



Pneumatic hoses

In principle, the same rules apply for pneumatic hoses as for round cables. In practice, it has been demonstrated that pneumatic hoses are less susceptible to wear. After consultation, they can be laid together more closely than the “10% clearance all-around” rule. A double-sided strain relief is required under these conditions. For pneumatic hoses made of rubber, we recommend strictly following the “10% clearance” rule because they tend to adhere to each other and to other cables/hoses.

Flat cables

Flat cables must be able to move freely along the bending radius. Two flat cables next to one another should be kept apart with separators. If two flat cables are laid on top of one another, we strongly recommend the use of horizontal igus® shelving. Flat and round cables should be laid separately in the e-chain®. Strain relief should be attached at both ends. Flat cables are only conditionally recommended for use in e-chains®.

Hydraulic hoses

When designing hydraulic hoses in e-chains®, special attention should be paid to the expansion of the hoses when pressurized. Sufficient room must be left in the e-chain® for this as well as the possible larger external diameter of the hoses under pressure. It is important for selected hoses to be sufficiently flexible (i.e. meet bending radius specified by the e-chain®). The gliding ability and abrasion-resistant surface of the hoses are also important. All crossbars and shelves in the igus e-chain® minimize abrasion of hoses through wide, rounded and smooth surfaces. Normally, hoses with textile braiding are more flexible than hoses made of steel wire, while maintaining smaller outer diameters and better fatigue strength under stress.

As lateral movements of the hydraulic hoses within the chain can lead to increased abrasion of the hose material, they should be secured in position with vertical separators, but not forced. Special “locking” separators, which grip the opening crossbars of the chain, as well as the use of “spacers,” prevent lateral shifting of the separators; they also ensure the hoses stay put in cases of strong vibration and impact on the chain. Details about these accessories can be found in the description of various chain types.

Strain Relief

Hydraulic hoses are most often stretched lengthwise during operation. This must be taken into account when applying strain relief. More hose length is factored in to allow the hose to “breathe,” or “floating” strain relief must be implemented. In some cases, strain relief on the moving end only can be tolerated.

Rollclip

In almost all cases, the broad, smooth and rounded surfaces of all igus® e-chains® and tubes are sufficient to protect hydraulic hoses from abrasion. In extreme cases, the igus Rollclip can be installed. The hoses come in contact with a series of polymer cylinders which rotate. “Extreme” cases include particularly soft materials, particularly narrow bending radii or highly dynamic loads. Over 95% of all applications can be solved without Rollclips.

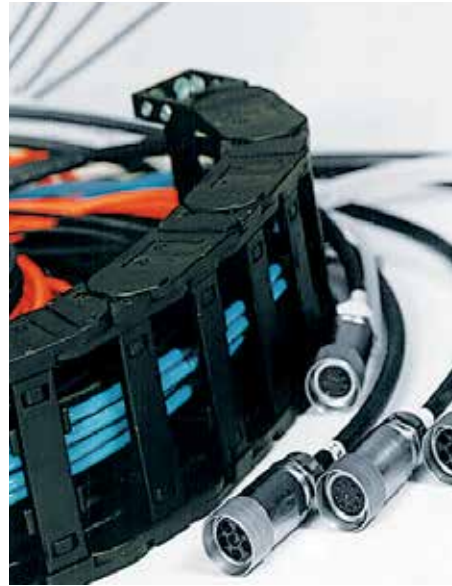

Fully pre-assembled e-chain system® with several pneumatic and hydraulic hoses



● Pneumatic hoses

The igus® program also offers polymer pneumatic hoses called chainflex® Air

● Flat cables

Outer jackets made of rubber must be specified particularly carefully, because of potentially high friction

● Hydraulic hoses

Hydraulic hoses need more space: 20% all-around clearance



The new roller crossbars for the E4.1 system significantly reduce jacket abrasion of very stiff cables and hoses with rolling contact surfaces equipped with tribo-optimized bearings. Available upon request



e-chain system® Design Strain Relief Elements Chainfix



Ideally, the cables/hoses should have strain relief at both ends of the e-chain®. At the very least, they must have strain relief at the moving end of the e-chain®.



For more information on all igus® strain relief elements, [► Chapter 10](#)

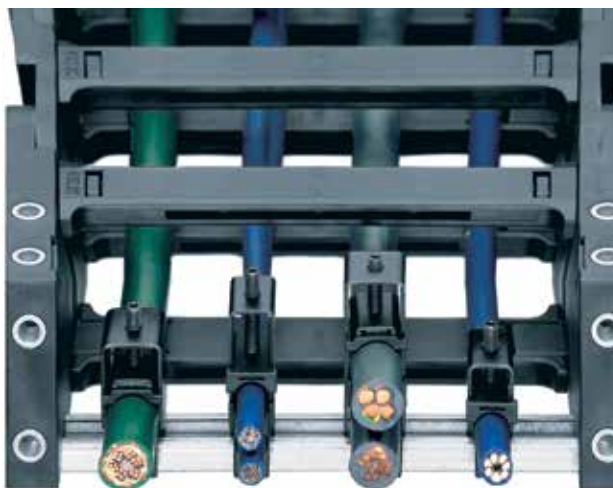

Strain relief in KMA mounting bracket with profile rail.

Strain relief for electrical cables

Strain relief can consist of standard elements or can be custom-made. For most applications, our standard program of profile rails in mounting brackets and space-saving Chainfix® clamps can be used. We also offer simple strain relief solutions using cable tiewraps and tiewrap plates. In ideal cases, the cables should be secured at both ends of the e-chain® with strain relief (in a few instances, strain relief at the moving end of the e-chain® is sufficient - please consult igus® for these cases).

Minimum gap of the strain relief and the beginning of the bend radius

Tests on our premises and in field applications have shown strain relief located at the last bending point of the e-chain® has no influence over the durability of igus® chainflex® cables. It is possible, therefore, to integrate the strain relief with the mounting bracket. This space-saving option for strain relief is offered by igus® for almost all e-chains® (More details on this in the individual chapters).

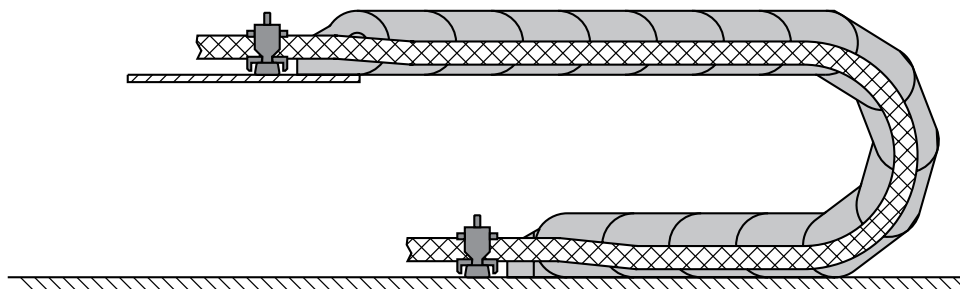

Ideal installation of cables in e-chains®. chainflex® cables can be directly strain-relieved in the mounting bracket (minimum gap to the last curved chain link is not necessary)



Chainfix strain relief with KMA brackets; used here for cables and hoses

e-chain system® Design

Strain Relief Elements

Chainfix



Features of Chainfix clamp

- Optimal igus® Chainfix housing with reduced height
- Long service life for dynamic applications thanks to improved clamping elements
- Integration with KMA mounting brackets - saves both time and space during installation and available for complete systems with cables and strain relief
- Improved housing foot clamp for easy fit into the profile rail
- Black housing and setscrews for attractive appearance
- Setscrews, tightened with Allen wrench, for easy installation
- Mark of the installation direction
- Now with better fixation due to optimized design

Tiewrap plates as individual parts

- Strain relief accessory for igus® e-chain systems®
- Attachment to mounting brackets
- Integration into the profile rail of KMA (polymer/metal mounting brackets)

Tiewrap plates with clip-on connection for the profile rail

The plates **3050.ZC** and **3075.ZC** can be clipped directly into the profile rail without bolts or any extra hardware. Clip-on tiewrap plates can be released and repositioned with just a screwdriver used as a lever.

4 options available:

- Tiewrap plates with clip-on connection for the profile rail
- Integrated strain relief for E2 tubes - series R
- Tiewrap plates for fixed crossbars
- Tiewrap plates for opening crossbars

CFU Honeycomb strain relief

- Up to 80% faster strain relief for different cables in one slot
- Simply insert cables and hoses into the honeycomb and close
- Easy to make changes - add or remove cables/hoses
- Simplified parts
- Can be used in gliding applications

Strain relief separator

- Can be integrated in mounting bracket
- Can be positioned as required
- Easy installation
- Cost-effective
- For most series from stock

Strain relief element outside of the e-chain® cross section

- Easy strain relief for cables, even in enclosed tubes
- Stepped strain relief - good access when retrofitting several cables with strain reliefs
- Matching for e-chains® and e-tubes
- Easy retrofit assembly possible
- Simple installation into top-hat rails and profile rail on KMA mounting brackets

Chainfix nugget - for profile rail

Option 1: universal cable fixation, for diameter with $\varnothing .79"$ (20 mm) and $\varnothing 1.18"$ (30 mm)

- The smart helper for electricians in the machine building industry
- Accessory for all KMA with integrated profile rail
- Easy to assemble, without any screws and tools
- Adjustable to every e-chain® filling
- Very small space requirement
- Easy strain relief with pre-attached cable strap

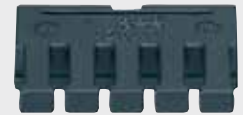

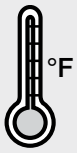

e-chain system® Design

Technical Data

Material Data



igus® materials

- igumid G
- igumid NB
- igumid ESD
- igumid TE
- igumid GE
- igumid DT

Find technical data about igus® materials, temperatures and chemical resistance
 ►see page 1.47



igus® factory; automatic compounding and conveyor belt for igumid G



Technical environment:

- Fire resistance
- Radiation
- Weathering
- Cold, heat
- Explosion areas
- Vacuum
- Hot chips
- Dirt, dust
- Cleanroom
- Chemicals

Plastics for longer life® - igus® know-how in polymer materials

Each year, igus® engineers develop more than one hundred new plastic compounds and test igus® products in more than 15,000 experiments per year. That's how in recent years they have built an extensive database of the tribological properties of polymers. This database makes it possible for us to better assess most of the applications in advance and provide our customer with confidence during use. Our calculations and analyses are based on the result of ongoing practical tests in our technical center and our experience with gliding applications. The focal points of our tests are push/pull forces, friction values and abrasion under widely varying conditions and speeds, as well as factors such as dirt, weathering or impact and bumps. We test all system components such as cables, hoses, strain relief and other accessories, in addition to the e-chains® or e-tubes and guide troughs.

Technical environment

The igumid G material, from which igus® e-chains® are made, possesses the following wide-ranging features to cope with a variety of environments: the ability to handle pressure and strenuous loads, abrasion resistance, sturdiness, stable behavior at high and low temperatures, and suitability for outdoor use. Numerous application examples, from refrigerator blocks to steel mills, prove this. In extreme cases, we also offer modifications and other igus® compounds as a solution. Please consult igus®.

Magnetically detectable plastic e-chains® - For the food and tobacco industry

- The material igumid DT is detected to the tiniest fragment all common metal detection systems and can therefore be selected automatically
- Particles as small as .04" (1.0 mm) can be recognized for fragments passing at speeds of 65.6 ft/min (20 m/min)

More information ► www.igus.com

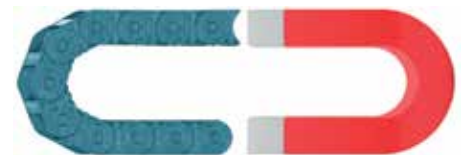

e-chain system® Design

Technical Data

Material igumid

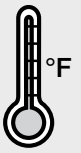

Flammability of igumid G

The flame-retardant characteristics of igumid G can be described using various classifications:

- Test procedure VDE 0304 parts 3-5.70 - classification IIc.
- Tested according to UL 94 "Standard Tests for Flammability of Plastic Materials for Parts in Devices and Appliances" classification 94 HB for .13 and .06 in. (3.2 and 1.6 mm) thickness of the body.
- Tested according to DIN 4102 "Fire Behavior of Building Materials and Parts" classification materials class B-2.

For further requirements, please consult igus® for special solutions, such as materials with self-extinguishing properties (UL94-V2 or UL94-V0).

All e-chains® (except for the E-Z Chains and Series 14 Chains) are made from igumid G.

Flammability of igumid NB

All E-Z Chains and Series 14 Chains are made from the flame-retardant igumid NB material. These chains have the following flame-retardant classifications:

- UL 94 classification - V2
- VDE 0304 Parts 3-5.70 classification - IIb
- DIN 4102 flammability of materials - B2

Please consult igus regarding material availability "V0."

Temperature resistance

igumid G is very suitable for outdoor applications. In our experience, the mechanical properties of the chain are not impaired. igumid G is also UV-resistant. igus® e-chains® are used in applications as cold as -40°F (-40°C). Installation may be eventually compromised at temperatures below -13°F (-25°C). In such cases, we offer special solutions made from cold-elastic materials. +248°F (+120°C) continuous temperatures are possible, however, the mechanical values are reduced and the service life is impaired. Please consult igus® if you have specific temperature requirements.

Resistance to radiation

igus® offers several solutions for high radiation areas. igumid G is very resistant to high-energy radiation. Under gamma radiation, in the range of 8×10^4 rd, the mechanical properties of igumid G change very little. Please consult igus®



Reflecting telescope at 2,200m. Robust under high wind speeds, snow, ice and increased UV radiation



Series 4040R rol e-chain® on a coal unloading system - travel 623 ft. (190 m), speed 1.64 ft/s (0.5 m/s), fill weight 5.41 lbs/ft. (8.05 kg/m)



Live broadcast from the Winter Olympics in Lillehammer; 246 ft (75 m) travel at -13°F (-25°C)



igumid G:
UL 94 HB (Standard)

igumid NB:
UL 94 V2 (Standard)
UL 94 V0 (upon request)



igumid G:

- UV-resistant
- Temperature range from:
-40°F (-40°C) to
+248°F (+120°C)



e-chain system® Design

Technical Data

ESD & ATEX



- **ESD** - avoidance of static charges in the field of manufacturing processes of electronic components or assemblies
- **ATEX** - prevention of explosive static charge in hazardous environment



100% of the produced ESD e-chains® are checked for their continuous conductivity from one end to the other

Measurements of the electrical surface leakage resistance for igus® e-chains® with the special material igumid GC were made already in 1992 by the igus® GmbH together with the PTB (Physikalisch-Technische-Bundesanstalt) in Braunschweig, supplemented by additional certifications in 1998 and 1999 according to DIN 53482 and the guidelines for static electricity "ZH1/200" of the Federation of Trade Associations. In the course of further innovation, the material igumid ESD was certified by the PTB (Physikalisch-Technische-Bundesanstalt) in May 2002. The material igumid ESD combines in its properties the requirements of the ESD as well as ATEX criteria. In some mechanical requirements, the igumid ESD surpasses even the standard material igumid and has been tested with over 10 million cycles in the igus® technology center.



Product range of ESD e-chains® from stock

Zipper	in.	Bi	(mm)
07	.39 - 1.97		(10 - 50)
09	.63 - 1.97		(16 - 50)
E2/000			
1500	.59 - 3.15		(15 - 80)
2500	.98 - 4.92		(25 - 125)
2700	1.97 - 4.92		(50 - 125)
E4-1			
E4.21	1.18 - 2.76		(30 - 70)
E4.28	1.57 - 4.92		(40 - 125)
E4.32	1.97 - 7.87		(50 - 200)
E4.42	1.97 - 7.87		(50 - 200)
E4.56	2.95 - 11.81		(75 - 300)
E4.80	2.95 - 11.81		(75 - 300)
Triflex® R TRC	in.	Ba	(mm)
TRC.40	1.69		(43)
TRC.60	2.56		(65)
TRC.70	3.19		(81)

Your benefits with ESD products

- ESD material tested with over 10 million cycles for the highest requirements
- Snap-open e-chains® with mounting brackets and interior separation in ESD and ATEX design available from stock
- Standardized product - igumid ESD with PTB certificate
- Proven over years of use in explosion-proof areas

Conductivity of igus® products from igumid ESD

In contrast to applied conductive surface coatings or potentially volatile incorporated anti-static agents, the additives used in the igumid ESD products from igus® grant long-term, maintenance-free conductivity to e-chains®. However, a conductive e-chains® alone is not enough to ensure sufficient conductivity. Instead, all individual components, as well as the entire e-chain®, must exhibit continuous conductivity. igumid ESD e-chains® are slate grey in color* to distinguish as conductive materials. All products in this catalog are optimized in this regard, and their continuous conductivity is tested, measured and documented prior to delivery. Only igus® e-chains® that have passed these tests are marked with the tested seal, and delivered to igus® customers.

*Exception: igus® Zipper e-chains® Series 07/09





More information on igus[®] ESD e-chains[®] - classification II 2 GD

● **General safety information:** these additional operating Instructions apply to the explosion-protected versions of our e-chains[®] of Type ESD in color grey (similar to RAL 7015). They supplement the Installation Instructions for the standard e-chains[®] and the catalog information. The information in these instructions relates only to data impacting on explosion protection. The technical information in the Installation Instructions for the standard e-chains[®] and the category information still apply unchanged unless these Instructions explicitly exclude or replace the relevant information. Required documentation and other documents are filed with the following institute pursuant to the ATEX Directive:

Physikalisch-Technische Bundesanstalt (PTB) Braunschweig and Berlin
 Bundesallee 100 • 38116 Braunschweig/Germany

● **Assembly, removal and installation:** please follow the information in the installation instructions for the standard e-chains[®] and the catalog information on assembly, removal and installation for trouble-free operation. igus[®] ESD e-chains[®] must be grounded with appropriate measures in accordance with drawing number 18392.2 in order to discharge any electrostatic charges occurring.

Assembly, installation, commissioning and maintenance may be performed only by personnel trained in explosion protection!

Please also note the corresponding national safety regulations and the relevant national regulations in respect of explosion protection during installation and operation.

● **Commissioning:** before commissioning the system, check that the system has been installed correctly in accordance with the Installation Instructions for the standard e-chains[®] and the catalog information. Correct grounding must be checked in particular in the case of ESD e-chains[®].

● **Maintenance:** igus[®] e-chains[®] are maintenance-free. Correct grounding of the e-chains[®] must be inspected at regular intervals. (*in case of large projects a customized maintenance plans can become an issue and will be created if necessary)

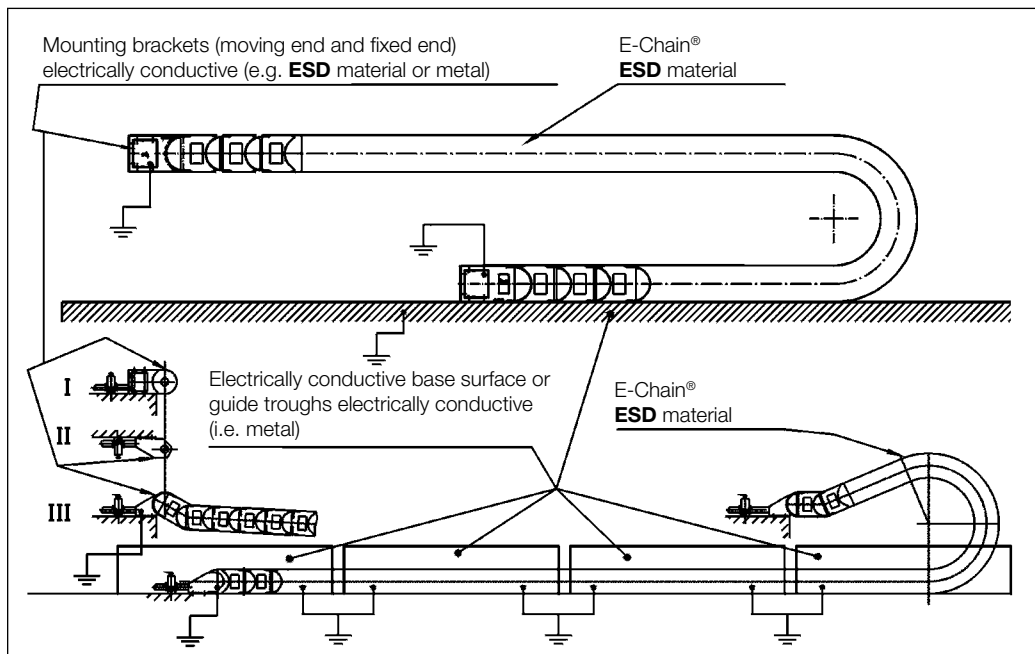

Connection of an e-chain[®] in accordance with ATEX Directive 94/9/EC



igumid G - II 3 GD

igus[®] e-chains[®] made of standard material igumid G correspond to the German federal office of Physics and Technology (PTB) to classification Ex II 3 GD according to ATEX-RL 94/9/EG.

igumid ESD - II 2 GD

igus[®] e-chains[®] made of igumid ESD correspond according to the German federal office of Physics and Technology (PTB) to classification Ex II 2 GD according ATEX-RL 94/9/EG



igus[®] igumid ESD with PTB certificate

We have received an official certificate from the German National Standards Laboratory (PTB) on material igumid ESD and we are able to provide you with a copy on request.

e-chain system® Design

Technical Data

Cleanroom and ESD

Cleanroom qualification of igus® e-chains®

In many applications where cumbersome special solutions are used, a simple standard e-chain® can be used instead. A comprehensive test program was devised and performed for both gliding use and unsupported use. For many applications, the e-chains® in special materials are practically abrasion-free. Detailed test results are available upon request. IPA tests confirm that standard igus® e-chains® meet cleanroom requirements. "Tested and certified as very good!" e-chains® for cleanroom applications in the test stand cleanroom environment demand very high wear-resistance of moving parts. e-chain®, for example, must be very wear resistant, in order to meet the normal requirements for such a sensitive environment.



IPA Fraunhofer Institute has tested the following igus® series according to DIN EN ISO 14644-1

Result according to DIN EN ISO 14644-1	Equivalent to US Federal Standard 209E	Classification Series	Report No.	Speed ft/s (m/s)
ISO Class 1	No comparable classification	E3-15-040-075-0	IG0704-400	1.64 / 3.28 / 6.56 (0.5 / 1.0 / 2.0)
ISO Class 1	No comparable classification	E61-29-050-075-0	IG1303-640-1	1.64 / 3.28 / 6.56 (0.5 / 1.0 / 2.0)
ISO Class 2	No comparable classification	E14-3-038-0	IG0308-295	3.28 (1.0)
ISO Class 2	No comparable classification	1500-050-038-0	IG1303-640-1	1.64 / 3.28 / 6.56 (0.5 / 1.0 / 2.0)
ISO Class 2	No comparable classification	T3-29-050-038-0	IG1303-640-1	1.64 / 3.28 / 6.56 (0.5 / 1.0 / 2.0)
ISO Class 3	ISO Class 1	E6-29-060-150-0	IG0704-400	1.64 / 6.56 (0.5 / 2.0)
ISO Class 3	ISO Class 1	2500-05-055-0	IG0308-295	6.56 (2.0)
ISO Class 5	ISO Class 3	E4-32-10-063-0	IG1303-640-1	1.64 / 3.28 / 6.56 (0.5 / 1.0 / 2.0)

Particle generation measurement



Result: particle generation
E14-3-038-0

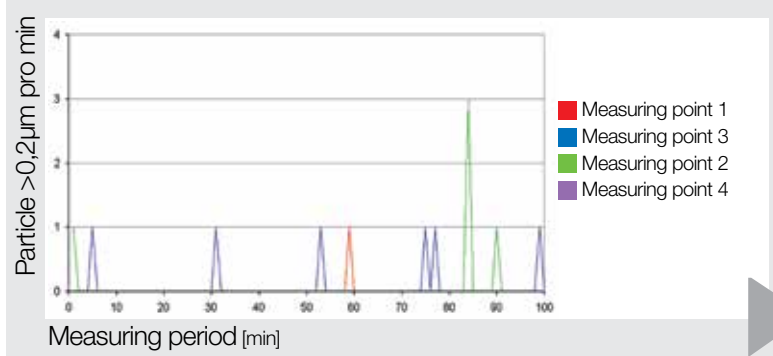

ISO Class 2
according to
DIN EN ISO 14644-1
for E14-3-038-0



Absorption LEVEL 1 confirmed by IPA-Fraunhofer-Institut according to SEMI E78-0998 for the E6 standard material. Continuously constant conductance value as there are no pin-bore connection (no air gaps).

Field strength measurement



Result: field strength
E6-29-050-055-0

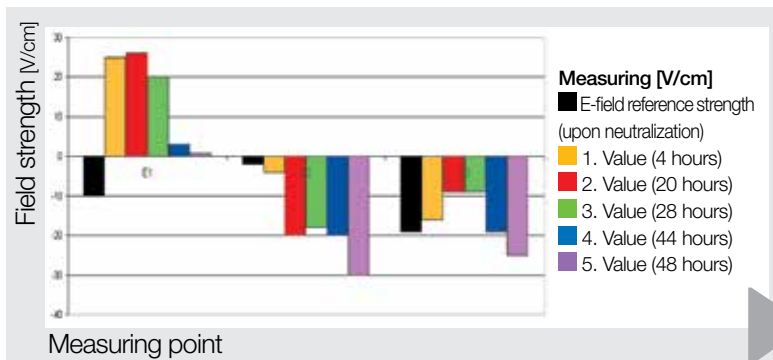

Level 1
ESD-compatibility
according to SEMI
E78-0998 for
E14-3-038-0 and
E6-29-050-055-0

e-chain system® Design

Technical Data

Dirty Environments

Spatter, hot chips

Laboratory tests and numerous field applications over the past 20 years have proven that igus® e-chains® and fully enclosed e-tubes protect cables used in welding robots and machine tools. e-tubes made from the igus® igumid HT material are resistant against hot chips and flying debris up to 1,562°F (850°C), no chips stick. This opens up new possibilities for replacing more complex and expensive steel tubes. All standard E2 and E4 e-tubes are available made from igumid HT, upon request. Please note: igumid G in direct contact with large amounts of melted aluminum is not recommended.



igus® e-tubes in the chip area of machine tools

Dirt, dust, chips

Materials and design make igus® e-chains® excellent problem-solvers in harsh environments. Experience and application references are available upon request. Please consult igus with your application.



Also hot asphalt is no problem for igus® e-tubes

Vacuum

igus® e-chains® made of igumid G can be used in vacuum applications. Very little outgassing occurs.

Chemical resistance

igumid G is resistant to fuel, lubricants, oils, fats, alcohol, ester, ketone, and aliphatic and aromatic hydrocarbons. Oxidants and acids are damaging. The table on ► Page 1.48 shows an excerpt of the precise details concerning resistance to chemicals. Acid-resistant e-chains® are available upon request.



System E4 in an incinerating plant - safe also in abrasive dirt and dust

Coolant resistance

e-chains® and e-tubes have proven resistant to cooling agents. However, we are always willing to perform individual tests if you have particular problems or advanced developments.



Compost sludge - numerous related references available upon request

Chemical Resistance Table

► Page 1.48

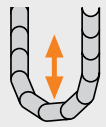

igus® - experience with:

dust, dirt, mud, compost, wood, textile fibers, paper dust, abrasive paste, cooling agents, glass dust, glass splinters, coal dust, sand, corundum and much more.

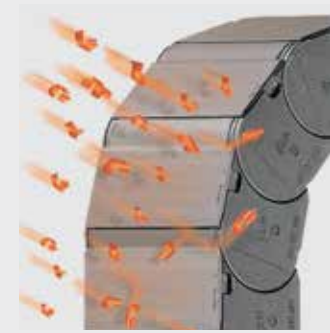

e-tubes that repel hot chips, up to 1,562°F (850 °C) with the igus® "igumid HT" material.



igus® tests: e-chains® and chainflex® cables are tested for resistance against chemicals and oils in long-term tests

e-chain system® Design

Technical Data

Material Data igumid - Colors

Material data igumid

Material data table						
	Units of measure	igumid G	igumid NB	igumid ESD	igumid TE	igumid GE
Mechanical properties						
Yield stress (dry/wet)	MPa	190/130	78/40	*	*	*
Elongation at break (dry/wet)	%	004/006	20/210	*	*	*
Elasticity module (tensile test)	MPa	9000/7000	2900/1200	*	*	*
Limit of elasticity (bending)	MPa	7.800	3.000	9.500	1.290	7200
Bending strength	MPa	240	120	230	55	200
Hardness Shore D	-	79	79	83	72	80
General properties						
Density	g/m3	1,37	1,14	1,2	1,02	1,46
Absorption of humidity 23/50 RF	% by weight	1,4	3,4	1,9	0,8	0,7
Maximum water absorption	% by weight	5,6	7,6	7,3	1,6	4
Electical properties						
Specific transitional resistance	Ω*cm	>1011	>1011	<109	>1011	>1011
Surface resistance ROA	Ω	>1011	>1011	<109	>1011	>1011
Thermal properties						
Lower application temperature	°C / °F	-40°C / -40°F	-40°C / -40°F	-40°C / -40°F	-40°C / -40°F	-40°C / -40°F
Upper long-term application temp.	°C / °F	120°C / 248°F	80°C / 176°F	80°C / 176°F	70°C / 158°F	120°C / 248°F
Upper short-term application temp.	°C / °F	180°C / 356°F	170°C / 338°F	150°C / 302°F	140°C / 284°F	200°C / 392°F
Material certificates						
Fire resistance as per UL94	-	HB	V2	HB	HB	HB
Silicone-free	-	++	++	++	++	++
Halogen-free	-	++	++	++	++	x
2002/95/EG (RoHS)	-	++	++	++	++	++
2002/96/EG (WEEE)	-	++	++	++	++	-
Color						
according to RAL, approx.	-	■ ≈RAL9004	■ ≈RAL9004	■ ≈RAL7015	■ ≈RAL9004	■ ≈RAL9004

++ = yes x = no *Values upon request



Colors and special solutions

Product prices are always based on the color black. e-chains® in any color shown in the color selection chart are subject to a percentage based color surcharge. Any other colors that are not shown in the chart are individually calculated depending on the article and quantity, insofar as this is technically possible. As a rule, colored e-chains® are not available from stock. Delivery lead-time and surcharges for colored e-chains® are available upon request. As a rule, all specifications related to stability (for instance unsupported lengths) and material characteristics apply only to black e-chains®. The characteristics of colored e-chains® may differ. This also applies to all e-chains® from special materials, such as conducting e-chains® made from igumid ESD material or other special materials. For technical reasons HT and ESD materials cannot be supplied in other colors.

e-chain® color variations with RAL-numbers

Color	Availability	RAL #	Part No. Suffix	Color	Availability	RAL #	Part No. Suffix
■ Black	Standard, from stock	≈ RAL 9004	-0	■ Orange	special color	≈ RAL 2003	-2
■ Dusty grey	special color, e-tubes only	≈ RAL 7037	-31	■ Yellow	special color	≈ RAL 1018	-4
□ White	special color	≈ RAL 9003	-1	■ Light grey	special color	≈ RAL 7035	-14
■ Grey white	special color	≈ RAL 9002	-1S				

Black e-chains® available from stock! Delivery time for special colors: Please consult igus®.

e-chain system® Design

Technical Data

Chemical Resistance

Medium	Concentration weight %	igumid G / NB	igumid TE
Acetic acid	2	++	+
Acetone	100	++	++
Ammonia (aqueous)	10	++	++
Benzole	100	++	++
Bitumen	100	+	-
Boric acid (aqueous)	10	++	+
Butyric acid	100	+	-
Calcium chloride (aqueous)	Sat. aq. sol.	++	++
Caustic potash	10	++	++
Chlorinated hydrocarbons		++	+
Chlorine water	Sat. aq. sol.	-	-
Chromic acid (aqueous)	1	+	-
Color		++	++
Diesel oil	100	++	++
Fats, cooking		++	++
Fluorinated hydrocarbons		++	++
Formaldehyde (aqueous)	30	+	+
Formic acid (aqueous)	2	+	++
Gasoline	100	++	++
Hydraulic oils		++	+
Hydrochloric acid	pH ₂	+	-
Hydrochloric acid	2	-	-
Hydrochloric acid	10	-	-
Ink, printing ink		++	++
Mercury		++	++
Methyl acetate	100	++	++
Milk		++	++
Mineral oil		++	++
Oil, cooking		++	++
Oil, lubricating oil		++	++
Oleic acid	100	++	++
Paraffin oil		++	++
Perchloroethylene	100	++	-
Polyester resins (with styrene)		++	++
Potassium carbonate (aqueous)	60	++	++
Potassium sulphate (aqueous)	100	++	++
Propane gas		++	++
Sodium carbonate (aqueous)	50	++	++
Tartaric acid		+	++
Vaseline		++	++
Zinc sulfate (aqueous)	10	++	-



The values specified are values determined by laboratory tests and are material-specific. All specifications apply to black e-chains®

Resistance classes

++ = resistant
 + = conditionally resistant
 - = non-resistant

Sat. aq. sol. = saturated aqueous solution

e-chain system® Design Standards and Certificates

Examples for test certificates and approvals of igus® products

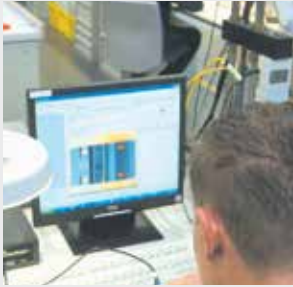

Quality inspection of every e-chain® production



Test location for ESD-e-chains®



chainflex® cables with many certificates for e.g. DESINA

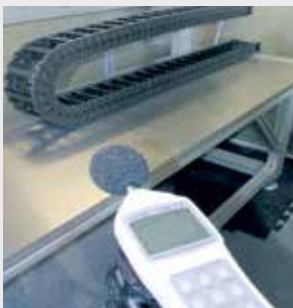

Noise level tests in igus® own acoustic laboratory

ISO 9001:2015

igus® Inc. has been certified since May 2002

TÜV construction test

igus® e-chains® and e-tubes are construction-tested by TÜV Rheinland. igus® e-chains® were tested and passed by TÜV Rheinland in accordance with the valid machine guidelines. As a result, the user of igus® e-chains® need not worry about meeting CE requirements through testing for this portion of the machinery. The construction test 2PFG 1036 / 10/97 for protective equipment includes the following:

- Application/safety
- Assembly
- Fatigue strength
- Resistance to external influences
- Sharp corners and edges

ESD/ATEX

igus® e-chains® made of standard material igumid G correspond to the German federal office of Physics and Technology (PTB) to classification Ex II 3 GD according to ATEX-RL 94/9/EG. igus® e-chains® made of igumid ESD correspond according to the German federal office of Physics and Technology (PTB) to classification Ex II 2 GD according ATEX-RL 94/9/EC.

IPA Cleanroom

Many e-chains® are suitable for the use in cleanrooms according to DIN EN ISO 14644-1. Confirmed by the IPA Fraunhofer Institute.

UL, CSA, CEI, CE, VDE

All igumid-materials for e-chains® and e-tubes have got the UL-material approval. The material igumid NB has the fire protection class approval IIb according to the test VDE 0304 Part 3/5.70, the approval V2 according UL94 and the construction material class B2 according DIN 4102.

Interbus, CC-Link and DESINA

chainflex®- cables are produced according to a variety of international standards. **Interbus certification:** for Interbus certification of certain CF11 bus cables. **CC-Link:** CC Link is a Fieldbus established by Mitsubishi Electric Automation. igus® chainflex® CFBUS.035 is

Clearly quieter

igus® e-chain systems® are clearly quieter. In the acoustic laboratory of the TÜV and the igus® GmbH different e-chains® were compared. The igus® System E3, E6 and E4/00 (Series E4/101) are measurably (and clearly) quieter than other products

igumid

The material igumid is free from toxins, according 2011/65/EU (RoHS2).

iF Design Award

32 iF Design Awards since 1987



igus[®] readychain[®] & readycable

Ready-to-install energy supply systems.
Cables with connectors.
Minimize process costs.
Everything from a single source.

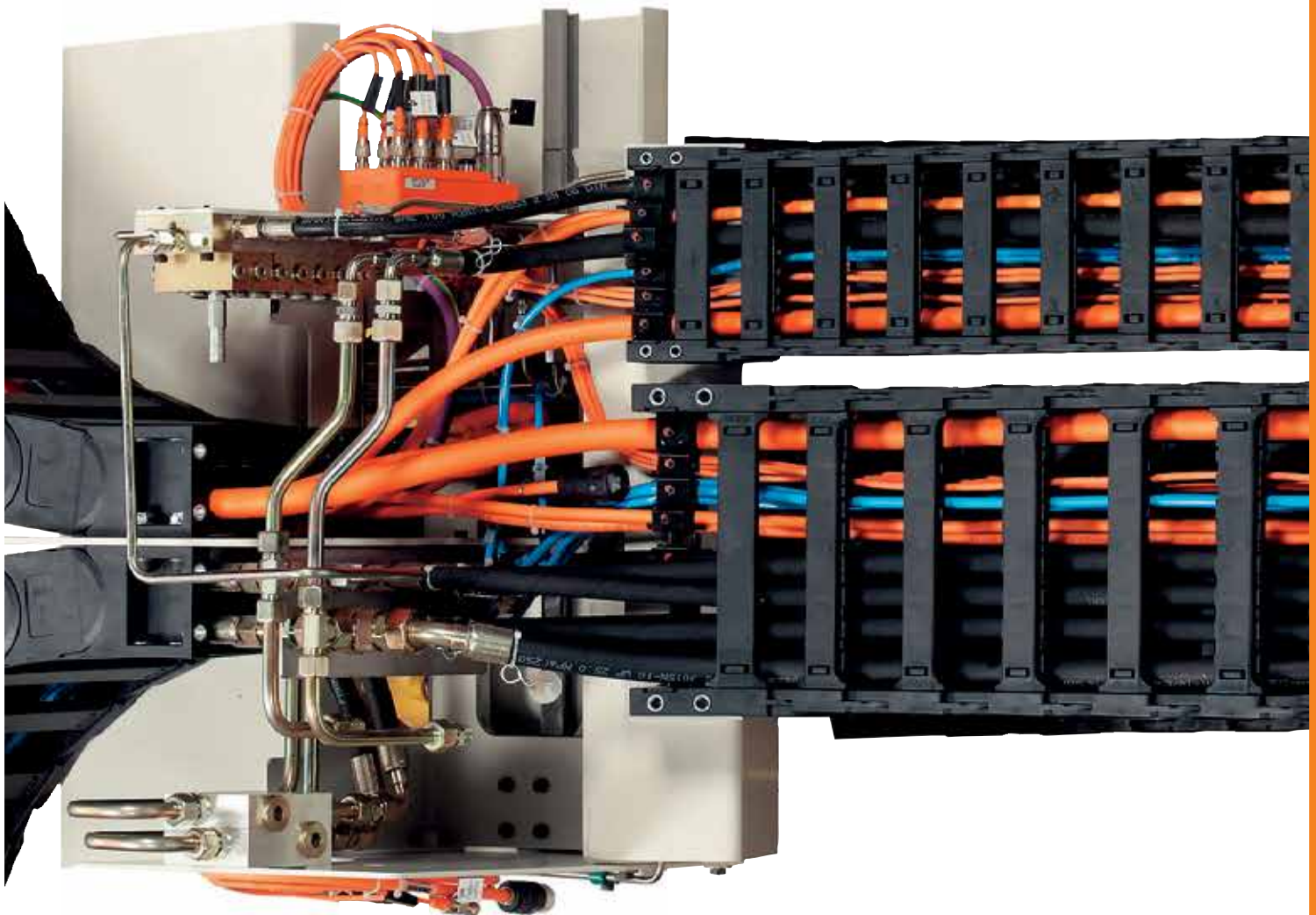

readychain® Ready to install assembled e-chain systems®

Assembled energy supply systems, connectors and cables from igus®. Everything from one source, directly from the manufacturer, delivered quickly to your machine



Ready to install systems, from connectors through assembled cables up to complex energy supply modules, delivered in 1-10 days



Customer specific production

readychains® - increase your capacities and cash flow quickly with igus

- Lower the overhead costs
- Cut your throughput times from days to hours
- Respond flexibly to order variations
- Utilize igus® manufacturing capacities and our know-how in cable assembly



From one off to mass production

Reduce the number of suppliers and orders by 75% with igus®

- One order, one invoice, one delivery
- A partner for minimal machine downtimes
- All readychain® components are subject to an extensive quality control and function testing

Professionally assembled energy chain® modules direct from the manufacturer ...
 You decide the quantity, the travel and the degree of assembly ...

3 Benefits: readychain® basic



- 1 ONE supplier - combine suppliers
- 2 Reduce assembly time
- 3 Reduce failures

Reduction of assembly time
 Reduction of logistics cost
 Procurement optimisation



Further information, videos,
 configurators and product finders
 ▶ www.igus.com/RCbasic

6 Benefits: readychain® standard



- 4 No electrical termination needed
- 5 100% digitally tested
- 6 No cable surplus

Reduction of assembly time
 Reduction of logistics cost
 Procurement optimisation



Further information, videos,
 configurators and product finders
 ▶ www.igus.com/RCstandard

9 Benefits: readychain® standard+

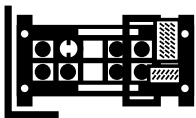

- 7 Reduce interfaces
- 8 Optimize points of connection / interfaces
- 9 Ready-to-install multi-axis system

Reduction of assembly time
 Reduction of logistics cost
 Procurement optimisation



Further information, videos,
 configurators and product finders
 ▶ www.igus.com/RCstandard+

13 Benefits: readychain® premium

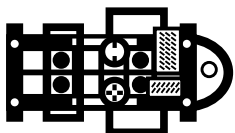

- 10 Optimize your transport / assembly
- 11 One single assembly
- 12 One Part No. / Product group
- 13 Plug & Play

Reduction of assembly time
 Reduction of logistics cost
 Procurement optimisation



Further information, videos,
 configurators and product finders
 ▶ www.igus.eu/RCpremium

readychain® The igus® readychain® Factory

Up to 1,000 orders/week, over 9,843 ft² floor space, “chain-cable-guarantee” since 1989.
More than 13 project engineers and over 127 dedicated readychain® assembly employees.



In igus® readychain® factories, we assemble customized e-chain systems®.



Up-to-date production processes, custom-build or serial production



Full service from system acceptance to installation



11 readychain® factories worldwide



Customized cable assembling at igus® Inc.

readychain®

Modular, quick and ready-to-install

1

Everything from one source

The readychain® system includes pre-assembled, customized e-chain systems®. The "plug-and-play" solutions are configured, manufactured and delivered according to individual customer specifications. The use of the mounting rack can yield benefits even at low volumes.



2

Flexible components

The telescoping supports and braces of the readychain® rack allow flexible adaptation to the installation needs on site. Changes in mass production can be easily undertaken. By using modular parts, additional components can also be easily attached to the rack.

3

Sustainable use

The components of the readychain® rack are galvanized and thus designed for a long life. Each rack is constructed within a few hours. The individual elements can be reused at any time removing the need to dispose of custom made parts, such as conventional welded transport racks.

4

Precise fitting "Plug & Play"

All interfaces and attachments are designed in such a way that the installation of the e-chain® can be managed quickly and easily. The complete package includes the matching plugs and connectors, plates, sensor actuator boxes, linear bearings, links to the central lubrication, etc., all reducing the installation time considerably.

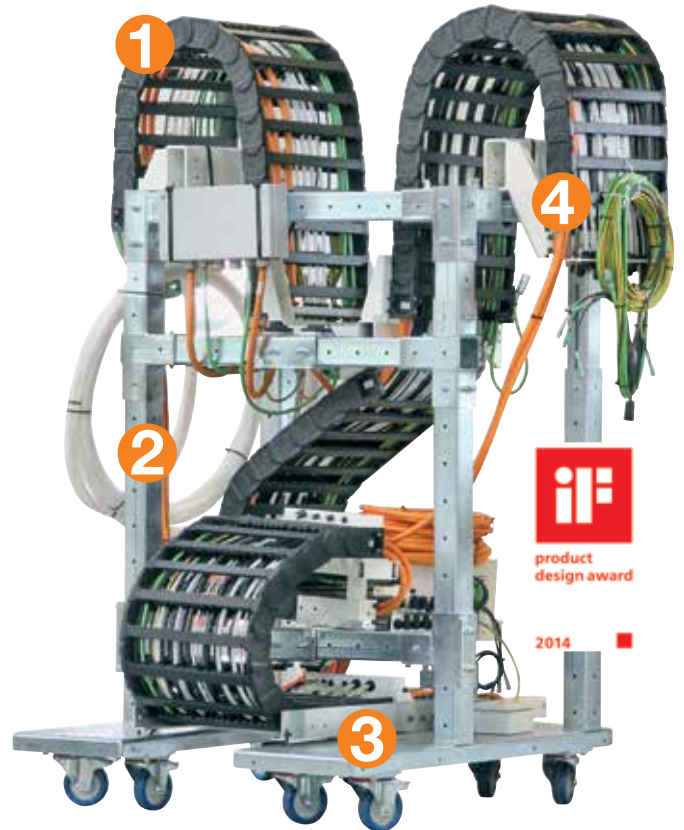

Save 80% at prototyping. Assembly transport rack for ready-to-install energy supply systems.

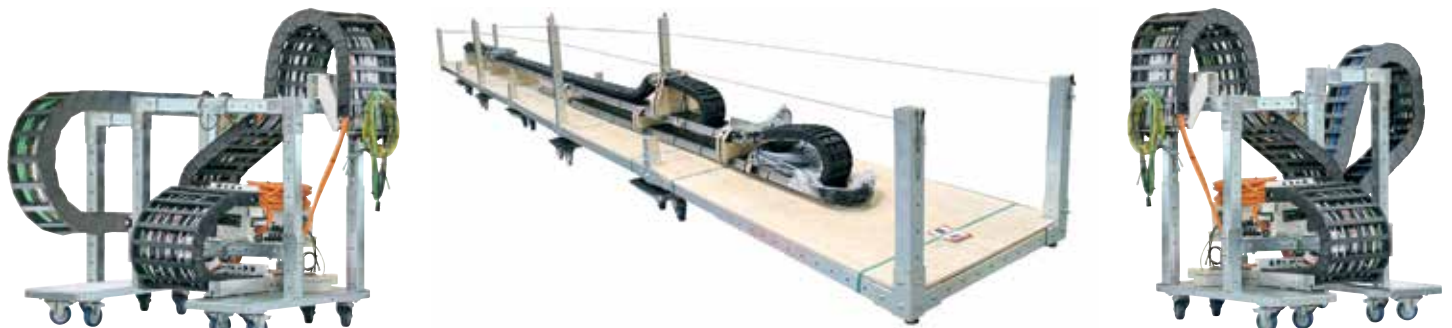

readychain® Connectors, cables and accessories

igus® connectors



Round plug connector kit



Square plug connector kit



Tools and accessories

igus® readycable



Drive systems: 3,200 cables



Catalog standards: video/vision/bus technology



Catalog standards: network/ethernet/FOC/Field bus



Catalog standards: CF-INI initiator cables up to 4 x d

igus® hoses and attachments



Configured online with hose cable configurator...



...to meet your needs

readychain® Configured, fitted, with System Guarantee



1

readychain® Service

- We visit you
- Define interfaces
- Logistics planning
- Cycle integration
- Time schedule



System acceptance on your machine



2

readychain® service

- Component selection
- Interface optimizations
- Documentation
- Integrated project management
- Cost optimization



Project planning



3

readychain® Skype service*

- Initial acceptance from your work place
- Build your prototype with an igus® project engineer, live in your meeting
- Your requests for changes explained with a model or visit us for acceptance in production



Prototype including transport rack



4

readychain® installation

- System installation by igus® specialists
- igus® supervision service for own installation
- Transparent, fixed price



Installation on site

*only available in Germany

readychain® Cable assembly

Capacity for 600,000 assembled cables a year, more than 18,000 test programs, 1,800 test adapters



Lean, automated manufacturing processes ensure a reliable system with short lead times



Computer-based high-voltage testing and inspection of all assembled cables



Modern machinery - automatic stripper-crimper

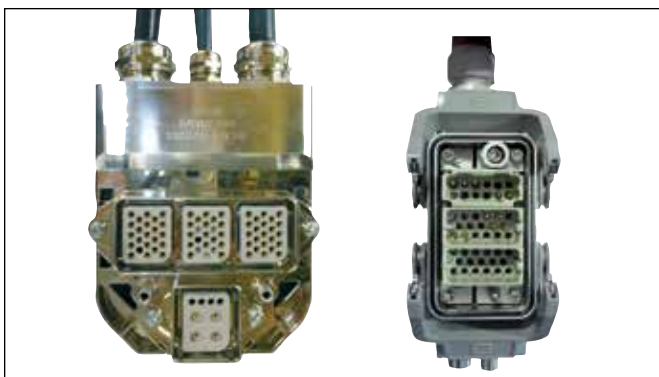

Special cable assemblies



System guarantee



Cable guarantee

e-chains® ...



More than 90,000 e-chain® components

... chainflex® cables...



Over 9 million feet of cable in stock

... readychain®



3,500 connector components



Hundreds of feet of guide trough



18,840 ft² test lab - more than 15,000 tests every year



Quickly within reach



Numerous strain relief solutions



More than 8,000 cable assemblies per week



Just in time supply

readycable® | From 24hrs ... for 24 manufacturers

No. 1 in flexible cable assemblies for e-chains®

The most cost-effective cable for your drive

igus® offers 7 price levels with the same electrical properties for readycable® drive cable assemblies to your requirements:

- From $\pm 180^\circ$ torsion to small movements
- From the smallest to the largest bend radius
- For outdoor or indoor applications
- Seven different outer jacket materials
- chainflex® measuring system and servo cables

Find the right drive cable and calculate the savings potential

► www.igus.com/readycable-finder

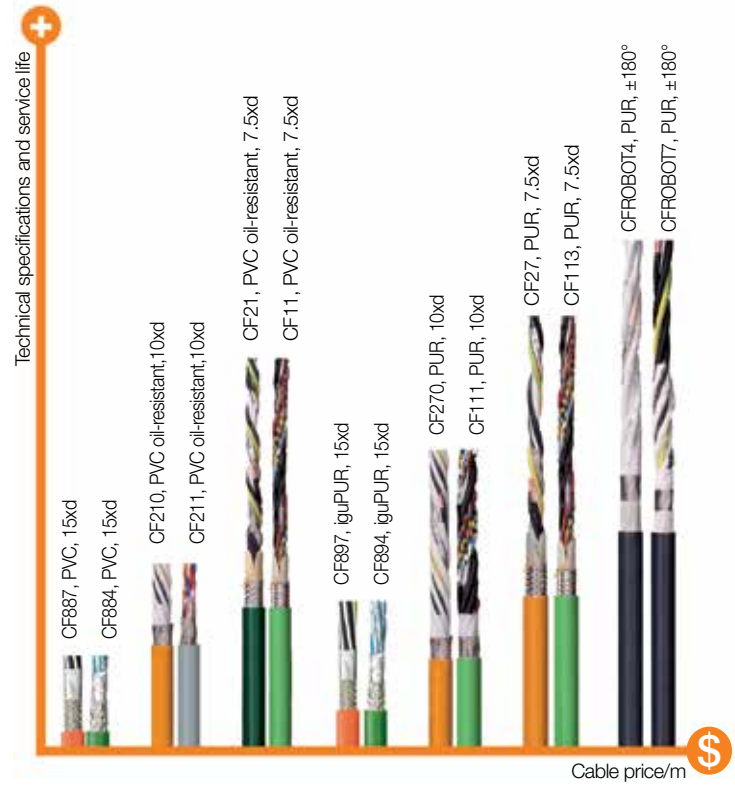

Drive cable assemblies built similar to 24 manufacturer standards:

... Allen Bradley ... B&R ... Baumüller ... Beckhoff ... Berger Lahr ... Control Techniques ... Danaher Motion ... ELAU ... Fagor ... Fanuc ... Festo ... Heidenhain ... Jetter ... Lenze ... LinMot ... LTI DRIVES ... Mitsubishi Electric ... NUM ... Omron ... Parker ... Rexroth ... SEW ... Siemens ... Stöber ...

1.59 More Information ► www.igus.com

Example:



- Always find the most cost-effective solution for your application
- Seven price levels with the same electrical properties
- 4,200 cable assemblies built similar to 24 manufacturer standards
- 36-month guarantee for all chainflex® cables
- To your required length
- No cutting charges
- Each cable electrically tested
- Configure drive cables online
- Fast delivery - up to 25 cables from the current catalogue range in 24hrs

60,000 test programs

- High-voltage tests
- Digital continuity test
- 1,800 test adapters
- Custom tests

More information ► www.igus.com/test

"QuickPin" - connector-cable configurator integrated directly in EPLAN P8

► www.igus.com/quickpin

Predictable reliability ... tested!

- 36-month igus® guarantee on every cable**
- More than 2.0 billion test strokes per year
- 1.4 million electric measurements per year
- Security for machine builders
- Clear statements on durability and service life
- Unique in the market (as of 04/2016)

More information

► www.igus.com/chainflex-guarantee



**Predictable reliability for full 36 months, or up to 10 million double strokes (5 million double strokes for the very cost-effective chainflex® M cables), whichever comes first. For the guarantee to be valid, the cables must be operated within the parameters for each cable series shown in the selection tables.

igus Assembly service with warranty

Improve technology and reduce costs with complete igus[®] systems



Assembly Service Save time and money



Installation

- Installation of your Energy Chain Systems® solution
- On-site supervision and as-built documentation
- Design and delivery of custom brackets and other accessories
- Installation inspections to ensure proper operation
- Full system performance warranty

Modernization / Retrofit

- Complete modernization solutions for your existing energy supply system
- Upgrade performance in speed and length of travel
- Increase system service life
- Minimize downtime and increase machine safety
- Reduce operation costs with an energy saving solution

Failure Inspection Services

- Services to survey and report on the conditions of your current system
- Report of serviceable items and adjustments to prolong life
- Proposals for upgrades and optimizations

Maintenance Inspections

- Full system inspections to comply with warranty documentation
- Identification of problem areas and anticipated life expectancy of parts
- Adjustment of cables, chain, and trough components
- Repair or replacement of system components that are damaged or worn



From a single source - components, service and reliability

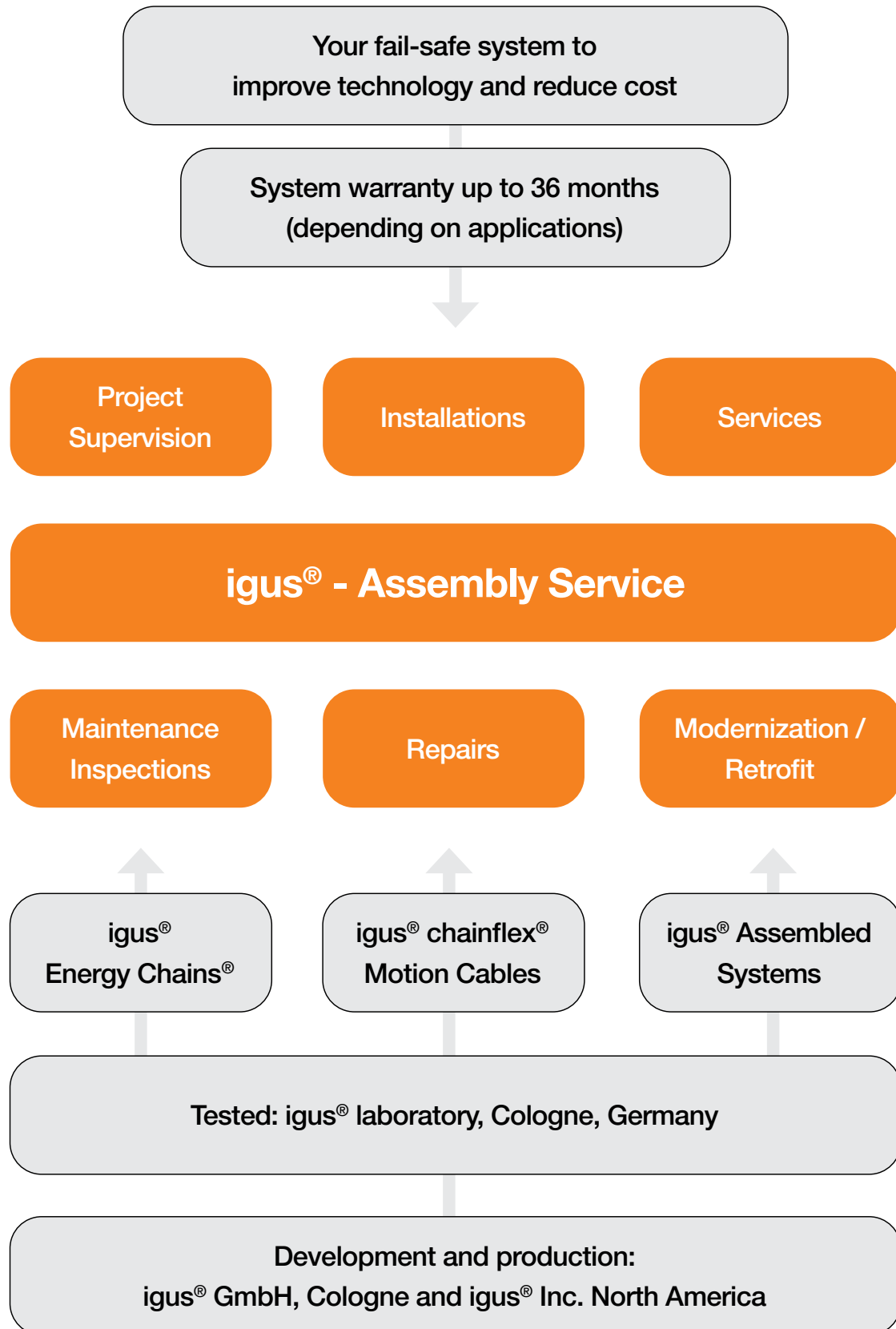

Assembly Service

Save time and money



igus® certified installation personnel

Reduces installation time and costs, ensures long system life and prevents failures caused by installation error.



Fixed costs for assembly and maintenance

Offers savings in administrative costs with purchasing and planning.



Accurate estimates for resource planning

Systems are installed correctly, and on schedule



Our network of installers minimizes costs by providing local, reliable support for your projects

Keeps travel and reaction times short and saves installation costs.



Flexible availability when you need us

Support available, even during nights and weekends.



Everything from a single source - including warranty!

From the design stage through delivery and installation, we will support you from start to finish.

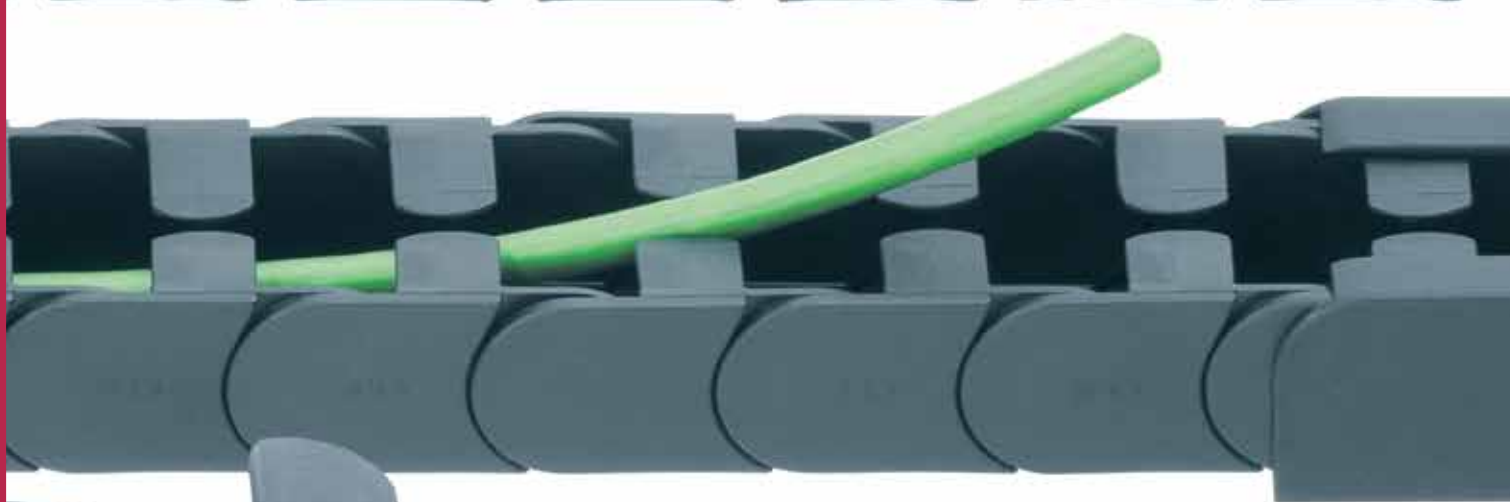



igus[®] solutions for simple applications

e-rib, E1, snapchain, office e-chain[®]





igus[®]

e-rib

**Reinforcement for
existing corrugated
tube systems**

Reinforcement for existing corrugated tube systems - e-rib

Corrugated tubes are used in many applications where the mechanical demands on the energy supply are low. The key advantages are easy, versatile and exceptionally cost-effective guidance of energy, data and media. However, fast movements can lead to damaging sideways movement. The igus® e-rib is easy to clip onto a corrugated hose and can help prevent this. The e-rib fills the joints of the corrugated hose to stabilize it in such a way that it can only move in one direction. The corrugated hose has an unsupported length due to the lateral guide elements. When retrofitted, the e-rib enables an upgrade of existing applications with just a few simple steps. The e-rib is independent of the hose manufacturer (depending on size) and available in four sizes.

- Stability prevents unintentional sideways movement
- Less installation space required
- Easy to retrofit
- No change in the impermeability of the corrugated hose

Typical industries and applications

- Fast, short and unsupported applications
- Standing or hanging applications
- Automotive industry
- Machine and plant construction
- Pick & Place applications
- Plotter
- Handling systems
- Medical technology
- SCARA robots





The igus® e-rib corrugated tube reinforcement can be easily retrofitted onto existing systems



Tests from the igus® laboratory: The igus® e-rib (pictured on the right) stabilizes the corrugated hose significantly in sideways movement during acceleration or deceleration

e-chain system® e-rib

Product Range



e-rib -
reinforcement for existing
corrugated tube systems

Series	Nominal width NW (mm)	Inner width <i>Bi</i> (mm)	Outer width <i>Ba</i> (mm)	Outer height <i>ha</i> (mm)	Mounting bracket
EL.00.23.0	.91 (23)	1.10 (28)	1.61 (41)	1.18 (30)	EL.00.12
EL.01.29.0 ¹⁾	1.14 (29)	1.06 (27)	1.75 (44.5)	1.38 (35)	EL.01.12
EL.00.36.0	1.42 (36)	1.65 (42)	2.20 (56)	1.69 (43)	EL.00.12
EL.00.48.0	1.89 (48)	2.13 (54)	2.66 (68)	2.13 (54)	EL.00.12

1) EL-01-29-0 only for PMA corrugated tube I-PISG-29B/S
Other sizes available upon request. Please consult igus® for delivery time.

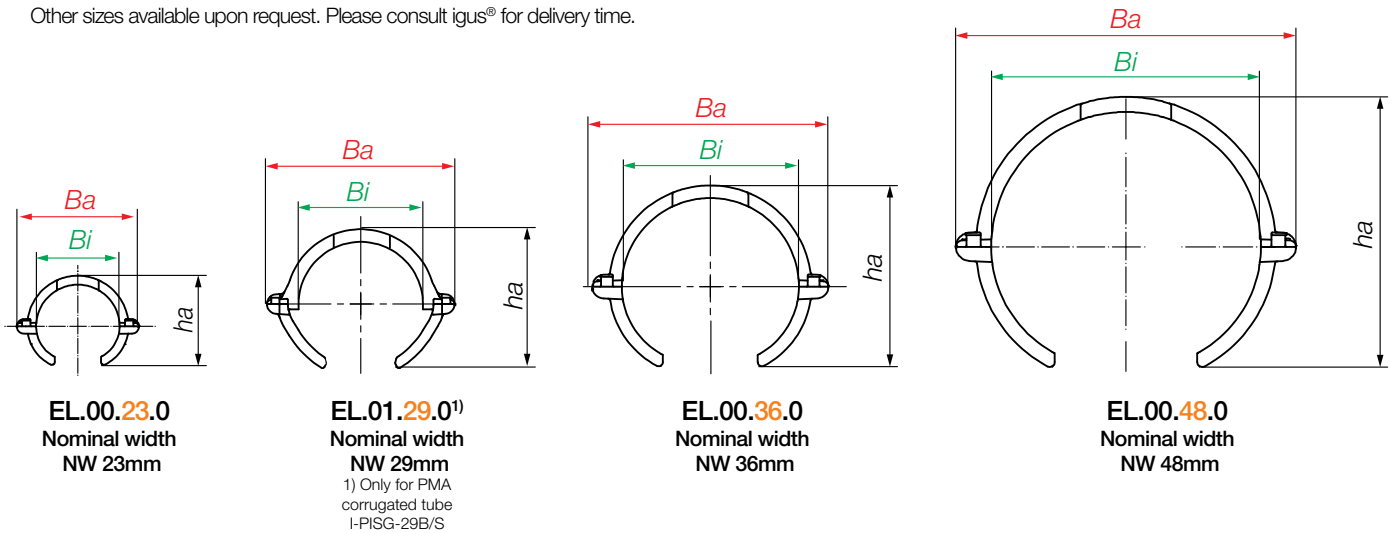

Available from stock. Orders ship as early as today.*

*On average 90% of orders ship the same day..

e-chain system® e-rib Assembly instructions



igus® delivers the required length. Any excess length can easily be cut off.



To attach the e-rib to the hose fitting, there must be no connection point on the last 7 ribs of the e-rib, otherwise the mounting bracket will not lock securely.



If necessary, cut off thicker end section and any excess length and place the two mounting brackets on the side plates.



Finally, the mounting brackets are fixed with two cable tiewraps.

Price Index



Series e-rib

Special Features / Options



Flammability Class
VDE 0304 IIC UL94 V2

Features & Benefits

- 1 Mounting bracket: connector elements for secure fixing
- 2 Additional security: retention clips for greater dynamic responsiveness
- 3 Independent of hose manufacturer:
4 sizes for nominal hose widths
NW23, NW29*, NW36 and NW48 available
*NW29 only for PMA corrugated tubes
- 4 Space-saving: less installation space required
- 5 Strong: prevents unintentional sideways movement

- 6 Easy to retrofit: simply clip onto a corrugated hose

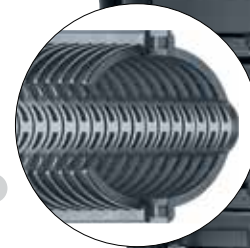

Usage Guidelines



- When low-cost corrugated tubes are used to protect and carry cables but stability must be increased
- To stabilize corrugated tubes used in highly dynamic applications
- Longer service life for cables in corrugated tubes
- 4 sizes for nominal hose widths NW23, NW29*, NW36 and NW48 available
*NW29 for PMA corrugated tubes



- When a fully enclosed, yet still openable corrugated tube is needed
➤ e-skin®, Chapter 6

Order Example: Complete E-Chain®

Please indicate chain length or number of links. Example:

3.28 ft (1 m) **EL.00.36.0**



e-rib

1 Set **EL.00.12**



Mounting Bracket

EL.00.S (Option: with 2 securing clips)

Securing Clips

MAT0170899 (Option: 1 cable tiewrap for securing clips)

Cable tiewrap

e-chain system® e-rib Reinforcement for existing corrugated tube systems



e-rib

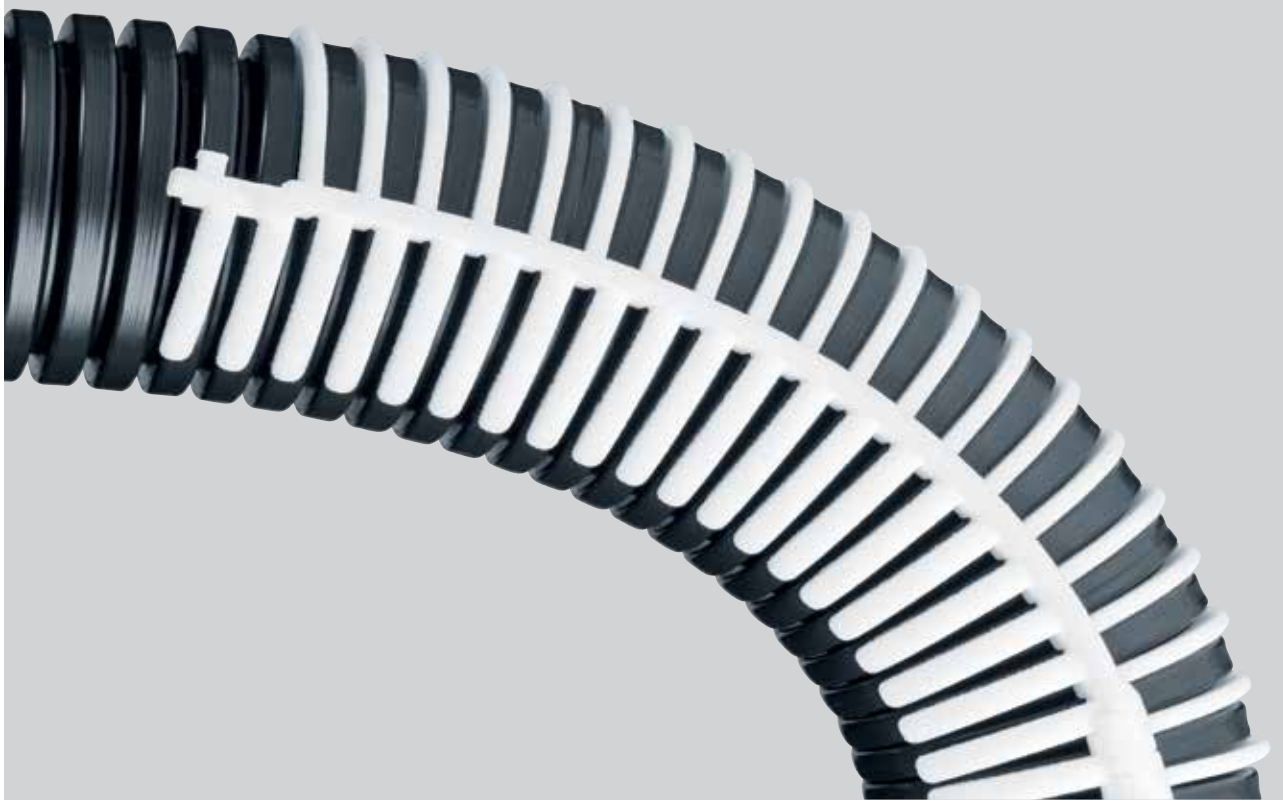

The e-rib is clipped onto the corrugated tube and stabilizes it in such a way that it can only move in one direction



More information ► www.igus.com/e-rib

PDF: www.igus.com/E-Chain-pdfs
Specs/CAD/RFG: www.igus.com/E-Chains
RoHS info: www.igus.com/RoHS



Material (E-Chain®) - permitted temperature	igumid NB / 41°F (+5°C) up to +176°F (+80° C)
Material (mounting brackets)* - permitted temperature	igumid NB / 41°F (+5°C) up to +176°F (+80° C)
Flammability Class (E-Chain®), igumid NB	VDE 0304 IIC UL94 V2

Technical Data



Details of material properties

► Chapter 1

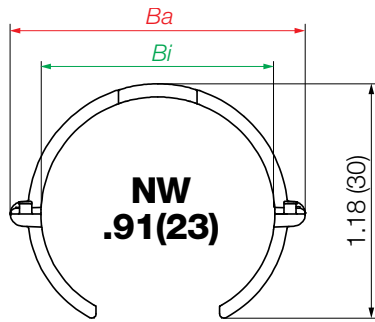

Series EL.00.23 | e-rib for corrugated tubes from different manufacturers

Part No.	NW	Bi	Ba	ha	Segments	Segment length	Weight	Mounting
e-rib	in. (mm)	in. (mm)	in. (mm)	in. (mm)	per ft. (meter)	in. (mm)	lbs/ft. (kg/m)	bracket
EL.00.23.0	.91 (23)	1.10 (28)	1.61 (41)	1.18 (30)	23 (7)	5.79 (147)	≈ (0.16)	EL.00.12

Part Number Structure

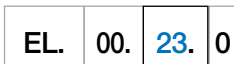

- Color - Black
- Nominal Width (NW)
- 00 for all manufacturers, 01 only for PMA
- Series e-rib

Installation dimensions and product description

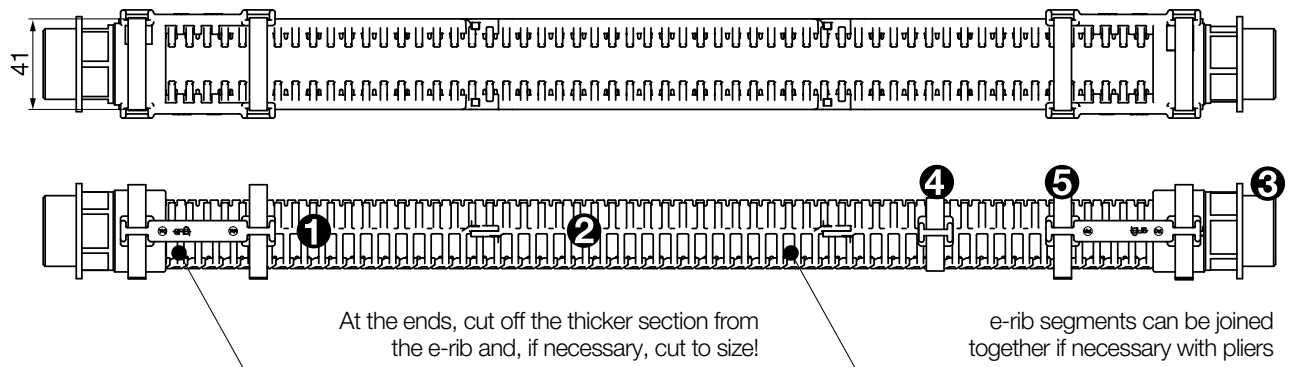

Position	Description	Part No.
①	PMA corrugated tube	I-PISG-23B
②	e-rib	EL.00.23
③	PMA connection fitting	I-BVND-M323GT
④	Securing clip, optional*	EL.00.S
⑤	Mounting bracket connection set	EL.00.12

Note: For each locking device, 2 clips EL.00.S and a cable tiewrap MAT0170899 are needed!

*Securing clips for additional attachment. They can be placed anywhere on the e-rib and fixed to the corrugated tube with a cable tiewrap.

e-chain system® e-rib
 Series EL.01.29
 Installation Dimensions



e-rib
 EL.01.29

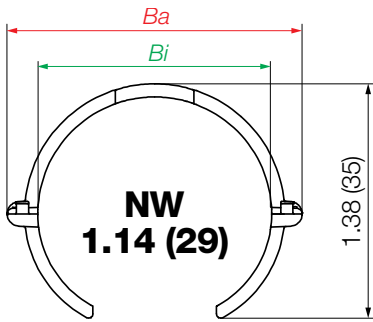

Series EL.01.29 | e-rib only for PMA corrugated tube I-PISG-29B/S

Part No.	NW	Bi	Ba	ha	Segments	Segment length	Weight	Mounting
e-rib	in. (mm)	in. (mm)	in. (mm)	in. (mm)	per ft. (meter)	in. (mm)	lbs/ft. (kg/m)	bracket
EL.01.29.0	1.14 (29)	1.06 (27)	1.75 (44.5)	1.38 (35)	32.8 (10)	3.94 (100)	≈ (0.12)	EL.01.12

Part Number Structure

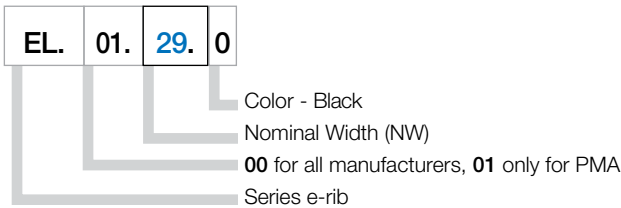

Installation dimensions and product description

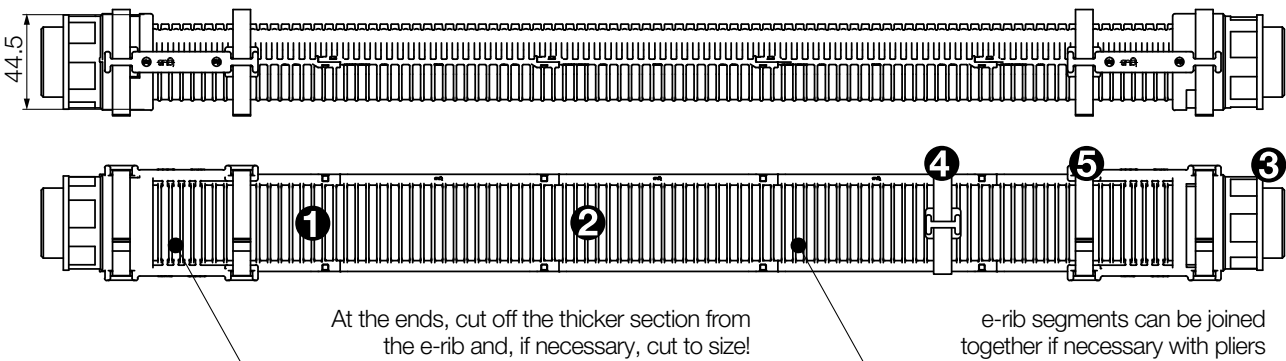

Position	Description	Part No.
①	PMA corrugated tube	I-PISG-29B
②	e-rib	EL.01.29
③	PMA connection fitting	I-BVND-M299GT
④	Securing clip, optional*	EL.01.S
⑤	Mounting bracket connection set	EL.01.12

Note: For each locking device, 2 clips EL-01-S and one cable tiewrap MAT0170899 are needed!

*Securing clips for additional attachment. They can be placed anywhere on the e-rib and fixed to the corrugated tube with a cable tiewrap.

PDF: igus.com/e-chain-pdfs
 Product information: igus.com/e-chains



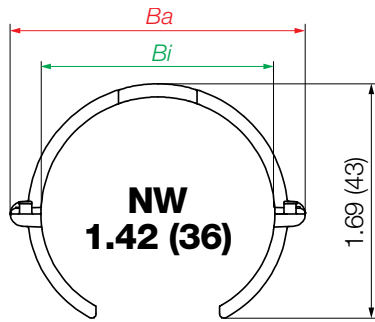

Series EL.00.36 | e-rib for corrugated tubes from different manufacturers

Part No.	NW	Bi	Ba	ha	Segments	Segment length	Weight	Mounting
e-rib	in. (mm)	in. (mm)	in. (mm)	in. (mm)	per ft. (meter)	in. (mm)	lbs/ft. (kg/m)	bracket
EL-00.36.0	1.42 (36)	1.65 (42)	2.20 (56)	1.69 (43)	23 (7)	5.79 (147)	≈ (0.22)	EL.00.12

Part Number Structure

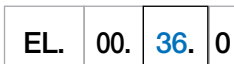

- Color - Black
- Nominal Width (NW)
- 00 for all manufacturers, 01 only for PMA
- Series e-rib

Installation dimensions and product description

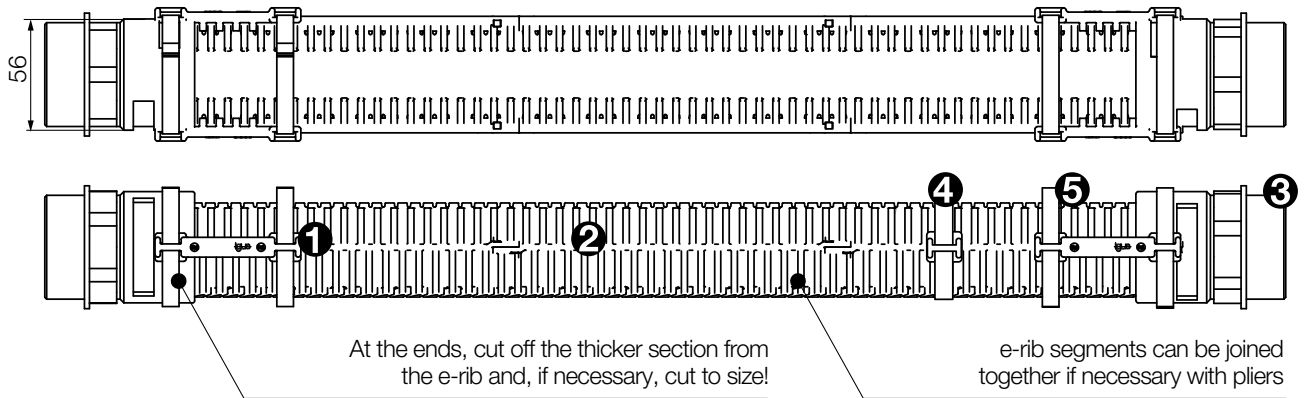

Position	Description	Part No.
①	PMA corrugated tube	I-PISG-36B
②	e-rib	EL.00.36
③	PMA connection fitting	I-BVND-M506GT
④	Securing clip, optional*	EL.00.S
⑤	Mounting bracket connection set	EL.00.12

Note: For each locking device, 2 clips EL-00-S and a cable tiewrap MAT0170899 are needed!

*Securing clips for additional attachment. They can be placed anywhere on the e-rib and fixed to the corrugated tube with a cable tiewrap.

e-chain system® E-Z chain
 Series EL.00.48
 Installation Dimensions



e-rib
 EL.00.48

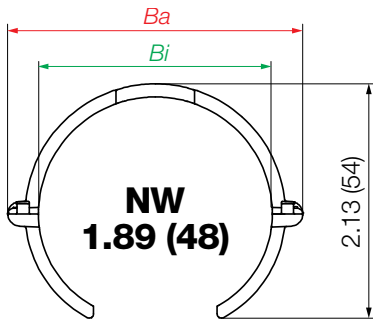

Series EL.00.48 | e-rib for corrugated tubes from different manufacturers

Part No.	NW	Bi	Ba	ha	Segments	Segment length	Weight	Mounting
e-rib	in. (mm)	in. (mm)	in. (mm)	in. (mm)	per ft. (meter)	in. (mm)	lbs/ft. (kg/m)	bracket
EL.00.48.0	1.89 (48)	2.13 (54)	2.68 (68)	2.13 (54)	23 (7)	5.79 (147)	≈ (0.27)	EL.00.12

Part Number Structure

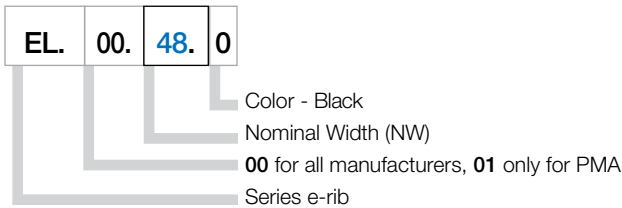

Installation dimensions and product description

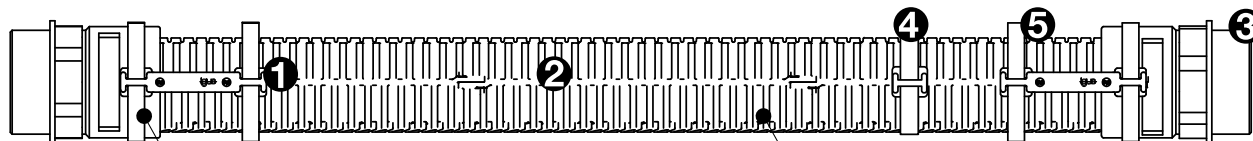
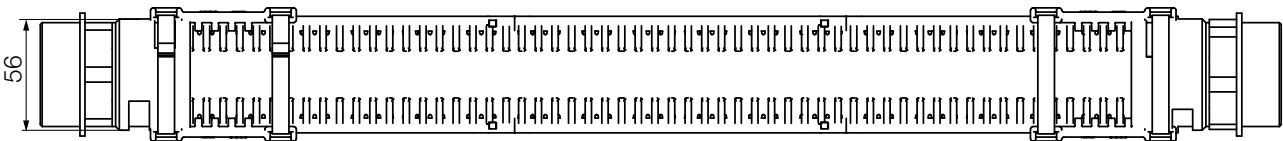

At the ends, cut off the thicker section from the e-rib and, if necessary, cut to size!

e-rib segments can be joined together if necessary with pliers

Position	Description	Part No.
①	PMA corrugated tube	I-PISG-48B
②	e-rib	EL.00.48
③	PMA connection fitting	I-BVND-M508GT
④	Securing clip, optional*	EL.00.S
⑤	Mounting bracket connection set	EL.00.12

Note: For each locking device, 2 clips EL-00-S and a cable tiewrap MAT0170899 are needed!

*Securing clips for additional attachment. They can be placed anywhere on the e-rib and fixed to the corrugated tube with a cable tiewrap.

PDF: igus.com/e-chain-pdfs
 Product information: igus.com/e-chains



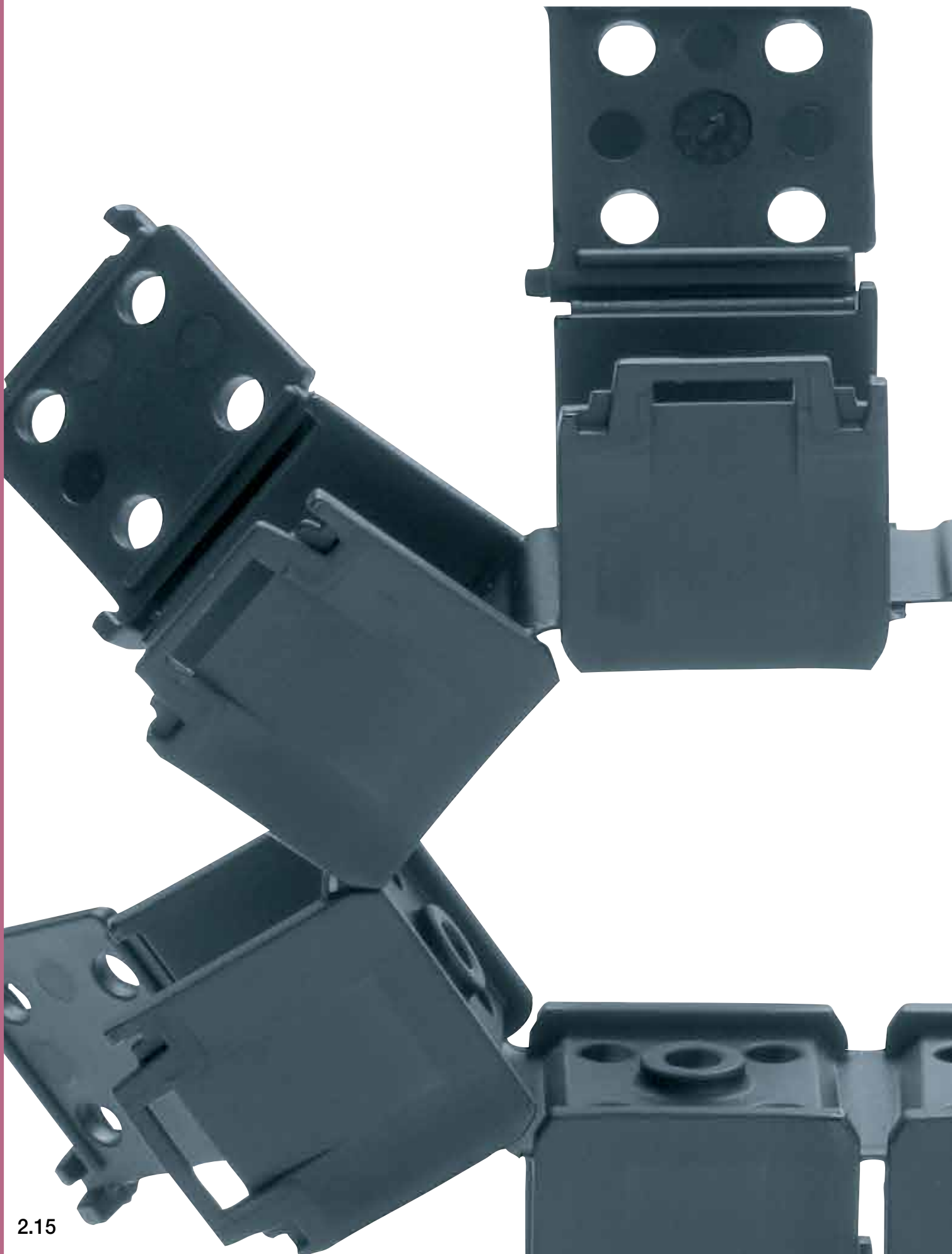

igus[®]

System E-1

e-chain[®] Band, Modular



E1- Modular, one-piece strip design for simple applications

E1: e-chain® modular, 1-piece strip designed for simple applications - The E1 design brings the benefits of an e-chain® to applications where this solution previously was too expensive. E1 is more economic for higher volumes, quicker to assemble and still offers great control and protection for moving cables. The igus® System E1 is very cost effective for high volumes and is especially ideal for automotive applications.

Typical industries and applications

- Automotive
- Office Solutions and technology
- Automation
- Electric equipment
- Machine-building



UL94-V2
classifications

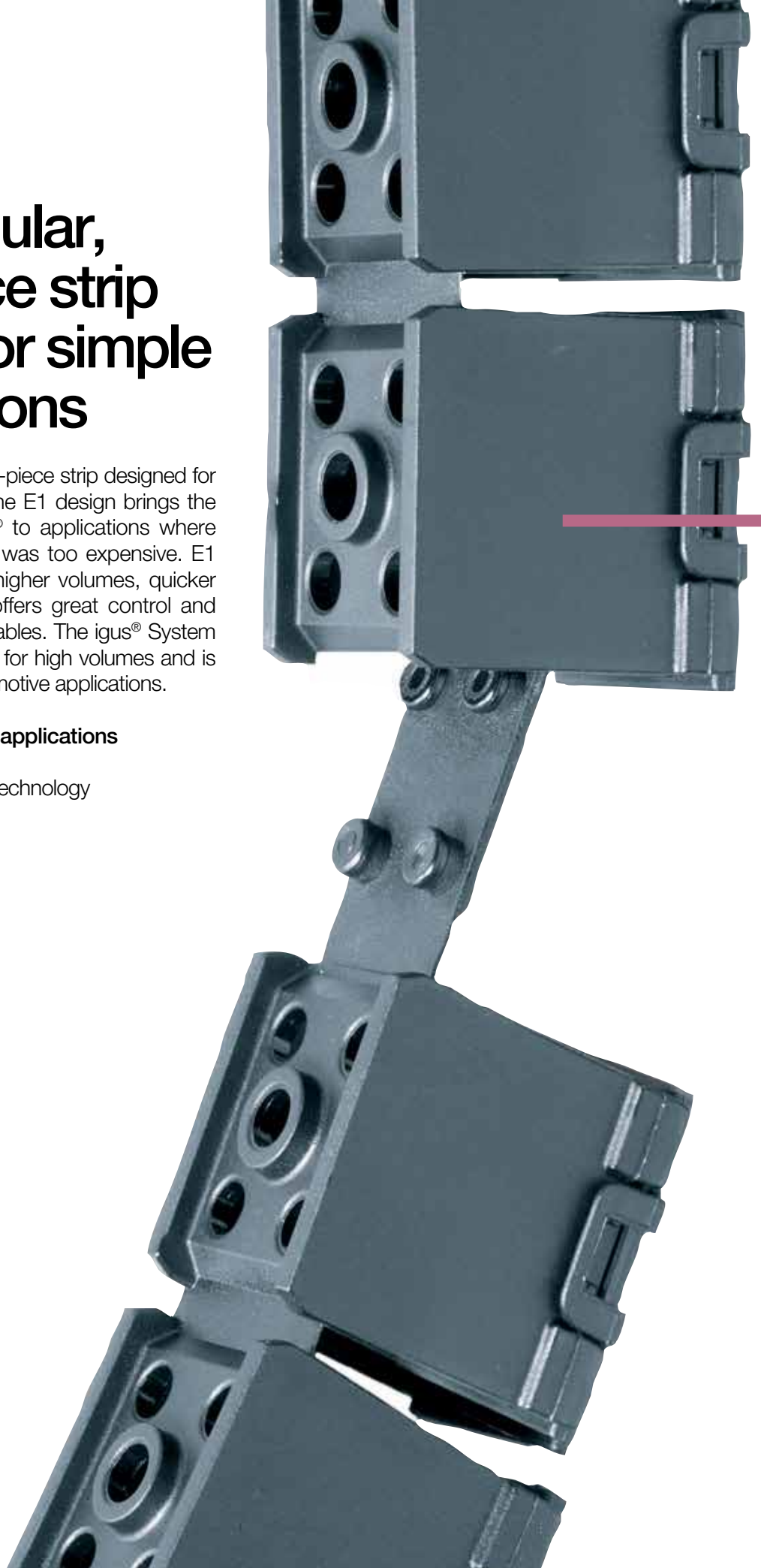

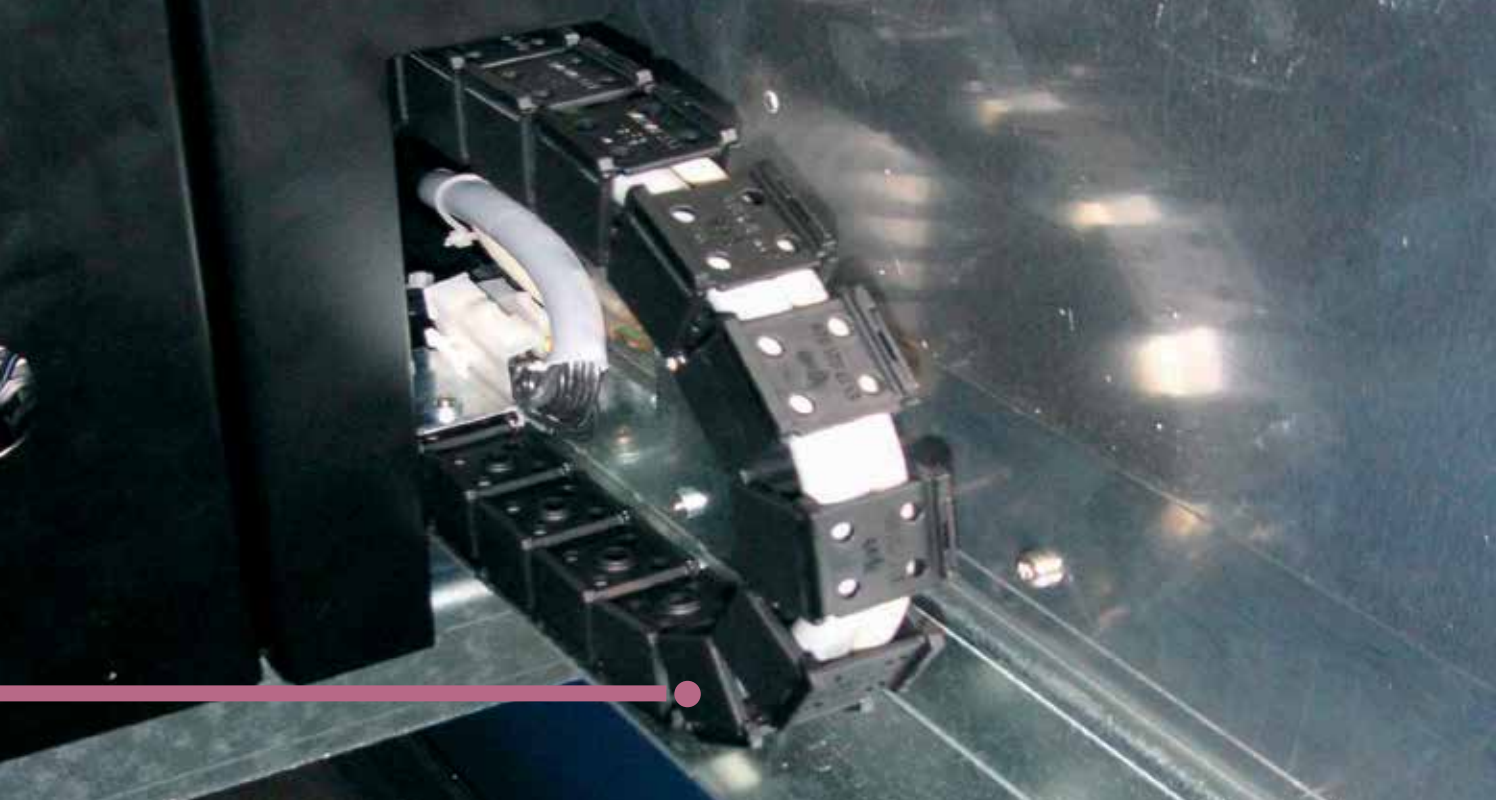

Harnessed igus® System E1 in a bottle deposit machine



Series E1-17-021-028 in an electric wheelchair - cable supply on the scissor lifting system



The igus®-System E1 is very cost-effective at high quantities and ideal for automotive applications

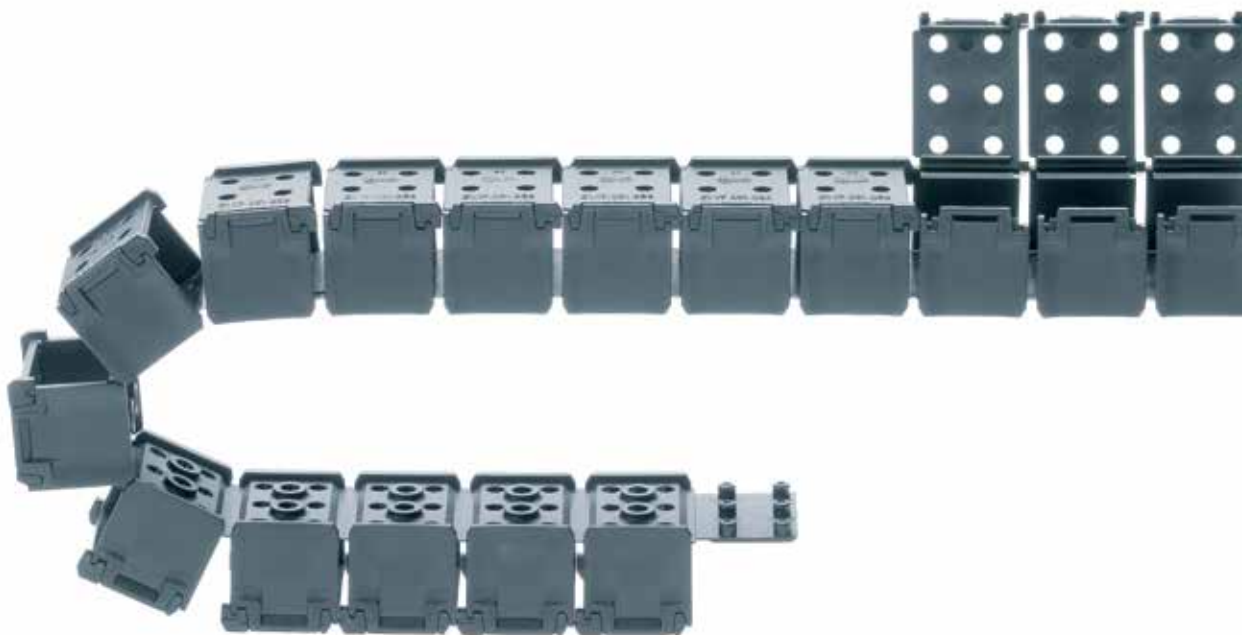

e-chain system® System E1

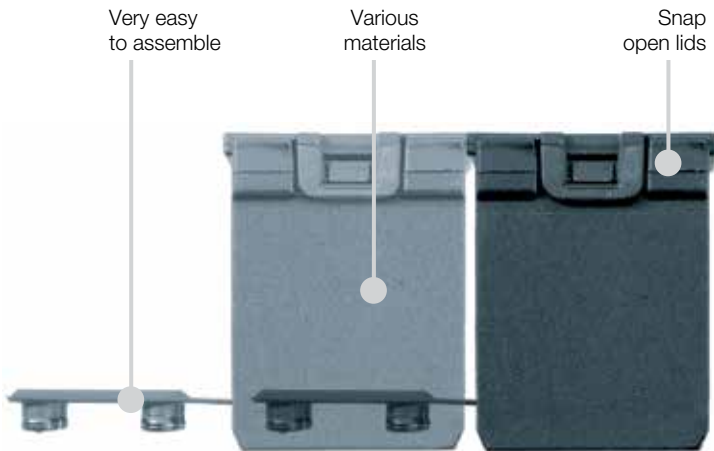

Modular, 1-piece strip design for simple applications

- Economic solution for high volumes
- A universal and easily adaptable e-chain® concept
- E1: e-chain® on one strip
- Easy shortening/lengthening through modular strip design
- Easy to snap open
- Strip connectors
- Easy attachment at each end
- Various materials available
- You can find more technical data about the material, chemical resistance, temperatures

► Design, Chapter 1

Series	Inner height <i>hi</i>		Inner width <i>Bi</i>		Outer width <i>Ba</i>		Outer height <i>ha</i>		Bending radius <i>R</i>		Segment length mm
	in.	(mm)	in.	(mm)	in.	(mm)	in.	(mm)	in.	(mm)	
E1-10-013-	.39	10	.51	13	.65	16.5	.61	15.5	.71	18	200
E1-17-021-	.67	17	.83	21	1.02	26	.98	25	1.10	28	255
E1-17-031-	.67	17	1.22	31	1.42	36	.98	25	1.10	28	204
E1-17-044-	.67	17	1.73	44	1.93	49	.98	25	1.10	28	255
E1-18-015-	.71	18	.59	15	.79	20	1.02	26	1.10	28	127.5
E1-20-015-	.79	20	.59	15	.87	22	1.06	27	1.10	28	250



System E1 - e-chain® - snap-open along outer radius



Available from stock. Orders ship as early as today.*

*On average 90% of orders ship the same day..

Shortening

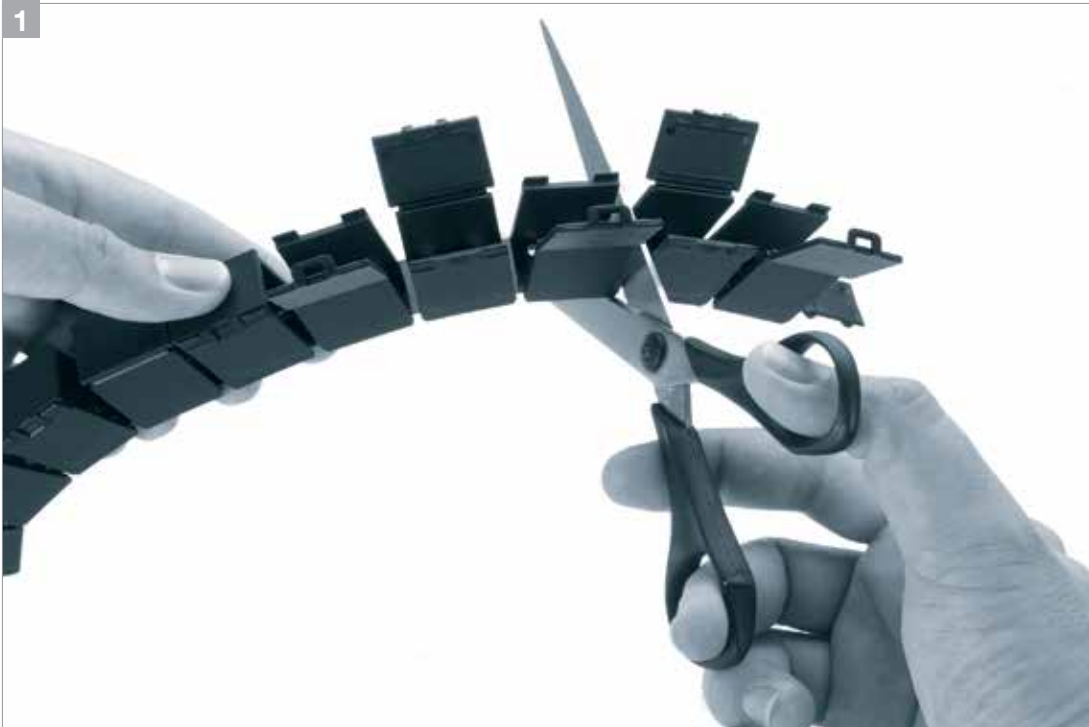

System E1 - e-chain on a strip - easy to shorten ...

Lengthening



... and to lengthen

Price Index

Series E1
Special Features / Options

Flammability Class
VDE 0304 IIC UL94 V2
Features & Benefits

- 1 Easy to shorten - separation at each segment
- 2 Very easy to fill because of snap-open lids
- 3 Easy to lengthen - strips can simply be snapped together
- 4 Easy fastening through integrated mounting holes
- 5 Low-price e-chain®
- 6 Different materials and colors available upon request
- 7 Compact design with smooth outer contour
- 8 Strain relief option (clip-on bracket)
- 9 All lids snap open for easier filling

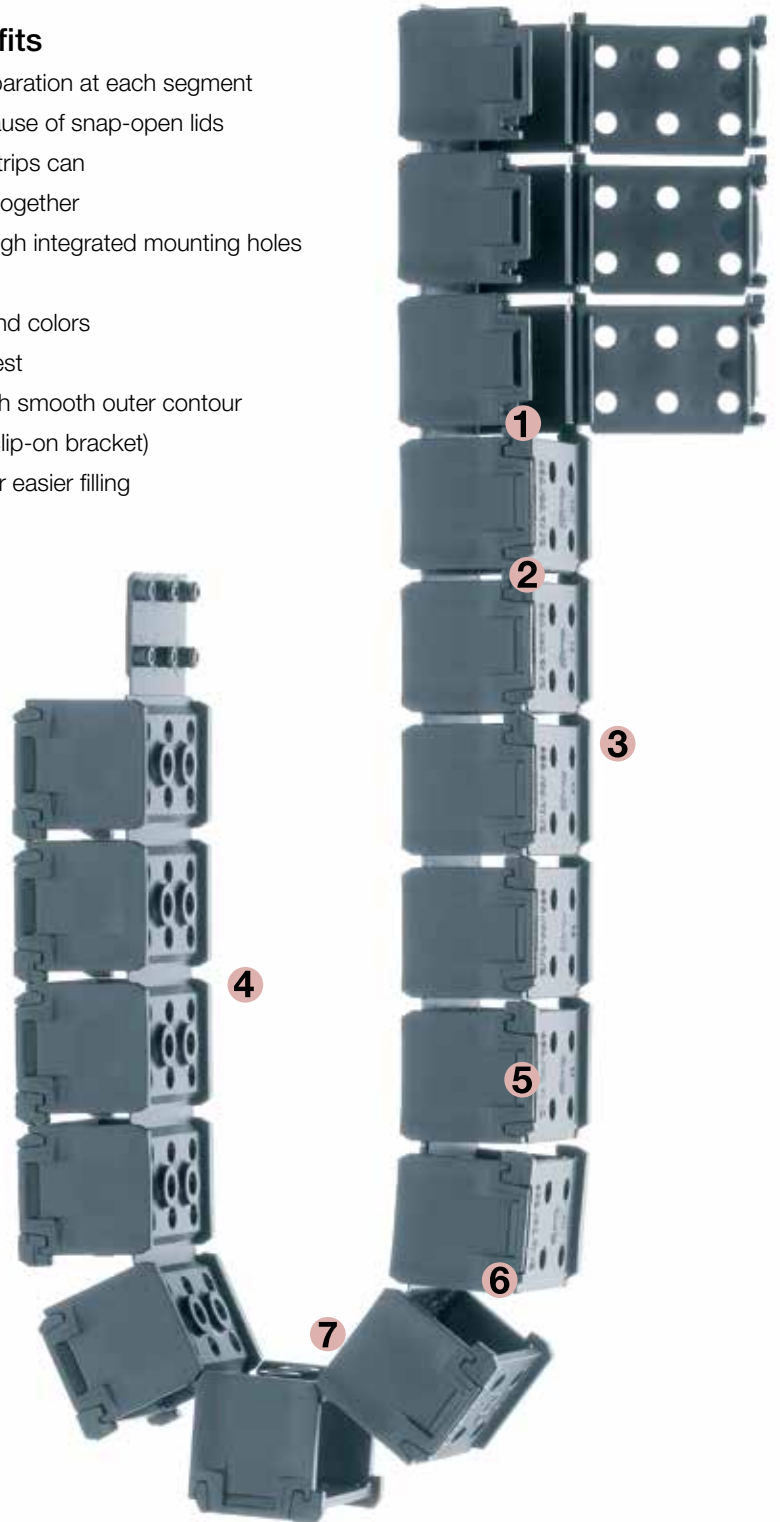
Usage Guidelines

- If simple filling is required
- If an economical e-chain® is required
- If low assembly cost is required
- For lower duty or cycle life



- High load or high cycle applications
 - **Series E-Z chain**
 - **Series Zipper**

Order Example: Complete e-chain®

Please indicate chain length or number of links. Example:

 3.28 ft (1 m) **E1-17-021-028-0** = 4 x 10.04" (255 mm) band

e-chain®

e-chain system® E1

Series E1-10, E1-17, E1-18, E1-20

Installation Dimensions



E1

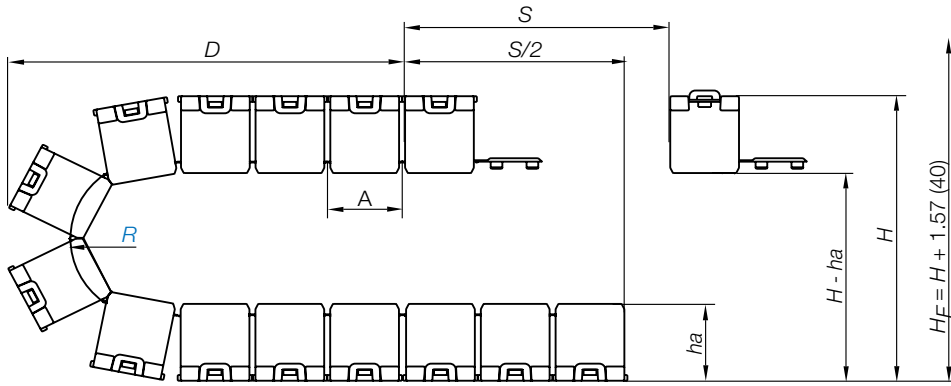

The required clearance height: $H_F = H + 1.57$ in. (40 mm)

Bending Radius for Series	E1-10	E1-17	E1-18	E1-20
R	.71 (018)	1.10 (028)	1.10 (028)	1.10 (028)
H	2.44 (62)	3.62 (92)	3.62 (92)	3.62 (92)
D	2.60 (66)	2.99 (76)	2.99 (76)	2.99 (76)
K	3.94 (100)	4.72 (120)	4.72 (120)	4.72 (120)

Short Travels - Unsupported



Unsupported E-Chains® feature positive camber over short travels. This must be accounted for when specifying the clearance height. Please refer to **Installation dimensions** for further details.

Legend

- S = Length of travel
- R = Bending radius
- H = Nominal clearance height
- D = Overlength e-chain® radius in final position
- $K = \pi \cdot R + \text{safety buffer}$
- H_r = Required clearance height

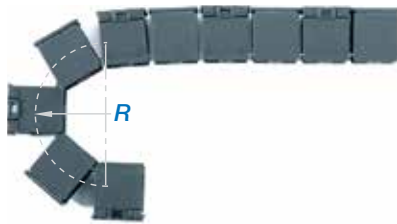

Part No. structure

E1-17-021-028-0

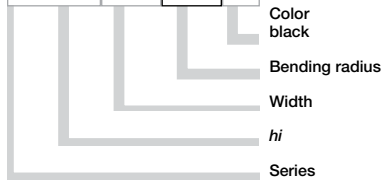

PDF: igus.com/e-chain-pdfs
Product information: igus.com/e-chains



Material (e-chain®) - permitted temperature °F application oriented, upon request
 Flammability Class (e-chain®), igumid NB VDE 0304 IIC UL94 V2

Technical Data



Details of material properties

► Chapter 1

Series E1-10 - Snap-open along the outer radius

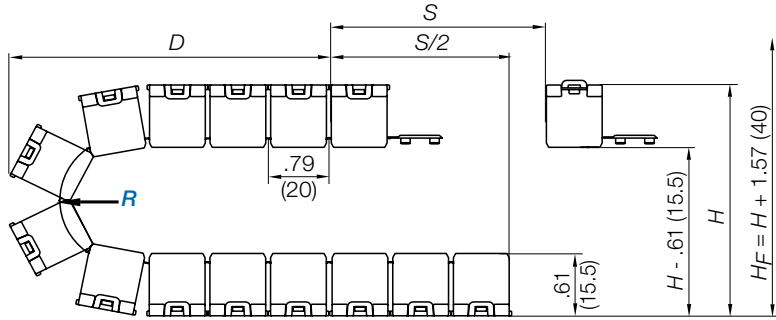
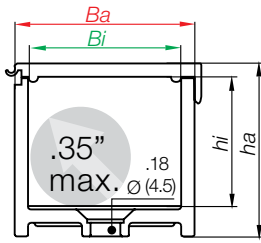

Pitch per link = .79" (20 mm)
Chain length = $\frac{S}{2} + K$

Supplement part number with required radius. Example: E1-10-013-**018**-0
Pitch: .79 in. (20 mm) per link

Part Number	Bi in. (mm)	Ba in. (mm)	Weight lbs/segment (kg/segment)
E1-10-013- <input type="text"/> -0	.20 (13)	.34 (16.5)	≈ 0.0362 (0.0164)
Choose from the radii below for the above size			
Radius (mm) Example: E1-10-013- 018 -0			

018	.71 (018)
R	.71 (018)
H	2.44 (62)
D	2.60 (66)
K	3.94 (100)

0=Standard color black. For other colors see Chapter 1

Part Number	Segment Length Dimension A mm	No. of links/segment	No. of segments/m
E1-10-013-018-0	200	10	5 (1000 mm)

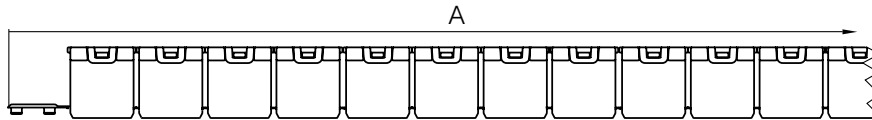

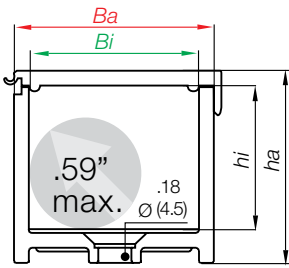

Series E1-17 - Snap-open along the outer radius

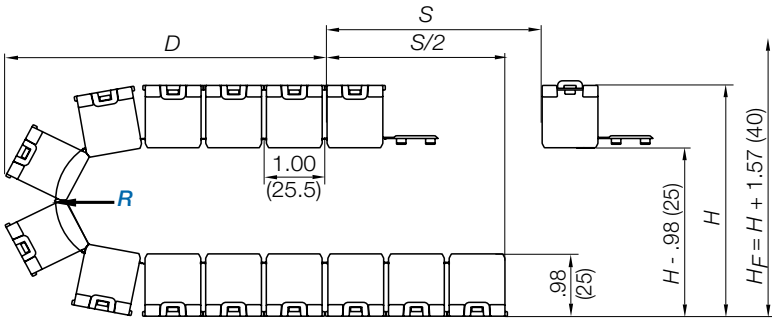

Pitch per link = 1.00" (25.5 mm)
Chain length = $\frac{S}{2} + K$

Supplement part number with required radius. Example: E1-17-021-**028**-0
Pitch: 1.00 in. (25.5 mm) per link

Part Number	Bi in. (mm)	Ba in. (mm)	Weight lbs/segment (kg/segment)
E1-17-021- <input type="text"/> -0	.83 (21)	1.02 (26)	≈ 0.1054 (0.0478)
E1-17-031- <input type="text"/> -0	1.22 (31)	1.42 (36)	≈ 0.1014 (0.0460)
E1-17-044- <input type="text"/> -0	1.73 (44)	1.93 (49)	≈ 0.1532 (0.0695)

Choose from the radii below for the above size
Radius (mm) Example: E1-17-021-**028**-0

R	1.10 (028)	0=Standard color black. For other colors see Chapter 1
H	3.62 (92)	
D	2.99 (76)	
K	4.72 (120)	

Part Number	Segment Length Dimension A mm	No. of links/segment	No. of segments/m
E1-10-021-028-0	255	10	4 (1020 mm)
E1-17-031-028-0	204	8	5 (1020 mm)
E1-17-044-028-0	255	10	4 (1020 mm)

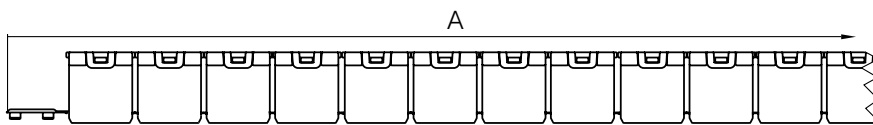

Mounting brackets for the Series E1-17-021



Compact, universal mounting bracket for E1-17-021: Part No. E1-170-021-TS - easy attachment



Series E1-10 - Snap-open along the outer radius

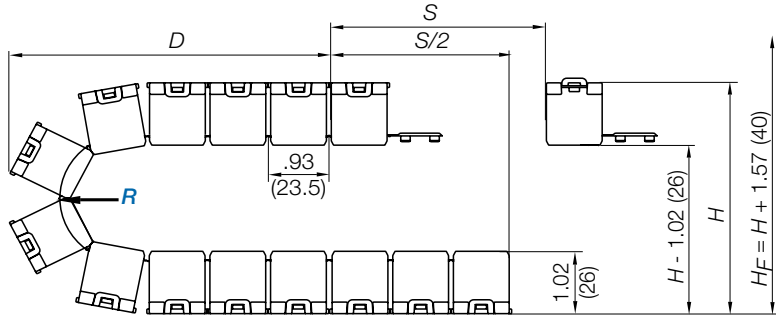
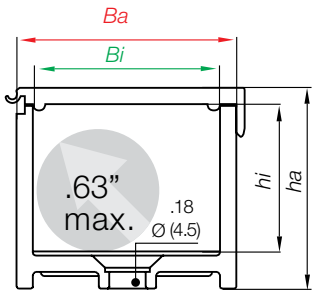

Pitch per link = .99" (25.25 mm)
Chain length = $\frac{S}{2} + K$

Supplement part number with required radius. Example: E1-18-015-**028**-0
Pitch: .93 in. (23.5 mm) per link

Part Number	<i>Bi</i> in. (mm)	<i>Ba</i> in. (mm)	Weight lbs/segment (kg/segment)
E1-18-015- <input type="text"/> -0	.59 (15)	.79 (20)	≈ 0.0373 (0.0169)
Choose from the radii below for the above size			
<i>Radius</i> (mm) Example: E1-18-015- 028 -0			

<i>R</i>	1.10 (028)
<i>H</i>	3.62 (92)
<i>D</i>	2.99 (76)
<i>K</i>	4.72 (120)

0=Standard color black. For other colors see Chapter 1

Part Number	Segment Length Dimension A mm	No. of links/segment	No. of segments/m
E1-18-015-028-0	101	4	10 (1010 mm)

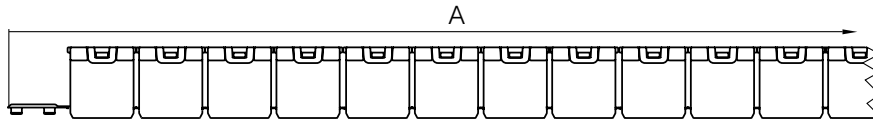

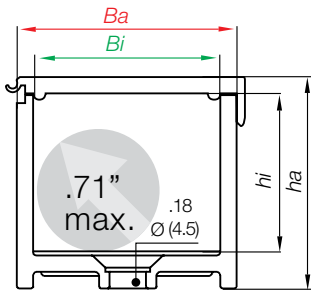

Series E1-20 - Snap-open along the outer radius
 Lids open in alternate directions

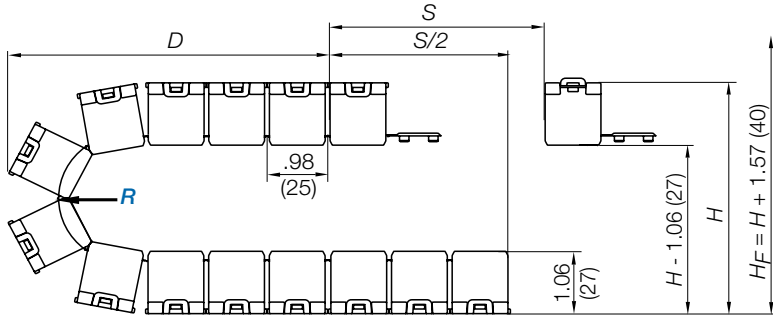

Pitch per link = .98" (25 mm)
 Chain length = $\frac{S}{2} + K$

Supplement part number with required radius. Example: E1-20-015-028-0
 Pitch: .98 in. (25 mm) per link

Part Number	Bi in. (mm)	Ba in. (mm)	Weight lbs/segment (kg/segment)
E1-20-015- -0	.59 (15)	.87 (22)	≈ 0.0977 (0.0443)

Choose from the radii below for the above size

Radius (mm) Example: E1-20-015-028-0

R	1.10 (028)	0=Standard color black. For other colors see Chapter 1
H	3.62 (92)	
D	2.99 (76)	
K	4.72 (120)	

Part Number	Segment Length Dimension A mm	No. of links/segment	No. of segments/m
E1-20-015-028-0	250	10	4 (1000 mm)

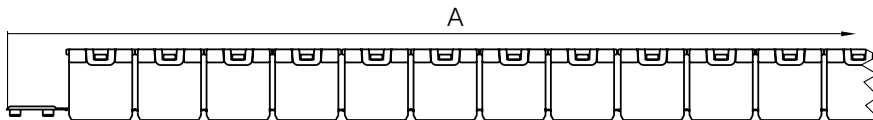



igus[®] snapchain

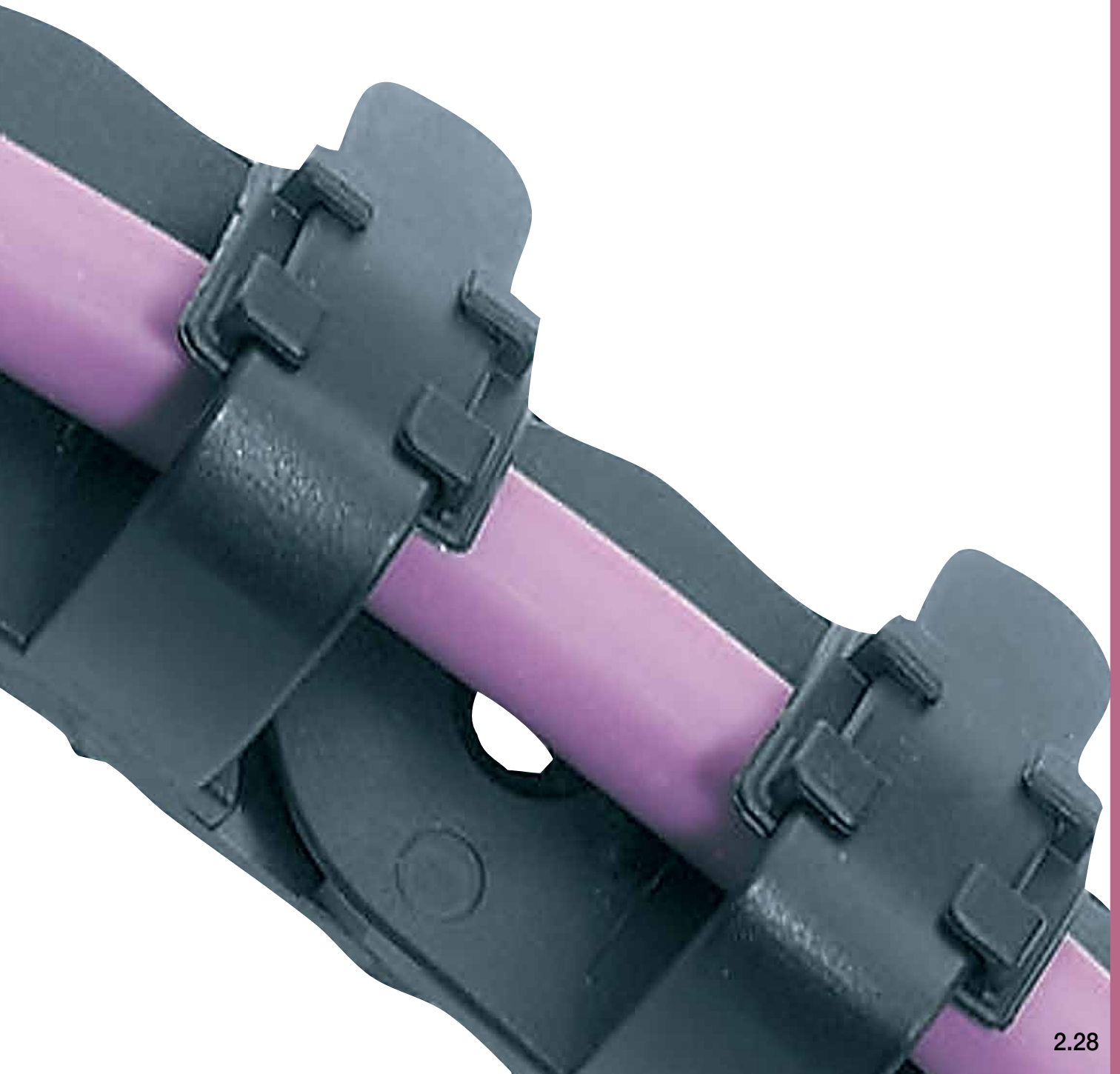

Save time:
Fit cable assemblies quickly in bunches,
available in 2 sizes

Flexible:
Adjust and change
cables at any time

Opening principle:
Version TE14/TE26 can
be opened along the outer and
TZ14/TZ26 can be opened along the
inner radius

Simple:
Favorable alternative to
complex hinged cable trays

Short lengths:
Well-suited to short
lengths, ideally 5 - 10 links

Flexible:
Can be bent in
1 or 2 directions



Fit cable assemblies quickly in bunches - snapchain

igus® snapchain is an economical e-chain® for low-duty applications. Tubes are easy to assemble and cost-effective. An ideal solution for less demanding applications.

Typical industries and applications

- Control cabinets
- Electrical equipment
- Computer cubicles
- Office furniture
- Wherever cables are moved infrequently



e-chain system® - snapchain
Series TE-14/TZ-14, TE-26/TZ-26
Product Range



Version TE -

Loops to be opened along the outer radius

Version TZ -

Loops to be opened along the inner radius

Series	Loop length		Pitch		Bending radius <i>R</i>	
	in.	(mm)	in.	(mm)	in.	(mm)
TE14-50	1.97	(50)	1.20	(30.5)	1.10 - 4.92	(028-125)
TE26-120	4.72	(120)	2.20	(56)	2.48 - 7.87	(063-200)
TZ14-50	1.97	(50)	1.20	(30.5)	1.10 - 4.92	(028-125)
TZ26-120	4.72	(120)	2.20	(56)	2.48 - 7.87	(063-200)

Material (e-chain®) - permitted temperature °F -40°F up to +176°F (-40°C up to +80°C)

Flammability Class (e-chain®), igumid NB VDE 0304 IIC UL94 V2

Technical Data



Details of material properties

► Chapter 1

Order example | Order key and color options based on Series TE26.



Order example for complete e-chain® 3.28 ft. (1.0 m), color black:

e-chain® 3.28 ft. (1.0 m) Please indicate chain-lengths or number of links

Order text: 1.0 m TE26-120-100-0

Part No. Structure

TE26-120-100-0

Version TE to be opened along the outer radius

TZ26-120-100-0

Version TZ to be opened along the inner radius



Color index (standard black)

Bending radius *R*

Length of loops

Series / Type

Version "TE" or "TZ"



Available from stock. Orders ship as early as today.*

*On average 90% of orders ship the same day..



Opens along the outer radius

Part Number	Weight lbs/ft (kg/m)
TE14-50- <input type="text"/> -0	≈ 0.1008 (0.15)
Choose from the radii below for the above size	
<i>Radius (mm)</i> Example: TE14-50- <input type="text"/> -0	
<input type="text"/>	<input type="text"/>
<input type="text"/>	<input type="text"/>
<input type="text"/>	<input type="text"/>
<input type="text"/>	<input type="text"/>
<input type="text"/>	<input type="text"/>
<input type="text"/>	<input type="text"/>
<i>R</i>	<i>R</i>
1.10 (028)	1.50 (038)
1.89 (048)	2.95 (075)
3.94 (100)	4.92 (125)

0 = Standard color black.
For other colors see Chapter 1

Opens along the inner radius

Part Number	Weight lbs/ft (kg/m)
TZ14-50- <input type="text"/> -0	≈ 0.1008 (0.15)
Choose from the radii below for the above size	
<i>Radius (mm)</i> Example: TE14-50- <input type="text"/> -0	
<input type="text"/>	<input type="text"/>
<input type="text"/>	<input type="text"/>
<input type="text"/>	<input type="text"/>
<input type="text"/>	<input type="text"/>
<input type="text"/>	<input type="text"/>
<input type="text"/>	<input type="text"/>
<i>R</i>	<i>R</i>
1.10 (028)	1.50 (038)
1.89 (048)	2.95 (075)
3.94 (100)	4.92 (125)

0 = Standard color black.
For other colors see Chapter 1

Dimensions

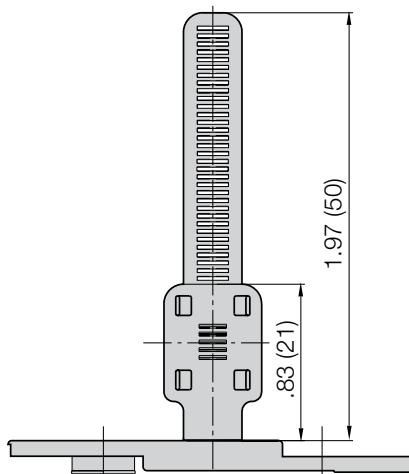
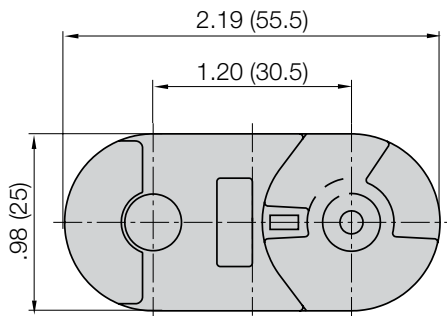

Pitch per link = 1.20" (30.5 mm)
Links per ft (m) = 10 (33)
Chain length = $\frac{s}{2} + K$

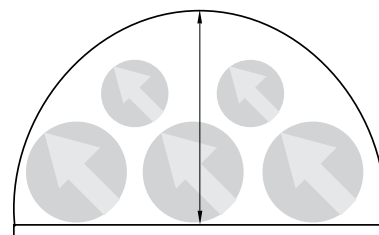

Cable package max.: 18 mm

e-chain system® - snapchain
 Series TE-26, TZ-26
 Product Range



TE-26
 TZ-26



Opens along the outer radius

Part Number	Weight lbs/ft (kg/m)
TE26-120- <input type="text"/> -0	≈ 0.2889 (0.43)
Choose from the radii below for the above size	
Radius (mm) Example: TE14-50- <input type="text"/> 028-0	
063	075
100	125
150	200
2.48 (063)	2.95 (075)
3.94 (100)	4.92 (125)
5.91 (150)	7.87 (200)

0 = Standard color black.
 For other colors see Chapter 1

Opens along the inner radius

Part Number	Weight lbs/ft (kg/m)
TZ26-120- <input type="text"/> -0	≈ 0.2889 (0.15)
Choose from the radii below for the above size	
Radius (mm) Example: TE14-50- <input type="text"/> 028-0	
063	075
100	125
150	200
2.48 (063)	2.95 (075)
3.94 (100)	4.92 (125)
5.91 (150)	7.87 (200)

0 = Standard color black.
 For other colors see Chapter 1

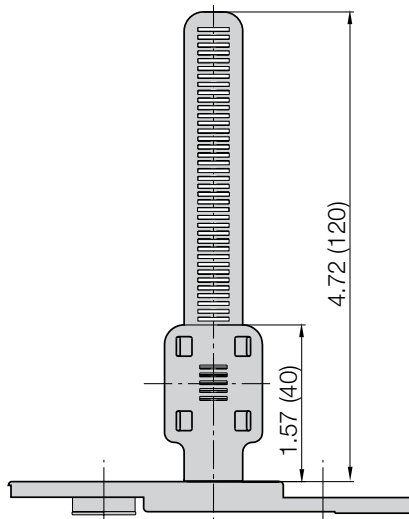
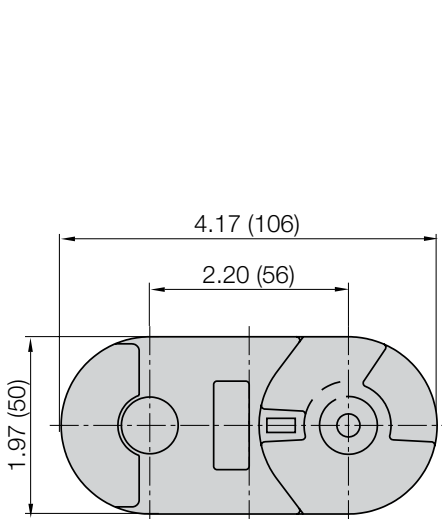

Pitch per link = 2.20" (56 mm)
 Links per ft (m) = 5.45 (18)
 Chain length = $\frac{s}{2} + K$

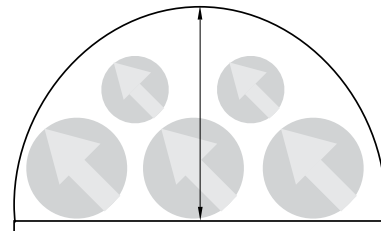

Cable package max.: 47 mm

PDF: igus.com/e-chain-pdfs
 Product information: igus.com/e-chains





igus[®] office e-chain[®]



Energy supply for offices and furniture - office e-chain®

Cables fitted quickly, e-chain® attached quickly, attractive design, nice and tidy. This e-chain® was designed and developed especially for the furniture industry.

- Aesthetic design
- Closed outer contours (half-tube)
- Mounting brackets easy to clip on
- Easy to fill, even when installed with “easy” design
- Cable-friendly due to smooth interior
- UL94-V2 certified
- Mounting brackets can be either screwed or bonded thanks to the large flat surface on the bottom

Typical industries and applications

- Electrically adjustable furniture
- Miscellaneous applications without highly dynamic movements





Insert cables quickly and easily with the office e-chain®, the energy supply for offices and furniture

New: OCR office e-chain® - tidy loose cables quickly and easily

- Movable in all axes, round and square versions
- Simply press in or pull out cables with "easy" design
- Mounting brackets with magnets for easy attachment in seconds
- Flexible fitting

Upon request, more information

► www.igus.com/OCR

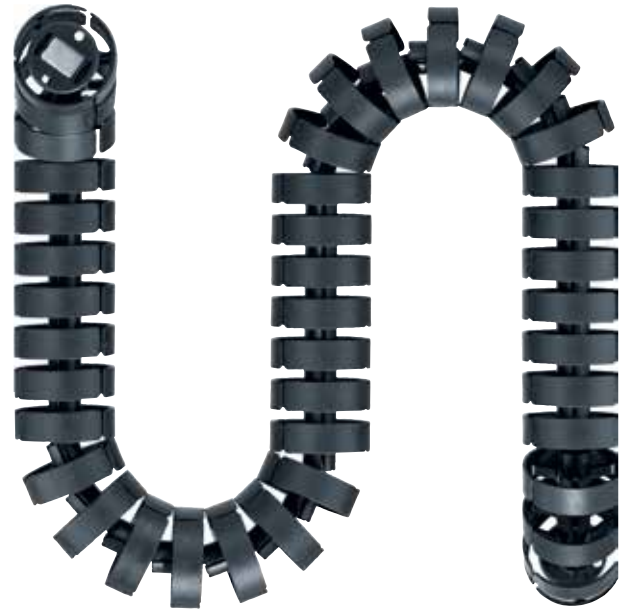

reddot design award
winner 2018



Available from stock. Orders ship as early as today.*

*On average 90% of orders ship the same day..

Price Index

Series ZF14

Special Features / Options

 Flammability Class
 VDE 0304 IIC UL94 V2

Features & Benefits

- 1 Mounting brackets: the e-chain[®] is easily clipped on
- 2 Stylishly simple: designed and developed especially for the furniture industry
- 3 Save time: simply press cables in, with “easy” design
- 4 Abrasion-optimized: cable-friendly due to smooth interior
- 5 Strong: prevents unintentional sideways movement
- 5 Protected: closed on the outside for cable protection and concealment
- 5 Colors: different colors available upon request

Usage Guidelines

- Aesthetic design
- Closed outer contours (half tube)
- Easy to fill, even when installed
- Cable-friendly due to smooth interior
- Mounting brackets can either be screwed or bonded due to the large flat bottom surface



- When an unsupported application is required
 - **E-Z chain, Chapter 2**
- Where small semi-static applications are required
 - **E1, Chapter 2**
- When a multi-axis solution is desired
 - **OCR office e-chain[®],**
 - **www.igus.com/OCR**

Order Example: Complete E-Chain[®]

Please indicate chain length or number of links. Example:

3.28 ft (1 m) **ZF14-038-028-0****e-chain[®]**1 Set **ZF114-038-12****Mounting Bracket**

e-chain system® office e-chain®
 Series ZF14
 Installation Dimensions



ZF14

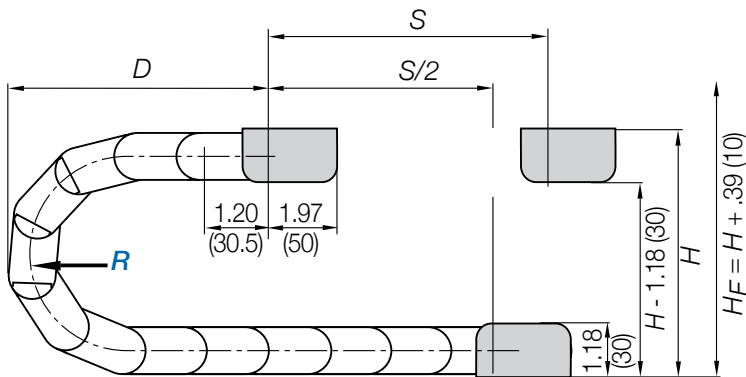
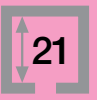

Pitch per link = 1.20" (30.5 mm)
 Links per ft (m) = 10 (33)
 For center mount applications:
 Chain length = $\frac{S}{2} + K$

The required clearance height: $H_r = H + .39$ in. (10 mm) (with .13 lbs/ft (0.2 kg/m) fill weight).
 Please consult igus® if space is particularly restricted.

R	1.10 (028)
H*	3.39 (86)
D	4.59 (116.5)
K	8.31 (211)



Part Number Structure

ZF14-038-028-0

- Color - Black
- Bending radius
- Width (depends on Bi)
- Series

Version ZF14 | "easy" design, split crossbar along the inner radius

Part No.	Bi	Ba	R Available bending radius	Weight
e-chains®	in. (mm)	in. (mm)	in. (mm)	lbs/ft. [kg/m]
ZF14-038-028-0	1.50 (38)	1.83 (46.6)	1.10 (028)	≈ 0.200 (0.297)

Complete Part No. with required radius (R). Example: ZF14-038-028-0

Material (E-Chain®) - permitted temperature	igumid NB / -40°F (-40°C) up to +176°F (+80° C)
Material (mounting brackets)* - permitted temperature	igumid G / -40°F (-40°C) up to +248°F (+120° C)
Flammability Class (E-Chain®), igumid NB	VDE 0304 IIC UL94-HB
Flammability Class (Mounting brackets), igumid G	VDE 0304 IIC UL94 V2

Technical Data



Details of material properties

► Chapter 1

PDF: www.igus.com/E-Chain-pdfs
 Specs/CAD/RFQ: www.igus.com/E-Chains
 RoHS info: www.igus.com/RoHS



ZF114 ... 1 **ZF114 ... 1**

Part No. ZF114-038-12 -
consisting of 2 x ZF114-038-1

Width index	Part No. full set	A in. (mm)	B in. (mm)
-038	ZF114-038-12	2.03 (51.6)	1.97 (50)

Suitable mounting bracket for moving and fixed ends

Mounting brackets for easy fitting to furniture.
Can be easily detached and re-attached.





PDF: www.igus.com/E-Chain-pdfs
Specs/CAD/RFQ: www.igus.com/E-Chains
RoHS info: www.igus.com/RoHS



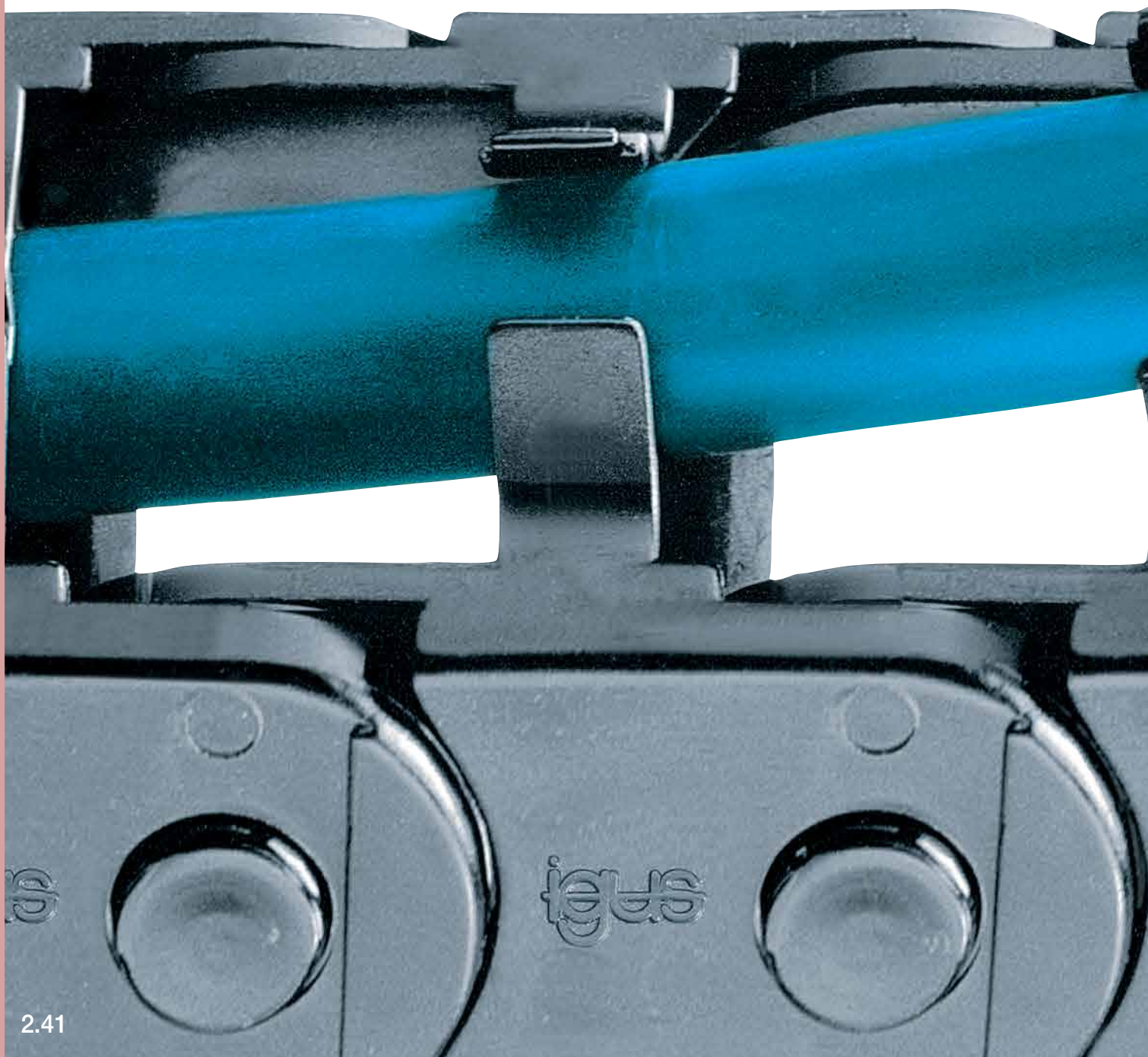

igus[®] E-Z chain

Easy to fill

CHAINFLEX[®]

igus

igus

E-Z chain - easy to fill and very cost-effective

E-Z chain – cost effective cable carrier offers easy access to cables and hoses. E-Z chain cable carriers are designed with a split crossbar along the outer or inner radius for fast installation or removal of cables and hoses—without any tools. The split crossbars are flexible, but retain their shape and strength to provide secure protection and easy cable accessibility.

Typical industries and applications

- General machinery
- Cleanroom applications
- Electronic apparatus
- Office equipment
- Vending machines
- Packaging machines



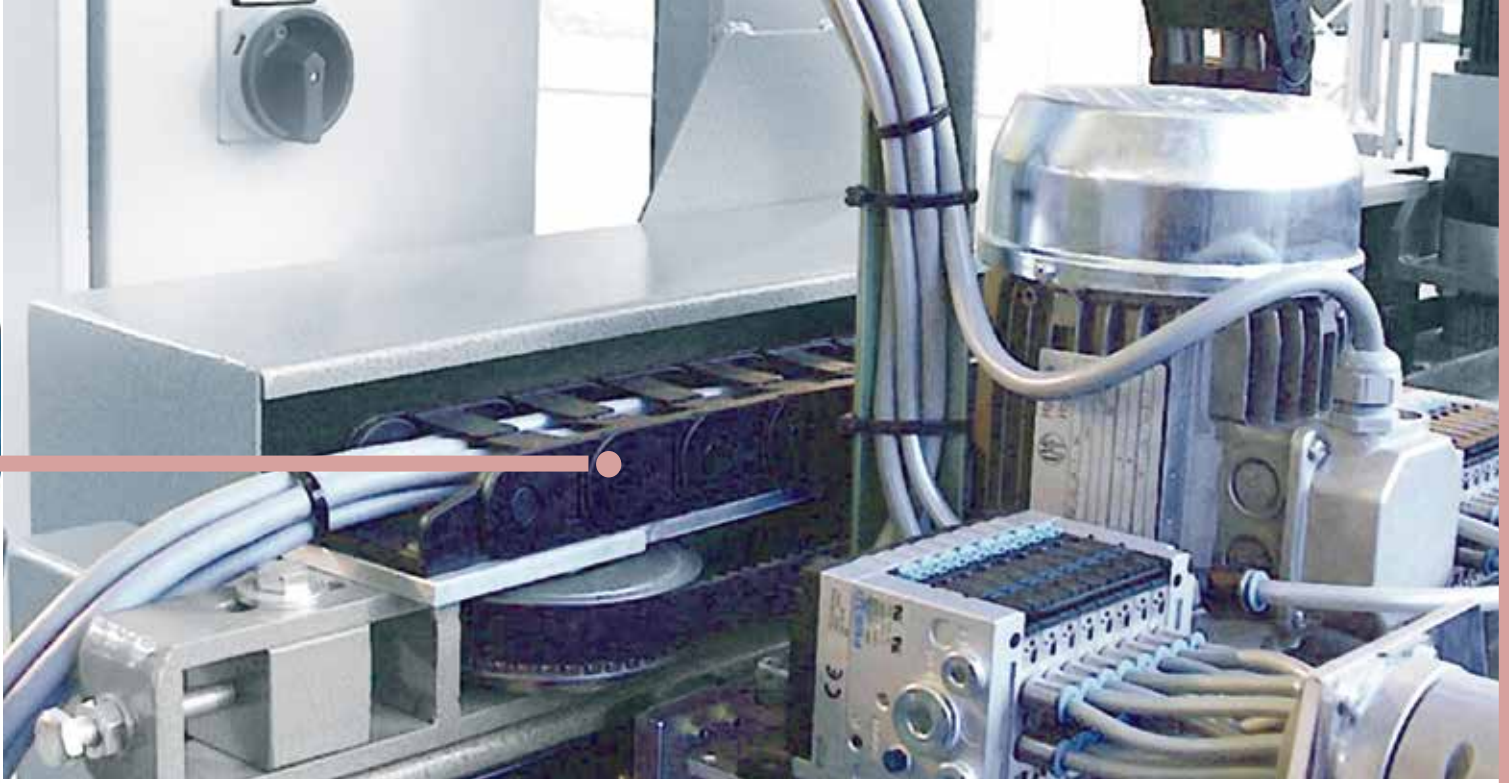

Machinery of all kinds feature igus® E-Z chains - reduces assembly times



Clean room test acc. to Fraunhofer Institute IPA

Standard material - ISO Class 2 acc. to ISO 14644-1

Speed: $v = 3.28 \text{ ft/s}$ (1.0 m/s) and $a = 6.56 \text{ ft/s}$ (2.0 m/s) -

Series E14-3-038



Special equipment: Electrically conductive ESD/ATEX version upon request.



Flammability Class
VDE 0304 IIC UL94 V2



With E-Z chain rotary and torsional motions are possible

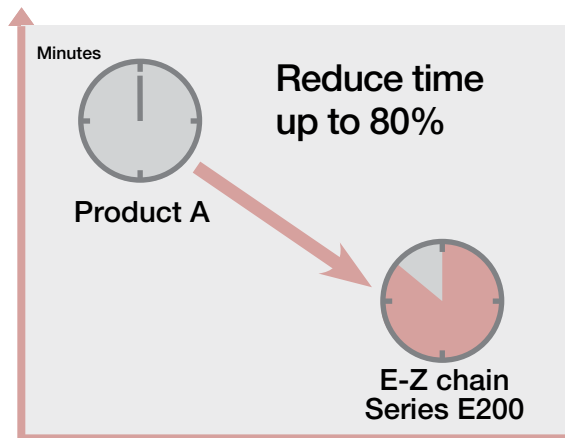

Assembly time: Insertion of 2 cables Ø .24" and .39" (6 and 10 mm).

We can provide you with more details about this and other tests.



E-Z chain Series E14 on server unit, removable for maintenance purposes Cleanroom Class 2 ISO is standard



E-Z chain on adjustable office furniture with UL94 - V2 Classification

e-chain system® E-Z chain Series

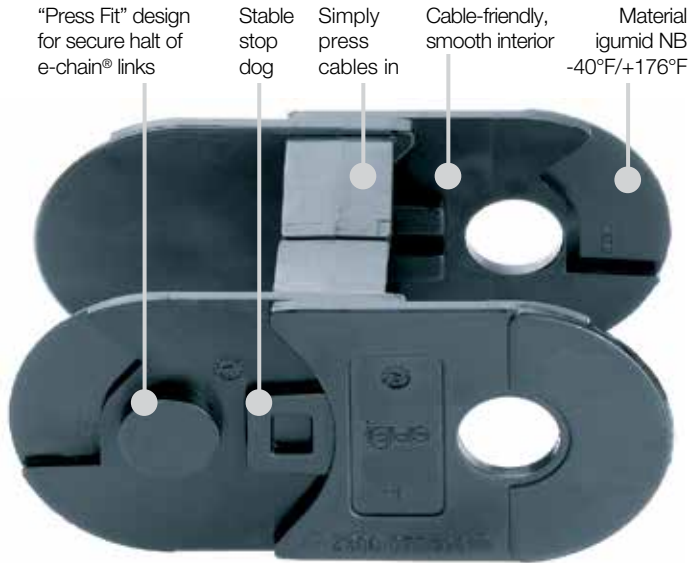

E-Z chain: “E” and “Z” makes “Easy”

- Easy to fill from the outer (exterior) radius (Version “E”) or inner radius (Version “Z”)
- Fast cable accessibility without opening and closing lids
- Easy to lengthen and shorten at any point
- Low price with one-piece design
- Dirt-repellent, contoured exterior
- Mounting brackets available with integrated strain relief
- Limited torsion tolerance
- Available with interior separation (some types)
- Flammability rating UL94-V2
- Suitable for clean-room applications
- You can find more technical data about the material, chemical resistance, temperatures ► **Chapter 1, Design**

Selection table

Series	Inner height <i>hi</i>		Inner width <i>Bi</i>		Outer width <i>Ba</i>		Outer height <i>ha</i>		Bending radius <i>R</i>	
	in.	(mm)	in.	(mm)	in.	(mm)	in.	(mm)	in.	(mm)
E03	.20	(5)	.20 - .39	(5-10)	.34 - .54	(8.7-13.7)	.31	(8)	.39 - 1.10	(10-28)
E04	.28	(7)	.28	(7)	.51	(13)	.39	(10)	.59 - 1.89	(15-48)
E045/Z045	.37	(9.4)	.39 - 1.06	(10-27)	.63 - 1.46	(16 - 37)	.49	(12.5)	.71 - 1.50	(18-38)
E06/Z06	.41/.42	(10.5 / 10.7)	.39 - .79	(10-20)	.65 - 1.04	(16.5-26.5)	.59	(15)	.71 - 1.50	(18-38)
E065	.44	(11.3)	.63 - 1.42	(16-36)	.98 - 1.94	(24.8-49.3)	.59	(15)	.71 - 1.50	(18-38)
E08/Z08	.57/.58	(14.6 / 14.7)	.39 - 1.97	(10-50)	.72 - 2.29	(18.2-58.2)	.76	(19.3)	1.10 - 1.89	(28-48)
E14/Z14	.75	(19)	.59 - 1.97	(15-50)	1.06 - 2.44	(27-62)	.98	(25)	1.10 - 4.92	(28-125)
E200/Z200	.96	(24.3)	1.46 - 2.24	(37-57)	2.93 - 4.74	(74.4-120.4)	1.38	(35)	2.17 - 7.87	(55-200)
E16/Z16	1.26	(32)	.91 - 3.94	(23-100)	1.48 - 4.54	(37.5-115.3)	1.54	(39)	1.57 - 3.94	(40-100)
E26/Z26	1.44/1.46	(36.5 / 37.1)	1.85 - 2.95	(47-75)	3.62 - 6.57	(92-167)	1.97	(50)	2.48 - 9.84	(63-250)
E300/Z300	1.91	(48.5)	1.81 - 2.95	(46-75)	3.74 - 6.69	(95-170)	2.52	(64)	2.95 - 11.81	(75-300)

Quick assembly with ESD!



E-Z chain now available as ESD version

- Easy to fill on the outer/inner radius
- Accessible to the cables without opening and closing of lids
- Cost-effective one-piece design e-chain®
- Mounting brackets available

More information ► www.igus.com



Available from stock. Orders ship as early as today.*

*On average 90% of orders ship the same day..

e-chain system®

E-Z chain Series

Assembling | Separating | Filling | Series E03 · E04 · E/Z045



1 Twist and click or twist and divide



2 Press in cable

Assembling | Series E/Z06 · E065 · E/Z08 · E/Z14 · E/Z200 · E/Z16 · E/Z26 · E/Z300



1 Push and click...



2 Snap in pin

Separating | Series E/Z06 · E065 · E/Z08 · E/Z14 · E/Z200 · E/Z16 · E/Z26 · E/Z300

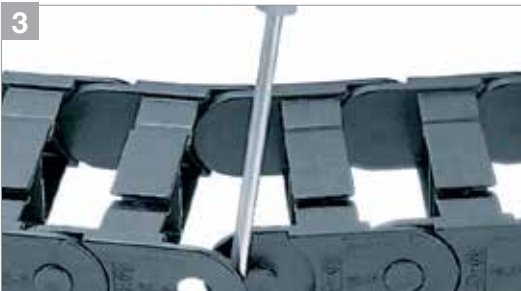

3 Release side link



4 Twist and pull apart

Filling | Series E/Z06 · E065 · E/Z08 · E/Z14 · E/Z200 · E/Z16 · E/Z26 · E/Z300



5 Press in cable



6 Pull out cable

Price Index

Series E03

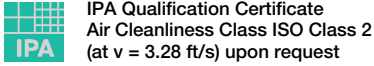
Special Features / Options

IPA Qualification Certificate
Air Cleanliness Class ISO Class 2
(at v = 3.28 ft/s) upon request



Flammability Class
VDE 0304 IIC UL94 V2



Smallest inner heights .20" (5 mm)
Series E03 E-Z chain

Assembly Tips

Just push the cables into the e-chain
using your thumb

Usage Guidelines

- If filling is required without opening and closing
- If price is an issue
- If quiet operation is required



- If a non-opening Energy is needed
➤ Series 03 E2 Micro

Features & Benefits

- 1 Smallest e-chain® -
interior dimensions .20" x .20" (5 x 5 mm)
- 2 Small pitch for low-noise and smooth operation
- 3 Very easy to fill, without opening and closing lids
- 4 Mounting bracket with integrated strain relief
- 5 Very lightweight - ideal for low fill weight
- 6 Patented push button design holds the links together
- 7 For smallest bending radii
chainflex® CF98/CF99 - 4 x d

Order Example: Complete e-chain®

Please indicate chain length or number of links. Example:

3.28 ft (1 m) **E03-05-010-0**

e-chain®

1 Set **E03-05-12Z**

Mounting Bracket

e-chain system® E-Z chain Series E03 Installation Dimensions



E03

Short travel, unsupported length

- FL_B = unsupported with permitted sag
 - FL_G = unsupported with straight upper run
- Further information ► Design, Chapter 1

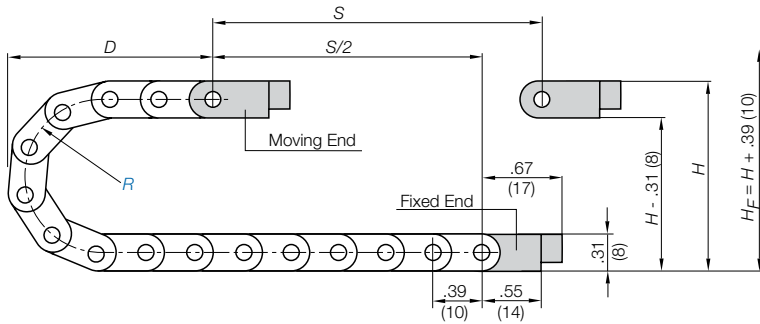
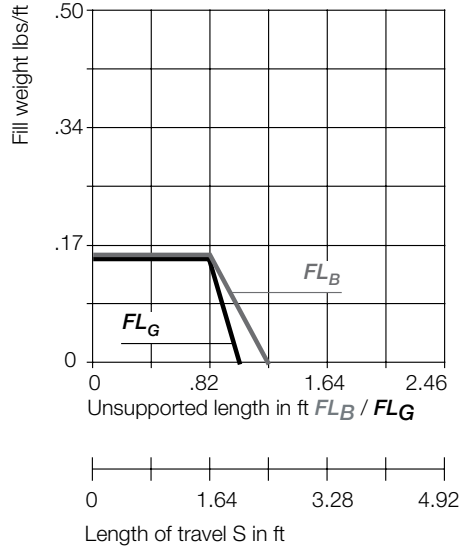
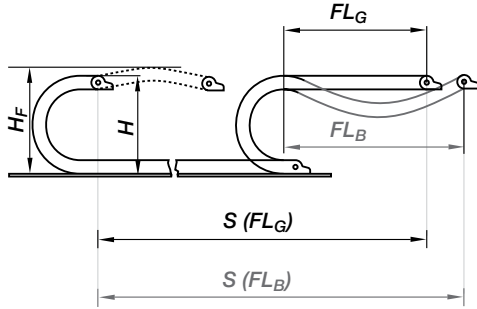

Pitch per link = .39" (10 mm)
Links per ft (m) = 30.47 (100)
For center mount applications:
Chain length = $\frac{S}{2} + K$

The required clearance height: $H_F = H + .39$ in. (10 mm) (with .067 lbs/ft (0.1 kg/m) fill weight). Please consult igus® if space is particularly restricted.

R	.39 (010)	.47 (012)	.59 (015)	.71 (018)	1.10 (028)
H	1.10 (28)	1.26 (32)	1.50 (38)	1.73 (44)	2.52 (64)
D	1.14 (29)	1.22 (31)	1.34 (34)	1.46 (37)	1.85 (47)
K	2.17 (55)	2.36 (60)	2.76 (70)	3.15 (80)	4.33 (110)

Short Travels - Unsupported



Unsupported E-Chains® feature positive camber over short travels. This must be accounted for when specifying the clearance height. Please refer to **Installation dimensions** for further details.

Legend

- S = Length of travel
- R = Bending radius
- H = Nominal clearance height
- D = Overlength e-chain® radius in final position
- $K = \pi \cdot R + \text{safety buffer}$
- H_F = Required clearance height



PDF: igus.com/e-chain-pdfs
Product information: igus.com/e-chains



Speed / acceleration FL_G	max. 65.6 ft/s (20 m/s) / max. 656 ft/s ² (200 m/s ²)
Speed / acceleration FL_B	max. 9.84 ft/s (3 m/s) / max. 19.69 ft/s ² (6 m/s ²)
Gliding speed / acceleration (maximum)	max. 9.84 ft/s (3 m/s) / max. 32.8 ft/s ² (10 m/s ²)
Material (e-chain®) - permitted temperature	igumid NB / -40°F (-40°C) up to +176°F (+80°C)
Material (mounting brackets)* - permitted temperature	igumid G / -40°F (-40°C) up to +248°F (+120°C)
Flammability Class (e-chain®), igumid NB	VDE 0304 IIC UL94 V2
Flammability Class (mounting brackets), igumid G*	VDE 0304 IIC UL94 HB

*Available in igumid NB upon request, please consult igus® for delivery time

Technical Data



Details of material properties

► Chapter 1

Series E03 - Split crossbar along the outer radius

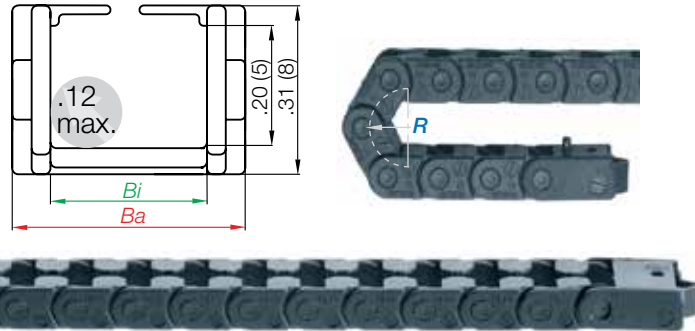

Part Number Structure

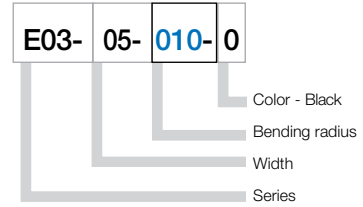

Telephone 1-800-521-2747

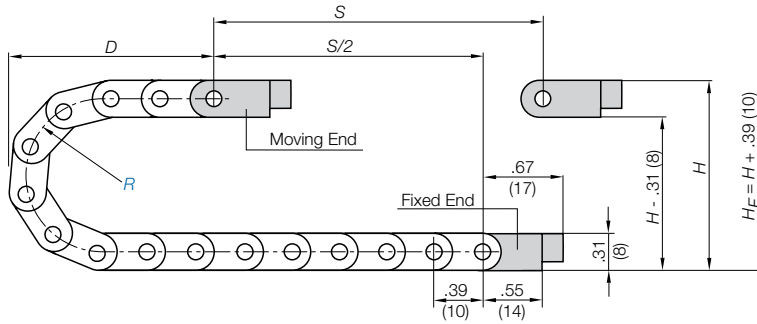

Supplement part number with required radius. Example: E03-05--0
Pitch: .39 in. (10 mm) per link links/ft (m) = 30.47 (100)

Part Number	Bi in. (mm)	Ba in. (mm)	Weight lbs/ft (kg/m)	Crossbar gap in. (mm)
E03-05- <input type="text" value=""/> -0*	.20 (5)	.34 (8.7)	≈ 0.020 (0.03)	.04 (1)
E03-07- <input type="text" value=""/> -0*	.28 (7)	.42 (10.7)	≈ 0.026 (0.04)	.08 (2)
E03-10- <input type="text" value=""/> -0*	.39 (10)	.54 (13.7)	≈ 0.033 (0.05)	.08 (2)

Choose from the radii below for all of the above sizes
Radius (mm) Example: 03-05--0

	<input type="text" value="010"/>	<input type="text" value="012"/>	<input type="text" value="015"/>	<input type="text" value="018"/>	<input type="text" value="028"/>
R	.39 (010)	.47 (012)	.59 (015)	.71 (018)	1.10 (028)
H	1.10 (28)	1.26 (32)	1.50 (38)	1.73 (44)	2.52 (64)
D	1.14 (29)	1.22 (31)	1.34 (34)	1.46 (37)	1.85 (47)
K	2.17 (55)	2.36 (60)	2.76 (70)	3.15 (80)	4.33 (110)

0=Standard color black. For other colors see Chapter 1

*Please note: For this series the crossbars do not overlap. Please see table for gap amount.

e-chain system® E-Z chain

Series E03

Mounting Brackets



Polymer, one-piece

- One-piece mounting bracket
- Corrosion resistant
- Available preassembled
- Inner and outer attachment possible
- Adaptor plate for rapid installation

Moving end with bore
03 ...1Z

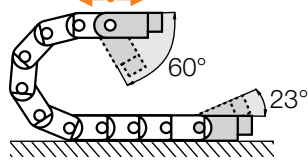

Fixed end with pin
03...2Z

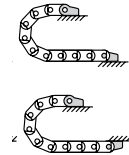

Possible installation configurations -

Part Number Structure

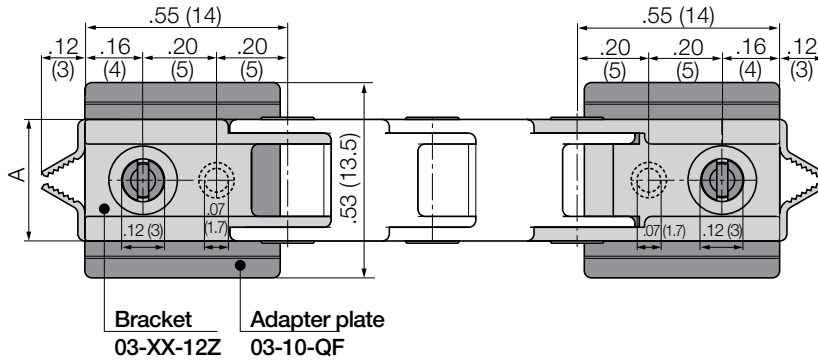
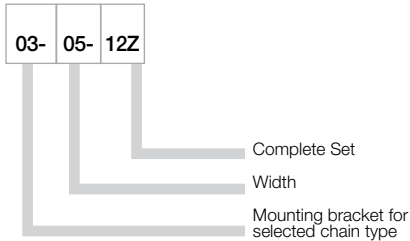

Full set, for both ends:

03- 05- 12Z Full set, each part with pin/bore

Single-part order:

03- 05- 1Z Mounting bracket with bore

03- 05- 2Z Mounting bracket with pin

Width Index	Part No. Full Set	Dimension A in. (mm)
-05	03-05-12PZ	.34 (8.7)
-07	03-07-12PZ	.42 (10.7)
-10	03-10-12PZ	.54 (13.7)

Additional Accessories



03-10-QF = Adapter plate for all sizes

The adapter has broken edges, so that it can be adapted to the respective chain width. It is not absolutely necessary for attaching the mounting brackets. The mounting brackets can also be screwed on without the adapter plate.

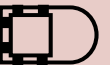
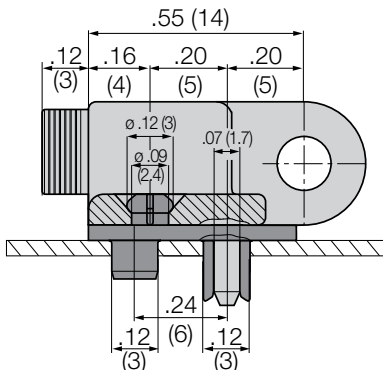

Price Index

Series E04

Special Features / Options
IPA Qualification Certificate
Air Cleanliness Class ISO Class 2
(at v = 3.28 ft/s) upon request

Flammability Class
VDE 0304 IIC UL94 V2

**Special equipment: Electrically
conductive ESD/ATEX version
upon request**
Assembly Tips

Just push the cables into the e-chain
using your thumb



Special solution:
opening gap (0.8 mm)
Part No. E04-07-015-S

Usage Guidelines



- If filling is required without opening and closing
- If price is an issue
- If quiet operation is required



- If a non-opening Energy is needed
➤ **Series 04 E2 Micro**

Features & Benefits

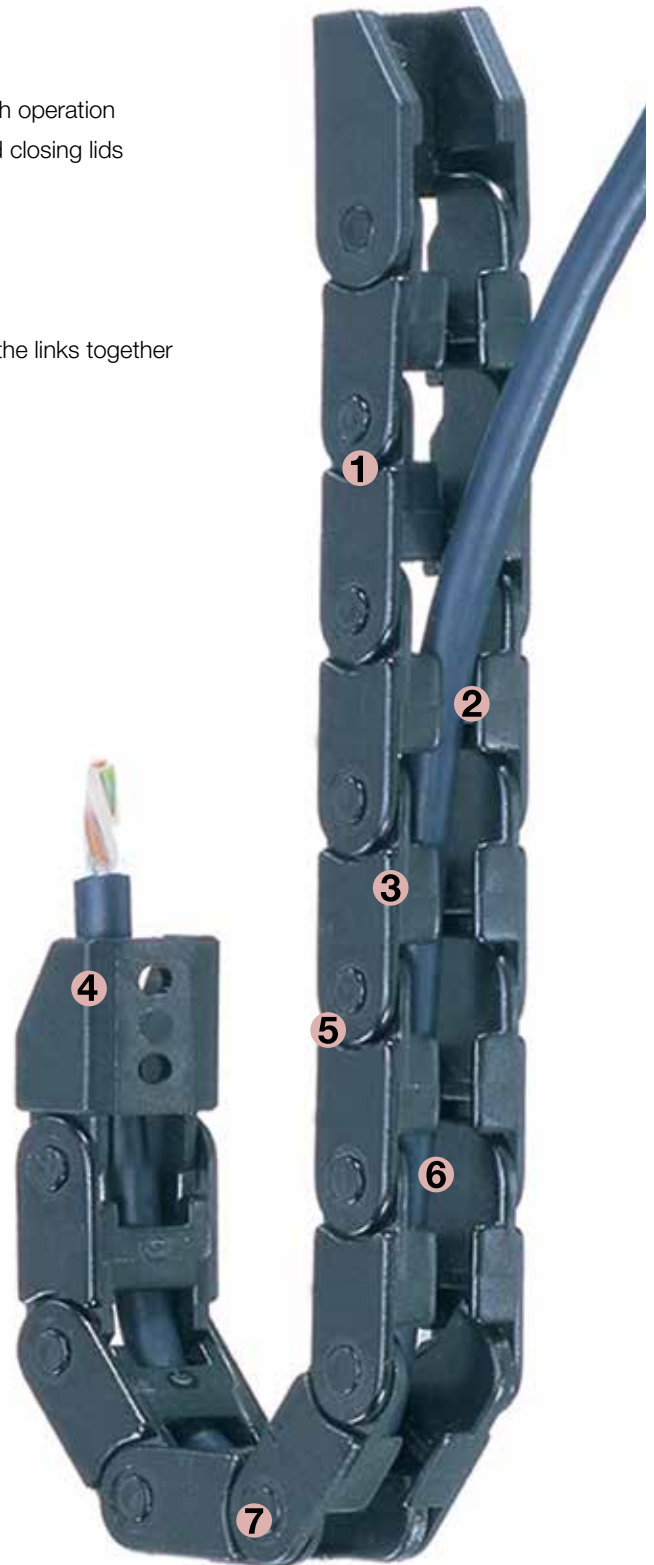
- 1 Small pitch for low-noise and smooth operation
- 2 Very easy to fill, without opening and closing lids
- 3 For high acceleration
- 4 Mounting brackets available
- 5 Limited torsion tolerance
- 6 Cable friendly smooth interior
- 7 Patented push button design holds the links together

Order Example: Complete e-chain®

Please indicate chain length or number of links. Example:

3.28 ft (1 m) **E04-07-038-0**

e-chain®

1 Set **040-07-12**

Mounting Bracket

e-chain system® E-Z chain

Series E04

Installation Dimensions



E04

Short travel, unsupported length

- FL_B = unsupported with permitted sag
 - FL_G = unsupported with straight upper run
- Further information ► Design, Chapter 1

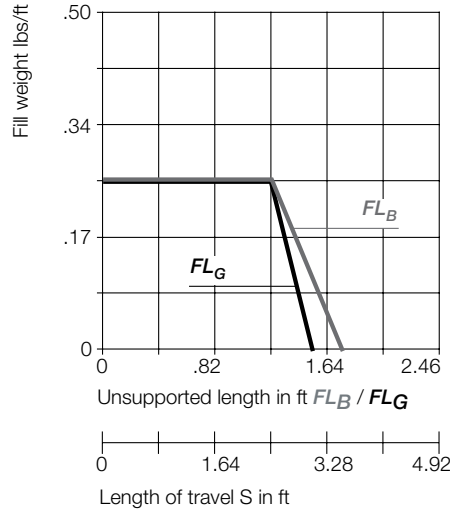
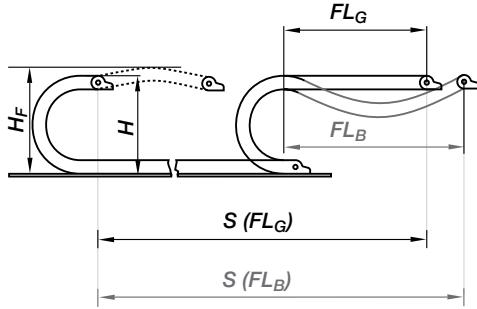

Short Travels - Unsupported



Unsupported E-Chains® feature positive camber over short travels. This must be accounted for when specifying the clearance height. Please refer to **Installation dimensions** for further details.

Legend

- S = Length of travel
- R = Bending radius
- H = Nominal clearance height
- D = Overlength e-chain® radius in final position
- $K = \pi \cdot R + \text{safety buffer}$
- H_F = Required clearance height

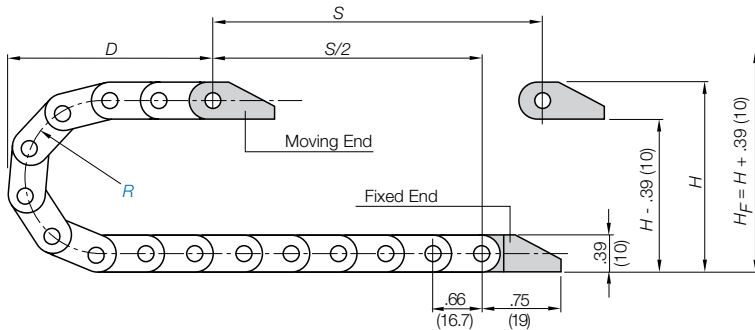

Pitch per link = .66" (16.7 mm)
 Links per ft (m) = 18.28 (60)
 For center mount applications:
 Chain length = $\frac{S}{2} + K$

The required clearance height: $H_F = H + .39$ in. (10 mm) (with .067 lbs/ft (0.1 kg/m) fill weight. Please consult igus® if space is particularly restricted.

R	.59 (015)	.71 (018)	1.10 (028)	1.50 (038)	1.89 (048)
H	1.57 (40)	1.81 (46)	2.60 (66)	3.39 (86)	4.17 (106)
D	1.77 (45)	1.89 (48)	2.28 (58)	2.68 (68)	3.07 (78)
K	3.35 (85)	3.54 (90)	4.92 (125)	6.10 (155)	7.28 (185)



PDF: igus.com/e-chain-pdfs
 Product information: igus.com/e-chains



Speed / acceleration FL_G	max. 65.6 ft/s (20 m/s) / max. 656 ft/s ² (200 m/s ²)
Speed / acceleration FL_B	max. 9.84 ft/s (3 m/s) / max. 19.69 ft/s ² (6 m/s ²)
Material (e-chain®) - permitted temperature	igumid NB / -40°F (-40°C) up to +176°F (+80°C)
Material (mounting brackets)* - permitted temperature	igumid G / -40°F (-40°C) up to +248°F (+120°C)
Flammability Class (e-chain®), igumid NB	VDE 0304 IIC UL94 V2
Flammability Class (mounting brackets), igumid G	VDE 0304 IIC UL94 HB

Technical Data



Details of material properties

► Chapter 1

Series E04 - Split crossbar along the outer radius

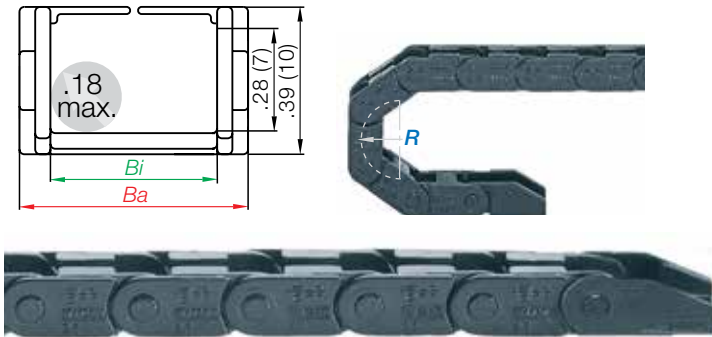

Part Number Structure

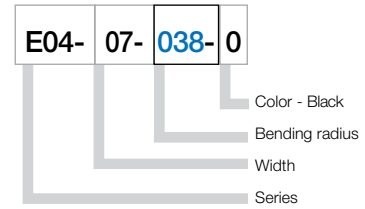

Telephone 1-800-521-2747

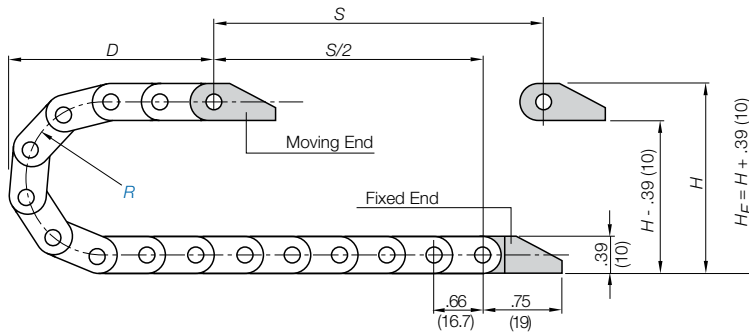

Supplement part number with required radius. Example: E04-07-**038**-0
Pitch: .66 in. (16.7 mm) per link links/ft (m) = 18.28 (60)

Part Number	Bi in. (mm)	Ba in. (mm)	Weight lbs/ft (kg/m)	Crossbar Gap in. (mm)
E04-07- <input type="text"/> -0*	.28 (7)	.51 (13)	≈ 0.053 (0.08)	.10 (2.5)

Choose from the radii below for all of the above sizes
Radius (mm) Example: E04-07-**038**-0

	015	018	028	038	048
R	.59 (015)	.71 (018)	1.10 (028)	1.50 (038)	1.89 (048)
H	1.57 (40)	1.81 (46)	2.60 (66)	3.39 (86)	4.17 (106)
D	1.77 (45)	1.89 (48)	2.28 (58)	2.68 (68)	3.07 (78)
K	3.35 (85)	3.54 (90)	4.92 (125)	6.10 (155)	7.28 (185)

0=Standard color black. For other colors see Chapter 1
*Please note: For this series the crossbars do not overlap. Please see table for gap amount.

e-chain system® E-Z chain

Series E04

Mounting Brackets



E04



Polymer, one-piece

- One-piece mounting bracket
- Corrosion resistant
- Available preassembled

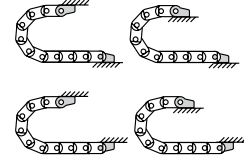
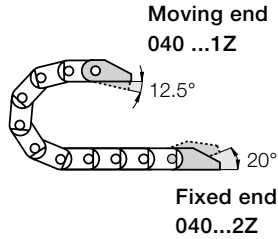

Possible installation configurations -

Part Number Structure

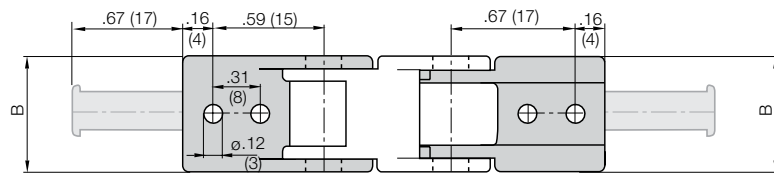
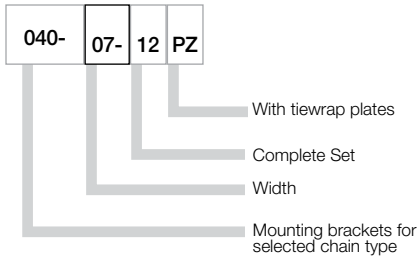

Full set, for both ends:

040-07-12 Full set, each part with pin/bore

Single-part order:

040-07-1 Mounting bracket with bore

040-07-2 Mounting bracket with pin

Chain Type	Part No. Full set without Tiewrap Plate	Part No. Full set with Tiewrap Plate	Dimension B in. (mm)	Number of Teeth
E04-07	040-07-12	040-07-12PZ	.47 (12)	1

PDF: igus.com/e-chain-pdfs
Product information: igus.com/e-chains

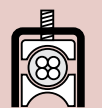
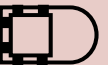

Additional accessories



Quicksnap - the complete, detachable mounting unit, upon request
Only available for the 040-07 e-chain - **Part No. 040-07-QS**

E045
Z045



e-chain system® E-Z chain Series E045/Z045



Price Index



Series E045

Special Features / Options



IPA Qualification Certificate
Air Cleanliness Class ISO Class 2
(at v = 3.28 ft/s) upon request



Flammability Class
VDE 0304 IIC UL94 V2



Special equipment: Electrically
conductive ESD/ATEX version
upon request

Assembly Tips



Just push the cables into the e-chain
using your thumb

Features & Benefits

- 1 Limited torsion tolerance
- 2 Small pitch for low-noise and smooth operation
- 3 Cable friendly interior
- 4 Patented push button design holds the links together
- 5 Very easy to fill
- 6 Mounting brackets available
- 7 "E" Series features split crossbar along the outer radius
- 8 "Z" Series features split crossbar along the inner radius
- 9 1-, 2-, or 3-chamber system available

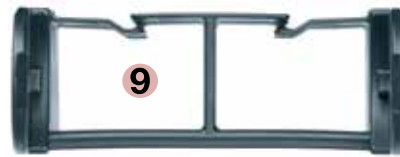

Usage Guidelines



- If filling is required without opening and closing
- If a very small pitch is required



- If smooth operation is required
 - Series 045 E2 Micro
- If high stability is required
 - Series 06 E2 Micro
- If non-opening is required
 - Series 045 E2 Micro

Order Example: Complete e-chain®

Please indicate chain length or number of links. Example:

3.28 ft (1 m) E045-16-038-0



e-chain®

1 Set 0450-16-12



Mounting Bracket

e-chain system® E-Z chain Series E045/Z045 Installation Dimensions



E045
Z045

Short travel, unsupported length

- FL_B = unsupported with permitted sag
 - FL_G = unsupported with straight upper run
- Further information ► Design, Chapter 1

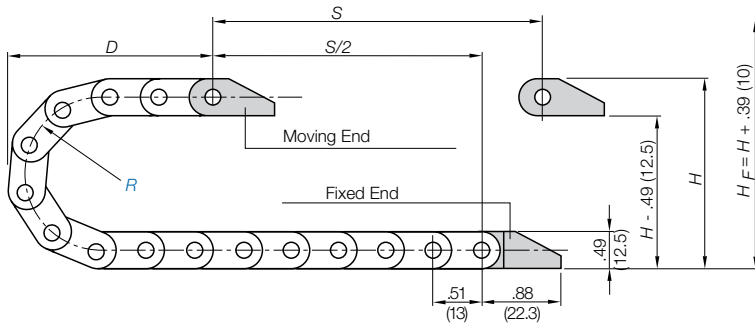
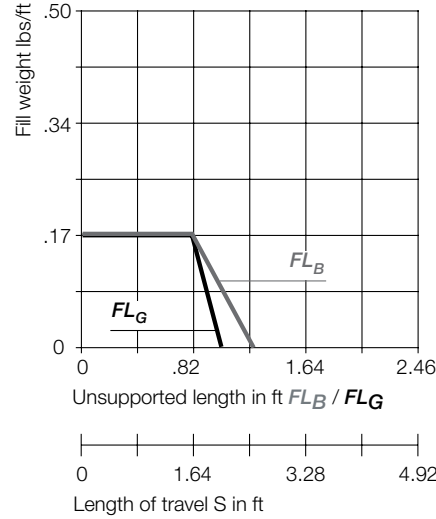
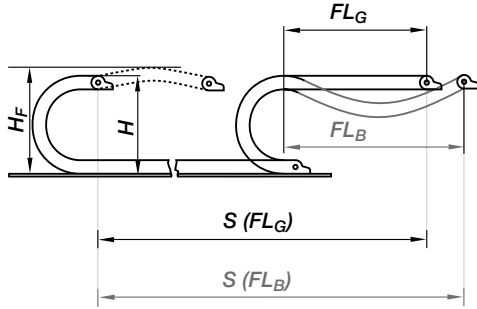

Pitch per link = .51" (13 mm)
Links per ft (m) = 23.47 (77)
For center mount applications:
Chain length = $\frac{S}{2} + K$

The required clearance height: $H_F = H + .39$ in. (10 mm) (with .067 lbs/ft (0.1 kg/m) fill weight).
Please consult igus® if space is particularly restricted.

R	.71 (018)	1.10 (028)	1.50 (038)
H	1.91 (48.5)	2.70 (68.5)	3.48 (88.5)
D	1.73 (44)	2.13 (54)	2.52 (64)
K	3.35 (85)	4.53 (115)	5.91 (150)

Short Travels - Unsupported



Unsupported E-Chains® feature positive camber over short travels. This must be accounted for when specifying the clearance height. Please refer to **Installation dimensions** for further details.

Legend

- S = Length of travel
- R = Bending radius
- H = Nominal clearance height
- D = Overlength e-chain® radius in final position
- $K = \pi \cdot R + \text{safety buffer}$
- H_F = Required clearance height



PDF: igus.com/e-chain-pdfs
Product information: igus.com/e-chains



Speed / acceleration FL_G	max. 65.6 ft/s (20 m/s) / max. 656 ft/s ² (200 m/s ²)
Speed / acceleration FL_B	max. 9.84 ft/s (3 m/s) / max. 19.69 ft/s ² (6 m/s ²)
Material (e-chain®) - permitted temperature	igumid NB / -40°F (-40°C) up to +176°F (+80°C)
Material (mounting brackets)* - permitted temperature	igumid G / -40°F (-40°C) up to +248°F (+120°C)
Flammability Class (e-chain®), igumid NB	VDE 0304 IIC UL94 V2
Flammability Class (mounting brackets), igumid G	VDE 0304 IIC UL94 HB

Technical Data



Details of material properties

► Chapter 1

Series E045 - Split crossbar along the outer radius

Single Chamber System
2 Chamber System

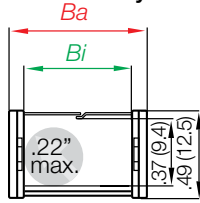

3 Chamber System

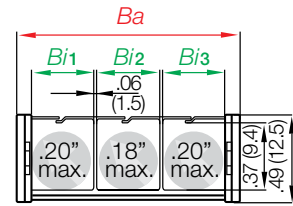
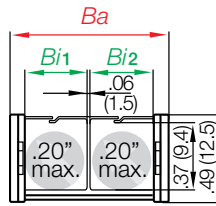

Supplement part number with required radius. Example: E045-16-038-0
Pitch: .51 in. (13 mm) per link links/ft (m) = 23.47 (77)

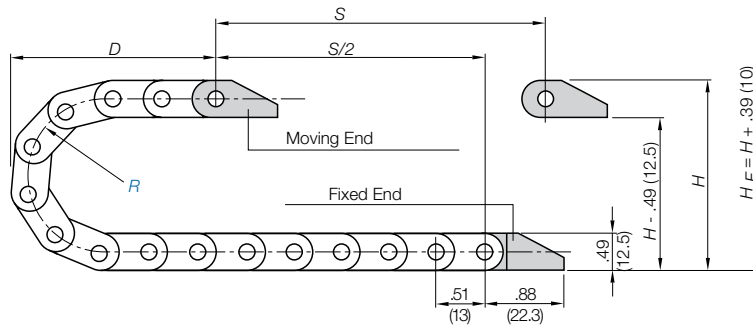

Part Number Structure



Color - Black
Bending radius
Width
Series

Part Number	Bi in. (mm)	Ba in. (mm)	Weight lbs/ft (kg/m)	Crossbar Gap in. (mm)
Single Chamber System				
E045-10- <input type="checkbox"/> -0*	.39 (10)	.63 (16)	≈ 0.06 (0.09)	.08 (2)
E045-16- <input type="checkbox"/> -0	.63 (16)	.91 (23)	≈ 0.07 (0.11)	-
2 Chamber System				
E045-2/7- <input type="checkbox"/> -0*	.28/.28 (7/7)	.91 (23)	≈ 0.09 (0.13)	.09 (2.25)
E045-2/9- <input type="checkbox"/> -0*	.35/.35 (9/9)	1.06 (27)	≈ 0.09 (0.14)	.09 (2.25)
3 Chamber System				
E045-3/9- <input type="checkbox"/> -0*	.35/.35/.35 (9/9/9)	1.46 (37)	≈ 0.11 (0.17)	.09 (2.25)
Choose from the radii below for all of the above sizes Radius (mm) Example: E045-16-038-0				

	018	028	038
R	.71 (018)	1.10 (028)	1.50 (038)
H	1.91 (48.5)	2.70 (68.5)	3.48 (88.5)
D	1.73 (44)	2.13 (54)	2.52 (64)
K	3.35 (85)	4.53 (115)	5.91 (150)

0=Standard color black. For other colors see Chapter 1
*Please note: For this series the crossbars do not overlap. Please see table for gap amount.

Series Z045 - Split crossbar along the inner radius

Single Chamber System
2 Chamber System

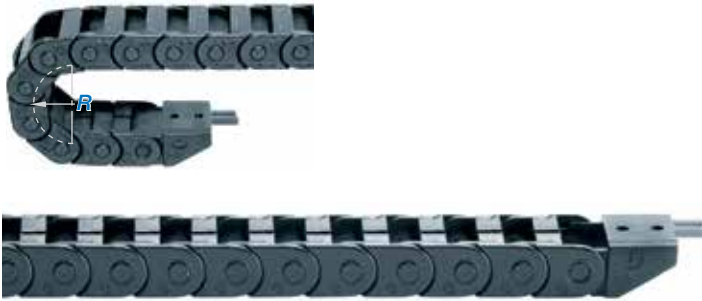
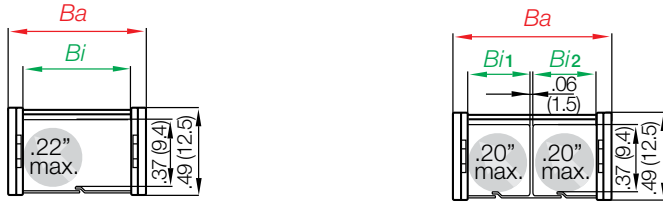

Supplement part number with required radius. Example: Z045-16-**038**-0
Pitch: .51 in. (13 mm) per link links/ft (m) = 23.47 (77)

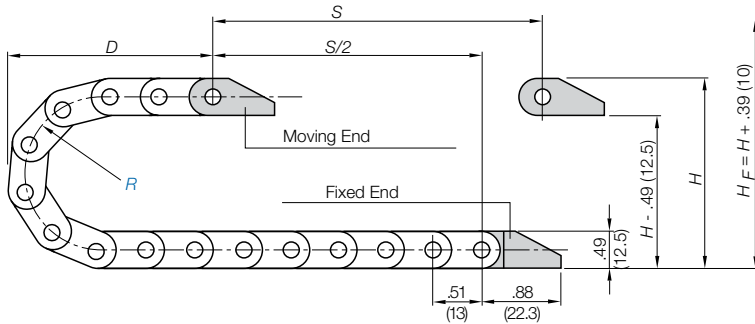

Part Number Structure

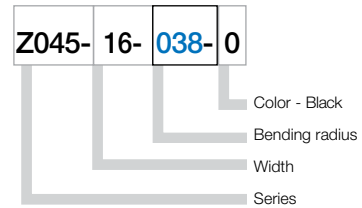

Part Number	<i>Bi</i> in. (mm)	<i>Ba</i> in. (mm)	Weight lbs/ft (kg/m)	Crossbar Gap in. (mm)
Single Chamber System				
Z045-16- <input type="text"/> -0*	.63 (16)	.91 (23)	≈ 0.07 (0.11)	.08 (2)

2 Chamber System	<i>Bi</i> in. (mm)	<i>Ba</i> in. (mm)	Weight lbs/ft (kg/m)	Crossbar Gap in. (mm)
Z045-2/7- <input type="text"/> -0*	.28/.28 (7/7)	.91 (23)	≈ 0.09 (0.13)	.09 (2.25)

Choose from the radii below for all of the above sizes
Radius (mm) Example: Z045-16-**038**-0

	018	028	038
R	.71 (018)	1.10 (028)	1.50 (038)
H	1.91 (48.5)	2.70 (68.5)	3.48 (88.5)
D	1.73 (44)	2.13 (54)	2.52 (64)
K	3.35 (85)	4.53 (115)	5.91 (150)

0=Standard color black. For other colors see Chapter 1

*Please note: For this series the crossbars do not overlap. Please see table for gap amount.





Polymer, one-piece

- One-piece mounting bracket
- Corrosion resistant
- Available preassembled

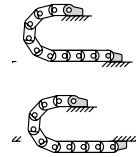
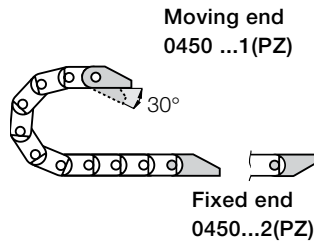

Possible installation configurations -

Part Number Structure

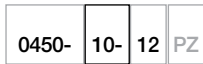

- With tiewrap plates
- Complete Set
- Width
- Mounting brackets for selected chain type

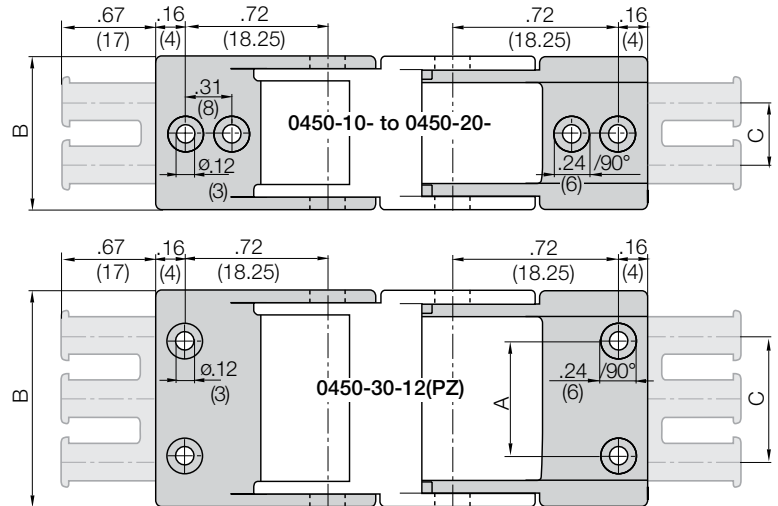

Full set, for both ends:

0450-10-12-PZ

Full set, each part with pin/bore + tiewrap plate

Single-part order:

0450-10-1-PZ

Mounting bracket with bore + tiewrap plate

0450-10-2-PZ

Mounting bracket with pin + tiewrap plate

Chain Type	Part No.		Dimension A in. (mm)	Dimensions B in. (mm)		Dimension C in. (mm)		Number of Teeth
	Full set with Tiewrap Plate	Full Set without Tiewrap Plate						
E045/Z045-10	0450-10-12PZ	0450-10-12	—	—	.63 (16)	—	—	1
E045/Z045-16	0450-16-12PZ	0450-16-12	—	—	.87 (22)	.39 (10)		2
E045/Z045-2/7	0450-16-12PZ	0450-16-12	—	—	.87 (22)	.39 (10)		2
E045/Z045-2/9	0450-20-12PZ	0450-20-12	—	—	1.02 (26)	.39 (10)		2
E045/Z045-3/9	0450-30-12PZ	0450-30-12	.87 (22)		1.42 (36)	.79 (20)		3

Additional Accessories



Quickfix - mounting bracket
with dowel, upon request

Part No.

0450-16-12Q

PDF: igus.com/e-chain-pdfs
Product information: igus.com/e-chains



E06
Z06



e-chain system® E-Z chain Series E06/Z06



Price Index



Series E06/Z06

Special Features / Options



IPA Qualification Certificate
Air Cleanliness Class ISO Class 2
(at v = 3.28 ft/s) upon request



Flammability Class
VDE 0304 IIC UL94 V2



Special equipment: Electrically
conductive ESD/ATEX version
upon request

Assembly Tips



Just push the cables into the e-chain
using your thumb



Special solution -
opening gap 0.14 (3.5 mm)
Part No. E06-10-018S3

Usage Guidelines



- If filling is required without opening and closing
- If price is an issue
- If quiet operation is required



- "Z" Series is unsuitable for gliding applications
 - Series 07 Zipper
- If non-opening is required
 - Series 06 E2 Micro

Features & Benefits

- 1 Small pitch for low-noise and smooth operation
- 2 Cable friendly - smooth interior
- 3 Very lightweight
- 4 Patented push button design holds the links together
- 5 Very easy to fill
- 6 Integrated strain relief option
- 7 "E" Series features split crossbar along the outer radius
- 8 "Z" Series features split crossbar along the inner radius
- 9 Limited torsion tolerance



Order Example: Complete e-chain®

Please indicate chain length or number of links. Example:

3.28 ft (1 m) E06-10-038-0



e-chain®

1 Set 060-10-12



Mounting Bracket

e-chain system® E-Z chain Series E06/Z06 Installation Dimensions



E06
Z06

Short travel, unsupported length

- FL_B = unsupported with permitted sag
 - FL_G = unsupported with straight upper run
- Further information ► Design, Chapter 1

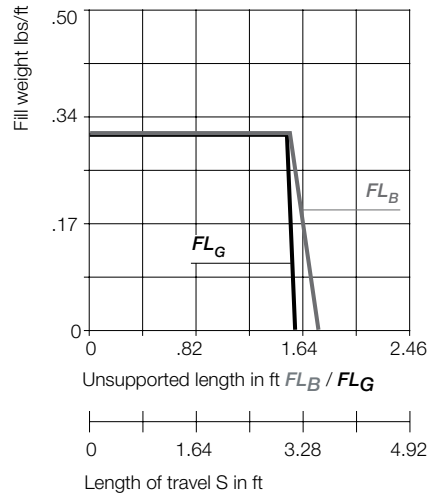
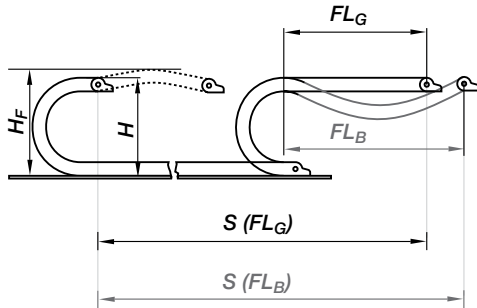

Short Travels - Unsupported

Unsupported E-Chains® feature positive camber over short travels. This must be accounted for when specifying the clearance height. Please refer to **Installation dimensions** for further details.

Legend

- S = Length of travel
- R = Bending radius
- H = Nominal clearance height
- D = Overlength e-chain® radius in final position
- $K = \pi \cdot R + \text{safety buffer}$
- H_F = Required clearance height

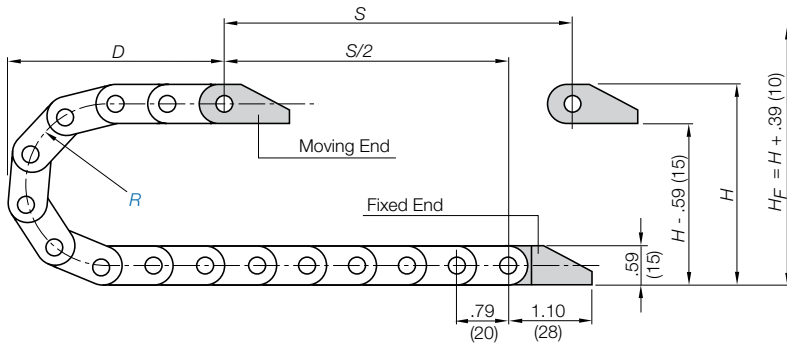

Pitch per link = .79" (20 mm)
Links per ft (m) = 15.24 (50)
For center mount applications:
Chain length = $S/2 + K$

The required clearance height: $H_F = H + .39$ in. (10 mm) (with .13 lbs/ft (0.2 kg/m) fill weight. Please consult igus® if space is particularly restricted.

R	.71 (018)	1.10 (028)	1.50 (038)
H*	2.01 (51)	2.80 (71)	3.58 (91)
D	2.20 (56)	2.60 (66)	2.99 (76)
K	3.94 (100)	5.12 (130)	6.30 (160)



PDF: igus.com/e-chain-pdfs
Product information: igus.com/e-chains



Speed / acceleration FL_G	max. 65.6 ft/s (20 m/s) / max. 656 ft/s ² (200 m/s ²)
Speed / acceleration FL_B	max. 9.84 ft/s (3 m/s) / max. 19.69 ft/s ² (6 m/s ²)
Material (e-chain®) - permitted temperature	igumid NB / -40°F (-40°C) up to +176°F (+80°C)
Material (mounting brackets)* - permitted temperature	igumid G / -40°F (-40°C) up to +248°F (+120°C)
Flammability Class (e-chain®), igumid NB	VDE 0304 IIC UL94 V2
Flammability Class (mounting brackets), igumid G	VDE 0304 IIC UL94 HB

Technical Data



Details of material properties

► Chapter 1

Series E06 - Split crossbar along the outer radius

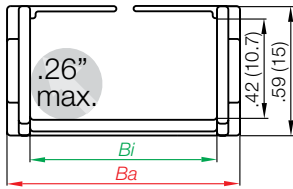

Part Number Structure



Color - Black
Bending radius
Width
Series

Series Z06 - Split crossbar along the inner radius

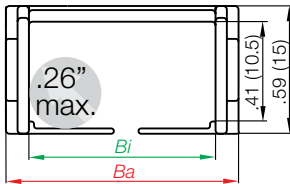

Part Number Structure



Color - Black
Bending radius
Width
Series

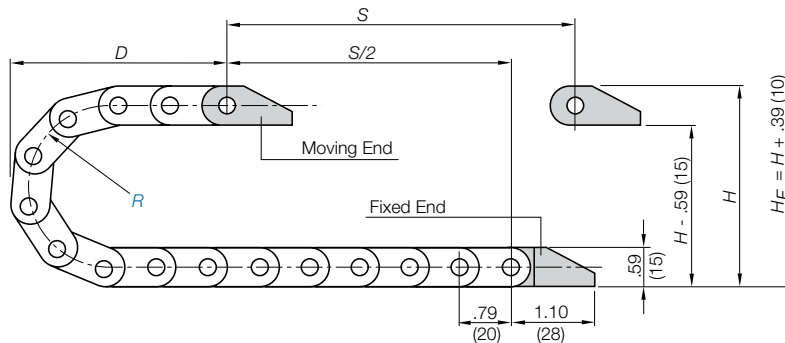

Supplement part number with required radius. Example: E06-10-038-0
Pitch: .79 in. (20 mm) per link links/ft (m) = 15.24 (50)

Part Number			Bi	Ba	Weight	Crossbar Gap
Split Crossbar Outer Radius	Split Crossbar Inner Radius		in. (mm)	in. (mm)	lbs/ft (kg/m)	in. (mm)
E06-10	Z06-10*	<input type="text"/> -0	.39 (10)	.65 (16.5)	≈ 0.09 (0.14)	.22 (5.5)
E06-16-	Z06-16*	<input type="text"/> -0	.63 (16)	.86 (22.5)	≈ 0.11 (0.16)	.22 (5.5)
E06-20-	Z06-20	<input type="text"/> -0	.79 (20)	1.04 (26.5)	≈ 0.12 (0.18)	-

Choose from the radii below for all of the above sizes
Radius (mm) Example: E06-10-038-0

	018	028	038
R	.71 (018)	1.10 (028)	1.50 (038)
H*	2.01 (51)	2.80 (71)	3.58 (91)
D	2.20 (56)	2.60 (66)	2.99 (76)
K	3.94 (100)	5.12 (130)	6.30 (160)

0=Standard color black. For other colors see Chapter 1
*Please note: For this series the crossbars do not overlap. Please see table for gap amount.

e-chain system® E-Z chain Series E06/Z06 Mounting Brackets



E06
Z06



Polymer, one-piece

- One-piece mounting bracket
- Corrosion resistant
- Available preassembled
- Inner and outer attachment possible
- Available with or without integrated strain relief tiwrap plates

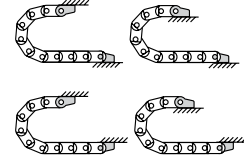
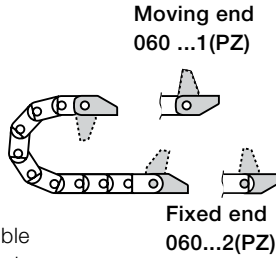

Possible installation configurations -

Dimensions and order configurations

Strain relief is possible on the moving end and/or the fixed end.

Part Number Structure

060-	20-	12	PZ
------	-----	----	----

- With assembled strain relief tiwrap plates
- Complete Set
- Width
- Mounting brackets for selected chain type

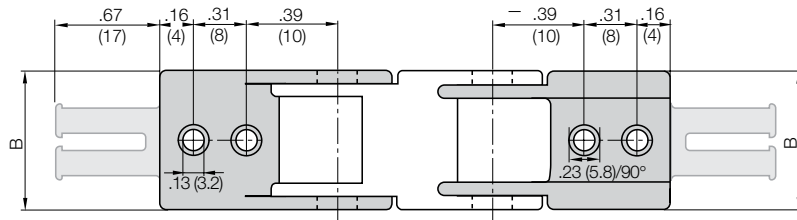

Full set, for both ends:

060- 20- 12 PZ Full set, each part with pin/bore

Single-part order:

060- 20- 1 PZ Mounting bracket with bore

060- 20- 2 PZ Mounting bracket with pin

Chain Type	Part No. Full set with Tiwrap Plate	Part No. Full Set without Tiwrap Plate	Dimensions B		Number of Teeth
			in.	(mm)	
E06/Z06-10	060-10-12PZ	060-10-12	.65	(16.5)	1
E06/Z06-16	060-16-12PZ	060-16-12	.89	(22.5)	2
E06/Z06-20	060-20-12PZ	060-20-12	1.06	(27.0)	2

Additional Accessories



Quicksnap - the complete, detachable mounting unit, upon request

Part No.

060-10-QS

060-16-QS

060-20-QS



Quickfix - mounting bracket with dowel, upon request

Part No. 060-20-34QZ

PDF: igus.com/e-chain-pdfs
Product information: igus.com/e-chains

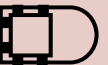

Price Index



Series E065/Z065

Special Features / Options

IPA Qualification Certificate
Air Cleanliness Class ISO Class 2
(at v = 3.28 ft/s) upon request

Flammability Class
VDE 0304 IIC UL94 V2

Torsional motion possible

Special equipment: Electrically
conductive ESD/ATEX version
upon request

Assembly Tips



Just push the cables into the e-chain
using your thumb

Features & Benefits

- 1 Mounting bracket with integrated strain relief
- 2 Small pitch for low-noise and smooth operation
- 3 Very lightweight
- 4 Patented push button design holds the links together
- 5 Very easy to fill
- 6 Cable friendly - smooth interior
- 7 Limited torsion tolerance
- 8 Split crossbar along the inner and outer radius
- 9 1-, 2-, 3- and 4-chamber system available

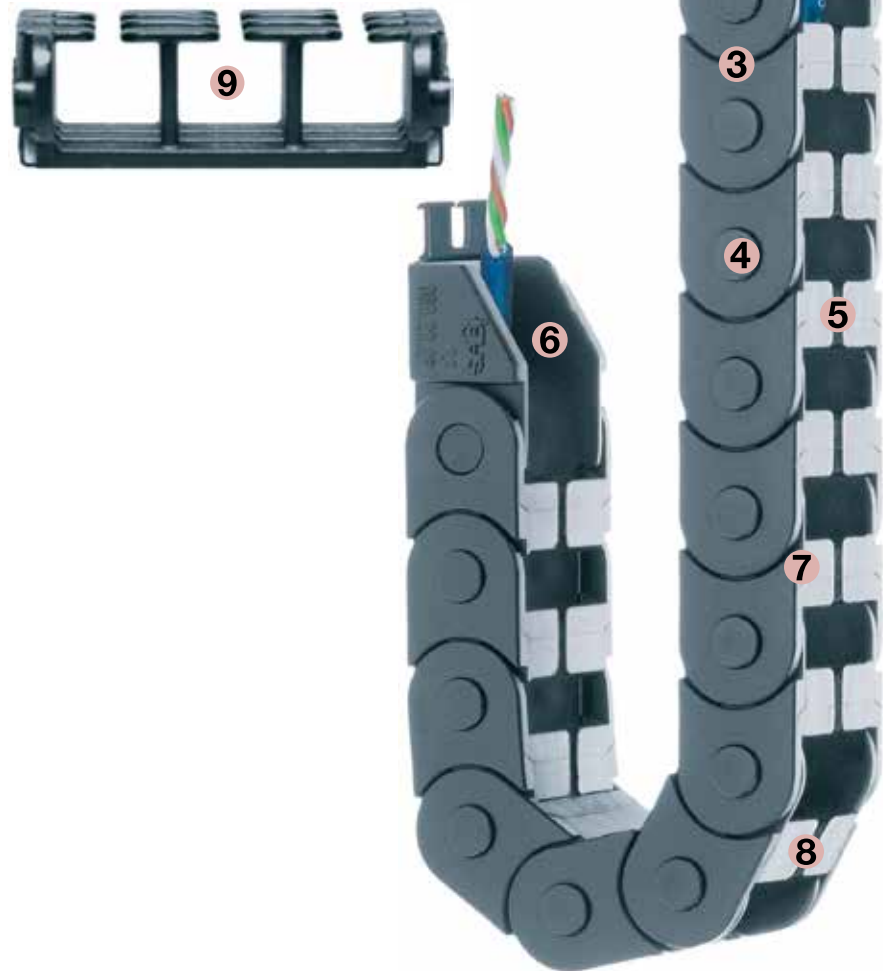

Usage Guidelines



- If filling is required without opening and closing
- If price is an issue
- If quiet operation is required



- If high loads and long unsupported lengths are present
➤ Series 06 E2 Micro

Order Example: Complete e-chain®
Please indicate chain length or number of links. Example:

3.28 ft (1 m) E065-16-038-0

e-chain®

1 Set 0650-16-12PZ

Mounting Bracket

e-chain system® E-Z chain

Series E065/Z065

Installation Dimensions



E065
Z065

Short travel, unsupported length

- FL_B = unsupported with permitted sag
 - FL_G = unsupported with straight upper run
- Further information ► Design, Chapter 1

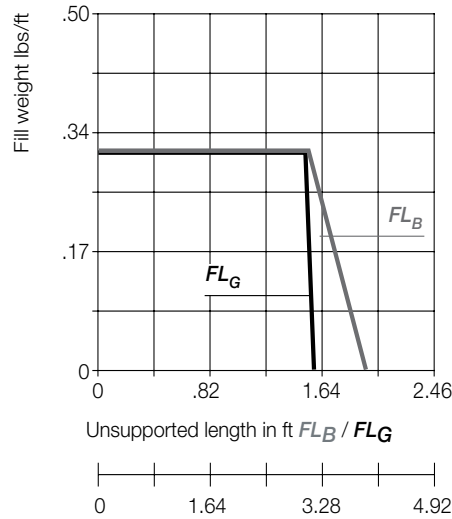
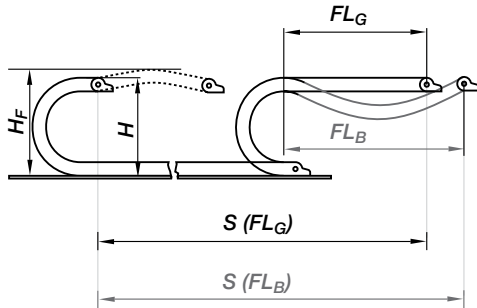

Short Travels - Unsupported



Unsupported E-Chains® feature positive camber over short travels. This must be accounted for when specifying the clearance height. Please refer to **Installation dimensions** for further details.

Legend

- S = Length of travel
- R = Bending radius
- H = Nominal clearance height
- D = Overlength e-chain® radius in final position
- $K = \pi \cdot R + \text{safety buffer}$
- H_F = Required clearance height

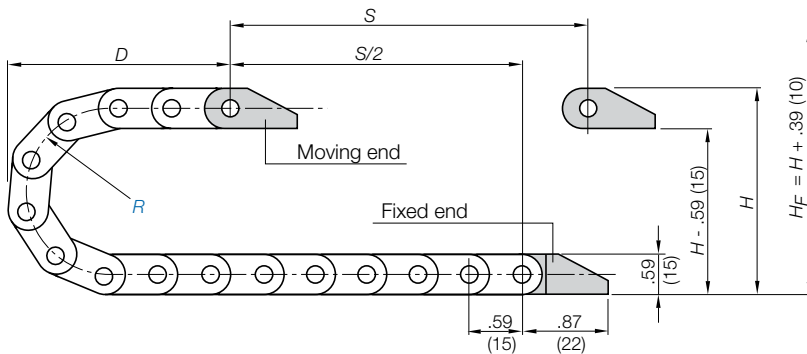

Pitch per link = $.59^\circ$ (15 mm)

Links per ft (m) = 20.34 (67)

For center mount applications:

Chain length = $\frac{S}{2} + K$

The required clearance height: $H_F = H + .39$ in. (10 mm) (with .13 lbs/ft (0.2 kg/m) fill weight). Please consult igus® if space is particularly restricted.

R	.71 (018)	1.10 (028)	1.50 (038)
H*	2.01 (51)	2.80 (71)	3.58 (91)
D	1.89 (48)	2.28 (58)	3.68 (68)
K	3.54 (90)	4.72 (120)	5.91 (150)

Speed / acceleration FL_G	max. 65.6 ft/s (20 m/s) / max. 656 ft/s ² (200 m/s ²)
Speed / acceleration FL_B	max. 9.84 ft/s (3 m/s) / max. 19.69 ft/s ² (6 m/s ²)
Gliding speed / acceleration (maximum)	max. 9.84 ft/s (3 m/s) / max. 32.8 ft/s ² (10 m/s ²)
Material (e-chain®) - permitted temperature	igumid NB / -40°F (-40°C) up to +176°F (+80°C)
Material (mounting brackets)* - permitted temperature	igumid G / -40°F (-40°C) up to +248°F (+120°C)
Flammability Class (e-chain®), igumid NB	VDE 0304 IIC UL94 V2
Flammability Class (mounting brackets), igumid G*	VDE 0304 IIC UL94 HB

*Available in igumid NB upon request, please consult igus® for delivery time

Technical Data



Details of material properties

► Chapter 1



PDF: igus.com/e-chain-pdfs
Product information: igus.com/e-chains



Series E065
Split crossbar along the outer radius



Part Number Structure

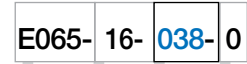

Color - Black
Bending radius
Width
Series

1 Chamber System

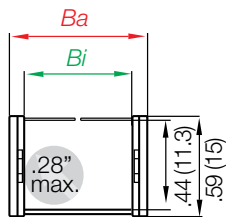

2 Chamber System

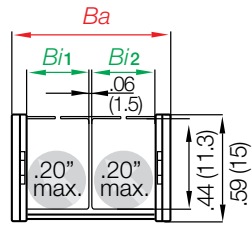

3 Chamber System

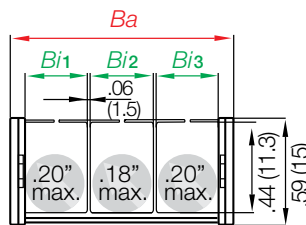

4 Chamber System

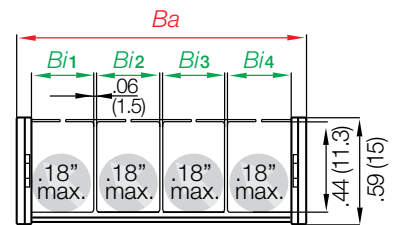

Supplement part number with required radius. Example: E065-16-**038**-0
Pitch: .59 in. (15 mm) per link links/ft (m) = 20.34 (67)

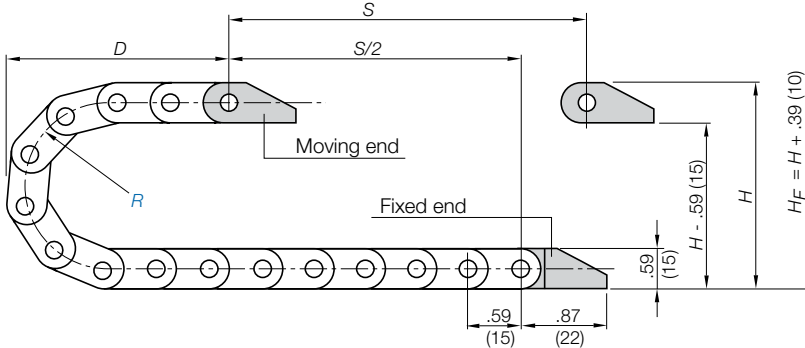

Part Number	Bi in. (mm)	Ba in. (mm)	Weight lbs/ft (kg/m)
1 Chamber System			
E065-16- <input type="text"/> -0*	.63 (16)	.98 (24.8)	≈ 0.11 (0.17)
2 Chamber System			
E065-2/9- <input type="text"/> -0*	.35/.35 (9/9)	1.15 (29.3)	≈ 0.13 (0.19)
3 Chamber System			
E065-3/9- <input type="text"/> -0*	.35/.35/.35 (9/9/9)	1.55 (39.3)	≈ 0.15 (0.22)
4 Chamber System			
E065-4/9- <input type="text"/> -0*	.35/.35/.35/.35 (9/9/9/9)	1.94 (49.3)	≈ 0.17 (0.25)

Choose from the radii below for all of the above sizes
Radius (mm) Example: E065-16-**038**-0

R	018	028	038
R	.71 (018)	1.10 (028)	1.50 (038)
H*	2.01 (51)	2.80 (71)	3.58 (91)
D	1.89 (48)	2.28 (58)	3.68 (68)
K	3.54 (90)	4.72 (120)	5.91 (150)

* Crossbars do not overlap. There is a gap of .10" (2.5mm)

Series Z065

Split crossbar along the inner radius



Part Number Structure

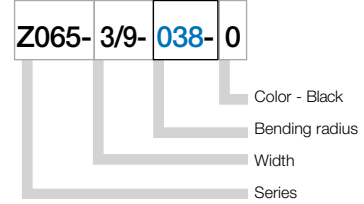

3 Chamber System

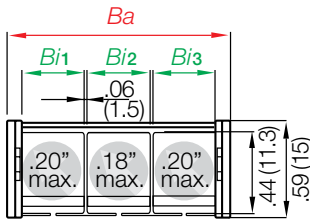

Supplement part number with required radius. Example: Z065-3/9-038-0

Pitch: 2.20 in. (56 mm) per link links/ft (m) = 5.49 (18)

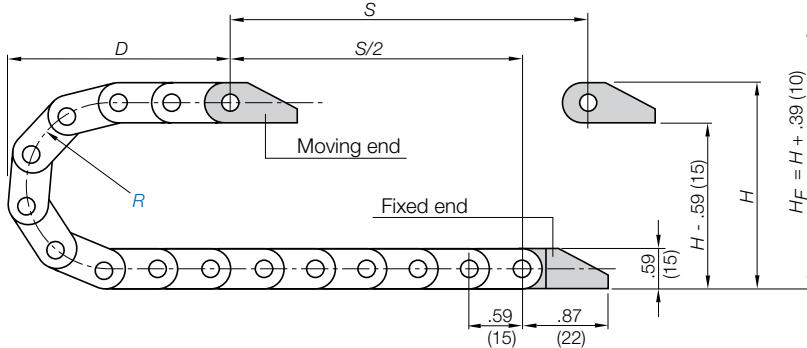

Part Number	<i>Bi</i> in. (mm)	<i>Ba</i> in. (mm)	Weight lbs/ft (kg/m)
Z065-3/9- <input type="text"/> -0	.35/.35/.35 (9/9/9)	1.55 (39.3)	≈ 0.15 (0.22)

Choose from the radii below for all of the above sizes
Radius (mm) Example: Z065-3/9-038-0

	018	028	038
R	.71 (018)	1.10 (028)	1.50 (038)
H*	2.01 (51)	2.80 (71)	3.58 (91)
D	1.89 (48)	2.28 (58)	3.68 (68)
K	3.54 (90)	4.72 (120)	5.91 (150)





Polymer, one-piece

- One-piece mounting bracket
- Corrosion resistant
- Available preassembled
- Inner and outer attachment possible
- Available with integrated strain relief tiewrap plates

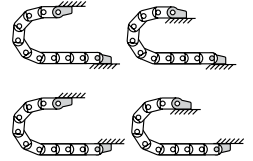
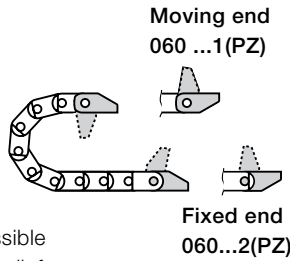

Possible installation configurations -

Dimensions and order configurations

Strain relief is possible on the moving end and/or the fixed end.

Part Number Structure

0650-	3/99-	12	PZ
-------	-------	----	----

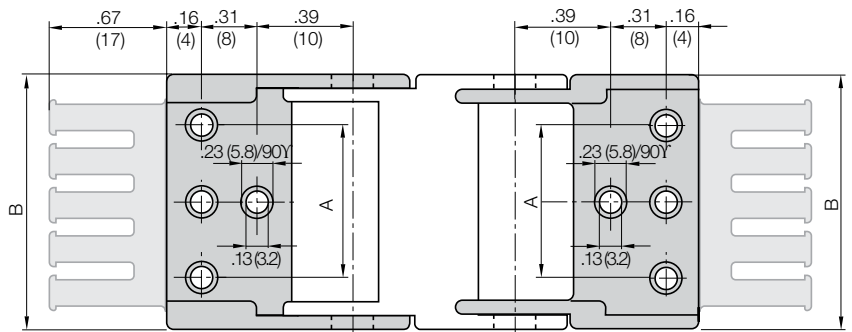
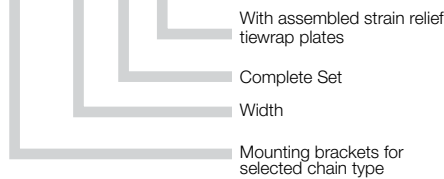

Full set, for both ends:

0650-3/9-12 PZ Full set, each part with pin/bore

Single-part order:

0650-3/9-1 PZ Mounting bracket with bore

0650-3/9-2 PZ Mounting bracket with pin

Chain Type	Part No. Full set with Tiewrap Plate	Part No. Full Set without Tiewrap Plate	Dimensions A		Dimensions B		Number of Teeth
			in.	(mm)	in.	(mm)	
E065-16-	0650-16-12PZ	0650-16-12	—	—	.89	(22.5)	2
E065-2/9	0650-2/9-12PZ	0650-2/9-12	—	—	1.06	(27)	2
E065/Z065-3/9	0650-3/9-12PZ	0650-3/9-12	.87	(22)	1.46	(37)	3
E065-4/9	0650-4/9-12PZ	0650-4/9-12	1.26	(32)	1.85	(47)	4

Additional Accessories



Quicksnap - the complete, detachable mounting unit, upon request



Quickfix - mounting bracket with dowel, upon request

e-chain system® E-Z chain
Series E065/Z065

Series

igus®
e-chain system®

Telephone 1-800-521-2747

Internet: igus.com
email: sales@igus.com
QuickSpec: igus.com/quickspec



Price Index



Series E08/Z08

Special Features / Options



IPA Qualification Certificate
Air Cleanliness Class ISO Class 2
(at v = 3.28 ft/s) upon request



Flammability Class
VDE 0304 IIC UL94 V2



Special equipment: Electrically
conductive ESD/ATEX version
upon request

Assembly Tips



Just push the cables into the e-chain
using your thumb

Usage Guidelines



- If filling is required without opening and closing
- If price is an issue
- If quiet operation is required



- "Z" Series is unsuitable for gliding applications
► Series 09 Zipper

Features & Benefits

- 1 Cable-friendly interior
- 2 Small pitch for low-noise and smooth operation
- 3 Lightweight
- 4 Patented push button design holds the links together
- 5 Integrated strain relief option
- 6 Very easy to fill
- 7 "E" Series features split crossbar along the outer radius
- 8 "Z" Series features split crossbar along the inner radius
- 9 Limited torsion tolerance



Order Example: Complete e-chain®

Please indicate chain length or number of links. Example:

3.28 ft (1 m) E08-30-038-0

e-chain®

1 Set 080-30-12PZ

Mounting Bracket

e-chain system® E-Z chain

Series E08/Z08

Installation Dimensions



E08
Z08

Short travel, unsupported length

- FL_B = unsupported with permitted sag
 - FL_G = unsupported with straight upper run
- Further information ► Design, Chapter 1

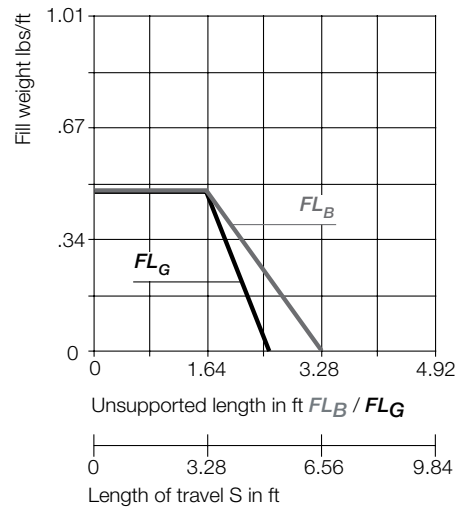
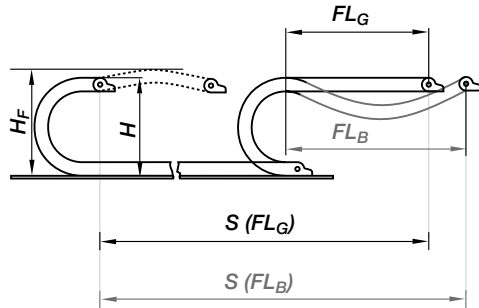

Short Travels - Unsupported



Unsupported E-Chains® feature positive camber over short travels. This must be accounted for when specifying the clearance height. Please refer to **Installation dimensions** for further details.

Legend

- S = Length of travel
- R = Bending radius
- H = Nominal clearance height
- D = Overlength e-chain® radius in final position
- $K = \pi \cdot R + \text{safety buffer}$
- H_F = Required clearance height

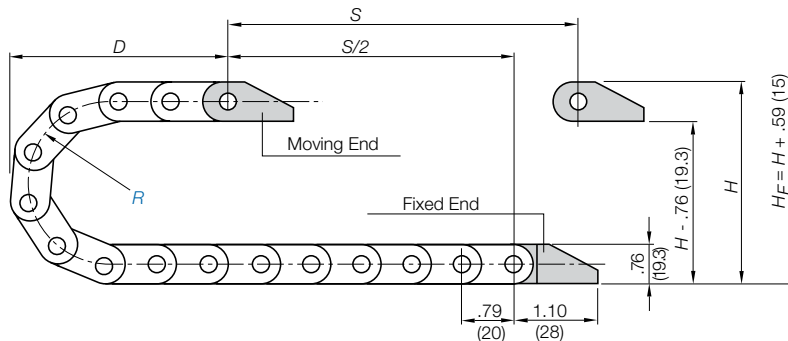

Pitch per link: = .79" (20 mm)
 Links per ft (m): = 15.24 (50)
 For center mount applications:
 Chain length = $\frac{S}{2} + K$

The required clearance height: $H_F = H + .59$ in. (15 mm) (with .20 lbs/ft (0.3 kg/m) fill weight. Please consult igus® if space is particularly restricted.

R	1.10 (028)	1.50 (038)	1.89 (048)
H	2.95 (75)	3.74 (95)	4.53 (115)
D	2.68 (68)	3.07 (78)	3.46 (88)
K	5.12 (130)	6.30 (160)	7.68 (195)

Speed / acceleration FL_G	max. 65.6 ft/s (20 m/s) / max. 656 ft/s ² (200 m/s ²)
Speed / acceleration FL_B	max. 9.84 ft/s (3 m/s) / max. 19.69 ft/s ² (6 m/s ²)
Gliding speed / acceleration (maximum)	max. 9.84 ft/s (3 m/s) / max. 32.8 ft/s ² (10 m/s ²)
Material (e-chain®) - permitted temperature	igumid NB / -40°F (-40°C) up to +176°F (+80°C)
Material (mounting brackets)* - permitted temperature	igumid G / -40°F (-40°C) up to +248°F (+120°C)
Flammability Class (e-chain®), igumid NB	VDE 0304 IIC UL94 V2
Flammability Class (mounting brackets), igumid G*	VDE 0304 IIC UL94 HB

Technical Data



Details of material properties

► Chapter 1



PDF: igus.com/e-chain-pdfs
 Product information: igus.com/e-chains



Series E08 - Split crossbar along the outer radius

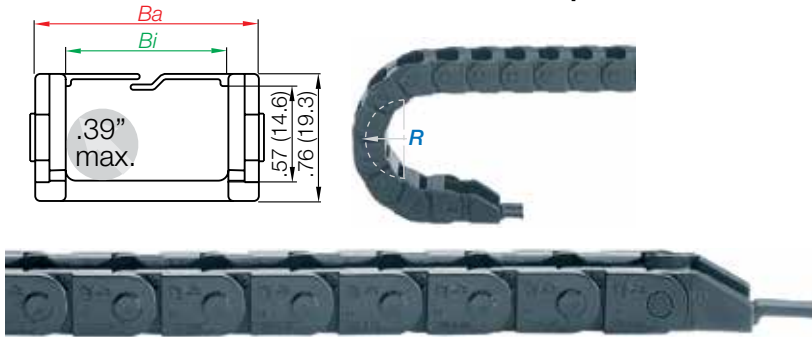

Part Number Structure

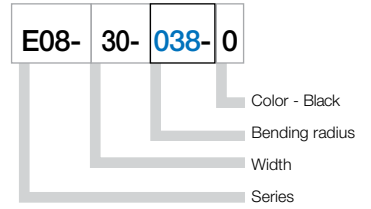

Series Z08 - Split crossbar along the inner radius

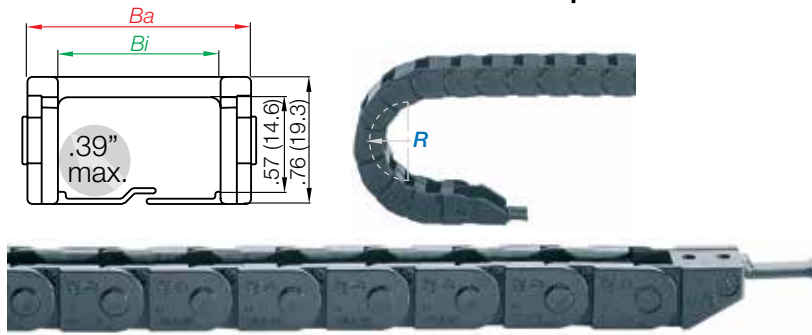

Part Number Structure

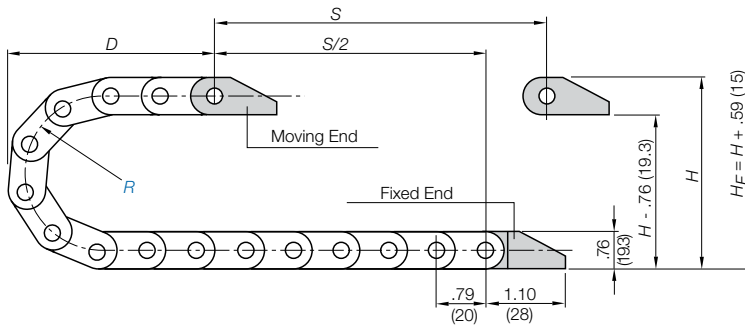
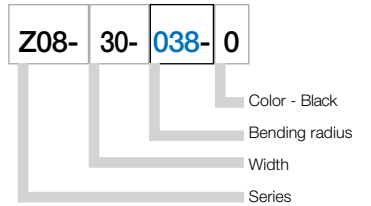

Supplement part number with required radius. Example: E08-10-038-0
Pitch: .79 in. (20 mm) per link links/ft (m) = 15.24 (50)

Part Number			Bi	Ba	Weight
Split Crossbar	Split Crossbar		in. (mm)	in. (mm)	lbs/ft (kg/m)
Outer Radius	Inner Radius				
E08-10-	Z08-10-	<input type="checkbox"/> -0	.39 (10)	.72 (18.2)	≈ 0.14 (0.21)
E08-16-	Z08-16-	<input type="checkbox"/> -0	.63 (16)	.95 (24.2)	≈ 0.16 (0.24)
E08-20-	Z08-20-	<input type="checkbox"/> -0	.79 (20)	1.11 (28.2)	≈ 0.17 (0.25)
E08-30-	Z08-30-	<input type="checkbox"/> -0	1.18 (30)	1.50 (38.2)	≈ 0.19 (0.28)
E08-40-	Z08-40-	<input type="checkbox"/> -0	1.57 (40)	1.90 (48.2)	≈ 0.21 (0.31)
E08-50-	Z08-50-	<input type="checkbox"/> -0	1.97 (50)	2.29 (58.2)	≈ 0.25 (0.37)

Choose from the radii below for all of the above sizes
Radius (mm) Example: E08-10-038-0

	028	038	048
R	1.10 (28)	1.50 (38)	1.89 (48)
H	2.95 (75)	3.74 (95)	4.53 (115)
D	2.68 (68)	3.07 (78)	3.46 (88)
K	5.12 (130)	6.30 (160)	7.68 (195)

0=Standard color black. For other colors see Chapter 1

e-chain system® E-Z chain Series E08/Z08 Mounting Brackets



E08
Z08



Plastic, one-piece

- One-piece mounting bracket
- Corrosion resistant
- Available preassembled
- Inner and outer attachment possible
- Available with or without integrated strain relief tiwrap plates

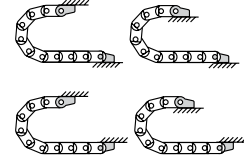
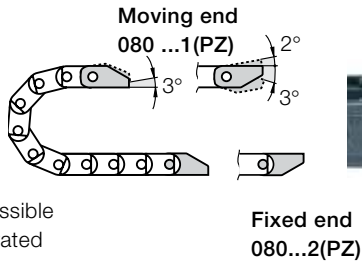

Possible installation configurations -

Dimensions and order configurations

Strain relief is possible on the moving end and/or the fixed end.

Part Number Structure



- With assembled strain relief tiwrap plates
- Complete Set
- Width
- Mounting brackets for selected chain type

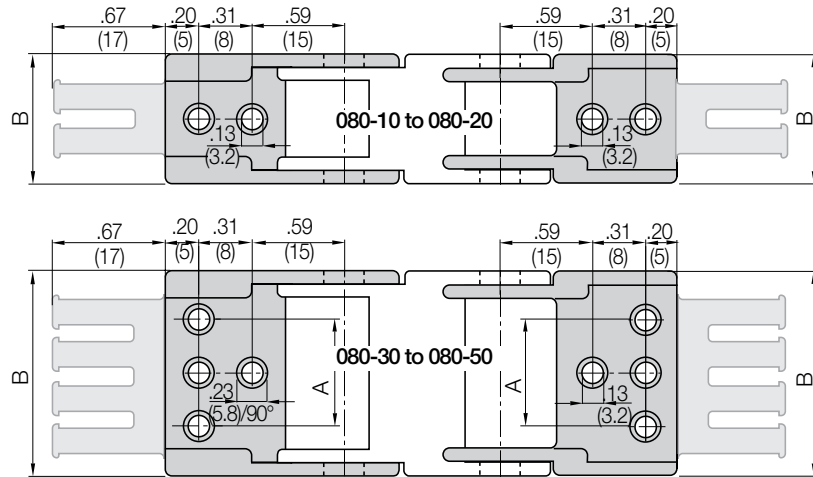

Full set, for both ends:

080-20-12-PZ Full set, each part with pin/bore

Single-part order:

080-20-1-PZ Mounting bracket with bore

080-20-2-PZ Mounting bracket with pin

080-10-12 - 080-20-12: Center bores only

080-30-12 - 080-50-12: Outer bores only

Chain Type	Part No. Full set with Tiwrap Plate	Part No. Full Set without Tiwrap Plate	Dimension A		Dimensions B		Number of Teeth
			in.	(mm)	in.	(mm)	
E08/Z08-10	080-10-12PZ	080-10-12	—	—	.72	(18.2)	1
E08/Z08-16	080-16-12PZ	080-16-12	—	—	.95	(24.2)	2
E08/Z08-20	080-20-12PZ	080-20-12	—	—	1.11	(28.2)	2
E08/Z08-30	080-30-12PZ	080-30-12	.87	(22)	1.50	(38.2)	3
E08/Z08-40	080-40-12PZ	080-40-12	1.26	(32)	1.90	(48.2)	4
E08/Z08-50	080-50-12PZ	080-50-12	1.65	(42)	2.29	(58.2)	5

Additional Accessories



Quicksnap - the complete, detachable mounting unit, upon request

Part No.

080-20-QS

080-30-QS

PDF: igus.com/e-chain-pdfs
Product information: igus.com/e-chains

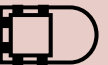

E14
Z14



e-chain system® E-Z chain Series E14/Z14



Price Index



Series E14/Z14

Special Features / Options

 IPA Qualification Certificate
Air Cleanliness Class ISO Class 2
(at v = 3.28 ft/s) upon request

 Flammability Class
VDE 0304 IIC UL94 V2

 IPA Qualification Certificate: ESD
Classification Level 1 (for Series
E14-3-038). Special equipment:
Electrically conductive ESD/ATEX
version upon request

Assembly Tips



Just push the cables into the e-chain
using your thumb

Usage Guidelines



- If filling is required without opening and closing
- If price is an issue
- If quiet operation is required



- "Z" Series is unsuitable for gliding applications
➤ Series B15 E2 Mini
- If a long unsupported length is required
➤ Series B15 E2 Mini

Features & Benefits

- 1 Small pitch for low-noise and smooth operation
- 2 Cable-friendly interior
- 3 Limited torsion tolerance
- 4 Very easy to fill
- 5 Integrated strain relief option
- 6 Patented push button design holds the links together
- 7 "E" Series features split crossbar along the outer radius
- 8 "Z" Series features split crossbar along the inner radius



Order Example: Complete e-chain®

Please indicate chain length or number of links. Example:

3.28 ft (1 m) E14-3-038-0

 e-chain®

1 Set 114-3-12PZ

 Mounting Bracket

e-chain system® E-Z chain Series E14/Z14 Installation Dimensions



E14
Z14

Short travel, unsupported length

- FL_B = unsupported with permitted sag
 - FL_G = unsupported with straight upper run
- Further information ► Design, Chapter 1

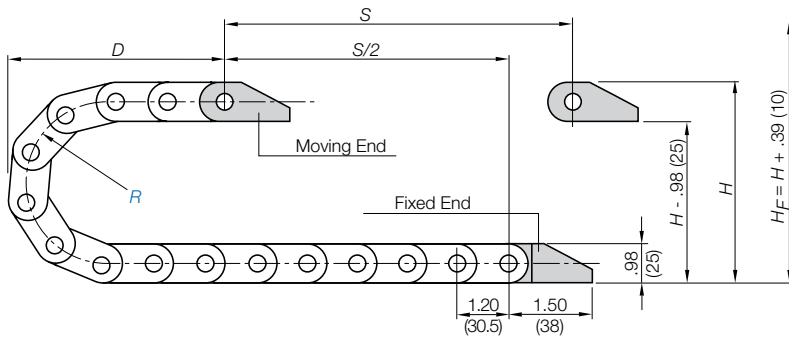
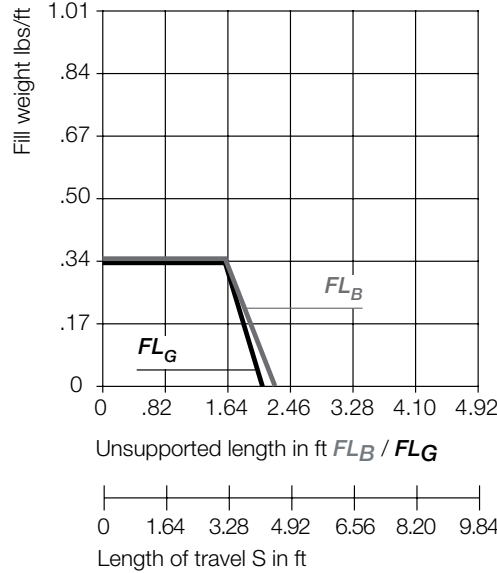
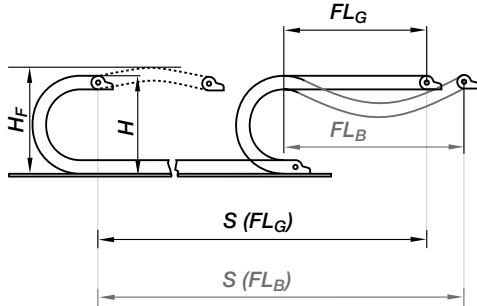

Pitch per link = 1.20" (30.5 mm)
Links per ft (m) = 10.06 (33)
For center mount applications:
Chain length = $\frac{S}{2} + K$

The required clearance height: $H_F = H + .39$ in. (10 mm) (with .13 lbs/ft (0.2 kg/m) fill weight). Please consult igus® if space is particularly restricted.

R	1.10 (028)	1.50 (038)	1.89 (048)	2.95 (075)	3.94 (100)	4.92 (125)
H	3.19 (81)	3.98 (101)	4.76 (121)	6.89 (175)	8.86 (225)	10.83 (275)
D	3.35 (86)	3.78 (96)	4.17 (106)	5.24 (133)	6.22 (158)	7.20 (183)
K	5.91 (150)	7.28 (185)	8.46 (215)	11.81 (300)	14.96 (380)	17.91 (455)

Short Travels - Unsupported



Unsupported E-Chains® feature positive camber over short travels. This must be accounted for when specifying the clearance height. Please refer to **Installation dimensions** for further details.

Legend

- S = Length of travel
- R = Bending radius
- H = Nominal clearance height
- D = Overlength e-chain® radius in final position
- $K = \pi \cdot R + \text{safety buffer}$
- H_F = Required clearance height



PDF: igus.com/e-chain-pdfs
Product information: igus.com/e-chains



Speed / acceleration FL_G	max. 65.6 ft/s (20 m/s) / max. 656 ft/s ² (200 m/s ²)
Speed / acceleration FL_B	max. 9.84 ft/s (3 m/s) / max. 19.69 ft/s ² (6 m/s ²)
Gliding speed / acceleration (maximum)	max. 9.84 ft/s (3 m/s) / max. 32.8 ft/s ² (10 m/s ²)
Material (e-chain®) - permitted temperature	igumid NB / -40°F (-40°C) up to +176°F (+80°C)
Material (mounting brackets)* - permitted temperature	igumid G / -40°F (-40°C) up to +248°F (+120°C)
Flammability Class (e-chain®), igumid NB	VDE 0304 IIC UL94 V2
Flammability Class (mounting brackets), igumid G*	VDE 0304 IIC UL94 HB

*Available in igumid NB upon request, please consult igus® for delivery time

Technical Data



Details of material properties

► Chapter 1

Series E14 - Split crossbar along the outer radius

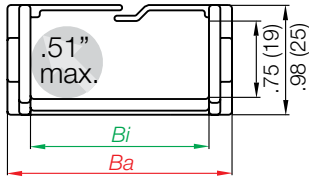

Part Number Structure

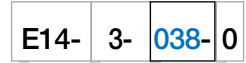

Color - Black
Bending radius
Width
Series



Series Z14 - Split crossbar along the inner radius

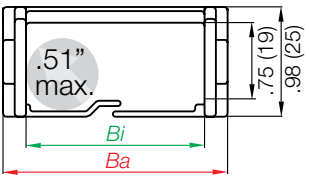

Part Number Structure



Color - Black
Bending radius
Width
Series

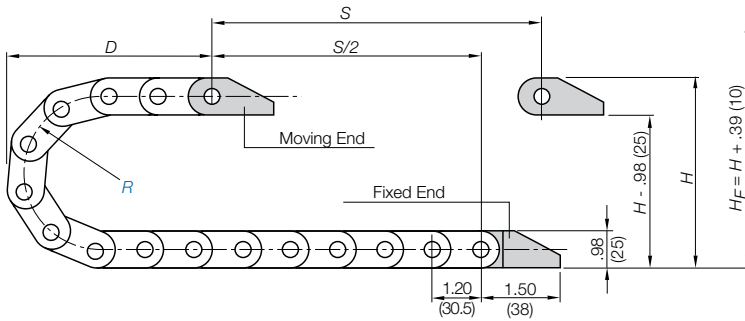

Supplement part number with required radius. Example: E14-3--0

Pitch: 1.20 in. (30.5 mm) per link links/ft (m) = 10.06 (33)

Part Number

Split Crossbar	Split Crossbar			Bi	Ba	Weight
Outer Radius	Inner Radius			in. (mm)	in. (mm)	lbs/ft (kg/m)
E14-1-	Z14-1-	<input type="text" value=""/>	-0	.59 (15)	1.06 (27)	≈ 0.21 (0.31)
E14-2-	Z14-2-	<input type="text" value=""/>	-0	.98 (25)	1.46 (37)	≈ 0.22 (0.32)
E14-3-	Z14-3-	<input type="text" value=""/>	-0	1.50 (38)	1.97 (50)	≈ 0.27 (0.40)
E14-4-	Z14-4-	<input type="text" value=""/>	-0	1.97 (50)	2.44 (62)	≈ 0.30 (0.44)

Choose from the radii below for all of the above sizes
Radius (mm) Example: E14-3--0

	<input type="text" value="028"/>	<input type="text" value="038"/>	<input type="text" value="048"/>	<input type="text" value="075"/>	<input type="text" value="100"/>	<input type="text" value="125"/>
R	1.10 (028)	1.50 (038)	1.89 (048)	2.95 (075)	3.94 (100)	4.92 (125)
H	3.19 (81)	3.98 (101)	4.76 (121)	6.89 (175)	8.86 (225)	10.83 (275)
D	3.35 (86)	3.78 (96)	4.17 (106)	5.24 (133)	6.22 (158)	7.20 (183)
K	5.91 (150)	7.28 (185)	8.46 (215)	11.81 (300)	14.96 (380)	17.91 (455)

0=Standard color black. For other colors see Chapter 1

e-chain system® E-Z chain Series E14/Z14 Mounting Brackets



E14
Z14



Plastic, one-piece

- One-piece mounting bracket
- Corrosion resistant
- Available preassembled
- Inner and outer attachment possible
- Available with or without strain relief tiewrap plates

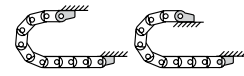
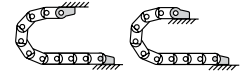
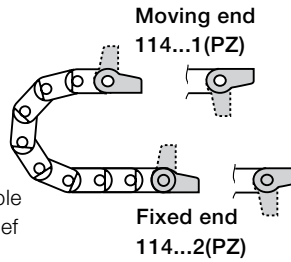

Possible installation configurations -

Dimensions and order configurations

Strain relief is possible on the moving end and/or the fixed end.

Part Number Structure

114-	20-	12	P	PZ
------	-----	----	---	----

- With assembled strain relief tiewrap plates
- Without assembled strain relief tiewrap plates
- Complete Set
- Width
- Mounting brackets for selected chain type

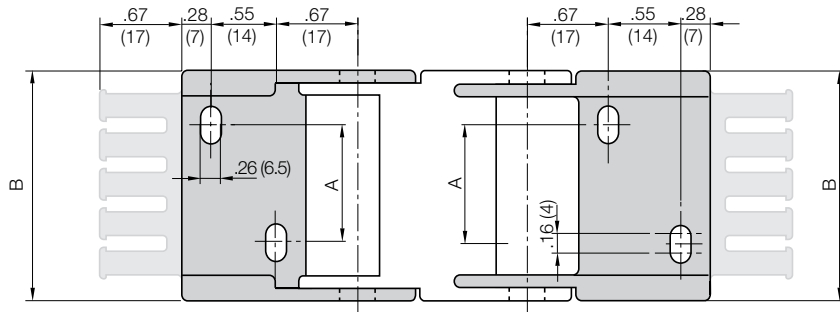

Full set, for both ends:

114- 20- 12 PZ

Full set, each part with pin/bore + tiewrap plate

Single-part order:

114- 20- 1 PZ

Mounting bracket with bore + tiewrap plate

114- 20- 2 PZ

Mounting bracket with pin + tiewrap plate

Chain Type	Part No.	Part No.	Dimension A		Dimensions B		Number of Teeth
	Full set with Tiewrap Plate	Full Set without Tiewrap Plate	in.	(mm)	in.	(mm)	
E14/Z14-1	114-1-12PZ	114-1-12P	—	—	1.04	(26.3)	2
E14/Z14-2	114-2-12PZ	114-2-12P	.39	(10)	1.43	(36.3)	3
E14/Z14-3	114-3-12PZ	114-3-12P	.91	(23)	1.94	(49.3)	4
E14/Z14-4	114-4-12PZ	114-4-12P	1.38	(35)	2.41	(61.3)	5

Additional Accessories



Quickfix - mounting bracket with dowel, upon request

Part No.
114-3-12QZ

PDF: igus.com/e-chain-pdfs
Product information: igus.com/e-chains

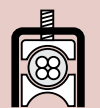

E200
Z200



e-chain system® E-Z chain Series E200/Z200



Price Index



Series E200/Z200

Special Features / Options

 IPA Qualification Certificate
Air Cleanliness Class ISO Class 2
(at v = 3.28 ft/s) upon request

 Flammability Class
VDE 0304 IIC UL94 V2

 Special equipment: Electrically
conductive ESD/ATEX version
upon request

Assembly Tips

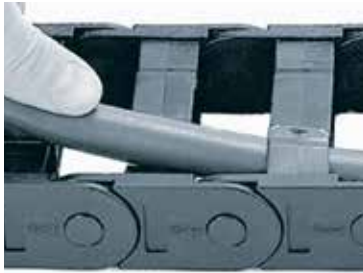

Just push the cables into the e-chain
using your thumb

Other Installation Methods

- Vertical, hanging ≤ 32.8 ft (10 m)
- Vertical, standing ≤ 4.92 ft (1.5 m)
- Side-mounted, un_supp. ≤ 1.64 ft (0.5 m)
- Rotary requires further calculation

Usage Guidelines



- If filling is required without opening and closing
- If price is an issue
- If quiet operation is required



- If a long unsupported length is required
 - Series 2400/2500 E2/000
- If single extrusion crossbars are required
 - Series 2400/2500 E2/000

Features & Benefits

- 1 Mounting bracket with integrated strain relief
- 2 Large pins for long service life
- 3 Patented push button design holds the links together
- 4 Limited torsion tolerance
- 5 "E" Series features split crossbar along the outer radius
- 6 Dirt-repellant exterior
- 7 Cable-friendly interior
- 8 "Z" Series features split crossbar along the inner radius
- 9 Very easy to fill - cables only have to be pushed in
- 10 1- or 2-chamber system available

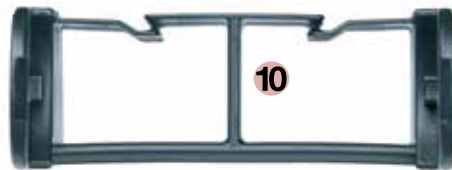

Order Example: Complete e-chain®

Please indicate chain length or number of links. Example:

3.28 ft (1 m) E200-05-100-0

 e-chain®

1 Set 2050-34PZB

 Mounting Bracket

e-chain system® E-Z chain Series E200/Z200 Installation Dimensions



E200
Z200

Short travel, unsupported length

- FL_B = unsupported with permitted sag
 - FL_G = unsupported with straight upper run
- Further information ► Design, Chapter 1

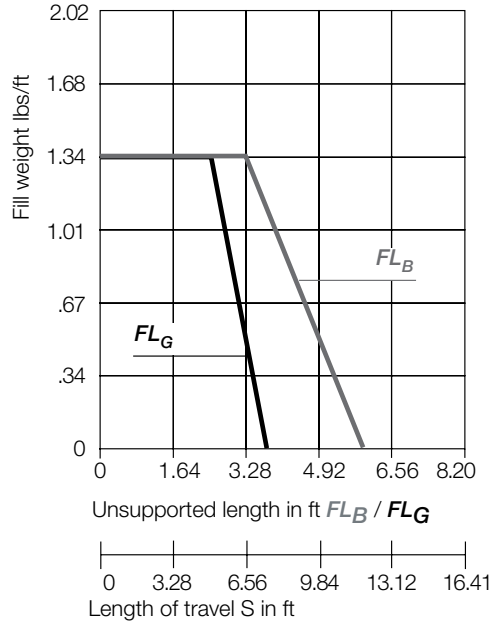
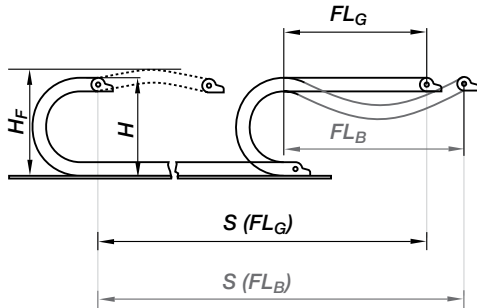

Short Travels - Unsupported



Unsupported E-Chains® feature positive camber over short travels. This must be accounted for when specifying the clearance height. Please refer to **Installation dimensions** for further details.

Legend

- S = Length of travel
- R = Bending radius
- H = Nominal clearance height
- D = Overlength e-chain® radius in final position
- $K = \pi \cdot R + \text{safety buffer}$
- H_f = Required clearance height

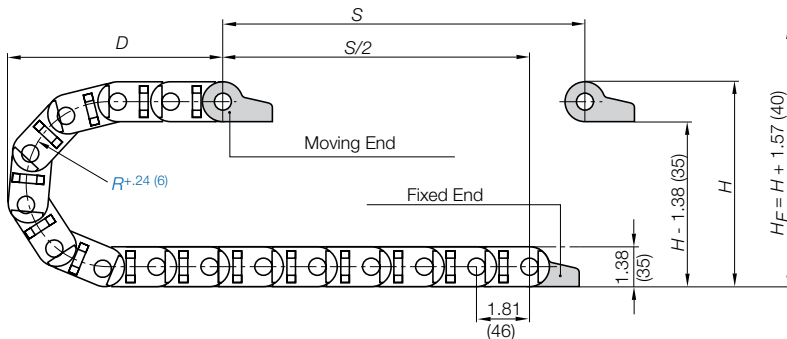

Pitch per link: = 1.81" (46 mm)
Links per ft (m): = 6.71 (22)
For center mount applications:
Chain length = $S/2 + K$

The required clearance height: $H_f = H + 1.57$ in. (40 mm) (with 1.68 lbs/ft (2.5 kg/m) fill weight). Please consult igus® if space is particularly restricted.

R	2.16 (055)	2.95 (075)	3.94 (100)	5.91 (150)	7.87 (200)
H^{+4}	5.71 (145)	7.28 (185)	9.25 (235)	13.19 (335)	17.12 (435)
D	5.59 (142)	6.38 (162)	7.36 (187)	9.33 (237)	11.30 (287)
K	10.43 (265)	12.99 (330)	16.14 (410)	22.24 (565)	28.54 (725)

Speed / acceleration FL_G	max. 65.6 ft/s (20 m/s) / max. 656 ft/s ² (200 m/s ²)
Speed / acceleration FL_B	max. 9.84 ft/s (3 m/s) / max. 19.69 ft/s ² (6 m/s ²)
Gliding speed / acceleration (maximum)	max. 9.84 ft/s (3 m/s) / max. 32.8 ft/s ² (10 m/s ²)
Material (e-chain®) - permitted temperature	igumid NB / -40°F (-40°C) up to +176°F (+80°C)
Material (mounting brackets)* - permitted temperature	igumid G / -40°F (-40°C) up to +248°F (+120°C)
Flammability Class (e-chain®), igumid NB	VDE 0304 IIC UL94 V2
Flammability Class (mounting brackets), igumid G*	VDE 0304 IIC UL94 HB

*Available in igumid NB upon request, please consult igus® for delivery time

Technical Data



Details of material properties

► Chapter 1



PDF: igus.com/e-chain-pdfs
Product information: igus.com/e-chains



Series E200
Split crossbar along the outer radius



Series Z200
Split crossbar along the inner radius

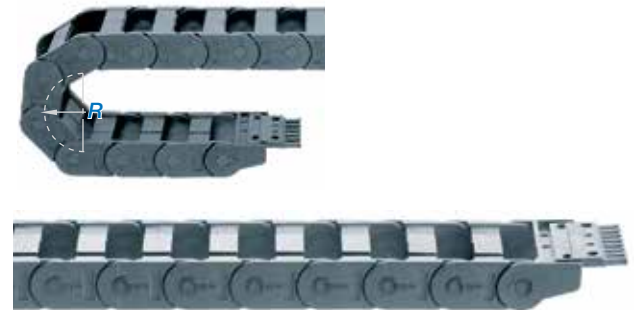

Single Chamber System

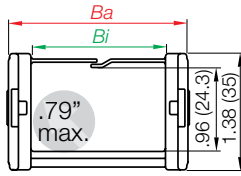

2 Chamber System
1 chamber from each width is shown
Actual carrier will have 2 chambers of the same size.

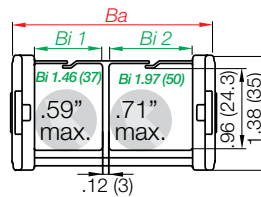

Single Chamber System

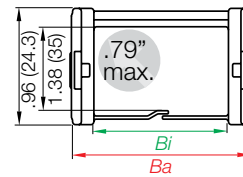

2 Chamber System
1 chamber from each width is shown
Actual carrier will have 2 chambers of the same size.

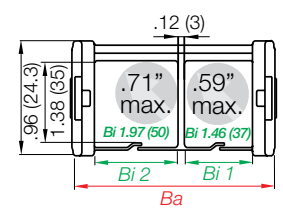

Supplement part number with required radius. Example: E200-05-100-0
Pitch: 1.81 in. (46 mm) per link links/ft (m) = 6.71 (22)

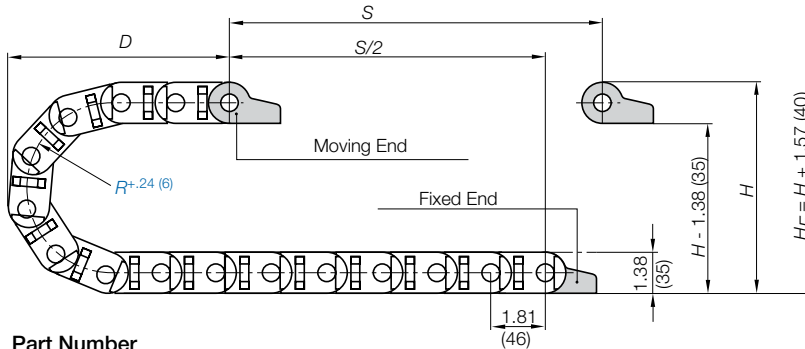

Part Number Structure

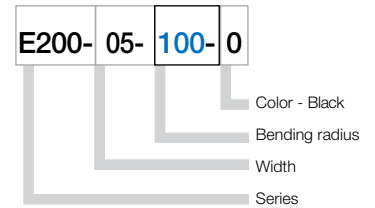

Part Number
Single Chamber System

Split Crossbar	Split Crossbar		Bi	Ba	Weight
Outer radius	Inner Radius		in. (mm)	in. (mm)	lbs/ft (kg/m)
E200-05-	Z200-05-	<input type="text"/> -0	2.24 (57)	2.93 (74.4)	≈ 0.47 (0.70)

Part Number
2 Chamber System

Split Crossbar	Split Crossbar		Bi 1	Bi 2	Ba	Weight
Outer radius	Inner Radius		in. (mm)	in. (mm)	in. (mm)	lbs/ft (kg/m)
E200-2/35-	Z200-2/35-	<input type="text"/> -0	1.46 (37)	1.46 (37)	3.72 (94.4)	≈ 0.53 (0.79)
E200-2/50-	Z200-2/50-	<input type="text"/> -0	1.97 (50)	1.97 (50)	4.74 (120.4)	≈ 0.55 (0.82)

Choose from the radii below for all of the above sizes
Radius (mm) Example: E200-05-100-0

	055	075	100	150	200
R	2.16 (055)	2.95 (075)	3.94 (100)	5.91 (150)	7.87 (200)
H ⁺	5.71 (145)	7.28 (185)	9.25 (235)	13.19 (335)	17.12 (435)
D	5.59 (142)	6.38 (162)	7.36 (187)	9.33 (237)	11.30 (287)
K	10.43 (265)	12.99 (330)	16.14 (410)	22.24 (565)	28.54 (725)

0=Standard color black. For other colors see Chapter 1

e-chain system® E-Z chain

Series E200/Z200

Mounting Brackets



E200
Z200



Option 1: pivoting

- Short and long travels
- Space-restricted conditions
- Corrosion resistant

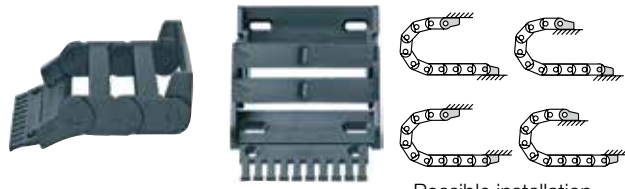
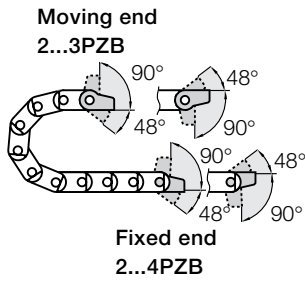

Possible installation configurations -

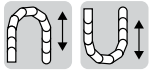

Option 2: locking

- Vertical hanging/standing travels
- High accelerations
- Corrosion resistant

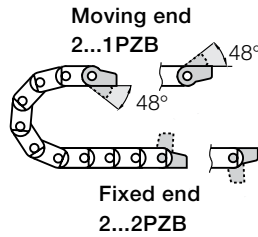

Possible installation configurations -

Dimensions and order configurations

Strain relief is possible on the moving end and/or the fixed end.

Part Number Structure

2050- 34 PZ B K1

- With 10 cable tiewraps
- With tiewrap plates
- Without tiewrap plates
- Complete Set
34 = Pivoting
12 = Locking
- Mounting brackets for selected chain type

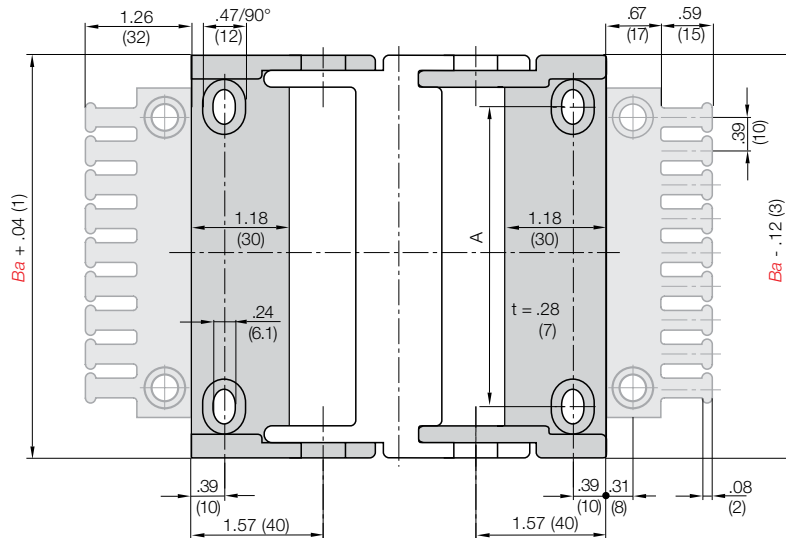

Full set, for both ends:

2050- 34 PZB Full set, each part with pin/bore + tiewrap plate

Single-part order:

2050- 3 PZB Mounting bracket with bore + tiewrap plate

2050- 4 PZB Mounting bracket with pin + tiewrap plate

For Chain Type	Part No. Full Set with Tiewrap Plate	Part No. Full Set with Tiewrap Plate + 10 cable ties	Part No. Full Set without Tiewrap Plate	Dimension A in. (mm)	Number of teeth
E200/Z200-05	2050- <input type="checkbox"/> PZB	2050- <input type="checkbox"/> PZBK1	2050- <input type="checkbox"/> PZ	1.73 (44)	6
E200/Z200-2/35	2070- <input type="checkbox"/> PZB	2070- <input type="checkbox"/> PZBK1	2070- <input type="checkbox"/> PZ	2.52 (64)	8
E200/Z200-2/50	2100- <input type="checkbox"/> PZB	2100- <input type="checkbox"/> PZBK1	2100- <input type="checkbox"/> PZ	3.54 (90)	10

34 or 12

For pivoting brackets choose 34
For locking brackets choose 12
Example: 2050- 34 PZB

PDF: igus.com/e-chain-pdfs
Product information: igus.com/e-chains



Strain relief for polymer mounting brackets (pivoting or locking)

The strain relief tiwrap plates can be snapped directly onto the mounting bracket. After bolting the mounting brackets to the machine, the strain relief tiwrap plates are firmly connected to the base. There is no need to bolt them on separately. Cable tiwraps secured to the cable and the tiwrap plate (teeth) provide proper strain relief and save time.

Tiewrap Plates

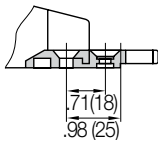

Shown assembled

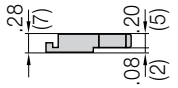

Single tiwrap plate



**Option 1:
Tiewrap plates as an individual part**

Available as an individual component, can be fixed onto a mounting bracket.

Tiewrap Plates	n Number of Teeth	Dimension C	Dimension B
2050-ZB	6	2.36 (60)	1.57 (40)
2070-ZB	8	3.15 (80)	2.36 (60)
2100-ZB	10	3.94 (100)	3.15 (80)

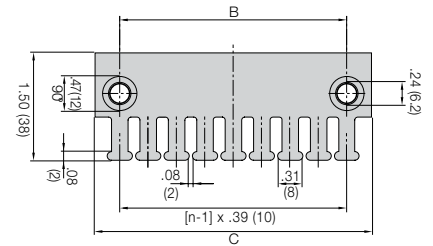

For more information please refer to strain relief section of Chapter 10

Strain relief for steel mounting brackets

Clip-on connection is not possible with steel mounting brackets. In this case, the tiwrap plates must be bolted directly into separate bore holes in front of the mounting bracket. Alternatively the tiwrap plates 20XX-ZB can be also used here. **Details chapter 10**



Cable tiwraps as individual parts

Cable tiwraps 100 pieces/bag	Width x Length		Maximum Ø		Tensile Strength	
	in.	(mm)	in.	(mm)	lbs	(N)
CFB-001	.19 x 5.91	(4.8 x 150)	1.42	(36)	50	(222)



**Option 2:
Clip-on Tiewrap plates for opening crossbars**

Clip-on tiwrap plates are also available as an attachment to opening crossbars. They can be positioned at any point along the e-chain®.

Part No.	Number of Teeth	Width of Strain Relief in. (mm)
2050-Z	6	2.44 (62)

For more information please refer to strain relief section of Chapter 10



PDF: igus.com/e-chain-pdfs
Product information: igus.com/e-chains



E16
Z16



e-chain system® E-Z chain Series E16/Z16



Price Index



Series E16/Z16

Special Features / Options

IPA Qualification Certificate
Air Cleanliness Class ISO Class 2
(at v = 3.28 ft/s) upon request

Flammability Class
VDE 0304 IIC UL94 V2

Special equipment: Electrically
conductive ESD/ATEX version
upon request

Assembly Tips



Just push the cables into the e-chain
using your thumb

Usage Guidelines



- If filling is required without opening and closing
- If price is an issue
- If quiet operation is required



- If a long unsupported length is required
➤ Series 2600/2700 E2 Medium
- If an e-chain with a high locking crossbar is needed
➤ Series 2600/2700 E2 Medium

Features & Benefits

- 1 Cable-friendly interior
- 2 Limited torsion tolerance
- 3 Small pitch for low-noise and smooth operation
- 4 Very easy to fill - cables only have to be pushed in
- 5 Mounting bracket with integrated strain relief
- 6 Patented push button design holds the links together
- 7 "E" Series features split crossbar along the outer radius
- 8 "Z" Series features split crossbar along the inner radius



Order Example: Complete e-chain®

Please indicate chain length or number of links. Example:

3.28 ft (1 m) E16-3-060-0

e-chain®

1 Set 117-3-12PZ

Mounting Bracket

e-chain system® E-Z chain Series E16/Z16 Installation Dimensions



E16
Z16

Short travel, unsupported length

- FL_B = unsupported with permitted sag
 - FL_G = unsupported with straight upper run
- Further information ► Design, Chapter 1

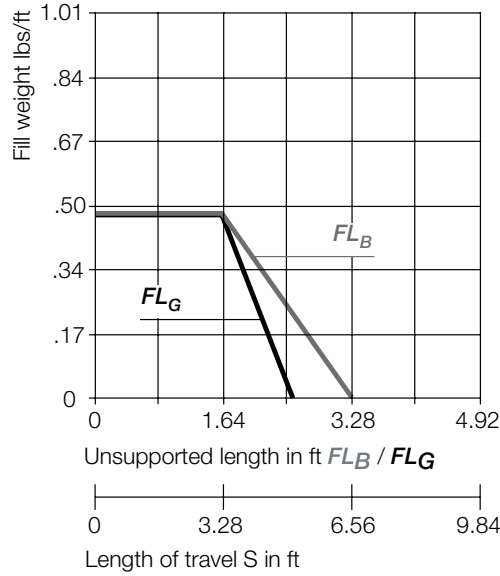
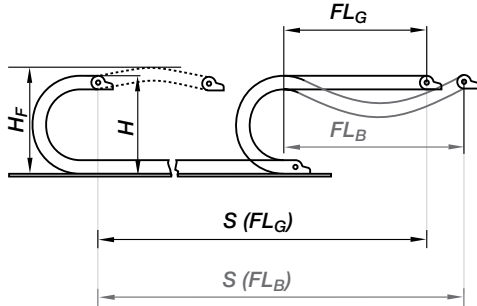

Short Travels - Unsupported



Unsupported E-Chains® feature positive camber over short travels. This must be accounted for when specifying the clearance height. Please refer to **Installation dimensions** for further details.

Legend

- S = Length of travel
- R = Bending radius
- H = Nominal clearance height
- D = Overlength e-chain® radius in final position
- $K = \pi \cdot R + \text{safety buffer}$
- H_F = Required clearance height

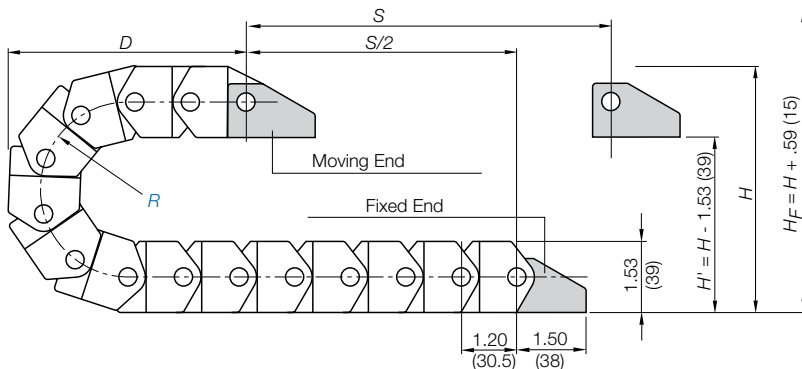

Pitch per link = 1.20" (30.5 mm)
Links per ft (m) = 10.06 (33)
For center mount applications:
Chain length = $\frac{S}{2} + K$

The required clearance height: $H_F = H + .59$ in. (15 mm) (with .20 lbs/ft (0.3 kg/m) fill weight. Please consult igus® if space is particularly restricted.

R	1.57 (040)*	2.36 (060)	2.95 (075)	3.94 (100)	4.92 (125**)
H	4.69 (119)	6.26 (159)	7.44 (189)	9.41 (239)	11.38 (289)
D	4.13 (105)	4.92 (125)	5.51 (140)	6.50 (165)	7.48 (190)
K	7.48 (190)	9.84 (250)	11.81 (300)	14.96 (380)	17.91 (455)

*This radius is only available for the E16-2, Z16-3, Z16-4 Series

** This radius is only available for the E16-3, E16-5, E16-6, E16-7, Z16-2 and Z16-4

Speed / acceleration FL_G	max. 65.6 ft/s (20 m/s) / max. 656 ft/s ² (200 m/s ²)
Speed / acceleration FL_B	max. 9.84 ft/s (3 m/s) / max. 19.69 ft/s ² (6 m/s ²)
Gliding speed / acceleration (maximum)	max. 9.84 ft/s (3 m/s) / max. 32.8 ft/s ² (10 m/s ²)
Material (e-chain®) - permitted temperature	igumid NB / -40°F (-40°C) up to +176°F (+80° C)
Material (mounting brackets)* - permitted temperature	igumid G / -40°F (-40°C) up to +248°F (+120° C)
Flammability Class (e-chain®), igumid NB	VDE 0304 IIC UL94 V2
Flammability Class (mounting brackets), igumid G*	VDE 0304 IIC UL94 HB

*Available in igumid NB upon request, please consult igus® for delivery time

Technical Data



Details of material properties

► Chapter 1

PDF: igus.com/e-chain-pdfs
Product information: igus.com/e-chains



STANDARD

Series E16 - Split crossbar along the outer radius

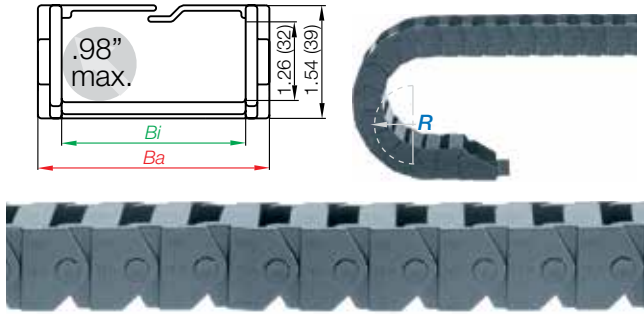

Part Number Structure

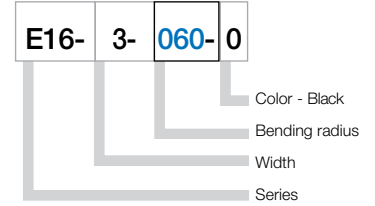

Series Z16 - Split crossbar along the inner radius

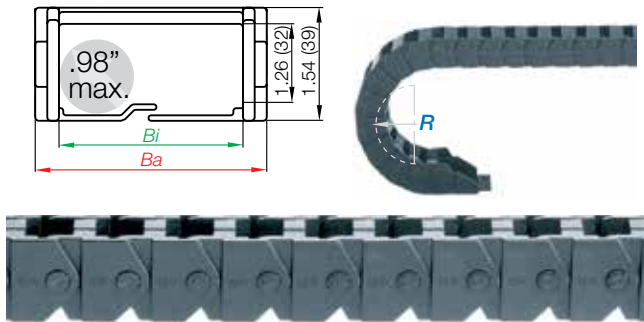

Part Number Structure

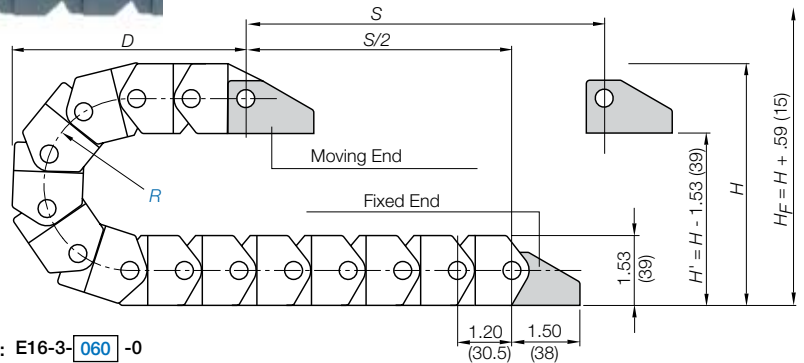
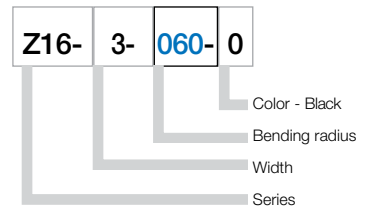

Supplement part number with required radius. Example: E16-3-060-0
Pitch: 1.20 in. (30.5 mm) per link links/ft (m) = 10.06 (33)

Part Number				<i>Bi</i>	<i>Ba</i>	Weight
Split Crossbar	Split Crossbar			in. (mm)	in. (mm)	lbs/ft (kg/m)
Outer radius	Inner radius					
E16-2-	Z16-2-	<input type="text"/>	-0	.91 (23)	1.48 (37.5)	≈ 0.34 (0.51)
E16-3-	Z16-3-	<input type="text"/>	-0	1.42 (36)	1.99 (50.5)	≈ 0.38 (0.57)
E16-4-	Z16-4-	<input type="text"/>	-0	1.89 (48)	2.46 (62.5)	≈ 0.42 (0.62)
E16-5-	Z16-5-	<input type="text"/>	-0	2.48 (63)	3.09 (78.5)	≈ 0.50 (0.75)
E16-6-	Z16-6-	<input type="text"/>	-0	3.15 (80)	3.76 (95.5)	≈ 0.56 (0.83)
E16-7-	Z16-7-	<input type="text"/>	-0	3.94 (100)	4.54 (115.3)	≈ 0.61 (0.91)

Choose from the radii below for all of the above sizes
Radius (mm) Example: E16-3-060-0

	040*	060	075	100	125**
R	1.57 (040)*	2.36 (060)	2.95 (075)	3.94 (100)	4.92 (125**)
H	4.69 (119)	6.26 (159)	7.44 (189)	9.41 (239)	11.38 (289)
D	4.13 (105)	4.92 (125)	5.51 (140)	6.50 (165)	7.48 (190)
K	7.48 (190)	9.84 (250)	11.81 (300)	14.96 (380)	17.91 (455)

0=Standard color black. For other colors see Chapter 1
*This radius is only available for the E16-2, Z16-3, Z16-4 Series
** This radius is only available for the E16-3, E16-5, E16-6, E16-7, Z16-2 and Z16-4

e-chain system® E-Z chain Series E16/Z16 Mounting Brackets



E16
Z16

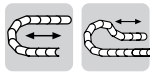

Standard

Option 1: pivoting

- One-piece mounting bracket
- Corrosion resistant
- Available pre-assembled
- Inner and outer attachment possible
- With our without strain relief tiwrap plates

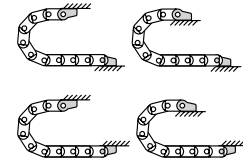
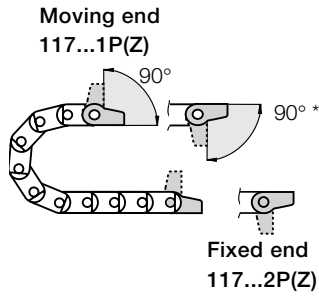

Possible installation configurations -

Dimensions and order configurations

Strain relief is possible on the moving end and/or the fixed end.

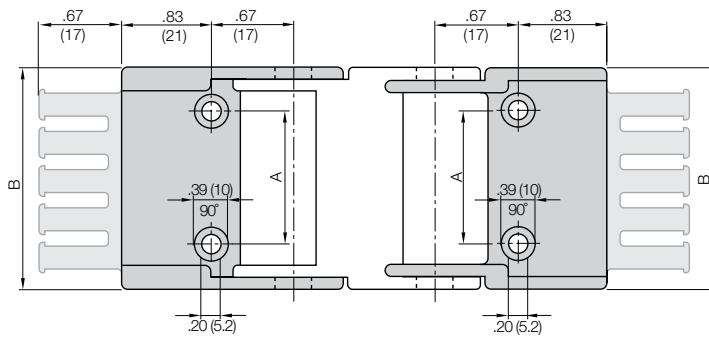

Part Number Structure

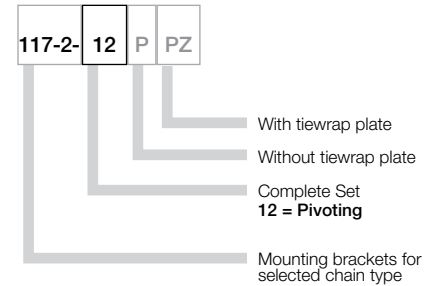

Full set, for both ends:

117-2-12-PZ Full set, each part with pin/bore + tiwrap plate

Single-part order:

117-2-1-PZ Mounting bracket with bore + tiwrap plate

117-2-2-PZ Mounting bracket with pin + tiwrap plate

For Chain Type	Part No. Full set with Tiwrap Plate	Part No. Full Set without Tiwrap Plate	Number of Teeth	Dimension A in. (mm)	Dimensions B in. (mm)
E16/Z16-2	117-2-12PZ	117-2-12P	3	.47 (12)	1.40 (35.5)
E16/Z16-3	117-3-12PZ	117-3-12P	4	.98 (25)	1.91 (48.5)
E16/Z16-4	117-4-12PZ	117-4-12P	5	1.46 (37)	2.38 (60.5)
E16/Z16-5	117-5-12PZ	117-5-12P	6	1.89 (48)	2.99 (76.0)
E16/Z16-6	117-6-12PZ	117-6-12P	8	2.56 (65)	3.66 (93.0)
E16/Z16-7	117-7-12PZ	117-7-12P	10	3.35 (85)	4.45 (113.0)

Additional Accessories



Quicksnap - the complete, detachable mounting unit, upon request



Quickfix - mounting bracket with dowel, upon request

PDF: igus.com/e-chain-pdfs
Product information: igus.com/e-chains

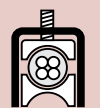

E26
Z26



e-chain system® E-Z chain Series E26/Z26



Price Index



Series E26/Z26

Special Features / Options



IPA Qualification Certificate
Air Cleanliness Class ISO Class 2
(at v = 3.28 ft/s) upon request



Flammability Class
VDE 0304 IIC UL94 V2



Special equipment: Electrically
conductive ESD/ATEX version
upon request

Assembly Tips



Just push the cables into the e-chain
using your thumb

Other Installation Methods

Vertical, hanging ≤ 32.8 ft (10 m)

Vertical, standing ≤ 4.92 ft (1.5 m)

Side-mounted, un_supp. ≤ 1.64 ft (0.5 m)

Rotary requires further calculation

Usage Guidelines



- If filling is required without opening and closing
- If price is an issue
- If quiet operation is required



- If a long unsupported length is required
➤ Series 2600/2700 E2/000
- If an e-chain with a high locking crossbar is needed
➤ Series 2600/2700 E2/000

Features & Benefits

- 1 Integrated strain relief option
- 2 Very easy to fill - cables only have to be pushed in
- 3 Cable-friendly interior
- 4 Limited torsion tolerance
- 5 Large pins for long service life
- 6 "E" Series features split crossbar along the outer radius
- 7 Dirt-repellent exterior
- 8 Patented push button design holds the links together
- 9 "Z" Series features split crossbar along the inner radius
- 10 1-, 2- or 3-chamber system available

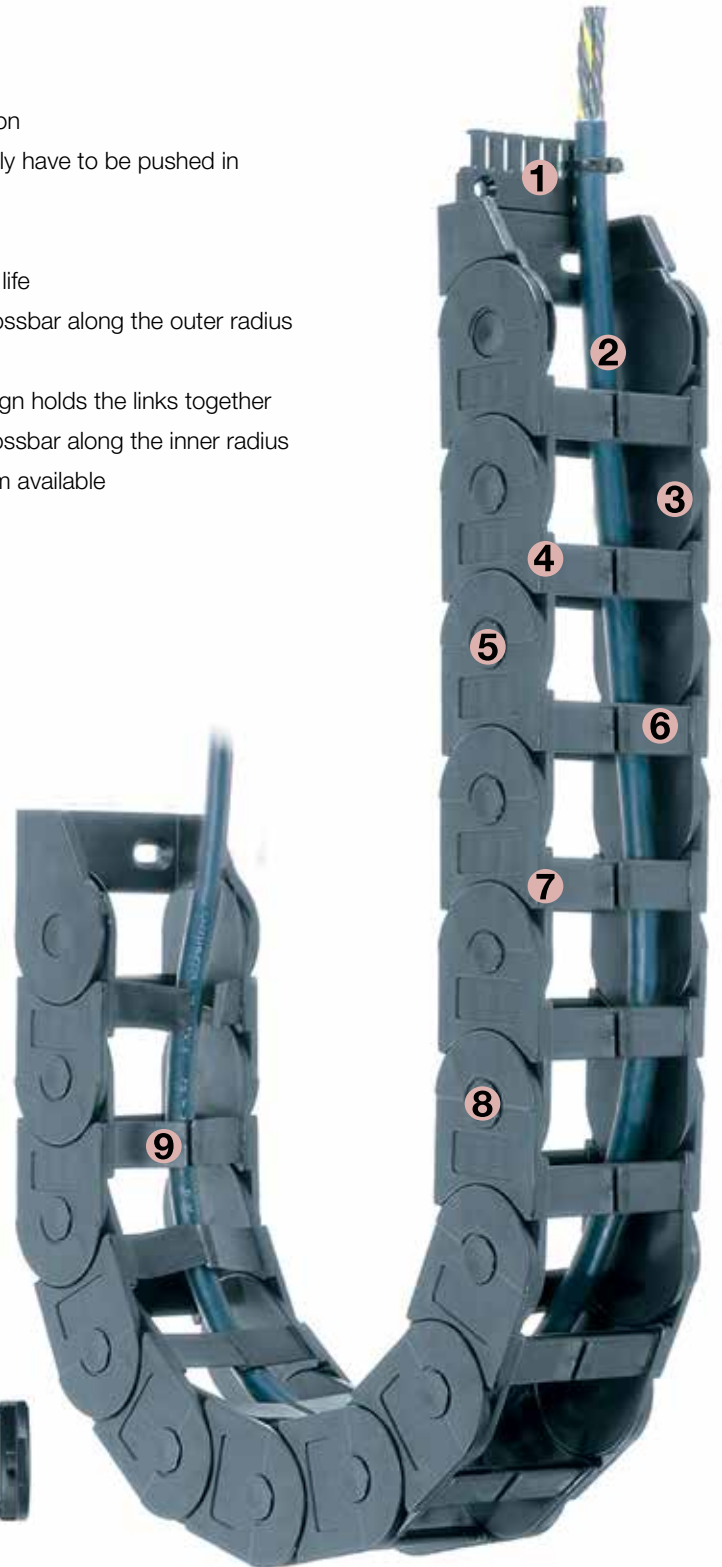

Order Example: Complete e-chain®

Please indicate chain length or number of links. Example:

3.28 ft (1 m) E26-07-150-0

e-chain®

1 Set 2607-34PZB

Mounting Bracket

e-chain system® E-Z chain

Series E26/Z26

Installation Dimensions



E26
Z26

Short travel, unsupported length

- FL_B = unsupported with permitted sag
 - FL_G = unsupported with straight upper run
- Further information ► Design, Chapter 1

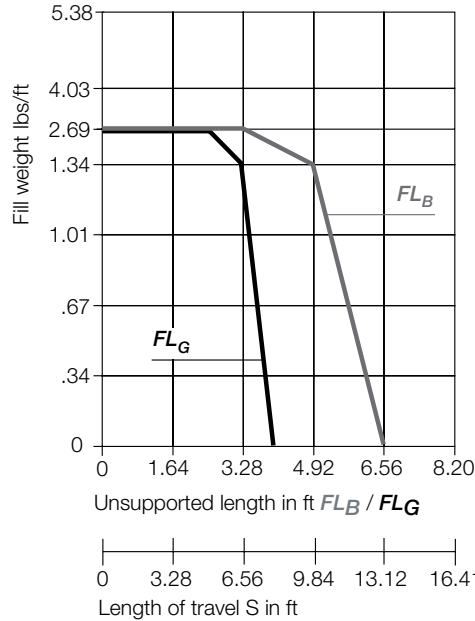
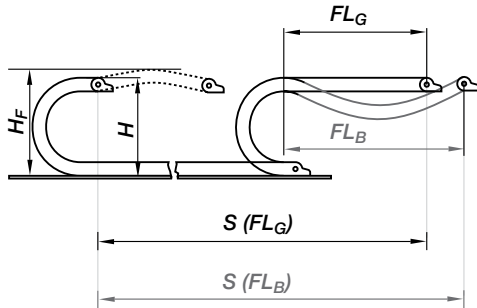

Short Travels - Unsupported



Unsupported E-Chains® feature positive camber over short travels. This must be accounted for when specifying the clearance height. Please refer to **Installation dimensions** for further details.

Legend

- S = Length of travel
- R = Bending radius
- H = Nominal clearance height
- D = Overlength e-chain® radius in final position
- $K = \pi \cdot R + \text{safety buffer}$
- H_f = Required clearance height

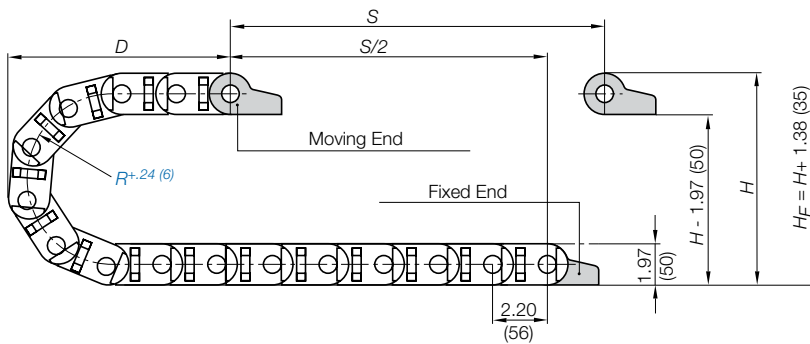

Pitch per link = 2.20" (56 mm)
 Links per ft (m) = 5.49 (18)
 For center mount applications:
 Chain length = $\frac{S}{2} + K$

The required clearance height: $H_f = H + 1.38$ in. (35 mm) (with 1.34 lbs/ft (2.0 kg/m) fill weight). Please consult igus® if space is particularly restricted.

R	2.48 (063)	2.95 (075)	3.94 (100)	4.92 (125)	5.91 (150)	6.89 (175)	7.87 (200)	9.84 (250)
H^{*5}	6.93 (176)	7.87 (200)	9.84 (250)	11.81 (300)	13.78 (350)	15.75 (400)	17.72 (450)	21.65 (550)
D	6.77 (172)	7.24 (184)	8.23 (209)	9.21 (234)	10.20 (259)	11.18 (284)	12.17 (309)	14.13 (359)
K	12.20 (310)	13.78 (350)	16.93 (430)	19.90 (505)	23.03 (585)	26.18 (665)	29.33 (745)	35.43 (900)

Speed / acceleration FL_G	max. 65.6 ft/s (20 m/s) / max. 656 ft/s ² (200 m/s ²)
Speed / acceleration FL_B	max. 9.84 ft/s (3 m/s) / max. 19.69 ft/s ² (6 m/s ²)
Gliding speed / acceleration (maximum)	max. 9.84 ft/s (3 m/s) / max. 32.8 ft/s ² (10 m/s ²)
Material (e-chain®) - permitted temperature	igumid NB / -40°F (-40°C) up to +176°F (+80°C)
Material (mounting brackets)* - permitted temperature	igumid G / -40°F (-40°C) up to +248°F (+120°C)
Flammability Class (e-chain®), igumid NB	VDE 0304 IIC UL94 V2
Flammability Class (mounting brackets), igumid G*	VDE 0304 IIC UL94 HB

*Available in igumid NB upon request, please consult igus® for delivery time

Technical Data



Details of material properties

► Chapter 1

PDF: igus.com/e-chain-pdfs
 Product information: igus.com/e-chains



Series E26
Split crossbar along the outer radius



Part Number Structure

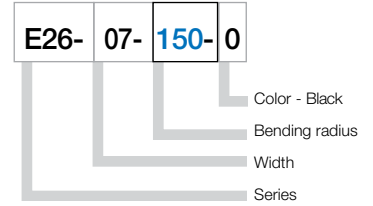

1 Chamber System

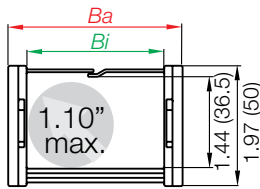

2 Chamber System

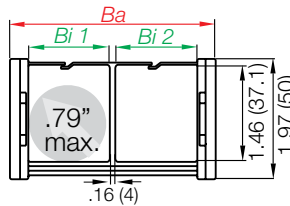

3 Chamber System

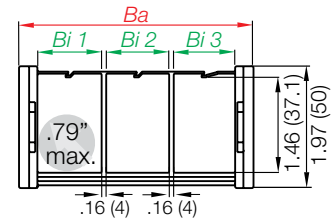

Supplement part number with required radius. Example: E26-07--0
Pitch: 2.20 in. (56 mm) per link links/ft (m) = 5.49 (18)

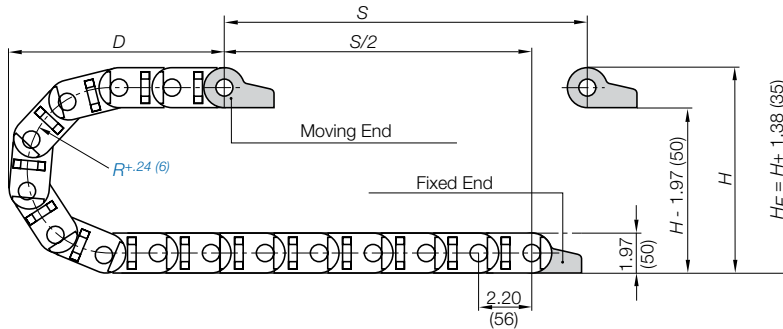

Part Number	Bi	Ba	Weight
	in. (mm)	in. (mm)	lbs/ft (kg/m)
E26-07- <input type="text" value=""/> -0	2.95 (75)	3.62 (92)	≈ 0.65 (0.96)

Part Number	Bi	Ba	Weight
	in. (mm)	in. (mm)	lbs/ft (kg/m)
E26-2/45- <input type="text" value=""/> -0	1.89/1.89 (48/48)	4.61 (117)	≈ 0.77 (1.14)

Part Number	Bi	Ba	Weight
	in. (mm)	in. (mm)	lbs/ft (kg/m)
E26-3/45- <input type="text" value=""/> -0	1.85/1.89/1.85 (47/48/47)	6.57 (167)	≈ 0.87 (1.30)

Choose from the radii below for all of the above sizes
Radius (mm) Example: E26-07--0

	063	075	100	125	150	175	200	250
R	2.48 (063)	2.95 (075)	3.94 (100)	4.92 (125)	5.91 (150)	6.89 (175)	7.87 (200)	9.84 (250)
H +5	6.93 (176)	7.87 (200)	9.84 (250)	11.81 (300)	13.78 (350)	15.75 (400)	17.72 (450)	21.65 (550)
D	6.77 (172)	7.24 (184)	8.23 (209)	9.21 (234)	10.20 (259)	11.18 (284)	12.17 (309)	14.13 (359)
K	12.20 (310)	13.78 (350)	16.93 (430)	19.88 (505)	23.03 (585)	26.18 (665)	29.33 (745)	35.43 (900)

Series Z26
Split crossbar along the inner radius



Part Number Structure

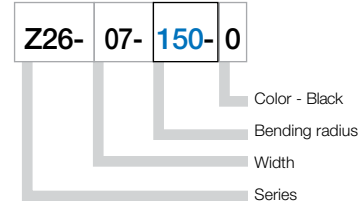

1 Chamber System

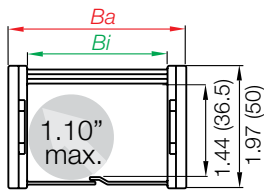

2 Chamber System

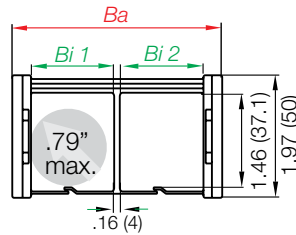

3 Chamber System

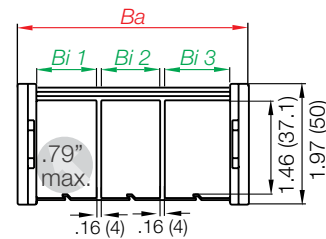

Supplement part number with required radius. Example: Z26-07-**150**-0

Pitch: 2.20 in. (56 mm) per link links/ft (m) = 5.49 (18)

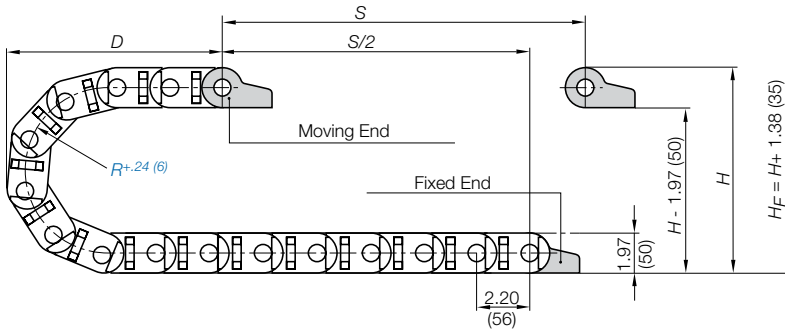

Part Number	Bi	Ba	Weight
1 Chamber System	in. (mm)	in. (mm)	lbs/ft (kg/m)
Z26-07- <input type="text"/> -0	2.95 (75)	3.62 (92)	≈ 0.65 (0.96)

Part Number	Bi	Ba	Weight
2 Chamber System	in. (mm)	in. (mm)	lbs/ft (kg/m)
Z26-2/45- <input type="text"/> -0	1.89/1.89 (48/48)	4.61 (117)	≈ 0.77 (1.14)

Part Number	Bi	Ba	Weight
3 Chamber System	in. (mm)	in. (mm)	lbs/ft (kg/m)
Z26-3/45- <input type="text"/> -0	1.85/1.89/1.85 (47/48/47)	6.57 (167)	≈ 0.87 (1.30)

Choose from the radii below for all of the above sizes
Radius (mm) Example: Z26-07-**100**-0

	063	075	100	125	150	175	200	250
R	2.48 (063)	2.95 (075)	3.94 (100)	4.92 (125)	5.91 (150)	6.89 (175)	7.87 (200)	9.84 (250)
H ⁺⁵	6.93 (176)	7.87 (200)	9.84 (250)	11.81 (300)	13.78 (350)	15.75 (400)	17.72 (450)	21.65 (550)
D	6.77 (172)	7.24 (184)	8.23 (209)	9.21 (234)	10.20 (259)	11.18 (284)	12.17 (309)	14.13 (359)
K	12.20 (310)	13.78 (350)	16.93 (430)	19.88 (505)	23.03 (585)	26.18 (665)	29.33 (745)	35.43 (900)





Option 1: pivoting

- Recommended for unsupported and gliding applications
- Space-restricted conditions
- Available with or without strain relief tiwrap plates
- Corrosion resistant

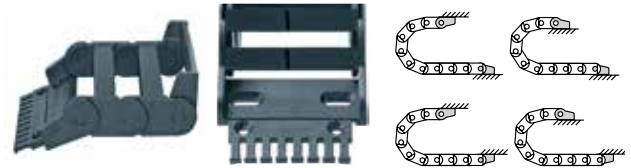
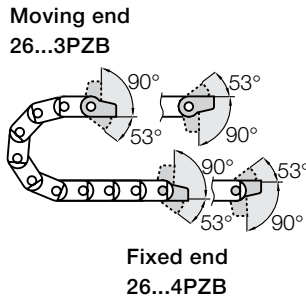

Possible installation configurations -

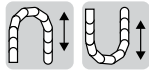

Option 2: locking

- Recommended for unsupported and gliding applications
- For high speed and/or accelerations
- Corrosion resistant

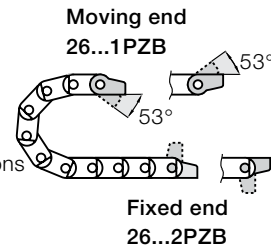

Possible installation configurations -

Dimensions and order configurations

Strain relief is possible on the moving end and/or the fixed end.

Part Number Structure

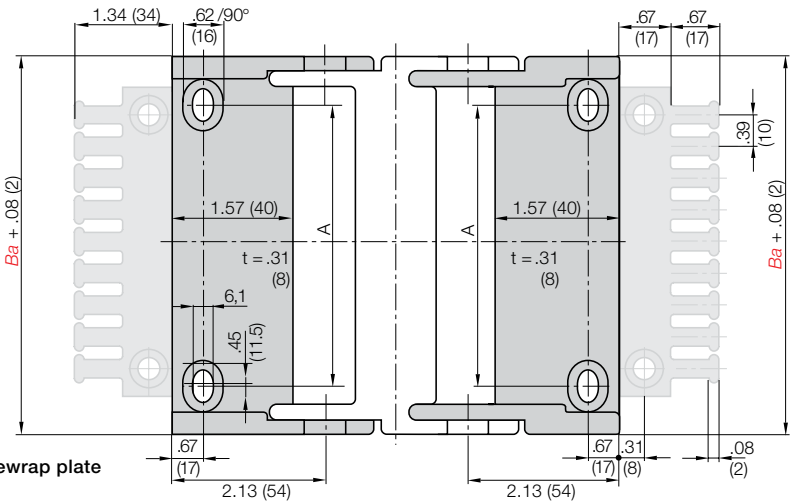
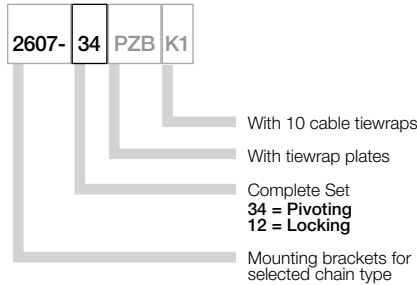

Full set, for both ends:
2607- [34] [PZB] Full set, each part with pin/bore + tiwrap plate
Single-part order:
2607- [3] [PZB] Mounting bracket with bore + tiwrap plate
2607- [4] [PZB] Mounting bracket with pin + tiwrap plate

Part No. Full Set (pivoting)
With Tiwrap Plates
Series E26/Z26:
2607-34PZB

Part No. Full Set (pivoting)
With Tiwrap Plates + 10 cable ties
Series E26/Z26:
2607-34PZBK1

Part No. Full Set (pivoting)
Without Tiwrap Plates
Series E26/Z26:
2607-34PZ

For Chain Type	Part No. Full Set with Tiwrap Plate	Part No. Full Set with Tiwrap Plate + 10 cable ties	Part No. Full Set without Tiwrap Plate	Dimension A in. (mm)	Number of Teeth
E26/Z26-07	2607- [] PZB	2607- [] PZBK1	2607- [] PZ	2.17 (55)	7
E26/Z26-2/45	2610- [] PZB	2610- [] PZBK1	2610- [] PZ	3.15 (80)	10
E26/Z26-3/45	2615- [] PZB	2615- [] PZBK1	2615- [] PZ	5.12 (130)	15

34 or 12

For pivoting brackets choose **34**
For locking brackets choose **12**
Example: 2607-34 PZB

Strain relief for polymer mounting brackets (pivoting or locking)

The strain relief tiwrap plates can be snapped directly onto the mounting bracket. After bolting the mounting brackets to the machine, the strain relief tiwrap plates are firmly connected to the base. There is no need to bolt them on separately. Cable tiwraps secured to the cable and the tiwrap plate (teeth) provide proper strain relief and save time.

Tiewrap Plates

**Option 1:
 Tiewrap plates as an individual part**

Available as an individual component, can be fixed onto a mounting bracket.

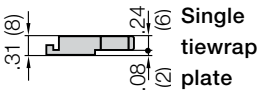
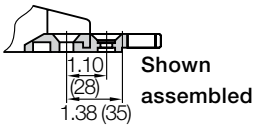

Tiewrap Plate	n Number of Teeth	C Overall Width in. (mm)	B Bore Width in. (mm)	Center Bore
3050-ZB	5	1.97 (50)	1.18 (30)	no
3075-ZB	7	2.95 (75)	2.16 (55)	no
3100-ZB	10	3.94 (100)	3.15 (80)	no
3115-ZB	11	4.53 (115)	3.74 (95)	no
3125-ZB	12	4.92 (125)	4.13 (105)	no
3150-ZB	15	5.91 (150)	5.12 (130)	no
3175-ZB	17	6.89 (175)	6.10 (155)	no
3200-ZB	20	7.87 (200)	7.09 (180)	yes
3225-ZB	22	8.86 (225)	8.07 (205)	yes
3250-ZB	25	9.84 (250)	9.06 (230)	yes

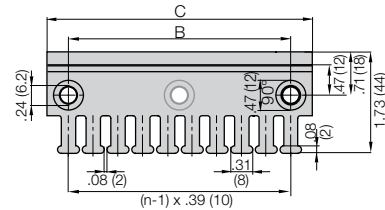

For more information please refer to strain relief section of Chapter 10



Cable tiwraps as individual parts

Cable tiwraps 100 pieces/bag	Width x Length		Maximum Ø		Tensile Strength	
	in.	(mm)	in.	(mm)	lbs	(N)
CFB-001	.19 x 5.91	(4.8 x 150)	1.42	(36)	50	(222)

PDF: igus.com/e-chain-pdfs
 Product information: igus.com/e-chains

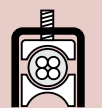



Price Index



Series E300/Z300

Special Features / Options



IPA Qualification Certificate
Air Cleanliness Class ISO Class 2
(at v = 3.28 ft/s) upon request



Flammability Class
VDE 0304 IIC UL94 V2



Special equipment: Electrically
conductive ESD/ATEX version
upon request

Assembly Tips



Just push the cables into the e-chain using your thumb

Other Installation Methods

Vertical, hanging ≤ 32.8 ft (10 m)

Vertical, standing ≤ 4.92 ft (1.5 m)

Side-mounted, un_supp. ≤ 1.64 ft (0.5 m)

Rotary requires further calculation

Usage Guidelines



- If filling is required without opening and closing
- If price is an issue
- If quiet operation is required



- If high loads and long unsupported lengths are present
➤ Series 3400/3500 E2/000

Features & Benefits

- 1 Limited torsion tolerance
- 2 Cable-friendly interior
- 3 Large pins for long service life
- 4 Very easy to fill - cables only have to be pushed in
- 5 Dirt-repellent exterior
- 6 "E" Series features split crossbar along the outer radius
- 7 Integrated strain relief option
- 8 Patented push button design holds the links together
- 9 "Z" Series features split crossbar along the inner radius
- 10 Interior separation possible
- 11 1-, 2- or 3-chamber system available

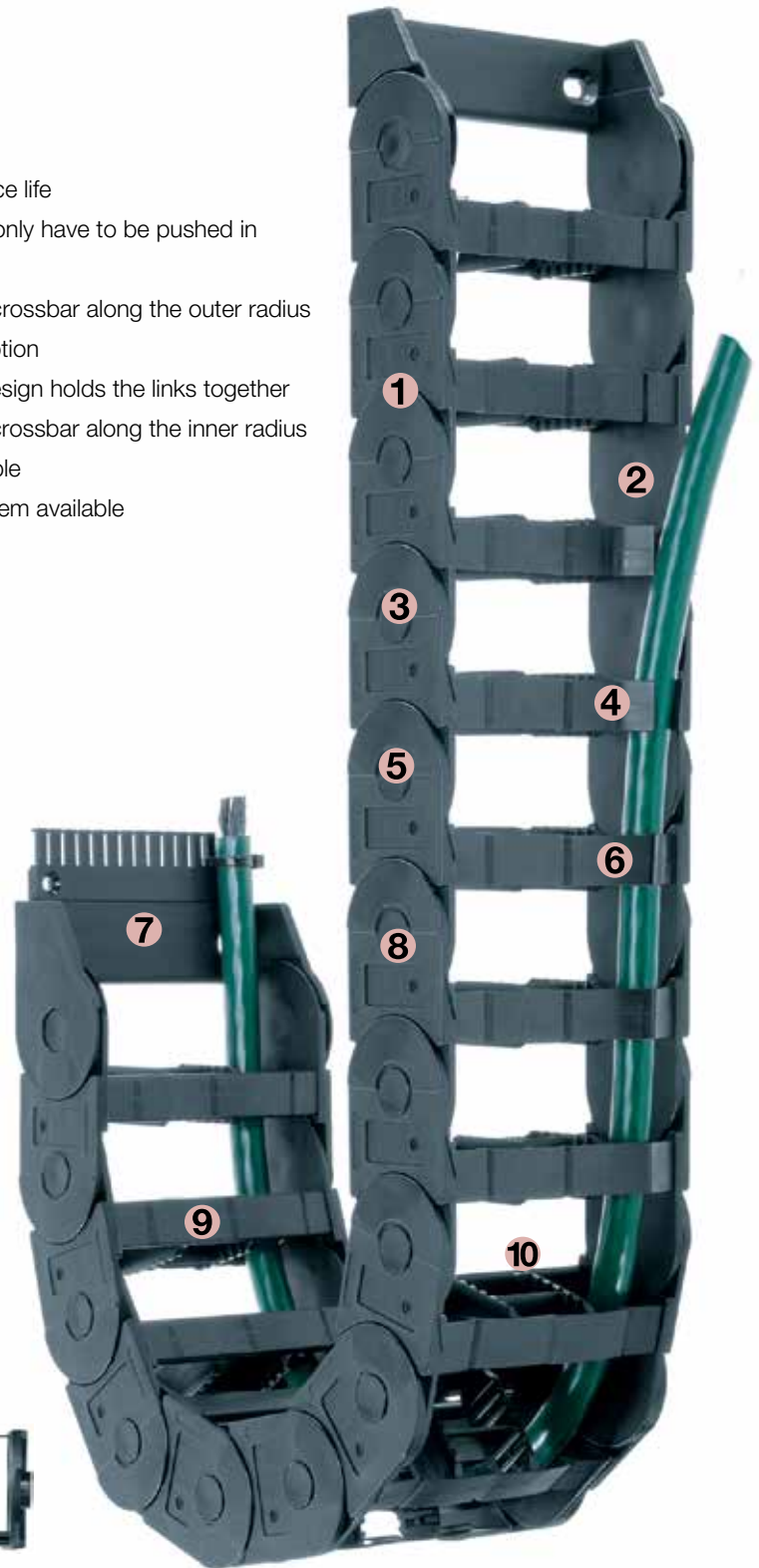

Order Example: Complete e-chain®

Please indicate chain length or number of links. Example:

3.28 ft (1 m) E300-075-100-0

e-chain®

1 Set 3075-34PZB

Mounting Bracket

e-chain system® E-Z chain

Series E300/Z300

Installation Dimensions



E300
Z300

Short travel, unsupported length

- FL_B = unsupported with permitted sag
 - FL_G = unsupported with straight upper run
- Further information ► Design, Chapter 1

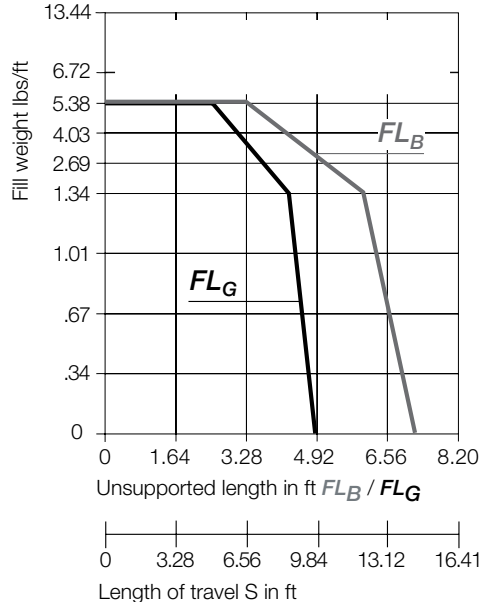
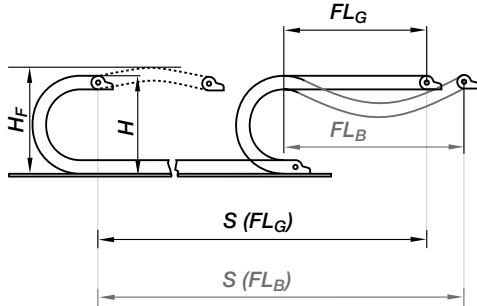

Short Travels - Unsupported



Unsupported E-Chains® feature positive camber over short travels. This must be accounted for when specifying the clearance height. Please refer to **Installation dimensions** for further details.

Legend

- S = Length of travel
- R = Bending radius
- H = Nominal clearance height
- D = Overlength e-chain® radius in final position
- $K = \pi \cdot R + \text{safety buffer}$
- H_f = Required clearance height

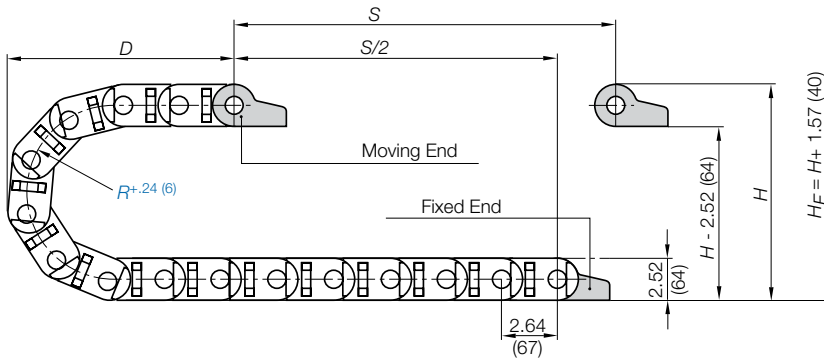

Pitch per link = 2.64" (67 mm)
 Links per ft (m) = 4.57 (15)
 For center mount applications:
 Chain length = $\frac{S}{2} + K$

The required clearance height: $H_f = H + 1.57$ in. (40 mm) (with 1.68 lbs/ft (2.5 kg/m) fill weight). Please consult igus® if space is particularly restricted.

R	2.95 (075)	3.94 (100)	4.92 (125)	5.91 (150)	7.87 (200)	9.84 (250)	11.81 (300)
H^{+4}	8.43 (214)	10.39 (264)	12.36 (314)	14.33 (364)	18.27 (464)	22.20 (564)	26.14 (664)
D	8.19 (208)	9.17 (233)	10.16 (258)	11.14 (283)	13.11 (333)	15.08 (383)	17.05 (433)
K	14.57 (370)	17.72 (450)	20.87 (530)	24.02 (610)	30.12 (765)	36.22 (920)	42.52 (1080)

Speed / acceleration FL_G	max. 65.6 ft/s (20 m/s) / max. 656 ft/s ² (200 m/s ²)
Speed / acceleration FL_B	max. 9.84 ft/s (3 m/s) / max. 19.69 ft/s ² (6 m/s ²)
Gliding speed / acceleration (maximum)	max. 9.84 ft/s (3 m/s) / max. 32.8 ft/s ² (10 m/s ²)
Material (e-chain®) - permitted temperature	igumid NB / -40°F (-40°C) up to +176°F (+80°C)
Material (mounting brackets)* - permitted temperature	igumid G / -40°F (-40°C) up to +248°F (+120°C)
Flammability Class (e-chain®), igumid NB	VDE 0304 IIC UL94 V2
Flammability Class (mounting brackets), igumid G*	VDE 0304 IIC UL94 HB

*Available in igumid NB upon request, please consult igus® for delivery time

Technical Data



Details of material properties

► Chapter 1



PDF: igus.com/e-chain-pdfs
 Product information: igus.com/e-chains



Series E300
Split crossbar along the outer radius



Part Number Structure

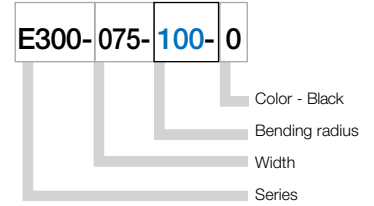

Single Chamber System

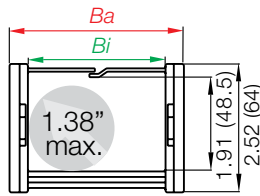

2 Chamber System

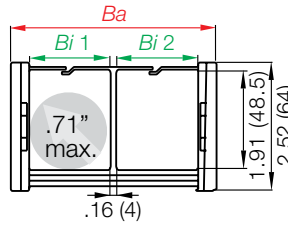

3 Chamber System with optional shelving

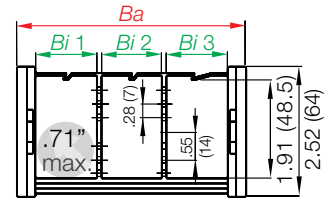

Supplement part number with required radius. Example: E300-075--0
Pitch: 2.64 in. (67 mm) per link links/ft (m) = 4.57 (15)

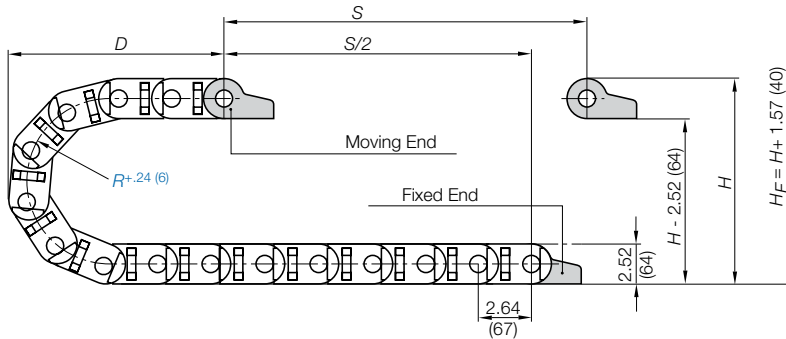

Shelving

Unassembled
Part number 386-54
Assembled
Part number 387-54

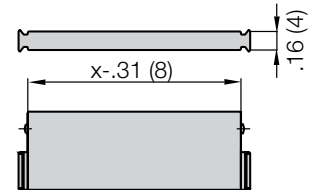

Part Number	Bi	Ba	Weight
	in. (mm)	in. (mm)	lbs/ft (kg/m)
1 Chamber System			
E300-075- <input type="text" value=""/> -0	2.95 (75)	3.74 (95)	≈ 1.08 (1.60)

Part Number	Bi	Ba	Weight
	in. (mm)	in. (mm)	lbs/ft (kg/m)
2 Chamber System			
E300-2/45- <input type="text" value=""/> -0	1.89/1.89 (48/48)	4.72 (120)	≈ 1.20 (1.78)

Part Number	Bi	Ba	Weight
	in. (mm)	in. (mm)	lbs/ft (kg/m)
3 Chamber System			
E300-3/45- <input type="text" value=""/> -0	1.85/1.81/1.85 (47/46/47)	6.69 (170)	≈ 1.29 (1.92)

Choose from the radii below for all of the above sizes

Radius (mm) Example: E300-075--0

	075	100	125	150	200	250	300
R	2.95 (075)	3.94 (100)	4.92 (125)	5.91 (150)	7.87 (200)	9.84 (250)	11.81 (300)
H +5	8.43 (214)	10.39 (264)	12.36 (314)	14.33 (364)	18.27 (464)	22.20 (564)	26.14 (664)
D	8.19 (208)	9.17 (233)	10.16 (258)	11.14 (283)	13.11 (333)	15.08 (383)	17.05 (433)
K	14.57 (370)	17.72 (450)	20.87 (530)	24.02 (610)	30.12 (765)	36.22 (920)	42.52 (1080)

Series Z300

Split crossbar along the inner radius



Part Number Structure

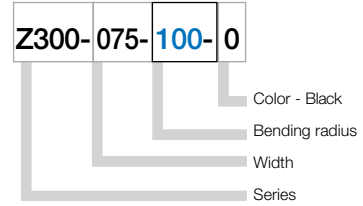

Single Chamber System

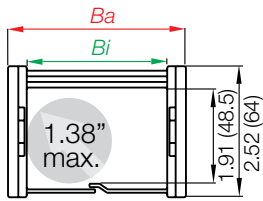

2 Chamber System

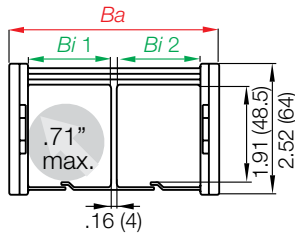

3 Chamber System

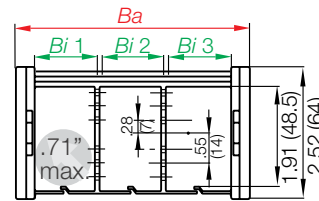

Supplement part number with required radius. Example: Z300-075--0
Pitch: 2.64 in. (67 mm) per link links/ft (m) = 4.57 (15)

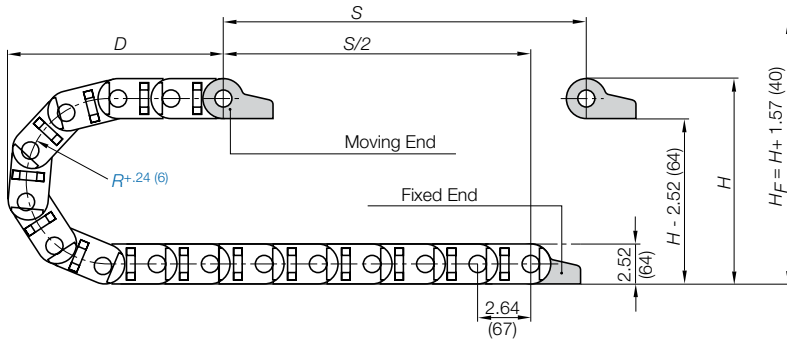

Shelving

Unassembled
Part number 386-54
Assembled
Part number 387-54

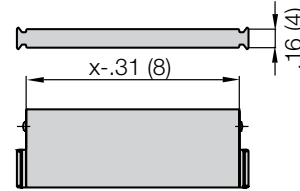

Part Number	Bi	Ba	Weight
	in. (mm)	in. (mm)	lbs/ft (kg/m)
Z300-075- <input type="text" value=""/> -0	2.95 (75)	3.74 (95)	≈ 1.08 (1.60)

Part Number	Bi	Ba	Weight
	in. (mm)	in. (mm)	lbs/ft (kg/m)
Z300-2/45- <input type="text" value=""/> -0	1.89/1.89 (48/48)	4.72 (120)	≈ 1.20 (1.78)

Part Number	Bi	Ba	Weight
	in. (mm)	in. (mm)	lbs/ft (kg/m)
Z300-3/45- <input type="text" value=""/> -0	1.85/1.81/1.85 (47/46/47)	6.69 (170)	≈ 1.29 (1.92)

Choose from the radii below for all of the above sizes
Radius (mm) Example: Z300-075--0

	075	100	125	150	200	250	300
R	2.95 (75)	3.94 (100)	4.92 (125)	5.91 (150)	7.87 (200)	9.84 (250)	11.81 (300)
H +5	8.43 (214)	10.39 (264)	12.36 (314)	14.33 (364)	18.27 (464)	22.20 (564)	26.14 (664)
D	8.19 (208)	9.17 (233)	10.16 (258)	11.14 (283)	13.11 (333)	15.08 (383)	17.05 (433)
K	14.57 (370)	17.72 (450)	20.87 (530)	24.02 (610)	30.12 (765)	36.22 (920)	42.52 (1080)



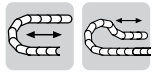

Standard

Option 1: pivoting

- Recommended for unsupported and gliding applications
- Space-restricted conditions
- Available with or without strain relief tiwrap plates
- Corrosion resistant

Moving end
3...3PZB

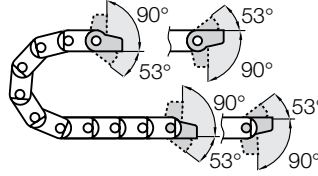

Fixed end
3...4PZB

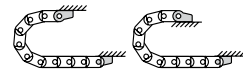
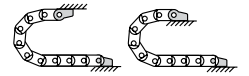

Possible installation configurations -

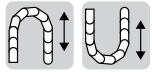

Option 2: locking

- Recommended for unsupported and gliding applications
- For high speed and/or accelerations
- Corrosion resistant

Moving end
3...1PZB

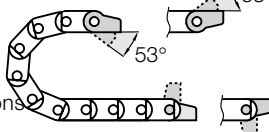

Fixed end
3...2PZB

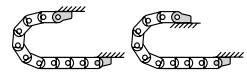
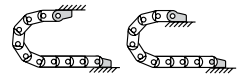

Possible installation configurations -

Dimensions and order configurations

Strain relief is possible on the moving end and/or the fixed end.

Part Number Structure



- With 10 cable tiwrap ties
- With tiwrap plates
- Complete Set
34 = Pivoting
12 = Locking
- Mounting brackets for selected chain type

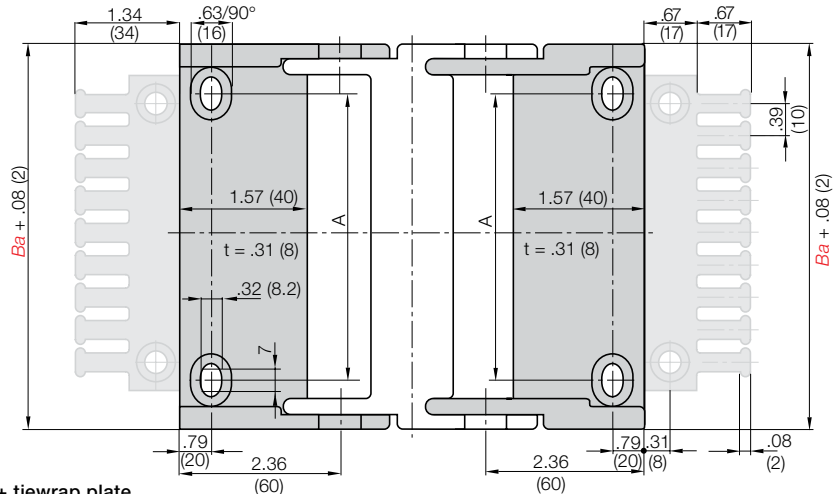

Full set, for both ends:

3075- [34] PZB Full set, each part with pin/bore + tiwrap plate

Single-part order:

3075- [3] PZB Mounting bracket with bore + tiwrap plate

3075- [4] PZB Mounting bracket with pin + tiwrap plate

Part No. Full Set (pivoting)

With Tiwrap Plates

Series E300, Z300:

3075-34PZB

Part No. Full Set (pivoting)

With Tiwrap Plates + 10 cable ties

Series E300, Z300:

3075-34PZBK1

Part No. Full Set (pivoting)

Without Tiwrap Plates

Series E300, Z300:

3075-34PZ

For Chain Type	Part No. Full Set with Tiwrap Plate	Part No. Full Set with Tiwrap Plate + 10 cable ties	Part No. Full Set without Tiwrap Plate	Dimension A in. (mm)	Number of Teeth
E300/Z300-075	3075- [] PZB	3075- [] PZBK1	3075- [] PZ	2.09 (53)	7
E300/Z300-2/45	3100- [] PZB	3100- [] PZBK1	3100- [] PZ	3.07 (78)	10
E300/Z300-3/45	3150- [] PZB	3150- [] PZBK1	3150- [] PZ	5.04 (128)	15

34 or 12

For pivoting brackets choose **34**
For locking brackets choose **12**
Example: 3075- **34** PZB

Strain relief for polymer mounting brackets (pivoting or locking)

The strain relief tiwrap plates can be snapped directly onto the mounting bracket. After bolting the mounting brackets to the machine, the strain relief tiwrap plates are firmly connected to the base. There is no need to bolt them on separately. Cable tiwraps secured to the cable and the tiwrap plate (teeth) provide proper strain relief and save time.

Tiewrap Plates

**Option 1:
 Tiewrap plates as an individual part**

Available as an individual component, can be fixed onto a mounting bracket.

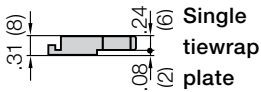
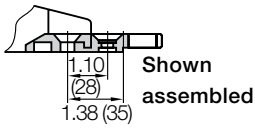

Tiewrap Plate	n Number of Teeth	C Overall Width in. (mm)	B Bore Width in. (mm)	Center Bore
3050-ZB	5	1.97 (50)	1.18 (30)	no
3075-ZB	7	2.95 (75)	2.16 (55)	no
3100-ZB	10	3.94 (100)	3.15 (80)	no
3115-ZB	11	4.53 (115)	3.74 (95)	no
3125-ZB	12	4.92 (125)	4.13 (105)	no
3150-ZB	15	5.91 (150)	5.12 (130)	no
3175-ZB	17	6.89 (175)	6.10 (155)	no
3200-ZB	20	7.87 (200)	7.09 (180)	yes
3225-ZB	22	8.86 (225)	8.07 (205)	yes
3250-ZB	25	9.84 (250)	9.06 (230)	yes

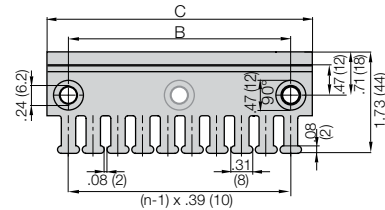

For more information please refer to strain relief section of Chapter 10



Cable tiwraps as individual parts

Cable tiwraps 100 pieces/bag	Width x Length		Maximum Ø		Tensile Strength	
	in.	(mm)	in.	(mm)	lbs	(N)
CFB-001	.19 x 5.91	(4.8 x 150)	1.42	(36)	50	(222)

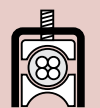



igus® Zipper Chain



Zipper - Fast and easy access to cables and hoses

iF-Design Award

Zipper e-chains® enable lightning-fast opening and closing of lids. Different from the typical e-chain® design, which features side links and crossbars, Zipper chains are built with interconnected lids. These lids pull back like a zipper, removing the top section of the e-chain® in one uniform piece at any point along the length of the carrier. Cable installation and removal—especially for cables equipped with preassembled connectors—is both fast and simple because the unique design eliminates the need to snake cables through the carrier.

Typical industries and applications

- Pick & place robots
- Semi-conductor machines
- Linear motors, actuators
- Measuring equipment
- Machine tools (Zipper e-tube)



Cleanroom Class 1 (ISO class 3) for Zipper Series 15, tested by the Dryden Engineering Company, CA



Flammability Class
VDE 0304 IIC UL94 HB



iF-Design
Award Winner



Low-noise



Fast Opening and Closing
with “Zipper”



igus® e-chain® Series 17
on an X-Y table.
Acceleration: 328 ft/s² (100 m/s²)

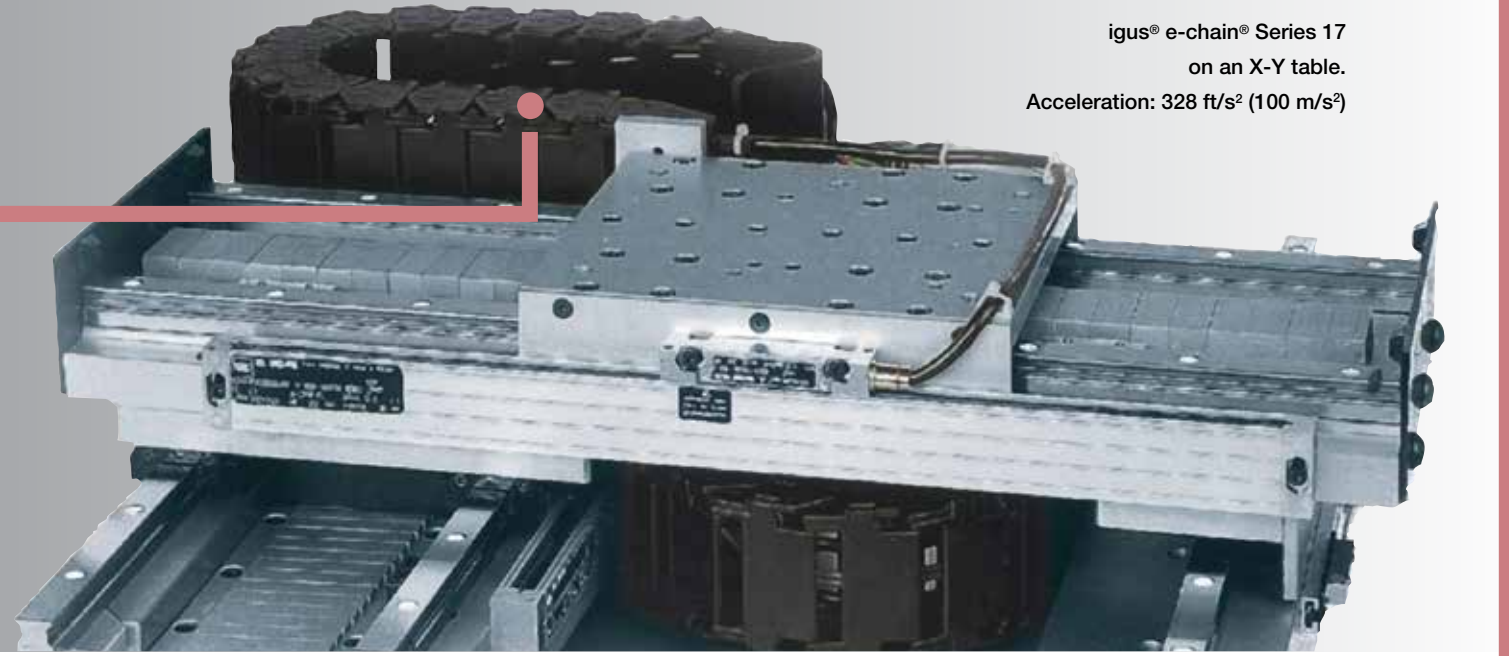

Lightning fast opening and closing with “Zipper”

- Reduced assembly-time
- Zipper-like design for quick opening and closing of lids
- Zipper lids can be separated and joined at each chain link
- Small pitch for low noise and smooth operation
- High accelerations: 328 ft/s² (100 m/s²) and more are possible
- Interior separation possible for larger versions (Series 15 and 17)



igus® e-chain® Series 15 Zipper in
automatic equipment - reduce assembly time

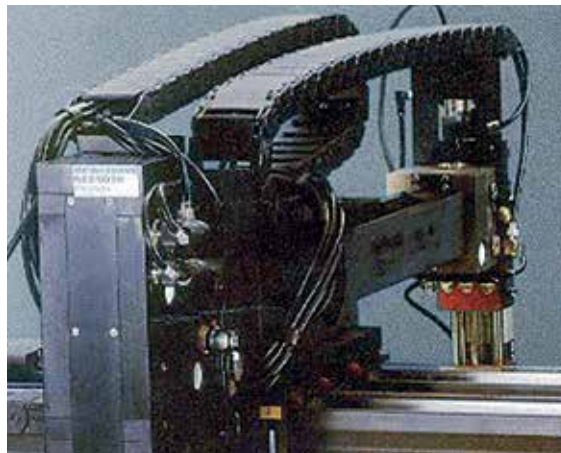

Series 15 with acceleration of 328 ft/s² (100 m/s²)
on pick-and-place robots, low noise

e-chain system® Zipper

Selection Guide

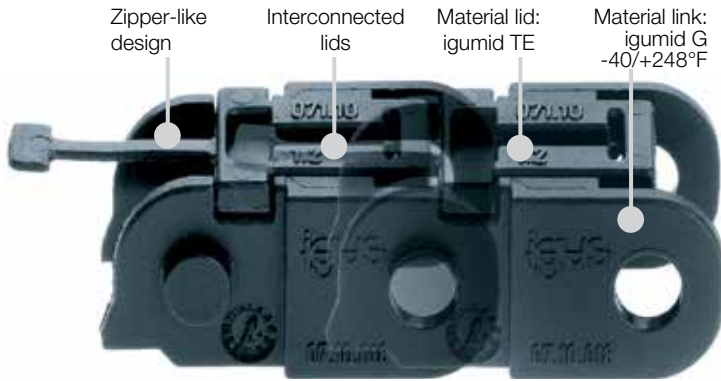

Zipper e-chains®

- Reduced assembly-time:
Zipper-like design for quick opening and closing of lids
- Zipper lids can be separated and joined at each chain link
- Small pitch for low noise, smooth operation
- High acceleration: 328 ft/s² (100 m/s²) and more
- Interior separation possible for larger versions
- You can find more technical data about the material, chemical resistance, temperatures ► **Design, Chapter 1**

Series	Inner height <i>hi</i>		Inner width <i>Bi</i>		Outer width <i>Ba</i>		Outer height <i>ha</i>		Bending radius <i>R</i>	
	in.	(mm)	in.	(mm)	in.	(mm)	in.	(mm)	in.	(mm)
047	.35	(9.0)	.39- .63	(10 - 16)	.63- .87	(16.0 - 22.0)	.49	(12.5)	.71- 1.50	(018 - 038)
07	.41	(10.3)	.24- 2.52	(6 - 64)	.49- 2.80	(12.5 - 71.0)	.59	(15.0)	.71- 1.89	(018 -048*)
09	.59	(15.0)	.39- 1.97	(10 - 50)	.72- 2.29	(18.2 - 58.2)	.76	(19.3)	1.10- 1.89	(028 - 048)
15	.67	(17.0)	.59- 3.94	(15 - 100)	1.02- 4.45	(26.0 - 113.0)	.94	(24.0)	1.50- 7.09	(038 - 180)
17	1.26	(32.0)	.59- 3.94	(15 - 100)	1.02- 4.45	(26.0 - 113.0)	1.54	(39.0)	2.48- 4.92	(063 - 125)

*For the 07 series, the 1.89" (048mm) bend radius is only available for the 2.52" (64mm) inner width

For protection against dirt and debris

For information about this zipper series please refer to the tubes section of the catalog ► **tubes, Chapter 5**

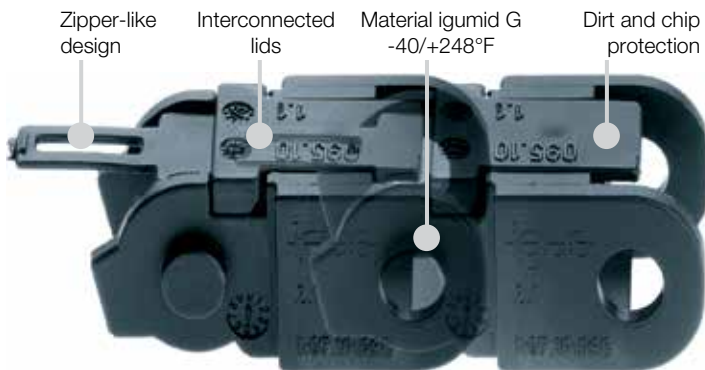

Zipper e-tubes against chips and dirt

- Fully enclosed e-tube with zipper opening mechanism
- Protection against dirt and chips
- Superfast opening of interconnected lids
- Modular design - tool-free lengthening and shortening
- Small pitch for low noise, smooth operation, high acceleration
- You can find more technical data about the material, chemical resistance, temperatures ► **Design, Chapter 1**

Series	Inner height <i>hi</i>		Inner width <i>Bi</i>		Outer width <i>Ba</i>		Outer height <i>ha</i>		Bending radius <i>R</i>	
	in.	(mm)	in.	(mm)	in.	(mm)	in.	(mm)	in.	(mm)
R07	.41	(10.3)	.39- 1.97	(10 - 50)	.65- 2.24	(16.5 - 57.0)	.59	(15.0)	1.50 - 1.89	(038 - 048)
R09	.59	(15.0)	.39- 1.97	(10 - 50)	.72- 2.29	(18.2 - 58.2)	.76	(19.3)	1.89 - 3.94	(048 - 100)
R15	.67	(17.0)	.98- 3.15	(25 - 80)	1.42- 3.70	(36.0 - 94.0)	.94	(24.0)	2.48 - 7.09	(063 - 180)
R17	1.26	(32.0)	.59- 2.48	(15 - 63)	1.02- 2.91	(26.0 - 74.0)	1.54	(39.0)	2.48 - 4.92	(063 - 125)



Available from stock. Orders ship as early as today.*

*On average 90% of orders ship the same day..

e-chain system® Zipper Assembly Instructions

Assembling | Zipper



Push and click



Snap lids together



Position and...



...push and snap

Separating | Zipper



Zip - upward . All lids fit like a "Zipper"



Separate lids



Release side-link



Twist and pull apart

Price Index

Series 047

Special Features / Options

Upon request: Cleanroom Class 1
(ISO class 3) tested by the Dryden
Engineering Company, CA



Flammability Class
VDE 0304 IIC UL94 HB



Low-noise

Assembly Tips

“Zipper-fast” opening and closing

Features & Benefits

- 1 For high acceleration
- 2 Zipper lids can be separated and joined at each link
- 3 Small pitch for low-noise and smooth operation
- 4 ‘Zipper-fast’ opening and closing
- 5 Mounting brackets available
- 6 Lightweight

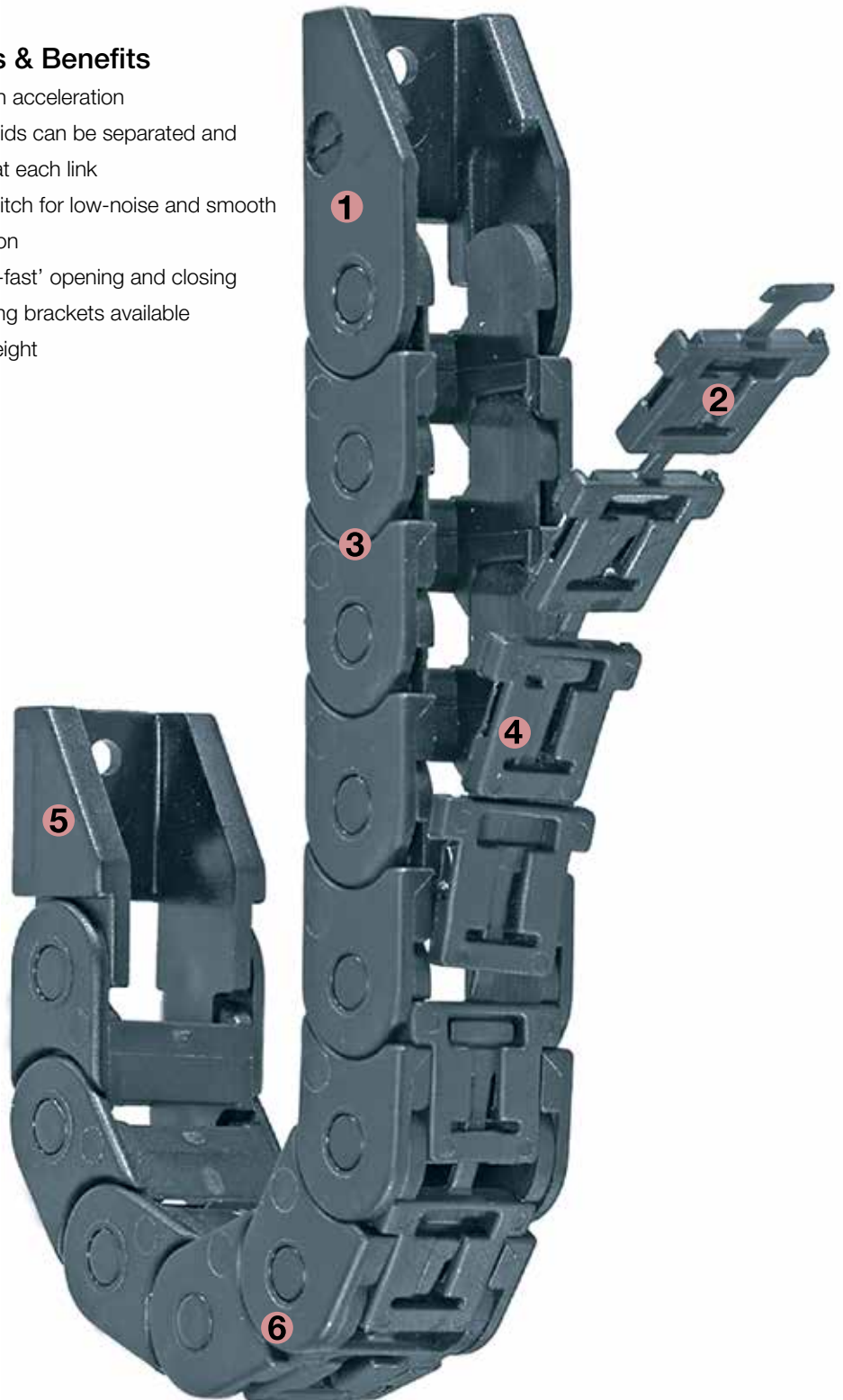
Usage Guidelines

- If fast, zipper-like accessibility to cables is required
- If quiet operation is required
- If aesthetic design is required
- If excellent service life is required
- If cost is a factor



- If easy filling without opening and closing is required
- Series E04 E-Z Chain

Order Example: Complete e-chain®

Please indicate chain length or number of links. Example:

3.28 ft (1 m) 047-10-038-0

e-chain®

1 Set 0450-10-12

Mounting Bracket

e-chain system® Zipper Series 047 Installation Dimensions

Short travel, unsupported length

- FL_B = unsupported with permitted sag
 - FL_G = unsupported with straight upper run
- Further information ► Design, Chapter 1

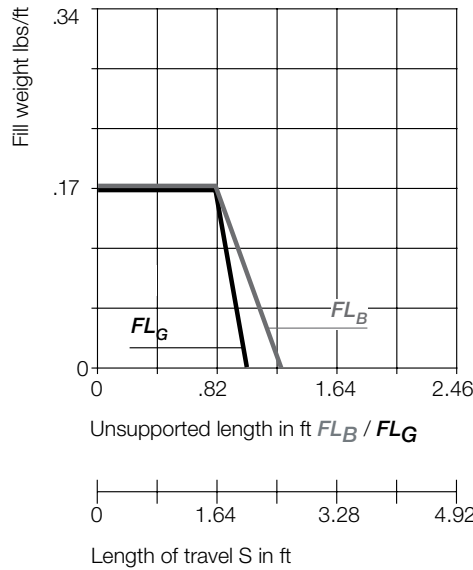
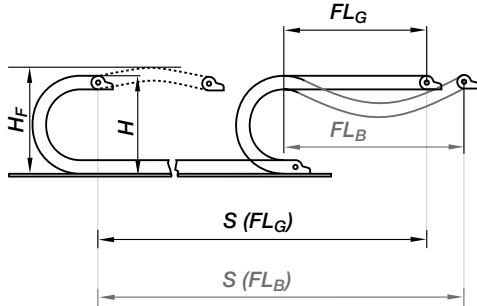

Short Travels - Unsupported

Unsupported e-chains® feature positive camber over short travels. This must be accounted for when specifying the clearance height. Please refer to **Installation dimensions** for further details.

Legend

- S = Length of travel
- R = Bending radius
- H = Nominal clearance height
- D = Overlength e-chain® radius in final position
- $K = \pi \cdot R + \text{safety buffer}$
- H_f = Required clearance height

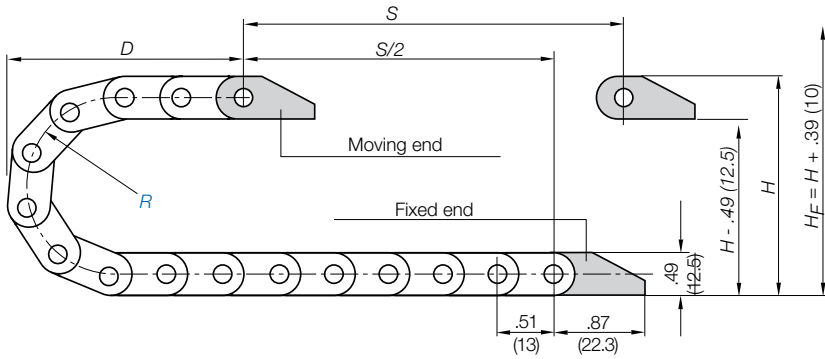

Pitch per link = .51" (13 mm)
 Links per ft (m) = 23.46 (77)
 For center mount applications:
 Chain length = $\frac{S}{2} + K$

The required clearance height: $H_f = H + .39$ in. (10 mm) (with .13 lbs/ft (0.2 kg/m) fill weight). Please consult igus® if space is particularly restricted.

R	.71 (018)	1.10 (028)	1.50 (038)
H*	1.91 (48.5)	2.70 (68.5)	3.48 (88.5)
D	1.73 (44)	2.13 (54)	2.52 (64)
K	3.35 (85)	4.53 (115)	5.91 (150)



PDF: igus.com/e-chain-pdfs
 Product information: igus.com/e-chains



Speed / acceleration FL_G	max. 65.6 ft/s (20 m/s) / max. 656 ft/s ² (200 m/s ²)
Speed / acceleration FL_B	max. 9.84 ft/s (3 m/s) / max. 19.69 ft/s ² (6 m/s ²)
Gliding speed / acceleration (maximum)	max. 32.8 ft/s (10 m/s) / max. 164 ft/s ² (50 m/s ²)
Material - permitted temperature	igumid G / -40°F (-40°C) up to +248°F (+120° C)
Flammability Class, igumid G	VDE 0304 IIC UL94 HB

Technical Data



Details of material properties

► Chapter 1

Series 047 - zip open along the outer radius

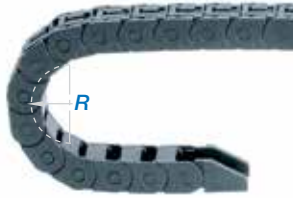
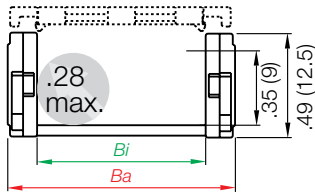

Part Number Structure



- Color - Black
- Bending radius
- Width
- Series

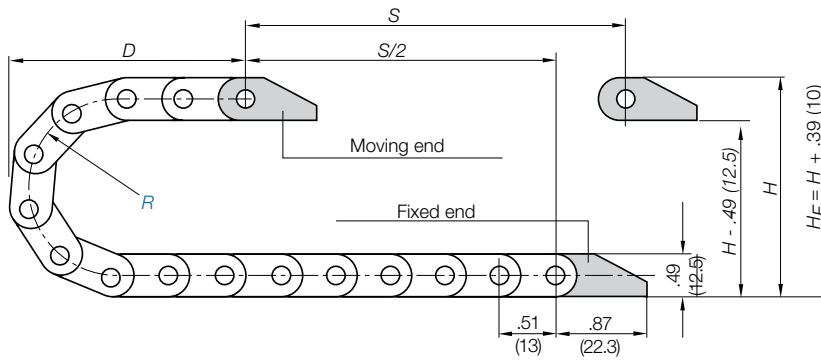

Supplement part number with required radius. Example: 047-10-038-0
Pitch: .51 in. (13 mm) per link links/ft (m) = 23.46 (77)

Part Number	Bi in. (mm)	Ba in. (mm)	Weight lbs/ft (kg/m)
047-10- <input type="text"/> -0	.39 (10)	.63 (16)	≈ 0.067 (0.10)
047-16- <input type="text"/> -0	.63 (16)	.87 (22)	≈ 0.074 (0.11)

Choose from the radii below for all of the above sizes
Radius (mm) Example: 047-10-038-0

	018	028	038
R	.71 (018)	1.10 (028)	1.50 (038)
H*	1.91 (48.5)	2.70 (68.5)	3.48 (88.5)
D	1.73 (44)	2.13 (54)	2.52 (64)
K	3.35 (85)	4.53 (115)	5.91 (150)

e-chain system® Zipper

Series 047

Mounting Brackets



Plastic, one-piece

- One-piece mounting bracket
- Corrosion resistant
- Available preassembled

Moving end
0450...1 (PZ)

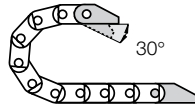

30°

Fixed end
0450-2 (PZ)

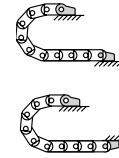

Possible installation configurations -

Part Number Structure

0450- 10- 12 PZ

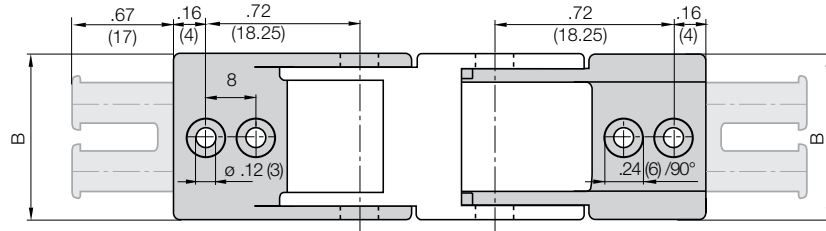
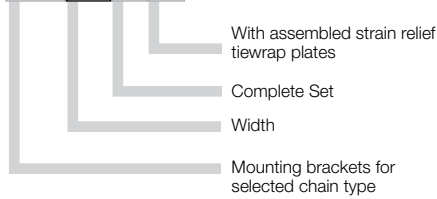

Full set, for both ends:

0450-10-12 Full set, each part with pin/bore

Single-part order:

0450-10-1 Mounting bracket with bore

0450-10-2 Mounting bracket with pin

Chain Type	Part No.	Part No.	Dimensions B		Number of Teeth
	Full set with Tiewrap Plate	Full Set without Tiewrap Plate	in.	(mm)	
047-10	0450-10-12PZ	0450-10-12	.63	(16)	1
047-16	0450-16-12PZ	0450-16-12	.87	(22)	2

Additional Accessories



Quickfix - mounting bracket with dowel, upon request

Part No.

0450-16-12Q



Price Index



Series 07

Special Features / Options



Upon request: Cleanroom Class 1
(ISO class 3) tested by the Dryden
Engineering Company, CA



Flammability Class
VDE 0304 IIC UL94 HB



Low-noise

Assembly Tips



“Zipper-fast” opening and closing

Usage Guidelines



- If fast, zipper-like accessibility to cables is required
- If quiet operation is required
- If aesthetic design is required
- If excellent service life is required



- If a more cost-effective, openable e-chain is required
 - Series B07 E2 Micro
- If cable installation without opening lids is possible
 - Series E06 E-Z Chain
- If a closed tube system is required
 - Series R07 E2 Zipper Tube

Features & Benefits

- 1 Mounting bracket with integrated strain relief
- 2 Zipper lids can be separated and joined at each link
- 3 Small pitch for low-noise and smooth operation
- 4 ‘Zipper-fast’ opening and closing
- 5 For high acceleration
- 6 Lightweight



Order Example: Complete e-chain®

Please indicate chain length or number of links. Example:

3.28 ft (1 m) 07-20-038-0

e-chain®

1 Set 060-20-12PZ

Mounting Bracket

e-chain system® Zipper Series 07 Installation Dimensions

Short travel, unsupported length

- FL_B = unsupported with permitted sag
 - FL_G = unsupported with straight upper run
- Further information ► Design, Chapter 1

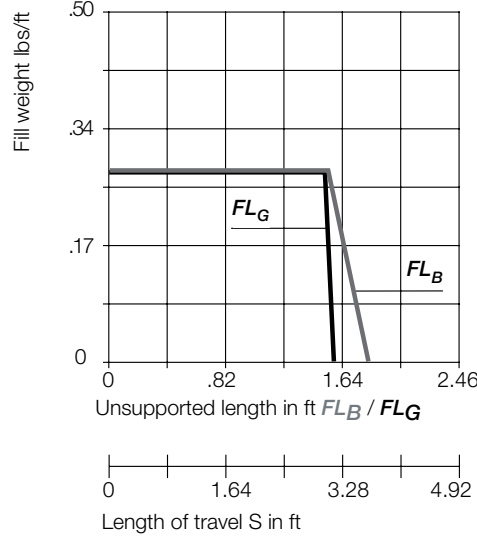
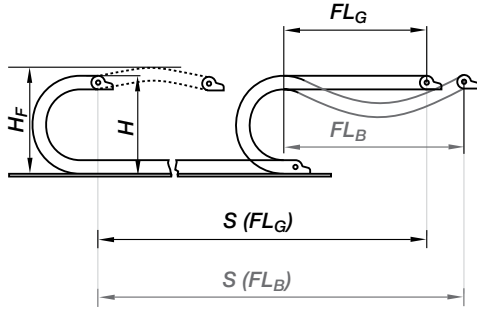

Short Travels - Unsupported

Unsupported e-chains® feature positive camber over short travels. This must be accounted for when specifying the clearance height. Please refer to **Installation dimensions** for further details.

Legend

- S = Length of travel
- R = Bending radius
- H = Nominal clearance height
- D = Overlength e-chain® radius in final position
- $K = \pi \cdot R + \text{safety buffer}$
- H_f = Required clearance height

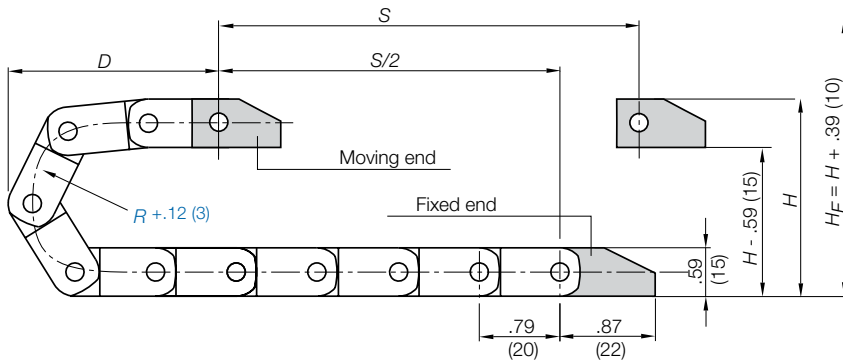

Pitch per link = .79" (20 mm)
 Links per ft (m) = 15.24 (50)
 For center mount applications:
 Chain length = $\frac{S}{2} + K$

The required clearance height: $H_f = H + .39 \text{ in. (10 mm)}$ (with .13 lbs/ft (0.2 kg/m) fill weight). Please consult igus® if space is particularly restricted.

R	.71 (018)	1.10 (028)	1.50 (038)	1.89 (048*)
H*	2.01 (51)	2.80 (71)	3.58 (91)	4.37 (111)
D	2.20 (56)	2.60 (66)	2.99 (76)	3.39 (86)
K	3.94 (100)	5.12 (130)	6.30 (160)	7.68 (195)

*This bend radius is only available for the 2.52" (64mm) inner width



PDF: igus.com/e-chain-pdfs
 Product information: igus.com/e-chains



Speed / acceleration FL_G	max. 65.6 ft/s (20 m/s) / max. 656 ft/s ² (200 m/s ²)
Speed / acceleration FL_B	max. 9.84 ft/s (3 m/s) / max. 19.69 ft/s ² (6 m/s ²)
Gliding speed / acceleration (maximum)	max. 32.8 ft/s (10 m/s) / max. 164 ft/s ² (50 m/s ²)
Material - permitted temperature	igumid G / -40°F (-40°C) up to +248°F (+120° C)
Flammability Class, igumid G	VDE 0304 IIC UL94 HB

Technical Data



Details of material properties

► Chapter 1

Series 07 - zip open along the outer radius

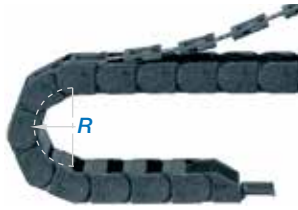
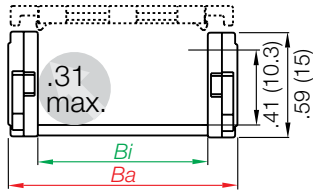

Part Number Structure



- Color - Black
- Bending radius
- Width
- Series

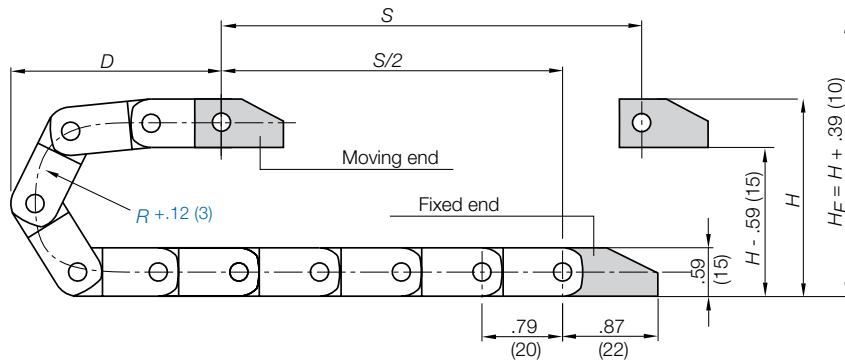

Supplement part number with required radius. Example: 07-20-038-0
Pitch: .79 in. (20 mm) per link links/ft (m) = 15.24 (50)

Part Number	Bi in. (mm)	Ba in. (mm)	Weight lbs/ft (kg/m)
07-06- <input type="checkbox"/> -0	.24 (6)	.49 (12.5)	≈ 0.087 (0.13)
07-10- <input type="checkbox"/> -0	.39 (10)	.65 (16.5)	≈ 0.094 (0.14)
07-16- <input type="checkbox"/> -0	.63 (16)	.89 (22.5)	≈ 0.108 (0.16)
07-20- <input type="checkbox"/> -0	.79 (20)	1.06 (27.0)	≈ 0.114 (0.17)
07-30- <input type="checkbox"/> -0	1.18 (30)	1.46 (37.0)	≈ 0.134 (0.20)
07-40- <input type="checkbox"/> -0	1.57 (40)	1.85 (47.0)	≈ 0.155 (0.23)
07-50- <input type="checkbox"/> -0	1.97 (50)	2.24 (57.0)	≈ 0.175 (0.26)
07-64- <input type="checkbox"/> -0	2.52 (64)	2.80 (71.0)	≈ 0.202 (0.30)

Choose from the radii below for all of the above sizes

Radius (mm) Example: 07-20-038-0

	018	028	038	048*
R	.71 (018)	1.10 (028)	1.50 (038)	1.89 (048*)
H*	2.01 (51)	2.80 (71)	3.58 (91)	4.37 (111)
D	2.20 (56)	2.60 (66)	2.99 (76)	3.39 (86)
K	3.94 (100)	5.12 (130)	6.30 (160)	7.68 (195)

*This bend radius is only available for the 2.52" (64mm) inner width

e-chain system® Zipper Series 07 Mounting Brackets



Plastic, one-piece

- One-piece mounting bracket
- Corrosion resistant
- Available preassembled
- Inner and outer attachment possible
- Available with or without integrated strain relief tiewrap plates

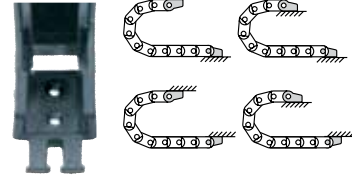
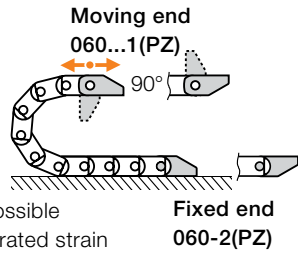

Possible installation configurations -

Part Number Structure



- With assembled strain relief tiewrap plates
- Complete Set
- Width
- Mounting brackets for selected chain type

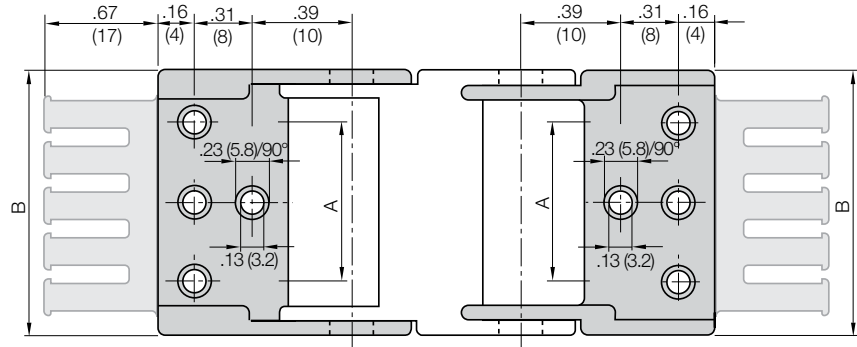

Full set, for both ends:

060- [20- 12] Full set, each part with pin/bore

Single-part order:

060- [20- 1] Mounting bracket with bore

060- [20- 2] Mounting bracket with pin

060-06-12 - 060-20-12:

Center bores only

060-30-12 - 060-64-12:

Outer bores only

Chain Type	Part No.		Dimension A		Dimensions B		Number of Teeth
	Full set with Tiewrap Plate	Full Set without Tiewrap Plate	in.	(mm)	in.	(mm)	
07-06	060-06-12PZ	060-06-12	—	—	.49	(12.5)	1
07-10	060-10-12PZ	060-10-12	—	—	.65	(16.5)	1
07-16	060-16-12PZ	060-16-12	—	—	.89	(22.5)	2
07-20	060-20-12PZ	060-20-12	—	—	1.06	(27.0)	2
07-30	060-30-12PZ	060-30-12	.87	(22)	1.46	(37.0)	3
07-40	060-40-12PZ	060-40-12	1.26	(32)	1.85	(47.0)	4
07-50	060-50-12PZ	060-50-12	1.65	(42)	2.24	(57.0)	5
07-64	060-64-12PZ	060-64-12	2.20	(56)	2.80	(71.0)	6

Additional Accessories



Quicksnap - the complete, detachable mounting unit, upon request

Part No.

- 060-10-QS
- 060-16-QS
- 060-20-QS
- 060-40-QS



Quickfix - mounting bracket with dowel, upon request

Part No.

- 060-10-34QZ
- 060-20-34QZ



Price Index

Series R07
Special Features / Options

Upon request: Cleanroom Class 1 (ISO class 3) tested by the Dryden Engineering Company, CA

 ESD classification:
 Electrically conductive ESD/
 ATEX version upon request

 Flammability Class
 VDE 0304 IIC UL94 HB

Low-noise

Assembly Tips

"Zipper" fast opening and closing

Usage Guidelines



- If fast installation using zipper lids is required
- If protection against dust and dirt is required
- If quick insertion of cables with preassembled connectors is required



- If opening of the link is not necessary
 - **Series 06 E2 Micro**
- If cable installation without opening lids is possible
 - **Series E06 E-Z Chain**

Features & Benefits

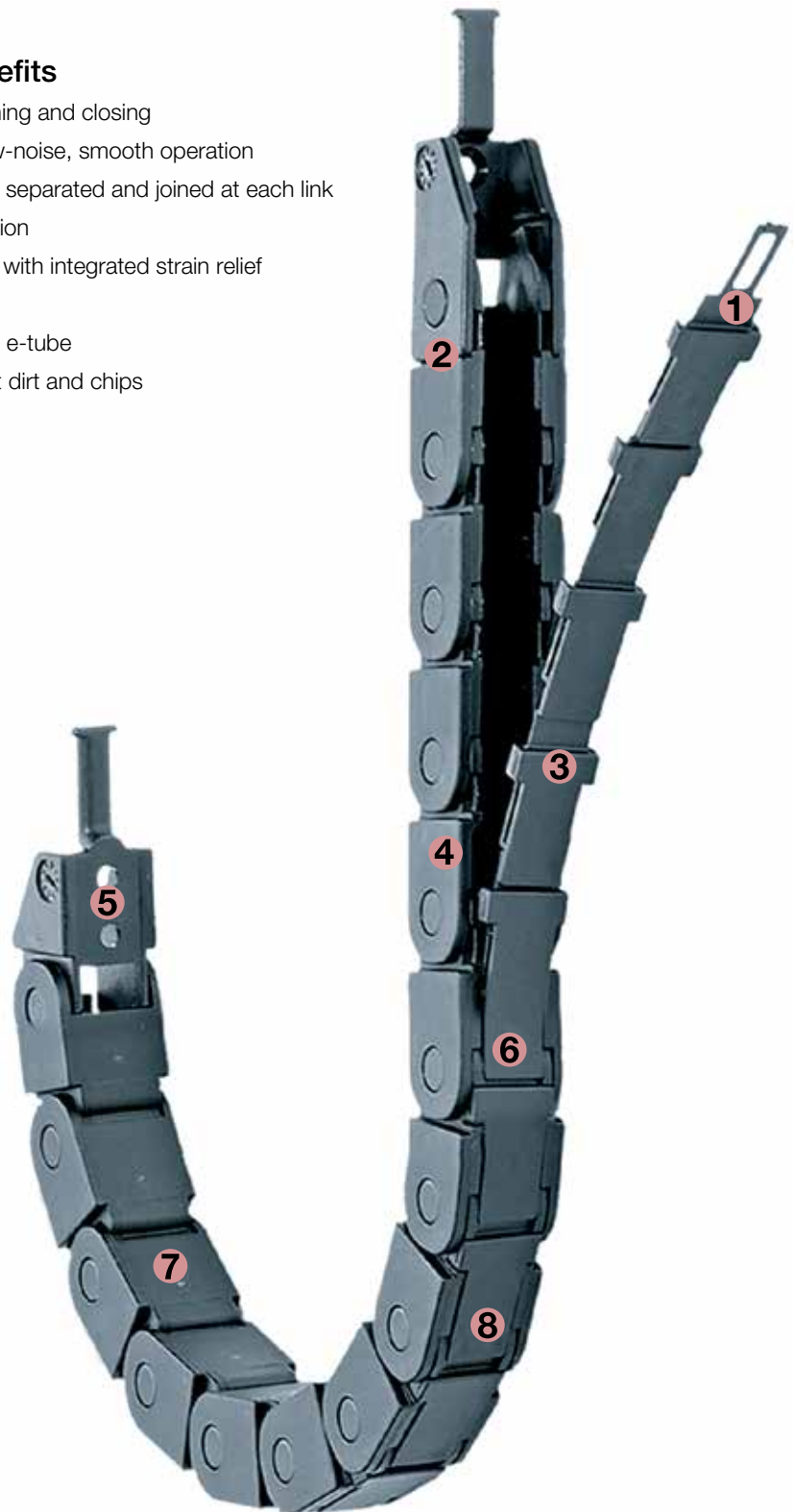
- 1 "Zipper" fast opening and closing
- 2 Small pitch for low-noise, smooth operation
- 3 Zipper lids can be separated and joined at each link
- 4 For high acceleration
- 5 Mounting bracket with integrated strain relief
- 6 Lightweight
- 7 Smallest zip-open e-tube
- 8 Protection against dirt and chips

Order Example: Complete e-chain®

Please indicate chain length or number of links. Example:

 3.28 ft (1 m) **R07-20-038-0**

e-chain®

 1 Set **060-20-12PZ**

Mounting Bracket

e-chain system® E2 tubes

Series R07

Installation Dimensions



R07

Short travel, unsupported length

- FL_B = unsupported with permitted sag
 - FL_G = unsupported with straight upper run
- Further information ► Design, Chapter 1

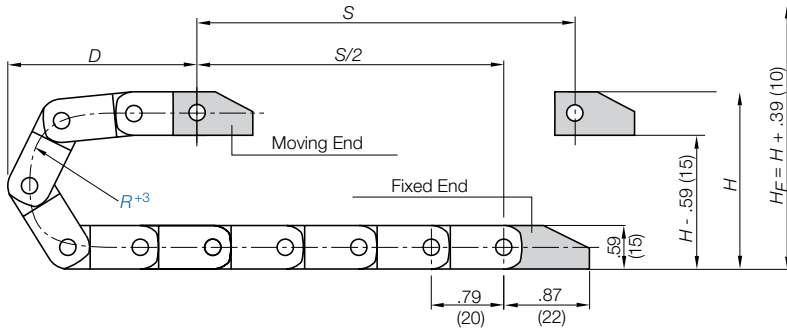
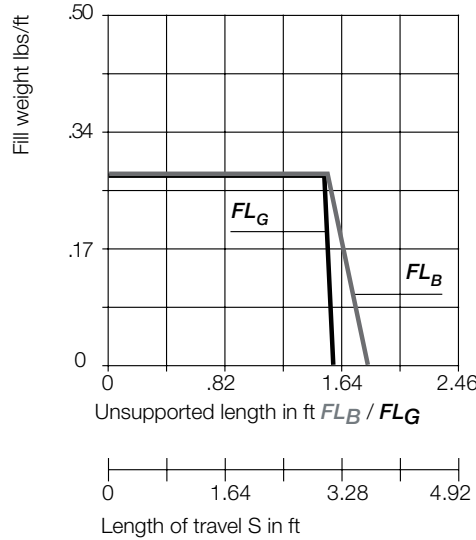
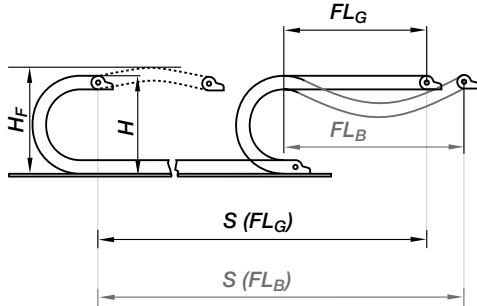

The required clearance height: $H_F = H + .39$ in. (10 mm) (with .13 lbs/ft (0.2 kg/m) fill weight). Please consult igus® if space is particularly restricted.

R	1.50 (038)	1.89 (048)
H	3.58 (91)	4.37 (111)
D	2.99 (76)	3.39 (86)
K	6.30 (160)	7.68 (195)

Short Travels - Unsupported



Unsupported e-chains® feature positive camber over short travels. This must be accounted for when specifying the clearance height. Please refer to **Installation dimensions** for further details.

Legend

- S = Length of travel
- R = Bending radius
- H = Nominal clearance height
- D = Overlength e-chain® radius in final position
- $K = \pi \cdot R + \text{Safety buffer}$
- H_F = Required clearance height

Pitch per link = .79" (20 mm)
 Links per ft (m) = 15.24 (50)
 For center mount applications:
 Chain length = $S/2 + K$



PDF: igus.com/e-chain-pdfs
 Product information: igus.com/e-chains



Speed / acceleration FL_G	max. 65.6 ft/s (20 m/s) / max. 656 ft/s ² (200 m/s ²)
Speed / acceleration FL_B	max. 9.84 ft/s (3 m/s) / max. 19.69 ft/s ² (6 m/s ²)
Gliding speed / acceleration (maximum)	max. 9.84 ft/s (3 m/s) / max. 32.8 ft/s ² (10 m/s ²)
Material - permitted temperature	igumid G / -40°F (-40°C) up to +248°F (+120° C)
Flammability Class, igumid G	VDE 0304 IIC UL94 HB

Technical Data



Details of material properties

► Chapter 1

Series R07 - e-tube zip open along the outer radius

igus®
e-chain system®

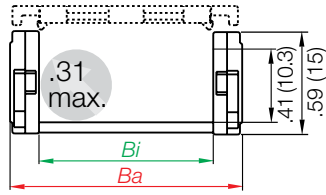

Part Number Structure



- Color - Black
- Bending radius
- Width
- Series

Telephone 1-800-521-2747

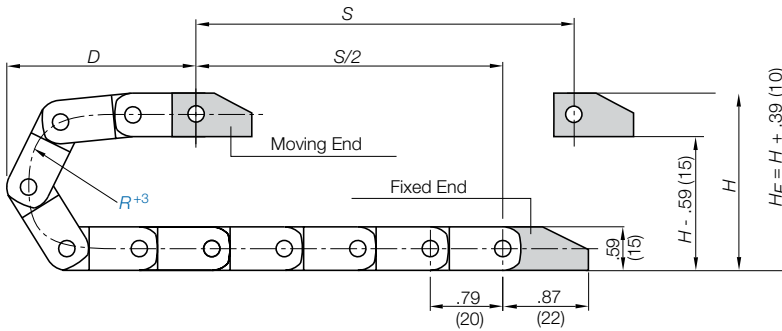

Supplement part number with required radius. Example: R07-20-**038**-0
Pitch: .79 in. (20 mm) per link links/ft (m) = 15.24 (50)

Part Number	<i>Bi</i> in. (mm)	<i>Ba</i> in. (mm)	Weight lbs/ft (kg/m)
R07-10- <input type="text"/> -0	.39 (10)	.65 (16.5)	≈ 0.094 (0.14)
R07-16- <input type="text"/> -0	.63 (16)	.89 (22.5)	≈ 0.108 (0.16)
R07-20- <input type="text"/> -0	.79 (20)	1.06 (27.0)	≈ 0.114 (0.17)
R07-30- <input type="text"/> -0	1.18 (30)	1.46 (37.0)	≈ 0.134 (0.20)
R07-40- <input type="text"/> -0	1.57 (40)	1.85 (47.0)	≈ 0.155 (0.23)
R07-50- <input type="text"/> -0	1.97 (50)	2.24 (57.0)	≈ 0.175 (0.26)

Choose from the radii below for all of the above sizes

Radius (mm) Example: R07-20-**038**-0

	038	048
<i>R</i>	1.50 (038)	1.89 (048)
<i>H</i>	3.58 (91)	4.37 (111)
<i>D</i>	2.99 (76)	3.39 (86)
<i>K</i>	6.30 (160)	7.68 (195)

Internet: igus.com
email: sales@igus.com
QuickSpec: igus.com/quickspec

e-chain system® E2 tubes Series R07 Mounting Brackets - Plastic



R07



Plastic, one-piece

- One-piece mounting bracket
- Corrosion resistant
- Available preassembled
- Inner and outer attachment possible
- Available with or without strain relief tiwrap plates

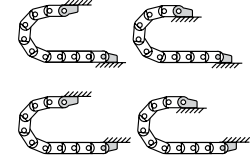
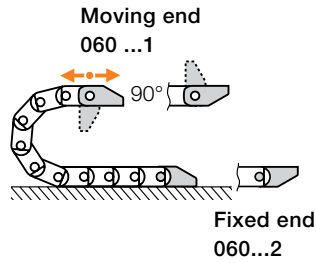

Possible installation configurations -

Part Number Structure

060-	10-	12	PZ
------	-----	----	----

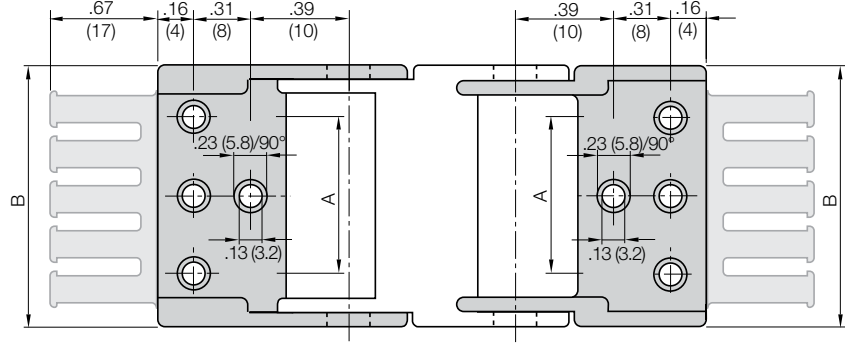
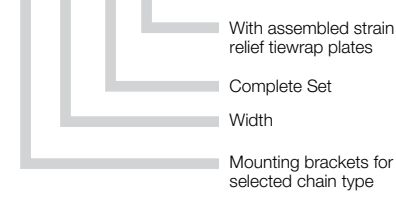

Full set, for both ends:

060- [10-] [12] Full set, each part with pin/bore

Single-part order:

060- [10-] [1] Mounting bracket with bore

060- [10-] [2] Mounting bracket with pin

060-10-12 - 060-20-12:

Center bores only

060-30-12 - 060-50-12:

Outer bores only

Chain Type	Part No. Full set with Tiwrap Plate	Part No. Full Set without Tiwrap Plate	Dimension A		Dimensions B		Number of Teeth
			in.	(mm)	in.	(mm)	
R07-10	060-10-12PZ	060-10-12	—	—	.65	(16.5)	1
R07-16	060-16-12PZ	060-16-12	—	—	.89	(22.5)	2
R07-20	060-20-12PZ	060-20-12	—	—	1.06	(27.0)	2
R07-30	060-30-12PZ	060-30-12	.87	(22)	1.46	(37.0)	3
R07-40	060-40-12PZ	060-40-12	1.26	(32)	1.85	(47.0)	4
R07-50	060-50-12PZ	060-50-12	1.65	(42)	2.24	(57.0)	5

Additional Accessories



Quicksnap - the complete, detachable mounting unit, upon request

Part No.

060-10-QS

060-16-QS

060-20-QS

060-40-QS



Quickfix - mounting bracket with dowel, upon request

Part No.

060-10-34QZ

060-20-34QZ

PDF: igus.com/e-chain-pdfs
Product information: igus.com/e-chains



Price Index



Series 09

Special Features / Options



Upon request: Cleanroom Class 1
(ISO class 3) tested by the Dryden
Engineering Company, CA



Flammability Class
VDE 0304 IIC UL94 HB



Low-noise

Assembly Tips

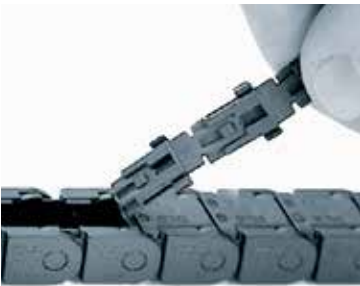

“Zipper-fast” opening and closing

Usage Guidelines



- If fast, zipper-like accessibility to cables is required
- If quick, easy insertion of cables with preassembled connectors is required
- If quiet operation is required
- If aesthetic design is required
- If high acceleration and travel speed is present



- If a more cost-effective, openable e-chain is required
 - **Series B09 E2 Micro**
- If cable installation without opening lids is possible
 - **Series E08 E-Z Chain**
- If a closed tube system is required
 - **Series R09 E2 Zipper Tube**

Features & Benefits

- 1 Zipper lids can be separated and joined at each link
- 2 Small pitch for low-noise and smooth operation
- 3 ‘Zipper-fast’ opening and closing
- 4 For high acceleration
- 5 Mounting bracket with integrated strain relief
- 6 Lightweight



Order Example: Complete e-chain®

Please indicate chain length or number of links. Example:

3.28 ft (1 m) **09-20-038-0**



e-chain®

1 Set **080-20-12PZ**



Mounting Bracket

e-chain system® Zipper Series 09 Installation Dimensions

Short travel, unsupported length

- FL_B = unsupported with permitted sag
 - FL_G = unsupported with straight upper run
- Further information ► Design, Chapter 1

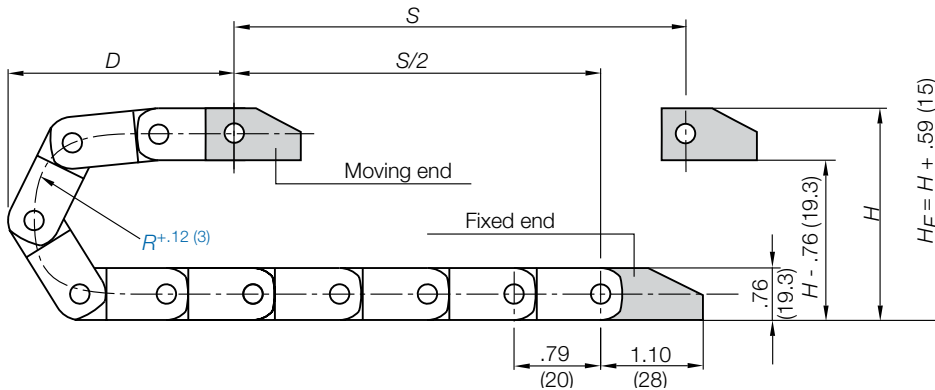
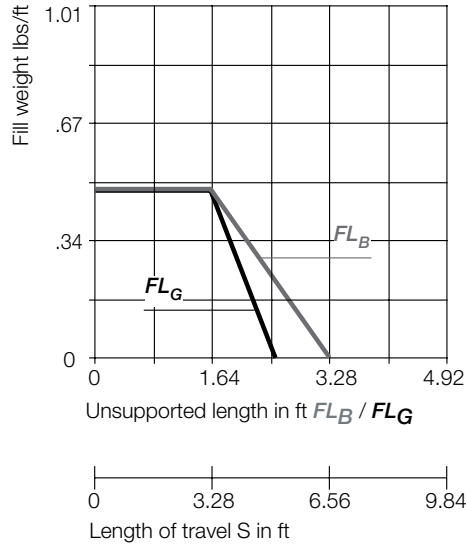
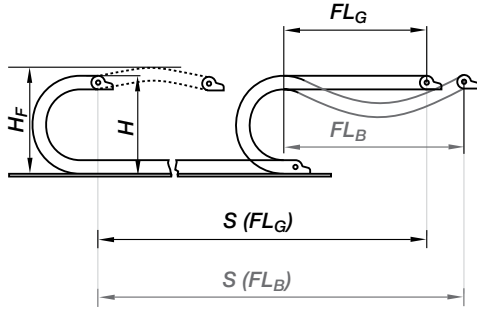

Short Travels - Unsupported

Unsupported e-chains® feature positive camber over short travels. This must be accounted for when specifying the clearance height. Please refer to **Installation dimensions** for further details.

Legend

- S = Length of travel
- R = Bending radius
- H = Nominal clearance height
- D = Overlength e-chain® radius in final position
- $K = \pi \cdot R + \text{safety buffer}$
- H_F = Required clearance height

Pitch per link: = .79" (20 mm)
Links per ft (m): = 15.24 (50)
For center mount applications:
Chain length = $\frac{S}{2} + K$

The required clearance height: $H_F = H + .59 \text{ in. (15 mm)}$ (with .20 lbs/ft (0.3 kg/m) fill weight). Please consult igus® if space is particularly restricted.

R	1.10 (028)	1.50 (038)	1.89 (048)
H*	2.95 (75)	3.74 (95)	4.53 (115)
D	2.68 (68)	3.07 (78)	3.46 (88)
K	5.12 (130)	6.30 (160)	7.68 (195)



PDF: igus.com/e-chain-pdfs
Product information: igus.com/e-chains



Speed / acceleration FL_G	max. 65.6 ft/s (20 m/s) / max. 656 ft/s ² (200 m/s ²)
Speed / acceleration FL_B	max. 9.84 ft/s (3 m/s) / max. 19.69 ft/s ² (6 m/s ²)
Gliding speed / acceleration (maximum)	max. 32.8 ft/s (10 m/s) / max. 164 ft/s ² (50 m/s ²)
Material - permitted temperature	igumid G / -40°F (-40°C) up to +248°F (+120° C)
Flammability Class, igumid G	VDE 0304 IIC UL94 HB

Technical Data



Details of material properties

► Chapter 1

Series 09 - zip open along the outer radius

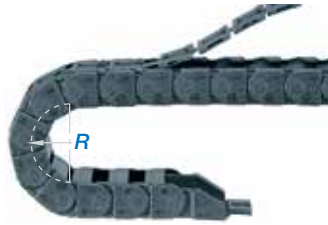
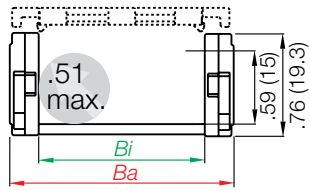

Part Number Structure



Color - Black
Bending radius
Width
Series

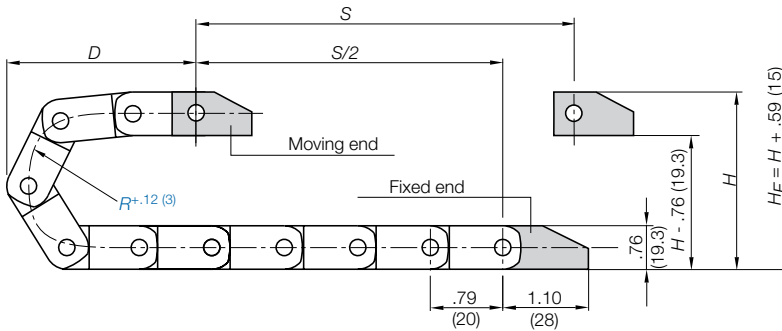

Supplement part number with required radius. Example: 09-20-038-0
Pitch: .79 in. (20 mm) per link links/ft (m) = 15.24 (50)

Part Number	Bi in. (mm)	Ba in. (mm)	Weight lbs/ft (kg/m)
09-10- [] -0	.39 (10)	.72 (18.2)	≈ 0.141 (0.21)
09-16- [] -0	.63 (16)	.95 (24.2)	≈ 0.161 (0.24)
09-20- [] -0	.79 (20)	1.11 (28.2)	≈ 0.168 (0.25)
09-30- [] -0	1.18 (30)	1.50 (38.2)	≈ 0.188 (0.28)
09-40- [] -0	1.57 (40)	1.90 (48.2)	≈ 0.208 (0.31)
09-50- [] -0	1.97 (50)	2.29 (58.2)	≈ 0.228 (0.34)

Choose from the radii below for all of the above sizes

Radius (mm) Example: 09-20-038-0

	028	038	048
R	1.10 (028)	1.50 (038)	1.89 (048)
H*	2.95 (75)	3.74 (95)	4.53 (115)
D	2.68 (68)	3.07 (78)	3.46 (88)
K	5.12 (130)	6.30 (160)	7.68 (195)

Additional Accessories



Quicksnap - the complete, detachable mounting unit, upon request

Part No.
080-20-QS
080-30-QS

Interior Separation

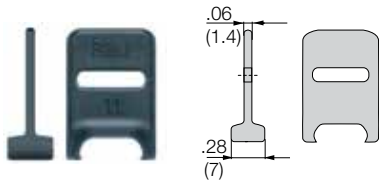

Slotted separator

Unassembled	Part No. B09-2
Assembled	Part No. B09-2-1

- **Separator B09-2** is used when vertical separation is required. Due to its slot, it allows basic vertical/horizontal shelving arrangements.

Full-width shelves - for the standard interior separation

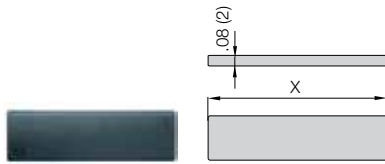

Full width shelf

Unassembled	Part No. 110-X
Assembled	Part No. 111-X

- **Full width shelf** is used in applications with many thin cables with similar diameters.

Width X in. (mm)	Part No. Unassembled	Part No. Assembled	Width X in. (mm)	Part No. Unassembled	Part No. Assembled	Width X in. (mm)	Part No. Unassembled	Part No. Assembled
0.63 (16)	110-16	111-16	1.18 (30)	110-30	111-30	1.97 (50)	110-50	111-50
0.79 (20)	110-20	111-20	1.57 (40)	110-40	111-40			

Mounting Brackets - Plastic



Plastic, pivoting

- One-piece mounting bracket
- Corrosion resistant
- Available preassembled
- Inner and outer attachment possible
- Available with or without strain relief tiewrap plates



Part Number Structure

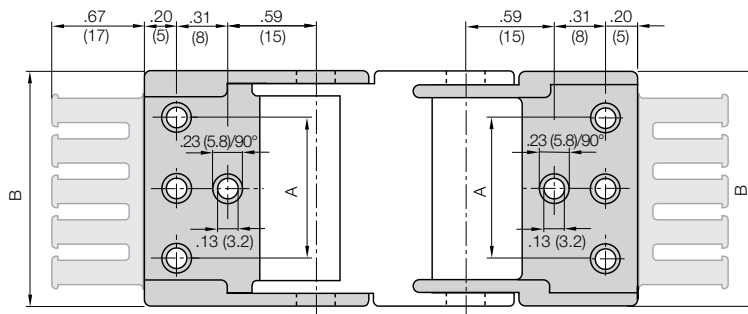
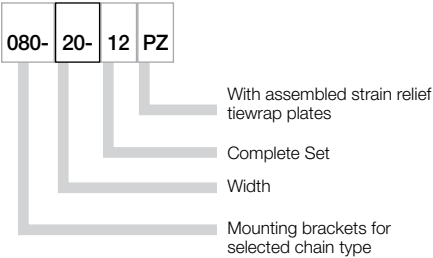

Full set, for both ends:

080- 20- 12 Full set, each part with pin/bore

Single-part order:

080- 20- 1 Mounting bracket with bore

080- 20- 2 Mounting bracket with pin

080-10-12 - 080-20-12:

Center bores only

080-30-12 - 080-50-12:

Outer bores only

Chain Type	Part No. Full set with Tiewrap Plate	Part No. Full Set without Tiewrap Plate	Dimension A in. (mm)	Dimensions B in. (mm)	Number of Teeth
09-10	080-10-12PZ	080-10-12	— —	.72 (18.2)	1
09-16	080-16-12PZ	080-16-12	— —	.95 (24.2)	2
09-20	080-20-12PZ	080-20-12	— —	1.11 (28.2)	2
09-30	080-30-12PZ	080-30-12	.87 (22)	1.50 (38.2)	3
09-40	080-40-12PZ	080-40-12	1.26 (32)	1.90 (48.2)	4
09-50	080-50-12PZ	080-50-12	1.65 (42)	2.29 (58.2)	5



Price Index



Series R09

Special Features / Options



Upon request: Cleanroom Class 1 (ISO class 3) tested by the Dryden Engineering Company, CA



iF-Design Award Winner



Flammability Class
VDE 0304 IIC UL94 HB



Low-noise

Assembly Tips



"Zipper" fast opening and closing

Usage Guidelines



- If fast installation using zipper lids is required
- If protection against dust and dirt is required
- If quick insertion of cables with preassembled connectors is required



- If opening of the link is not necessary
 - Series 08 E2 Micro
- If cable installation without opening lids is necessary
 - Series E08 E-Z Chain

Features & Benefits

- 1 "Zipper" fast opening and closing
- 2 Small pitch for low-noise, smooth operation
- 3 Lightweight
- 4 Zipper lids can be separated and joined at each link
- 5 Small zip-open e-tube
- 6 For high acceleration
- 7 Mounting bracket with integrated strain relief
- 8 Protection against dirt and chips
- 9 iF-Design Award Winner

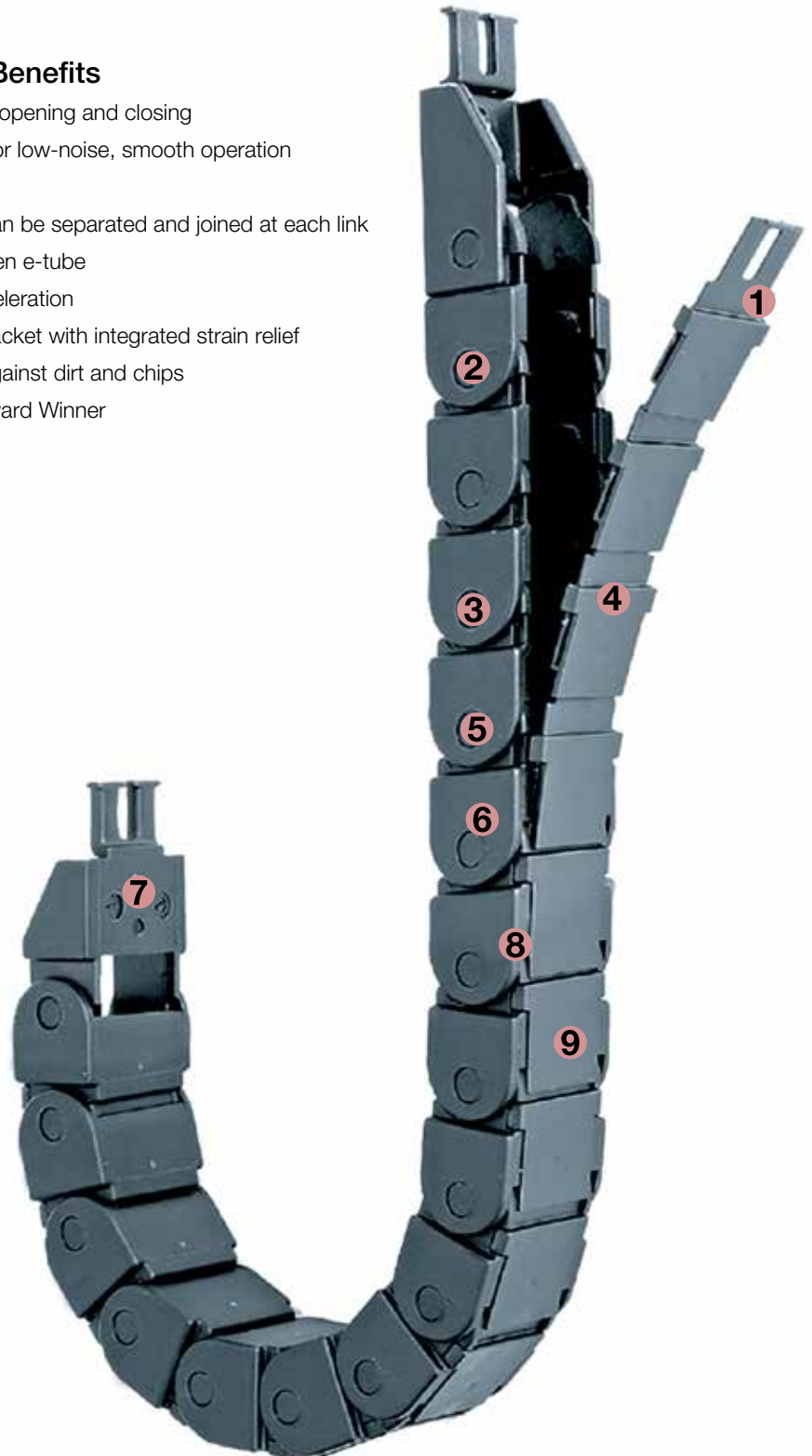

Order Example: Complete e-chain®

Please indicate chain length or number of links. Example:

3.28 ft (1 m) R09-20-048-0

1 Set 080-20-12PZ

e-chain system® E2 tubes

Series R09

Installation Dimensions



R09

Short travel, unsupported length

- FL_B = unsupported with permitted sag
 - FL_G = unsupported with straight upper run
- Further information ► Design, Chapter 1

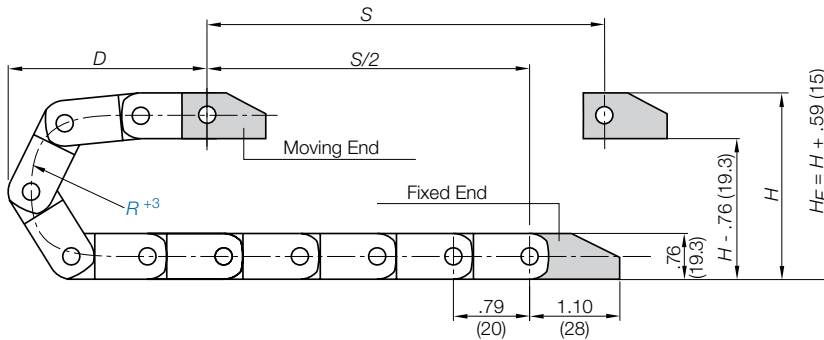
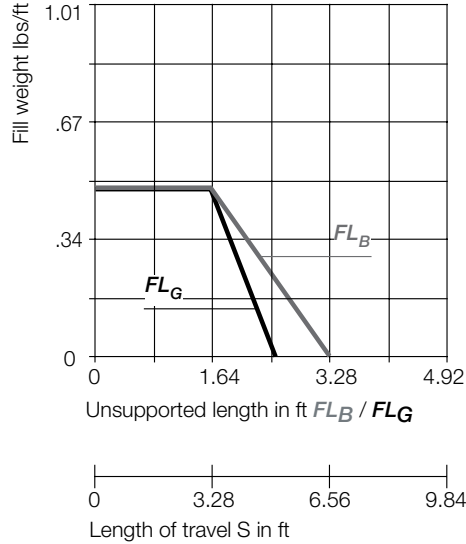
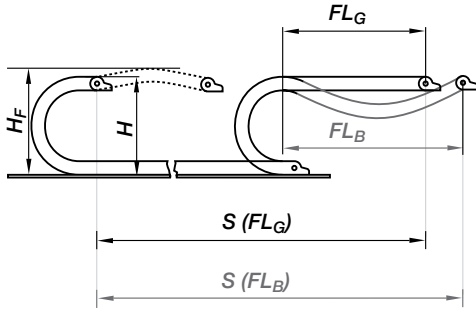

Short Travels - Unsupported

Unsupported e-chains® feature positive camber over short travels. This must be accounted for when specifying the clearance height. Please refer to **Installation dimensions** for further details.

Legend

- S = Length of travel
- R = Bending radius
- H = Nominal clearance height
- D = Overlength e-chain® radius in final position
- $K = \pi \cdot R + \text{Safety buffer}$
- $H_F = \text{Required clearance height}$

Pitch per link = .79" (20 mm)
 Links per ft (m) = 15.24 (50)
 For center mount applications:
 Chain length = $\frac{S}{2} + K$

The required clearance height: $H_F = H + .59 \text{ in. (15 mm)}$ (with .20 lbs/ft (0.3 kg/m) fill weight). Please consult igus® if space is particularly restricted.

R	1.89 (048)	2.95 (075)	3.94 (100)
H	4.53 (115)	6.65 (169)	8.62 (219)
D	3.46 (88)	4.53 (115)	5.51 (140)
K	7.68 (195)	11.02 (280)	13.98 (355)

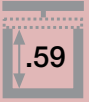

PDF: igus.com/e-chain-pdfs
 Product information: igus.com/e-chains



Speed / acceleration FL_G	max. 65.6 ft/s (20 m/s) / max. 656 ft/s ² (200 m/s ²)
Speed / acceleration FL_B	max. 9.84 ft/s (3 m/s) / max. 19.69 ft/s ² (6 m/s ²)
Gliding speed / acceleration (maximum)	max. 32.8 ft/s (10 m/s) / max. 164 ft/s ² (50 m/s ²)
Material - permitted temperature	igumid G / -40°F (-40°C) up to +248°F (+120° C)
Flammability Class, igumid G	VDE 0304 IIC UL94 HB

Technical Data



Details of material properties

► Chapter 1

Series R09 - e-tube zip open along the outer radius

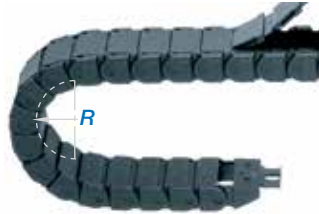
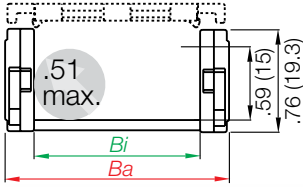

Part Number Structure



Color - Black
Bending radius
Width
Series

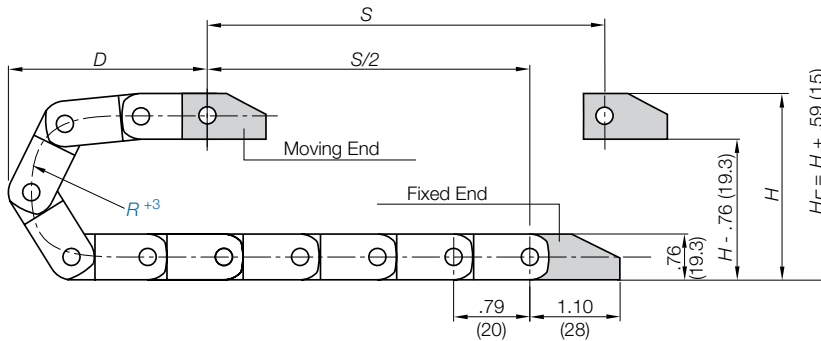

Supplement part number with required radius. Example: R09-20-048-0
Pitch: .79 in. (20 mm) per link links/ft (m) = 15.24 (50)

Part Number	<i>Bi</i> in. (mm)	<i>Ba</i> in. (mm)	Weight lbs/ft (kg/m)
R09-10- <input type="text"/> -0	.39 (10)	.72 (18.2)	≈0.155 (0.23)
R09-16- <input type="text"/> -0	.63 (16)	.95 (24.2)	≈0.175 (0.26)
R09-20- <input type="text"/> -0	.79 (20)	1.11 (28.2)	≈0.181 (0.27)
R09-30- <input type="text"/> -0	1.18 (30)	1.50 (38.2)	≈0.202 (0.30)
R09-40- <input type="text"/> -0	1.57 (40)	1.90 (48.2)	≈0.222 (0.33)
R09-50- <input type="text"/> -0	1.97 (50)	2.29 (58.2)	≈0.242 (0.36)

Choose from the radii below for all of the above sizes

Radius (mm) Example: R09-20-038-0

	048	075	100
R	1.89 (048)	2.95 (075)	3.94 (100)
H	4.53 (115)	6.65 (169)	8.62 (219)
D	3.46 (88)	4.53 (115)	5.51 (140)
K	7.68 (195)	11.02 (280)	13.98 (355)

Mounting Brackets - Plastic



Plastic, one-piece

- One-piece mounting bracket
- Corrosion resistant
- Available preassembled
- Inner and outer attachment possible
- Available with or without strain relief tiwrap plates

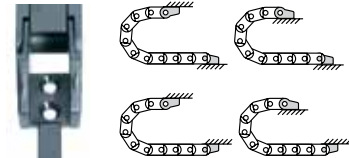
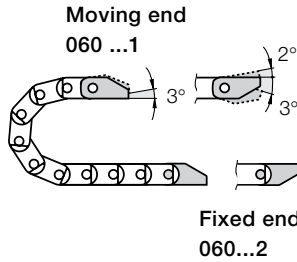

Possible installation configurations -

Part Number Structure



- With assembled strain relief tiwrap plates
- Complete Set
- Width
- Mounting brackets for selected chain type

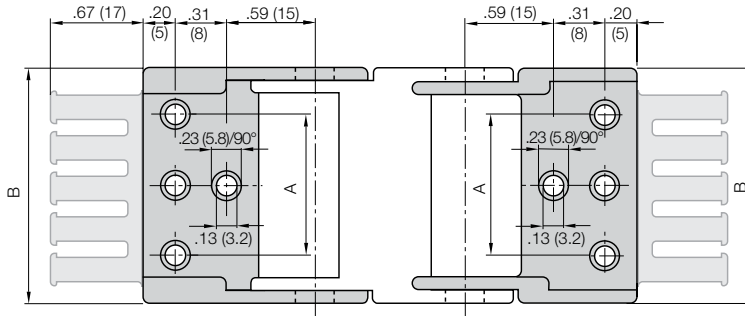

Full set, for both ends:

080-20-12 Full set, each part with pin/bore

Single-part order:

080-20-1 Mounting bracket with bore

080-20-2 Mounting bracket with pin

080-10-12 - 080-20-12:

Center bores only

080-30-12 - 080-50-12:

Outer bores only

Chain Type	Part No. Full set with Tiewrap Plate	Part No. Full Set without Tiewrap Plate	Dimension A in. (mm)	Dimensions B in. (mm)	Number of Teeth
R09-10	080-10-12PZ	080-10-12	— —	.72 (18.2)	1
R09-16	080-16-12PZ	080-16-12	— —	.95 (24.2)	2
R09-20	080-20-12PZ	080-20-12	— —	1.11 (28.2)	2
R09-30	080-30-12PZ	080-30-12	.87 (22)	1.50 (38.2)	3
R09-40	080-40-12PZ	080-40-12	1.26 (32)	1.90 (48.2)	4
R09-50	080-50-12PZ	080-50-12	1.65 (42)	2.29 (58.2)	5

Additional Accessories



Quicksnap - the complete, detachable mounting unit, upon request

Part No.

080-20-QS

080-30-QS



Price Index



Series 15

Special Features / Options



Upon request: Cleanroom Class 1 (ISO class 3) tested by the Dryden Engineering Company, CA



Flammability Class
VDE 0304 IIC UL94 HB



Low-noise

Assembly Tips



“Zipper-fast” opening and closing

Usage Guidelines



- If fast, zipper-like accessibility to cables is required
- If interior separation is required
- If high stability and long service life are required



- If opening of the link is not necessary
➤ **Series 10 E2 Mini**
- If torsion occurs
➤ **Series E14 E-Z Chain**
- If the chain must snap-open along the inner radius
➤ **Series B15i E2 Mini**

Features & Benefits

- 1 Large pins and double stop dog for superior life and long unsupported length
- 2 ‘Zipper-fast’ opening and closing
- 3 Small pitch for low-noise, smooth
- 4 operation
Zipper lids can be separated and joined at
- 5 each link
Mounting bracket with integrated strain
- 6 relief
For high acceleration



Order Example: Complete e-chain®

Please indicate chain length or number of links. Example:

3.28 ft (1 m) **15-025-038-0**

e-chain®

With 2 separators **154** assembled every 2nd link

Interior Separation

1 Set **1025-12PZ**

Mounting Bracket

e-chain system® Zipper Series 15 Installation Dimensions

Short travel, unsupported length

- FL_B = unsupported with permitted sag
 - FL_G = unsupported with straight upper run
- Further information ► Design, Chapter 1

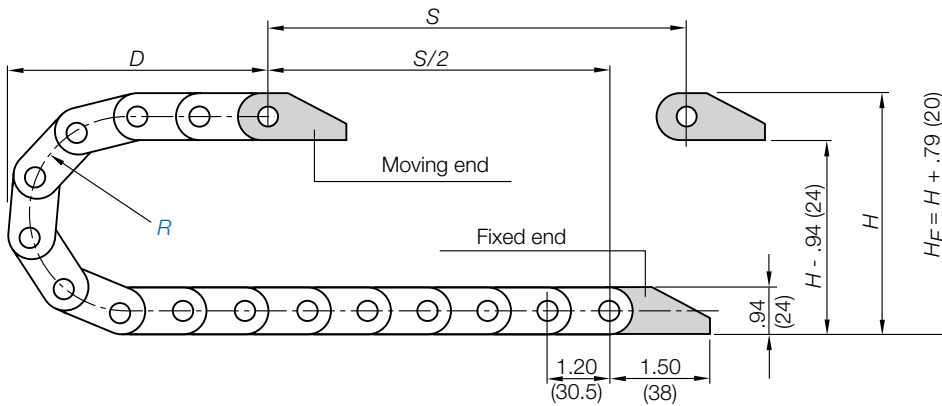
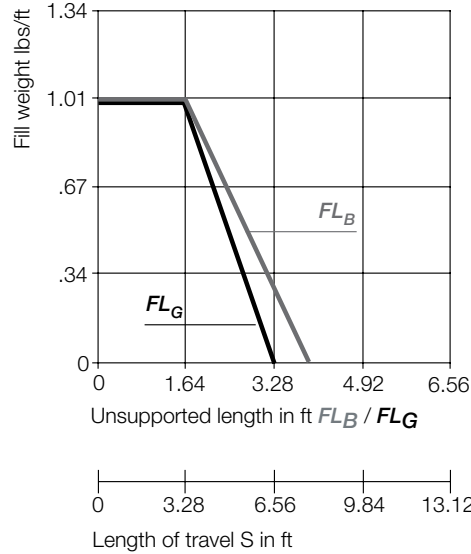
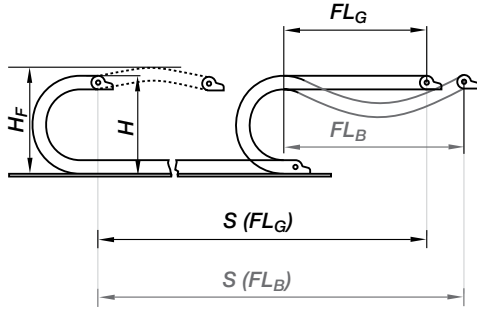

Short Travels - Unsupported

Unsupported e-chains® feature positive camber over short travels. This must be accounted for when specifying the clearance height. Please refer to **Installation dimensions** for further details.

Legend

- S = Length of travel
- R = Bending radius
- H = Nominal clearance height
- D = Overlength e-chain® radius in final position
- $K = \pi \cdot R + \text{safety buffer}$
- H_F = Required clearance height

Pitch per link = 1.20" (30.5 mm)
Links per ft (m) = 10.06 (33)
For center mount applications:
Chain length = $\frac{S}{2} + K$

The required clearance height: $H_F = H + .79 \text{ in. (20 mm)}$ (with .67 lbs/ft (1.0 kg/m) fill weight). Please consult igus® if space is particularly restricted.

R	1.50 (038)	1.89 (048)	2.95 (075)	3.94 (100)	4.33 (110)	4.92 (125)	5.71 (145)	7.09 (180)
H	3.90 (99)	4.69 (119)	6.81 (173)	8.78 (223)	9.57 (243)	10.75 (273)	12.32 (313)	15.08 (383)
D	3.74 (95)	4.13 (105)	5.20 (132)	6.18 (157)	6.57 (167)	7.17 (182)	7.95 (202)	9.33 (237)
K	7.28 (185)	8.46 (215)	11.81 (300)	14.96 (380)	16.14 (410)	17.91 (455)	20.47 (520)	24.80 (630)



PDF: igus.com/e-chain-pdfs
Product information: igus.com/e-chains



Speed / acceleration FL_G	max. 65.6 ft/s (20 m/s) / max. 656 ft/s ² (200 m/s ²)
Speed / acceleration FL_B	max. 9.84 ft/s (3 m/s) / max. 19.69 ft/s ² (6 m/s ²)
Gliding speed / acceleration (maximum)	max. 32.8 ft/s (10 m/s) / max. 164 ft/s ² (50 m/s ²)
Material - permitted temperature	igumid G / -40°F (-40°C) up to +248°F (+120° C)
Flammability Class, igumid G	VDE 0304 IIC UL94 HB

Technical Data



Details of material properties

► Chapter 1

Series 15 - Zip-open along the outer radius

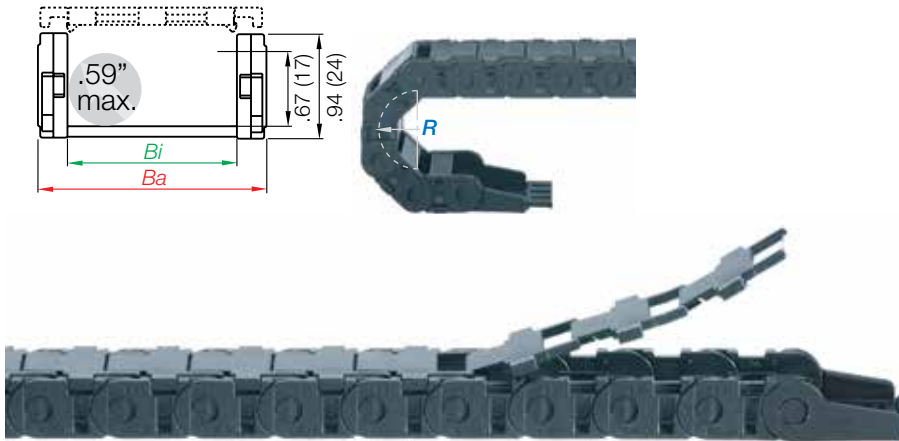

Part Number Structure

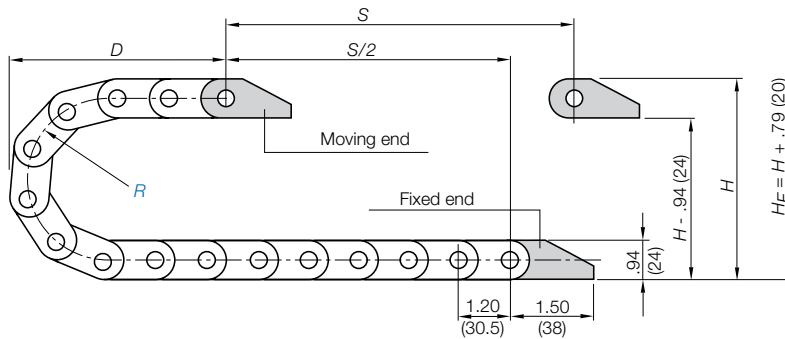
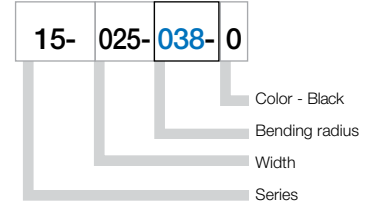

Supplement part number with required radius. Example: 15-025-**038**-0
Pitch: 1.20 in. (30.5 mm) per link links/ft (m) = 10.06 (33)

Part Number	<i>Bi</i>	<i>Ba</i>	Weight
Snap-open outer radius	in. (mm)	in. (mm)	lbs/ft (kg/m)
15-015- <input type="text"/> -0	.59 (15)	1.02 (26)	≈ 0.235 (0.35)
15-025- <input type="text"/> -0	.98 (25)	1.42 (36)	≈ 0.269 (0.40)
15-038- <input type="text"/> -0	1.50 (38)	1.93 (49)	≈ 0.309 (0.46)
15-050- <input type="text"/> -0	1.97 (50)	2.40 (61)	≈ 0.349 (0.52)
15-5- <input type="text"/> -0	2.48 (63)	2.99 (76)	≈ 0.423 (0.63)
15-6 <input type="text"/> -0	3.15 (80)	3.70 (94)	≈ 0.470 (0.70)
15-7 <input type="text"/> -0	3.94 (100)	4.45 (113)	≈ 0.511 (0.76)

Choose from the radii below for all of the above sizes
Radius (mm) Example: 15-025-**038**-0

	038	048	075	100	110	125	145	180
R	1.50 (038)	1.89 (048)	2.95 (075)	3.94 (100)	4.33 (110)	4.92 (125)	5.71 (145)	7.09 (180)
H	3.90 (99)	4.69 (119)	6.81 (173)	8.78 (223)	9.57 (243)	10.75 (273)	12.32 (313)	15.08 (383)
D	3.74 (95)	4.13 (105)	5.20 (132)	6.18 (157)	6.57 (167)	7.17 (182)	7.95 (202)	9.33 (237)
K	7.28 (185)	8.46 (215)	11.81 (300)	14.96 (380)	16.14 (410)	17.91 (455)	20.47 (520)	24.80 (630)

0=Standard color black. For other colors see Chapter 1

Interior Separation



Option 1: Vertical separators

Vertical separators are used if only a vertical subdivision of the e-chain® interior is required. A slotted separator is used for this subdivision. This separator can also be used with full-width shelves for a continuous horizontal subdivision. By standard, vertical separators are assembled every other e-chain® link.

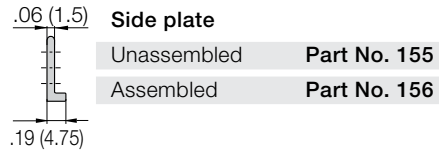
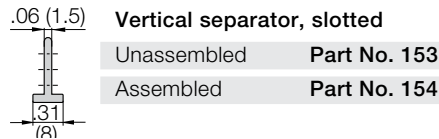
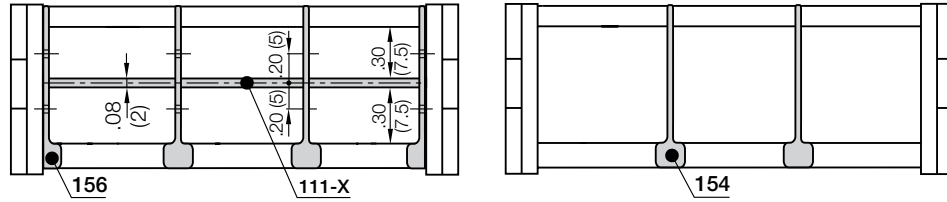

Option 2: Full-width shelf

Interior separation with continuous horizontal subdivision is practical is using a large number of thin cables with similar or identical diameters.

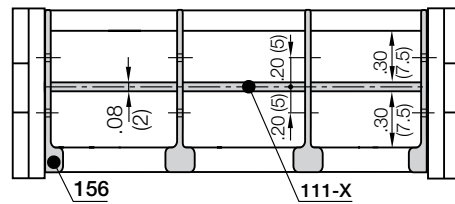

Width X in. (mm)	Part No. Unassembled	Part No. Assembled
.59 (015)	110-15	111-15
.98 (025)	110-25	111-25
1.50 (038)	110-38	111-38
1.97 (050)	110-50	111-50
2.48 (063)	110-63	111-63
3.15 (080)	110-80	111-80
3.94 (100)	110-100	111-100

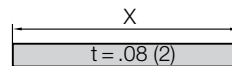

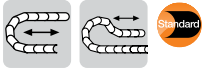

Option 1: pivoting

- Well suited for space-restricted conditions
- Strain relief with detachable tiwrap plates
- Can be mounted on either the fixed or moving end of the chain
- Variable traverse angle for flexible assembly

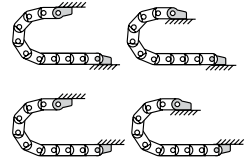
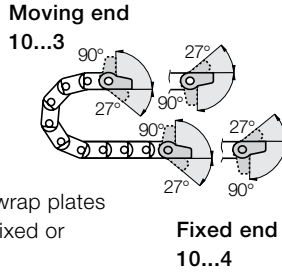

Possible installation configurations -

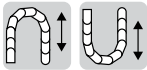

Option 2: locking

- Extreme accelerations
- If space is limited for height
- Can be mounted on either the fixed or moving end of the chain

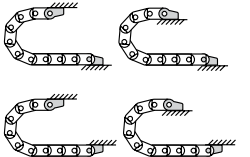
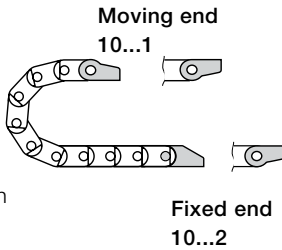

Possible installation configurations -

For e-chain
15-015 to 15-050

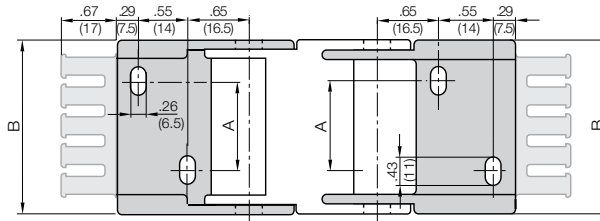

For e-chain
15-5 to 15-7

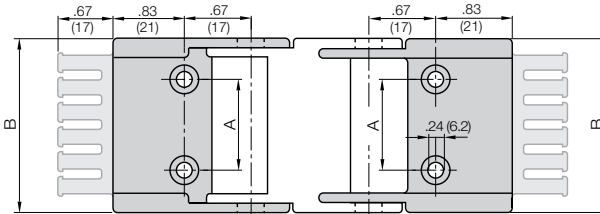

Part Number Structure

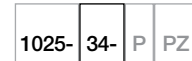

- With tiwrap plate
- Without tiwrap plate
- Complete Set
12 = Locking
34 = Pivoting
- Mounting brackets for selected chain type

Part number examples are shown for pivoting brackets. For locking brackets fill in the blank with **12**

Part No. Full Set (pivoting)
with Tiwrap Plate
Series 15 with 25mm inner width
1025-34PZ

Part No. Full Set (pivoting)
without Tiwrap Plate
Series 15 with 25 mm inner width
1025-34P

Full set, for both ends:
1025-34-PZ Full set, each part with pin/bore + tiwrap plate
Single-part order:
1025-3-PZ Mounting bracket with bore + tiwrap plate
1025-4-PZ Mounting bracket with pin + tiwrap plate

For Chain Type	Part No. Full set with Tiwrap Plate	Part No. Full Set without Tiwrap Plate	Dimension A in. (mm)	Dimensions B in. (mm)	Number of Teeth
15-015	1015- <input type="checkbox"/> PZ	1015- <input type="checkbox"/> P	—	1.00 (25.5)	2
15-025	1025- <input type="checkbox"/> PZ	1025- <input type="checkbox"/> P	.39 (10)	1.40 (35.5)	3
15-038	1038- <input type="checkbox"/> PZ	1038- <input type="checkbox"/> P	.91 (23)	1.91 (48.5)	4
15-050	1050- <input type="checkbox"/> PZ	1050- <input type="checkbox"/> P	1.38 (35)	2.38 (60.5)	5
15-5	105- <input type="checkbox"/> PZ	105- <input type="checkbox"/> P	1.89 (48)	2.95 (75.0)	6
15-6	106- <input type="checkbox"/> PZ	106- <input type="checkbox"/> P	2.56 (65)	3.62 (92.0)	8
15-7	107- <input type="checkbox"/> PZ	107- <input type="checkbox"/> P	3.35 (85)	4.41 (112.0)	10

34 or 12

For pivoting brackets choose 34
For locking brackets choose 12
Example: 1025- 34 PZ

e-chain system® Zipper

Series 15

Guide Trough

One-piece guide troughs made of steel are available for the Series 15 Zipper e-chains®. These guide troughs are available from stock for outer chain widths up to 4.45 in. (113 mm). For wider e-chains® and tubes, special solutions are possible with short lead times. No installation sets are required for these trough sizes since the guide troughs consist of a one-piece U-profile. The joint connection with this type of guide trough is specified individually for every application.

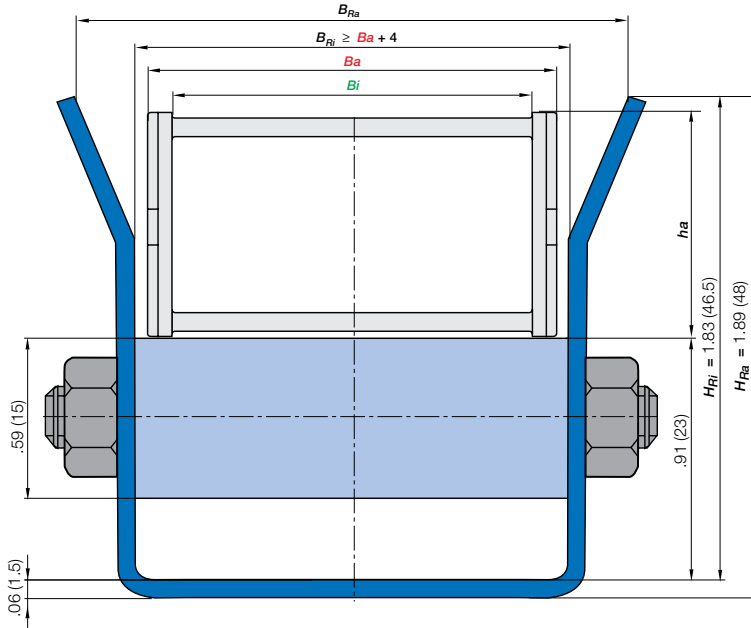

Dimensions Guide troughs 91-10 – 91-71

For Series	Part No.	BRa		BRi		Weight	
		in.	(mm)	in.	(mm)	lbs/ft	(kg/m)
15-015							
Trough without glide bar 6.56 ft. (2m section)	91-10	1.59	(40.5)	1.18	(30)	1.01	(1.50)
Glide bar 6.56 ft. (2m section)	91-11	1.59	(40.5)	1.18	(30)	.30	(.45)
15-025							
Trough without glide bar 6.56 ft. (2m section)	91-20	1.99	(50.5)	1.57	(40)	1.11	(1.65)
Glide bar 6.56 ft. (2m section)	91-21	1.99	(50.5)	1.57	(40)	.38	(.57)
15-038							
Trough without glide bar 6.56 ft. (2m section)	91-30	2.46	(62.5)	2.05	(52)	1.21	(1.80)
Glide bar 6.56 ft. (2m section)	91-31	2.46	(62.5)	2.05	(52)	.46	(.68)
15-050							
Trough without glide bar 6.56 ft. (2m section)	91-40	2.85	(72.5)	2.44	(62)	1.28	(1.90)
Glide bar 6.56 ft. (2m section)	91-41	2.85	(72.5)	2.44	(62)	.61	(.91)
15-5							
Trough without glide bar 6.56 ft. (2m section)	91-50	3.60	(91.5)	3.19	(81)	1.52	(2.26)
Glide bar 6.56 ft. (2m section)	91-51	3.60	(91.5)	3.19	(81)	.84	(1.25)
15-6							
Trough without glide bar 6.56 ft. (2m section)	91-60	4.27	(108.5)	3.86	(98)	1.83	(2.72)
Glide bar 6.56 ft. (2m section)	91-61	4.27	(108.5)	3.86	(98)	.91	(1.35)
15-7							
Trough without glide bar 6.56 ft. (2m section)	91-70	5.06	(128.5)	4.65	(118)	2.13	(3.17)
Glide bar 6.56 ft. (2m section)	91-71	5.06	(128.5)	4.65	(118)	1.14	(1.70)

Trough material in general: St 1203 galvanized

PDF: igus.com/e-chain-pdfs
 Product information: igus.com/e-chains

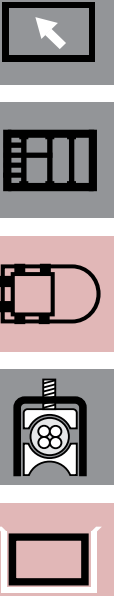

Price Index

Series R15

Special Features / Options

Upon request: Cleanroom Class 1 (ISO class 3) tested by the Dryden Engineering Company, CA

ESD classification: Electrically conductive ESD/ATEX version upon request

UL94-V2 classifications upon request

Low-noise

Assembly Tips

"Zipper-fast" opening and closing

Usage Guidelines



- If extremely quick, zipper-like access to cables is required
- If chip protection is required
- If quick, easy insertion of cables with preassembled connectors is required
- If aesthetic design is required



- If opening of the link is not necessary
 - **Series 10 E2 mini**
- If the chain must snap-open along the inner radius
 - **Series B15i E2 mini**

Features & Benefits

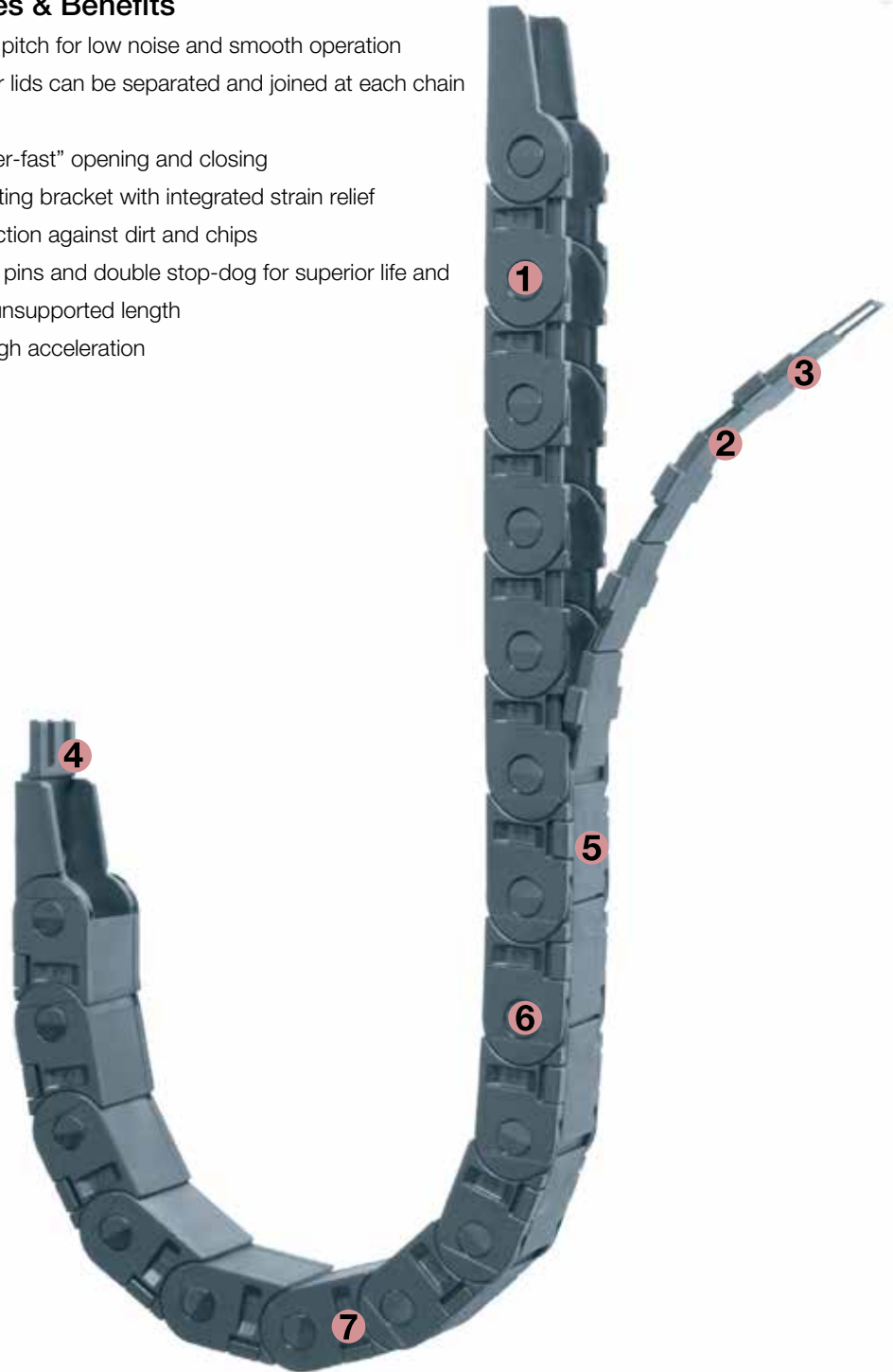
- 1 Small pitch for low noise and smooth operation
- 2 Zipper lids can be separated and joined at each chain link
- 3 "Zipper-fast" opening and closing
- 4 Mounting bracket with integrated strain relief
- 5 Protection against dirt and chips
- 6 Large pins and double stop-dog for superior life and long unsupported length
- 7 For high acceleration

Order Example: Complete e-chain®

Please indicate chain length or number of links. Example:

3.28 ft (1 m) **R15-025-063-0**

e-chain®

With 2 separators **R154** assembled every 2nd link

Interior Separation

1 Set **1025-12PZ**

Mounting Bracket

e-chain system® E2 tubes

Series R15

Installation Dimensions

Short travel, unsupported length

- FL_B = unsupported with permitted sag
 - FL_G = unsupported with straight upper run
- Further information ► Design, Chapter 1

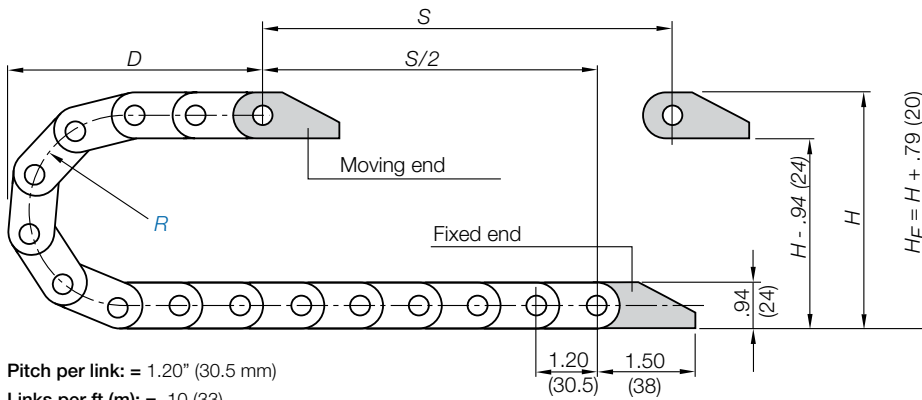
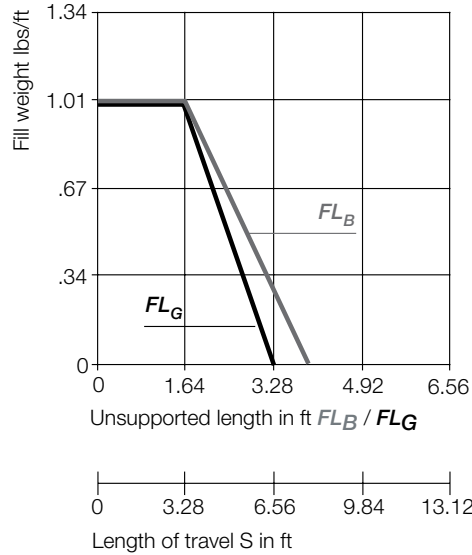
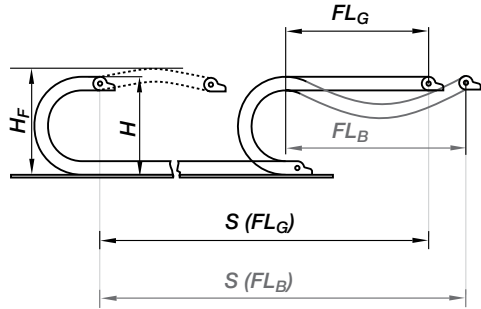

Pitch per link = 1.20" (30.5 mm)
 Links per ft (m) = 10 (33)
 For center mount applications:
 Chain length = $S/2 + K$

The required clearance height: $H_F = H + .79$ in. (20 mm) (with .67 lbs/ft (1.0 kg/m) fill weight).
 Please consult igus® if space is particularly restricted.

R	2.48 (063)	2.95 (075)	3.94 (100)	4.33 (110)	4.92 (125)	5.71 (145)	7.09 (180)
H	5.91 (150)	6.89 (175)	8.86 (225)	9.65 (245)	10.83 (275)	12.40 (315)	15.16 (385)
D	4.72 (120)	5.71 (145)	6.10 (155)	6.69 (170)	7.48 (190)	8.86 (225)	10.98 (279)
K	10.24 (260)	11.81 (300)	14.96 (380)	16.14 (410)	17.91 (455)	20.47 (520)	24.80 (630)



R15

Short Travels - Unsupported



Unsupported e-chains® feature positive camber over short travels. This must be accounted for when specifying the clearance height. Please refer to **Installation dimensions** for further details.

Legend

- S = Length of travel
- R = Bending radius
- H = Nominal clearance height
- D = Overlength e-chain® radius in final position
- $K = \pi \cdot R + \text{safety buffer}$
- H_F = Required clearance height

PDF: igus.com/e-chain-pdfs
 Product information: igus.com/e-chains



Speed / acceleration FL_G	max. 6.56 ft/s (20 m/s) / max. 656 ft/s ² (200 m/s ²)
Speed / acceleration FL_B	max. 9.84 ft/s (3 m/s) / max. 19.69 ft/s ² (6 m/s ²)
Gliding speed / acceleration (maximum)	max. 32.8 ft/s (10 m/s) / max. 32.8 ft/s ² (10 m/s ²)
Material - permitted temperature	igumid G / -40°F (-40°C) up to +248°F (+120° C)
Flammability Class, igumid G	VDE 0304 IIC UL94 HB

Technical Data



Details of material properties

► Chapter 1

Series R15 - e-tube snap-open along the outer radius

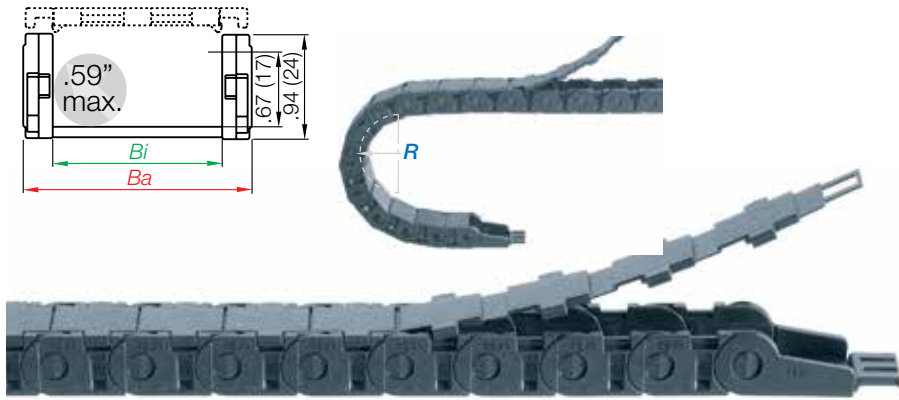

Part Number Structure

R15-025-063-0

- Color - Black
- Bending radius
- Width
- Series

Telephone 1-800-521-2747

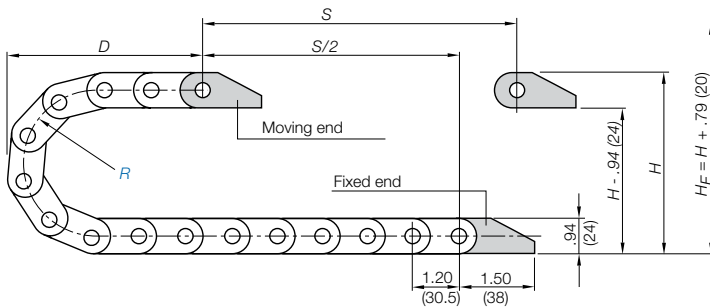

Pitch per link: = 1.20" (30.5 mm)
Links per ft (m): = 10 (33)
For center mount applications:
Chain length = $\frac{S}{2} + K$

Supplement part number with required radius. Example: R15-025-063-0
Pitch: 1.20 in. (30.5 mm) per link links/ft (m) = 10 (33)

Part Number	Bi in. (mm)	Ba in. (mm)	Weight lbs/ft (kg/m)
R15-025- [] -0	.98 (25)	1.42 (36)	≈ 0.269 (0.40)
R15-038- [] -0	1.50 (38)	1.93 (49)	≈ 0.309 (0.46)
R15-063- [] -0	2.48 (63)	2.99 (76)	≈ 0.423 (0.63)
R15-080- [] -0	3.15 (80)	3.70 (94)	≈ 0.470 (0.70)

Choose from the radii below for all of the above sizes

Radius (mm) Example: R15-025-063-0

	063	075	100	110	125	145	180
R	2.48 (063)	2.95 (075)	3.94 (100)	4.33 (110)	4.92 (125)	5.71 (145)	7.09 (180)
H	5.91 (150)	6.89 (175)	8.86 (225)	9.65 (245)	10.83 (275)	12.40 (315)	15.16 (385)
D	4.72 (120)	5.71 (145)	6.10 (155)	6.69 (170)	7.48 (190)	8.86 (225)	10.98 (279)
K	10.24 (260)	11.81 (300)	14.96 (380)	16.14 (410)	17.91 (455)	20.47 (520)	24.80 (630)

Internet: igus.com
email: sales@igus.com
QuickSpec: igus.com/quickSpec

e-chain system® E2 tubes

Series R15

Interior Separation



R15

Option 1: Vertical separators and spacers

Vertical separators are used if a vertical subdivision of the e-chain® interior is required. By standard, vertical separators are assembled every other e-chain® link. .

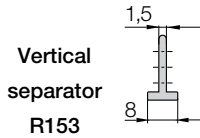
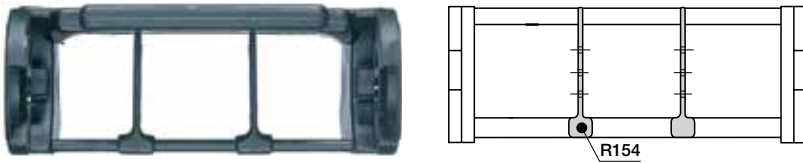

Vertical Separator

Unassembled	Part No. R153
Assembled	Part No. R154

- **Standard separator R153 for e-chains®**
This separator is used for general subdivision of e-chain®.

Option 2: Full-width shelf

It is ideal for use in applications involving many thin cables with similar or identical diameters. This shelf slides into place and spans the entire width of the chain.

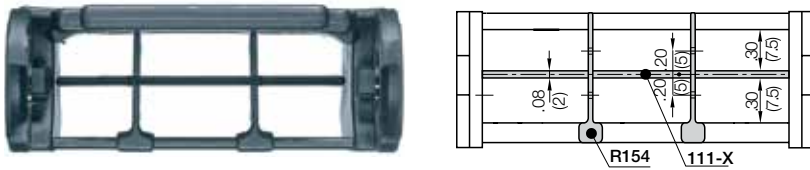

Shelves 110-XX

Shelves can be inserted at 3 different heights in .20" (5mm) increments

Width X in. (mm)	Part No.	
	Unassembled	Assembled
0.98 (25)	110-25	111-25
1.50 (38)	110-38	111-38
2.68 (63)	110-63	111-63
3.15 (80)	110-80	111-80

PDF: igus.com/e-chain-pdfs
Product information: igus.com/e-chains



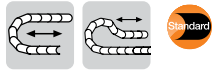

Option 1: pivoting

- Recommended for unsupported and gliding applications
- Well suited for tight installation conditions
- Available with or without strain relief tiwrap plates
- Variable traverse angle for flexible assembly

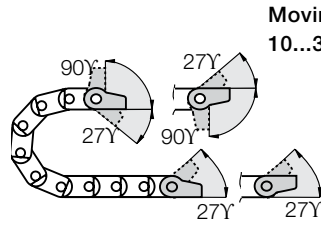

Moving end
10...3P(Z)

Fixed end
10...4

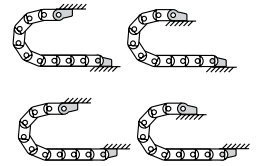

Possible installation configurations -

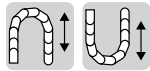

Option 2: locking

- Recommended for unsupported and gliding applications
- Extreme speed and/or accelerations
- For height restricted applications

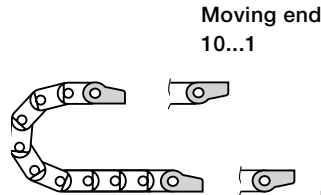

Moving end
10...1

Fixed end
10...2

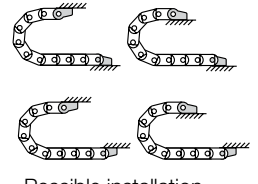

Possible installation configurations -

For e-chain
R15-015 to R15-050

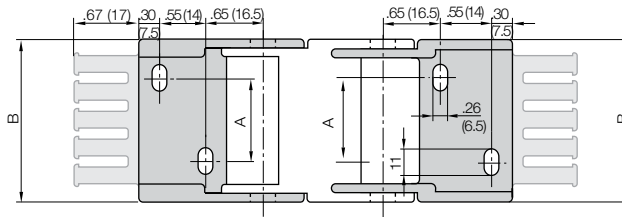

For e-chain
R15-063 to R15-100

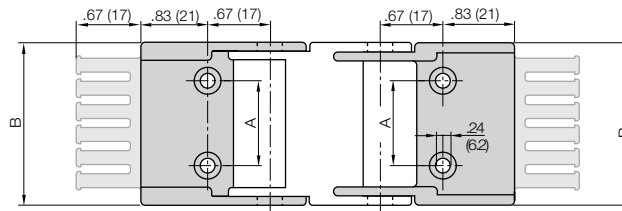

Part Number Structure

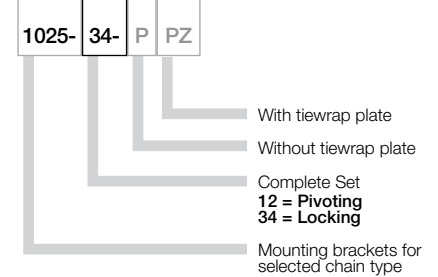

Part number examples are shown for pivoting brackets. For locking brackets fill in the blank with

Part No. Full Set (pivoting)
with Tiwrap Plate
Series R15 with 25mm inner width
1025-34PZ

Part No. Full Set (pivoting)
without Tiwrap Plate
Series R15 with 25 mm inner width
1025-34P

Full set, for both ends:
1025- - Full set, each part with pin/bore + tiwrap plate

Single-part order:
1025- - Mounting bracket with bore + tiwrap plate
1025- - Mounting bracket with pin + tiwrap plate

For Chain Type	Part No. Full set with Tiwrap Plate	Part No. Full Set without Tiwrap Plate	Dimension A in. (mm)	Dimensions B in. (mm)	Number of Teeth
R15-025	1025- <input type="text" value=""/> PZ	1025- <input type="text" value=""/> P	.39 (10)	1.40 (35.5)	3
R15-038	1038- <input type="text" value=""/> PZ	1038- <input type="text" value=""/> P	.91 (23)	1.91 (48.5)	4
R15-063	105- <input type="text" value=""/> PZ	105- <input type="text" value=""/> P	1.89 (48)	2.95 (75.0)	6
R15-080	106- <input type="text" value=""/> PZ	106- <input type="text" value=""/> P	2.56 (65)	3.62 (92.0)	8

or

For pivoting brackets choose
For locking brackets choose
Example: 1025- PZ

Price Index



Series 17

Special Features / Options



Upon request: Cleanroom Class 1
(ISO class 3) tested by the Dryden
Engineering Company, CA



Flammability Class
VDE 0304 IIC UL94 HB



Low-noise

Assembly Tips



“Zipper-fast” opening and closing

Usage Guidelines



- If fast, zipper-like accessibility to cables is required
- If interior separation is required
- If quiet operation is required



- If individual links must open as opposed to ‘zipping’ open
➤ **Series B17 E2 Mini**

Features & Benefits

- 1 Interior separation possible
- 2 Small pitch for low-noise, smooth operation
- 3 ‘Zipper-fast’ opening and closing
- 4 For high acceleration
- 5 Zipper lids can be separated and joined at each link
- 6 Mounting bracket with integrated strain relief



Order Example: Complete e-chain®

Please indicate chain length or number of links. Example:

3.28 ft (1 m) **17-2-063-0**

e-chain®

With 2 separators **172** assembled every 2nd link

Interior Separation

1 Set **117-2-12PZ**

Mounting Bracket

e-chain system® Zipper Series 17 Installation Dimensions

Short travel, unsupported length

- FL_B = unsupported with permitted sag
 - FL_G = unsupported with straight upper run
- Further information ► Design, Chapter 1

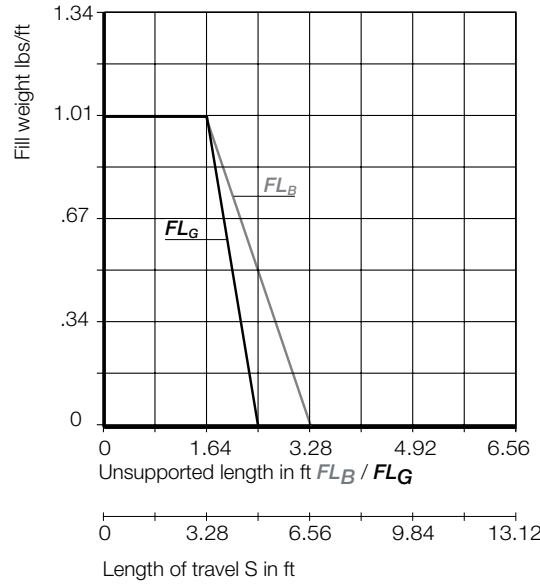
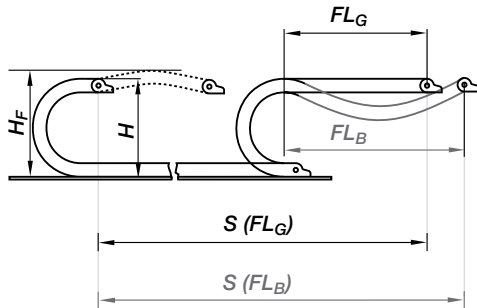

Short Travels - Unsupported



Unsupported e-chains® feature positive camber over short travels. This must be accounted for when specifying the clearance height. Please refer to **Installation dimensions** for further details.

Legend

- S = Length of travel
- R = Bending radius
- H = Nominal clearance height
- D = Overlength e-chain® radius in final position
- $K = \pi \cdot R + \text{safety buffer}$
- H_F = Required clearance height

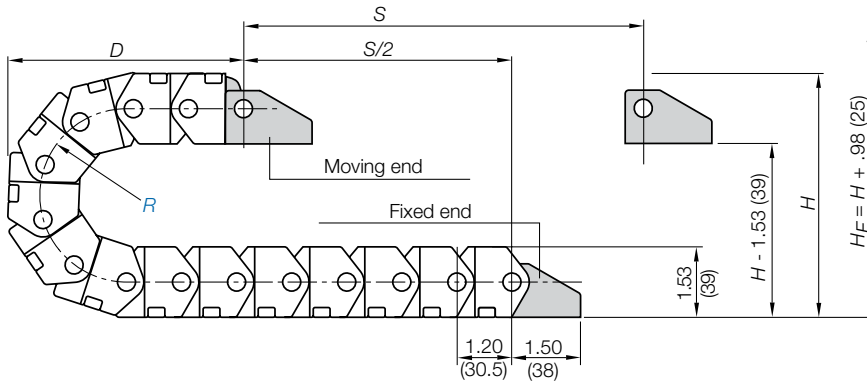

Pitch per link = 1.20" (30.5 mm)
 Links per ft (m) = 10.06 (33)
 For center mount applications:
 Chain length = $\frac{S}{2} + K$

The required clearance height: $H_F = H + .98$ in. (25 mm) (with 1.01 lbs/ft (1.5 kg/m) fill weight. Please consult igus® if space is particularly restricted.

R	2.48 (063)	2.95 (075)	3.94 (100)	4.92 (125)
H	6.50 (165)	7.44 (189)	9.41 (239)	11.38 (289)
D	5.04 (128)	5.51 (140)	6.50 (165)	7.48 (190)
K	10.24 (260)	11.81 (300)	14.96 (380)	17.91 (455)

Speed / acceleration FL_G	max. 6.56 ft/s (20 m/s) / max. 656 ft/s ² (200 m/s ²)
Speed / acceleration FL_B	max. 9.84 ft/s (3 m/s) / max. 19.69 ft/s ² (6 m/s ²)
Gliding speed / acceleration (maximum)	max. 32.8 ft/s (10 m/s) / max. 164 ft/s ² (50 m/s ²)
Material - permitted temperature	igumid G / -40°F (-40°C) up to +248°F (+120° C)
Flammability Class, igumid G	VDE 0304 IIC UL94 HB

Technical Data



Details of material properties

► Chapter 1



Series 17 - Zip-open along the outer radius - Standard

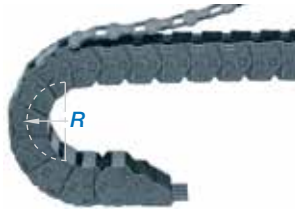
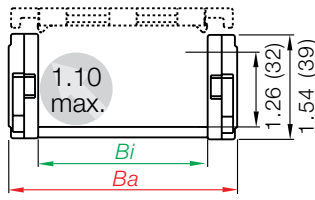

Part Number Structure

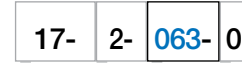

- Color - Black
- Bending radius
- Width
- Series



Telephone 1-800-521-2747

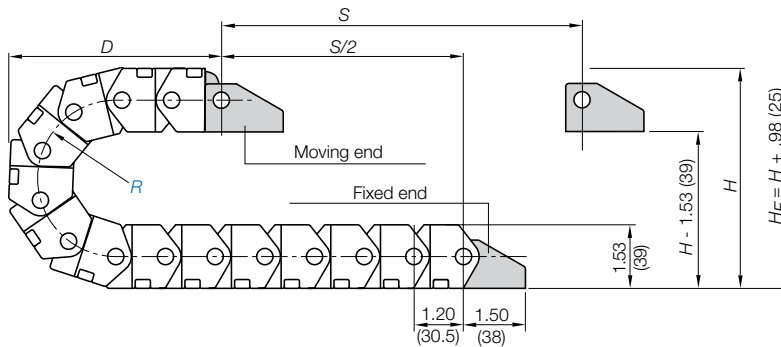

Supplement part number with required radius. Example: 17-1-**063**-0
Pitch: 1.20 in. (30.5 mm) per link links/ft (m) = 10.06 (33)

Part Number	<i>Bi</i>	<i>Ba</i>	Weight
	in. (mm)	in. (mm)	lbs/ft (kg/m)
17-1- <input type="text"/> -0	.59 (15)	1.02 (26)	≈ 0.349 (0.52)
17-2- <input type="text"/> -0	.98 (25)	1.42 (36)	≈ 0.396 (0.59)
17-3- <input type="text"/> -0	1.50 (38)	1.93 (49)	≈ 0.437 (0.65)
17-4- <input type="text"/> -0	1.97 (50)	2.40 (61)	≈ 0.470 (0.70)
17-5- <input type="text"/> -0	2.48 (63)	2.99 (76)	≈ 0.558 (0.83)
17-6- <input type="text"/> -0	3.15 (80)	3.66 (93)	≈ 0.618 (0.92)
17-7- <input type="text"/> -0	3.94 (100)	4.45 (113)	≈ 0.712 (1.06)

Choose from the radii below for all of the above sizes
Radius (mm) Example: 17-1-**063**-0

	063	075	100	125
R	2.48 (63)	2.95 (75)	3.94 (100)	4.92 (125)
H	6.50 (165)	7.44 (189)	9.41 (239)	11.38 (289)
D	5.04 (128)	5.51 (140)	6.50 (165)	7.48 (190)
K	10.24 (260)	11.81 (300)	14.96 (380)	17.91 (455)

0=Standard color black. For other colors see Chapter 1

Internet: igus.com
email: sales@igus.com
QuickSpec: igus.com/quickspec



Option 1: Vertical separators

Vertical separators are used if only a vertical subdivision of the e-chain® interior is required. A slotted separator is used for this subdivision. This separator can also be used with full-width shelves for a continuous horizontal subdivision. By standard, vertical separators are assembled every other e-chain® link.

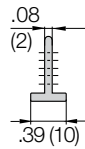
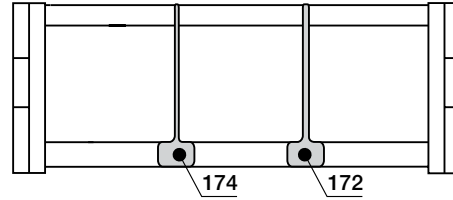
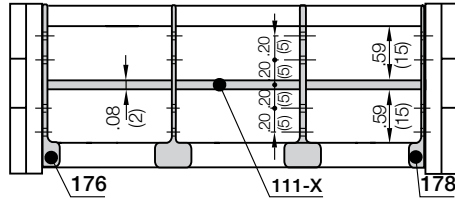

Vertical Separator for 17-1 to 17-4
 Unassembled **Part No. 171**
 Assembled **Part No. 172**

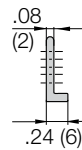

Side Plate for 17-1 to 17-4
 Unassembled **Part No. 175**
 Assembled **Part No. 176**

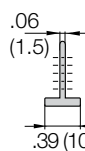

Vertical Separator for 17-5 to 17-7
 Unassembled **Part No. 173**
 Assembled **Part No. 174**

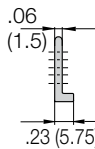

Side plate for 17-5 to 17-7
 Unassembled **Part No. 177**
 Assembled **Part No. 178**



Option 2: Full-width shelf

Interior separation with continuous horizontal subdivision is practical is using a large number of thin cables with similar or identical diameters.

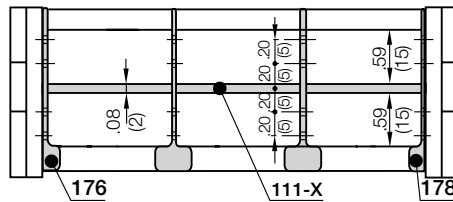

Width X in. (mm)	Part No. Unassembled	Part No. Assembled
.59 (015)	110-15	111-15
.98 (025)	110-25	111-25
1.50 (038)	110-38	111-38
1.97 (050)	110-50	111-50
2.48 (063)	110-63	111-63
3.15 (080)	110-80	111-80
3.94 (100)	110-100	111-100

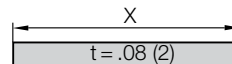

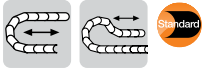

Option 1: pivoting

- One-piece mounting bracket
- Corrosion resistant
- Available pre-assembled
- Inner and outer attachment possible
- With our without strain relief tiewrap plates

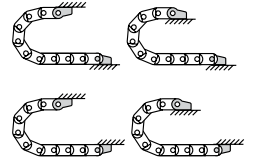
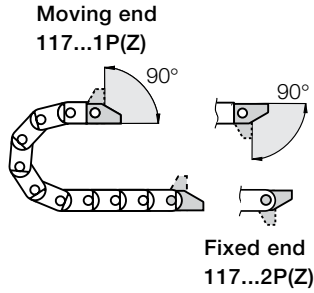

Possible installation configurations -

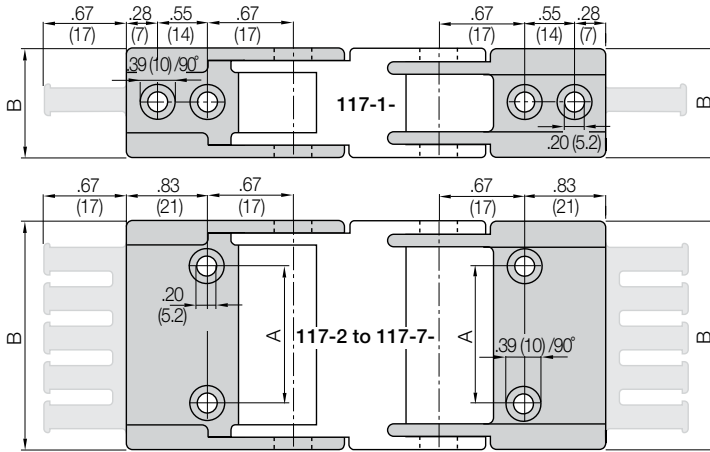

Part Number Structure

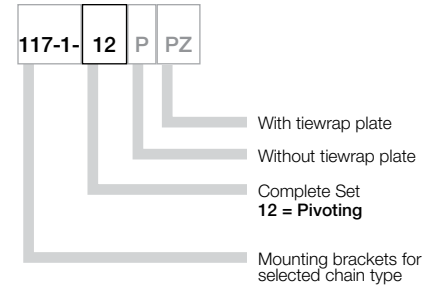

Full set, for both ends:

117-1-12-PZ Full set, each part with pin/bore + tiewrap plate

Single-part order:

117-1-1-PZ Mounting bracket with bore + tiewrap plate

117-1-2-PZ Mounting bracket with pin + tiewrap plate

For Chain Type	Part No. Full set with Tiewrap Plate	Part No. Full Set without Tiewrap Plate	Number of Teeth	Dimension A in. (mm)	Dimensions B in. (mm)
17-1	117-1-12PZ	117-1-12P	2	— —	1.00 (25.5)
17-2	117-2-12PZ	117-2-12P	3	.47 (12)	1.40 (35.5)
17-3	117-3-12PZ	117-3-12P	4	.98 (25)	1.91 (48.5)
17-4	117-4-12PZ	117-4-12P	5	1.46 (37)	2.38 (60.5)
17-5	117-5-12PZ	117-5-12P	6	1.89 (48)	2.99 (76.0)
17-6	117-6-12PZ	117-6-12P	8	2.56 (65)	3.66 (93.0)
17-7	117-7-12PZ	117-7-12P	10	3.35 (85)	4.45 (113.0)

PDF: igus.com/e-chain-pdfs
Product information: igus.com/e-chains



Price Index

Series R17

Special Features / Options

Clean-Room Upon request: Cleanroom Class 1 (ISO class 3) tested by the Dryden Engineering Company, CA

ESD ESD classification: Electrically conductive ESD/ATEX version upon request

UL UL94-V2 classifications upon request

Headphones Low-noise

Assembly Tips



“Zipper-fast” opening and closing

Usage Guidelines



- If extremely quick, zipper-like access to cables is required
- If chip protection is required
- If quick, easy insertion of cables with preassembled connectors is required
- If aesthetic design is required



- If cable installation without opening lids is possible
➤ **Series E16 E-Z Chain**

Features & Benefits

- 1 Mounting bracket with integrated strain relief
- 2 Small pitch for low-noise, smooth operation
- 3 “Zipper-fast” opening and closing
- 4 For high acceleration
- 5 Zipper lids can be separated and joined at each chain link
- 6 Smooth exterior and interior
- 7 Large pivot pins for long service life

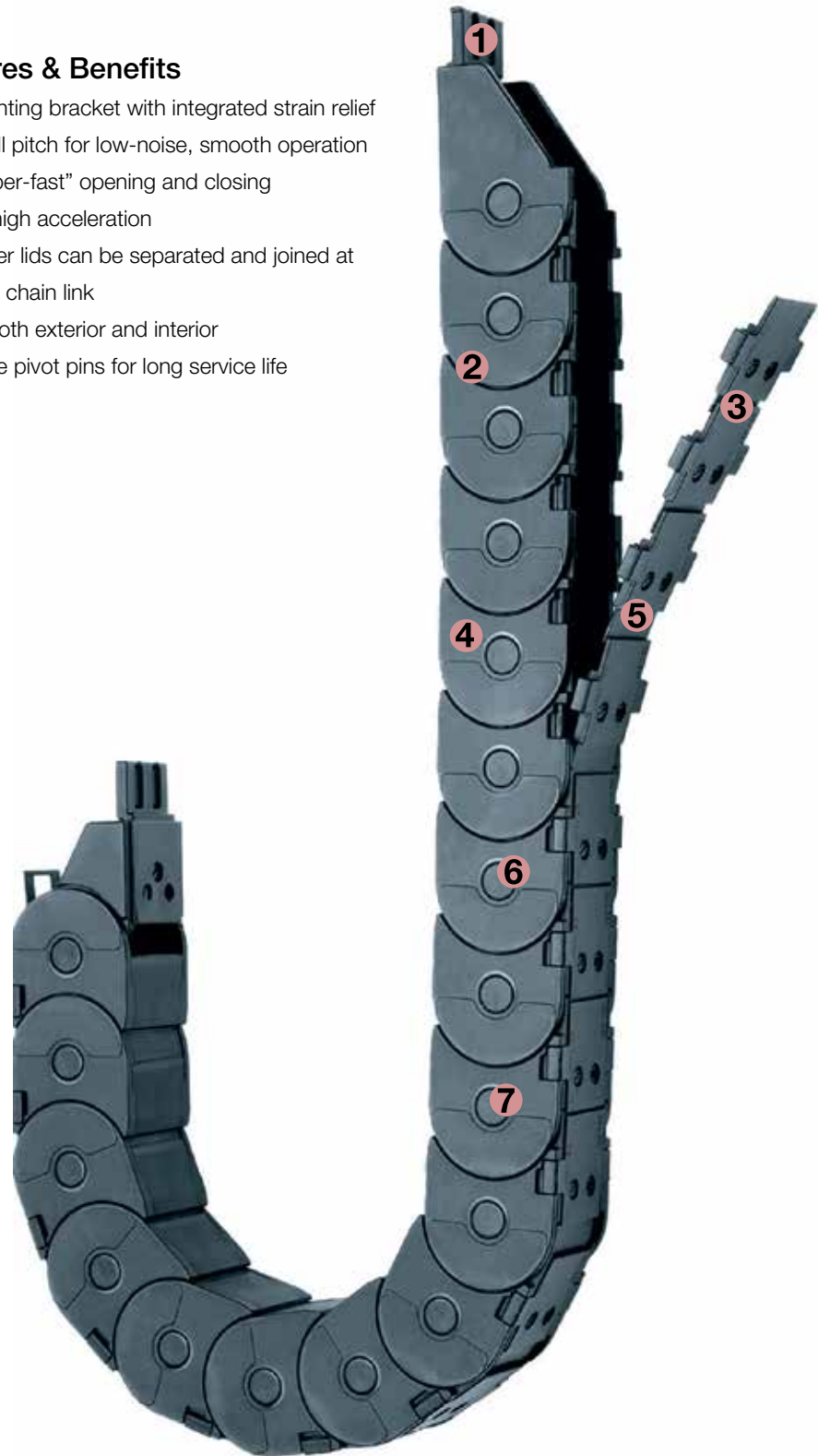

Order Example: Complete e-chain®

Please indicate chain length or number of links. Example:

3.28 ft (1 m) **R17-025-063-0**

e-chain®

With 2 separators **R172** assembled every 2nd link

Interior Separation

1 Set **117-025-12PZ**

Mounting Bracket

e-chain system® E2 tubes

Series R17

Installation Dimensions



R17

Short travel, unsupported length

- FL_B = unsupported with permitted sag
 - FL_G = unsupported with straight upper run
- Further information ► Design, Chapter 1

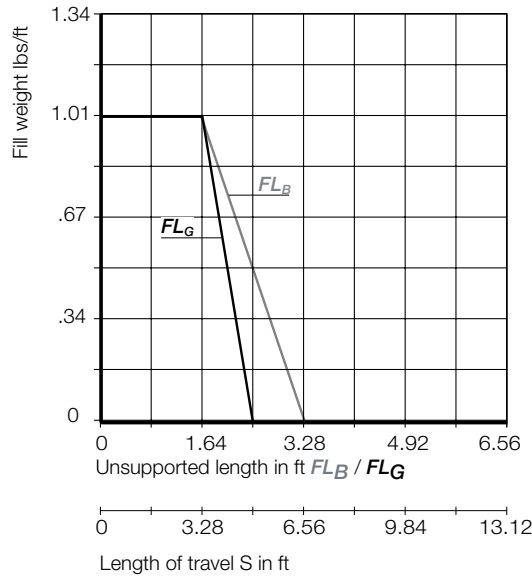
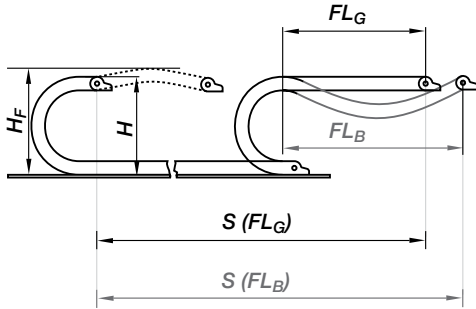

Short Travels - Unsupported



Unsupported e-chains® feature positive camber over short travels. This must be accounted for when specifying the clearance height. Please refer to **Installation dimensions** for further details.

Legend

- S = Length of travel
- R = Bending radius
- H = Nominal clearance height
- D = Overlength e-chain® radius in final position
- $K = \pi \cdot R + \text{safety buffer}$
- H_F = Required clearance height

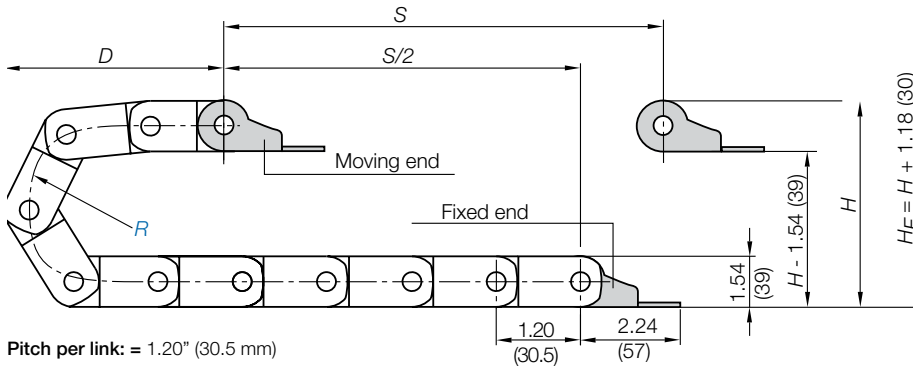

Pitch per link = 1.20" (30.5 mm)

Links per ft (m) = 10 (33)

For center mount applications:

Chain length = $S/2 + K$

The required clearance height: $H_F = H + 1.18 \text{ in. (30 mm)}$ (with .67 lbs/ft (1.0 kg/m) fill weight). Please consult igus® if space is particularly restricted.

R	2.48 (063)	2.95 (075)	3.94 (100)	4.92 (125)
H	6.50 (165)	7.44 (189)	9.41 (239)	11.38 (289)
D	4.53 (115)	5.12 (130)	6.10 (155)	7.09 (180)
K	10.83 (275)	12.01 (305)	15.55 (395)	18.70 (475)

Speed / acceleration FL_G	max. 6.56 ft/s (20 m/s) / max. 656 ft/s ² (200 m/s ²)
Speed / acceleration FL_B	max. 9.84 ft/s (3 m/s) / max. 19.69 ft/s ² (6 m/s ²)
Gliding speed / acceleration (maximum)	max. 32.81 ft/s (10 m/s) / max. 164 ft/s ² (50 m/s ²)
Material - permitted temperature	igumid G / -40°F (-40°C) up to +248°F (+120° C)
Flammability Class, igumid G	VDE 0304 IIC UL94 HB

Technical Data



Details of material properties

► Chapter 1



PDF: igus.com/e-chain-pdfs
Product information: igus.com/e-chains



Series R17 - e-tube snap-open along the outer radius

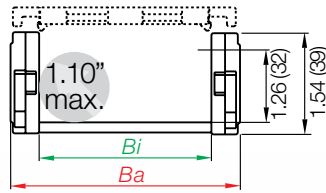
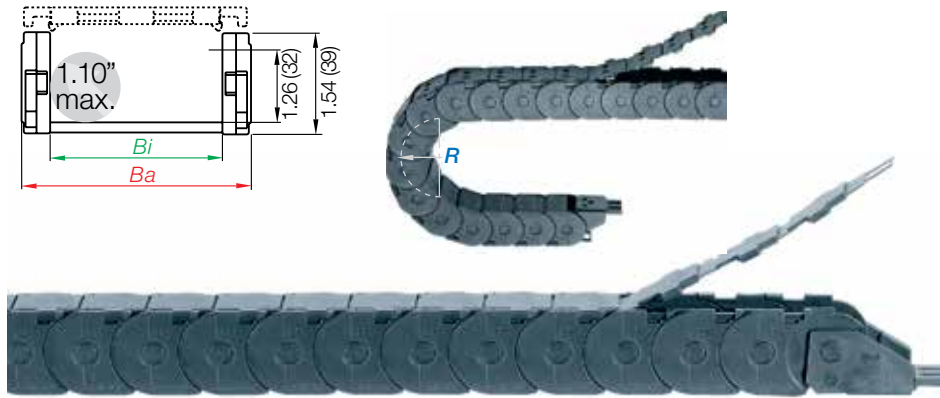

Part Number Structure

R17-025-063-0



Telephone 1-800-521-2747

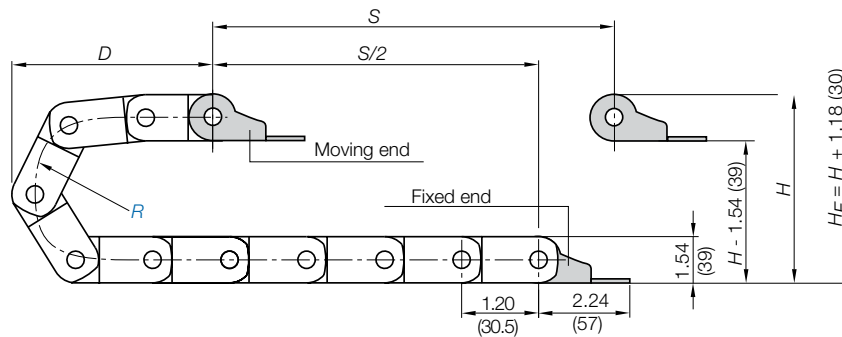

Pitch per link: = 1.20" (30.5 mm)
Links per ft (m): = 10 (33)
For center mount applications:
Chain length = $\frac{S}{2} + K$

Supplement part number with required radius. Example: R17-025-063-0
Pitch: 1.20 in. (30.5 mm) per link links/ft (m) = 10 (33)

Part Number	Bi in. (mm)	Ba in. (mm)	Weight lbs/ft (kg/m)
R17-015-□-0	.59 (15)	1.02 (26)	≈ 0.349 (0.52)
R17-025-□-0	.98 (25)	1.93 (49)	≈ 0.396 (0.59)
R17-063-□-0	2.48 (63)	2.99 (76)	≈ 0.558 (0.83)

Choose from the radii below for all of the above sizes

Radius (mm) Example: R17-025-063-0

	063	075	100	125
R	2.48 (63)	2.95 (75)	3.94 (100)	4.92 (125)
H	6.50 (165)	7.44 (189)	9.41 (239)	11.38 (289)
D	4.53 (115)	5.12 (130)	6.10 (155)	7.09 (180)
K	10.83 (275)	12.01 (305)	15.55 (395)	18.70 (475)

Internet: igus.com
email: sales@igus.com
QuickSpec: igus.com/quickspec

e-chain[®] E2 tubes Series R17 Interior Separation



R17

Option 1: Vertical separators and spacers

Vertical separators are used if a vertical subdivision of the e-chain[®] interior is required. By standard, vertical separators are assembled every other e-chain[®] link. .

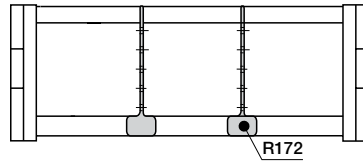

Vertical separator
R171

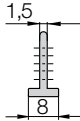

Vertical Separator

Unassembled **Part No. R171**
Assembled **Part No. R172**

- **Standard separator R171 for e-chains[®]**
This separator is used for general subdivision of e-chain[®].

Option 2: Full-width shelf

It is ideal for use in applications involving many thin cables with similar or identical diameters. This shelf slides into place and spans the entire width of the chain.

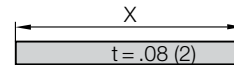
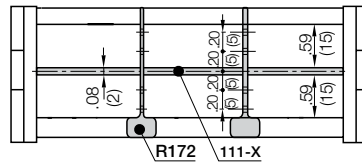

Shelves 110-XX

Shelves can be inserted at 5 different heights in .20" (5mm) increments

Width X in. (mm)	Part No.	
	Unassembled	Assembled
0.59 (15)	110-15	111-15
0.98 (25)	110-25	111-25
1.50 (38)	110-38	111-38
2.68 (63)	110-63	111-63
3.15 (80)	110-80	111-80

PDF: igus.com/e-chain-pdfs
Product information: igus.com/e-chains



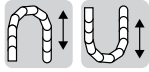

Option: locking

- One piece mounting bracket
- Corrosion resistant
- Available preassembled
- Inner and outer attachment possible
- Available with or without integrated strain relief tiwrap plates

Moving end
117...1P(Z)

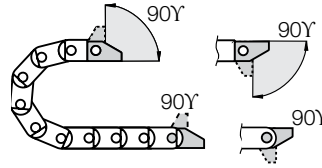

Fixed end
117...2P(Z)

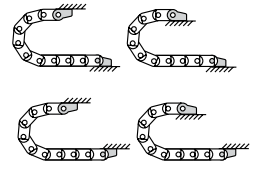

Possible installation configurations -

117...1P(Z)

Moving end

117...2P(Z)

Fixed end

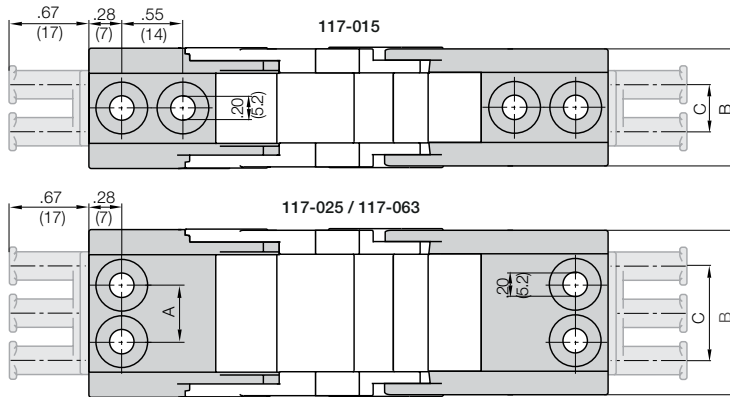

Part Number Structure

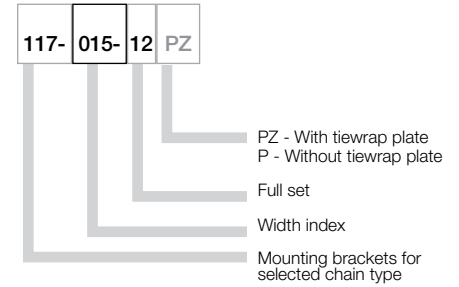

Part number examples are shown for pivoting brackets. For locking brackets fill in the blank with

Part No. Full Set (pivoting)
with Tiwrap Plate

Series R17 with 25mm inner width
117-025-12PZ

Part No. Full Set (pivoting)
without Tiwrap Plate

Series R17 with 25 mm inner width
117-025-12P

Full set, for both ends:

Full set, each part with pin/bore + tiwrap plate

Single-part order:

Mounting bracket with bore + tiwrap plate

Mounting bracket with pin + tiwrap plate

For Chain Type	Part No. Full set with Tiwrap Plate	Part No. Full Set without Tiwrap Plate	Dimension A in. (mm)	Dimension B in. (mm)	Dimension C in. (mm)	Number of Teeth
R17-015	117-015-12PZ	117-015-12P	-	1.01 (25.7)	.39 (10)	2
R17-025	117-025-12PZ	117-025-12P	.47 (12)	1.41 (35.7)	.79 (20)	3
R17-063	117-063-12PZ	117-063-12P	1.89 (48)	2.91 (73.7)	1.18 (30)	6

PDF: igus.com/e-chain-pdfs
Product information: igus.com/e-chains



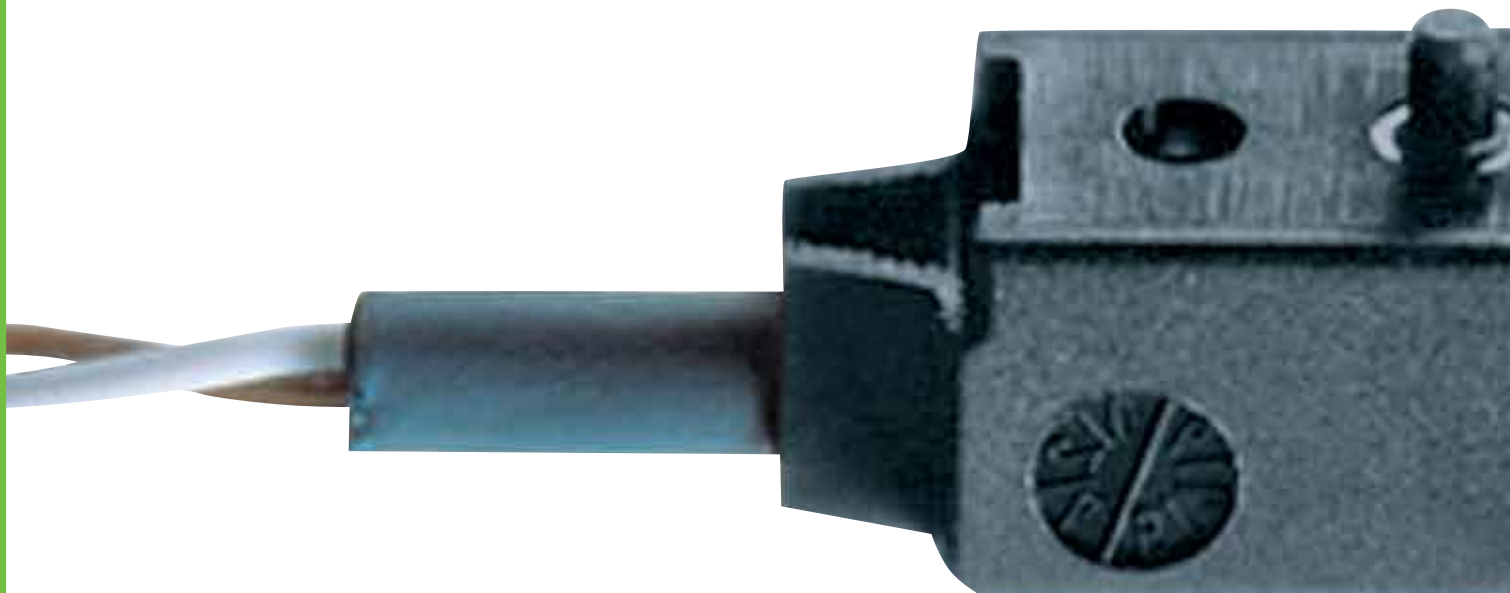
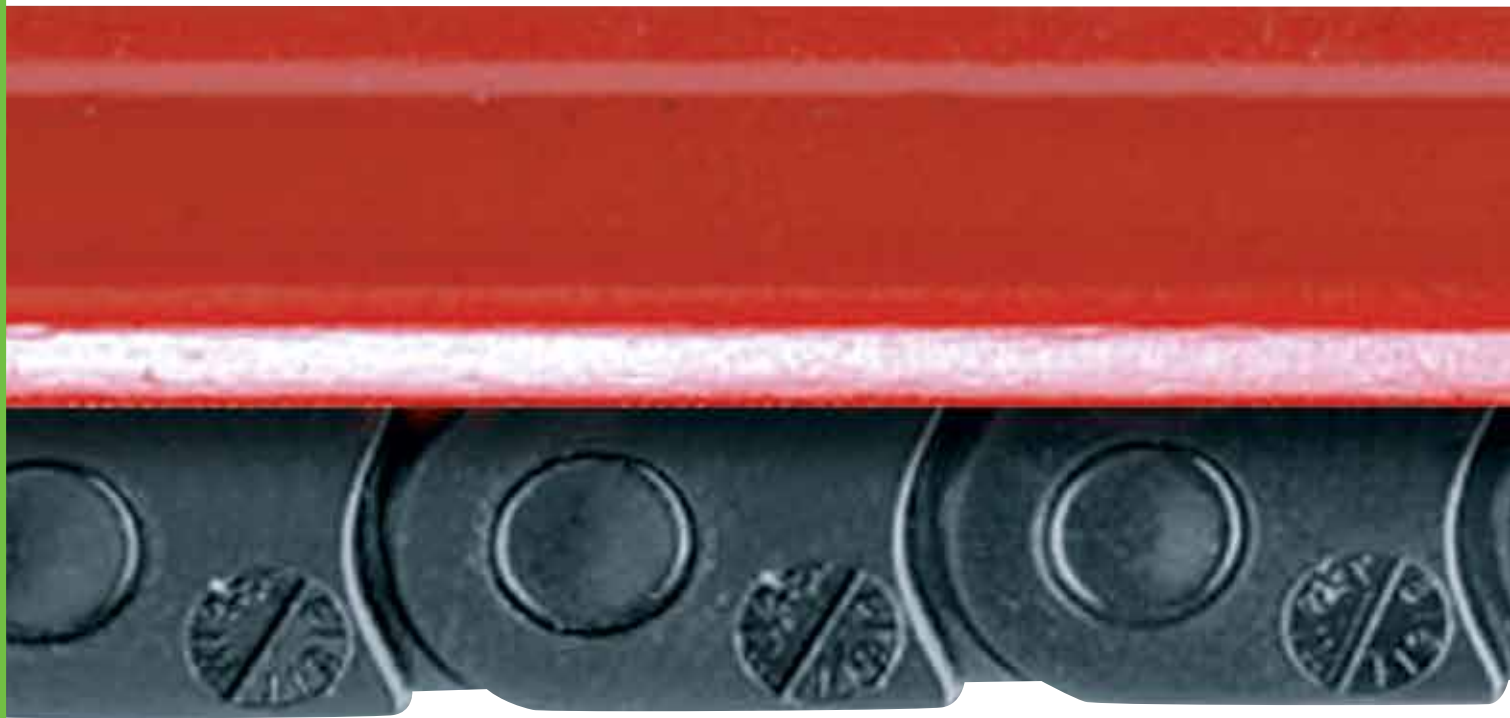

igus[®] E2 Micro

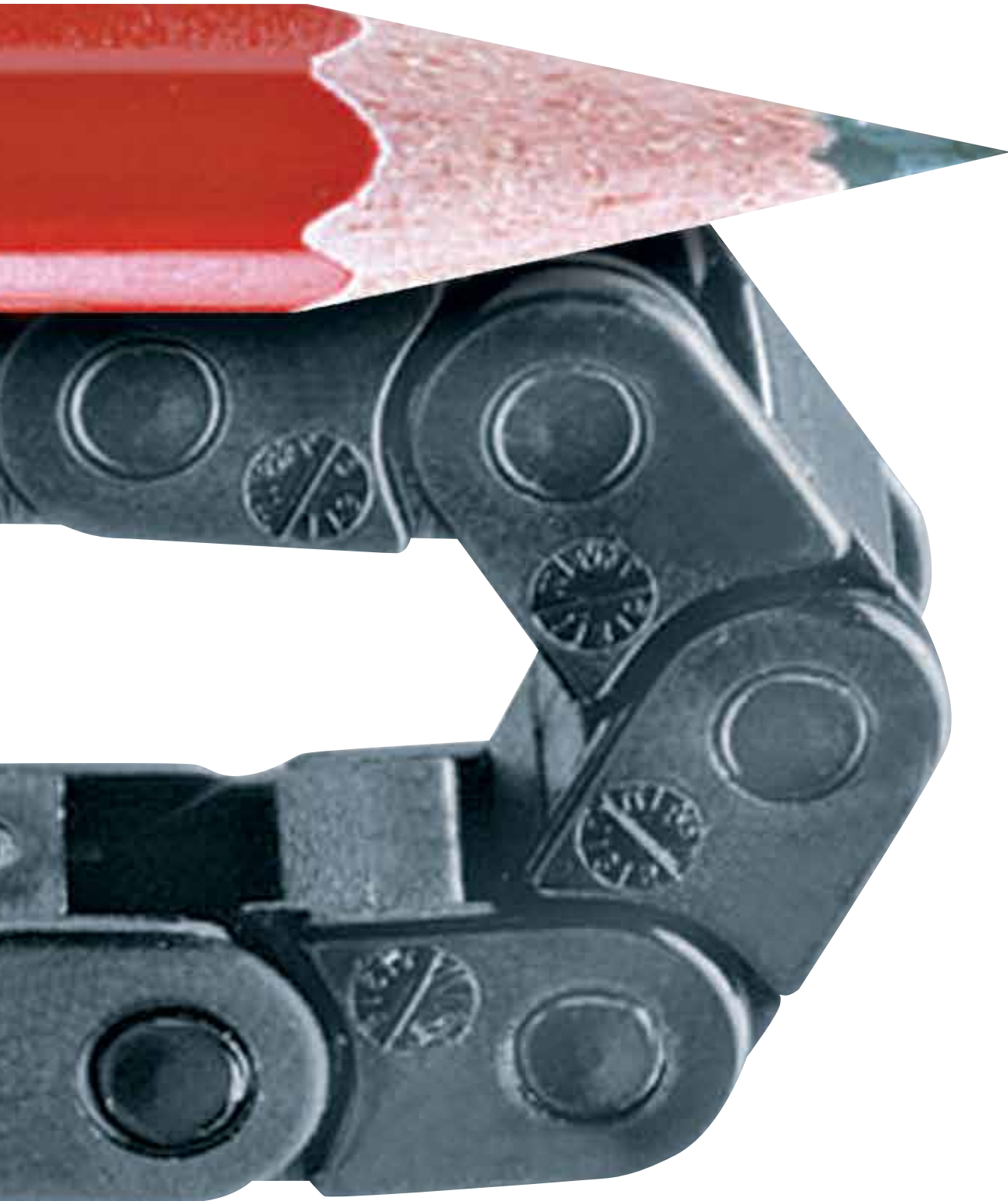

E2 Micro igus®' smallest e-chain® cable carrier

System E2 Micro—considered one of the world's smallest cable carriers—can fit into almost any application, including those with tight space restrictions and small bending radii. System E2 Micro is cost-effective and available in many styles and sizes with various accessory options.

Typical industries and applications

- Models (Micro e-chains®)
- Automatic doors
- Vehicles
- Measuring machines
- Electric equipment
- Pick and place robots
- General machinery



iF-Design Award -
for E2 Micro - Series 05



Special equipment: Electrically conductive
ESD/ATEX version upon request



IPA Qualification Certificate:
Cleanroom test upon request



UL94 - V2 class for Series 03 and
UL94 - HB class for all other Micro Series



Smallest inner heights 5 mm:
Series 03 E2 Micro





igus® E2 micro e-chains® are robust for standing applications



Sliding door in train - UL 94-V2 version



Sliding door in subway with igus®
Chainflex® CF9 cable for smallest spaces

e-chain system® E2 Micro Selection Guide

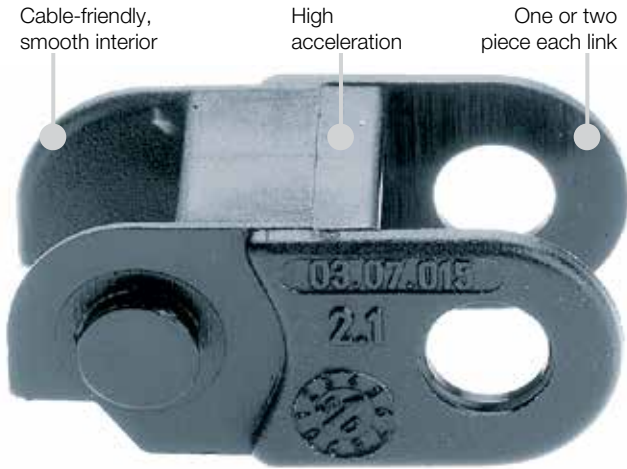

- One-piece e-chains®, from inner height of .20 (5 mm)
- High torsional rigidity
- Smallest inner heights and bending radii
- Mounting brackets with optional strain relief
- Small pitch for smooth running
- Cable-friendly, smooth interior
- Low weight
- Large pins for longer life
- Space-saving ratio of inner-to-outer dimensions
- To find more technical data about the material, chemical resistance and temperatures ► **Design, Chapter 1**

E2 Micro - one-piece e-chains® One-piece, non snap-open



Series	Inner height <i>hi</i>		Inner width <i>Bi</i>		Outer width <i>Ba</i>		Outer height <i>ha</i>		Bending radius <i>R</i>	
	in.	(mm)	in.	(mm)	in.	(mm)	in.	(mm)	in.	(mm)
03	.20	(5)	.20-.39	(5-10)	.34-.54	(8.7-13.7)	.31	(8)	.39-1.10	(10-28)
04	.28	(7)	.28-1.18	(7-30)	.47-1.38	(12-35)	.39	(10)	.59-1.89	(15-48)
05	.39	(10)	.24-2.52	(6-64)	.39-2.68	(10-68)	.47	(12)	.71-1.50	(18-38)
045	.41	(10.3)	.24-2.52	(6-64)	.47-2.76	(12-70)	.49	(12.5)	.71-1.50	(18-38)
06 ¹⁾	.41	(10.5)	.24-2.52	(6-64)	.49-2.80	(12.5-71)	.59	(15)	.71-1.50	(18-38)
E2C-10	.42	(10.6)	.24-1.97	(6-50)	.53-2.26	(13.4-57.4)	.59	(15)	.71-1.50	(18-38)
E2C-15	.59	(14.9)	.39-1.97	(10-50)	.70-2.28	(17.8-57.8)	.76	(19.3)	1.10-2.95	(28-75)
08 ²⁾	.59	(15)	.39-1.97	(10-50)	.72-2.29	(18.2-58.2)	.76	(19.3)	.98-1.89	(25-48)

E2 Micro - two-piece e-chains® Snap-open along the inner radius



Series	Inner height <i>hi</i>		Inner width <i>Bi</i>		Outer width <i>Ba</i>		Outer height <i>ha</i>		Bending radius <i>R</i>	
	in.	(mm)	in.	(mm)	in.	(mm)	in.	(mm)	in.	(mm)
E2i-10	.41	(10.3)	.63-1.57	(16-40)	.89-1.85	(22.5-47.0)	.59	(15)	.71-1.50	(18-38)
E2i-15	.56	(14.3)	.63-1.57	(16-40)	.95-1.90	(24.2-48.2)	.76	(19.3)	1.10-1.89	(28-48)

E2 Micro - two-piece e-chains® Snap-open along the outer radius



Series	Inner height <i>hi</i>		Inner width <i>Bi</i>		Outer width <i>Ba</i>		Outer height <i>ha</i>		Bending radius <i>R</i>	
	in.	(mm)	in.	(mm)	in.	(mm)	in.	(mm)	in.	(mm)
E2-10	.40	(10.1)	.24-1.97	(6-50)	.53-2.26	(13.4-57.4)	.59	(15)	.71-1.50	(18-38)
B07 ³⁾	.41	(10.3)	.63-1.57	(16-40)	.89-1.85	(22.5-47.0)	.59	(15)	.71-1.50	(18-38)
B09 ⁴⁾	.56	(14.3)	.63-1.57	(16-40)	.95-1.90	(24.2-48.2)	.76	(19.3)	1.10-1.89	(28-48)
E2-15	.57	(14.4)	.39-1.97	(10-50)	.70-2.28	(17.8-57.8)	.76	(19.3)	1.10-2.95	(28-75)

For new designs we recommend E2 micro new generation series 1) E2C-10, 2) E2C-15, 3) E2-10, 4) E2-15



Available from stock. Orders ship as early as today.*

*On average 90% of orders ship the same day..

e-chain system® E2 Micro Assembly Instructions

Assembling | E2 micro



Twist and click

Separating | E2 micro



Twist and separate

Specialty | E2 micro



igus® Micro e-chains® - for smallest bending radii with Chainflex® CF98 and CF99 - 4 x d!

Specialty | B07 and B09



B07 and B09: two-piece - Snap-open along outer radius with film-hinge

Price Index



Series 03

Special Features / Options



IPA Qualification Certificate:
Cleanroom test upon request



ESD Classification:
Electrically conductive ESD/
ATEX version upon request



Smallest inner height
.20" (5 mm)



Flammability Class
VDE 0304 IIC UL94 V2

Assembly Tips



Easy to assemble and disassemble

Usage Guidelines



- If quieter operation is required
- If cost is a factor
- If snap-open links are not necessary



- If snap-open links are required
 - Series 047 "Zipper"
- If quick insertion of cables with preassembled connector is required
 - Series E03 E-Z Chain

Features & Benefits

- 1 Mounting bracket with integrated strain relief
- 2 One-piece, non snap-open e-chain®
- 3 Very lightweight - low price
- 4 igus® smallest e-chain® - interior dimensions
.20" x .20" (5 x 5 mm)
- 5 Dirt-repellant exterior
- 6 Available as E-Z style e-chain, See Chapter 2
- 7 Patented push-button design for better stability



Order Example: Complete e-chain®

Please indicate chain length or number of links. Example:

3.28 ft (1 m) 03-05-028-0

e-chain®

1 Set 03-05-12Z

Mounting Bracket

e-chain system® E2 Micro Series 03 Installation Dimensions

Short travel, unsupported length

- FL_B = unsupported with permitted sag
 - FL_G = unsupported with straight upper run
- Further information ► Design, Chapter 1

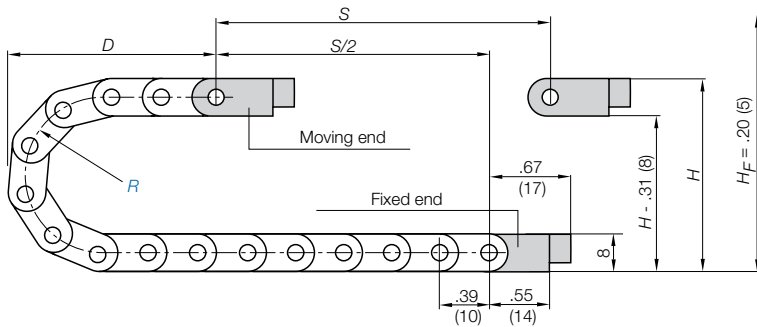
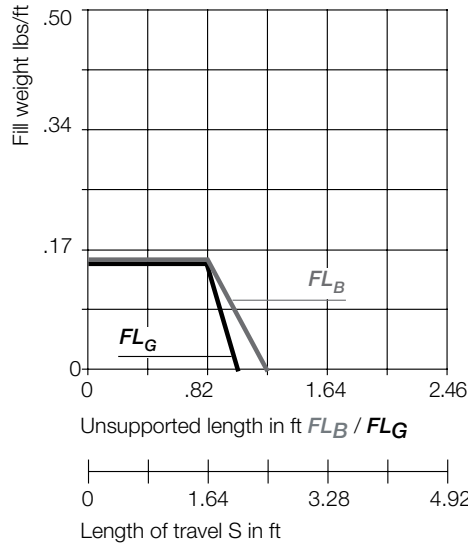
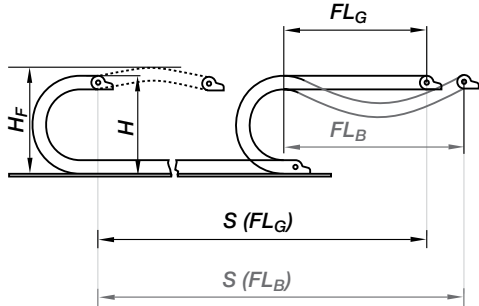

Pitch per link = .39" (10 mm)
 Links per ft (m) = 30.47 (100)
 For center mount applications:
 Chain length = $\frac{S}{2} + K$

The required clearance height: $H_F = H + .20$ in. (5 mm) (with .067 lbs/ft (0.1 kg/m) fill weight).
 Please consult igus® if space is particularly restricted.

R	.39 (010)	.47 (012)	.59 (015)	.71 (018)	1.10 (028)
H	1.10 (28)	1.26 (32)	1.50 (38)	1.73 (44)	2.52 (64)
D	1.14 (29)	1.22 (31)	1.34 (34)	1.46 (37)	1.85 (47)
K	2.17 (55)	2.36 (60)	2.76 (70)	3.15 (80)	4.33 (110)

Short Travels - Unsupported



Unsupported e-chains® feature positive camber over short travels. This must be accounted for when specifying the clearance height. Please refer to **Installation dimensions** for further details.

Legend

- S = Length of travel
- R = Bending radius
- H = Nominal clearance height
- D = Overlength e-chain® radius in final position
- $K = \pi \cdot R + \text{safety buffer}$
- H_F = Required clearance height

*If the mounting bracket location is set lower



PDF: igus.com/e-chain-pdfs
 Product information: igus.com/e-chains



Speed / acceleration FL_G	max. 65.6 ft/s (20 m/s) / max. 656 ft/s ² (200 m/s ²)
Speed / acceleration FL_B	max. 9.84 ft/s (3 m/s) / max. 19.69 ft/s ² (6 m/s ²)
Gliding speed / acceleration (maximum)	max. 9.84 ft/s (3 m/s) / max. 32.8 ft/s ² (10 m/s ²)
Material - permitted temperature	igumid NB / -40°F (-40°C) up to +176°F (+80° C)
Flammability Class, igumid NB	VDE 0304 IIC UL94 V2

Technical Data



Details of material properties

► Chapter 1

Series 03 - e-chain® non snap-open

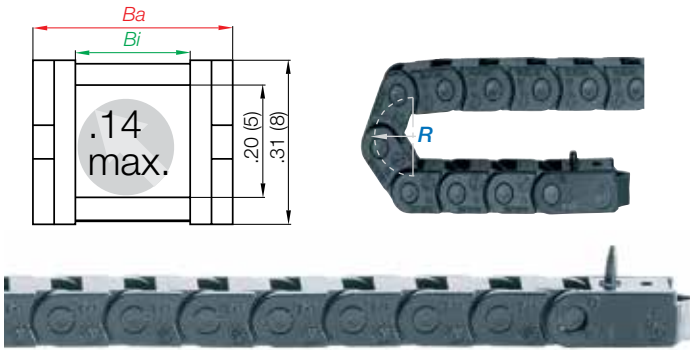

Part Number Structure

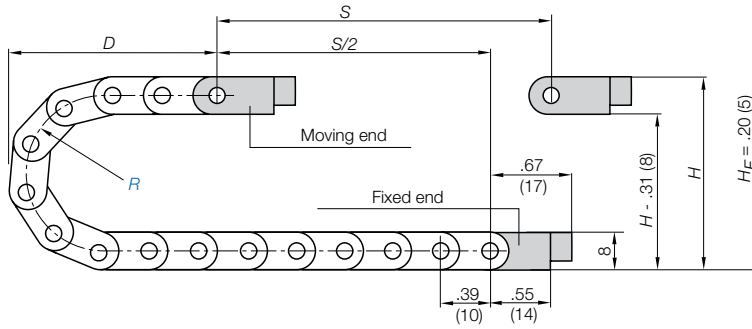
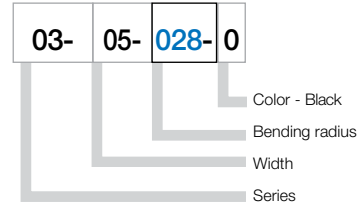

Supplement part number with required radius. Example: 03-05-**028**-0
Pitch: .39 in. (10 mm) per link links/ft (m) = 30.47 (100)

Part Number	<i>Bi</i> in. (mm)	<i>Ba</i> in. (mm)	Weight lbs/ft (kg/m)
03-05- <input type="text"/> -0	.20 (5)	.34 (8.7)	≈ 0.027 (0.04)
03-07- <input type="text"/> -0	.28 (7)	.42 (10.7)	≈ 0.034 (0.05)
03-10- <input type="text"/> -0	.39 (10)	.54 (13.7)	≈ 0.040 (0.06)

Choose from the radii below for all of the above sizes
Radius (mm) Example: 03-05-**028**-0

	010	012	015	018	028
<i>R</i>	.39 (010)	.47 (012)	.59 (015)	.71 (018)	1.10 (028)
<i>H</i>	1.10 (28)	1.26 (32)	1.50 (38)	1.73 (44)	2.52 (64)
<i>D</i>	1.14 (29)	1.22 (31)	1.34 (34)	1.46 (37)	1.85 (47)
<i>K</i>	2.17 (55)	2.36 (60)	2.76 (70)	3.15 (80)	4.33 (110)

0=Standard color black. For other colors see Chapter 1

e-chain system® E2 Micro Series 03 Mounting Brackets



Polymer, one-piece

- One-piece mounting bracket
- Corrosion resistant
- Available preassembled
- Rapid installation through adaptor plate

Moving end
03 ...1Z

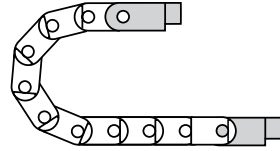

Fixed end
03...2Z



Part Number Structure

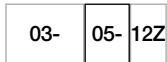

Complete Set
Width
Mounting bracket for selected chain type

Full set, for both ends:

03- 05- 12Z Full set, each part with pin/bore

Single-part order:

03- 05- 1Z Mounting bracket with bore

03- 05- 2Z Mounting bracket with pin

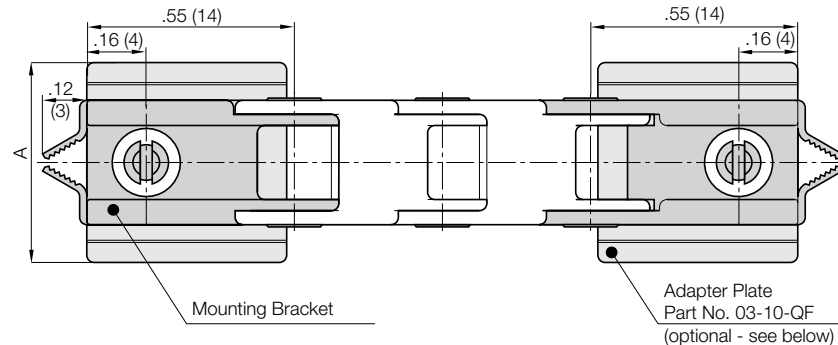

Chain Width	Part No. Full Set	Dimension A in. (mm)
-05	03-05-12Z	.34 (8.7)
-07	03-07-12Z	.42 (10.7)
-10	03-10-12Z	.54 (13.7)

Additional Accessories



03-10-QF = Adapter plate for all sizes

The adapter has broken edges, so that it can be adapted to the respective chain width. It is not absolutely necessary for attaching the mounting brackets. The mounting brackets can also be screwed on without the adapter plate.

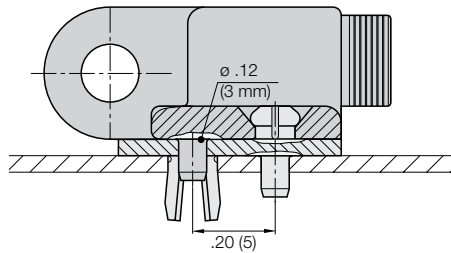

Price Index



Series 04

Special Features / Options



IPA Qualification Certificate:
Cleanroom test upon request



ESD Classification:
Electrically conductive ESD/
ATEX version upon request



Flammability Class
VDE 0304 IIC UL94 HB

Assembly Tips



Easy to assemble and disassemble

Usage Guidelines



- If quieter operation is required
- If cost is a factor
- If snap-open links are not necessary



- If snap-open links are required
 - Series 047 "Zipper"
- If quick insertion of cables with preassembled connector is required
 - Series E04 E-Z Chain

Features & Benefits

- 1 Very lightweight - low price
- 2 One-piece, non snap-open e-chain®
- 3 Small e-chain® -
interior dimensions .28" x .28" (7 x 7 mm)
- 4 Dirt-repellant exterior



Order Example: Complete e-chain®

Please indicate chain length or number of links. Example:

3.28 ft (1 m) 04-07-038-0

e-chain®

1 Set 040-07-12

Mounting Bracket

e-chain system® E2 Micro Series 04 Installation Dimensions

Short travel, unsupported length

- FL_B = unsupported with permitted sag
 - FL_G = unsupported with straight upper run
- Further information ► Design, Chapter 1

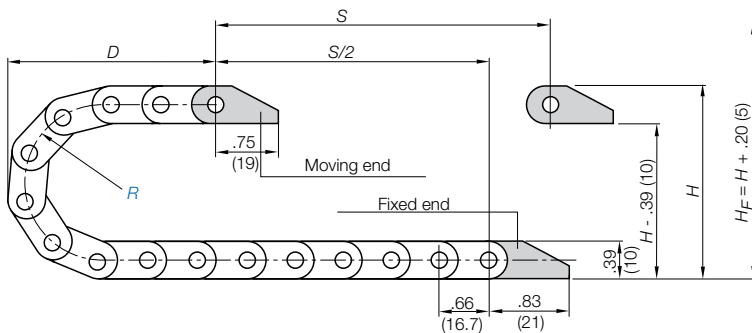
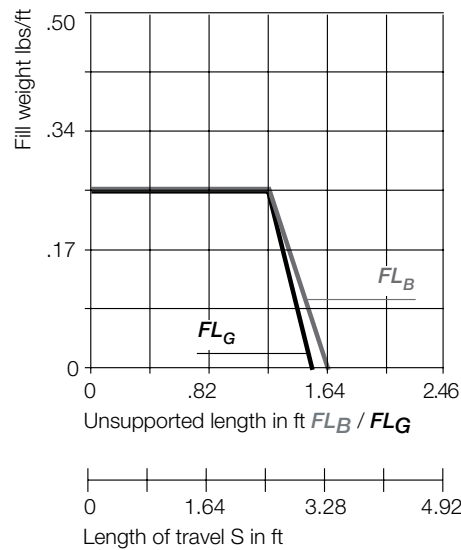
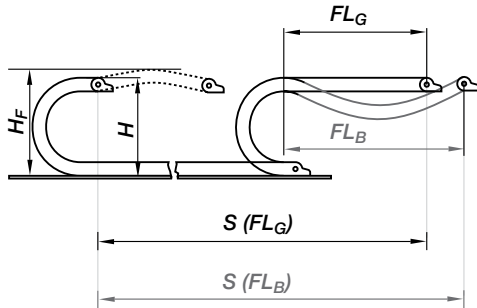

Pitch per link = .66" (16.7 mm)
 Links per ft (m) = 18.28 (60)
 For center mount applications:
 Chain length = $\frac{S}{2} + K$

The required clearance height: $H_F = H + .20 \text{ in. (5 mm)}$ (with .067 lbs/ft (0.1 kg/m) fill weight).
 Please consult igus® if space is particularly restricted.

R	.59 (015)	.71 (018)	1.10 (028)	1.50 (038)	1.89 (048)
H	1.57 (40)	1.81 (46)	2.60 (66)	3.39 (86)	4.17 (106)
D	1.77 (45)	1.89 (48)	2.28 (58)	2.68 (68)	3.07 (78)
K	3.35 (85)	3.54 (90)	4.92 (125)	6.10 (155)	7.28 (185)

Short Travels - Unsupported



Unsupported e-chains® feature positive camber over short travels. This must be accounted for when specifying the clearance height. Please refer to **Installation dimensions** for further details.

Legend

- S = Length of travel
- R = Bending radius
- H = Nominal clearance height
- D = Overlength e-chain® radius in final position
- $K = \pi \cdot R + \text{safety buffer}$
- H_F = Required clearance height



PDF: igus.com/e-chain-pdfs
 Product information: igus.com/e-chains



Speed / acceleration FL_G	max. 65.6 ft/s (20 m/s) / max. 656 ft/s ² (200 m/s ²)
Speed / acceleration FL_B	max. 9.84 ft/s (3 m/s) / max. 19.69 ft/s ² (6 m/s ²)
Gliding speed / acceleration (maximum)	max. 9.84 ft/s (3 m/s) / max. 32.8 ft/s ² (10 m/s ²)
Material - permitted temperature	igumid G / -40°F (-40°C) up to +248°F (+120°C)
Flammability Class, igumid G	VDE 0304 IIC UL94 HB

Technical Data



Details of material properties

► Chapter 1

Series 04 - e-chain® non snap-open

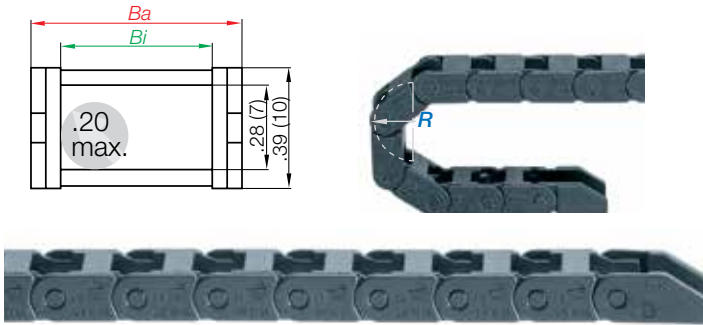

Part Number Structure

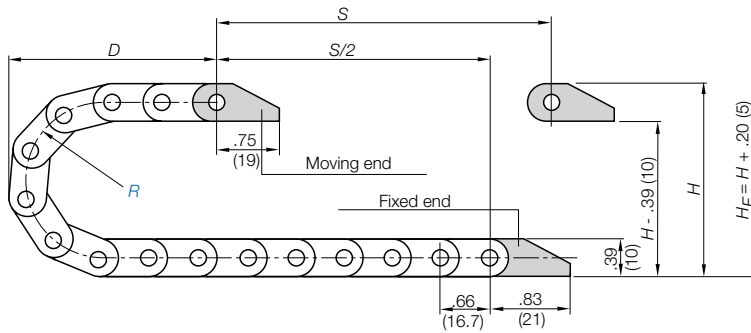
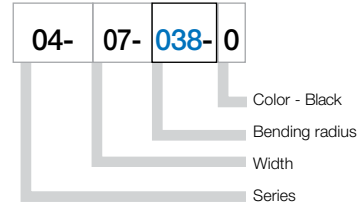

Supplement part number with required radius. Example: 04-07-**038**-0
Pitch: .66 in. (16.7 mm) per link links/ft (m) = 18.28 (60)

Part Number	<i>Bi</i> in. (mm)	<i>Ba</i> in. (mm)	Weight lbs/ft (kg/m)
04-07- <input type="text"/> -0	.28 (7)	.47 (12)	≈ 0.047 (0.07)
04-10- <input type="text"/> -0	.39 (10)	.59 (15)	≈ 0.053 (0.08)
04-16- <input type="text"/> -0	.63 (16)	.83 (21)	≈ 0.060 (0.09)
04-20- <input type="text"/> -0	.79 (20)	.98 (25)	≈ 0.067 (0.10)
04-30- <input type="text"/> -0	1.18 (30)	1.38 (35)	≈ 0.073 (0.11)

Choose from the radii below for all of the above sizes

Radius (mm) Example: 04-07-**038**-0

	015	018	028	038	048
R	.59 (015)	.71 (018)	1.10 (028)	1.50 (038)	1.89 (048)
H	1.57 (40)	1.81 (46)	2.60 (66)	3.39 (86)	4.17 (106)
D	1.77 (45)	1.89 (48)	2.28 (58)	2.68 (68)	3.07 (78)
K	3.35 (85)	3.54 (90)	4.92 (125)	6.10 (155)	7.28 (185)

0=Standard color black. For other colors see Chapter 1

e-chain system® E2 Micro Series 04 Mounting Brackets



Polymer, one-piece

- One-piece mounting bracket
- Corrosion resistant
- Available preassembled
- Inner and outer attachment possible

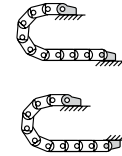
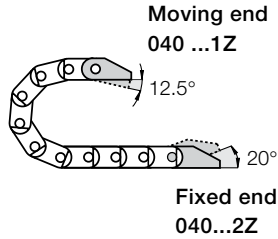

Possible installation configurations -

Part Number Structure

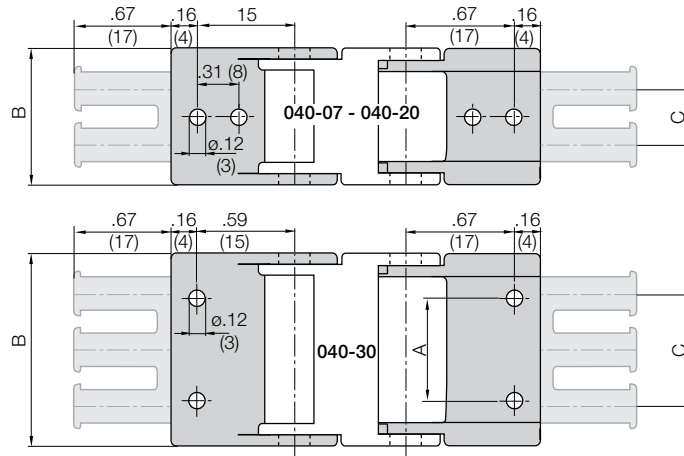
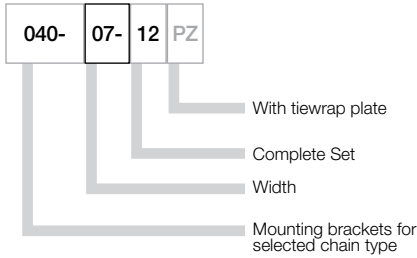

Full set, for both ends:

040-07-12-PZ Full set, each part with pin/bore

Single-part order:

040-07-1-PZ Mounting bracket with bore

040-07-2-PZ Mounting bracket with pin

Chain Type	Part No.	Part No.	Dimension A		Dimensions B		Dimension C		Number of Teeth
	Full set without Tiewrap Plate	Full set with Tiewrap plate	in.	(mm)	in.	(mm)	in.	(mm)	
04-07	040-07-12	040-07-12PZ	—	—	.47	(12)	—	—	1
04-10	040-10-12	040-07-12PZ	—	—	.59	(15)	—	—	1
04-16	040-16-12	040-07-12PZ	—	—	.83	(21)	.39	(10)	2
04-20	040-20-12	040-07-12PZ	—	—	.98	(25)	.39	(10)	2
04-30	040-30-12	040-07-12PZ	.87	(22)	1.38	(35)	.79	(20)	3

Additional accessories



Quicksnap - the complete, detachable mounting unit, upon request
Only available for the 040-07 e-chain - **Part No. 040-07-QS**



Price Index



Series 05

Special Features / Options



IPA Qualification Certificate:
Cleanroom test upon request



ESD Classification:
Electrically conductive ESD/
ATEX version upon request



Flammability Class
VDE 0304 IIC UL94 V2



iF-Design Award - for E2 micro
- Series 05

Assembly Tips



Easy to assemble and disassemble

Usage Guidelines



- If lightweight construction is required
- If minimal height and width dimensions are required
- If cost is a factor



- If snap-open links are necessary
 - Series 07 "Zipper"
- If quick insertion of cables with preassembled connectors is required
 - Series E06 E-Z Chain
- If extra rigidity is required
 - Series 06 E2 Micro

Features & Benefits

- 1 Very lightweight - ideal for low inertia applications
- 2 iF-Design Award
- 3 One-piece, non snap-open e-chain®



Order Example: Complete e-chain®

Please indicate chain length or number of links. Example:

3.28 ft (1 m) 05-20-038-0

e-chain®

1 Set 050-20-12

Mounting Bracket

e-chain system® E2 Micro Series 05 Installation Dimensions

Short travel, unsupported length

- FL_B = unsupported with permitted sag
 - FL_G = unsupported with straight upper run
- Further information ► Design, Chapter 1

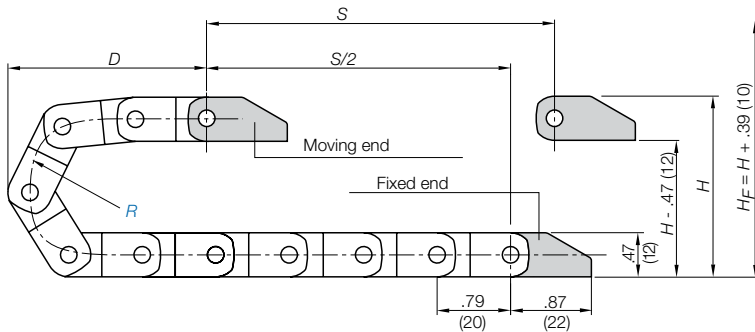
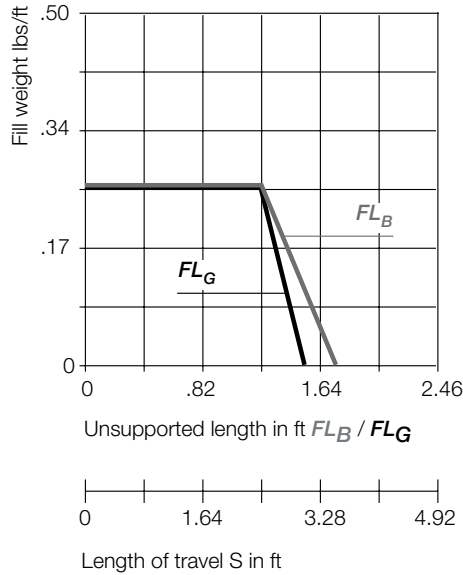
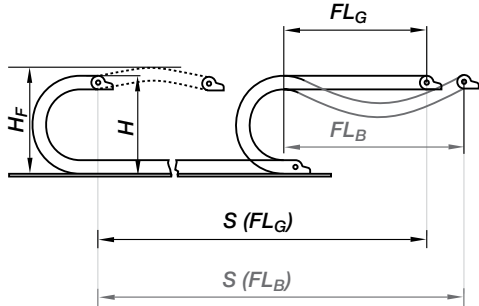

Pitch per link = .79" (20 mm)
 Links per ft (m) = 15.24 (50)
 For center mount applications:
 Chain length = $\frac{S}{2} + K$

The required clearance height: $H_F = H + .39$ in. (10 mm) (with .13 lbs/ft (0.2 kg/m) fill weight). Please consult igus® if space is particularly restricted.

R	.71 (018)	1.10 (028)	1.50 (038)
H	1.89 (48)	2.68 (68)	3.46 (88)
D	2.13 (54)	2.52 (64)	2.91 (74)
K	3.94 (100)	5.12 (130)	6.30 (160)

Short Travels - Unsupported



Unsupported e-chains® feature positive camber over short travels. This must be accounted for when specifying the clearance height. Please refer to **Installation dimensions** for further details.

Legend

- S = Length of travel
- R = Bending radius
- H = Nominal clearance height
- D = Overlength e-chain® radius in final position
- $K = \pi \cdot R + \text{safety buffer}$
- H_F = Required clearance height

*If the mounting bracket location is set lower



Speed / acceleration FL_G	max. 65.6 ft/s (20 m/s) / max. 656 ft/s ² (200 m/s ²)
Speed / acceleration FL_B	max. 9.84 ft/s (3 m/s) / max. 19.69 ft/s ² (6 m/s ²)
Gliding speed / acceleration (maximum)	max. 9.84 ft/s (3 m/s) / max. 32.8 ft/s ² (10 m/s ²)
Material - permitted temperature	igumid G / -40°F (-40°C) up to +248°F (+120°C)
Flammability Class, igumid G	VDE 0304 IIC UL94 HB

Technical Data



Details of material properties

► Chapter 1

Series 05 - e-chain® non snap-open

igus®
e-chain system®

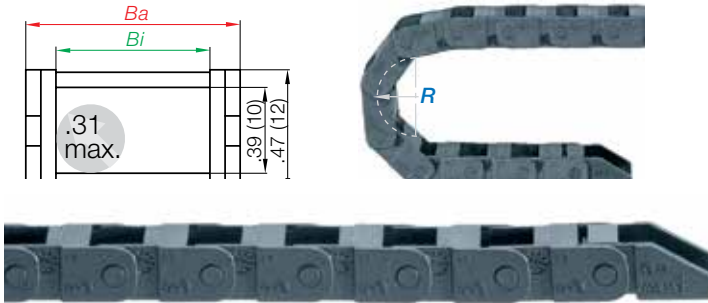

Part Number Structure



- Color - Black
- Bending radius
- Width
- Series

Telephone 1-800-521-2747

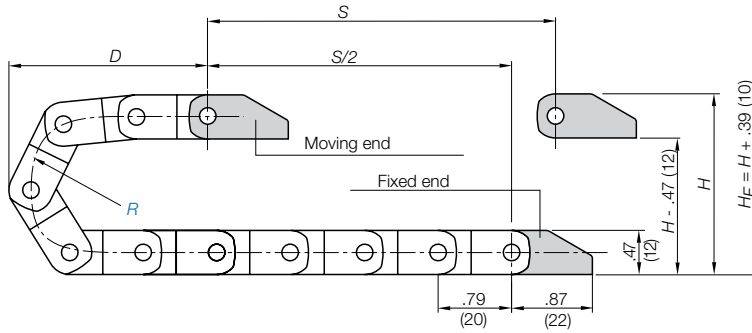

Supplement part number with required radius. Example: 05-20-**038**-0
Pitch: .79 in. (20 mm) per link links/ft (m) = 15.24 (50)

Part Number	<i>Bi</i> in. (mm)	<i>Ba</i> in. (mm)	Weight lbs/ft (kg/m)
05-06- (05-1) <input type="checkbox"/> -0	.28 (6)	.39 (10)	≈ 0.040 (0.06)
05-10- (05-2) <input type="checkbox"/> -0	.39 (10)	.55 (14)	≈ 0.047 (0.07)
05-16- (05-3) <input type="checkbox"/> -0	.63 (16)	.79 (20)	≈ 0.047 (0.07)
05-20- (05-4) <input type="checkbox"/> -0	.79 (20)	.94 (24)	≈ 0.054 (0.08)
05-30- (05-5) <input type="checkbox"/> -0	1.18 (30)	1.34 (34)	≈ 0.060 (0.09)
05-64- <input type="checkbox"/> -0	2.52 (64)	2.68 (68)	≈ 0.128 (0.19)

Choose from the radii below for all of the above sizes

Radius (mm) Example: 05-20-**038**-0

	018	028	038
<i>R</i>	.71 (018)	1.10 (028)	1.50 (038)
<i>H</i>	1.89 (48)	2.68 (68)	3.46 (88)
<i>D</i>	2.13 (54)	2.52 (64)	2.91 (74)
<i>K</i>	3.94 (100)	5.12 (130)	6.30 (160)

0=Standard color black. For other colors see Chapter 1

Internet: igus.com
email: sales@igus.com
QuickSpec: igus.com/quickspec

e-chain system® E2 Micro Series 05 Mounting Brackets



Polymer, one-piece

- One-piece mounting bracket
- Corrosion resistant
- Available preassembled
- Inner and outer attachment possible

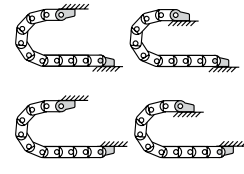
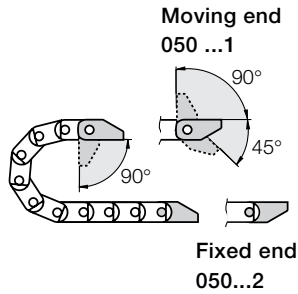

Possible installation configurations -

Part Number Structure

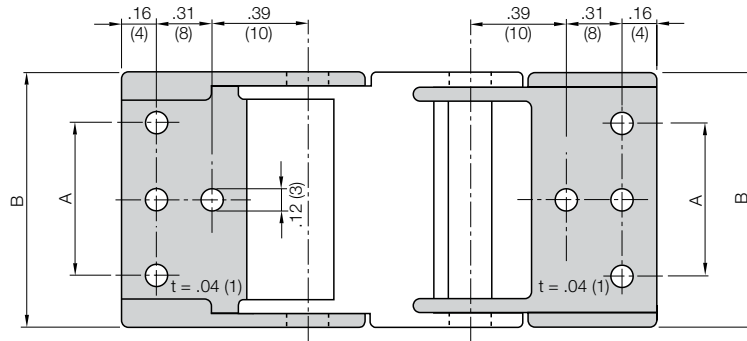
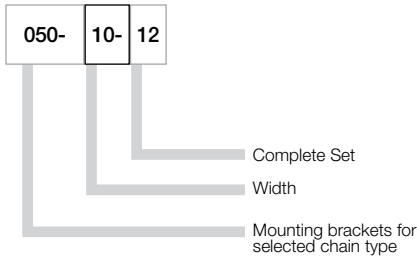

Full set, for both ends:

050- [10-] [12] Full set, each part with pin/bore

Single-part order:

050- [10-] [1] Mounting bracket with bore

050- [10-] [2] Mounting bracket with pin

Chain Type	Part No.	Dimension A		Dimensions B	
		in.	(mm)	in.	(mm)
05-06 (05-1)	050-06-12	—	—	.42	(10.7)
05-10 (05-2)	050-10-12	—	—	.58	(14.7)
05-16 (05-3)	050-16-12	—	—	.81	(20.7)
05-20 (05-4)	050-20-12	—	—	.97	(24.7)
05-30 (05-5)	050-30-12	.87	(22)	1.57	(34.7)
05-64	050-64-12	2.20	(56)	2.70	(68.7)



Price Index

Series 045
Special Features / Options

IPA Qualification Certificate:
Cleanroom test upon request

ESD Classification:
Electrically conductive ESD/
ATEX version upon request

Flammability Class
VDE 0304 IIC UL94 HB

Assembly Tips

Easy to assemble and disassemble

Features & Benefits

- 1 Small pitch for very quiet operation
- 2 Very lightweight - ideal for low inertia applications
- 3 Dirt-repellant exterior
- 4 One-piece, non snap-open e-chain®

 Series 046 with full-width shelving
available for the following:

046-16-018

046-16-028

046-16-038

Width Bi: .63" (16 mm)

Radii R: (018), (028), (038)

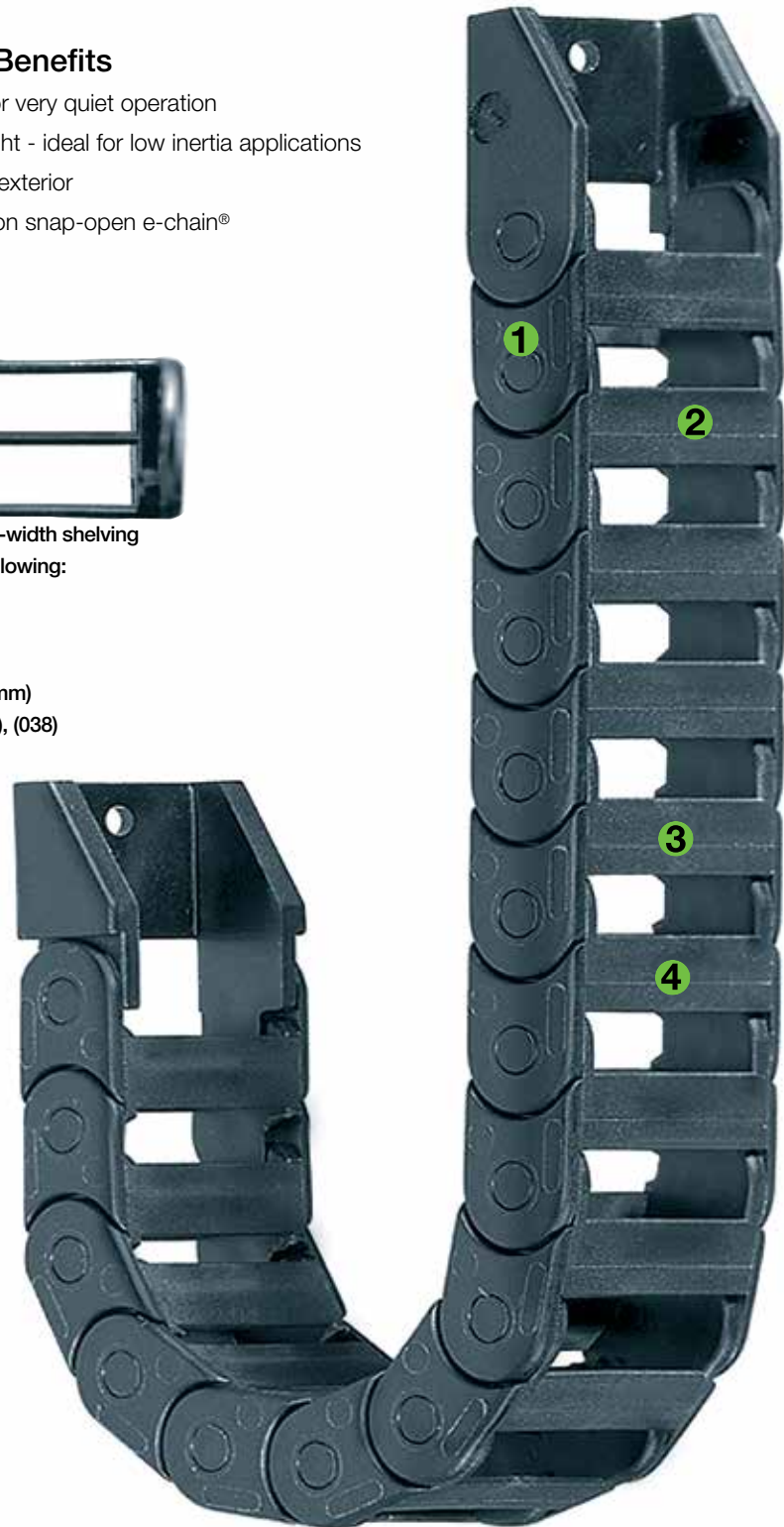
Usage Guidelines

- If very quiet operation is required
- Aesthetic design
- If excellent service life is required
- If cost is a factor
- If small bending radii are required



- If snap-open links are required
 - **Series 047 "Zipper"**
- If quick insertion of cables with preassembled connector is required
 - **Series E06 E-Z Chain**
- If extra rigidity is required
 - **Series 06 E2 Micro**

Order Example: Complete e-chain®

Please indicate chain length or number of links. Example:

 3.28 ft (1 m) **045-20-038-0**

 1 Set **0450-20-12**

e-chain system® E2 Micro Series 045 Installation Dimensions

Short travel, unsupported length

- FL_B = unsupported with permitted sag
 - FL_G = unsupported with straight upper run
- Further information ► Design, Chapter 1

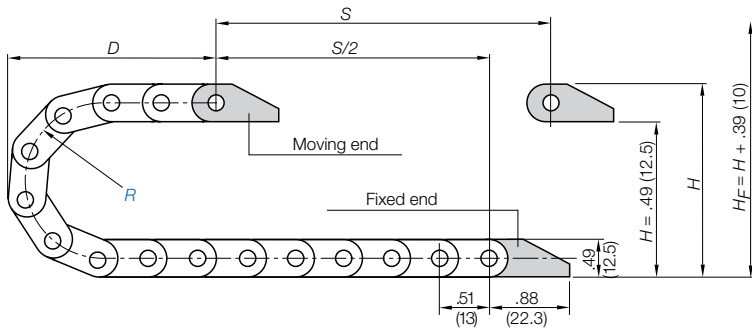
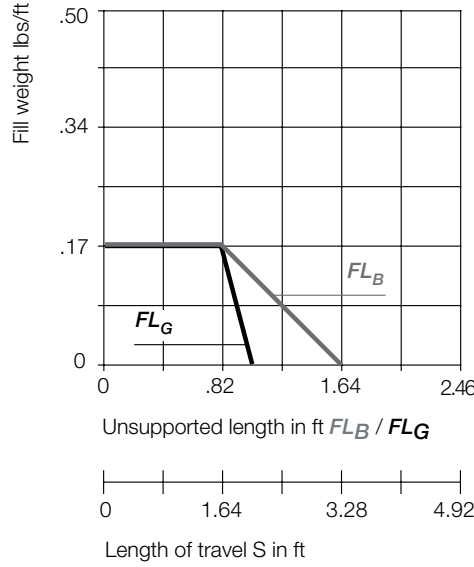
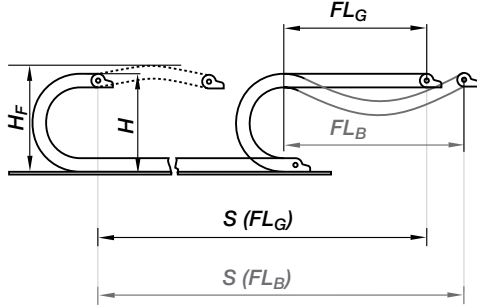

Pitch per link = .51" (13 mm)
 Links per ft (m) = 23.47 (77)
 For center mount applications:
 Chain length = $\frac{S}{2} + K$

The required clearance height: $H_f = H + .39$ in. (10 mm) (with .13 lbs/ft (0.2 kg/m) fill weight). Please consult igus® if space is particularly restricted.

R	.71 (018)	1.10 (028)	1.50 (038)
H	1.91 (48.5)	2.70 (68.5)	3.48 (88.5)
D	1.73 (44)	2.13 (54)	2.52 (64)
K	3.35 (85)	4.53 (115)	5.91 (150)

Short Travels - Unsupported



Unsupported e-chains® feature positive camber over short travels. This must be accounted for when specifying the clearance height. Please refer to **Installation dimensions** for further details.

Legend

- S = Length of travel
- R = Bending radius
- H = Nominal clearance height
- D = Overlength e-chain® radius in final position
- $K = \pi \cdot R + \text{safety buffer}$
- H_f = Required clearance height

*If the mounting bracket location is set lower



PDF: igus.com/e-chain-pdfs
 Product information: igus.com/e-chains



Speed / acceleration FL_G	max. 65.6 ft/s (20 m/s) / max. 656 ft/s ² (200 m/s ²)
Speed / acceleration FL_B	max. 9.84 ft/s (3 m/s) / max. 19.69 ft/s ² (6 m/s ²)
Gliding speed / acceleration (maximum)	max. 9.84 ft/s (3 m/s) / max. 32.8 ft/s ² (10 m/s ²)
Material - permitted temperature	igumid G / -40°F (-40°C) up to +248°F (+120°C)
Flammability Class, igumid G	VDE 0304 IIC UL94 HB

Technical Data



Details of material properties

► Chapter 1

Series 045 - e-chain® non snap-open

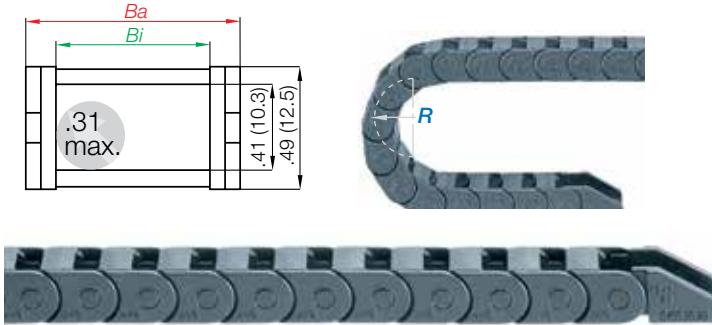

Part Number Structure

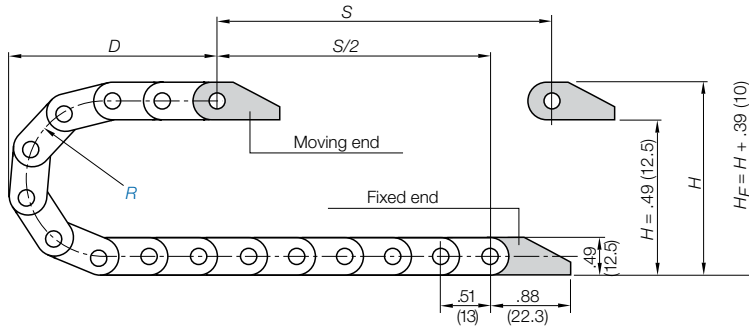
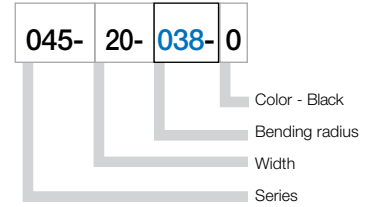

Supplement part number with required radius. Example: 045-20-**038**-0
Pitch: .51 in. (13 mm) per link links/ft (m) = 23.47 (77)

Part Number	<i>Bi</i> in. (mm)	<i>Ba</i> in. (mm)	Weight lbs/ft (kg/m)
045-06- [] -0	.24 (6)	.47 (12)	≈ 0.060 (0.09)
045-10- [] -0	.39 (10)	.63 (16)	≈ 0.067 (0.10)
045-16- [] -0	.63 (16)	.87 (22)	≈ 0.074 (0.11)
045-20- [] -0	.79 (20)	1.02 (26)	≈ 0.087 (0.13)
045-30- [] -0	1.18 (30)	1.42 (36)	≈ 0.108 (0.16)
045-64- [] -0	2.52 (64)	2.76 (70)	≈ 0.128 (0.19)

Choose from the radii below for all of the above sizes

Radius (mm) Example: 045-20-**038**-0

	018	028	038
<i>R</i>	.71 (018)	1.10 (028)	1.50 (038)
<i>H</i>	1.91 (48.5)	2.70 (68.5)	3.48 (88.5)
<i>D</i>	1.73 (44)	2.13 (54)	2.52 (64)
<i>K</i>	3.35 (85)	4.53 (115)	5.91 (150)

0=Standard color black. For other colors see Chapter 1

e-chain system® E2 Micro Series 045 Mounting Brackets



Polymer, one-piece

- One-piece mounting bracket
- Corrosion resistant
- Available preassembled
- Inner and outer attachment possible

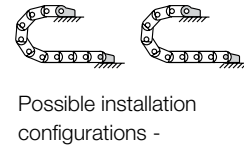
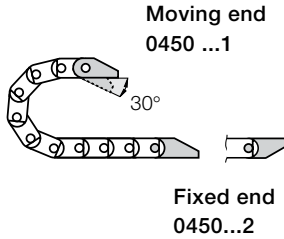

Part Number Structure

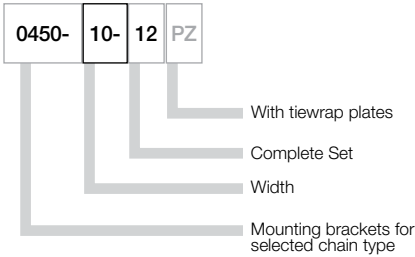

Full set, for both ends:

0450-10-12-PZ

Full set, each part with pin/bore + tie-strap plate

Single-part order:

0450-10-1-PZ

Mounting bracket with bore + tie-strap plate

0450-10-2-PZ

Mounting bracket with pin + tie-strap plate

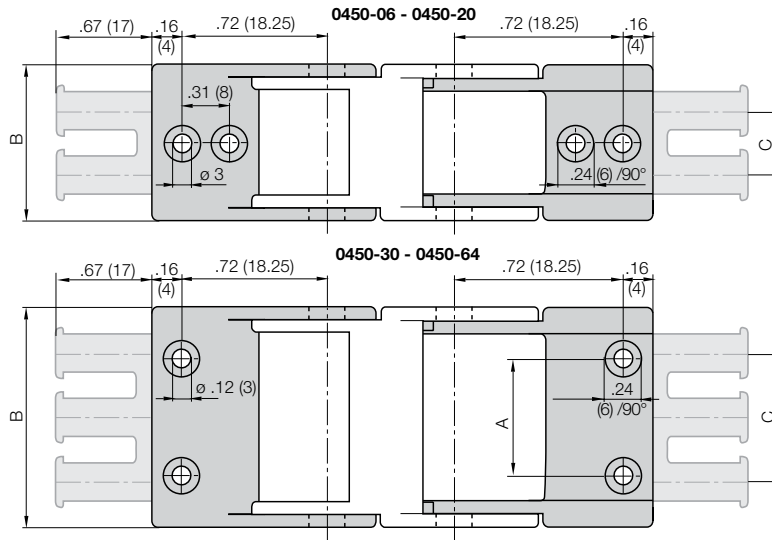

Chain Type	Part No. Full set without Tie-strap Plate	Part No. Full Set with Tie-strap Plate	Dimension A in. (mm)	Dimensions B in. (mm)	Dimensions C in. (mm)	Number of Teeth
045-06	0450-06-12	0450-06-12PZ	—	.47 (12)	—	1
045-10	0450-10-12	0450-10-12PZ	—	.63 (16)	—	1
045-16	0450-16-12	0450-16-12PZ	—	.87 (22)	.39 (10)	2
045-20	0450-20-12	0450-20-12PZ	—	1.02 (26)	.39 (10)	2
045-30	0450-30-12	0450-30-12PZ	.87 (22)	1.42 (36)	.79 (20)	3
045-64	0450-64-12	0450-64-12PZ	2.20 (56)	2.76 (70)	1.97 (50)	6

Additional Accessories



Quickfix - mounting bracket with dowel, upon request

Part No.

0450-16-12Q



For new designs we recommend E2 Micro "New Generation: E2C-10"

Price Index



Series 06

Special Features / Options



IPA Qualification Certificate:
Cleanroom test upon request



ESD Classification:
Electrically conductive ESD/
ATEX version upon request



Flammability Class
VDE 0304 IIC UL94 HB

Assembly Tips



East to assemble and disassemble

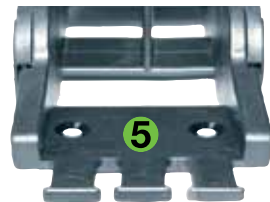

Features & Benefits

- 1 High torsional rigidity
- 2 Very lightweight - low price
- 3 Dirt repellent exterior
- 4 Mounting bracket with integrated strain relief
- 5 Molded in separator available

Usage Guidelines



- If high torsional rigidity is required
- If cost is a factor
- If connection options are required -
(Quicksnap & Quickfix)



- If snap-open links are required
➤ **Series 07 "Zipper"**
- If quick insertion of cables with
preassembled connectors is
required
➤ **Series E06/Z06 E-Z Chain**
- If very quiet operation is required
➤ **Series 045 E2 Micro**

Order Example: Complete e-chain®

Please indicate chain length or number of links. Example:

3.28 ft (1 m) 06-20-038-0

e-chain®

1 Set 060-20-12PZ

Mounting Bracket

e-chain system® E2 Micro Series 06 Installation Dimensions

Short travel, unsupported length

- FL_B = unsupported with permitted sag
 - FL_G = unsupported with straight upper run
- Further information ► Design, Chapter 1

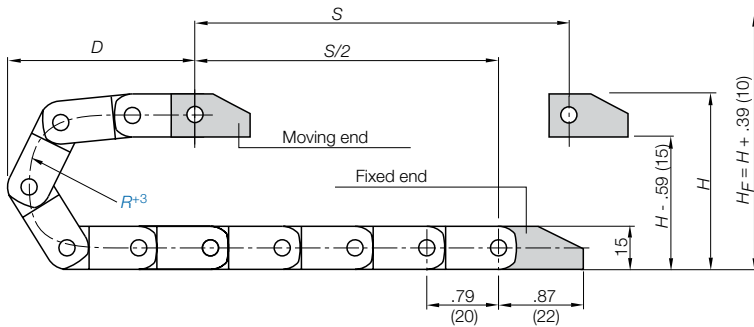
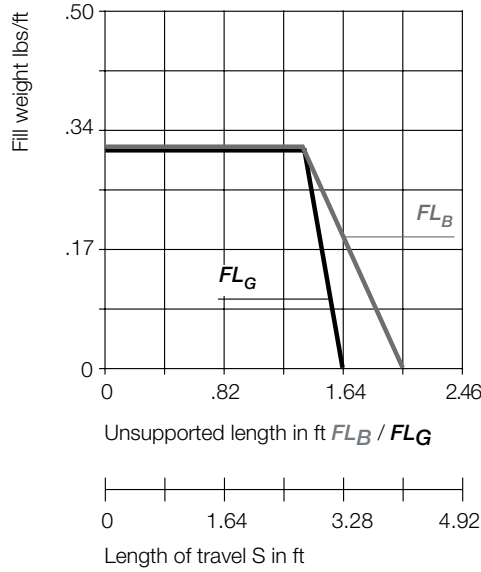
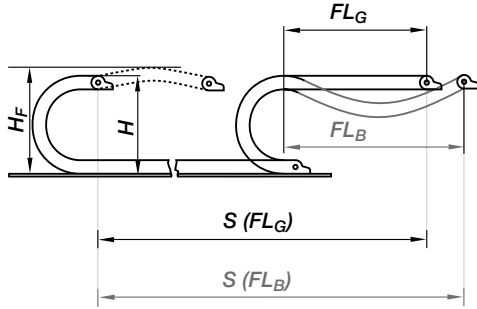

Pitch per link = $.79^\circ$ (20 mm)
 Links per ft (m) = 15.24 (50)
 For center mount applications:
 Chain length = $\frac{S}{2} + K$

The required clearance height: $H_F = H + .39$ in. (10 mm) (with .13 lbs/ft (0.2 kg/m) fill weight). Please consult igus® if space is particularly restricted.

R	.71 (018)	1.10 (028)	1.50 (038)
H*	2.01 (51)	2.80 (71)	3.58 (91)
D	2.20 (56)	2.60 (66)	2.99 (76)
K	3.94 (100)	5.12 (130)	6.30 (160)

Short Travels - Unsupported



Unsupported e-chains® feature positive camber over short travels. This must be accounted for when specifying the clearance height. Please refer to **Installation dimensions** for further details.

Legend

- S = Length of travel
- R = Bending radius
- H = Nominal clearance height
- D = Overlength e-chain® radius in final position
- $K = \pi \cdot R + \text{safety buffer}$
- H_F = Required clearance height

*If the mounting bracket location is set lower



PDF: igus.com/e-chain-pdfs
 Product information: igus.com/e-chains



Speed / acceleration FL_G	max. 65.6 ft/s (20 m/s) / max. 656 ft/s ² (200 m/s ²)
Speed / acceleration FL_B	max. 9.84 ft/s (3 m/s) / max. 19.69 ft/s ² (6 m/s ²)
Material - permitted temperature	igumid G / -40°F (-40°C) up to +248°F (+120°C)
Flammability Class, igumid G	VDE 0304 IIC UL94 HB

Technical Data



Details of material properties

► Chapter 1

Series 06 - e-chain® non snap-open

igus®
e-chain system®

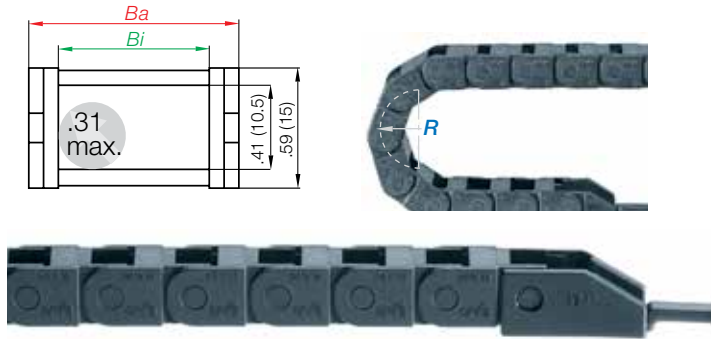

Part Number Structure

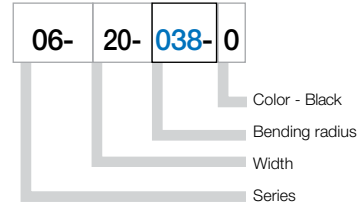

Telephone 1-800-521-2747

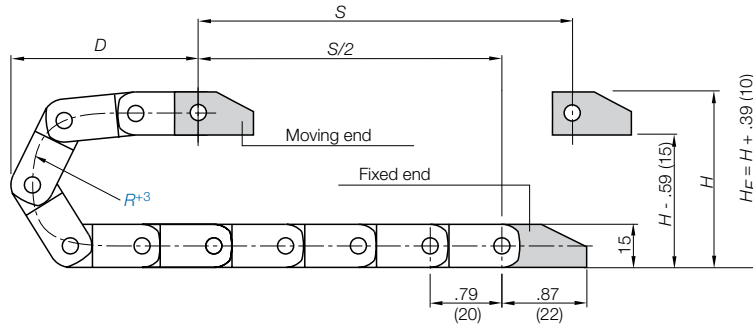

Supplement part number with required radius. Example: 06-20-038-0
Pitch: .79 in. (20 mm) per link links/ft (m) = 15.24 (50)

Part Number	<i>Bi</i> in. (mm)	<i>Ba</i> in. (mm)	Weight lbs/ft (kg/m)
06-06- [] -0	.28 (6)	.49 (12.5)	≈ 0.087 (0.13)
06-10- [] -0	.39 (10)	.65 (16.5)	≈ 0.094 (0.14)
06-16- [] -0	.63 (16)	.89 (22.5)	≈ 0.107 (0.16)
06-20- [] -0	.79 (20)	1.06 (27.0)	≈ 0.114 (0.17)
06-30- [] -0	1.18 (30)	1.46 (37.0)	≈ 0.134 (0.20)
06-40- [] -0	1.57 (40)	1.85 (47.0)	≈ 0.155 (0.23)
06-50- [] -0	1.97 (50)	2.24 (57.0)	≈ 0.175 (0.26)
06-64- [] -0	2.52 (64)	2.80 (71.0)	≈ 0.202 (0.30)

Choose from the radii below for all of the above sizes

Radius (mm) Example: 06-20-038-0

	018	028	038
<i>R</i>	.71 (018)	1.10 (028)	1.50 (038)
<i>H*</i>	2.01 (51)	2.80 (71)	3.58 (91)
<i>D</i>	2.20 (56)	2.60 (66)	2.99 (76)
<i>K</i>	3.94 (100)	5.12 (130)	6.30 (160)

0=Standard color black. For other colors see Chapter 1

Internet: igus.com
email: sales@igus.com
QuickSpec: igus.com/quickspec

e-chain system® E2 Micro Series 06 Mounting Brackets



Polymer, one-piece

- One-piece mounting bracket
- Corrosion resistant
- Available preassembled
- Inner and outer attachment possible
- Available with or without strain relief tiewrap plates

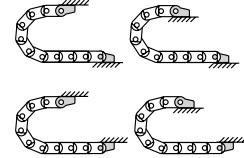
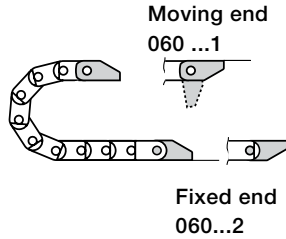

Possible installation configurations -

Part Number Structure

060-	20-	12	PZ
------	-----	----	----

- With assembled strain relief tiewrap plates
- Complete Set
- Width
- Mounting brackets for selected chain type

Full set, for both ends:

060- [20-] [12] Full set, each part with pin/bore

Single-part order:

060- [20-] [1] Mounting bracket with bore

060- [20-] [2] Mounting bracket with pin

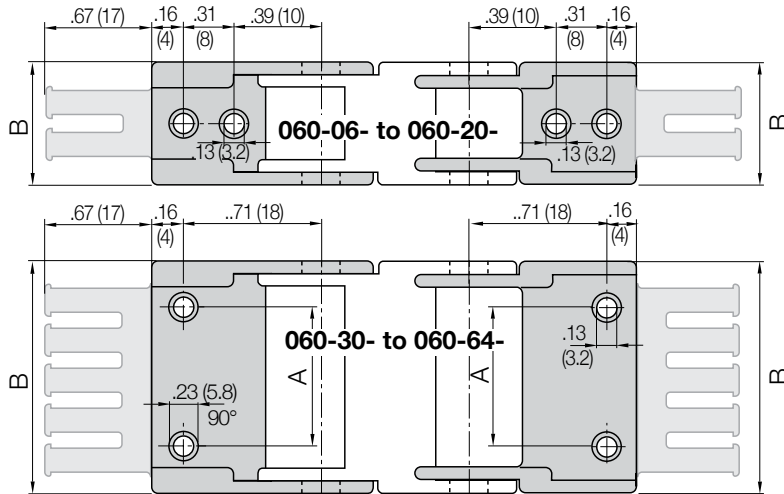

060-06-12 - 060-20-12: Center bores only

060-30-12 - 060-64-12: Outer bores only

Chain Type	Part No.	Part No.	Dimension A		Dimensions B		Number of Teeth
	Full set with Tiewrap Plate	Full Set without Tiewrap Plate	in.	(mm)	in.	(mm)	
06-06	060-06-12PZ	060-06-12	—	—	.42	(12.5)	1
06-10	060-10-12PZ	060-10-12	—	—	.65	(16.5)	1
06-16	060-16-12PZ	060-16-12	—	—	.89	(22.5)	2
06-20	060-20-12PZ	060-20-12	—	—	1.06	(27.0)	2
06-30	060-30-12PZ	060-30-12	.87	(22)	1.46	(37.0)	3
06-40	060-40-12PZ	060-40-12	1.26	(32)	1.85	(47.0)	4
06-50	060-50-12PZ	060-50-12	1.65	(42)	2.24	(57.0)	5
06-64	060-64-12PZ	060-64-12	2.20	(56)	2.70	(71.0)	6

Additional Accessories



Quicksnap - the complete, detachable mounting unit, upon request

Part No.

- 060-10-QS
- 060-16-QS
- 060-20-QS
- 060-40-QS



Quickfix - mounting bracket with dowel, upon request

Part No.

- 060-10-34QZ
- 060-20-34QZ



Price Index



Series E2-10

Special Features / Options



IPA Qualification Certificate:
Cleanroom test upon request



ESD Classification:
Electrically conductive ESD/
ATEX version upon request



Flammability Class
VDE 0304 IIC UL94 HB

Assembly Tips



Easy to assemble and disassemble

Usage Guidelines



- When long unsupported lengths and high additional loads are required with a small e-chain®
- For smooth, quiet operation due to small pitch
- If a large modular system in various designs is desired



- If a closed Energy Tube is required
➤ Series R07 “Zipper”
- If torsional rigidity is very important
➤ Series E2C-10 E2 Micro

Features & Benefits

- 1 Universal mounting bracket with strain relief option
- 2 Large, assembly friendly pins for long unsupported lengths
- 3 Very smooth contours ensure the best possible cable life
- 4 Non snap-open or snap-open in the inner or outer radius
- 5 Lightweight, low price
- 6 Square stop-dog system for large additional loads
- 7 Brake feature reduces noise



Order Example: Complete e-chain®

Please indicate chain length or number of links. Example:

3.28 ft (1 m) E2-10-20-038-0

e-chain®

1 Set E2-100-20-34PZ

Mounting Bracket

e-chain system® E2 Micro Series E2-10/E2i-10/E2C-10 Installation Dimensions



E2-10
E2i-10
E2C-10

Short travel, unsupported length

- FL_B = unsupported with permitted sag
 - FL_G = unsupported with straight upper run
- Further information ► Design, Chapter 1

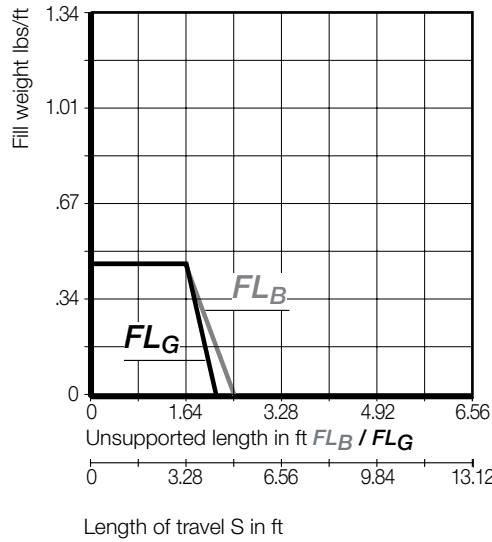
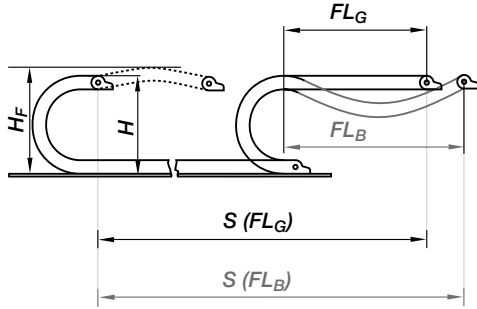

Short Travels - Unsupported



Unsupported e-chains® feature positive camber over short travels. This must be accounted for when specifying the clearance height. Please refer to **Installation dimensions** for further details.

Legend

- S = Length of travel
- R = Bending radius
- H = Nominal clearance height
- D = Overlength e-chain® radius in final position
- $K = \pi \cdot R + \text{safety buffer}$
- H_F = Required clearance height

*If the mounting bracket location is set lower

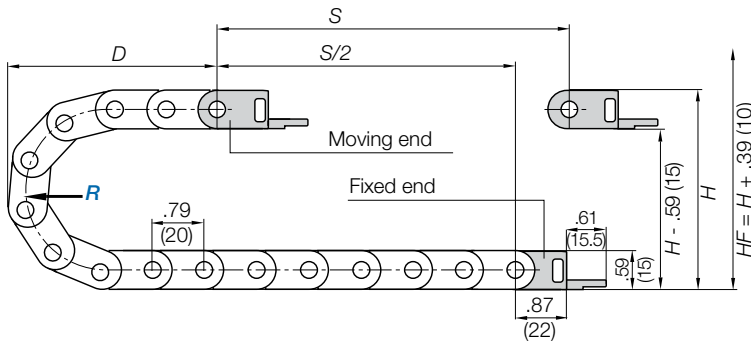

Pitch per link = .79" (20 mm)

Links per ft (m) = 15.24 (50)

For center mount applications:

Chain length = $\frac{S}{2} + K$

The required clearance height: $H_F = H + .39 \text{ in. (10 mm)}$ (with .13 lbs/ft (0.2 kg/m) fill weight). Please consult igus® if space is particularly restricted.

R	.71 (018)	1.10 (028)	1.50 (038)
H	2.01 (51)	2.80 (71)	3.58 (91)
D	2.20 (56)	2.60 (66)	2.99 (76)
K	3.94 (100)	5.12 (130)	6.30 (160)



PDF: igus.com/e-chain-pdfs
Product information: igus.com/e-chains



Speed / acceleration FL_G	max. 65.6 ft/s (20 m/s) / max. 656 ft/s ² (200 m/s ²)
Speed / acceleration FL_B	max. 9.84 ft/s (3 m/s) / max. 19.69 ft/s ² (6 m/s ²)
Gliding speed / acceleration (maximum)	max. 9.84 ft/s (3 m/s) / max. 32.8 ft/s ² (10 m/s ²)
Material - permitted temperature	igumid G / -40°F (-40°C) up to +248°F (+120° C)
Flammability Class, igumid G	VDE 0304 IIC UL94 HB

Technical Data



Details of material properties

► Chapter 1

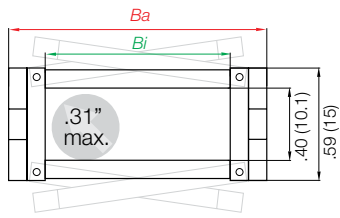

Series E2-10 - Snap-open along the outer radius from both sides



Part Number Structure



Color - Black
Bending radius
Width
Series

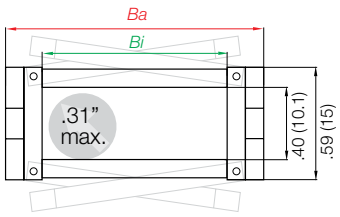

Series E2i-10 - Snap-open along the inner radius from both sides



Part Number Structure



Color - Black
Bending radius
Width
Series

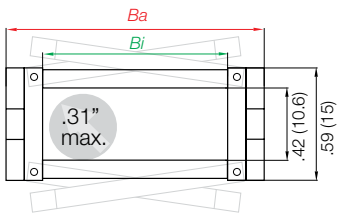

Series E2C-10 - One-piece, non snap-open



Part Number Structure



Color - Black
Bending radius
Width
Series

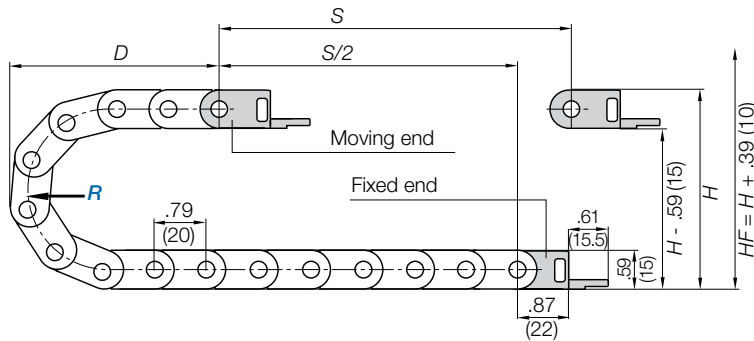

Supplement part number with required radius. Example: E2-10-20-038-0

Pitch: .79 in. (20 mm) per link links/ft (m) = 15.24 (50)

Snap-open along outer radius	Snap-open along inner radius	One-piece non snap-open		Bi in. (mm)	Ba in. (mm)	Weight		
						E2-10 lbs/ft (kg/m)	E2i-10 lbs/ft (kg/m)	E2C-10 lbs/ft (kg/m)
E2-10-06-	E2i-10-06-	E2C-10-06-	<input type="checkbox"/> -0	.28 (6)	.53 (13.4)	≈ 0.087 (0.13)	≈ 0.087 (0.13)	≈ 0.094 (0.14)
E2-10-10-	E2i-10-10-	E2C-10-10-	<input type="checkbox"/> -0	.39 (10)	.69 (17.4)	≈ 0.094 (0.14)	≈ 0.094 (0.14)	≈ 0.094 (0.14)
E2-10-16-	E2i-10-16-	E2C-10-16-	<input type="checkbox"/> -0	.63 (16)	.92 (23.4)	≈ 0.107 (0.16)	≈ 0.107 (0.16)	≈ 0.107 (0.16)
E2-10-20-	E2i-10-20-	E2C-10-20-	<input type="checkbox"/> -0	.79 (20)	1.08 (27.4)	≈ 0.114 (0.17)	≈ 0.114 (0.17)	≈ 0.114 (0.17)
E2-10-30-	E2i-10-30-	E2C-10-30-	<input type="checkbox"/> -0	1.18 (30)	1.47 (37.4)	≈ 0.128 (0.19)	≈ 0.128 (0.19)	≈ 0.134 (0.20)
E2-10-40-	E2i-10-40-	E2C-10-40-	<input type="checkbox"/> -0	1.57 (40)	1.87 (47.4)	≈ 0.148 (0.22)	≈ 0.148 (0.22)	≈ 0.154 (0.23)
E2-10-50-	E2i-10-50-	E2C-10-50-	<input type="checkbox"/> -0	1.97 (50)	2.26 (57.4)	≈ 0.168 (0.25)	≈ 0.168 (0.25)	≈ 0.168 (0.25)

Choose from the radii below for all of the above sizes

Radius (mm) Example: E2-10-20-038-0

0=Standard color black.
For other colors see Chapter 1

	018	028	038
R	.71 (018)	1.10 (028)	1.50 (038)
H	2.01 (51)	2.80 (71)	3.58 (91)
D	2.20 (56)	2.60 (66)	2.99 (76)
K	3.94 (100)	5.12 (130)	6.30 (160)

e-chain system® E2 Micro
 Series E2-10/E2i-10/E2C-10
 Interior Separation



E2-10
 E2i-10
 E2C-10

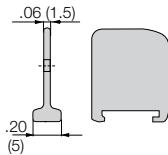
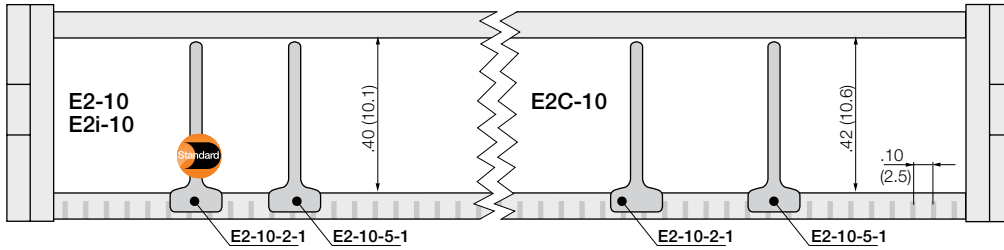

Separator

Unassembled	Part No. E2-10-2
Assembled	Part No. E2-10-2-1

- **Separator E2-10-2 Standard - for all applications**
 For a simple vertical subdivision on e-chains®. Separators can be arranged anywhere in the Energy cross section.

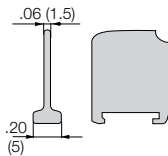

**Notch separator
 For notch crossbar**

Unassembled	Part No. E2-10-5
Assembled	Part No. E2-10-5-1

- **Notch separator E2-10-5 Locks safely in .10" (2.5 mm) increments**
 For exact positioning in e-chains®. Recommended for side-mounted applications.

PDF: igus.com/e-chain-pdfs
 Product information: igus.com/e-chains





Polymer, one-piece

- One-piece mounting bracket
- Corrosion resistant
- Available preassembled
- Inner and outer attachment possible
- Available with or without strain relief tiwrap plates

Moving end

- E2-100-...-3PZ two side pivoting
- E2-100-...-5PZ one side* pivoting
- E2-100-...-1PZ locking

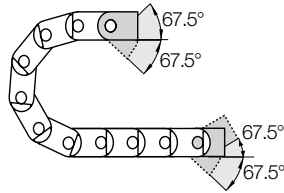

Fixed end

- E2-100-...-4PZ two side pivoting
- E2-100-...-6PZ one side* pivoting
- E2-100-...-2PZ locking

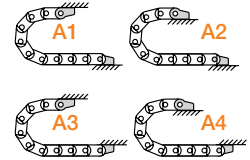

Possible installation configurations -

Part Number Structure

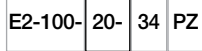

- E2-100-20-34-PZ: With assembled strain relief tiwrap plates
- 20: Complete Set - two side pivoting
- 34: Width
- PZ: Mounting brackets for selected chain type

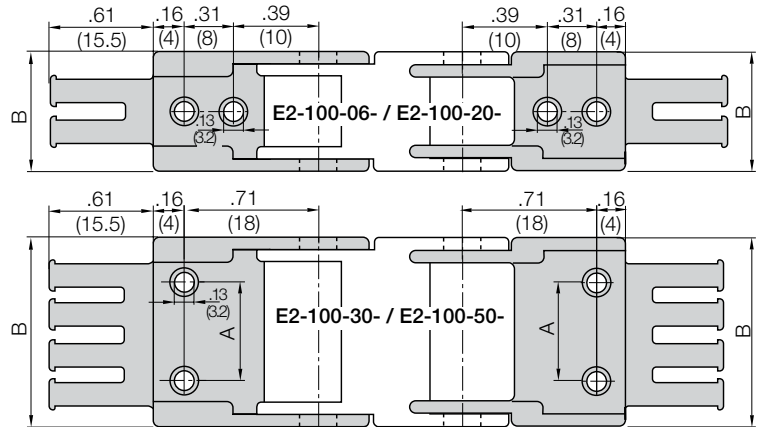

Full set, for both ends:

E2-100-20-34 Full set, each part with pin/bore

Single-part order:

- E2-100-20-3 Mounting bracket with bore
- E2-100-20-4 Mounting bracket with pin

E2-100-06-12 - E2-100-20-12: Center bores only
E2-100-30-12 - E2-100-64-12: Outer bores only

Chain Width	Part No. full set with tiwrap plate two side pivoting	Part No. full set with tiwrap plate one side* pivoting	Part No. full set with tiwrap plate locking	Dimension A in. (mm)	Dimension B in. (mm)	Number of Teeth
-06	E2-100-06-34PZ	E2-100-06-56PZ	E2-100-06-12PZ	—	.53 (13.4)	1
-10	E2-100-10-34PZ	E2-100-10-56PZ	E2-100-10-12PZ	—	.69 (17.4)	1
-16	E2-100-16-34PZ	E2-100-16-56PZ	E2-100-16-12PZ	—	.92 (23.4)	2
-20	E2-100-20-34PZ	E2-100-20-56PZ	E2-100-20-12PZ	—	1.08 (27.4)	2
-30	E2-100-30-34PZ	E2-100-30-56PZ	E2-100-30-12PZ	.87 (22)	1.47 (37.4)	3
-40	E2-100-40-34PZ	E2-100-40-56PZ	E2-100-40-12PZ	1.26 (32)	1.87 (47.4)	4
-50	E2-100-50-34PZ	E2-100-50-56PZ	E2-100-50-12PZ	1.65 (42)	2.26 (57.4)	5

*One-side pivoting: Pivot angle = Bending radius.

One side pivoting only to the inner radius - whether mounted to A1 or A4

Additional Accessories



Quick flange- the quick flange can be clipped-in laterally in all mounting brackets. Housing for hexagonal nut or M3 socket head screws M3.

Single:

Part no. E2-150-QF

Includes mounting bracket:

Part No. E2-100-20-34PZQF

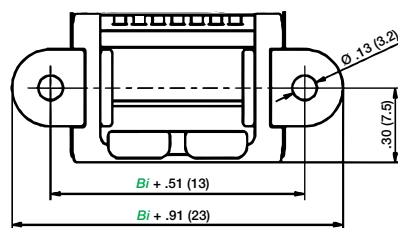



PDF: igus.com/e-chain-pdfs
Product information: igus.com/e-chains



Price Index



Series B07

Special Features / Options



ESD Classification:
Electrically conductive ESD/
ATEX version upon request



UL94 -V2 classifications upon
request

Assembly Tips



Easy to assemble and disassemble

Usage Guidelines



- If a small lightweight e-chain® is required
- If a small, openable, reasonably priced e-chain® is required
- Perfect for handling machines and pick-and-place tools



- If opening of the link is not necessary
 - **Series 06 E2 micro**
- If cable installation without opening lids is possible
 - **Series E06 E-Z Chain**
- If a fast openable Energy Tube system is required
 - **Series R07 E2 Tubes**

Features & Benefits

- 1 Lightweight
- 2 Small pitch for low-noise, smooth operation
- 3 Mounting bracket with integrated strain relief
- 4 For high acceleration
- 5 Snap-open along outer radius with film-hinge
- 6 Modular 2-piece link design - saves assembly time
- 7 Easy to shorten and lengthen at any given point



Order Example: Complete e-chain®

Please indicate chain length or number of links. Example:

3.28 ft (1 m) **B07-20-038-0**

e-chain®

1 Set **060-20-12PZ**

Mounting Bracket

Short travel, unsupported length

- FL_B = unsupported with permitted sag
 - FL_G = unsupported with straight upper run
- Further information ► Design, Chapter 1

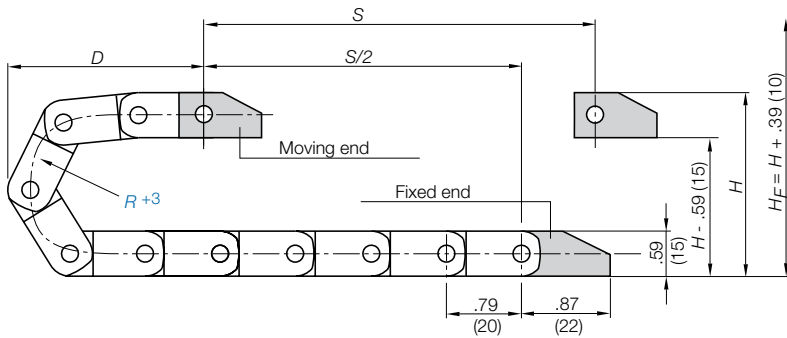
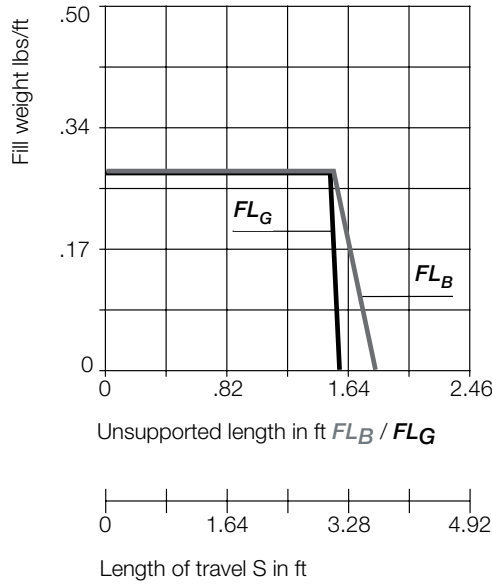
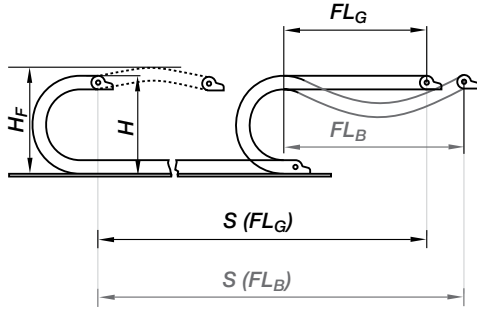

Pitch per link = $.79''$ (20 mm)
 Links per ft (m) = 15.24 (50)
 For center mount applications:
 Chain length = $\frac{S}{2} + K$

The required clearance height: $H_F = H + .39$ in. (10 mm) (with .13 lbs/ft (0.2 kg/m) fill weight). Please consult igus® if space is particularly restricted.

R	.71 (018)	1.10 (028)	1.50 (038)
H*	2.01 (51)	2.80 (71)	3.58 (91)
D	2.20 (56)	2.60 (66)	2.99 (76)
K	3.94 (100)	5.12 (130)	6.30 (160)

Short Travels -
Unsupported



Unsupported e-chains® feature positive camber over short travels. This must be accounted for when specifying the clearance height. Please refer to **Installation dimensions** for further details.

Legend

- S = Length of travel
- R = Bending radius
- H = Nominal clearance height
- D = Overlength e-chain® radius in final position
- $K = \pi \cdot R + \text{safety buffer}$
- H_F = Required clearance height

*If the mounting bracket location is set lower



PDF: igus.com/e-chain-pdfs
 Product information: igus.com/e-chains



Speed / acceleration FL_G	max. 6.56 ft/s (20 m/s) / max. 656 ft/s ² (200 m/s ²)
Speed / acceleration FL_B	max. 9.84 ft/s (3 m/s) / max. 19.69 ft/s ² (6 m/s ²)
Gliding speed / acceleration (maximum)	max. 32.81 ft/s (10 m/s) / max. 164 ft/s ² (50 m/s ²)
Material - permitted temperature	igumid G / -40°F (-40°C) up to +248°F (+120°C)
Flammability Class, igumid G	VDE 0304 IIC UL94 HB

Technical Data



Details of material properties

► Chapter 1

Series B07 - e-chain® snap-open along the outer radius

igus®
e-chain system®

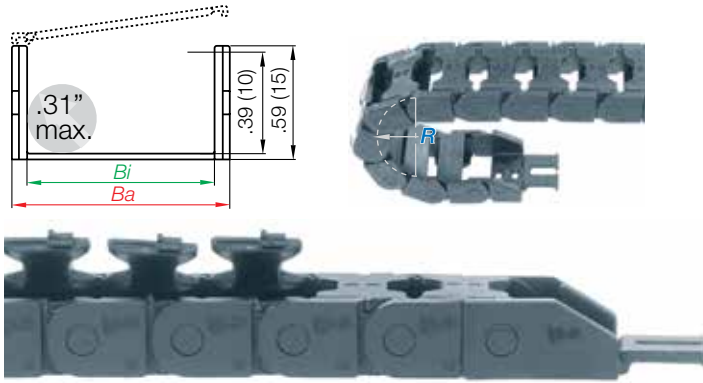

Part Number Structure

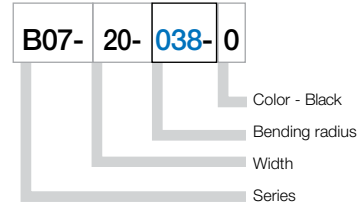

Telephone 1-800-521-2747

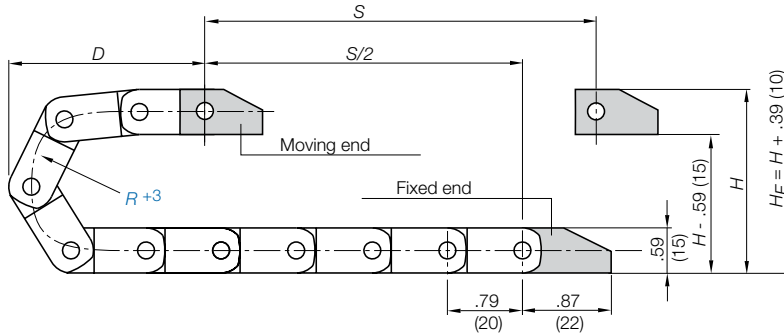

Supplement part number with required radius. Example: B07-20-038-0
Pitch: .79 in. (20 mm) per link links/ft (m) = 15.24 (50)

Part Number	<i>Bi</i> in. (mm)	<i>Ba</i> in. (mm)	Weight lbs/ft (kg/m)
B07-16- <input type="text"/> -0	.63 (16)	.89 (22.5)	≈ 0.107 (0.16)
B07-20- <input type="text"/> -0	.79 (20)	1.06 (27.0)	≈ 0.114 (0.17)
B07-30- <input type="text"/> -0	1.18 (30)	1.46 (37.0)	≈ 0.134 (0.20)
B07-40- <input type="text"/> -0	1.57 (40)	1.85 (47.0)	≈ 0.155 (0.23)

Choose from the radii below for all of the above sizes

Radius (mm) Example: B07-20-038-0

	018	028	038
R	.71 (018)	1.10 (028)	1.50 (038)
H*	2.01 (51)	2.80 (71)	3.58 (91)
D	2.20 (56)	2.60 (66)	2.99 (76)
K	3.94 (100)	5.12 (130)	6.30 (160)

0=Standard color black. For other colors see Chapter 1

Internet: igus.com
email: sales@igus.com
QuickSpec: igus.com/quickspec



Polymer, one-piece

- One-piece mounting bracket
- Corrosion resistant
- Available preassembled
- Inner and outer attachment possible
- Available with or without strain relief tiewrap plates

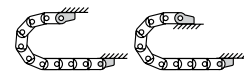
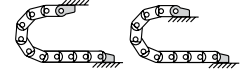
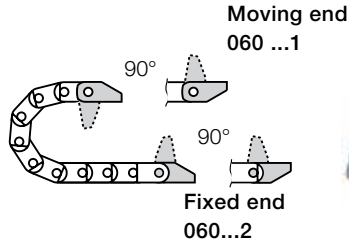

Possible installation configurations -

Part Number Structure



- With assembled strain relief tiewrap plates
- Complete Set
- Width
- Mounting brackets for selected chain type

Full set, for both ends:

060- [20- 12] Full set, each part with pin/bore

Single-part order:

060- [20- 1] Mounting bracket with bore

060- [20- 2] Mounting bracket with pin

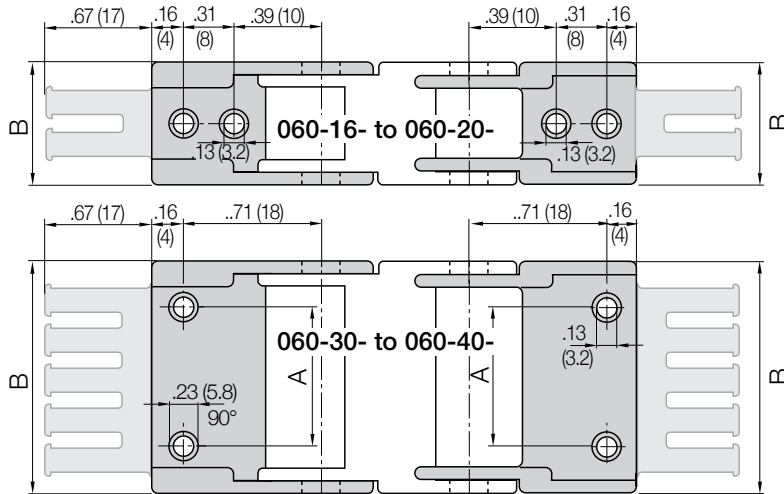

060-16-12 - 060-20-12: Center bores only

060-30-12 - 060-40-12: Outer bores only

Chain Type	Part No.	Part No.	Dimension A		Dimensions B		Number of Teeth
	Full set with Tiewrap Plate	Full Set without Tiewrap Plate	in.	(mm)	in.	(mm)	
B07-16	060-16-12PZ	060-16-12	—	—	.89	(22.5)	2
B07-20	060-20-12PZ	060-20-12	—	—	1.06	(27.0)	2
B07-30	060-30-12PZ	060-30-12	.87	(22)	1.46	(37.0)	3
B07-40	060-40-12PZ	060-40-12	1.26	(32)	1.85	(47.0)	4

Additional Accessories



Quicksnap - the complete, detachable mounting unit, upon request

Part No.

060-16-QS

060-20-QS

060-40-QS



Quickfix - mounting bracket with dowel, upon request

Part No.

060-20-34QZ



Price Index



Series B09

Special Features / Options



ESD Classification:
Electrically conductive ESD/
ATEX version upon request



UL94 -V2 classification version
upon request

Assembly Tips



Easy to assemble and disassemble

Usage Guidelines



- If a small and lightweight e-chain® is required
- If a small, openable, reasonably priced e-chain® is required
- Perfect for handling machines and pick-and-place robots



- If opening of the link is not necessary
 - Series 08 E2 Micro
- If cable installation without opening lids is possible
 - Series E08 E-Z Chain
- If a fast, openable Energy Tube system is required
 - Series R09 Energy Tube

Features & Benefits

- 1 Lightweight
- 2 Snap-open along outer radius with film-hinge
- 3 Mounting bracket with integrated strain relief
- 4 Small pitch for low-noise, smooth operation
- 5 Closed, easy to open version
- 6 Modular 2-piece link design - saves assembly time
- 7 For high acceleration
- 8 Easy to shorten and lengthen at any given point

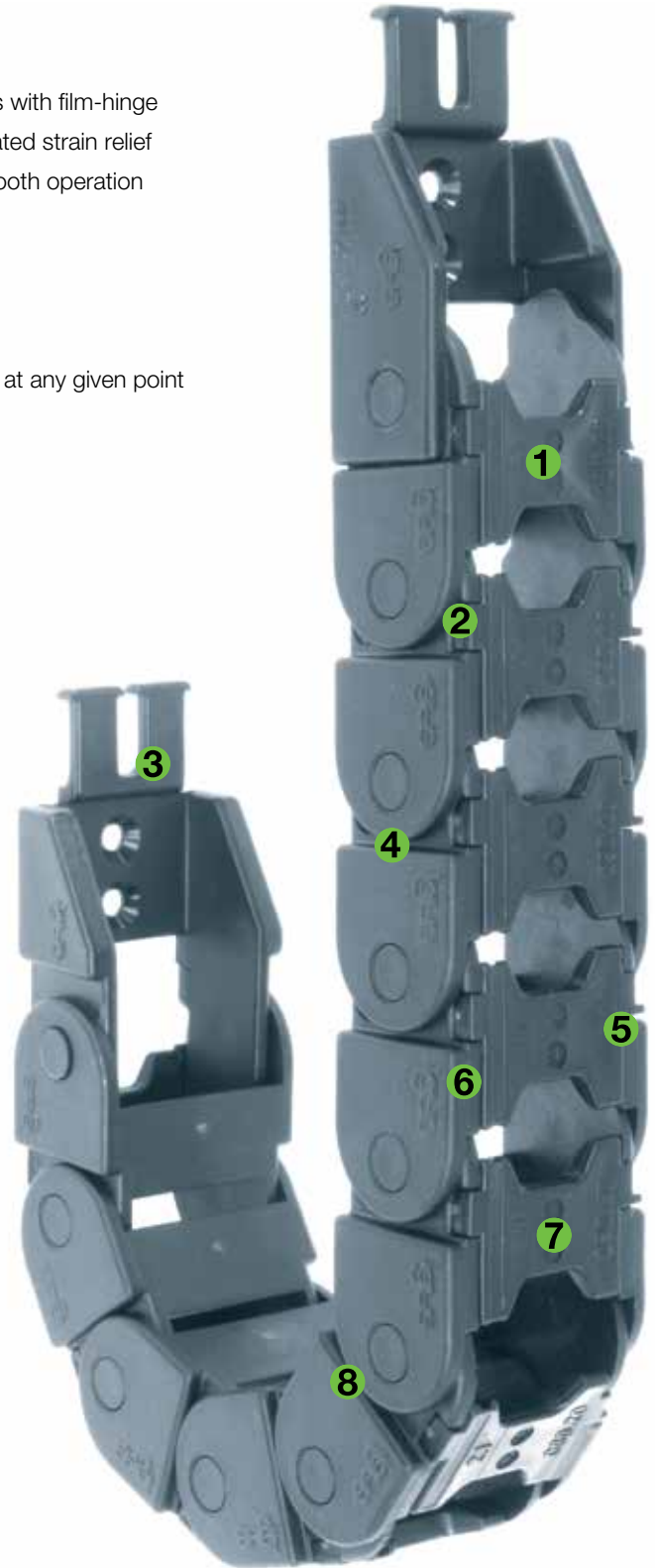

Order Example: Complete e-chain®

Please indicate chain length or number of links. Example:

3.28 ft (1 m) **B09-20-038-0**

e-chain®

1 Set **080-20-12PZ**

Mounting Bracket

Short travel, unsupported length

- FL_B = unsupported with permitted sag
 - FL_G = unsupported with straight upper run
- Further information ► Design, Chapter 1

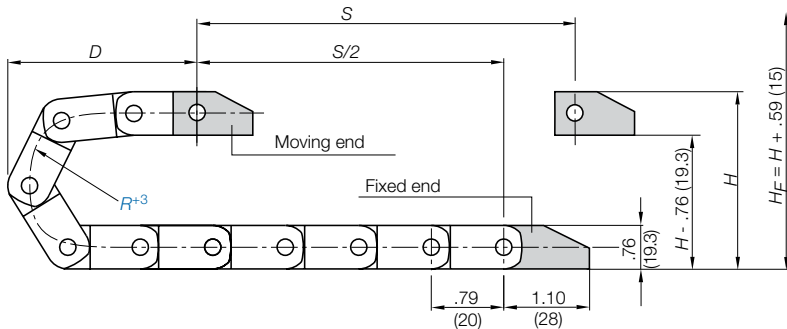
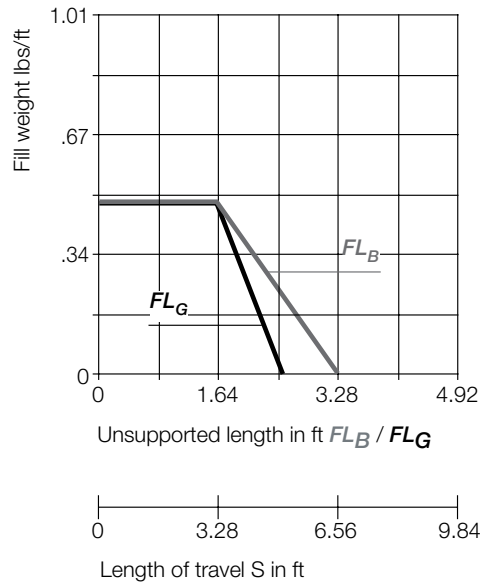
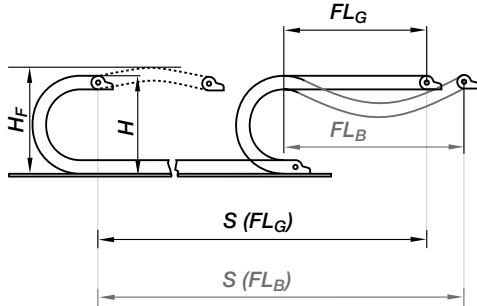

Pitch per link = .79" (20 mm)
Links per ft (m) = 15.24 (50)
For center mount applications:
Chain length = $\frac{S}{2} + K$

The required clearance height: $H_F = H + .59$ in. (15 mm) (with .20 lbs/ft (0.3 kg/m) fill weight). Please consult igus® if space is particularly restricted.

R	1.10 (028)	1.50 (038)	1.89 (048)
H*	2.95 (75)	3.74 (95)	4.53 (115)
D	2.68 (68)	3.07 (78)	3.46 (88)
K	5.21 (130)	6.41 (160)	7.68 (195)

Short Travels -
Unsupported



Unsupported e-chains® feature positive camber over short travels. This must be accounted for when specifying the clearance height. Please refer to **Installation dimensions** for further details.

Legend

- S = Length of travel
- R = Bending radius
- H = Nominal clearance height
- D = Overlength e-chain® radius in final position
- $K = \pi \cdot R + \text{ safety buffer}$
- H_F = Required clearance height

*If the mounting bracket location is set lower



Speed / acceleration FL_G	max. 6.56 ft/s (20 m/s) / max. 656 ft/s ² (200 m/s ²)
Speed / acceleration FL_B	max. 9.84 ft/s (3 m/s) / max. 19.69 ft/s ² (6 m/s ²)
Gliding speed / acceleration (maximum)	max. 32.81 ft/s (10 m/s) / max. 164 ft/s ² (50 m/s ²)
Material - permitted temperature	igumid G / -40°F (-40°C) up to +248°F (+120°C)
Flammability Class, igumid G	VDE 0304 IIC UL94 HB

Technical Data



Details of material properties

► Chapter 1

Series B09 - e-chain® snap-open along the outer radius

igus®
e-chain system®

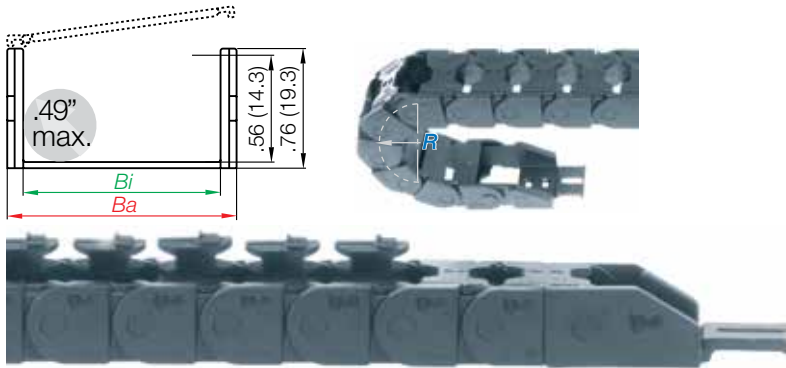

Part Number Structure

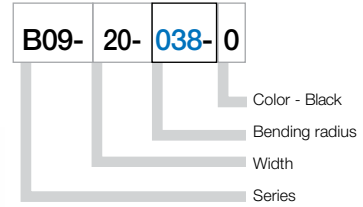

Telephone 1-800-521-2747

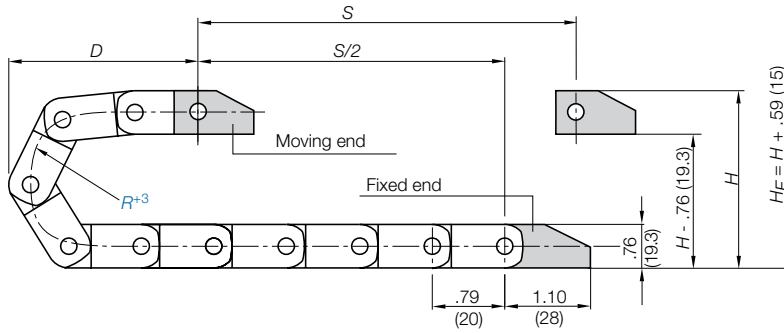

Supplement part number with required radius. Example: B09-20-**038**-0
Pitch: .79 in. (20 mm) per link links/ft (m) = 15.24 (50)

Part Number	<i>Bi</i> in. (mm)	<i>Ba</i> in. (mm)	Weight lbs/ft (kg/m)
B09-16- <input type="text"/> -0	.63 (16)	.95 (24.2)	≈ 0.16 (0.24)
B09-20- <input type="text"/> -0	.79 (20)	1.11 (28.2)	≈ 0.17 (0.25)
B09-30- <input type="text"/> -0	1.18 (30)	1.50 (38.2)	≈ 0.19 (0.28)
B09-40- <input type="text"/> -0	1.57 (40)	1.90 (48.2)	≈ 0.21 (0.31)

Choose from the radii below for all of the above sizes
Radius (mm) Example: B09-20-**038**-0

	028	038	048
R	1.10 (028)	1.50 (038)	1.89 (048)
H*	2.95 (75)	3.74 (95)	4.53 (115)
D	2.68 (68)	3.07 (78)	3.46 (88)
K	5.21 (130)	6.41 (160)	7.68 (195)

0=Standard color black. For other colors see Chapter 1

Internet: igus.com
email: sales@igus.com
QuickSpec: igus.com/quickspec

Additional Accessories



Quicksnap - the complete, detachable mounting unit, upon request

Part No.
080-20-QS
080-30-QS

e-chain system® E2 Micro Series B09 Interior Separation - Mounting Brackets



B09

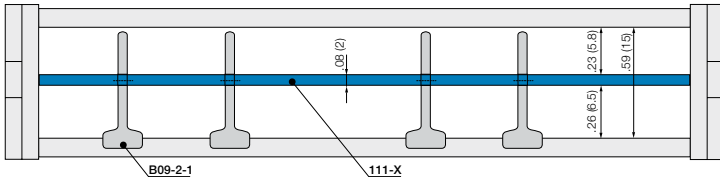

Separators, full-width shelves -

In the standard configuration separators are assembled every other Energy-Chain® link!

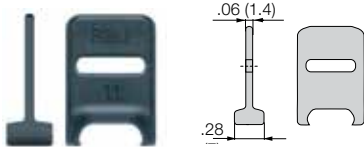

Vertical Separator, slotted

Unassembled **Part No. B09-2**

Assembled **Part No. B09-2-1**

Slotted separator B09-2

This component is used when vertical separation is required. Due to its slot, it allows basic vertical/horizontal shelving arrangements

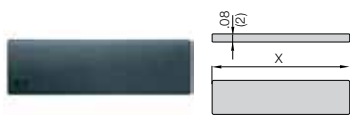

Full width shelf

Unassembled **Part No. 110-X**

Assembled **Part No. 111-X**

Full width shelf 110-X

This component is used in applications with many thin cables with similar diameters.

Width X in. (mm)	Part No. Unassembled	Part No. Assembled	Width X in. (mm)	Part No. Unassembled	Part No. Assembled
.39 (010)	110-10	111-10	1.18 (030)	110-30	111-30
.51 (013)	110-13	111-13	1.57 (040)	110-40	111-40
.63 (016)	110-16	111-16	1.97 (050)	110-50	111-50
.79 (020)	110-20	111-20			

Mounting Brackets



Plastic, one-piece

- One-piece mounting bracket
- Corrosion resistant
- Available preassembled
- Inner and outer attachment possible
- Available with or without strain relief tiewrap plates

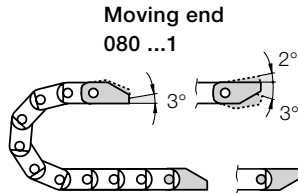

Fixed end
080...2

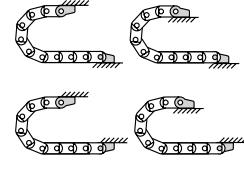

Possible installation configurations -

Part Number Structure

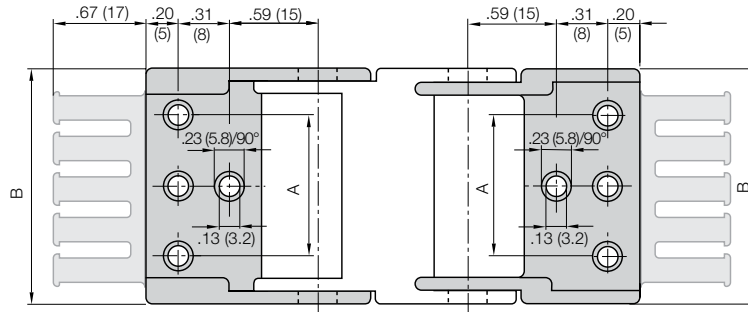
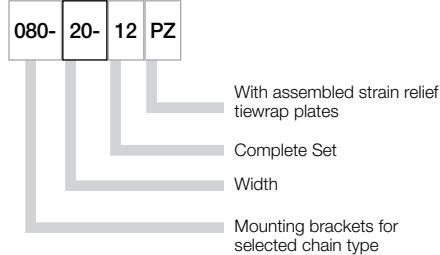

Full set, for both ends:

080- [20-] [12] Full set, each part with pin/bore

Single-part order:

080- [20-] [1] Mounting bracket with bore

080- [20-] [2] Mounting bracket with pin

080-16-12 - 080-20-12:

Center bores only

080-30-12 - 080-40-12:

Outer bores only

Chain Type	Part No. Full set with Tiewrap Plate	Part No. Full Set without Tiewrap Plate	Dimension A in. (mm)	Dimensions B in. (mm)	Number of Teeth
B09-16	080-16-12PZ	080-16-12	—	.95 (24.2)	2
B09-20	080-20-12PZ	080-20-12	—	1.11 (28.2)	2
B09-30	080-30-12PZ	080-30-12	.87 (22)	1.50 (38.2)	3
B09-40	080-40-12PZ	080-40-12	1.26 (32)	1.90 (48.2)	4

PDF: igus.com/e-chain-pdfs
Product information: igus.com/e-chains



Price Index



Series E2-15

Special Features / Options



IPA Qualification Certificate:
Cleanroom test upon request



ESD Classification:
Electrically conductive ESD/
ATEX version upon request



Flammability Class
VDE 0304 IIC UL94 HB

Assembly Tips



Easy to assemble and disassemble
Series 06 shown for demonstration
purposes only

Usage Guidelines



- When large unsupported lengths and high additional loads are required with a small e-chain®
- For smooth, quiet operation due to small pitch
- If a large modular system in various designs is desired



- If a closed Energy Tube is required
➤ Series R09 “Zipper”
- If filling without opening lids is required
➤ Series 08 E-Z Chain

Features & Benefits

- 1 Universal mounting bracket with strain relief option
- 2 Large, assembly friendly pins for long unsupported lengths
- 3 Very smooth contours ensure the best possible cable life
- 4 Non snap-open or snap-open on the inner or outer radius
- 5 Lightweight, low price
- 6 Square stop-dog system for large additional loads
- 7 Brake feature reduces noise



Order Example: Complete e-chain®

Please indicate chain length or number of links. Example:

3.28 ft (1 m) E2-15-20-038-0

e-chain®

1 Set E2-150-20-34PZ

Mounting Bracket

e-chain system® E2 Micro Series E2-15/E2i-15/E2C-15 Installation Dimensions



E2-15
E2i-15
E2C-15

Short travel, unsupported length

- FL_B = unsupported with permitted sag
 - FL_G = unsupported with straight upper run
- Further information ► Design, Chapter 1

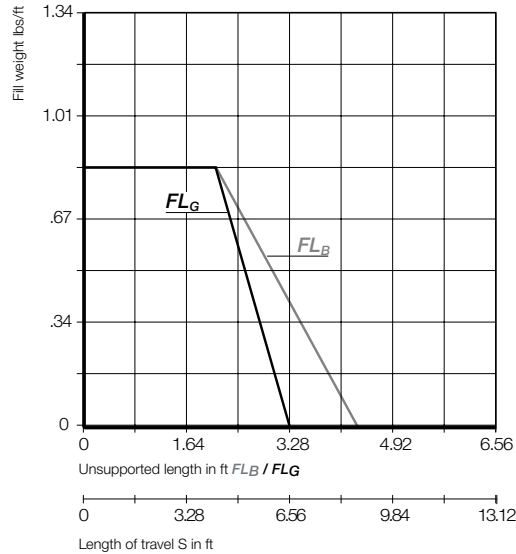
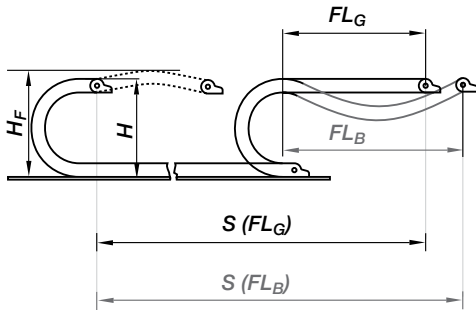

Short Travels - Unsupported



Unsupported e-chains® feature positive camber over short travels. This must be accounted for when specifying the clearance height. Please refer to **Installation dimensions** for further details.

Legend

- S = Length of travel
- R = Bending radius
- H = Nominal clearance height
- D = Overlength e-chain® radius in final position
- $K = \pi \cdot R + \text{safety buffer}$
- H_f = Required clearance height

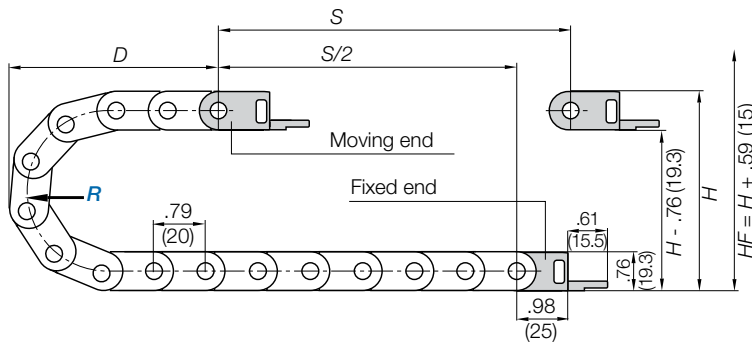

Pitch per link = .79" (20 mm)
Links per ft (m) = 15.24 (50)
For center mount applications:
Chain length = $\frac{S}{2} + K$

The required clearance height: $H_f = H + .59$ in. (15 mm) (with .20 lbs/ft (0.3 kg/m) fill weight). Please consult igus® if space is particularly restricted.

R	1.10 (028)	1.50 (038)	1.89 (048)	2.95 (075*)
H	2.95 (75)	3.74 (95)	4.53 (115)	6.65 (169)
D	2.68 (68)	3.07 (78)	3.46 (88)	4.53 (115)
K	5.12 (130)	6.30 (160)	7.68 (195)	11.02 (280)



PDF: igus.com/e-chain-pdfs
Product information: igus.com/e-chains



Speed / acceleration FL_G	max. 65.6 ft/s (20 m/s) / max. 656 ft/s ² (200 m/s ²)
Speed / acceleration FL_B	max. 9.84 ft/s (3 m/s) / max. 19.69 ft/s ² (6 m/s ²)
Gliding speed / acceleration (maximum)	max. 9.84 ft/s (3 m/s) / max. 32.8 ft/s ² (10 m/s ²)
Material - permitted temperature	igumid G / -40°F (-40°C) up to +248°F (+120° C)
Flammability Class, igumid G	VDE 0304 IIC UL94 HB

Technical Data



Details of material properties

► Chapter 1

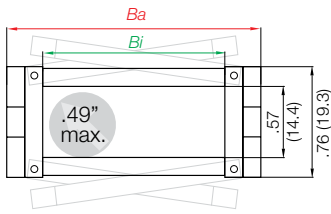

Series E2-15 - Snap-open along the outer radius from both sides



Part Number Structure



Color - Black
Bending radius
Width
Series

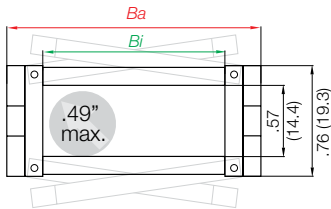

Series E2i-15 - Snap-open along the inner radius from both sides



Part Number Structure



Color - Black
Bending radius
Width
Series

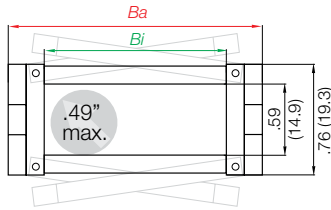

Series E2C-15 - One-piece, non snap-open



Part Number Structure



Color - Black
Bending radius
Width
Series

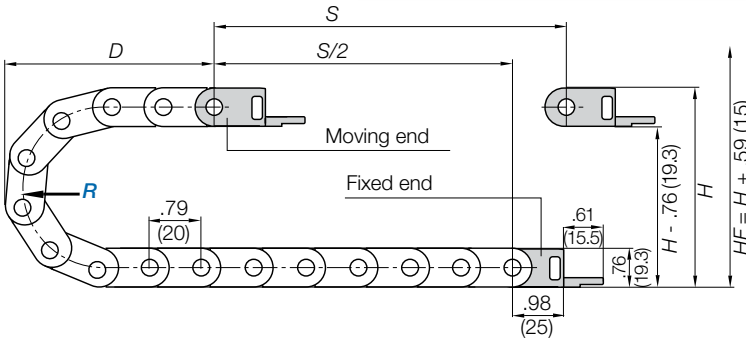

Supplement part number with required radius. Example: E2-15-20-038-0
Pitch: .79 in. (20 mm) per link links/ft (m) = 15.24 (50)

Snap-open along outer radius	Snap-open along inner radius	One-piece non snap-open	Bi in. (mm)	Ba in. (mm)	Weight		
					E2-15 lbs/ft (kg/m)	E2i-15 lbs/ft (kg/m)	E2C-15 lbs/ft (kg/m)
E2-15-10-	E2i-15-10-	E2C-15-10-	.39 (10)	.69 (17.4)	≈ 0.120 (0.18)	≈ 0.120 (0.18)	≈ 0.128 (0.19)
E2-15-13-	E2i-15-13-	E2C-15-13-	.51 (13)	.82 (20.8)	≈ 0.128 (0.19)	≈ 0.128 (0.19)	≈ 0.134 (0.20)
E2-15-16-	E2i-15-16-	E2C-15-16-	.63 (16)	.92 (23.4)	≈ 0.134 (0.20)	≈ 0.134 (0.20)	≈ 0.134 (0.20)
E2-15-20-	E2i-15-20-	E2C-15-20-	.79 (20)	1.08 (27.4)	≈ 0.141 (0.21)	≈ 0.141 (0.21)	≈ 0.141 (0.21)
E2-15-30-	E2i-15-30-	E2C-15-30-	1.18 (30)	1.47 (37.4)	≈ 0.161 (0.24)	≈ 0.161 (0.24)	≈ 0.161 (0.24)
E2-15-40-	E2i-15-40-	E2C-15-40-	1.57 (40)	1.87 (47.4)	≈ 0.175 (0.26)	≈ 0.175 (0.26)	≈ 0.175 (0.26)
E2-15-50-	E2i-15-50-	E2C-15-50-	1.97 (50)	2.26 (57.4)	≈ 0.195 (0.29)	≈ 0.195 (0.29)	≈ 0.195 (0.29)

Choose from the radii below for all of the above sizes

Radius (mm) Example: E2-15-20-038-0

0=Standard color black.
For other colors see Chapter 1

	028	038	048	075*
R	1.10 (028)	1.50 (038)	1.89 (048)	2.95 (075*)
H	2.95 (75)	3.74 (95)	4.53 (115)	6.65 (169)
D	2.68 (68)	3.07 (78)	3.46 (88)	4.53 (115)
K	5.12 (130)	6.30 (160)	7.68 (195)	11.02 (280)

*Radius 075 is only available for the E2C-15-40

e-chain system® E2 Micro
Series E2-15/E2i-15/E2C-15
Interior Separation



E2-15
E2i-15
E2C-15

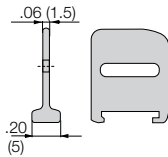
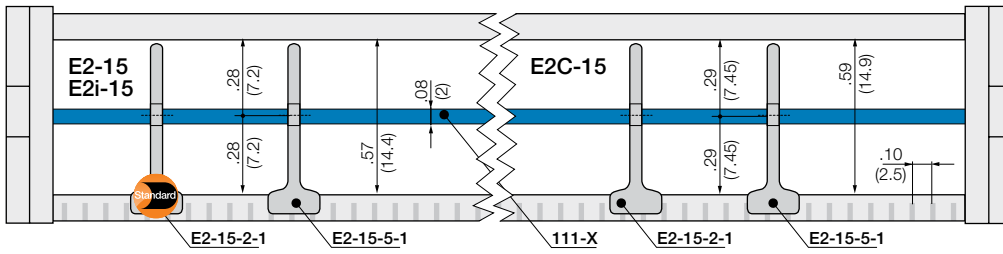

Separator

Unassembled **Part No. E2-15-2**

Assembled **Part No. E2-15-2-1**

• **Separator E2-15-2 Standard - for all applications**

For a simple vertical subdivision on e-chains®. Separators can be arranged anywhere in the Energy cross section.

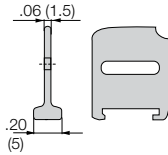

Notch separator for notch crossbar

Unassembled **Part No. E2-15-5**

Assembled **Part No. E2-15-5-1**

• **Notch separator E2-15-5 Locks safely in .10" (2.5 mm) increments**

For exact positioning in e-chains®. Recommended for side-mounted applications.

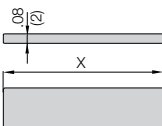

Full width shelf

Unassembled **Part No. 110-X**

Assembled **Part No. 111-X**

• **Full width shelf 110-X**

This component is used in applications with many thin cables with similar diameters.

Width X in. (mm)	Part No. Unassembled	Part No. Assembled	Width X in. (mm)	Part No. Unassembled	Part No. Assembled
.39 (010)	110-10	111-10	1.18 (030)	110-30	111-30
.51 (013)	110-13	111-13	1.57 (040)	110-40	111-40
.63 (016)	110-16	111-16	1.97 (050)	110-50	111-50
.79 (020)	110-20	111-20			

PDF: igus.com/e-chain-pdfs
Product information: igus.com/e-chains





Polymer, one-piece

- One-piece mounting bracket
- Corrosion resistant
- Available preassembled
- Inner and outer attachment possible
- Available with or without strain relief tiwrap plates

Moving end

- E2-150-...-3PZ two side pivoting
- E2-150-...-5PZ one side* pivoting
- E2-150-...-1PZ locking

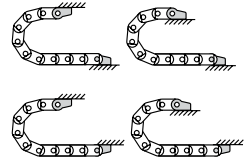
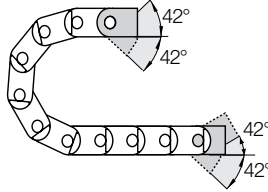

Possible installation configurations -

Fixed end

- E2-150-...-4PZ two side pivoting
- E2-150-...-6PZ one side* pivoting
- E2-150-...-2PZ locking

Part Number Structure

E2-150-	20-	34	PZ
---------	-----	----	----

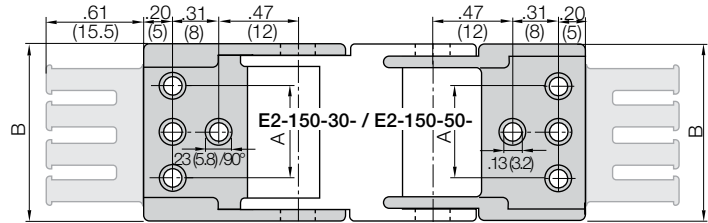
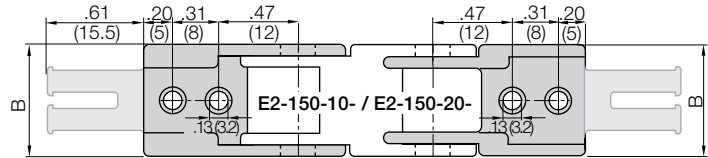
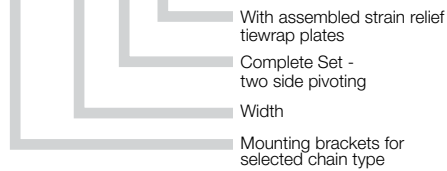

Full set, for both ends:

E2-150- [20-] [34] Full set, each part with pin/bore

Single-part order:

E2-150- [20-] [3] Mounting bracket with bore

E2-150- [20-] [4] Mounting bracket with pin

E2-150-10-12 - E2-150-20-12: Center bores only

E2-150-30-12 - E2-150-50-12: Outer bores only

Chain Width	Part No. full set with tiwrap plate two side pivoting	Part No. full set with tiwrap plate one side* pivoting	Part No. full set with tiwrap plate locking	Dimension A in. (mm)	Dimension B in. (mm)	Number of Teeth
-10	E2-150-10-34PZ	E2-150-10-56PZ	E2-150-10-12PZ	—	.70 (17.8)	1
-13	E2-150-13-34PZ	E2-150-13-56PZ	E2-150-13-12PZ	—	.82 (20.8)	1
-16	E2-150-16-34PZ	E2-150-16-56PZ	E2-150-16-12PZ	—	.94 (23.8)	2
-20	E2-150-20-34PZ	E2-150-20-56PZ	E2-150-20-12PZ	—	1.09 (27.8)	2
-30	E2-150-30-34PZ	E2-150-30-56PZ	E2-150-30-12PZ	.87 (22)	1.49 (37.8)	3
-40	E2-150-40-34PZ	E2-150-40-56PZ	E2-150-40-12PZ	1.26 (32)	1.88 (47.8)	4
-50	E2-150-50-34PZ	E2-150-50-56PZ	E2-150-50-12PZ	1.65 (42)	2.27 (57.8)	5

*One-side pivoting: Pivot angle = Bending radius.

One side pivoting only to the inner radius

Additional Accessories



Quick flange- the quick flange can be clipped-in laterally in all mounting brackets. Housing for hexagonal nut or cylinder head screws M3.

Single:

Part no. E2-150-QF

Includes mounting bracket:

Part No. E2-150-20-34PZQF

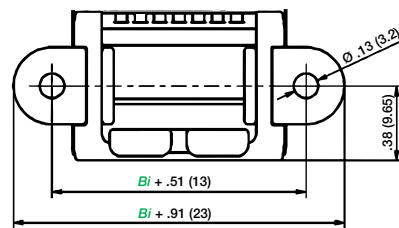

PDF: igus.com/e-chain-pdfs
Product information: igus.com/e-chains



Price Index

Series 08

Special Features / Options

IPA Qualification Certificate:
Cleanroom test upon request

ESD Classification:
Electrically conductive ESD/
ATEX version upon request

Flammability Class
VDE 0304 IIC UL94 HB

Assembly Tips

Easy to assemble and disassemble

Usage Guidelines

- If quiet operation is required
- If cost is a factor
- If connection options are required (Quicksnap, Quickfix, etc.)
- If high torsional rigidity is required



- If snap-open links are required
 - **Series 09 "Zipper"**
- If quick insertion of cables with preassembled connectors is required
 - **Series E08/Z08 E-Z Chain**

Features & Benefits

- 1 Small pitch for very quiet operation
- 2 High torsional rigidity
- 3 Mounting brackets with strain relief options
- 4 One-piece, non snap-open e-chain®
- 5 Very lightweight - low price
- 6 Dirt repellant exterior

Order Example: Complete e-chain®

Please indicate chain length or number of links. Example:

3.28 ft (1 m) 08-30-038-0

e-chain®

1 Set 080-30-12PZ

Mounting Bracket

e-chain system® E2 Micro Series 08 Installation Dimensions

Short travel, unsupported length

- FL_B = unsupported with permitted sag
 - FL_G = unsupported with straight upper run
- Further information ► Design, Chapter 1

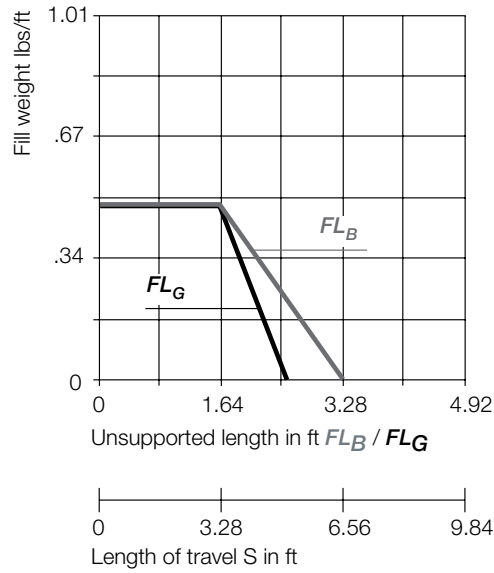
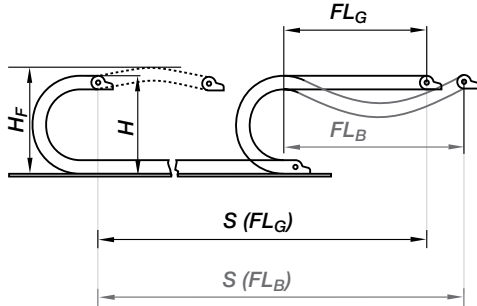

Short Travels - Unsupported

Unsupported e-chains® feature positive camber over short travels. This must be accounted for when specifying the clearance height. Please refer to **Installation dimensions** for further details.

Legend

- S = Length of travel
- R = Bending radius
- H = Nominal clearance height
- D = Overlength e-chain® radius in final position
- $K = \pi \cdot R + \text{safety buffer}$
- H_F = Required clearance height

*If the mounting bracket location is set lower

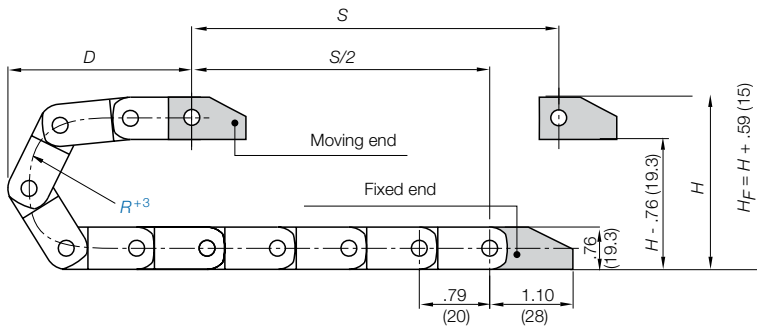

Pitch per link = .79" (20 mm)
 Links per ft (m) = 15.24 (50)
 For center mount applications:
 Chain length = $\frac{S}{2} + K$

The required clearance height: $H_F = H + .59 \text{ in. (15 mm)}$ (with .20 lbs/ft (0.3 kg/m) fill weight). Please consult igus® if space is particularly restricted.

R	.98 (025*)	1.10 (028)	1.50 (038)	1.89 (048)
H	2.72 (69)	2.95 (75)	3.74 (95)	4.53 (115)
D	2.56 (65)	2.68 (68)	3.07 (78)	3.46 (88)
K	4.72 (120)	5.12 (130)	6.30 (160)	7.48 (190)

*Only for 08-10 and 08-20 e-chain®



PDF: igus.com/e-chain-pdfs
 Product information: igus.com/e-chains



Speed / acceleration FL_G	max. 65.6 ft/s (20 m/s) / max. 656 ft/s ² (200 m/s ²)
Speed / acceleration FL_B	max. 9.84 ft/s (3 m/s) / max. 19.69 ft/s ² (6 m/s ²)
Material - permitted temperature	igumid G / -40°F (-40°C) up to +248°F (+120°C)
Flammability Class, igumid G	VDE 0304 IIC UL94 HB

Technical Data



Details of material properties

► Chapter 1

Series 08 - e-chain® non snap-open

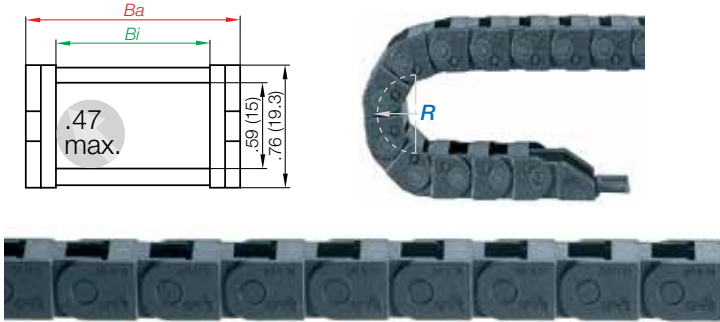

Part Number Structure

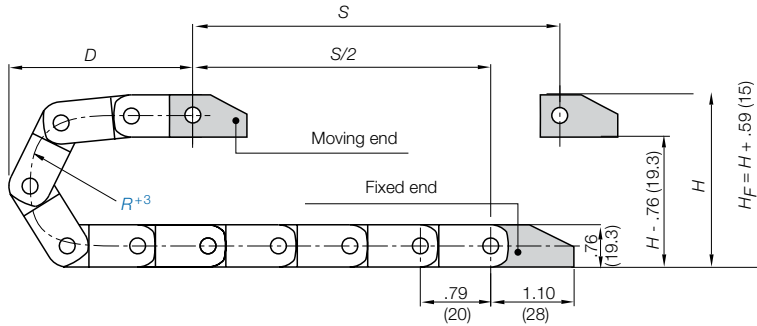
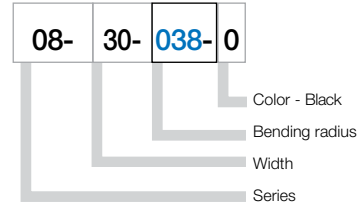

Supplement part number with required radius. Example: 08-20-**038**-0
Pitch: .79 in. (20 mm) per link links/ft (m) = 15.24 (50)

Part Number	<i>Bi</i> in. (mm)	<i>Ba</i> in. (mm)	Weight lbs/ft (kg/m)
08-10- <input type="checkbox"/> -0	.39 (10)	.72 (18.2)	≈ 0.14 (0.21)
08-13- ** <input type="checkbox"/> -0	.51 (13)	.83 (21.2)	≈ 0.15 (0.23)
08-16- <input type="checkbox"/> -0	.63 (16)	.95 (24.2)	≈ 0.16 (0.24)
08-20- <input type="checkbox"/> -0	.79 (20)	1.11 (28.2)	≈ 0.17 (0.25)
08-30- <input type="checkbox"/> -0	1.18 (30)	1.50 (38.2)	≈ 0.19 (0.28)
08-40- <input type="checkbox"/> -0	1.57 (40)	1.90 (48.2)	≈ 0.21 (0.31)
08-50- <input type="checkbox"/> -0	1.97 (50)	2.29 (58.2)	≈ 0.25 (0.37)

Choose from the radii below for all of the above sizes

Radius (mm) Example: 08-20-**038**-0

	025*	028	038	048
<i>R</i>	.98 (025*)	1.10 (028)	1.50 (038)	1.89 (048)
<i>H</i>	2.72 (69)	2.95 (75)	3.74 (95)	4.53 (115)
<i>D</i>	2.56 (65)	2.68 (68)	3.07 (78)	3.46 (88)
<i>K</i>	4.72 (120)	5.12 (130)	6.30 (160)	7.48 (190)

*Only for 08-10 and 08-20 e-chain®
0=Standard color black. For other colors see Chapter 1
**only for 028 and 038 radius

Additional Accessories



Quicksnap - the complete, detachable mounting unit, upon request

Part No.
080-20-QS
080-30-QS

e-chain system® E2 Micro Series 08 Interior Separation - Mounting Brackets

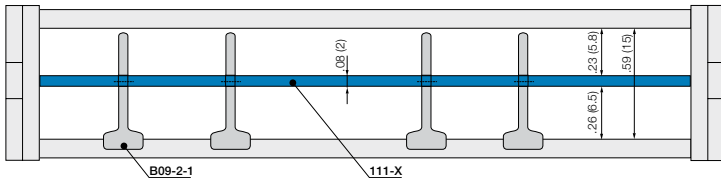

Separators, full-width shelves -
In the standard configuration separators are assembled every other Energy-Chain® link!

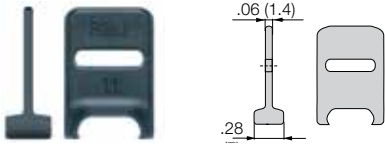

Vertical Separator, slotted
Unassembled **Part No. B09-2**
Assembled **Part No. B09-2-1**

- **Slotted separator B09-2**
This component is used when vertical separation is required. Due to its slot, it allows basic vertical/horizontal shelving arrangements.

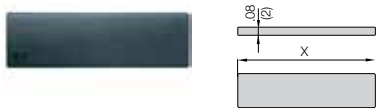

Full width shelf
Unassembled **Part No. 110-X**
Assembled **Part No. 111-X**

- **Full width shelf 110-X**
This component is used in applications with many thin cables with similar diameters.

Width X in. (mm)	Part No. Unassembled	Part No. Assembled	Width X in. (mm)	Part No. Unassembled	Part No. Assembled	Width X in. (mm)	Part No. Unassembled	Part No. Assembled
.39 (010)	110-10	111-10	.79 (020)	110-20	111-20	1.97 (050)	110-50	111-50
.51 (013)	110-13	111-13	1.18 (030)	110-30	111-30			
.63 (016)	110-16	111-16	1.57 (040)	110-40	111-40			

Mounting Brackets



Plastic, one-piece

- One-piece mounting bracket
- Corrosion resistant
- Available preassembled
- Inner and outer attachment possible
- Available with or without strain relief tiewrap plates

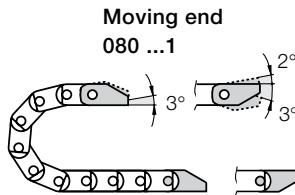

**Fixed end
080...2**

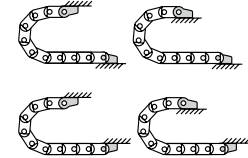

Possible installation configurations -

Part Number Structure

080- 20- 12 PZ

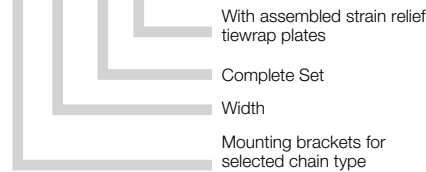

Full set, for both ends:

080- 20- 12 Full set, each part with pin/bore

Single-part order:

080- 20- 1 Mounting bracket with bore

080- 20- 2 Mounting bracket with pin

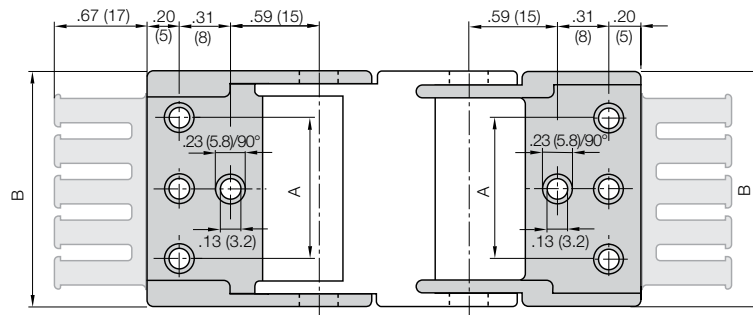

080-10-12 - 080-20-12: Center bores only

080-30-12 - 080-50-12: Outer bores only

Chain Type	Part No. Full set with Tiewrap Plate	Part No. Full Set without Tiewrap Plate	Dimension A in. (mm)	Dimensions B in. (mm)	Number of Teeth
08-10	080-10-12PZ	080-10-12	—	.72 (18.2)	1
08-13	—	080-13-12	—	.83 (21.2)	—
08-16	080-16-12PZ	080-16-12	—	.95 (24.2)	2
08-20	080-20-12PZ	080-20-12	—	1.11 (28.2)	2
08-30	080-30-12PZ	080-30-12	.87 (22)	1.50 (38.2)	3
08-40	080-40-12PZ	080-40-12	1.26 (32)	1.90 (48.2)	4
08-50	080-50-12PZ	080-50-12	1.65 (42)	2.29 (58.2)	5



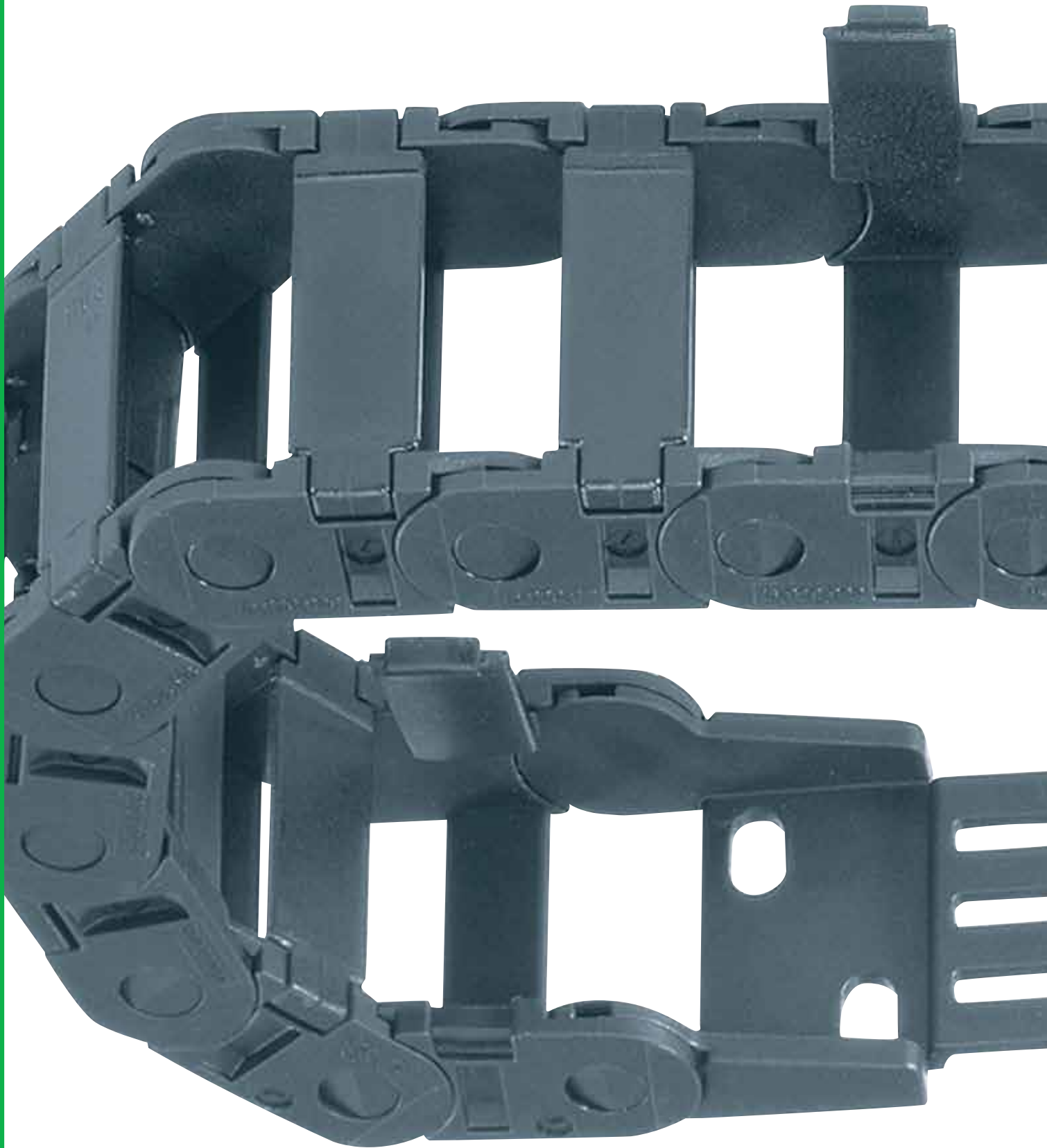

igus® E2 Mini



E2 mini - Small sized e-chains

System E2 mini is low-cost and can come equipped with interior separation to prevent cables from chaffing, twisting and corkscrewing. These e-chains can be used in applications with long, unsupported lengths and offer a variety of different connection options

Typical industries and applications

- Construction machinery
- Furniture
- Packaging machines
- Textile machines
- Vehicle construction
- Woodworking machines
- Glass machines
- Automation
- General machinery



Special equipment: Electrically conductive
ESD/ATEX version upon request



Cleanroom Class 1 (ISO class 3) for Series 10, tested
by the Dryden Engineering Company, California



Flammability Class
VDE 0304 IIC UL94 HB





E2 mini e-chain®, RBR-version with reverse bending radius



E2 mini e-chain® in a tooling machine, coolant resistant



Long-travel applications up to 131 ft. (40 m) are possible
- here: Series 10 in textile machine

e-chain system® E2 Mini Selection Guide

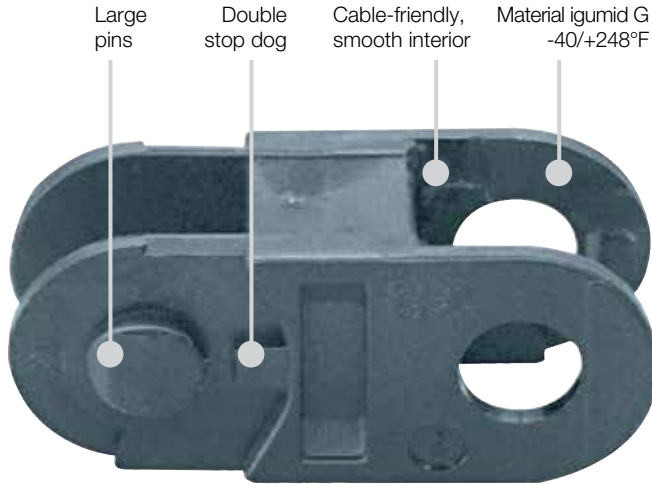

- Small pitch for smooth running
- High torsional rigidity
- Double stop dog and large pins for long service life
- Optimized relationship: weight - stability
- Large pins for long unsupported lengths
- Easy to assemble
- Various interior separation options
- You can find more technical data about the material, chemical resistance, temperatures **Design, Chapter 1**

E2 Mini - one-piece e-chains® One-piece, non snap-open



Series	Inner height <i>hi</i>		Inner width <i>Bi</i>		Outer width <i>Ba</i>		Outer height <i>ha</i>		Bending radius <i>R</i>	
	in.	(mm)	in.	(mm)	in.	(mm)	in.	(mm)	in.	(mm)
10	.71	(18)	.59-3.94	(15-100)	1.02-4.45	(26-113)	.91	(23)	1.10-7.09	(028-180)
11.031	.91	(23)	1.22	(31)	1.62	(41.2)	1.10	(28)	1.77-2.76	(045-070)
11.080	1.10	(28)	3.15	(80)	3.66	(93)	1.31	(33.4)	1.50-2.56	(038-065)
11.1/11.2	1.61	(41)	.59-.98	(15-25)	1.00-1.40	(25.5-35.5)	1.81	(46)	1.57-3.94	(040-100)

E2 Mini - one-piece e-chains® Snap-open along the inner radius with film-hinge



Series	Inner height <i>hi</i>		Inner width <i>Bi</i>		Outer width <i>Ba</i>		Outer height <i>ha</i>		Bending radius <i>R</i>	
	in.	(mm)	in.	(mm)	in.	(mm)	in.	(mm)	in.	(mm)
14	.79	(20)	.59-1.97	(15-50)	1.02-2.40	(26-61)	.98	(25)	1.10-4.92	(028-125)
F17	1.26	(32)	.59	(15)	1.02	(26)	1.54	(39)	1.89	(048)

E2 Mini - two-piece e-chains® Snap-open along the outer radius



Series	Inner height <i>hi</i>		Inner width <i>Bi</i>		Outer width <i>Ba</i>		Outer height <i>ha</i>		Bending radius <i>R</i>	
	in.	(mm)	in.	(mm)	in.	(mm)	in.	(mm)	in.	(mm)
B15	.67	(17)	.59-3.94	(15-100)	1.02-4.45	(26-113)	.91	(23)	1.50-7.09	(038-180)
B17	1.26	(32)	.59-3.94	(15-100)	1.00-4.45	(25.5-113)	1.54	(39)	1.89-4.92	(048-125)

E2 Mini - two-piece e-chains® Snap-open along the inner radius



Series	Inner height <i>hi</i>		Inner width <i>Bi</i>		Outer width <i>Ba</i>		Outer height <i>ha</i>		Bending radius <i>R</i>	
	in.	(mm)	in.	(mm)	in.	(mm)	in.	(mm)	in.	(mm)
B15i	.67	(17)	.59-3.94	(15-100)	1.02-4.45	(26-113)	.91	(23)	1.50-7.09	(038-180)
B17i	1.26	(32)	.98-1.50	(25-38)	1.40-1.91	(35.5-48.5)	1.54	(39)	1.89-4.92	(048-125*)



Available from stock. **Orders ship as early as today.***

*On average 90% of orders ship the same day..

e-chain system® E2 Mini Assembly Instructions

Assembling | E2 mini

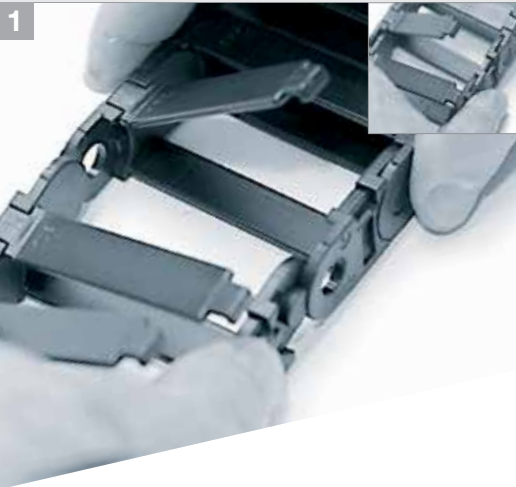

Push, click and snap in pin



Push and snap crossbars

Separating | E2 mini



Lever crossbars open



Open crossbars



Release side link



Twist and pull apart

Price Index

Series 10

Special Features / Options

Cleanroom Class 1 (ISO class 3)

ESD Classification:
 Electrically conductive ESD/
 ATEX version upon request

Assembly Tips

Easy to assemble and disassemble

Usage Guidelines

- If snap-open links are not necessary
- If a small but very stable chain is required



- If snap-open links are necessary
 - **Series 15 "Zipper"**
- If quick insertion of cables with preassembled connector is required
 - **Series E14 E-Z Chain**

Features & Benefits

- 1 Large pins and double stop dog for superior life and long unsupported length
- 2 Dirt repellent exterior
- 3 Mounting bracket with integrated strain relief
- 4 One piece link design
- 5 Interior separation available
- 6 Molded-in separator available

Series 10-050-075-S

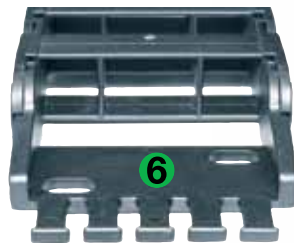
Order Example: Complete e-chain®

Please indicate chain length or number of links. Example:

3.28 ft (1 m) **10-025-038-0**
e-chain®
With 2 separators **111** assembled every 2nd link
 Interior Separation
1 Set **1025-12PZ**
Mounting Bracket

e-chain system® E2 Mini Series 10 Installation Dimensions

Short travel, unsupported length

- FL_B = unsupported with permitted sag
 - FL_G = unsupported with straight upper run
- Further information ► Design, Chapter 1

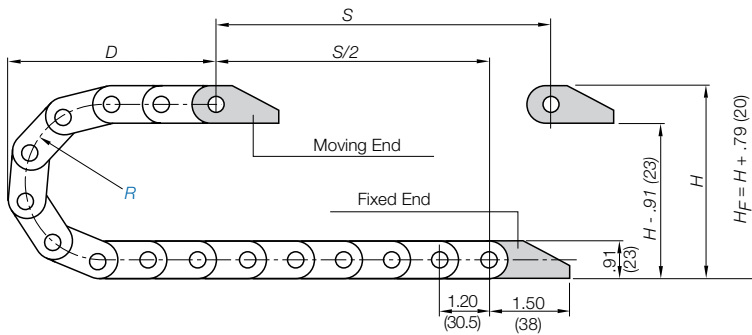
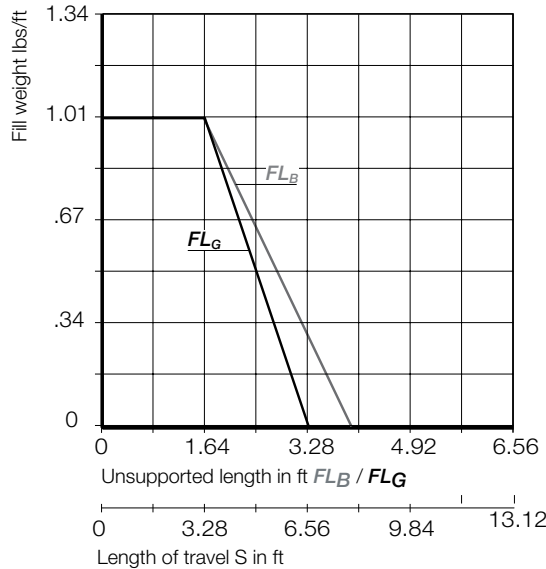
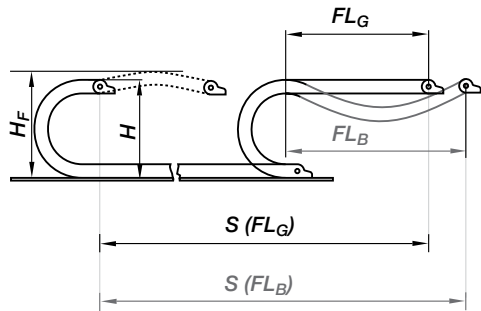

Pitch per link = 1.20" (30.5 mm)
 Links per ft (m) = 10.06 (33)
 For center mount applications:
 Chain length = $\frac{S}{2} + K$

The required clearance height: $H_F = H + .79$ in. (20 mm) (with 1.01 lbs/ft (1.5 kg/m) fill weight).
 Please consult igus® if space is particularly restricted.

R	1.10 (028)	1.50 (038)	1.89 (048)	2.95 (075)	3.94 (100)	4.33 (110)	4.92 (125)	5.71 (145)	7.09 (180)
H	3.11 (79)	3.90 (99)	4.69 (119)	6.81 (173)	8.78 (223)	9.57 (243)	10.75 (273)	12.32 (313)	15.08 (383)
D	3.35 (85)	3.74 (95)	4.3 (105)	5.20 (132)	6.18 (157)	6.57 (167)	7.16 (182)	7.95 (202)	9.33 (237)
K	5.91 (150)	7.28 (185)	8.46 (215)	11.81 (300)	14.96 (380)	16.14 (410)	17.91 (455)	20.47 (520)	24.80 (630)

Speed / acceleration FL_G	max. 65.6 ft/s (20 m/s) / max. 656 ft/s ² (200 m/s ²)
Speed / acceleration FL_B	max. 9.84 ft/s (3 m/s) / max. 19.69 ft/s ² (6 m/s ²)
Gliding speed / acceleration (maximum)	max. 9.84 ft/s (3 m/s) / max. 32.8 ft/s ² (10 m/s ²)
Material - permitted temperature	igumid G / -40°F (-40°C) up to +248°F (+120°C)
Flammability Class, igumid G	VDE 0304 IIC UL94 HB

Short Travels - Unsupported



Unsupported e-chains® feature positive camber over short travels. This must be accounted for when specifying the clearance height. Please refer to **Installation dimensions** for further details.

Legend

- S = Length of travel
- R = Bending radius
- H = Nominal clearance height
- D = Overlength e-chain® radius in final position
- $K = \pi \cdot R + \text{safety buffer}$
- H_F = Required clearance height



Technical Data



Details of material properties

► Chapter 1

Series 10 - e-chain® non snap-open

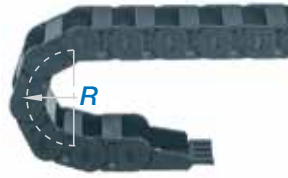
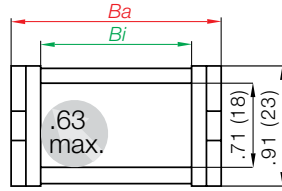

Part Number Structure

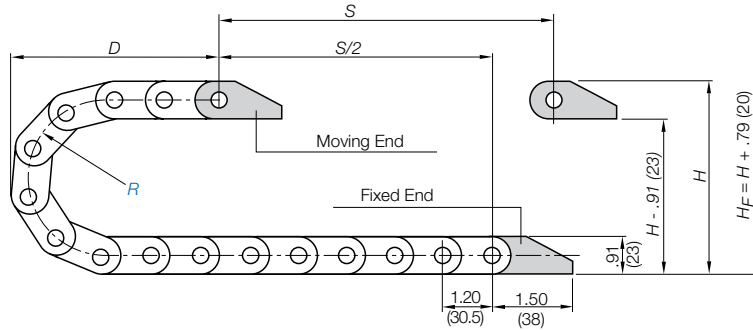
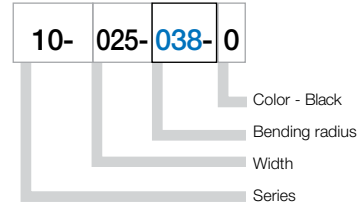

Supplement part number with required radius. Example: 10-025-**038**-0
Pitch: 1.20 in. (30.5 mm) per link links/ft (m) = 10.06 (33)

Part Number	<i>Bi</i> in. (mm)	<i>Ba</i> in. (mm)	Weight lbs/ft (kg/m)
10-015- <input type="checkbox"/> -0	.59 (15)	1.02 (26)	≈ 0.24 (0.35)
10-025- <input type="checkbox"/> -0	.98 (25)	1.42 (36)	≈ 0.27 (0.40)
10-038- <input type="checkbox"/> -0	1.50 (38)	1.93 (49)	≈ 0.31 (0.46)
10-050- <input type="checkbox"/> -0	1.97 (50)	2.40 (61)	≈ 0.35 (0.52)
10-5- <input type="checkbox"/> -0	2.48 (63)	2.99 (76)	≈ 0.42 (0.63)
10-6 <input type="checkbox"/> -0	3.15 (80)	3.70 (94)	≈ 0.47 (0.70)
10-7 <input type="checkbox"/> -0	3.94 (100)	4.45 (113)	≈ 0.51 (0.76)

Choose from the radii below for all of the above sizes

Radius (mm) Example: 10-025-**038**-0

	028	038	048	075	100	110	125	145	180
R	1.10 (028)	1.50 (038)	1.89 (048)	2.95 (075)	3.94 (100)	4.33 (110)	4.92 (125)	5.71 (145)	7.09 (180)
H	3.11 (79)	3.90 (99)	4.69 (119)	6.81 (173)	8.78 (223)	9.57 (243)	10.75 (273)	12.32 (313)	15.08 (383)
D	3.35 (85)	3.74 (95)	4.3 (105)	5.20 (132)	6.18 (157)	6.57 (167)	7.16 (182)	7.95 (202)	9.33 (237)
K	5.91 (150)	7.28 (185)	8.46 (215)	11.81 (300)	14.96 (380)	16.14 (410)	17.91 (455)	20.47 (520)	24.80 (630)

0=Standard color black. For other colors see Chapter 1

Interior Separation



Option 1: Vertical separators

Vertical separators are used if a vertical subdivision of the e-chain® interior is required. By standard, vertical separators are assembled every other e-chain® link.

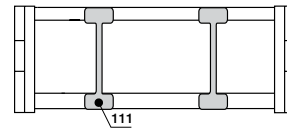
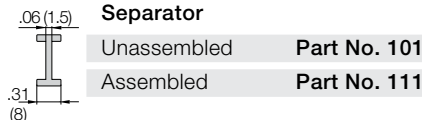

e-chain system® E2 Mini Series 10 Mounting Brackets - Plastic



Option 1: pivoting

- Short and long travel
- Space-restricted conditions
- Corrosion resistant

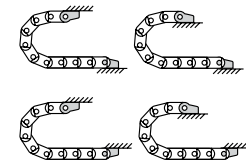
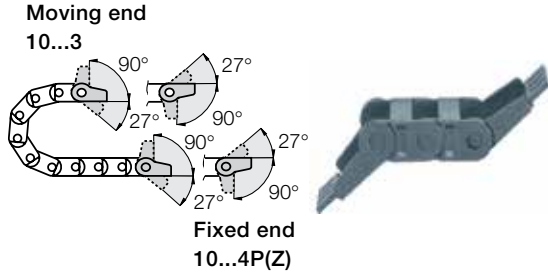

Possible installation configurations -

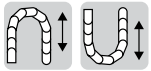

Option 2: locking

- Vertical hanging/standing travels
- Extreme accelerations
- Corrosion resistant

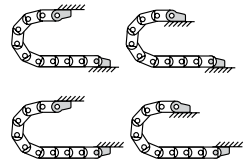
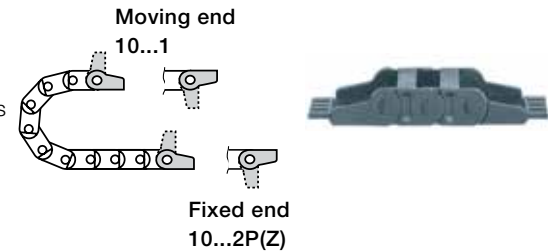

Possible installation configurations -

For e-chain
10-015 to 10-050

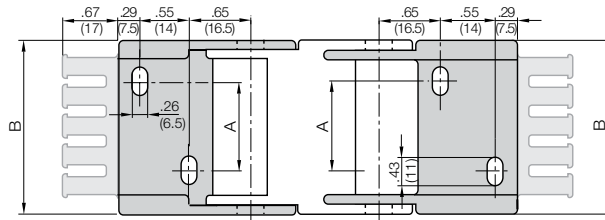

For e-chain
10-5 to 10-7

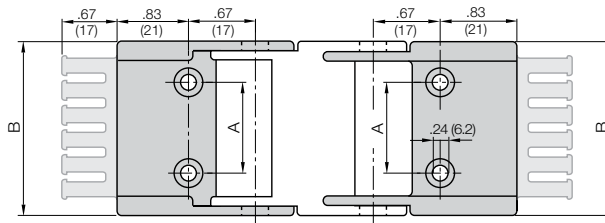

Part Number Structure

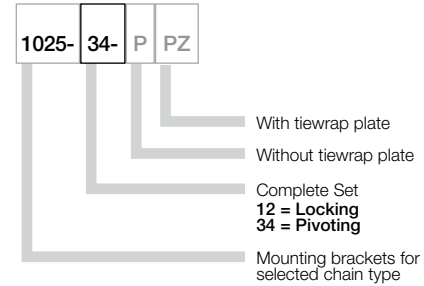

Part number examples are shown for pivoting brackets. For locking brackets fill in the blank with

Part No. Full Set (pivoting)
with Tiewrap Plate
Series 10 with 25mm inner width
1025-34PZ

Part No. Full Set (pivoting)
without Tiewrap Plate
Series 10 with 25 mm inner width
1025-34P

Full set, for both ends:
 Full set, each part
with pin/bore + tiewrap plate

Single-part order:
 Mounting bracket with bore
+ tiewrap plate
 Mounting bracket with pin
+ tiewrap plate

For Chain Type	Part No. Full set with Tiewrap Plate	Part No. Full Set without Tiewrap Plate	Dimension A in. (mm)	Dimensions B in. (mm)
10-015	1015- <input type="text" value=""/> PZ	1015- <input type="text" value=""/> P	— —	1.00 (25.5)
10-025	1025- <input type="text" value=""/> PZ	1025- <input type="text" value=""/> P	.39 (10)	1.40 (35.5)
10-038	1038- <input type="text" value=""/> PZ	1038- <input type="text" value=""/> P	.91 (23)	1.91 (48.5)
10-050	1050- <input type="text" value=""/> PZ	1050- <input type="text" value=""/> P	1.38 (35)	2.38 (60.5)
10-5	105- <input type="text" value=""/> PZ	105- <input type="text" value=""/> P	1.89 (48)	2.95 (75.0)
10-6	106- <input type="text" value=""/> PZ	106- <input type="text" value=""/> P	2.56 (65)	3.62 (92.0)
10-7	107- <input type="text" value=""/> PZ	107- <input type="text" value=""/> P	3.35 (85)	4.41 (112.0)

For pivoting brackets choose
For locking brackets choose
Example: 1025- PZ



One-piece guide troughs made of steel are available for the Series 10 Energy Chains®. These guide troughs are available from stock for outer chain widths up to 4.45 in. (113 mm). For wider e-chains® and Tubes, special solutions are possible with short lead times. No installation sets are required for these trough sizes since the guide troughs consist of a one-piece U-profile. The joint connection with this type of guide trough is specified individually for every application.

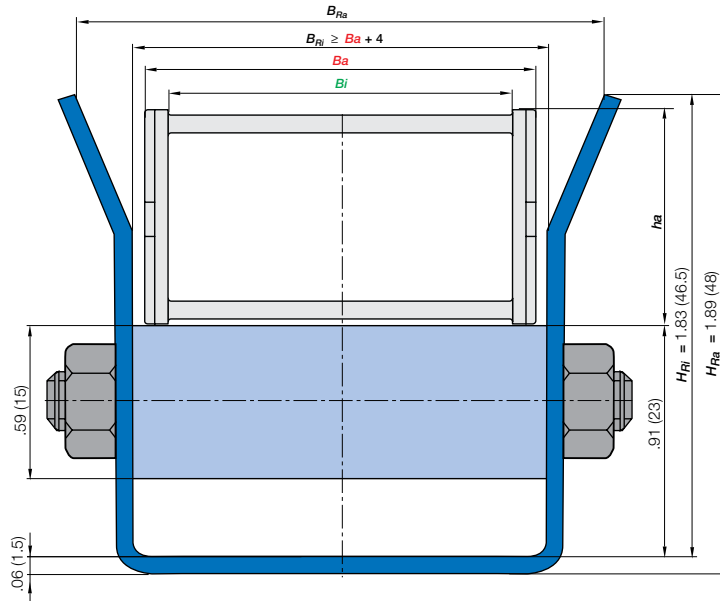

Dimensions Guide troughs 91-10 — 91-71

For Series	Part No.	BRa		BRi		Weight	
		in.	(mm)	in.	(mm)	lbs/ft	(kg/m)
10-015							
Trough without glide bar 6.56 ft. (2m section)	91-10	1.59	(40.5)	1.18	(30)	1.01	(1.50)
Glide bar 6.56 ft. (2m section)	91-11	1.59	(40.5)	1.18	(30)	.30	(.45)
10-025							
Trough without glide bar 6.56 ft. (2m section)	91-20	1.99	(50.5)	1.57	(40)	1.11	(1.65)
Glide bar 6.56 ft. (2m section)	91-21	1.99	(50.5)	1.57	(40)	.38	(.57)
10-038							
Trough without glide bar 6.56 ft. (2m section)	91-30	2.46	(62.5)	2.05	(52)	1.21	(1.80)
Glide bar 6.56 ft. (2m section)	91-31	2.46	(62.5)	2.05	(52)	.46	(.68)
10-050							
Trough without glide bar 6.56 ft. (2m section)	91-40	2.85	(72.5)	2.44	(62)	1.28	(1.90)
Glide bar 6.56 ft. (2m section)	91-41	2.85	(72.5)	2.44	(62)	.61	(.91)
10-5							
Trough without glide bar 6.56 ft. (2m section)	91-50	3.60	(91.5)	3.19	(81)	1.52	(2.26)
Glide bar 6.56 ft. (2m section)	91-51	3.60	(91.5)	3.19	(81)	.84	(1.25)
10-6							
Trough without glide bar 6.56 ft. (2m section)	91-60	4.27	(108.5)	3.86	(98)	1.83	(2.72)
Glide bar 6.56 ft. (2m section)	91-61	4.27	(108.5)	3.86	(98)	.91	(1.35)
10-7							
Trough without glide bar 6.56 ft. (2m section)	91-70	5.06	(128.5)	4.65	(118)	2.13	(3.17)
Glide bar 6.56 ft. (2m section)	91-71	5.06	(128.5)	4.65	(118)	1.14	(1.70)

Trough material in general: St 1203 galvanized



PDF: igus.com/e-chain-pdfs
Product information: igus.com/e-chains



Price Index

Series 11.031

Special Features / Options

ESD Classification:
Electrically conductive ESD
version upon request

Assembly Tips

Easy to assemble and disassemble

Usage Guidelines



- If space is restricted
- If many cables are arranged vertically adjacent



- If snap-open links are required
 - similar width/height from Series "Zipper"
- If quick insertion of cables with preassembled connector is required
 - similar width/height from Series E-Z Chain

Features & Benefits

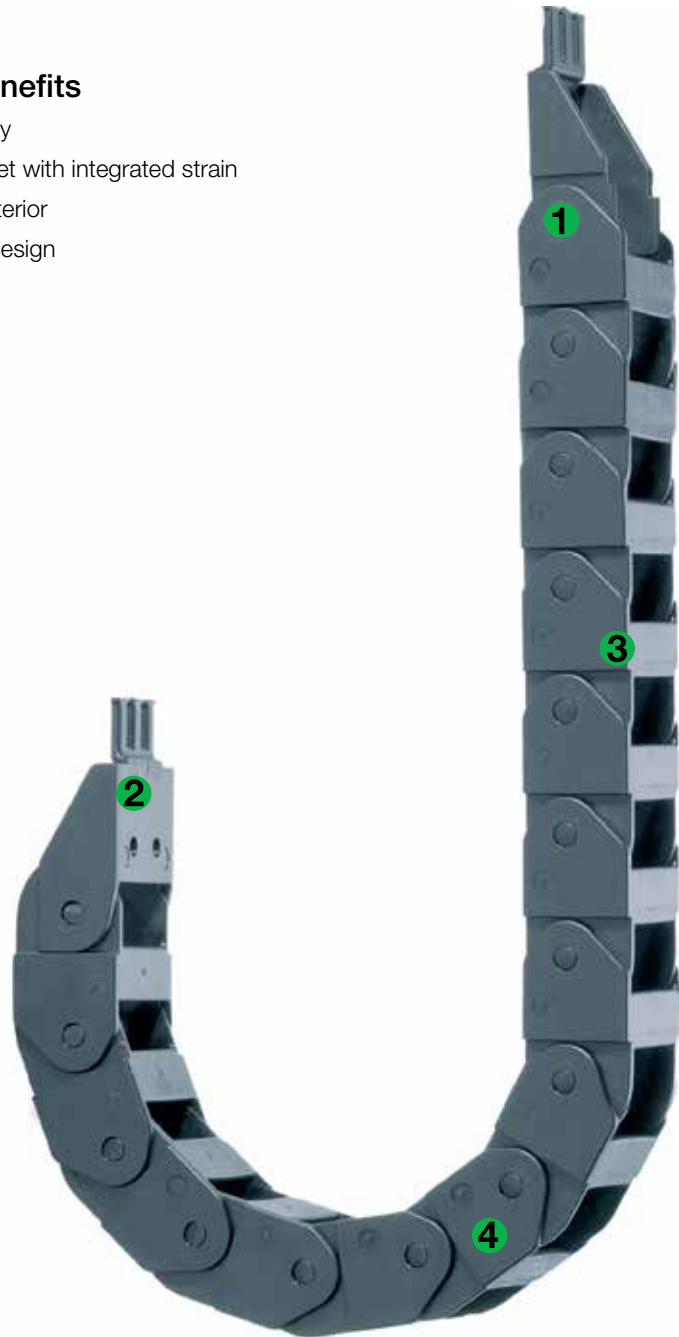
- 1 Torsional stability
- 2 Mounting bracket with integrated strain
- 3 Dirt repellent exterior
- 4 One piece link design

Order Example: Complete e-chain®

Please indicate chain length or number of links. Example:

3.28 ft (1 m) 11.031.070.0



e-chain®

1 Set 11.031.12PZ



Mounting Bracket

e-chain system® E2 Mini Series 11.031 Installation Dimensions

Short travel, unsupported length

- FL_B = unsupported with permitted sag
 - FL_G = unsupported with straight upper run
- Further information ► Design, Chapter 1

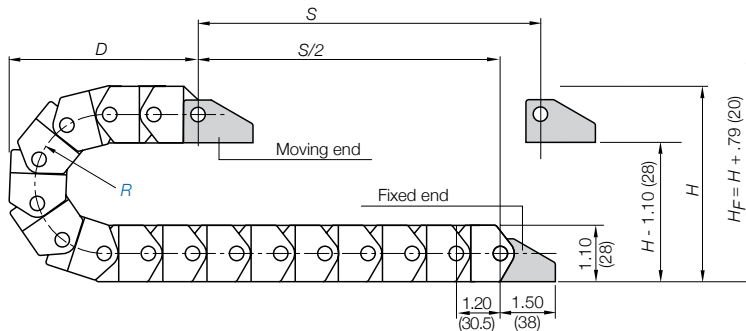
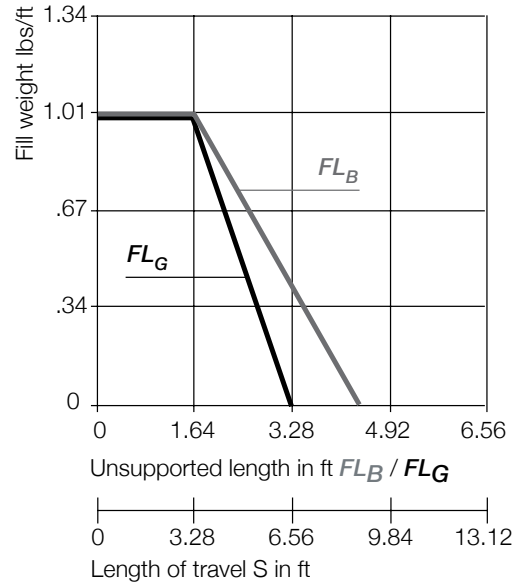
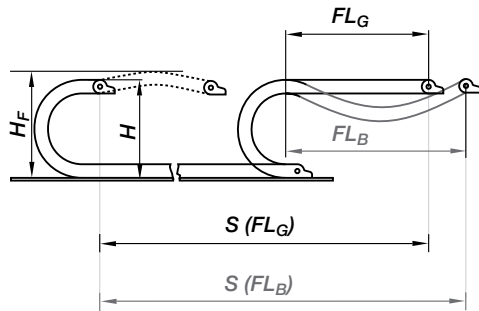

Pitch per link = 1.20" (30.5 mm)
Links per ft (m) = 10.06 (33)
For center mount applications:
Chain length = $\frac{S}{2} + K$

The required clearance height: $H_F = H + .79$ in. (20 mm) (with .34 lbs/ft (0.5 kg/m) fill weight). Please consult igus® if space is particularly restricted.

R	1.77 (045)	2.76 (070)
H	4.84 (123)	6.81 (173)
D	3.54 (107)	5.20 (132)
K	8.07 (205)	11.22 (285)



11.031

Short Travels - Unsupported



Unsupported e-chains® feature positive camber over short travels. This must be accounted for when specifying the clearance height. Please refer to **Installation dimensions** for further details.

Legend

- S = Length of travel
- R = Bending radius
- H = Nominal clearance height
- D = Overlength e-chain® radius in final position
- $K = \pi \cdot R + \text{safety buffer}$
- H_F = Required clearance height



PDF: igus.com/e-chain-pdfs
Product information: igus.com/e-chains



Speed / acceleration FL_G	max. 65.6 ft/s (20 m/s) / max. 656 ft/s ² (200 m/s ²)
Speed / acceleration FL_B	max. 9.84 ft/s (3 m/s) / max. 19.69 ft/s ² (6 m/s ²)
Gliding speed / acceleration (maximum)	max. 9.84 ft/s (3 m/s) / max. 32.8 ft/s ² (10 m/s ²)
Material - permitted temperature	igumid G / -40°F (-40°C) up to +248°F (+120°C)
Flammability Class, igumid G	VDE 0304 IIC UL94 HB

Technical Data



Details of material properties

► Chapter 1

Series 11.031 - e-chain® non snap-open

igus®
 e-chain system®

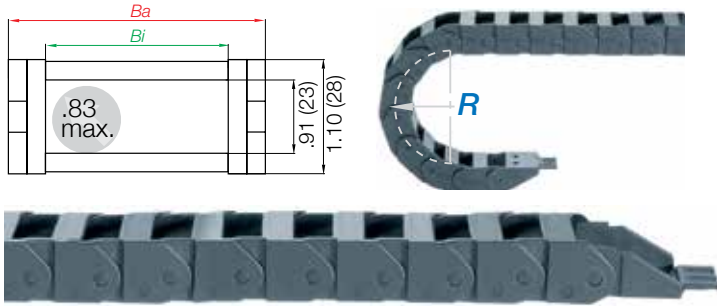

Part Number Structure

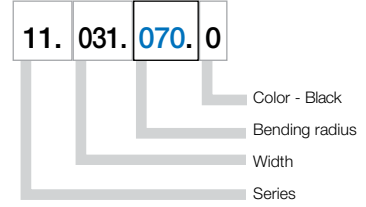

Telephone 1-800-521-2747

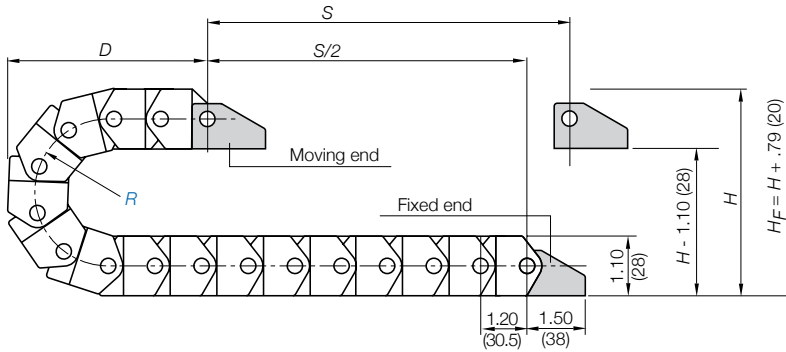

Supplement part number with required radius. Example: 11.031. **070** .0
 Pitch: 1.20 in. (30.5 mm) per link links/ft (m) = 10.06 (33)

Part Number	<i>Bi</i> in. (mm)	<i>Ba</i> in. (mm)	Weight lbs/ft (kg/m)
11.031. <input type="text"/> .0	1.22 (31)	1.62 (41.2)	≈ 0.29 (0.43)
Choose from the radii below for all of the above sizes Radius (mm) Example: 11.031. 070 .0			

	045	070
R	1.77 (045)	2.76 (070)
H	4.84 (123)	6.81 (173)
D	3.54 (107)	5.20 (132)
K	8.07 (205)	11.22 (285)

0=Standard color black. For other colors see Chapter 1

Internet: igus.com
 email: sales@igus.com
 QuickSpec: igus.com/quickspec

Standard

Option: pivoting

- Short and long travel
- Space-restricted conditions
- Corrosion resistant

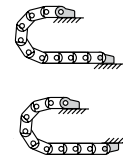
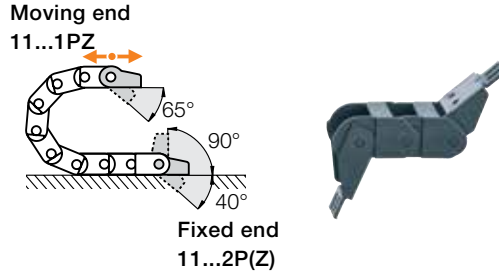

Possible installation configurations -

Moving end
11...1PZ

Fixed end
11...2P(Z)

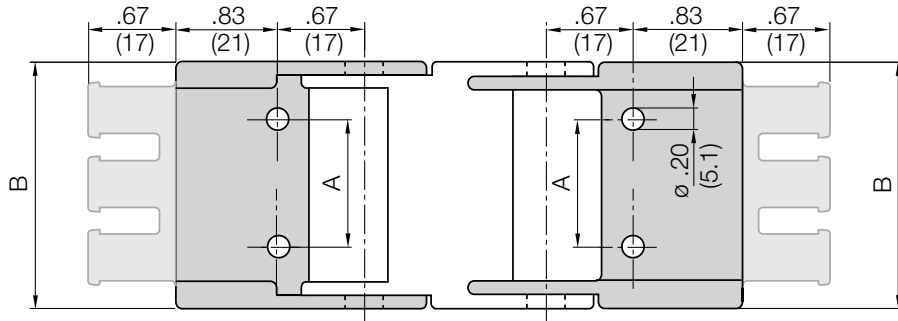

Part Number Structure

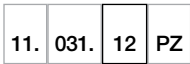

- With tiwrap plate
- Complete Set = 12
- Width
- Mounting brackets for selected chain type

Full set, for both ends:

11.031.12 PZ Full set, each part with pin/bore + tiwrap plate

Single-part order:

11.031.1 PZ Mounting bracket with bore + tiwrap plate

11.031.2 PZ Mounting bracket with pin + tiwrap plate

For Chain Type	Part No.	Part No.	Dimension A		Dimensions B		Number of teeth
	Full set with Tiwrap Plate	Full Set without Tiwrap Plate	in.	(mm)	in.	(mm)	
11.031	11.031.12 PZ	11.031.12P	.63	(16)	1.65	(42)	3

PDF: igus.com/e-chain-pdfs
Product information: igus.com/e-chains



Price Index

Series 11.080

Special Features / Options

ESD Classification:
Electrically conductive ESD
version upon request

Assembly Tips

Easy to assemble and disassemble

Usage Guidelines



- If space is restricted
- If many cables are arranged vertically adjacent



- If snap-open links are required
 - similar width/height from Series "Zipper"
- If quick insertion of cables with preassembled connector is required
 - similar width/height from Series E-Z Chain

Features & Benefits

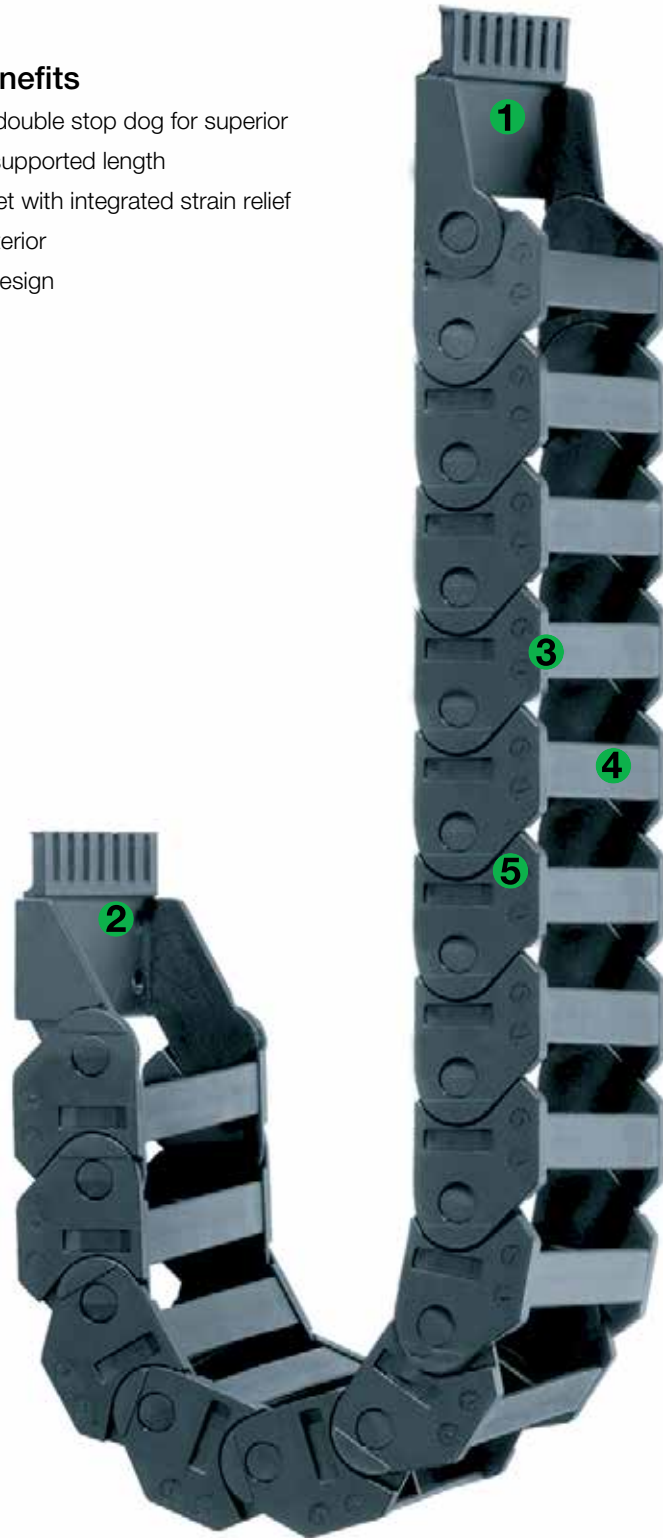
- ➊ Large pins and double stop dog for superior life and long unsupported length
- ➋ Mounting bracket with integrated strain relief
- ➌ Dirt repellent exterior
- ➍ One piece link design
- ➎ Stable design

Order Example: Complete e-chain®

Please indicate chain length or number of links. Example:

3.28 ft (1 m) 11.080.038.0



e-chain®

1 Set 11.080.12PZ



Mounting Bracket

e-chain system® E2 Mini Series 11.080 Installation Dimensions

Short travel, unsupported length

- FL_B = unsupported with permitted sag
- FL_G = unsupported with straight upper run

Further information ► Design, Chapter 1

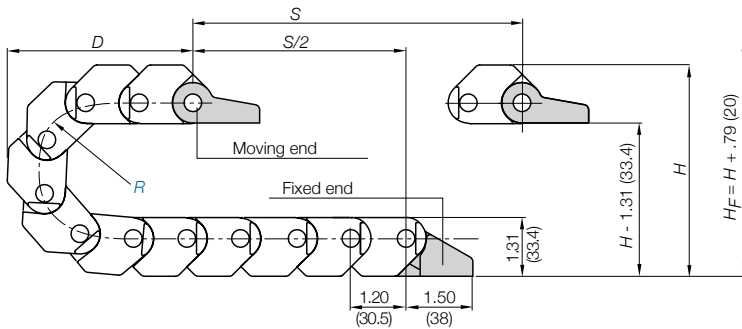
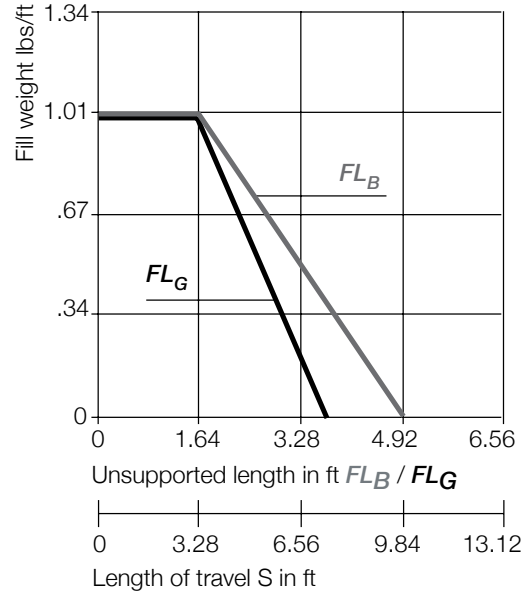
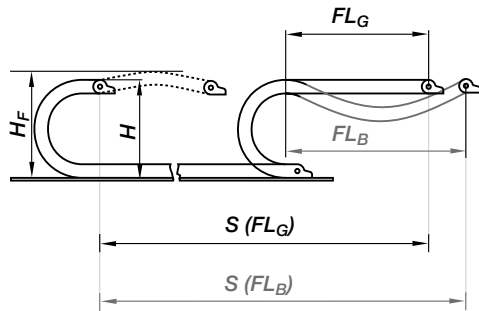

Pitch per link = 1.20" (30.5 mm)

Links per ft (m) = 10.06 (33)

For center mount applications:

Chain length = $\frac{S}{2} + K$

The required clearance height: $H_F = H + .79$ in. (20 mm) (with .34 lbs/ft (0.5 kg/m) fill weight. Please consult igus® if space is particularly restricted.

R	1.50 (038)	2.56 (065)
H	4.69 (119)	6.81 (173)
D	4.13 (105)	5.20 (132)
K	7.28 (185)	10.63 (270)

igus®

11.080

Short Travels - Unsupported



Unsupported e-chains® feature positive camber over short travels. This must be accounted for when specifying the clearance height. Please refer to **Installation dimensions** for further details.

Legend

- S = Length of travel
- R = Bending radius
- H = Nominal clearance height
- D = Overlength e-chain® radius in final position
- $K = \pi \cdot R + \text{safety buffer}$
- H_F = Required clearance height

1.10

PDF: igus.com/e-chain-pdfs
Product information: igus.com/e-chains



Speed / acceleration FL_G	max. 65.6 ft/s (20 m/s) / max. 656 ft/s ² (200 m/s ²)
Speed / acceleration FL_B	max. 9.84 ft/s (3 m/s) / max. 19.69 ft/s ² (6 m/s ²)
Gliding speed / acceleration (maximum)	max. 9.84 ft/s (3 m/s) / max. 32.8 ft/s ² (10 m/s ²)
Material - permitted temperature	igumid G / -40°F (-40°C) up to +248°F (+120°C)
Flammability Class, igumid G	VDE 0304 IIC UL94 HB

Technical Data



Details of material properties

► Chapter 1

4.68

Series 11.080 - e-chain® non openable.
With molded in vertical separation

igus®
e-chain system®

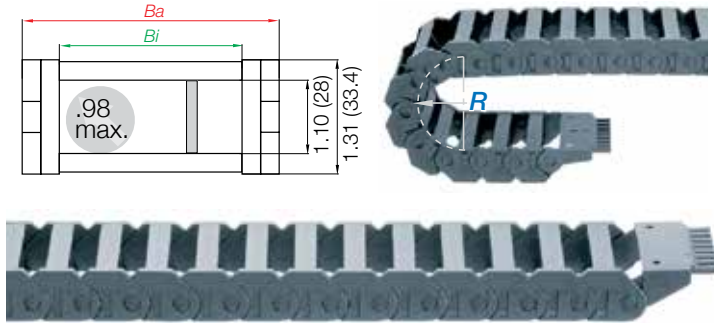

Part Number Structure

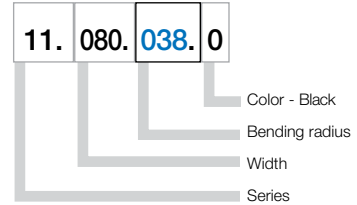

Telephone 1-800-521-2747

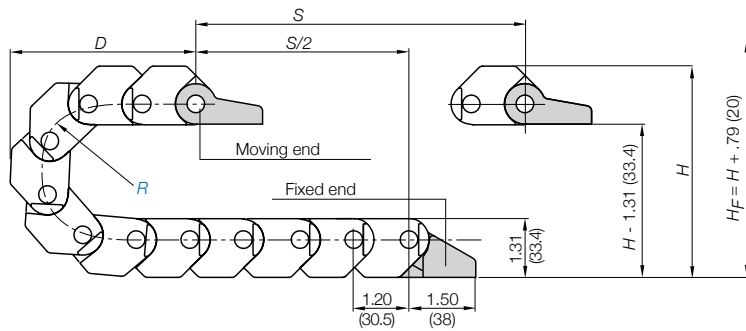

Supplement part number with required radius. Example: 11.080. **038** .0
Pitch: 1.20 in. (30.5 mm) per link links/ft (m) = 10.06 (33)

Part Number	Bi in. (mm)	Ba in. (mm)	Chamber Design	A in. (mm)	B in. (mm)	Weight lbs/ft (kg/m)
11.080. <input type="text"/> .0	3.15 (80)	3.66 (93)		1.81 (46)	1.26 (32)	≈ 0.49 (0.73)
Choose from the radii below for all of the above sizes Radius (mm) Example: 11.080. 038 .0						

	038	065
R	1.50 (38)	2.56 (65)
H	4.69 (119)	6.81 (173)
D	4.13 (105)	5.20 (132)
K	7.28 (185)	10.63 (270)

0=Standard color black. For other colors see Chapter 1

Internet: igus.com
email: sales@igus.com
QuickSpec: igus.com/quickspec

e-chain system® E2 Mini

Series 11.080

Mounting Brackets - plastic one piece - pivoting



11.080

Standard

Option: pivoting

- Short and long travel
- Space-restricted conditions
- Corrosion resistant

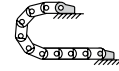
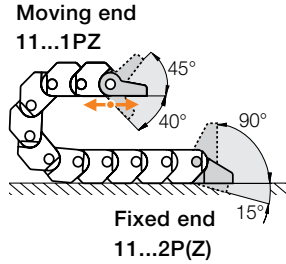

Possible installation configurations -

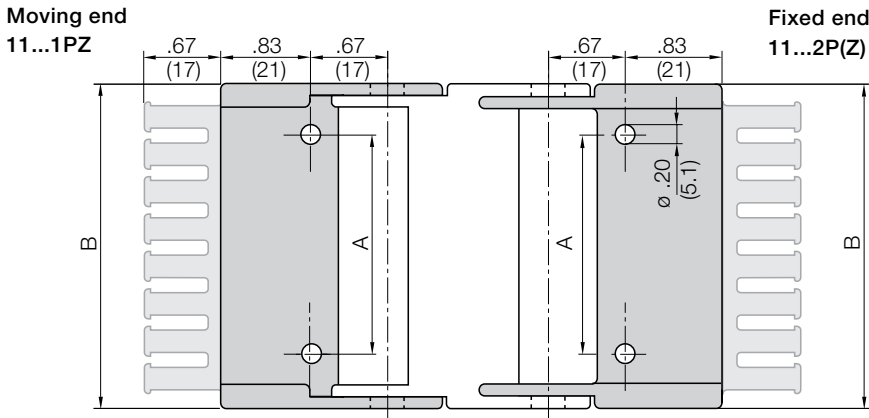

Part Number Structure

11.	080.	12	PZ
-----	------	----	----

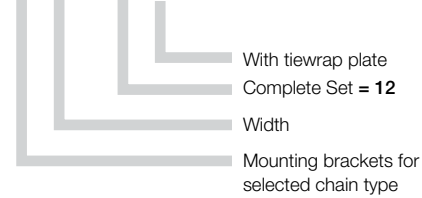

Full set, for both ends:

11.080.12.PZ Full set, each part with pin/bore + tiewrap plate

Single-part order:

11.080.1.PZ Mounting bracket with bore + tiewrap plate

11.080.2.PZ Mounting bracket with pin + tiewrap plate

For Chain Type	Part No. Full set with Tiewrap Plate	Part No. Full Set without Tiewrap Plate	Dimension A in. (mm)	Dimension B in. (mm)	Number of teeth
11.080	11.080.12PZ	11.080.12P	2.56 (65)	3.66 (93)	8

PDF: igus.com/e-chain-pdfs
Product information: igus.com/e-chains



Price Index



Series 11.1/11.2

Special Features / Options



ESD Classification:
Electrically conductive ESD
version upon request

Assembly Tips



Easy to assemble and disassemble

Usage Guidelines



- If space is restricted
- If many cables are arranged vertically adjacent



- If snap-open links are required
 - similar width/height from Series "Zipper"
- If quick insertion of cables with preassembled connector is required
 - similar width/height from Series E-Z Chain

Features & Benefits

- 1 Enlarged inner height
- 2 Mounting bracket with integrated strain
- 3 Dirt repellent exterior
- 4 One piece link design

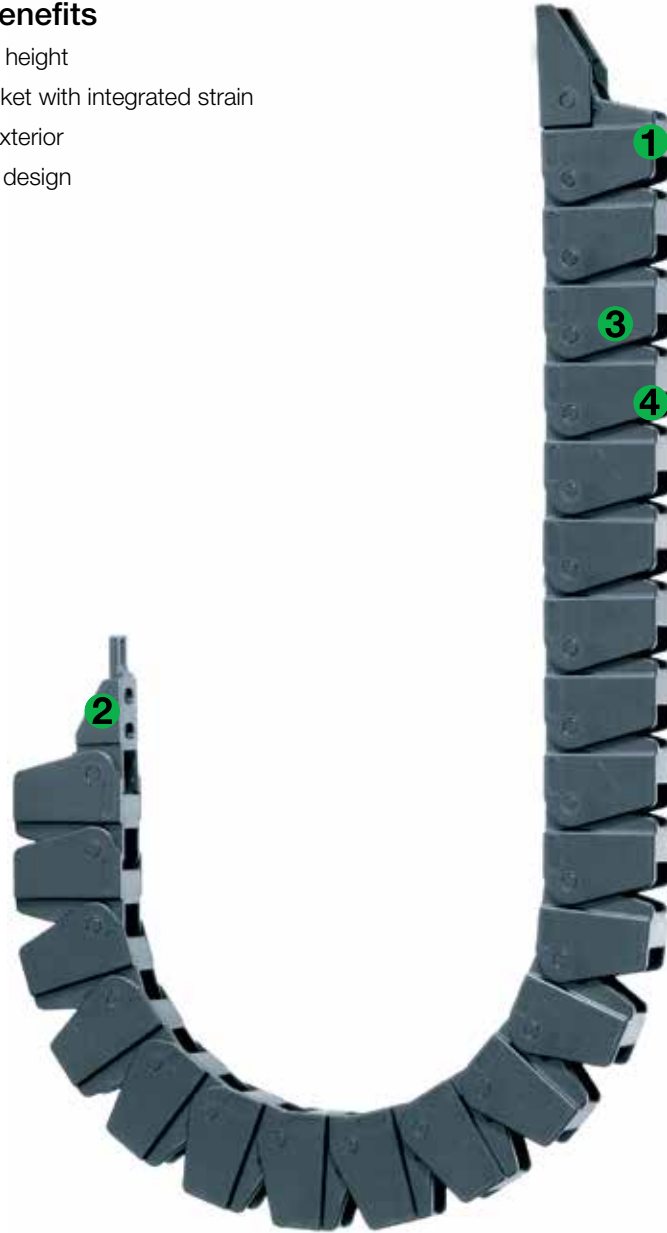

Order Example: Complete e-chain®

Please indicate chain length or number of links. Example:

3.28 ft (1 m) 11.2.100.0

e-chain®

1 Set 102.12PZ

Mounting Bracket

e-chain system® E2 Mini Series 11.1 / 11.2 Installation Dimensions

Short travel, unsupported length

- FL_B = unsupported with permitted sag
 - FL_G = unsupported with straight upper run
- Further information ► Design, Chapter 1

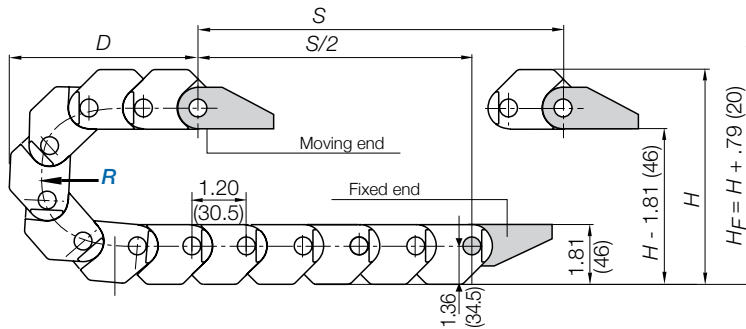
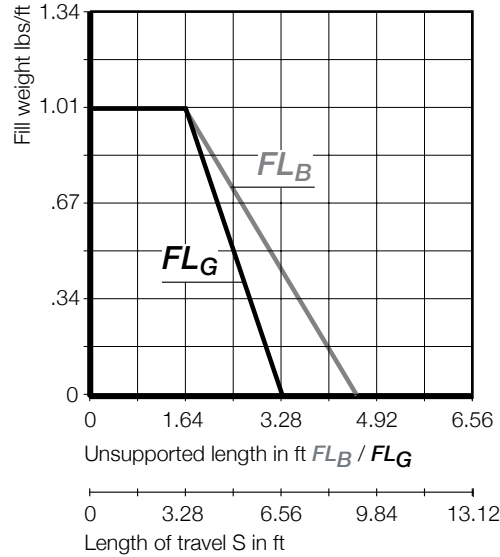
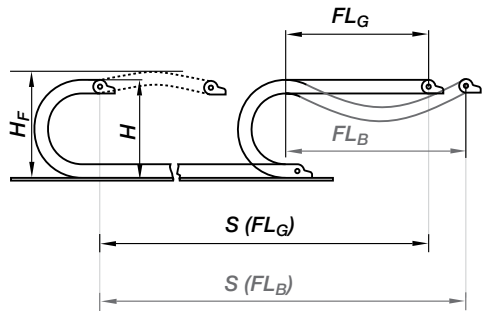

Pitch per link = 1.20" (30.5 mm)
 Links per ft (m) = 10.06 (33)
 For center mount applications:
 Chain length = $\frac{S}{2} + K$

The required clearance height: $H_F = H + .79$ in. (20 mm) (with .34 lbs/ft (0.5 kg/m) fill weight).
 Please consult igus® if space is particularly restricted.

R	1.57 (040)	2.48 (063)	2.95 (075)	3.94 (100)
H	5.87 (149)	7.68 (195)	8.62 (219)	10.59 (269)
D	4.72 (120)	5.63 (143)	6.10 (155)	7.09 (180)
K	7.48 (190)	10.24 (260)	11.81 (300)	14.96 (380)



11.2
11.2

Short Travels - Unsupported



Unsupported e-chains® feature positive camber over short travels. This must be accounted for when specifying the clearance height. Please refer to **Installation dimensions** for further details.

Legend

- S = Length of travel
- R = Bending radius
- H = Nominal clearance height
- D = Overlength e-chain® radius in final position
- $K = \pi \cdot R + \text{safety buffer}$
- H_F = Required clearance height

1.61

PDF: igus.com/e-chain-pdfs
 Product information: igus.com/e-chains



Speed / acceleration FL_G	max. 65.6 ft/s (20 m/s) / max. 656 ft/s ² (200 m/s ²)
Speed / acceleration FL_B	max. 9.84 ft/s (3 m/s) / max. 19.69 ft/s ² (6 m/s ²)
Gliding speed / acceleration (maximum)	max. 9.84 ft/s (3 m/s) / max. 32.8 ft/s ² (10 m/s ²)
Material - permitted temperature	igumid G / -40°F (-40°C) up to +248°F (+120°C)
Flammability Class, igumid G	VDE 0304 IIC UL94 HB

Technical Data



Details of material properties

► Chapter 1

4.72

Series 11.1/11.2 - e-chain® one-piece, non-openable

igus®
e-chain system®

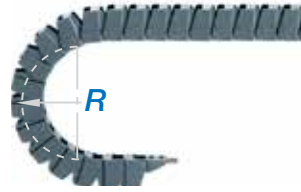
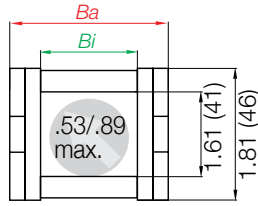

Part Number Structure



- Color - Black
- Bending radius
- Width
- Series

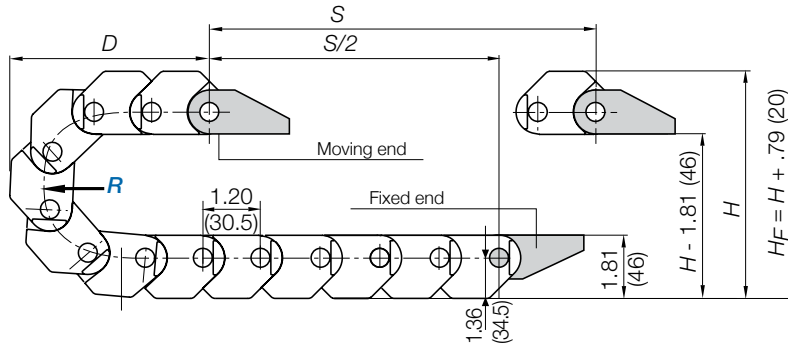

Supplement part number with required radius. Example: 11.1..0
Pitch: 1.20 in. (30.5 mm) per link links/ft (m) = 10.06 (33)

Part Number	Bi in. (mm)	Ba in. (mm)	Weight lbs/ft (kg/m)
11.1. <input type="text" value=""/> .0	.59 (15)	1.00 (25.5)	≈ 0.33 (0.50)
11.2. <input type="text" value=""/> .0	.98 (25)	1.40 (35.5)	≈ 0.35 (0.53)

Choose from the radii below for all of the above sizes
Radius (mm) Example: 11.1..0

	040	063	075	100
R	1.57 (040)	2.48 (063)	2.95 (075)	3.94 (100)
H	5.87 (149)	7.68 (195)	8.62 (219)	10.59 (269)
D	4.72 (120)	5.63 (143)	6.10 (155)	7.09 (180)
K	7.48 (190)	10.24 (260)	11.81 (300)	14.96 (380)

0=Standard color black. For other colors see Chapter 1

Telephone 1-800-521-2747

Internet: igus.com
email: sales@igus.com
QuickSpec: igus.com/quickspec

e-chain system® E2 Mini

Series 11.1 / 11.2

Mounting Brackets - plastic one piece - locking



11.2
11.2

Standard

Option: locking

- Short and long travel
- Space-restricted conditions
- Corrosion resistant

Moving end
10...1PZ

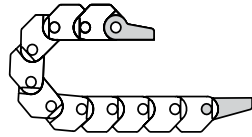

Fixed end
10...2P(Z)

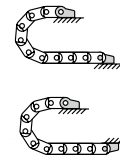

Possible installation configurations -

Moving end
10...1PZ

Fixed end
10...2P(Z)

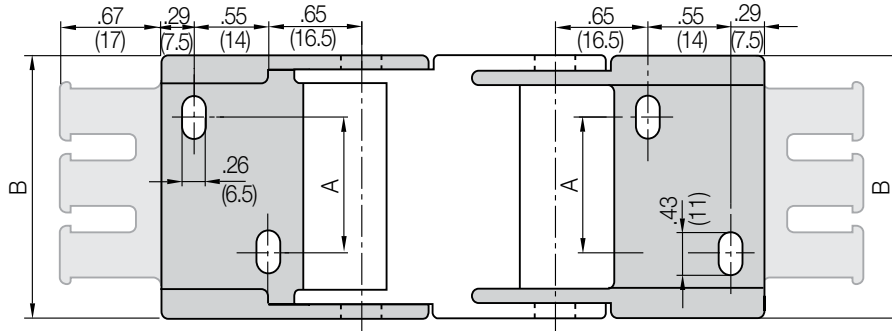

Part Number Structure

101. 12 PZ

- With tiewrap plate
- Complete Set = 12
- Mounting brackets for selected chain type

Full set, for both ends:

101.12.PZ Full set, each part with pin/bore + tiewrap plate

Single-part order:

101.1.PZ Mounting bracket with bore + tiewrap plate

101.2.PZ Mounting bracket with pin + tiewrap plate

For Chain Type	Part No. Full set with Tiewrap Plate	Part No. Full Set without Tiewrap Plate	Dimension A in. (mm)	Dimensions B in. (mm)	Number of teeth
11.1	101.12PZ	101.12P	- -	1.02 (26)	2
11.2	102.12PZ	102.12P	.39 (10)	1.42 (36)	3

PDF: igus.com/e-chain-pdfs
Product information: igus.com/e-chains



Price Index

Series 14

Special Features / Options

Cleanroom Class 1 (ISO class 3)

ESD Classification:
Electrically conductive ESD/
ATEX version upon request

UL94-V2 Classifications

Assembly Tips

Easy to assemble and disassemble

Usage Guidelines

- For applications with low loads
- Fast installation of the cables



- For gliding applications
 - **Series 15 Zipper**
- For long unsupported lengths
 - **Series 15 Zipper**

Features & Benefits

- 1 Flammability class UL 94
- 2 Mounting bracket with integrated strain relief
- 3 Dirt-repellent exterior
- 4 Snap-open along inner radius with film-hinge

Order Example: Complete e-chain®

Please indicate chain length or number of links. Example:

3.28 ft (1 m) **14-2-038-0**
e-chain®
1 Set **114-2-12PZ**
Mounting Bracket

e-chain system® E2 Mini Series 14 Installation Dimensions

Short travel, unsupported length

- FL_B = unsupported with permitted sag
 - FL_G = unsupported with straight upper run
- Further information ► Design, Chapter 1

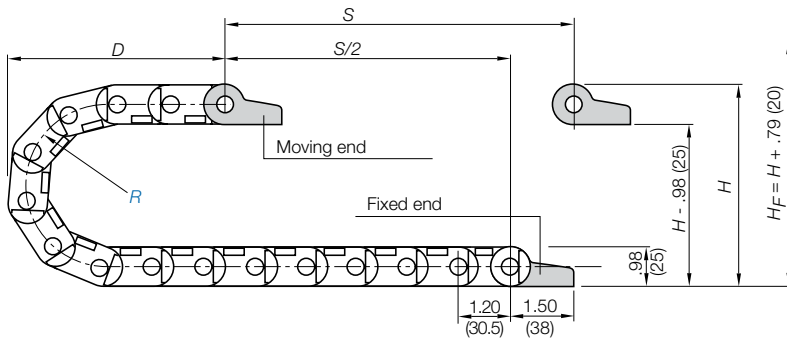
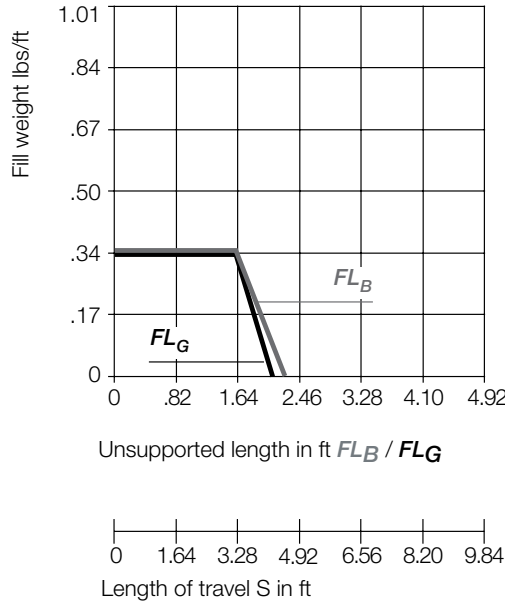
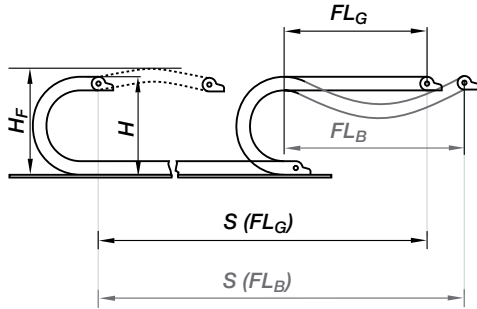

The required clearance height: $H_F = H + .79$ in. (20 mm) (with 0.34 lbs/ft (0.5 kg/m) fill weight). Please consult igus® if space is particularly restricted.

R	1.10 (028)	1.50 (038)	1.89 (048)	2.95 (075)	3.94 (100)	4.92 (125)
H	3.19 (81)	3.98 (101)	4.76 (121)	6.89 (175)	8.86 (225)	10.83 (275)
D	3.39 (86)	3.78 (96)	4.17 (106)	5.24 (133)	6.22 (158)	7.20 (183)
K	6.02 (150)	7.42 (185)	8.61 (215)	11.81 (300)	14.96 (380)	17.91 (455)

Short Travels - Unsupported



Unsupported e-chains® feature positive camber over short travels. This must be accounted for when specifying the clearance height. Please refer to **Installation dimensions** for further details.

Legend

- S = Length of travel
- R = Bending radius
- H = Nominal clearance height
- D = Overlength e-chain® radius in final position
- $K = \pi \cdot R + \text{safety buffer}$
- H_F = Required clearance height



Speed / acceleration FL_G	max. 6.56 ft/s (20 m/s) / max. 656 ft/s ² (200 m/s ²)
Speed / acceleration FL_B	max. 9.84 ft/s (3 m/s) / max. 19.69 ft/s ² (6 m/s ²)
Gliding speed / acceleration (maximum)	max. 9.84 ft/s (3 m/s) / max. 32.8 ft/s ² (10 m/s ²)
Material - permitted temperature	igumid G / -40°F (-40°C) up to +248°F (+120°C)
Flammability Class, igumid NB	VDE 0304 IIC UL94 V2

Technical Data



Details of material properties

► Chapter 1

Series 14 - e-chain® snap-open along the inner radius

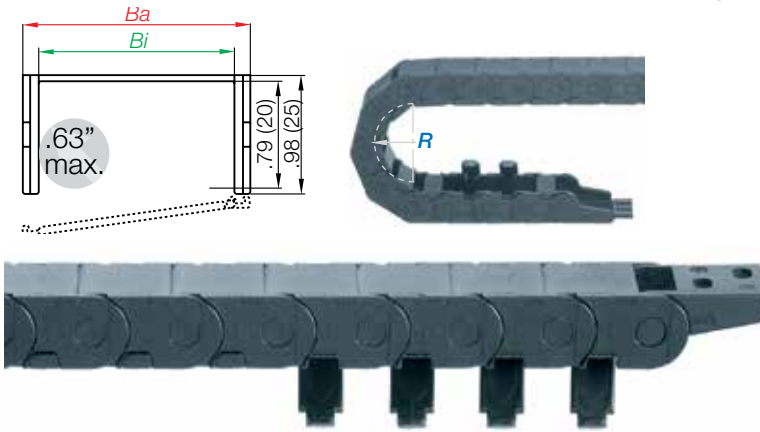

Part Number Structure

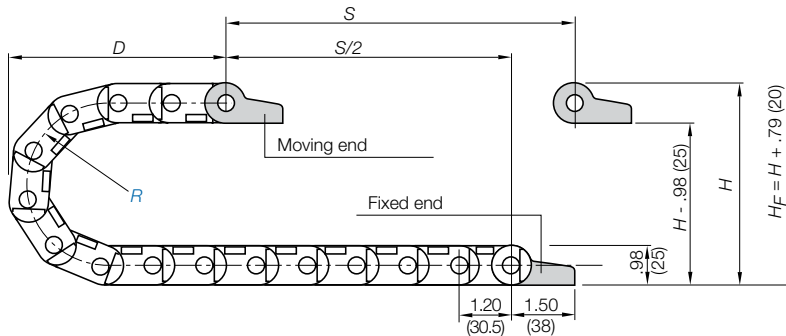
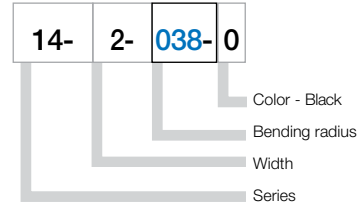

Supplement part number with required radius. Example: 14-2--0
Pitch: 1.20 in. (30.5 mm) per link links/ft (m) = 10.06 (33)

Part Number	<i>Bi</i> in. (mm)	<i>Ba</i> in. (mm)	Weight lbs/ft (kg/m)
14-1- <input type="text" value=""/> -0	.59 (15)	1.02 (26)	≈ 0.21 (0.31)
14-2- <input type="text" value=""/> -0	.98 (25)	1.42 (36)	≈ 0.22 (0.32)
14-3- <input type="text" value=""/> -0	1.50 (38)	1.93 (49)	≈ 0.27 (0.40)
14-4- <input type="text" value=""/> -0	1.97 (50)	2.40 (61)	≈ 0.28 (0.41)

Choose from the radii below for all of the above sizes

Radius (mm) Example: 14-2--0

	<input type="text" value="028"/>	<input type="text" value="038"/>	<input type="text" value="048"/>	<input type="text" value="075"/>	<input type="text" value="100"/>	<input type="text" value="125"/>
R	1.10 (028)	1.50 (038)	1.89 (048)	2.95 (075)	3.94 (100)	4.92 (125)
H	3.19 (81)	3.98 (101)	4.76 (121)	6.89 (175)	8.86 (225)	10.83 (275)
D	3.39 (86)	3.78 (96)	4.17 (106)	5.24 (133)	6.22 (158)	7.20 (183)
K	6.02 (150)	7.42 (185)	8.61 (215)	11.81 (300)	14.96 (380)	17.91 (455)

0=Standard color black. For other colors see Chapter 1

e-chain system® E2 Mini Series 14 Mounting Brackets



Polymer, one-piece

- One-piece mounting bracket
- Corrosion resistant
- Available preassembled
- Inner and outer attachment possible
- Available with or without strain relief tiewrap plates

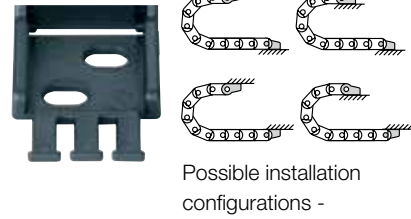
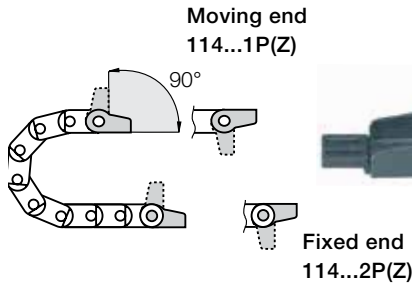

Moving end
114...1P(Z)

Fixed end
114...2P(Z)

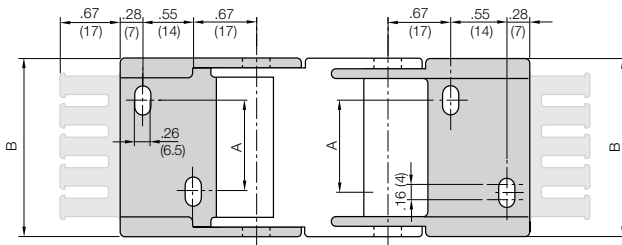

Part Number Structure

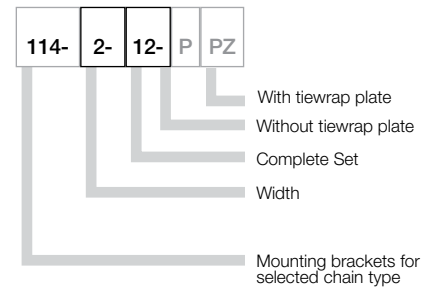

For Chain Type	Part No.		Dimension A		Dimensions B	
	Full set with Tiewrap Plate	Full Set without Tiewrap Plate	in.	(mm)	in.	(mm)
14.1	114-1-12-PZ	114-1-12-P	—	—	1.04	(26.3)
14.2	114-2-12-PZ	114-2-12-P	.39	(10)	1.43	(36.3)
14.3	114-3-12-PZ	114-3-12-P	.91	(23)	1.94	(49.3)
14.4	114-4-12-PZ	114-4-12-P	1.38	(35)	2.41	(61.3)

Full set, for both ends:

114- 2- 12- PZ Full set, each part with pin/bore + tiewrap plate

Single-part order:

114- 2- 1- PZ Mounting bracket with bore + tiewrap plate

114- 2- 2- PZ Mounting bracket with pin + tiewrap plate

Additional Accessories



Quickfix - mounting bracket with dowel, upon request

Part No.
114-3-12QZ



B15
B15i



e-chain system® E2 Mini Series B15 / B15i



Price Index



Series B15 / B15i

Special Features / Options



ESD Classification:
Electrically conductive ESD/
ATEX version upon request



Flammability Class
VDE 0304 IIC UL94 HB

Assembly Tips



Easy to assemble and disassemble

Usage Guidelines



- If snap-open accessibility is required
- If a small but very stable chain is required



- If snap-open accessibility is not required
➤ **Series 10 E2 Mini**
- If quick insertion of cables is needed
➤ **Series E14 E-Z Chain**

Features & Benefits

- 1 Large pins and double stop dog for superior life and long unsupported length
- 2 Mounting bracket with integrated strain relief
- 3 Can be opened along the outer radius (Series B15) or along the inner radius (Series B15i), these Series can be combined
- 4 Interior separation available
- 5 Dirt repellent exterior



Order Example: Complete e-chain®

Please indicate chain length or number of links. Example:

3.28 ft (1 m) **B15-025-038-0**

e-chain®

With 2 separators **154** assembled every 2nd link

Interior Separation

1 Set **1025-12PZ**

Mounting Bracket

e-chain system® E2 Mini Series B15 / B15i Installation Dimensions

Short travel, unsupported length

- FL_B = unsupported with permitted sag
 - FL_G = unsupported with straight upper run
- Further information ► Design, Chapter 1

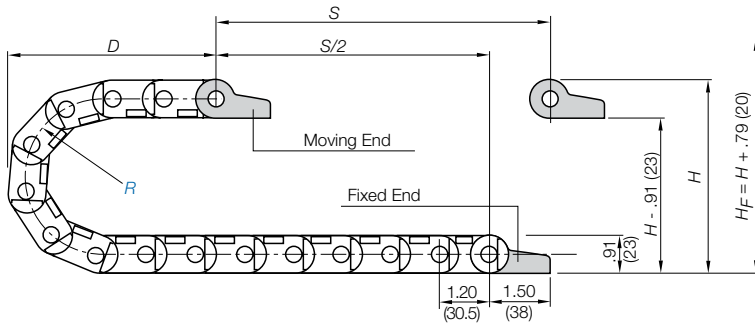
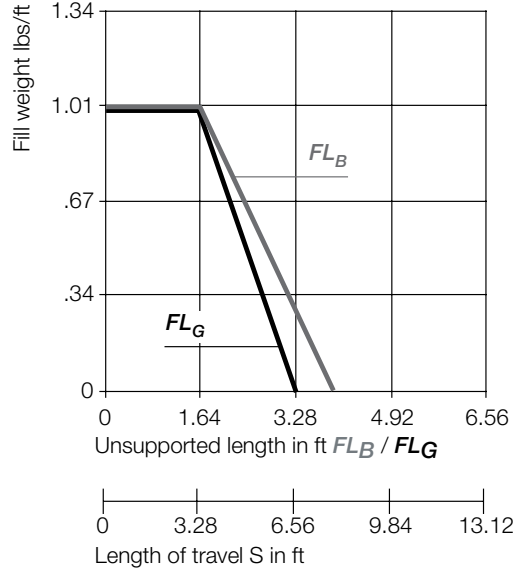
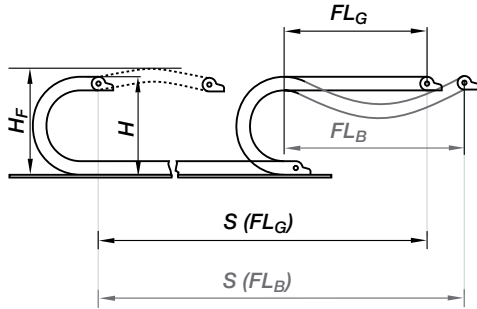

Pitch per link = 1.20" (30.5 mm)
 Links per ft (m) = 10.06 (33)
 For center mount applications:
 Chain length = $\frac{S}{2} + K$

The required clearance height: $H_F = H + .79$ in. (20 mm) (with 1.01 lbs/ft (0.5 kg/m) fill weight). Please consult igus® if space is particularly restricted.

R	1.50 (038)	1.89 (048)	2.95 (075)	3.94 (100)	4.33 (110)	4.92 (125)	5.71 (145)	7.09 (180)
H	3.90 (99)	4.69 (119)	6.81 (173)	8.78 (223)	9.57 (243)	10.75 (273)	12.32 (313)	15.08 (383)
D	3.74 (95)	4.13 (105)	5.20 (132)	6.18 (157)	6.57 (167)	7.17 (182)	7.95 (202)	9.33 (237)
K	7.28 (185)	8.46 (215)	11.81 (300)	14.96 (380)	16.14 (410)	17.91 (455)	20.47 (520)	24.80 (630)

Speed / acceleration FL_G	max. 65.6 ft/s (20 m/s) / max. 656 ft/s ² (200 m/s ²)
Speed / acceleration FL_B	max. 9.84 ft/s (3 m/s) / max. 19.69 ft/s ² (6 m/s ²)
Gliding speed / acceleration (maximum)	max. 9.84 ft/s (3 m/s) / max. 32.8 ft/s ² (10 m/s ²)
Material - permitted temperature	igumid G / -40°F (-40°C) up to +248°F (+120°C)
Flammability Class, igumid G	VDE 0304 IIC UL94 HB



B15
B15i

Short Travels - Unsupported



Unsupported e-chains® feature positive camber over short travels. This must be accounted for when specifying the clearance height. Please refer to **Installation dimensions** for further details.

Legend

- S = Length of travel
- R = Bending radius
- H = Nominal clearance height
- D = Overlength e-chain® radius in final position
- $K = \pi \cdot R + \text{safety buffer}$
- H_F = Required clearance height



PDF: igus.com/e-chain-pdfs
 Product information: igus.com/e-chains



Technical Data



Details of material properties

► Chapter 1

STANDARD

Series B15 - Snap-open along the outer radius - Standard

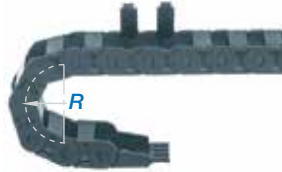
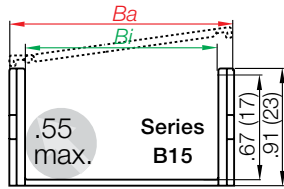

Part Number Structure

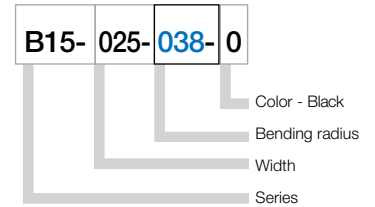

Series B15i - Snap-open along the inner radius

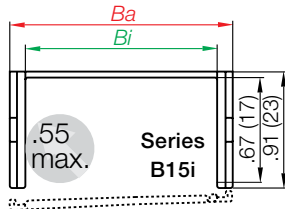

Part Number Structure

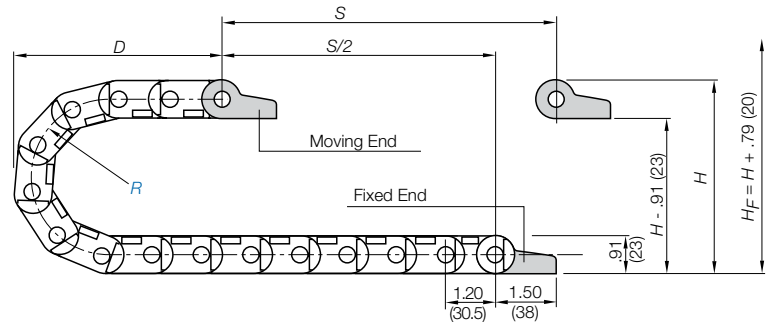
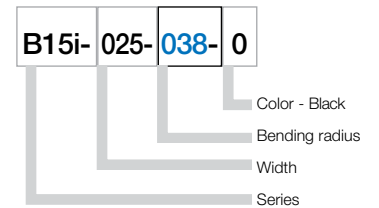

Supplement part number with required radius. Example: B15-025--0

Pitch: 1.20 in. (30.5 mm) per link links/ft (m) = 10.06 (33)

Part Number

Snap-open outer radius	Snap-open inner radius		<i>Bi</i> in. (mm)	<i>Ba</i> in. (mm)	Weight lbs/ft (kg/m)
B15-015-	B15i-015-	<input type="text" value="0"/> -0	.59 (15)	1.02 (26)	≈ 0.24 (0.35)
B15-025-	B15i-025-	<input type="text" value="0"/> -0	.98 (25)	1.42 (36)	≈ 0.27 (0.40)
B15-038-	B15i-038-	<input type="text" value="0"/> -0	1.50 (38)	1.93 (49)	≈ 0.31 (0.46)
B15-050-	B15i-050-	<input type="text" value="0"/> -0	1.97 (50)	2.40 (61)	≈ 0.35 (0.52)
B15-5-	B15i-5-	<input type="text" value="0"/> -0	2.48 (63)	2.99 (76)	≈ 0.42 (0.63)
B15-6-	B15i-6-	<input type="text" value="0"/> -0	3.15 (80)	3.70 (94)	≈ 0.47 (0.70)
B15-7-	B15i-7-	<input type="text" value="0"/> -0	3.94 (100)	4.45 (113)	≈ 0.51 (0.76)

Choose from the radii below for all of the above sizes

Radius (mm) Example: B15-025--0

	<input type="text" value="038"/>	<input type="text" value="048"/>	<input type="text" value="075"/>	<input type="text" value="100"/>	<input type="text" value="110"/>	<input type="text" value="125"/>	<input type="text" value="145"/>	<input type="text" value="180"/>
R	1.50 (38)	1.89 (48)	2.95 (75)	3.94 (100)	4.33 (110)	4.92 (125)	5.71 (145)	7.09 (180)
H	3.90 (99)	4.69 (119)	6.81 (173)	8.78 (223)	9.57 (243)	10.75 (273)	12.32 (313)	15.08 (383)
D	3.74 (95)	4.13 (105)	5.20 (132)	6.18 (157)	6.57 (167)	7.17 (182)	7.95 (202)	9.33 (237)
K	7.28 (185)	8.46 (215)	11.81 (300)	14.96 (380)	16.14 (410)	17.91 (455)	20.47 (520)	24.80 (630)

0=Standard color black. For other colors see Chapter 1

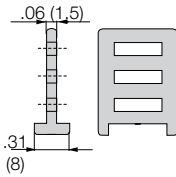
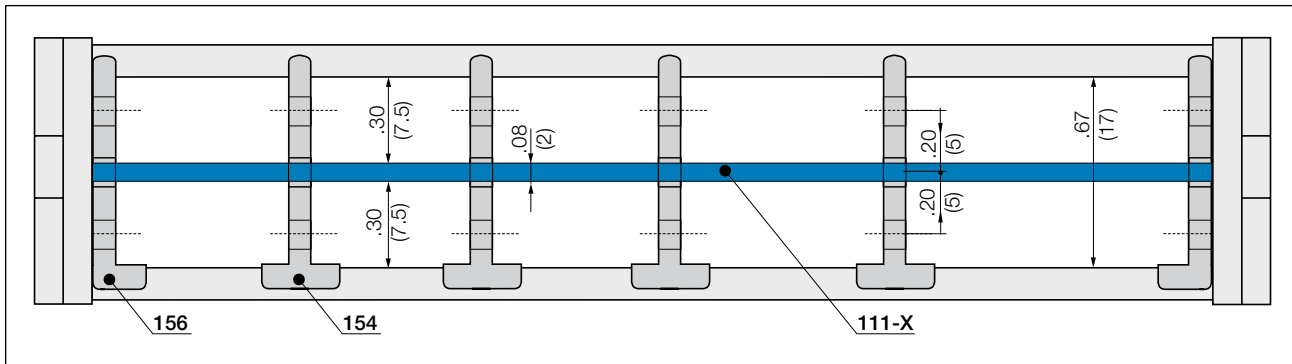

Slotted separator for e-chains®

Unassembled	Part No. 153
Assembled	Part No. 154

● **Slotted separator 153**

is used when vertical and horizontal separation is required. Due to its slot, it allows basic vertical/horizontal shelving arrangements.

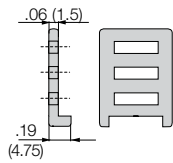

Side plate for e-chains®

Unassembled	Part No. 155
Assembled	Part No. 156

● **Side plate 155**

Side plate for use with full-width shelf 110-X and slotted separator 153

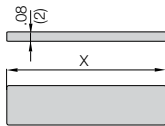

Full width shelf for e-chains®

Unassembled	Part No. 110-X
Assembled	Part No. 111-X

● **Full width shelf 110-X**

this option makes sense in applications with many thin cables with similar diameters. Full width shelves can be arranged at 3 different heights in .20" (5 mm) increments.

Width X in. (mm)	Part No. Unassembled	Part No. Assembled
.59 (015)	110-15	111-15
.98 (025)	110-25	111-25
1.50 (038)	110-38	111-38
1.97 (050)	110-50	111-50

Width X in. (mm)	Part No. Unassembled	Part No. Assembled
2.48 (063)	110-63	111-63
3.15 (080)	110-80	111-80
3.94 (100)	110-100	111-100



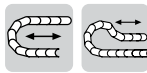

Standard

Option 1: pivoting

- Short and long travel
- Space-restricted conditions
- Corrosion resistant

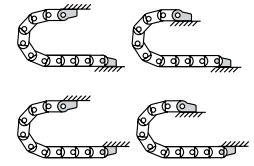
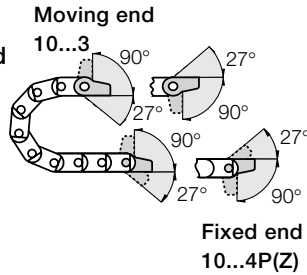

Possible installation configurations -

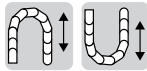

Option 2: locking

- Vertical hanging/standing travels
- Extreme accelerations
- Corrosion resistant

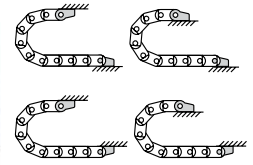
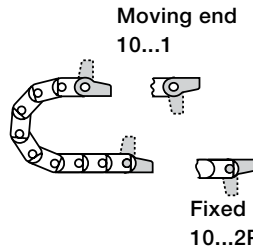

Possible installation configurations -

For e-chain
B15/B15i-015 to
B15/B15i-050

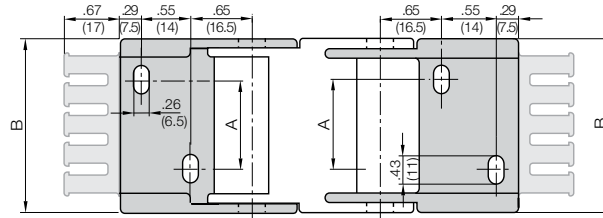

For e-chain
B15/B15i-5 to
B15/B15i-7

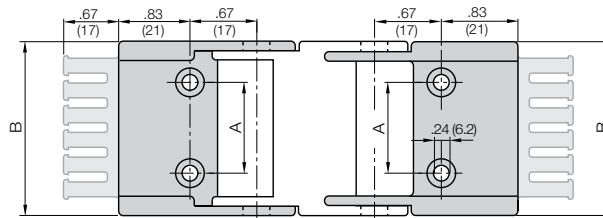

Part Number Structure

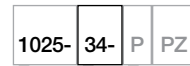

- With tiewrap plate
- Without tiewrap plate
- Complete Set
12 = Locking
34 = Pivoting
- Mounting brackets for selected chain type

Part number examples are shown for pivoting brackets. For locking brackets fill in the blank with **12**

Part No. Full Set (pivoting)
with Tiewrap Plate
Series B15/B15i with 25mm inner width
1025-34PZ

Part No. Full Set (pivoting)
without Tiewrap Plate
Series B15/B15i with 25 mm inner width
1025-34P

Full set, for both ends:
1025-34-1-PZ Full set, each part
with pin/bore + tiewrap plate

Single-part order:
1025-3-PZ Mounting bracket with bore
+ tiewrap plate

1025-4-PZ Mounting bracket with pin
+ tiewrap plate

For Chain Type	Part No.		Dimension A		Dimensions B	
	Full set with Tiewrap Plate	Full Set without Tiewrap Plate	in.	(mm)	in.	(mm)
B15/B15i-015	1015- <input type="text"/> PZ	1015- <input type="text"/> P	—	—	1.00	(25.5)
B15/B15i-025	1025- <input type="text"/> PZ	1025- <input type="text"/> P	.39	(10)	1.40	(35.5)
B15/B15i-038	1038- <input type="text"/> PZ	1038- <input type="text"/> P	.91	(23)	1.91	(48.5)
B15/B15i-050	1050- <input type="text"/> PZ	1050- <input type="text"/> P	1.38	(35)	2.38	(60.5)
B15/B15i-5	105- <input type="text"/> PZ	105- <input type="text"/> P	1.89	(48)	2.95	(75.0)
B15/B15i-6	106- <input type="text"/> PZ	106- <input type="text"/> P	2.56	(65)	3.62	(92.0)
B15/B15i-7	107- <input type="text"/> PZ	107- <input type="text"/> P	3.35	(85)	4.41	(112.0)

For pivoting brackets choose **34**
For locking brackets choose **12**
Example: 1025- PZ

e-chain system® E2 Mini

Series B15 / B15i

Guide Trough



B15
B15i

One-piece guide troughs made of steel are available for the Series B15 Energy Chains®. These guide troughs are available from stock for outer chain widths up to 4.45 in. (113 mm). For wider e-chains® and Tubes, special solutions are possible with short lead times. No installation sets are required for these trough sizes since the guide troughs consist of a one-piece U-profile. The joint connection with this type of guide trough is specified individually for every application.

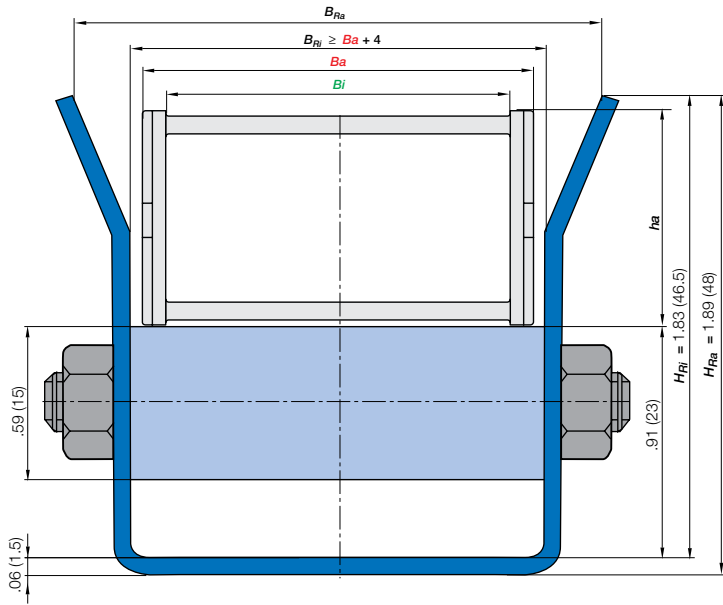

Dimensions Guide troughs 91-10 – 91-71

For Series	Part No.	B_{Ra} in. (mm)	B_{Ri} in. (mm)	Weight lbs/ft (kg/m)
B15-015				
Trough without glide bar 6.56 ft. (2m section)	91-10	1.59 (40.5)	1.18 (30)	1.01 (1.50)
Glide bar 6.56 ft. (2m section)	91-11	1.59 (40.5)	1.18 (30)	.30 (.45)
B15-025				
Trough without glide bar 6.56 ft. (2m section)	91-20	1.99 (50.5)	1.57 (40)	1.11 (1.65)
Glide bar 6.56 ft. (2m section)	91-21	1.99 (50.5)	1.57 (40)	.38 (.57)
B15-038				
Trough without glide bar 6.56 ft. (2m section)	91-30	2.46 (62.5)	2.05 (52)	1.21 (1.80)
Glide bar 6.56 ft. (2m section)	91-31	2.46 (62.5)	2.05 (52)	.46 (.68)
B15-050				
Trough without glide bar 6.56 ft. (2m section)	91-40	2.85 (72.5)	2.44 (62)	1.28 (1.90)
Glide bar 6.56 ft. (2m section)	91-41	2.85 (72.5)	2.44 (62)	.61 (.91)
B15-5				
Trough without glide bar 6.56 ft. (2m section)	91-50	3.60 (91.5)	3.19 (81)	1.52 (2.26)
Glide bar 6.56 ft. (2m section)	91-51	3.60 (91.5)	3.19 (81)	.84 (1.25)
B15-6				
Trough without glide bar 6.56 ft. (2m section)	91-60	4.27 (108.5)	3.86 (98)	1.83 (2.72)
Glide bar 6.56 ft. (2m section)	91-61	4.27 (108.5)	3.86 (98)	.91 (1.35)
B15-7				
Trough without glide bar 6.56 ft. (2m section)	91-70	5.06 (128.5)	4.65 (118)	2.13 (3.17)
Glide bar 6.56 ft. (2m section)	91-71	5.06 (128.5)	4.65 (118)	1.14 (1.70)

Trough material in general: St 1203 galvanized

PDF: igus.com/e-chain-pdfs
Product information: igus.com/e-chains



Price Index



Series B17

Special Features / Options



Special Equipment:
Electrically conductive ESD/
ATEX version upon request



Flammability Class
VDE 0304 IIC UL94 HB

Assembly Tips



Easy to assemble and disassemble

Usage Guidelines



- If snap-open accessibility is required
- If a rather small chain with a broad inner width is required



- If quick opening of the links is required
➤ **Series 17 Zipper**
- If quick insertion of cables with preassembled connectors is required
➤ **Series E16 E-Z Chain**

Features & Benefits

- 1 Dirt-repellent exterior
 - 2 Small pitch for very quiet operation
 - 3 Small e-chain® with large inner height
 - 4 Snap-open with film-hinge along the outer radius
 - 5 Mounting bracket with integrated strain relief
- Interior separation available

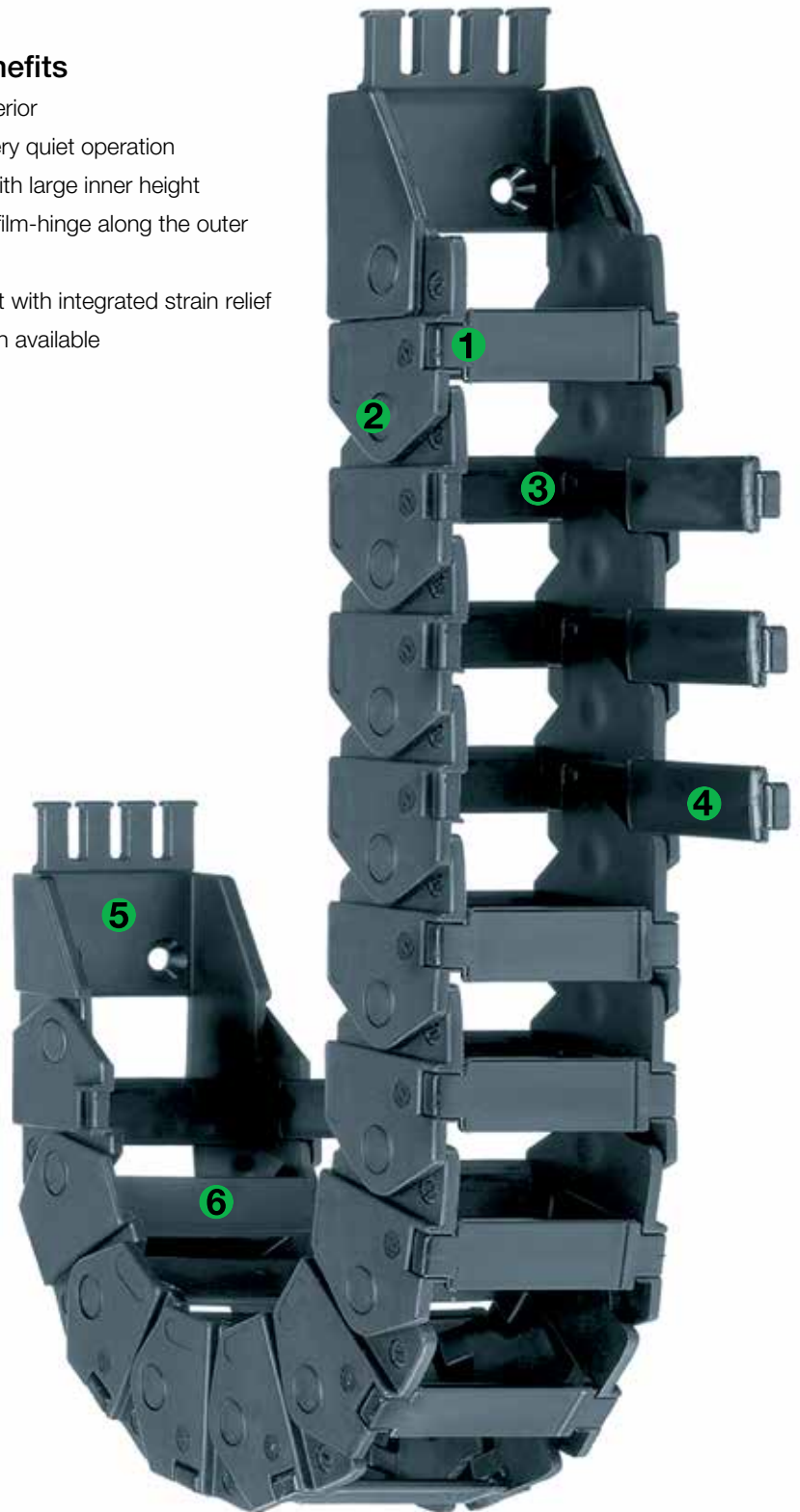

Order Example: Complete e-chain®

Please indicate chain length or number of links. Example:

3.28 ft (1 m) **B17-1-063-0**

e-chain®

With 2 separators **172** assembled every 2nd link

Interior Separation

1 Set **117-1-12PZ**

Mounting Bracket

e-chain system® E2 Mini Series B17/B17i Installation Dimensions

Short travel, unsupported length

- FL_B = unsupported with permitted sag
 - FL_G = unsupported with straight upper run
- Further information ► Design, Chapter 1

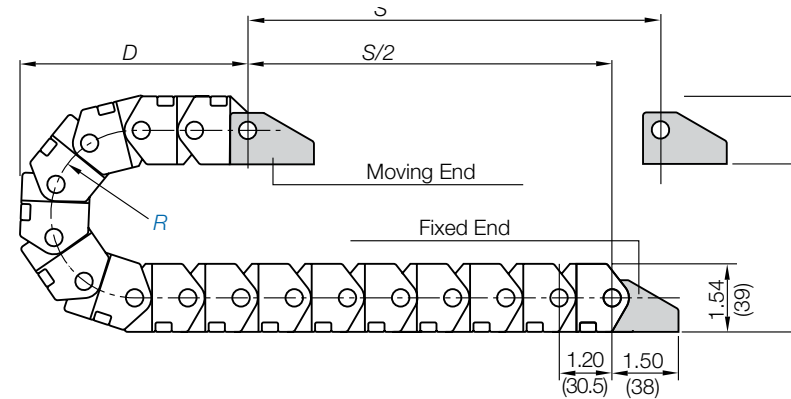
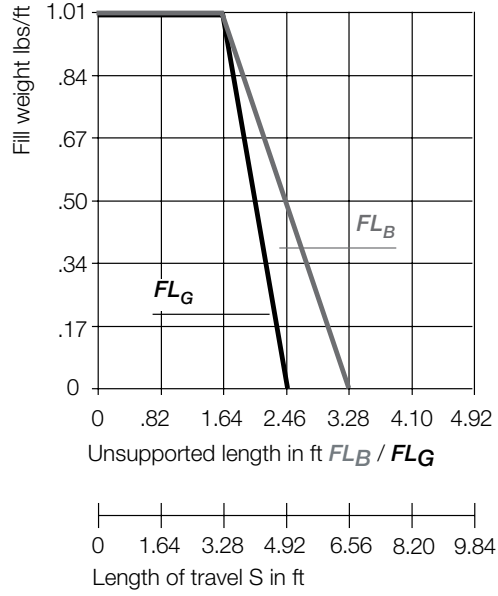
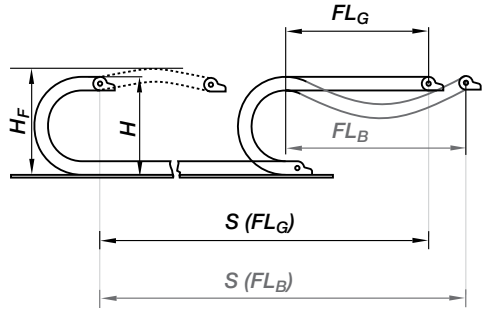

Pitch per link = 1.20" (30.5 mm)
Links per ft (m) = 10.06 (33)
For center mount applications:
Chain length = $\frac{S}{2} + K$

The required clearance height: $H_F = H + .98$ in. (25 mm) (with 1.01 lbs/ft (1.5 kg/m) fill weight). Please consult igus® if space is particularly restricted.

R	1.89 (048)	2.48 (063)	2.95 (075)	3.94 (100)	4.92 (125)
H	5.31 (135)	6.50 (165)	7.44 (189)	9.41 (239)	11.38 (289)
D	4.45 (113)	5.04 (128)	5.51 (140)	6.50 (165)	7.48 (190)
K	8.46 (215)	10.24 (260)	11.81 (300)	14.96 (380)	17.91 (455)



B17
B17i

Short Travels - Unsupported



Unsupported e-chains® feature positive camber over short travels. This must be accounted for when specifying the clearance height. Please refer to **Installation dimensions** for further details.

Legend

- S = Length of travel
- R = Bending radius
- H = Nominal clearance height
- D = Overlength e-chain® radius in final position
- $K = \pi \cdot R + \text{safety buffer}$
- H_F = Required clearance height



PDF: igus.com/e-chain-pdfs
Product information: igus.com/e-chains



Speed / acceleration FL_G	max. 65.6 ft/s (20 m/s) / max. 656 ft/s ² (200 m/s ²)
Speed / acceleration FL_B	max. 9.84 ft/s (3 m/s) / max. 19.69 ft/s ² (6 m/s ²)
Gliding speed / acceleration (maximum)	max. 9.84 ft/s (3 m/s) / max. 32.8 ft/s ² (10 m/s ²)
Material - permitted temperature	igumid G / -40°F (-40°C) up to +248°F (+120°C)
Flammability Class, igumid G	VDE 0304 IIC UL94 HB

Technical Data



Details of material properties

► Chapter 1

STANDARD

Series B17 - Snap-open along the outer radius - Standard

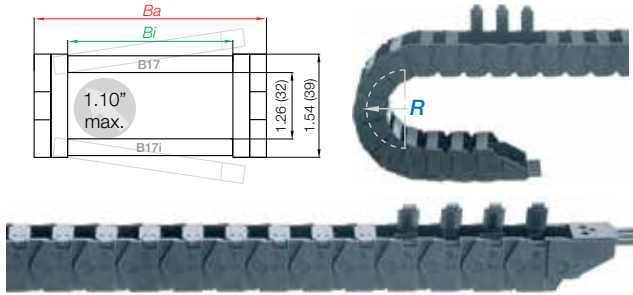

Part Number Structure

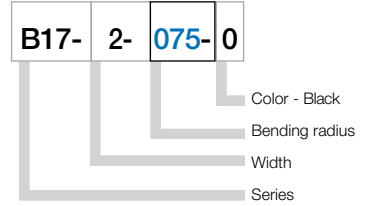

Series B17i - Snap-open along the inner radius

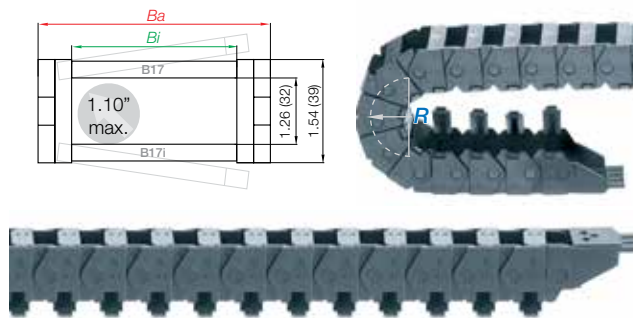

Part Number Structure

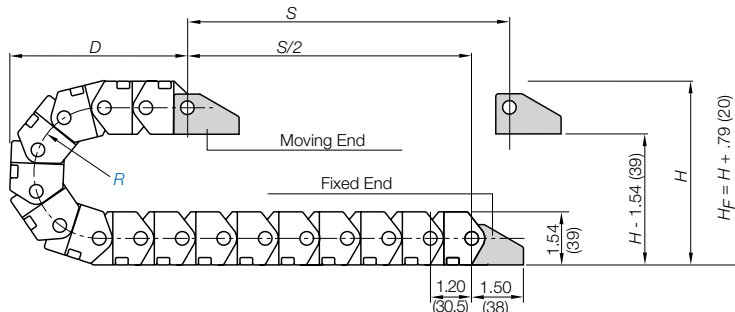
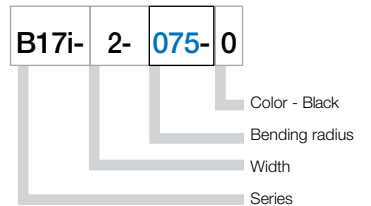

Supplement part number with required radius. Example: B17-2--0
Pitch: 1.20 in. (30.5 mm) per link links/ft (m) = 10.06 (33)

Part number Snap-open along outer radius	Part number Snap-open along inner radius		<i>Bi</i> in. (mm)	<i>Ba</i> in. (mm)	Weight lbs/ft (kg/m)
B17-1-	—	<input type="text" value="0"/> -0	.59 (15)	1.00 (25.5)	≈ 0.35 (0.52)
B17-2-	B17i-2-	<input type="text" value="0"/> -0	.98 (25)	1.40 (35.5)	≈ 0.40 (0.59)
B17-3-	B17i-3-	<input type="text" value="0"/> -0	1.50 (38)	1.91 (48.5)	≈ 0.44 (0.65)
B17-4-	B17i-4-	<input type="text" value="0"/> -0	1.97 (50)	2.38 (60.5)	≈ 0.47 (0.70)
B17-5-	—	<input type="text" value="0"/> -0	2.48 (63)	2.99 (76)	≈ 0.56 (0.83)
B17-6-	—	<input type="text" value="0"/> -0	3.15 (80)	3.66 (93)	≈ 0.62 (0.92)
B17-7-	—	<input type="text" value="0"/> -0	3.94 (100)	4.45 (113)	≈ 0.71 (1.06)

Choose from the radii below for all of the above sizes
Radius (mm) Example: B17-2--0

	<input type="text" value="048"/> *	<input type="text" value="063"/> *	<input type="text" value="075"/>	<input type="text" value="100"/> *	<input type="text" value="125"/> *
R	1.89 (048)	2.48 (063)	2.95 (075)	3.94 (100)	4.92 (125)
H	5.31 (135)	6.50 (165)	7.44 (189)	9.41 (239)	11.38 (289)
D	4.45 (113)	5.04 (128)	5.51 (140)	6.50 (165)	7.48 (190)
K	8.46 (215)	10.24 (260)	11.81 (300)	14.96 (380)	17.91 (455)

* Radii 063, 100, 125 not available for the B17i-3
** Radius 048 is not available for the B17-5 or B17-7

0=Standard color black. For other colors see Chapter 1

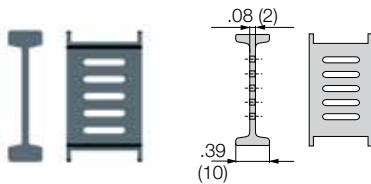
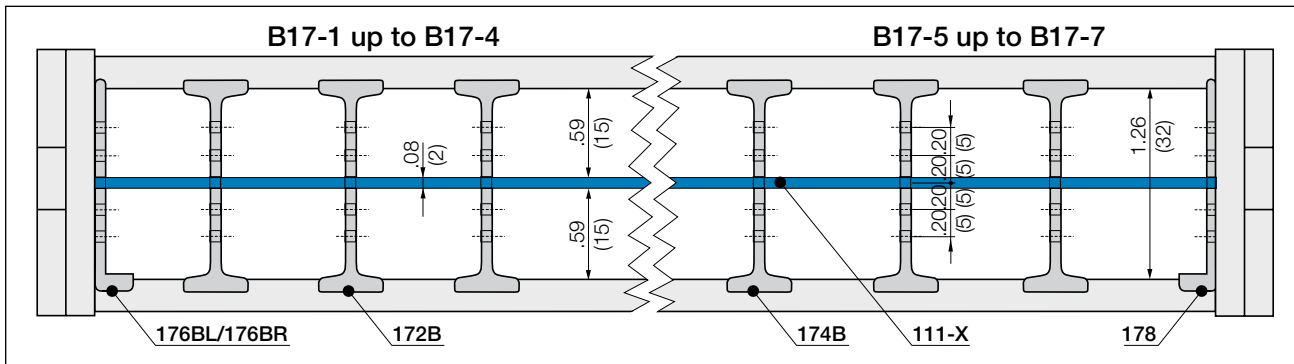

Slotted separator for B17-1 up to B17-4

Unassembled	Part No. 171B
Assembled	Part No. 172B

- Slotted separator 171B**
 (B17-1 up to B17-4)
 is used when vertical and horizontal separation is required. Due to its slot, it allows basic vertical/horizontal shelving arrangements.

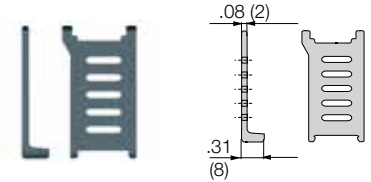

Side plate (left) for B17-1 up to B17-4

Unassembled	Part No. 175BL
Assembled	Part No. 176BL

- Side plate 175BL**
 (B17-1 up to B17-4)
 Side plate (left) for use with full-width shelf 110-X and slotted separator 171B

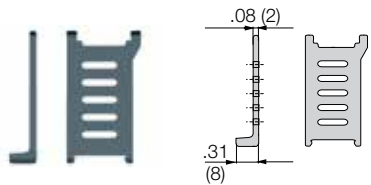

Side plate (right) for B17-1 up to B17-4

Unassembled	Part No. 175BR
Assembled	Part No. 176BR

- Side plate 175BR**
 (B17-1 up to B17-4)
 Side plate (right) for use with full-width shelf 110-X and slotted separator 171B

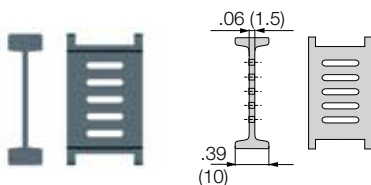

Slotted separator for B17-5 up to B17-7

Unassembled	Part No. 173B
Assembled	Part No. 174B

- Slotted separator 173B**
 (B17-5 up to B17-7)
 is used when vertical and horizontal separation is required. Due to its slot, it allows basic vertical/horizontal shelving arrangements.

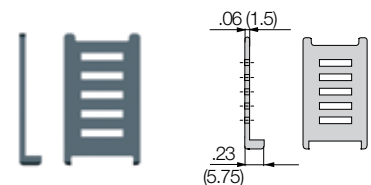

Side plate for B17-5 up to B17-7

Unassembled	Part No. 177
Assembled	Part No. 178

- Side plate 177**
 (B17-5 up to B17-7)
 Side plate for use with full-width shelf 110-X and slotted separator 173B

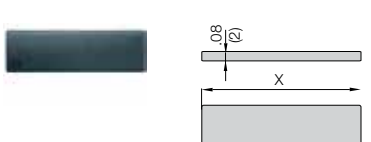

Full width shelf, for all widths

Unassembled	Part No. 110-X
Assembled	Part No. 111-X

- Full width shelf 110-X**
 this option makes sense in applications with many thin cables with similar diameters. Full width shelves can be arranged at 5 different heights in .20" (5 mm) increments.

Width X in. (mm)	Part No. Unassembled	Part No. Assembled	Width X in. (mm)	Part No. Unassembled	Part No. Assembled
.59 (015)	110-15	111-15	2.48 (063)	110-63	111-63
.98 (025)	110-25	111-25	3.15 (080)	110-80	111-80
1.50 (038)	110-38	111-38	3.94 (100)	110-100	111-100
1.97 (050)	110-50	111-50			



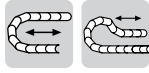

Standard

Option: locking

- One-piece mounting bracket
- Corrosion resistant
- Available pre-assembled
- Inner and outer attachment possible
- With or without strain relief tiewrap plates

Moving end with bore
117...1P(Z)

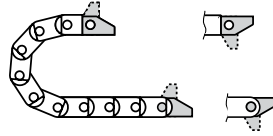

Fixed end with pin
117...2P(Z)

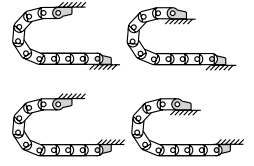

Possible installation configurations -

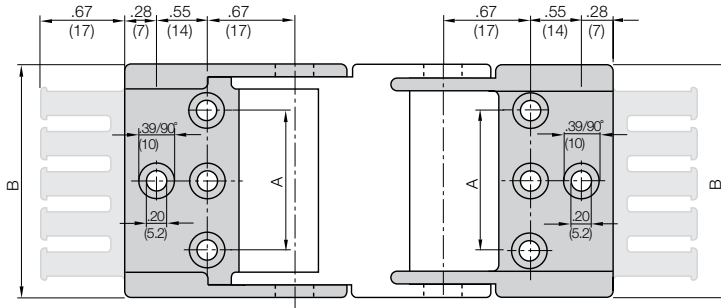

Part Number Structure

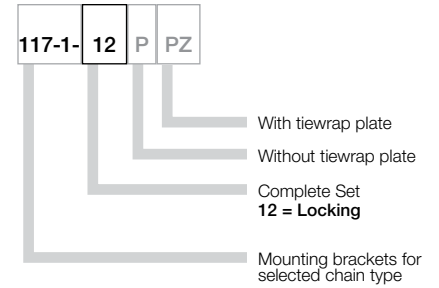

Full set, for both ends:

117-1-12-PZ Full set, each part with pin/bore + tiewrap plate

Single-part order:

117-1-1-PZ Mounting bracket with bore + tiewrap plate

117-1-2-PZ Mounting bracket with pin + tiewrap plate

For Chain Type	Part No.		Number of Teeth	Dimension A		Dimensions B	
	Full set with Tiewrap Plate	Full Set without Tiewrap Plate		in.	(mm)	in.	(mm)
B17-1	117-1-12PZ	117-1-12P	2	—	—	1.00	(25.5)
B17/B17i-2	117-2-12PZ	117-2-12P	3	.47	(12)	1.40	(35.5)
B17/B17i-3	117-3-12PZ	117-3-12P	4	.98	(25)	1.91	(48.5)
B17/B17i-4	117-4-12PZ	117-4-12P	5	1.46	(37)	2.38	(60.5)
B17-5	117-5-12PZ	117-5-12P	6	1.89	(48)	2.99	(76.0)
B17-6	117-6-12PZ	117-6-12P	8	2.56	(65)	3.66	(93.0)
B17-7	117-7-12PZ	117-7-12P	10	3.35	(85)	4.45	(113.0)

117-1-P(Z): Center bores only

117-2-12P(Z) - 117-7-P(Z): Outer bores only

PDF: igus.com/e-chain-pdfs
Product information: igus.com/e-chains



Price Index

Series F17
Special Features / Options

Special Equipment:
Electrically conductive ESD/
ATEX version upon request

Assembly Tips

Easy to assemble and disassemble

Usage Guidelines



- For applications with low loads
- If a quick access to cables is required
- For small bending radii with a large interior height is required
- For fast applications
- If a small e-chain® with large interior height is required
- If aesthetic design is required



- If cable installation without opening lids is possible
 - **Series 11.080 E2 mini**
- If extremely quick, zipper-like access to cables is required
 - **Series R17 Zipper**
- For gliding applications
 - **Series 2600/2700/2650/2680 E2/000**

4.91
Features & Benefits

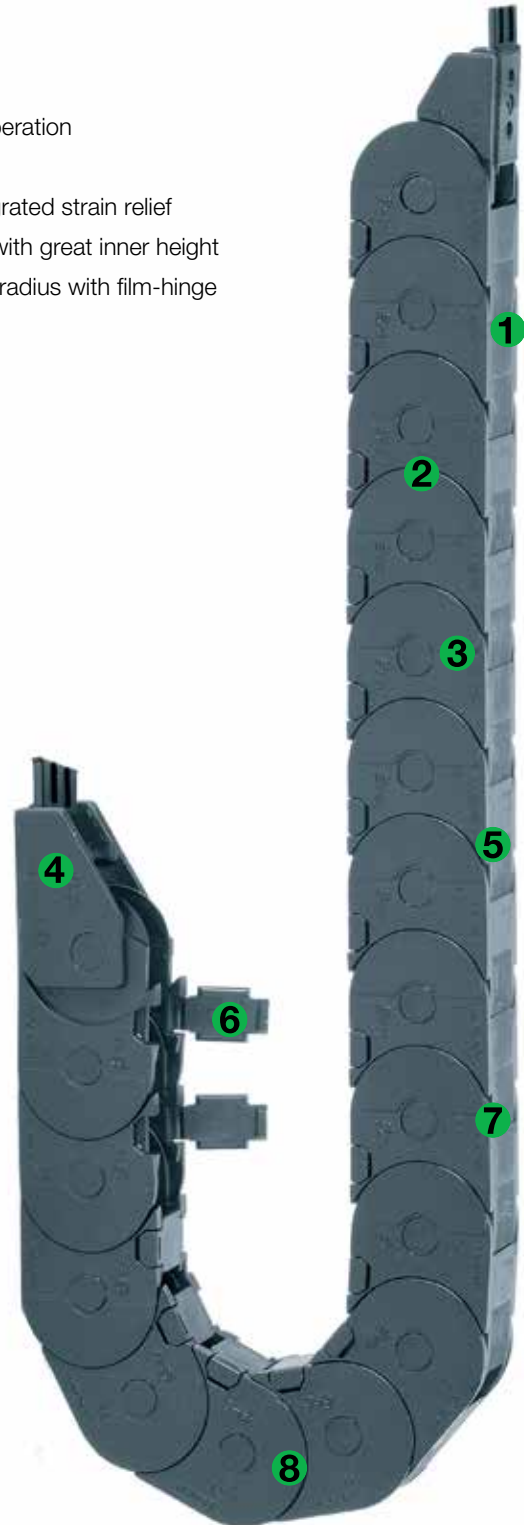
- 1 Dirt-repellent exterior
- 2 Small pitch for very quiet operation
- 3 Elegant design
- 4 Mounting bracket with integrated strain relief
- 5 Two-piece, small e-chain® with great inner height
- 6 Snap-open along the outer radius with film-hinge
- 7 Closed outside
- 8 Small bending radii

Order Example: Complete e-chain®

Please indicate chain length or number of links. Example:

 3.28 ft (1 m) **F17-025-063-0**

e-chain®

 With 2 separators **R172** assembled every 2nd link

Interior Separation

 1 Set **117-025-12PZ**

Mounting Bracket

e-chain system® E2 Mini Series F17 Installation Dimensions

Short travel, unsupported length

- FL_B = unsupported with permitted sag
 - FL_G = unsupported with straight upper run
- Further information ► Design, Chapter 1

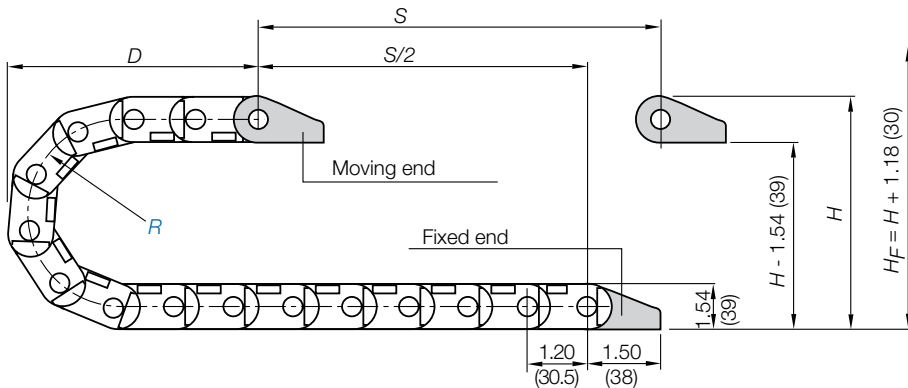
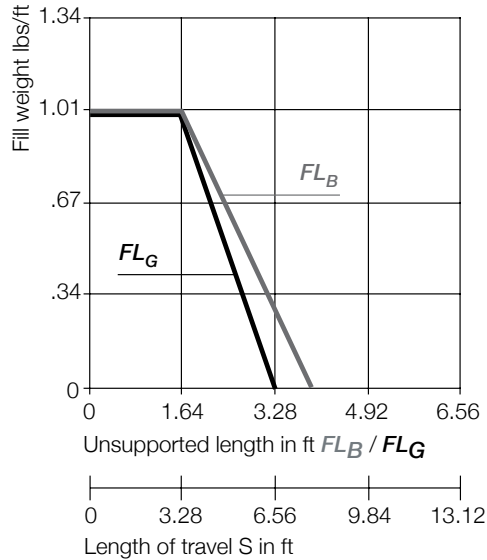
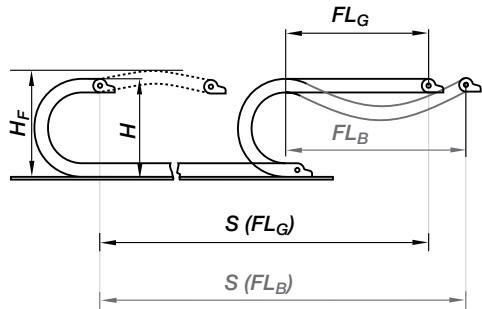

The required clearance height: $H_F = H + 1.18$ in. (30 mm) (with .34 lbs/ft (0.5 kg/m) fill weight). Please consult igus® if space is particularly restricted.

R	1.89 (048)	2.95 (075)
H	5.31 (135)	7.44 (189)
D	4.45 (113)	5.51 (140)
K	8.46 (215)	11.81 (300)

Short Travels - Unsupported



Unsupported e-chains® feature positive camber over short travels. This must be accounted for when specifying the clearance height. Please refer to **Installation dimensions** for further details.

Legend

- S = Length of travel
- R = Bending radius
- H = Nominal clearance height
- D = Overlength e-chain® radius in final position
- $K = \pi \cdot R + \text{safety buffer}$
- H_F = Required clearance height

Pitch per link = 1.20" (30.5 mm)
Links per ft (m) = 10.06 (33)
For center mount applications:
Chain length = $\frac{S}{2} + K$



Speed / acceleration FL_G	max. 65.6 ft/s (20 m/s) / max. 656 ft/s ² (200 m/s ²)
Speed / acceleration FL_B	max. 9.84 ft/s (3 m/s) / max. 19.69 ft/s ² (6 m/s ²)
Gliding speed / acceleration (maximum)	max. 9.84 ft/s (3 m/s) / max. 32.8 ft/s ² (10 m/s ²)
Material - permitted temperature	igumid G / -40°F (-40°C) up to +248°F (+120°C)
Flammability Class, igumid G	VDE 0304 IIC UL94 HB

Technical Data



Details of material properties

► Chapter 1



Series F17 - Openable along the inner radius from one side with film-hinge

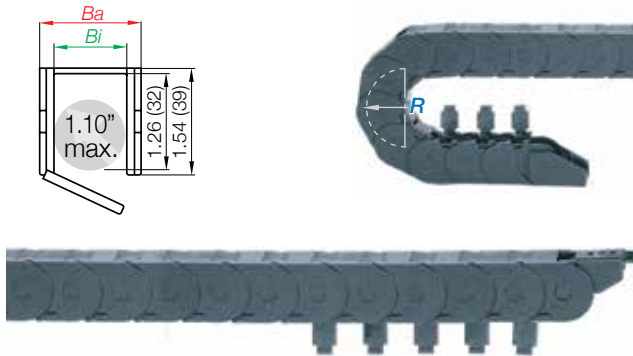

Part Number Structure

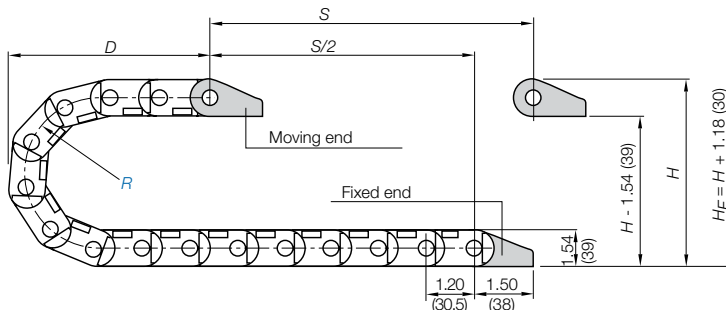
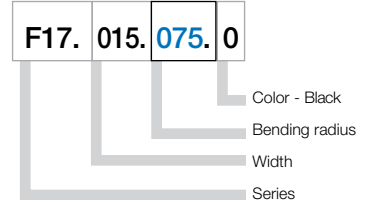

Supplement part number with required radius. Example: F17.015..0
Pitch: 1.20 in. (30.5 mm) per link links/ft (m) = 10.06 (33)

For e-chain® type	Bi in. (mm)	Ba in. (mm)	Weight lbs/ft (kg/m)
F17.015. <input type="text"/> .0	.59 (15)	1.02 (26)	≈ 0.35 (0.52)

Choose from the radii below for all of the above sizes
Radius (mm) Example: F17.015..0

	048** 1.89 (048)	075 2.95 (075)
R	1.89 (048)	2.95 (075)
H	5.31 (135)	7.44 (189)
D	4.45 (113)	5.51 (140)
K	8.46 (215)	11.81 (300)

0=Standard color black. For other colors see Chapter 1

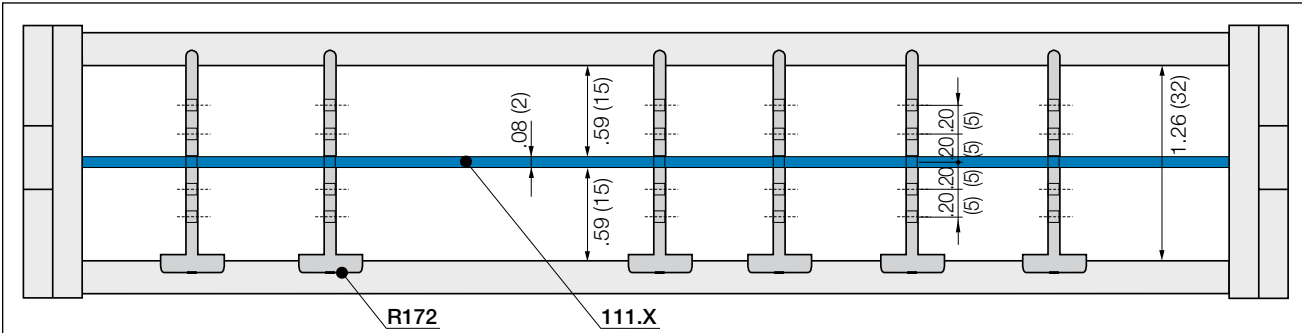

No lateral gap to side links necessary.
As standard separators are fitted every 2nd e-chain® link!

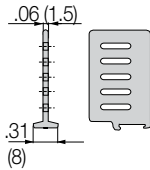

Slotted separator

Unassembled	Part No. R171
Assembled	Part No. R172

- **Slotted separator R171**
is used when vertical separation is required. The slot allows basic vertical/horizontal shelving arrangements.

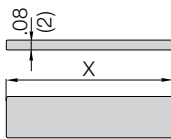

Full width shelf, for all widths

Unassembled	Part No. 110-15
Assembled	Part No. 111-15

- **Full width shelf 110-15**
this option makes sense in applications with many thin cables with similar diameters. For full-width separation

Full-width shelves
Width = X [mm]

Width X in. (mm)	Part No. Unassembled	Part No. Assembled
.59 (015)	110-15	111-15

PDF: igus.com/e-chain-pdfs
Product information: igus.com/e-chains





Standard

Option: locking

- One-piece mounting bracket
- Corrosion resistant
- Available preassembled
- Inner and outer attachment possible
- With or without strain relief tiewrap plates

Moving end with bore
117...1P(Z)

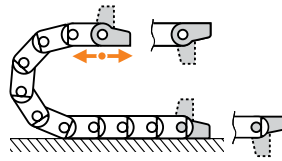

Fixed end with pin
117...2P(Z)

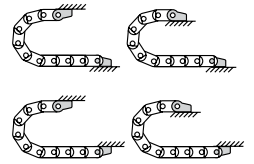

Possible installation configurations -

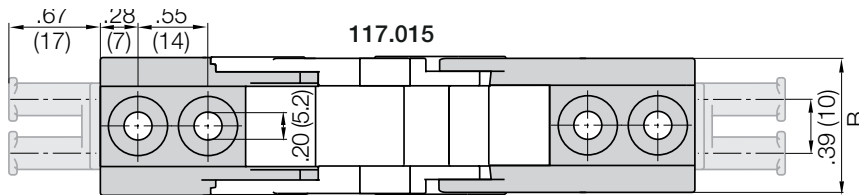

For Chain Type	Part No. Full set with Tiewrap Plate	Part No. Full Set without Tiewrap Plate	Number of Teeth	Dimension A		Dimensions B	
				in.	(mm)	in.	(mm)
F17.015	117.015.12PZ	117.015.12P	2	—	—	1.09	(27.7)

Full set, for both ends:

117.015.12PZ Full set, each part with pin/bore + tiewrap plate

Single-part order:

117.015.1PZ Mounting bracket with bore + tiewrap plate

117.015.2PZ Mounting bracket with pin + tiewrap plate

Part Number Structure

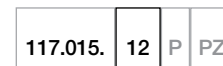

- With tiewrap plate
- Without tiewrap plate
- Complete Set
- 12 = Locking**
- Mounting brackets for selected chain type

e-chain system® E2 Mini
Series F17
Mounting Brackets - Plastic



F17

PDF: igus.com/e-chain-pdfs
Product information: igus.com/e-chains



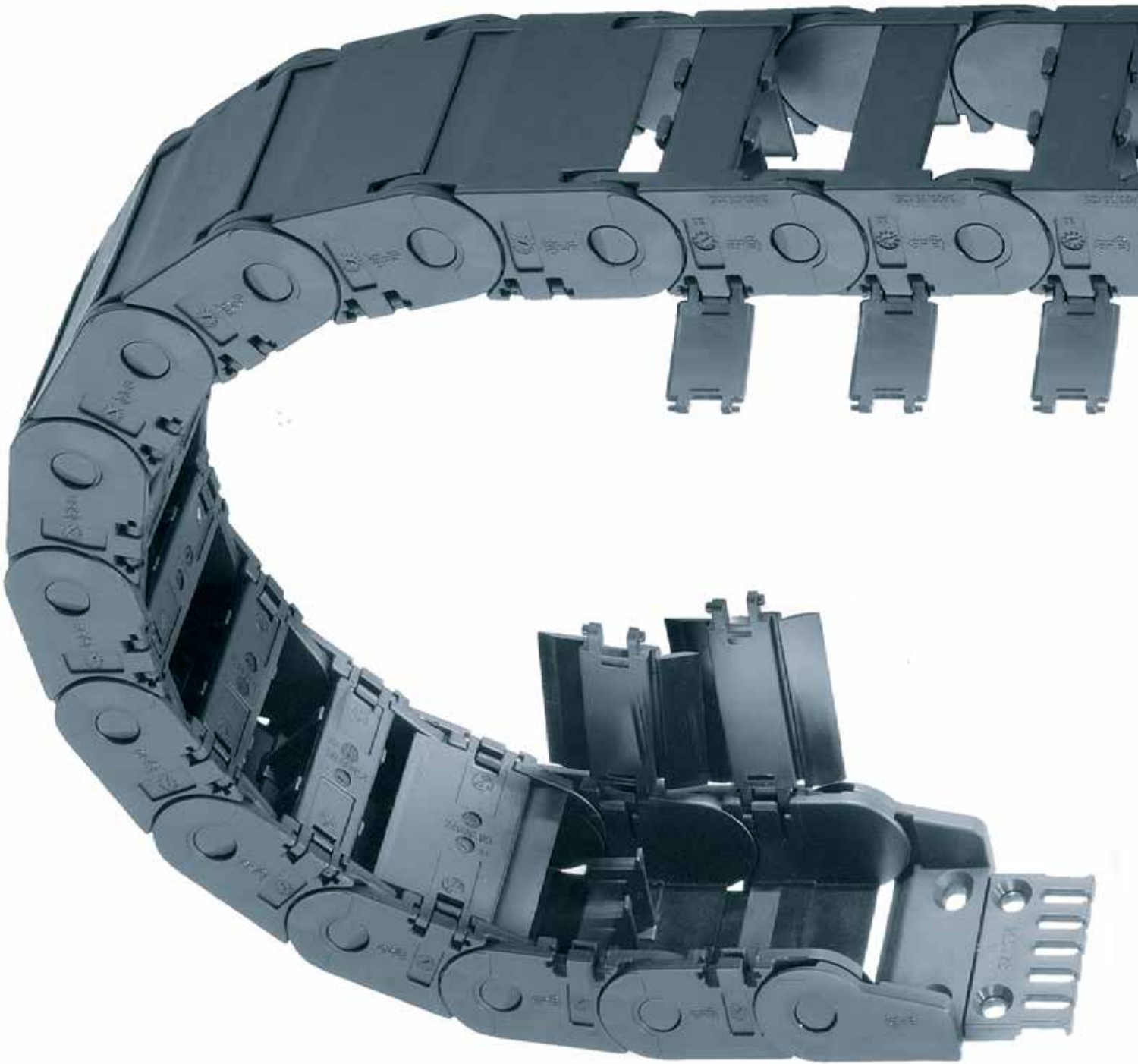

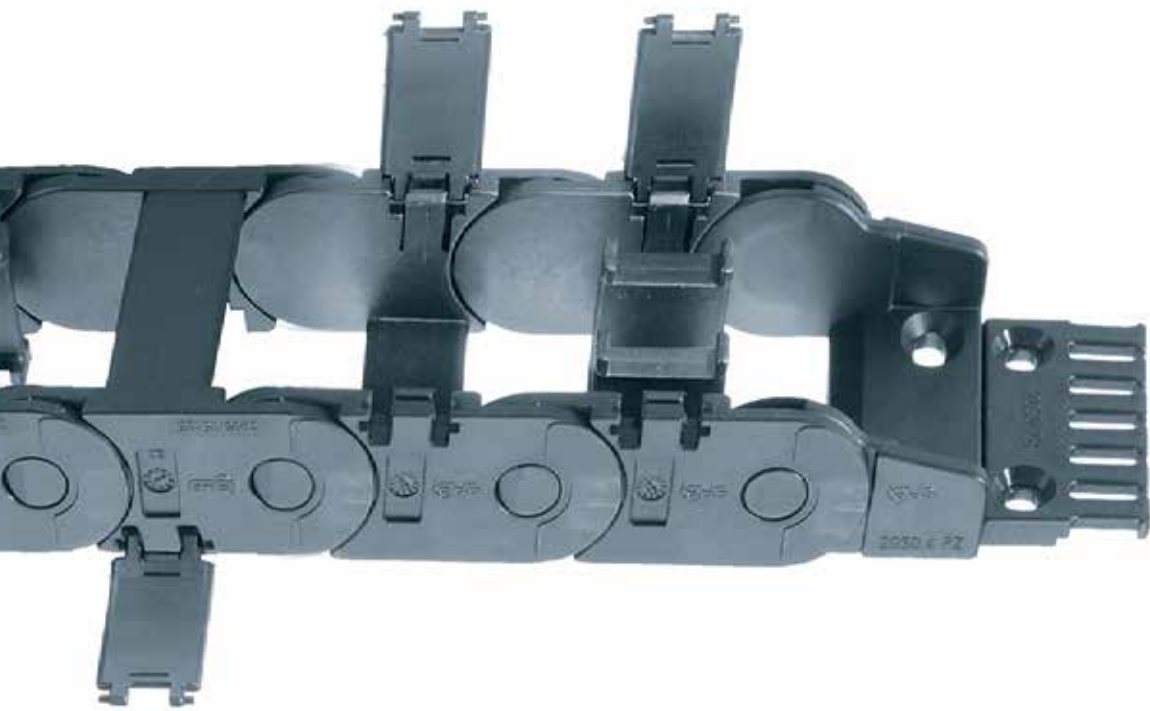

igus[®] E2/000

E2/000 - with 2-piece link-design for a wide range of applications

E2/000 - the standard

The E2/000 Series is igus® fourth generation in this popular size range. All past experiences went into this Millennium Series: easy assembly combined with ruggedness - high stability paired with quieter motion - long cable life and many mounting options. The design is consistent within all E2/000 variations. It is the standard product for machine builders around the world.

Typical industries and applications

- Material handling
- Construction machinery
- Woodworking machines
- Glass handling machines
- Plastic handling machines
- Long travel applications in many industries
- Semiconductor machines
- Theatre, entertainment and amusement parks
- Vehicles
- General machinery

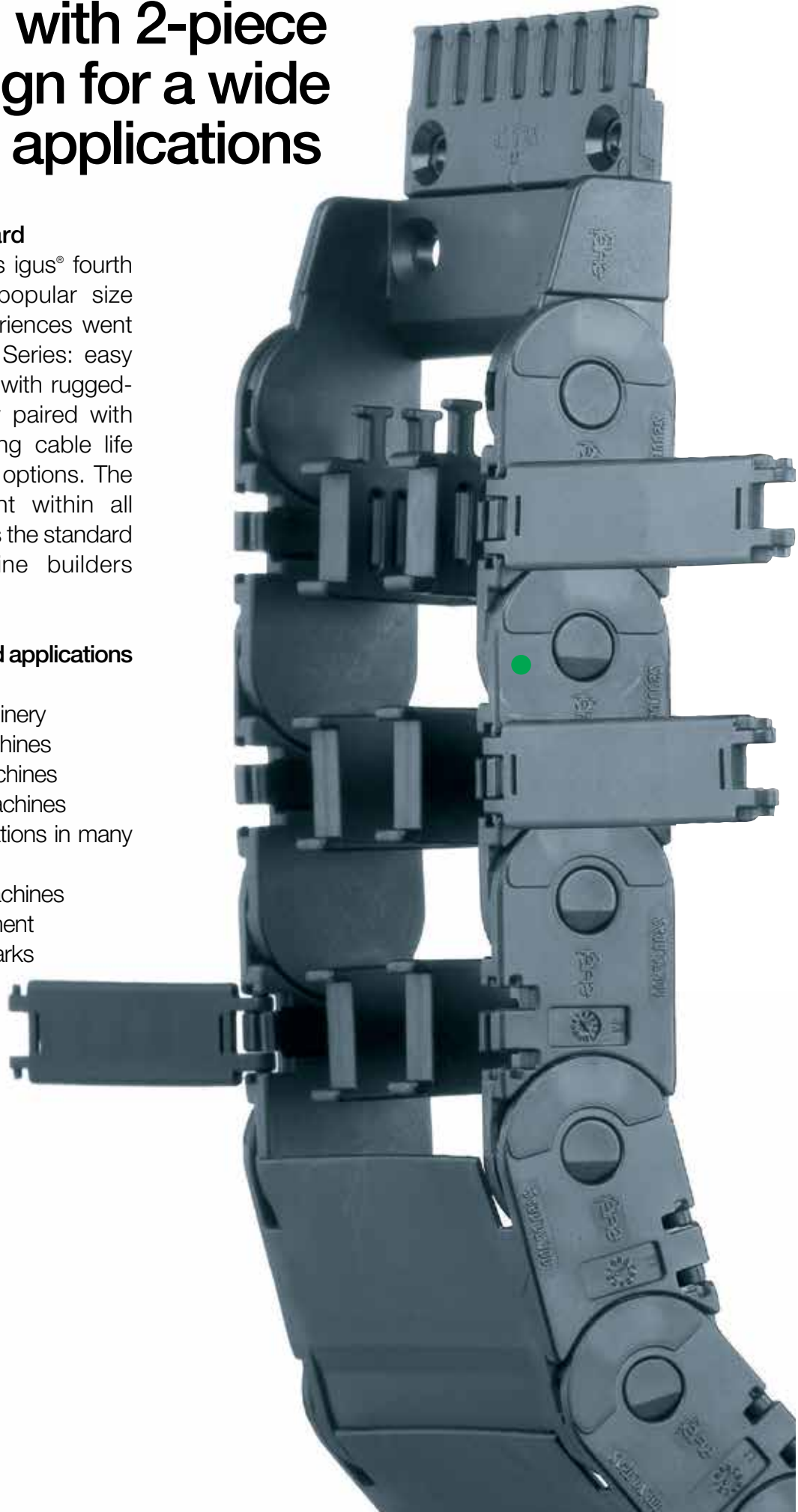



Pre-assembled E2/000 e-chain® - turnkey solution delivered with cables and sheet metal parts attached and ready for installation

E2/000 features



New snap-open mechanism, choice of snap-open on left or right

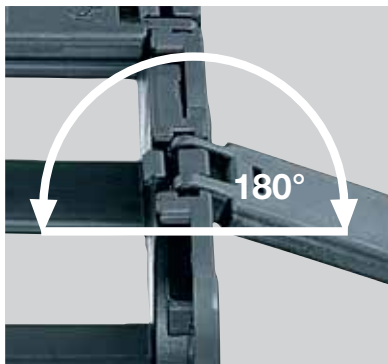

Hinged crossbar can be swiveled by more than 180° on both sides

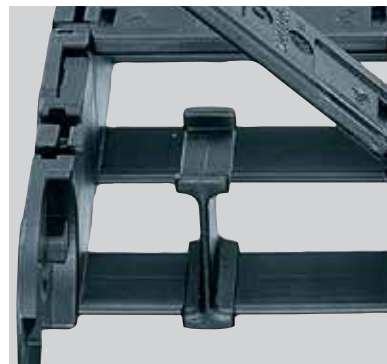

Secure fit of separators and interior separation even when e-chain® is open



Half e-tube - Fully enclosed in outer radius. Choice of swiveling interior radius to the left or right



Lightning-fast closing by the touch of a thumb - secure fit without additional locking devices

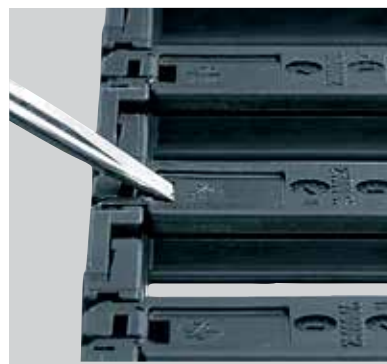

Opening mechanism accessible from above - rapid opening with a screwdriver or the e-chain® opener

e-chain system® E2/000

Selection Guide

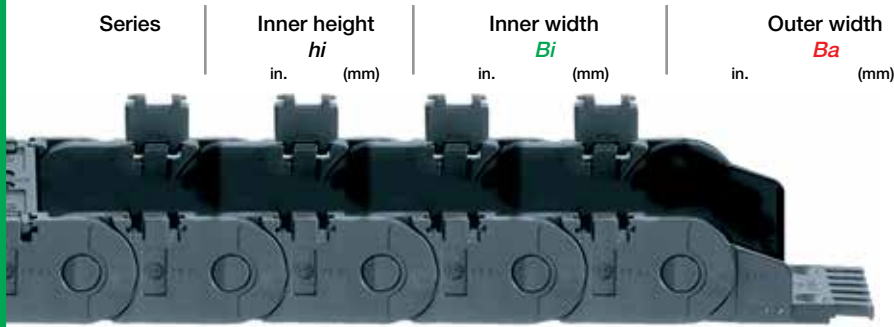

E2/000 e-chains®
Standard for System E2
 snap-open along outer
 radius from both sides

Series	Inner height <i>hi</i>		Inner width <i>Bi</i>		Outer width <i>Ba</i>		Outer height <i>ha</i>		Bending radius <i>R</i>	
	in.	(mm)	in.	(mm)	in.	(mm)	in.	(mm)	in.	(mm)
1500	.83	(21)	.59-4.92	(15 - 125)	1.12-5.45	(28.5 - 138.5)	1.10	(28)	1.38-7.09	(35 - 180)
2500	.98	(25)	.98-4.92	(25 - 125)	1.61-5.55	(41.0 - 141.0)	1.38	(35)	2.44-9.84	(55 - 250)
2700	1.38	(35)	1.97-6.89	(50 - 175)	2.60-7.64	(66.0 - 194.0)	1.97	(50)	2.48-9.84	(63 - 250)
3500	1.77	(45)	1.97-9.84	(50 - 250)	2.76-10.63	(70.0 - 270.0)	2.52	(64)	2.95-11.81	(75 - 300)
255	.94	(24)	1.50-4.06	(38 - 103)	2.13-4.69	(54.0 - 119.0)	1.38	(35)	2.17-9.84	(55 - 250)



E2/000 e-chains®
 snap-open along inner
 radius from both sides

1400	.83	(21)	.59-4.92	(15 - 125)	1.12-5.45	(28.5 - 138.5)	1.10	(28)	1.38-7.09	(35 - 180)
2400	.98	(25)	.98-4.92	(25 - 125)	1.61-5.55	(41.0 - 141.0)	1.38	(35)	2.44-9.84	(55 - 250)
2600	1.38	(35)	1.97-6.89	(50 - 175)	2.60-7.64	(66.0 - 194.0)	1.97	(50)	2.48-9.84	(63 - 250)
3400	1.77	(45)	1.97-9.84	(50 - 250)	2.76-10.63	(70.0 - 270.0)	2.52	(64)	2.95-11.81	(75 - 300)



Half e-tubes
 snap-open along inner
 radius from both sides

1450	.83	(21)	.59-4.92	(15 - 125)	1.12-5.45	(28.5 - 138.5)	1.10	(28)	2.95-7.09	(75 - 180)
2450	.98	(25)	.98-4.92	(25 - 125)	1.61-5.55	(41.0 - 141.0)	1.38	(35)	2.95-9.84	(75 - 250)
2650	1.38	(35)	1.97-6.89	(50 - 175)	2.60-7.64	(66.0 - 194.0)	1.97	(50)	3.94-9.84	(100 - 250)
3450	1.77	(45)	1.97-9.84	(50 - 250)	2.76-10.63	(70.0 - 270.0)	2.52	(64)	4.92-11.81	(125 - 300)



Full e-tubes
 snap-open along inner
 radius from both sides

1480	.83	(21)	.59-4.92	(15 - 125)	1.12-5.45	(28.5 - 138.5)	1.10	(28)	2.95-7.09	(75 - 180)
2480	.98	(25)	.98-4.92	(25 - 125)	1.61-5.55	(41.0 - 141.0)	1.38	(35)	2.95-9.84	(75 - 250)
2680	1.38	(35)	1.97-6.89	(50 - 175)	2.60-7.64	(66.0 - 194.0)	1.97	(50)	3.94-9.84	(100 - 250)
3480	1.77	(45)	1.97-9.84	(50 - 250)	2.76-10.63	(70.0 - 270.0)	2.52	(64)	4.92-11.81	(125 - 300)

e-chain system® E2/000 Assembly Instructions

e-chains® - Opening and Closing E2 Series R1000 e-tubes



1 Open: swivel lids



2 Close: push and snap



3 Insert screwdriver into the slot, using a lever action apply pressure to the screwdriver to release



4 Remove lid

e-chains® - Separating E2 Series R1000 e-tubes



1 Release side link



2 Twist and pull apart



Available from stock. **Orders ship as early as today.***

*On average 90% of orders ship the same day..

1400
1500



e-chain system® E2/000 Series 1400/1500



Price Index



Series 1400/1450/1500

Special Features / Options



IPA Qualification Certificate, Air Cleanliness Class ISO Class 3 (at v = 2 m/s) upon request



ESD classification: Electrically conductive ESD/ATEX version upon request



Flammability Class VDE 0304 IIC UL94 HB

Assembly Tips



Snap-open mechanism, choice of snap-open on left or right. Hinged crossbar can be swiveled by more than 180° on both sides. Lightning-fast closing by hand. Secure fit without additional locking devices.

Other Installation Methods

Vertical, hanging ≤ 65.6 ft (20 m)

Vertical, standing ≤ 6.56 ft (2 m)

Side-mounted, un_supp. ≤ 2.30 ft (0.7 m)

Rotary requires further calculation

Usage Guidelines



- If snap-open accessibility along the inner or outer radius is required
- If integrated strain relief at the mounting point is required
- If half e-tube is required (Series 1450)
- If long service life is required
- If easy installation is required



- If the application is very simple
➤ Series E200 E-Z Chain
- If greater stability is required
➤ Series E4-21 E4-1 Series

Features & Benefits

- 1 Tried-and-tested mounting bracket
- 2 Snap-open crossbar for easy opening from the left or right
- 3 Series 1400 snap-open on both sides along inner radius
- 4 Series 1500 snap-open on both sides along outer radius
- 5 Integrated strain relief possible
- 6 Modular interior separation
- 7 Easy assembly by optimized pin
- 8 Double stop dog for long unsupported length
- 9 Crossbars with high retention force
- 10 Also available as ESD version

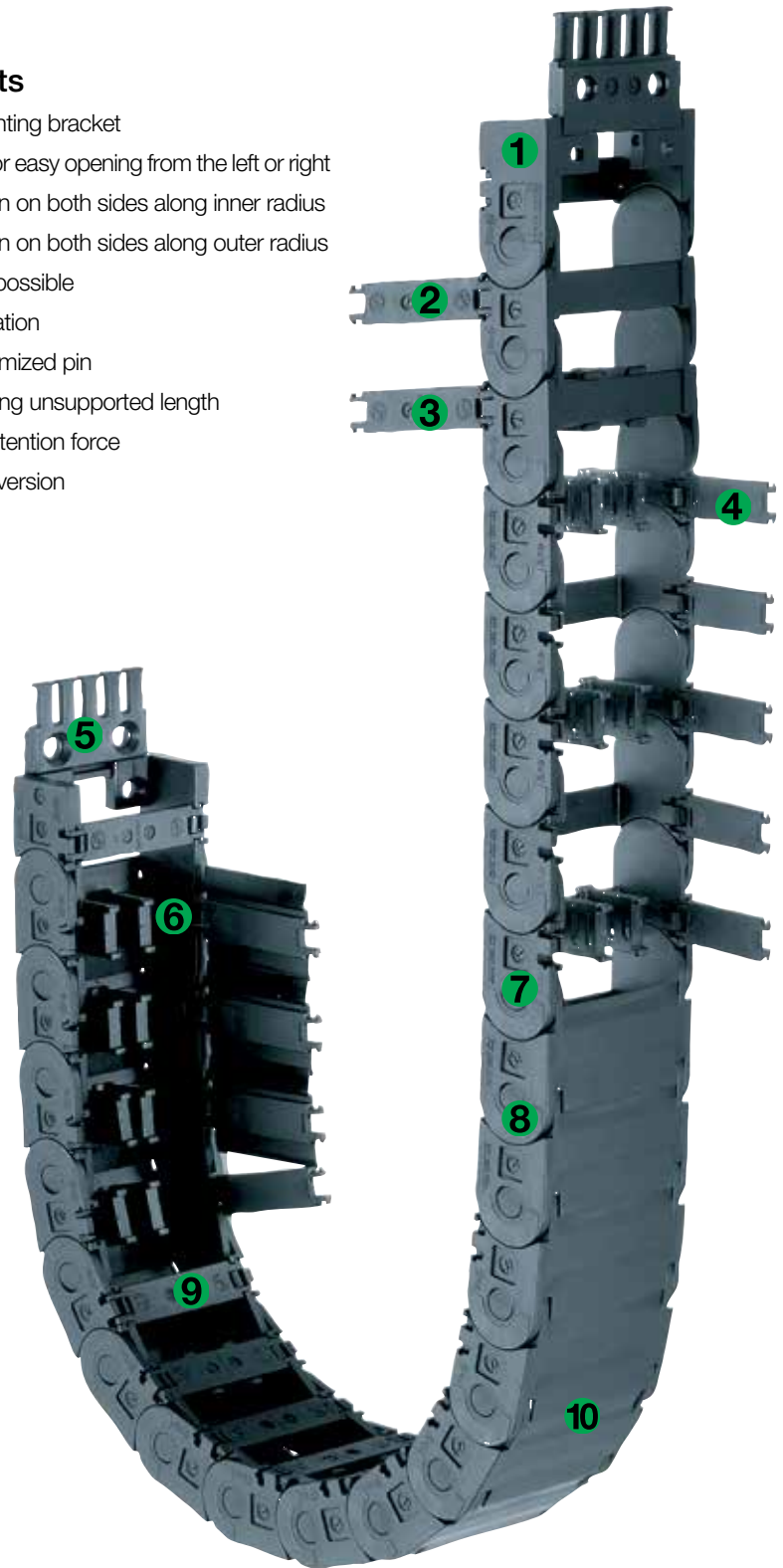

Order Example: Complete e-chain®

Please indicate chain length or number of links. Example:

9.84 ft (3 m) **1400-038-100-0**



e-chain®

With 2 separators **14011** assembled every 2nd link



Interior Separation

1 Set **15000-038-34PZB**



Mounting Bracket

e-chain system® E2/000

Series 1400/1500

Installation Dimensions

Short travel, unsupported length

- FL_B = unsupported with permitted sag
 - FL_G = unsupported with straight upper run
- Further information ► Design, Chapter 1

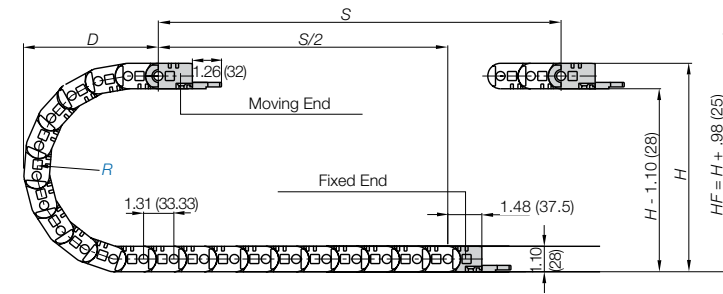
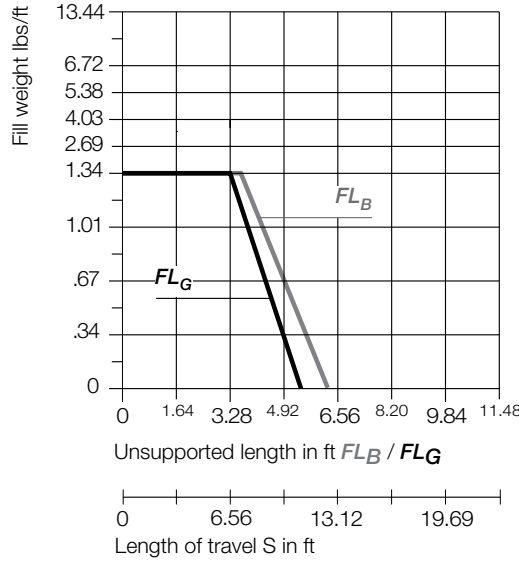
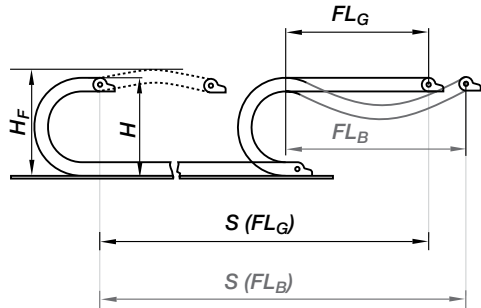

Pitch per link = 1.31" (33.3 mm)
 Links per ft (m) = 9.16 (30)
 For center mount applications:
 Chain length = $S/2 + K$

The required clearance height: $H_f = H + .98$ in. (25 mm) (with .34 lbs/ft (0.5 kg/m) fill weight).
 Please consult igus® if space is particularly restricted.

R	1.38 (035)	1.50 (038)	1.89 (048)	2.95 (075)	3.94 (100)	4.92 (125)	5.71 (145)	7.09 (180)
H	3.86 (98)	4.09 (104)	4.88 (124)	7.01 (178)	8.98 (228)	10.94 (278)	12.52 (318)	15.28 (388)
D	3.90 (99)	4.02 (102)	4.41 (112)	5.47 (139)	6.46 (164)	7.44 (189)	8.23 (209)	9.61 (244)
K	7.09 (180)	7.48 (190)	8.66 (220)	12.01 (305)	15.16 (385)	18.11 (460)	20.67 (525)	25.00 (635)

For long travels with lowered mounting height

Long travel lengths from 32.8 ft. (10 m) to max. 246 ft. (75 m)

For center mount applications:

Chain length = $S/2 + K_2$

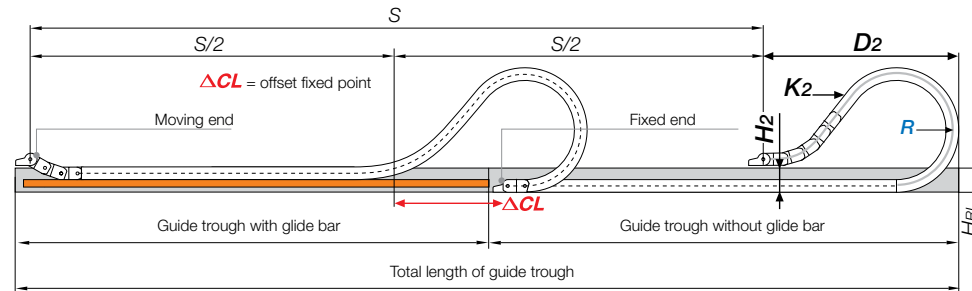

In case of travels between 13 ft. (4m) and 32.8 ft. (10m) we recommend a longer unsupported length.

R	1.38 (035)	1.50 (038)	1.89 (048)	2.95 (075)	3.94 (100)	4.92 (125)	5.71 (145)	7.09 (180)
H ₂	—	—	—	—	3.94 (100)	3.94 (100)	3.94 (100)	3.94 (100)
D ₂ ²⁵	—	—	—	—	13.39 (340)	19.49 (495)	21.26 (540)	27.17 (690)
K ₂	—	—	—	—	23.62 (600)	31.50 (800)	37.01 (940)	46.06 (1170)
ΔCL	—	—	—	—	7.05 (179)	12.01 (305)	13.39 (340)	17.52 (445)

Speed / acceleration FL_G	max. 65.6 ft/s (20 m/s) / max. 656 ft/s ² (200 m/s ²)
Speed / acceleration FL_B	max. 9.84 ft/s (3 m/s) / max. 19.69 ft/s ² (6 m/s ²)
Gliding speed / acceleration (maximum)	max. 32.81 ft/s (10 m/s) / max. 164 ft/s ² (50 m/s ²)
Material - permitted temperature	igumid G / -40°F (-40°C) up to +248°F (+120°C)
Flammability Class, igumid G	VDE 0304 IIC UL94 HB



1400
1500

Short Travels - Unsupported



Unsupported e-chains® feature positive camber over short travels. This must be accounted for when specifying the clearance height. Please refer to **Installation dimensions** for further details.

Legend

- S = Length of travel
- R = Bending radius
- H = Nominal clearance height
- D = Overlength e-chain® radius in final position
- $K = \pi \cdot R + \text{safety buffer}$
- H_f = Required clearance height
- H_{R1} = Trough inner height
- H₂ = *Mounting height
- D₂ = Overlength - long travels, gliding
- K₂ = *Add-on

*If the mounting bracket location is set lower

Long Travels - Gliding



If the unsupported length is exceeded, the e-chain®/ Tube must glide on itself. This requires a guide trough.

Design, Chapter 1

Technical Data



Details of material properties

► Chapter 1



PDF: igus.com/e-chain-pdfs
 Product information: igus.com/e-chains



► Chapter 9

1400
1500



e-chain system® E2/000
Series 1400/1500

igus®
e-chain system®

Telephone 1-800-521-2747

Series 1400 - Snap-open along the inner radius

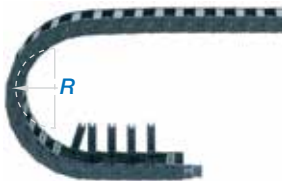
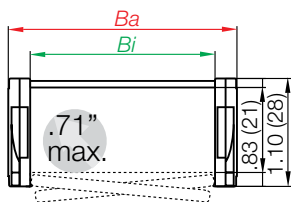

Part Number Structure

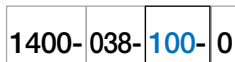

Color - Black
Bending radius
Width
Series

Series 1500 - Snap open along the outer radius

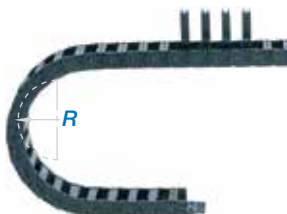
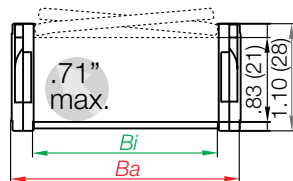

Part Number Structure



Color - Black
Bending radius
Width
Series

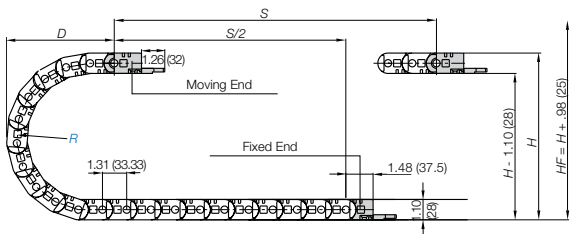

Supplement part number with required radius. Example: 1400-038--0
Pitch: 1.31 in. (33.3 mm) per link links/ft (m) = 9.14 (30)

Part Number						Weight	
Snap-open Inner Radius	Snap-open Outer Radius			<i>Bi</i>	<i>Ba</i>	1400/1500	1450
				in. (mm)	in. (mm)	lbs/ft (kg/m)	lbs/ft (kg/m)
1400-015-	1500-015- <input type="text" value=""/>	-0		.59 (15)	1.12 (28.5)	≈ 0.31 (0.46)	≈ 0.32 (0.48)
1400-020-	1500-020- <input type="text" value=""/>	-0		.79 (20)	1.32 (33.5)	≈ 0.32 (0.47)	-
1400-025-	1500-025- <input type="text" value=""/>	-0		.98 (25)	1.52 (38.5)	≈ 0.33 (0.49)	≈ 0.38 (0.57)
1400-038-	1500-038- <input type="text" value=""/>	-0		1.50 (38)	2.03 (51.5)	≈ 0.36 (0.53)	≈ 0.40 (0.59)
1400-050-	1500-050- <input type="text" value=""/>	-0		1.97 (50)	2.50 (63.5)	≈ 0.38 (0.56)	≈ 0.44 (0.65)
1400-068-	1500-068- <input type="text" value=""/>	-0		2.68 (68)	3.21 (81.5)	≈ 0.42 (0.63)	≈ 0.50 (0.74)
1400-080-	1500-080- <input type="text" value=""/>	-0		3.15 (80)	3.68 (93.5)	≈ 0.45 (0.67)	≈ 0.54 (0.80)
1400-100-	1500-100- <input type="text" value=""/>	-0		3.94 (100)	4.47 (113.5)	≈ 0.50 (0.74)	≈ 0.60 (0.90)
1400-125-	1500-125- <input type="text" value=""/>	-0		4.92 (125)	5.45 (138.5)	≈ 0.56 (0.83)	≈ 0.69 (1.03)

Choose from the radii below for all of the above sizes

Radius (mm) Example: 1400-038--0

	035	038	048	075	100	125	145	180
R	1.38 (035)	1.50 (038)	1.89 (048)	2.95 (075)	3.94 (100)	4.92 (125)	5.71 (145)	7.09 (180)
H+4	3.86 (98)	4.09 (104)	4.88 (124)	7.01 (178)	8.98 (228)	10.94 (278)	12.52 (318)	15.28 (388)
D	3.90 (99)	4.02 (102)	4.41 (112)	5.47 (139)	6.46 (164)	7.44 (189)	8.23 (209)	9.61 (244)
K	7.09 (180)	7.48 (190)	8.66 (220)	12.01 (305)	15.16 (385)	18.11 (460)	20.67 (525)	25.00 (635)

Internet: igus.com
email: sales@igus.com
QuickSpec: igus.com/quickspec

e-chain system® E2/000
 Series 1400/1500
 Interior Separation - New Generation



1400
 1500

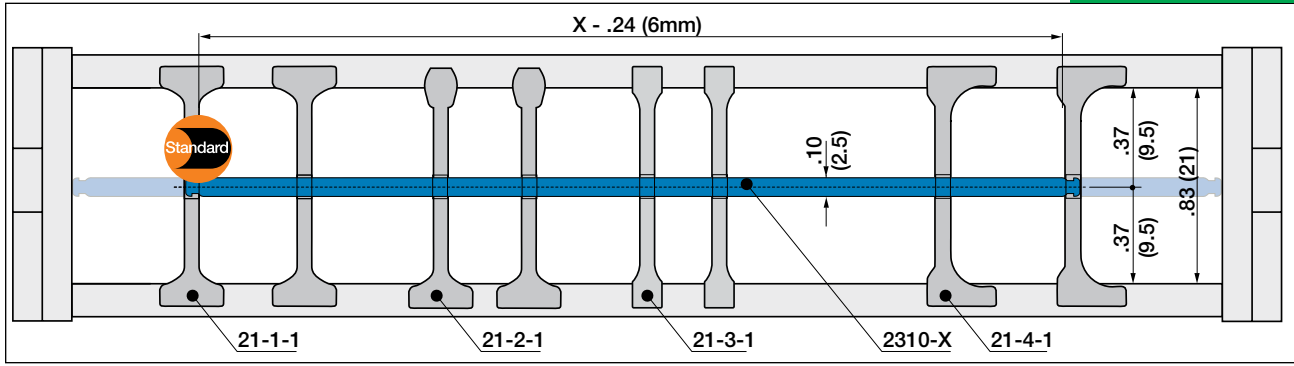

In the standard configuration separators are assembled every 2nd e-chain® link

Note: Only suitable for e-chain® Series 1400/1500

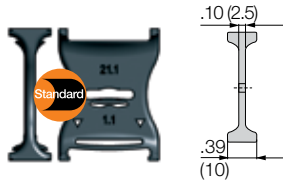

Separator, wide base

Unassembled Part No. 21.1
 Assembled Part No. 21.1.1

- **Standard separator 21.1 for all applications**

Separator with wide base for maximum locking strength and safe standing in e-chains®.

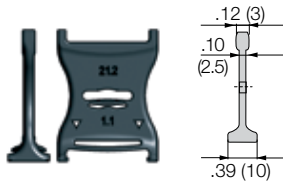

Separator, narrow head

Unassembled Part No. 21.2
 Assembled Part No. 21.2.1

- **Separator 21.2**

For even faster installation

is used when vertical and horizontal separation is required. Due to its slot, it allows basic vertical/horizontal shelving arrangements.

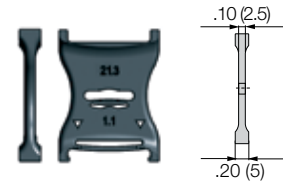

Separator, narrow base

Unassembled Part No. 21.3
 Assembled Part No. 21.3.1

- **Separator 21.3**

For many thin cables

is used when vertical and horizontal separation is required. Due to its slot, it allows basic vertical/horizontal shelving arrangements.

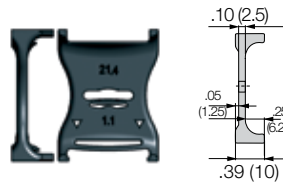

Separator, asymmetrical

Unassembled Part No. 21.4
 Assembled Part No. 21.4.1

- **Separator 21.4**

For side mounted applications

is used when vertical and horizontal separation is required. Due to its slot, it allows basic vertical/horizontal shelving arrangements.

Lockable full-width shelves - for the standard interior separation

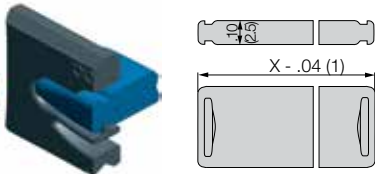

Full width shelf, lockable

Unassembled Part No. 2300-X
 Assembled Part No. 2310-X

- **Full width shelf, lockable**

is used when vertical and horizontal separation is required.

Width X in. (mm)	Part No. Unassembled	Part No. Assembled	Width X in. (mm)	Part No. Unassembled	Part No. Assembled	Width X in. (mm)	Part No. Unassembled	Part No. Assembled
015	2300-15	2310-15	060	2300-60	2310-60	087	2300-87	2310-87
025	2300-25	2310-25	062	2300-62	2310-62	090	2300-90	2310-90
030	2300-30	2310-30	065	2300-65	2310-65	100	2300-100	2310-100
038	2300-38	2310-38	070	2300-70	2310-70	103	2300-103	2310-103
040	2300-40	2310-40	075	2300-75	2310-75	110	2300-110	2310-110
050	2300-50	2310-50	077	2300-77	2310-77	120	2300-120	2310-120
057	2300-57	2310-57	080	2300-80	2310-80	125	2300-125	2310-125

PDF: igus.com/e-chain-pdfs
 Product information: igus.com/e-chains



Option 1: Vertical separators

Vertical separators are used if a vertical subdivision of the e-tube interior is required. By standard, vertical separators are assembled every other e-tube link.

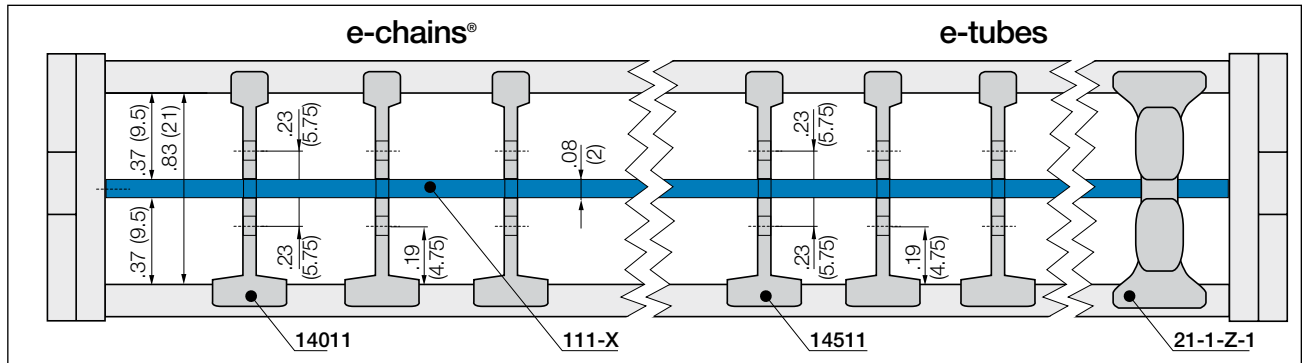

Separators, full-width shelves, Strain relief separators

In the standard configuration separators are assembled every 2nd e-chain® link

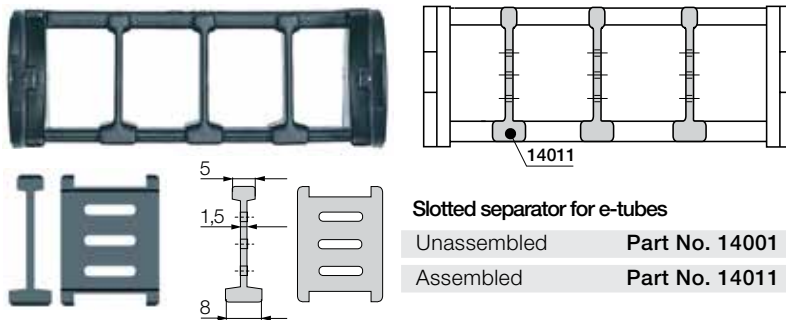

Slotted separator for e-tubes
Unassembled Part No. 14001
Assembled Part No. 14011

- **Slotted separator 14001 (Chains only)** is used when vertical and horizontal separation is required. Due to its slot, it allows basic vertical/horizontal shelving arrangements.

Option 2: Strain relief separator

Can be integrated into the mounting bracket and can be placed there at any position. To be used assembled on either the first or last e-chain® link. Ideal for restricted space conditions.

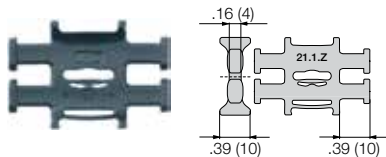

Strain relief separator for e-chains®
Unassembled Part No. 21.1.Z
Assembled Part No. 21.1.Z.1

- **Slotted separator 21.1.Z (Chains only)** It combines strain relief and interior separation.

Option 3: Full-width shelf

It is ideal for use in applications involving many thin cables with similar or identical diameters. This shelf slides into place and spans the entire width of the chain.

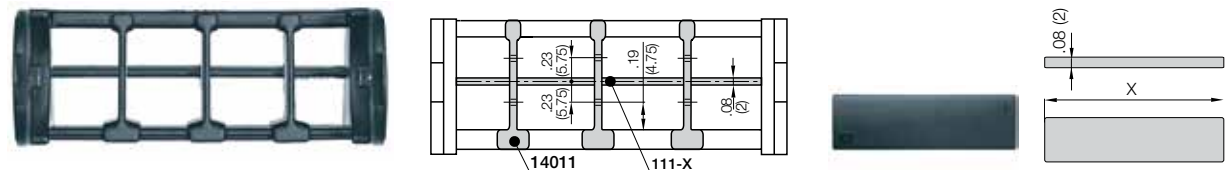

Width X in. (mm)	Part No. Unassembled	Part No. Assembled	Width X in. (mm)	Part No. Unassembled	Part No. Assembled
0.59 (15)	110-15	111-15	2.68 (68)	110-68	111-68
0.79 (20)	110-20	111-20	3.15 (80)	110-80	111-80
0.98 (25)	110-25	111-25	3.94 (100)	110-100	111-100
1.50 (38)	110-38	111-38	4.92 (125)	110-125	111-125
1.97 (50)	110-50	111-50			

- **Full-width shelf 110-X (Chains®/Tubes)** this option makes sense in applications with many thin cables with similar diameters. Full-width shelves can be inserted at 3 different heights in .23" (5.75mm) increments

e-chain system® E2/000

Series 1400/1500

Mounting Brackets - Plastic



1400
1500



Option 1: pivoting

- Unsupported and gliding applications
- Space-restricted conditions
- Integrated strain relief
- Easy to assemble
- Various mounting positions

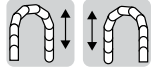
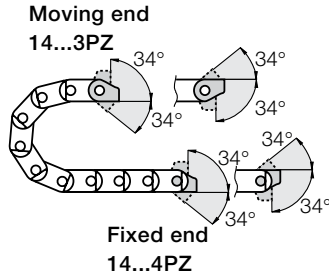

Option 2: locking

- Unsupported applications
- Extreme speed/accelerations
- If space is limited for height (H_F)
- Various mounting positions

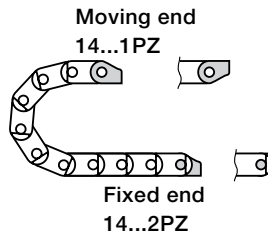

Part Number Structure

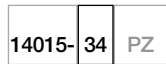

With tiewrap plates

Complete Set
34 = Pivoting
12 = Locking

Mounting brackets for selected chain type

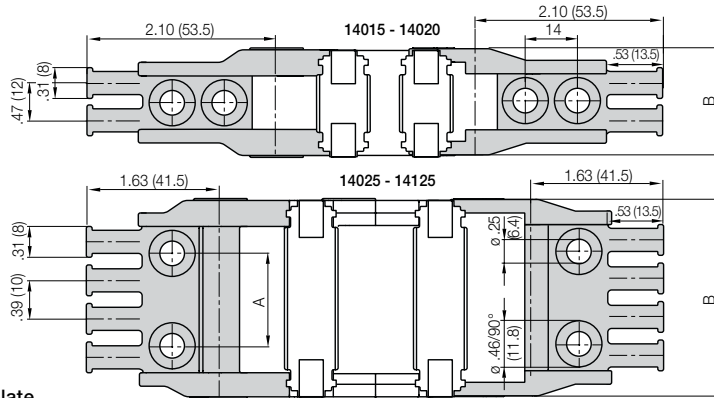

Full set, for both ends:

14015-34-PZ Full set, each part with pin/bore + tiewrap plate

Single-part order:

14015-3-PZ Mounting bracket with bore + tiewrap plate

14015-4-PZ Mounting bracket with pin + tiewrap plate

For Chain Type	Part No.	Dimension A		Dimension B		Number
		in.	(mm)	in.	(mm)	
1400/1450/1500-015	14015-□ PZ	-	-	1.12	(28.5)	2
1400/1450/1500-020	14020-□ PZ	-	-	1.32	(33.5)	2
1400/1450/1500-025	14025-□ PZ	.51	(13)	1.52	(38.5)	2
1400/1450/1500-038	14038-□ PZ	.94	(24)	2.03	(51.5)	4
1400/1450/1500-050	14050-□ PZ	1.42	(36)	2.50	(63.5)	6
1400/1450/1500-068	14068-□ PZ	2.13	(54)	3.21	(81.5)	7
1400/1450/1500-080	14080-□ PZ	2.60	(66)	3.68	(93.5)	8
1400/1450/1500-100	14100-□ PZ	3.39	(86)	4.47	(113.5)	10
1400/1450/1500-125	14125-□ PZ	4.37	(111)	5.45	(138.5)	13

34 or 12

For pivoting brackets choose

For locking brackets choose

Example: 14015- PZB

PDF: igus.com/e-chain-pdfs
Product information: igus.com/e-chains



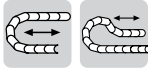

Option 3: plastic

- Unsupported applications
- Space-restricted conditions
- Strain relief with detachable tiwrap plates
- Can be attached at either the fixed end or the moving end

Moving end with bore
15000...3PZ(B)

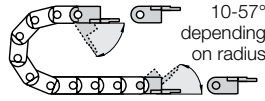

Fixed end with pin
15000...4PZ(B)



Part Number Structure

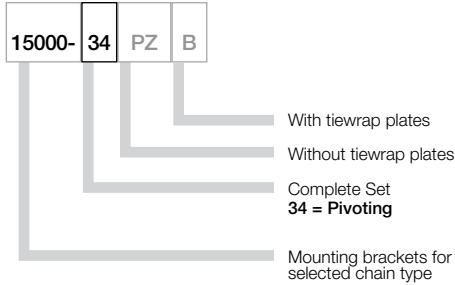

15000...3PZ(B)
Moving end

15000...4PZ(B)
Fixed end

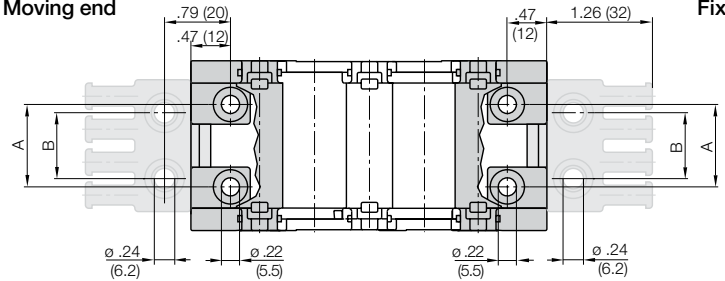

Full set, for both ends:

15000-34-PZB Full set, each part with pin/bore + tiwrap plate

Single-part order:

15000-3-PZB Mounting bracket with bore + tiwrap plate

15000-4-PZB Mounting bracket with pin + tiwrap plate

For Chain Type	Part No. Full Set with Tiwrap Plate	Part No. Full Set without Tiwrap Plate	Part No. Full Set with Tiwrap Plate + 10 cable ties	Dimension A in. (mm)	Dimension B in. (mm)
1400/1500-015	-	-	-	-	-
1400/1500-020	-	-	-	-	-
1400/1500-025	15000-025-34PZB	15000-025-34PZ	15000-025-34PZBK1	.47 (12)	.59 (15)
1400/1500-038	15000-038-34PZB	15000-038-34PZ	15000-038-34PZBK1	.98 (25)	.79 (20)
1400/1500-050	15000-050-34PZB	15000-050-34PZ	15000-050-34PZBK1	1.46 (37)	1.18 (30)
1400/1500-068	15000-068-34PZB	15000-068-34PZ	15000-068-34PZBK1	2.17 (55)	1.57 (40)
1400/1500-080	15000-080-34PZB	15000-080-34PZ	15000-080-34PZBK1	2.64 (67)	2.36 (60)
1400/1500-100	15000-100-34PZB	15000-100-34PZ	15000-100-34PZBK1	3.43 (87)	3.15 (80)
1400/1500-125	15000-125-34PZB	15000-125-34PZ	15000-125-34PZBK1	4.41 (112)	4.13 (105)

e-chain system® E2/000

Series 1400/1500

Mounting Brackets - Steel



1400
1500

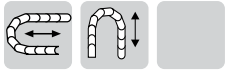

Option 4: Steel

- Locked connections
- One part (two-piece) for all chain widths
- Electrically conductive
- Bolted connection outside of chain cross-section possible

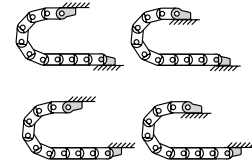
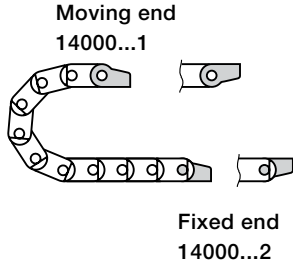

Possible installation configurations -

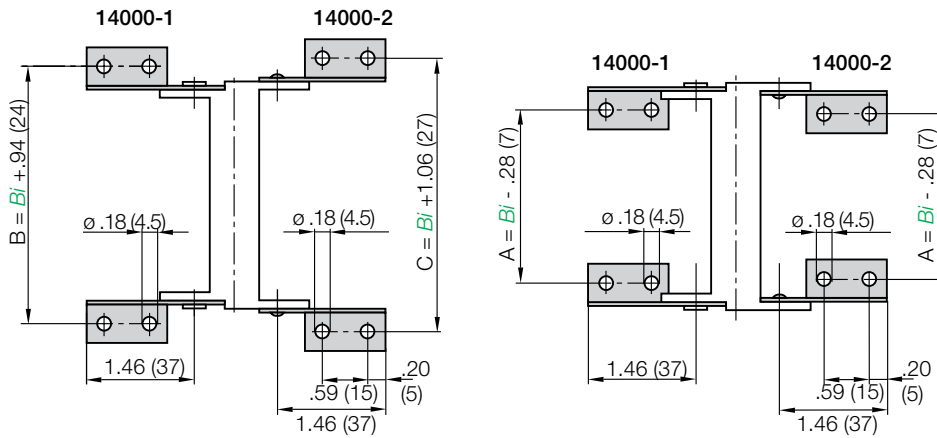

Chain Type	Part No. Full Set	Dimension A		Dimension B		Dimension C	
		in.	(mm)	in.	(mm)	in.	(mm)
1400/1500-015	14000-12	.31	(8)	1.54	(39)	1.65	(42)
1400/1500-020	14000-12	.51	(13)	1.73	(44)	1.85	(47)
1400/1500-025	14000-12	.71	(18)	1.93	(49)	2.05	(52)
1400/1500-038	14000-12	1.22	(31)	2.44	(62)	2.56	(65)
1400/1500-050	14000-12	1.69	(43)	2.91	(74)	3.03	(77)
1400/1500-068	14000-12	2.40	(61)	3.62	(92)	3.74	(95)
1400/1500-080	14000-12	2.87	(73)	4.09	(104)	4.21	(107)
1400/1500-100	14000-12	3.66	(93)	4.88	(124)	5.00	(127)
1400/1500-125	14000-12	4.65	(118)	5.87	(149)	5.98	(152)

Part No. Mounting Brackets Full Set

4 parts, 2 with pin, 2 with bore
Series 1400/1500:
14000-12

Part No. Mounting Bracket Moving End

2 parts, 1 left & 1 right
Series 1400/1500:
14000-1

Part No. Mounting Bracket Fixed End

2 parts, 1 left & 1 right
Series 1400/1500:
14000-2

PDF: igus.com/e-chain-pdfs
Product information: igus.com/e-chains



Tiewrap Plates

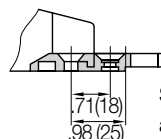

Shown assembled

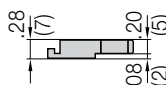

Single tiewrap plate

Option 1:

Tiewrap plates as an individual part

Available as an individual component, can be fixed onto a mounting bracket with the use of a profile rail.

Tiewrap Plates	n Number of Teeth	Dimension C	Dimension B
2020-ZB	3	1.18 (30)	.59 (15)
2030-ZB	4	1.57 (40)	.79 (20)
2040-ZB	5	1.97 (50)	1.18 (30)
2050-ZB	6	2.36 (60)	1.57 (40)
2070-ZB	8	3.15 (80)	2.36 (60)
2090-ZB	9	3.54 (90)	2.76 (70)
2100-ZB	10	3.94 (100)	3.15 (80)
2125-ZB	12	4.72 (120)	3.94 (100)

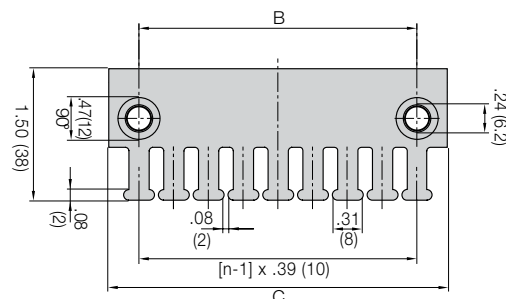

For more information please refer to strain relief section of Chapter 10



Strain relief for steel mounting brackets

Clip-on connection is not possible with steel mounting brackets. In this case, the tiewrap plates must be bolted directly into separate bore holes in front of the mounting bracket. Alternatively the tiewrap plates 20XX-ZB can be also used here. Details chapter 10



Cable tiewraps as individual parts

Cable tiewraps 100 pieces/bag	Width x Length		Maximum Ø		Tensile Strength	
	in.	(mm)	in.	(mm)	lbs	(N)
CFB-001	.19	x 5.91 (4.8 x 150)	1.42	(36)	50	(222)



1400
1500

PDF: igus.com/e-chain-pdfs
Product information: igus.com/e-chains

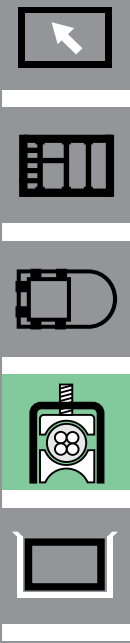

Price Index



Series R1480

Special Features / Options

IPA Qualification Certificate
Air Cleanliness Class ISO Class 3
(at v = 6.56 ft/s) upon request

ESD classification:
Electrically conductive ESD/
ATEX version upon request

Flammability Class
VDE 0304 IIC UL94 HB

Assembly Tips



Insert screwdriver into the slot, using a lever action apply pressure to the screwdriver to release

Other Installation Methods

Vertical, hanging ≤ 65.6 ft (20 m)

Vertical, standing ≤ 6.56 ft (2 m)

Side-mounted, un_supp. ≤ 2.3 ft (0.7 m)

Rotary requires further calculation

Usage Guidelines



- If hinged, snap-open accessibility along the inner radius is required
- If integrated strain relief is required at the connection point
- If long service life is required
- If chip protection is required
- If easy installation is required



- If the application is very simple
➤ **Series E14 E-Z Chain**
- If greater stability is needed
➤ **Series E4-21 System E4-1**
- If an e-tube with a small bending radius is required
➤ **Series R117 E2 Tubes**

Features & Benefits

- 1 Tried-and-tested mounting bracket
- 2 Snap-open crossbar for easy opening from the left or right
- 3 Series 1450 snap-open on both sides along inner radius
- 4 Series 1480 snap-open on both sides along inner radius
- 5 Integrated strain relief possible
- 6 Modular interior separation
- 7 Easy assembly by optimized pin
- 8 Double stop dog for long unsupported length
- 9 Crossbars with high retention force
- 10 Also available as ESD version

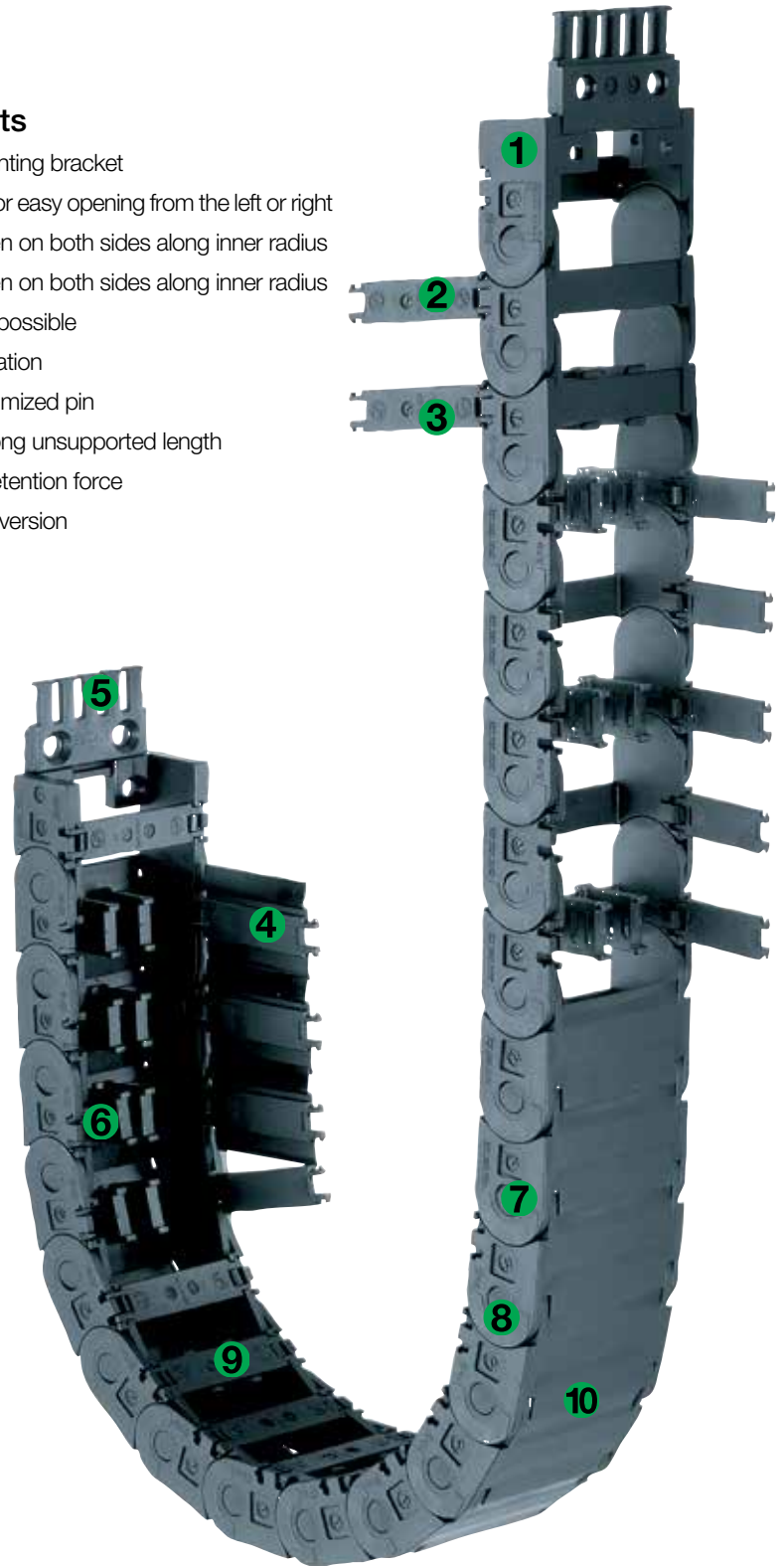

Order Example: Complete e-chain®

Please indicate chain length or number of links. Example:

3.28 ft (1 m) **1480-038-075-0**

e-chain®

With 2 separators **14501** assembled every 2nd link

Interior Separation

1 Set **15000-038-34PZB**

Mounting Bracket

e-chain system® E2/000

Series 1450/1480 Half-Tubes and Full Tubes

Installation Dimensions



1450
1480

Short travel, unsupported length

- FL_B = unsupported with permitted sag
 - FL_G = unsupported with straight upper run
- Further information ► Design, Chapter 1

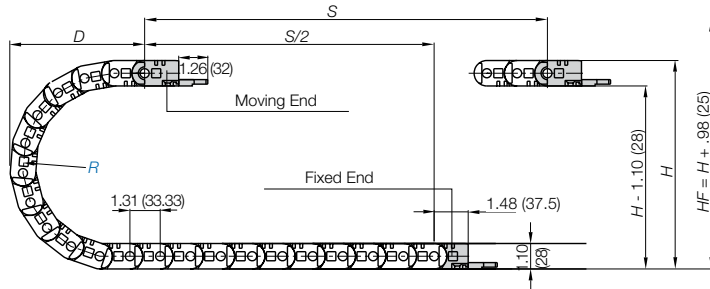
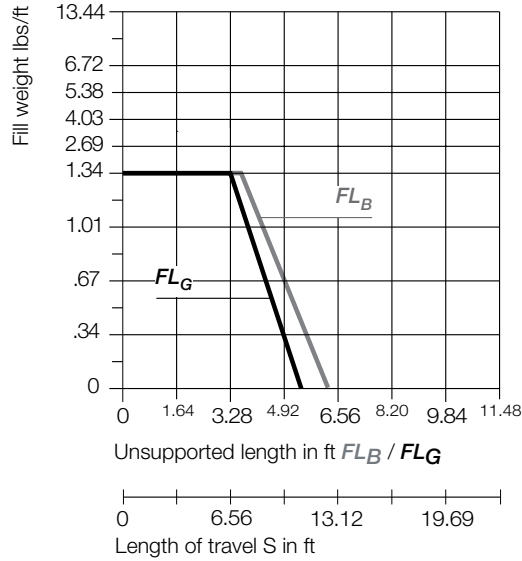
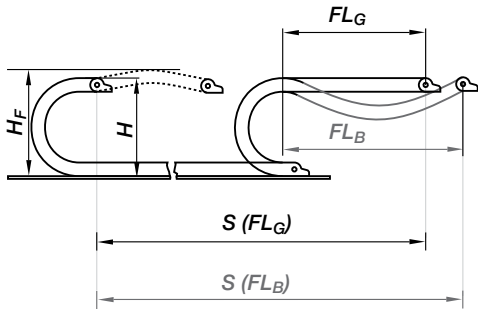

Pitch per link = 1.31" (33 mm)
 Links per ft (m) = 9.16 (30)
 For center mount applications:
 Chain length = $S/2 + K$

The required clearance height: $H_F = H + .98$ in. (25 mm) (with .34 lbs/ft (0.5 kg/m) fill weight).
 Please consult igus® if space is particularly restricted.

R	2.95 (075)	3.94 (100)	4.92 (125)	5.71 (145)	7.09 (180)
H	7.01 (178)	8.98 (228)	10.94 (278)	12.52 (318)	15.28 (388)
D	5.47 (139)	6.46 (164)	7.44 (189)	8.23 (209)	9.61 (244)
K	12.01 (305)	15.16 (385)	18.11 (460)	20.67 (525)	25.00 (635)

Short Travels - Unsupported



Unsupported e-chains® feature positive camber over short travels. This must be accounted for when specifying the clearance height. Please refer to **Installation dimensions** for further details.

Legend

- S = Length of travel
- R = Bending radius
- H = Nominal clearance height
- D = Overlength e-chain® radius in final position
- $K = \pi \cdot R + \text{safety buffer}$
- H_F = Required clearance height



PDF: igus.com/e-chain-pdfs
 Product information: igus.com/e-chains



Speed / acceleration FL_G	max. 65.6 ft/s (20 m/s) / max. 656 ft/s ² (200 m/s ²)
Speed / acceleration FL_B	max. 9.84 ft/s (3 m/s) / max. 19.69 ft/s ² (6 m/s ²)
Material - permitted temperature	igumid G / -40°F (-40°C) up to +248°F (+120° C)
Flammability Class, igumid G	VDE 0304 IIC UL94 HB

Technical Data



Details of material properties

► Chapter 1

Series 1450 - Half e-tube - Snap-open along the inner radius

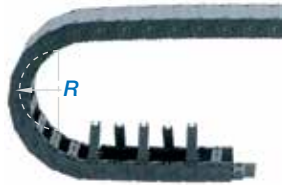
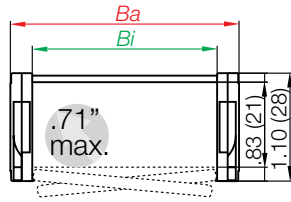

Part Number Structure

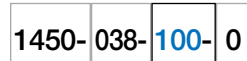

Color - Black
Bending radius
Width
Series

Series 1480 - hinged, snap-open along the inner radius

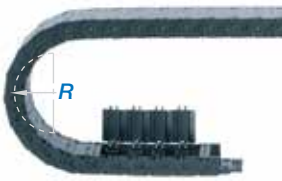
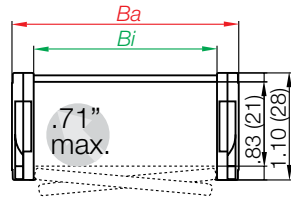

Part Number Structure



Color - Black
Bending radius
Width
Series

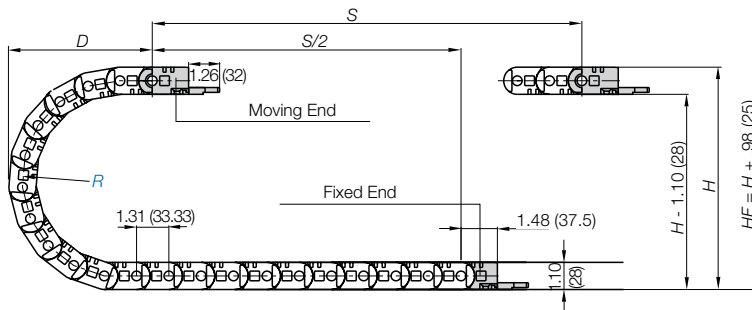

Supplement part number with required radius. Example: 1480-038--0
Pitch: 1.31 in. (33 mm) per link links/ft(m) = 9.41 (30)

Part Number.

Half e-tube Snap-open Inner Radius	Full e-tube Snap-open Inner Radius		<i>Bi</i> in. (mm)	<i>Ba</i> in. (mm)	Weight 1450 lbs/ft (kg/m)	Weight 1480 lbs/ft (kg/m)
1450-015-	1480-015-	<input type="text" value=""/> -0	.79 (15)	1.12 (28.5)	≈ 0.32 (0.48)	≈ 0.34 (0.50)
1450-025-	1480-025-	<input type="text" value=""/> -0	.98 (25)	1.52 (38.5)	≈ 0.36 (0.54)	≈ 0.38 (0.57)
1450-038-	1480-038-	<input type="text" value=""/> -0	1.50 (38)	2.03 (51.5)	≈ 0.40 (0.59)	≈ 0.41 (0.61)
1450-050-	1480-050-	<input type="text" value=""/> -0	1.97 (50)	2.50 (63.5)	≈ 0.44 (0.65)	≈ 0.45 (0.67)
1450-068-	1480-068-	<input type="text" value=""/> -0	2.68 (68)	3.21 (81.5)	≈ 0.50 (0.74)	≈ 0.52 (0.77)
1450-080-	1480-080-	<input type="text" value=""/> -0	3.15 (80)	3.68 (93.5)	≈ 0.54 (0.80)	≈ 0.56 (0.84)
1450-100-	1480-100-	<input type="text" value=""/> -0	3.94 (100)	4.47 (113.5)	≈ 0.60 (0.90)	≈ 0.65 (0.96)
1450-125-	1480-125-	<input type="text" value=""/> -0	4.92 (125)	5.45 (138.5)	≈ 0.69 (1.03)	≈ 0.73 (1.08)

Choose from the radii below for all of the above sizes
Radius (mm) Example: 1480-038--0

	075	100	125	145	180
R	2.95 (075)	3.94 (100)	4.92 (125)	5.71 (145)	7.09 (180)
H	7.01 (178)	8.98 (228)	10.94 (278)	12.52 (318)	15.28 (388)
D	5.47 (139)	6.46 (164)	7.44 (189)	8.23 (209)	9.61 (244)
K	12.01 (305)	15.16 (385)	18.11 (460)	20.67 (525)	25.00 (635)

e-chain system® E2/000

Series 1450/1480 Half-Tubes and Full Tubes

Interior Separation



1450
1480

Option 1: Vertical separators

Vertical separators are used if a vertical subdivision of the e-tube interior is required. By standard, vertical separators are assembled every other e-chain® link.

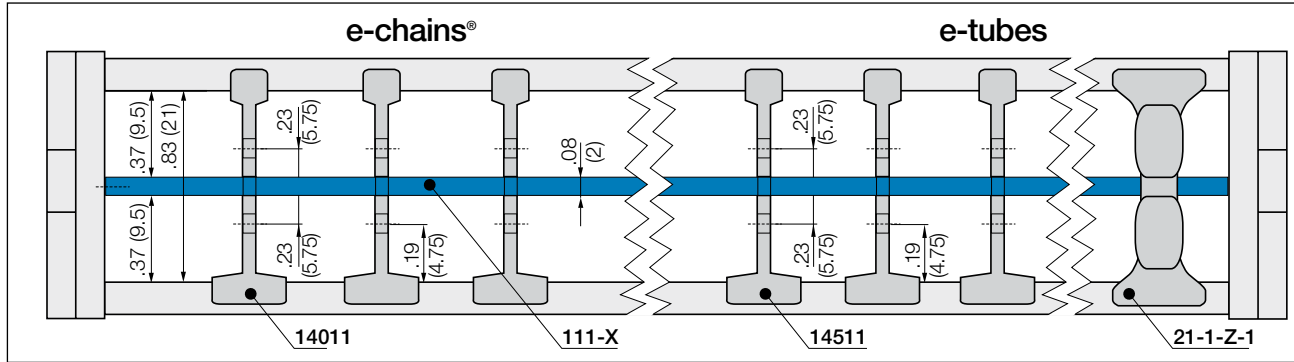

Separators, full-width shelves

In the standard configuration separators are assembled every 2nd e-chain® link

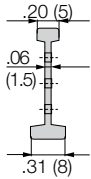
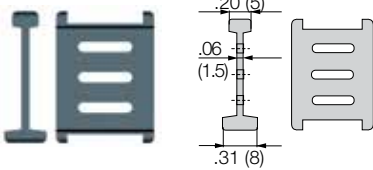
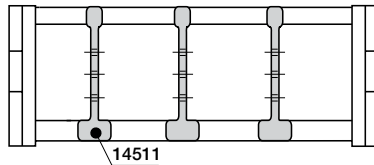

Slotted separator for e-tubes

Unassembled	Part No. 14501
Assembled	Part No. 14511

- **Slotted separator 14501 (Tubes only)** is used when vertical and horizontal separation is required. Due to its slot, it allows basic vertical/horizontal shelving arrangements.

Option 2: Full-width shelf

It is ideal for use in applications involving many thin cables with similar or identical diameters. This shelf slides into place and spans the entire width of the chain.

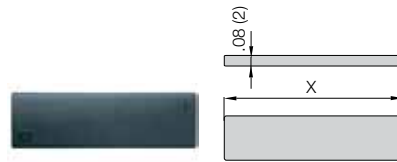
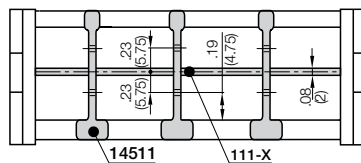

Width X	Part No.	Part No.
in. (mm)	Unassembled	Assembled
0.59 (15)	110-15	111-15
0.79 (20)	110-20	111-20
0.98 (25)	110-25	111-25
1.50 (38)	110-38	111-38
1.97 (50)	110-50	111-50
2.68 (68)	110-68	111-68
3.15 (80)	110-80	111-80
3.94 (100)	110-100	111-100
4.92 (125)	110-125	111-125

- **Full-width shelf 110-X (Chains®/Tubes)** this option makes sense in applications with many thin cables with similar diameters. For a consequent subdivision. Full-width shelves can be inserted at 3 different heights in .23" (5.75mm) increments

PDF: igus.com/e-chain-pdfs
Product information: igus.com/e-chains



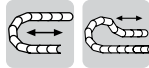

Standard

Option 1: pivoting

- Unsupported and gliding applications
- Space-restricted conditions
- Integrated strain relief
- Easy to assemble
- Various mounting positions

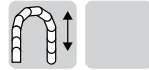
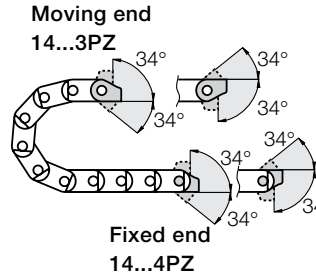

Option 2: locking

- Unsupported applications
- Extreme speed/accelerations
- If space is limited for height (H_f)
- Various mounting positions

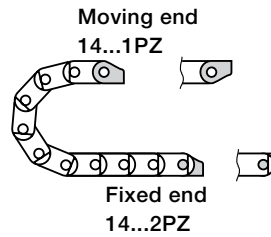

Part Number Structure

14015- 34 PZ

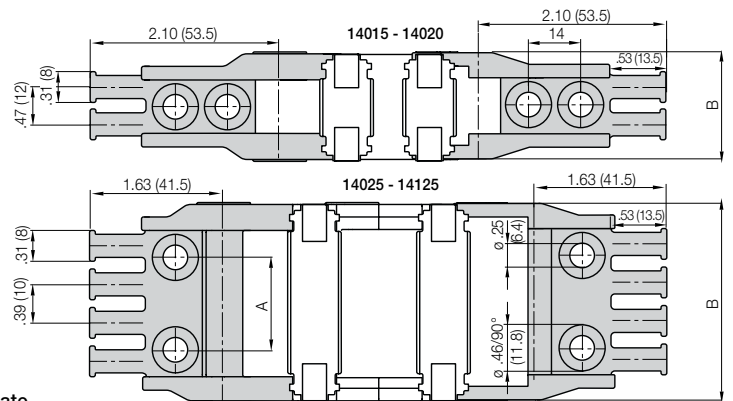
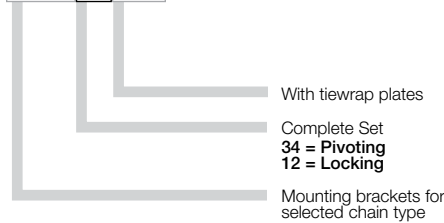

Full set, for both ends:

14015- 34 PZ Full set, each part with pin/bore + tiwrap plate

Single-part order:

14015- 3 PZ Mounting bracket with bore + tiwrap plate

14015- 4 PZ Mounting bracket with pin + tiwrap plate

For Chain Type	Part No. Full Set with Tiewrap Plate	Dimension A		Dimension B		Number
		in.	(mm)	in.	(mm)	
1450/1480-015	14015- <input type="checkbox"/> PZ	-	-	1.12	(28.5)	2
1450/1480-020	14020- <input type="checkbox"/> PZ	-	-	1.32	(33.5)	2
1450/1480-025	14025- <input type="checkbox"/> PZ	.51	(13)	1.52	(38.5)	2
1450/1480-038	14038- <input type="checkbox"/> PZ	.94	(24)	2.03	(51.5)	4
1450/1480-050	14050- <input type="checkbox"/> PZ	1.42	(36)	2.50	(63.5)	6
1450/1480-068	14068- <input type="checkbox"/> PZ	2.13	(54)	3.21	(81.5)	7
1450/1480-080	14080- <input type="checkbox"/> PZ	2.60	(66)	3.68	(93.5)	8
1450/1480-100	14100- <input type="checkbox"/> PZ	3.39	(86)	4.47	(113.5)	10
1450/1480-125	14125- <input type="checkbox"/> PZ	4.37	(111)	5.45	(138.5)	13

34 or 12

For pivoting brackets choose 34

For locking brackets choose 12

Example: 14015- 34 PZB

e-chain system® E2/000

Series 1450/1480 Half-Tubes and Full Tubes

Mounting Brackets - Plastic



1450
1480

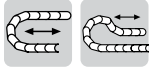

Option 3: plastic

- Unsupported applications
- Space-restricted conditions
- Strain relief with detachable tiewrap plates
- Can be attached at either the fixed end or the moving end



Part Number Structure

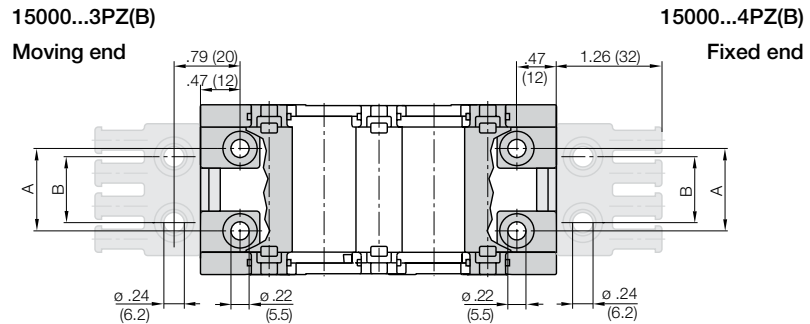
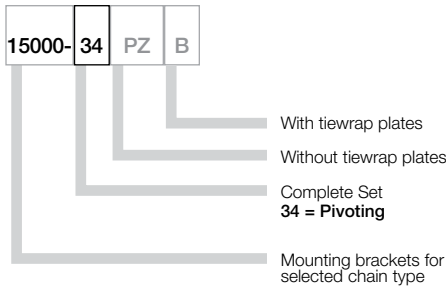

Full set, for both ends:

15000-34-PZB Full set, each part with pin/bore + tiewrap plate

Single-part order:

15000-3-PZB Mounting bracket with bore + tiewrap plate

15000-4-PZB Mounting bracket with pin + tiewrap plate

Part No. Mounting Brackets Full Set

4 parts, 2 with pin, 2 with bore

Series 1480:

15000-Width-34

Part No. Mounting bracket with bore

2 parts, 1 left & 1 right

Series 1480:

15000-Width-3

Part No. Mounting bracket with pin

2 parts, 1 left & 1 right

Series 1480:

15000-Width-4

For Chain Type	Part No. Full Set with Tiewrap Plate	Part No. Full Set with Tiewrap Plate + 10 cable ties	Dimension A		Dimension B	
			in.	(mm)	in.	(mm)
1450/1480-025	15000-025-34PZB	15000-025-34PZBK1	.47	(12)	.59	(15)
1450/1480-038	15000-038-34PZB	15000-038-34PZBK1	.98	(25)	.79	(20)
1450/1480-050	15000-050-34PZB	15000-050-34PZBK1	1.46	(37)	1.18	(30)
1450/1480-068	15000-068-34PZB	15000-068-34PZBK1	2.17	(55)	1.57	(40)
1450/1480-080	15000-080-34PZB	15000-080-34PZBK1	2.64	(67)	2.36	(60)
1450/1480-100	15000-100-34PZB	15000-100-34PZBK1	3.43	(87)	3.15	(80)
1450/1480-125	15000-125-34PZB	15000-125-34PZBK1	4.41	(112)	4.13	(105)

PDF: igus.com/e-chain-pdfs
Product information: igus.com/e-chains



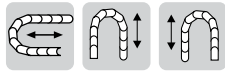

Option 4: steel

- Locked connections
- One part (two-piece) for all chain widths
- Electrically conductive
- Bolted connection outside of chain cross-section possible

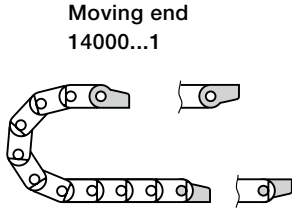

Fixed end
14000...2

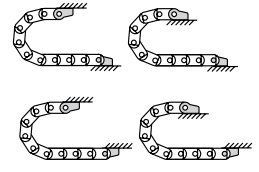

Possible installation configurations -

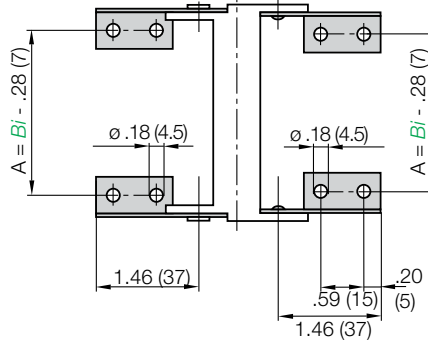
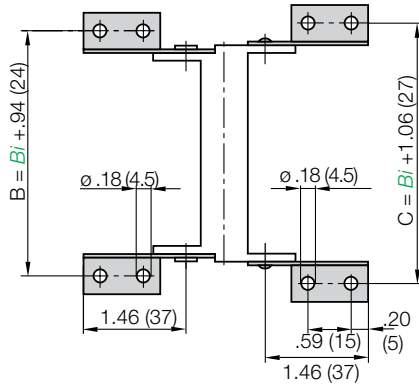

Chain Type	Part No. Full Set	Dimension A		Dimension B		Dimension C	
		in.	(mm)	in.	(mm)	in.	(mm)
1450/1480-015	14000-12	.31	(8)	1.54	(39)	1.65	(42)
1450/1480-020	14000-12	.51	(13)	1.73	(44)	1.85	(47)
1450/1480-025	14000-12	.71	(18)	1.93	(49)	2.05	(52)
1450/1480-038	14000-12	1.22	(31)	2.44	(62)	2.56	(65)
1450/1480-050	14000-12	1.69	(43)	2.91	(74)	3.03	(77)
1450/1480-068	14000-12	2.40	(61)	3.62	(92)	3.74	(95)
1450/1480-080	14000-12	2.87	(73)	4.09	(104)	4.21	(107)
1450/1480-100	14000-12	3.66	(93)	4.88	(124)	5.00	(127)
1450/1480-125	14000-12	4.65	(118)	5.87	(149)	5.98	(152)

Part No. Mounting Brackets Full Set

4 parts, 2 with pin, 2 with bore
Series 1480:
14000-12

Part No. Mounting Bracket Moving End

2 parts, 1 left & 1 right
Series 1480:
14000-1

Part No. Mounting Bracket Fixed End

2 parts, 1 left & 1 right
Series 1480:
14000-2

e-chain system® E2/000

Series 1450/1480 Half-Tubes and Full Tubes

Mounting Bracket - Steel



1450
1480

Tiewrap Plates

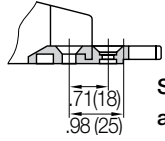

Shown assembled

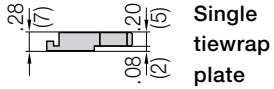

Single tie-wrap plate

Option 1: Tiewrap plates as an individual part

Available as an individual component, can be fixed onto a mounting bracket with the use of a profile rail.

Tiewrap Plates	n Number of Teeth	Dimension C	Dimension B
2020-ZB	3	1.18 (30)	.59 (15)
2030-ZB	4	1.57 (40)	.79 (20)
2040-ZB	5	1.97 (50)	1.18 (30)
2050-ZB	6	2.36 (60)	1.57 (40)
2070-ZB	8	3.15 (80)	2.36 (60)
2090-ZB	9	3.54 (90)	2.76 (70)
2100-ZB	10	3.94 (100)	3.15 (80)
2125-ZB	12	4.72 (120)	3.94 (100)

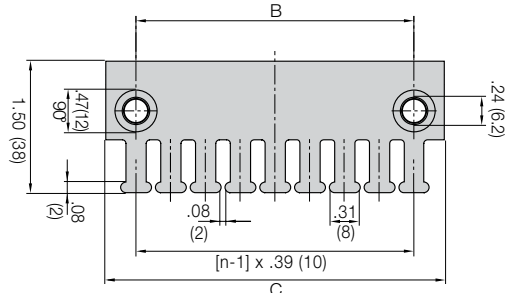

For more information please refer to strain relief section of Chapter 10



Cable tiewraps as individual parts

Cable tiewraps 100 pieces/bag	Width x Length		Maximum Ø		Tensile Strength	
	in.	(mm)	in.	(mm)	lbs	(N)
CFB-001	.19 x 5.91	(4.8 x 150)	1.42	(36)	50	(222)



Strain relief for steel mounting brackets

Clip-on connection is not possible with steel mounting brackets. In this case, the tie-wrap plates must be bolted directly into separate bore holes in front of the mounting bracket. Alternatively the tie-wrap plates 20XX-ZB can be also used here. **Details chapter 10**

PDF: igus.com/e-chain-pdfs
Product information: igus.com/e-chains



2400
2500



e-chain system® E2/000 Series 2400/2500



Price Index



Series 2400/2500

Special Features / Options



IPA Qualification Certificate, Air Cleanliness Class ISO Class 3 (at v = 2 m/s) upon request



ESD classification: Electrically conductive ESD/ATEX version upon request



UL94 V2 classifications upon request

Assembly Tips



Snap-open mechanism, choice of snap-open on left or right. Hinged crossbar can be swiveled by more than 180° on both sides. Lightning-fast closing by hand. Secure fit without additional locking devices.

Other Installation Methods

Vertical, hanging ≤ 131.24 ft (40 m)

Vertical, standing ≤ 9.84 ft (3 m)

Side-mounted, un supp. ≤ 3.28 ft (1 m)

Rotary requires further calculation

Usage Guidelines



- If snap-open accessibility along the inner or outer radius is required
- If integrated strain relief at the mounting point is required
- If modular interior separation is needed
- If long service life is required
- If easy installation is required



- If the application is very simple
➤ Series E200 E-Z Chain
- If greater stability is required
➤ Series E4-21 E4-1 Series

Features & Benefits

- 1 Tried-and-tested mounting bracket
- 2 Snap-open crossbar for easy opening from the left or right
- 3 Series 2500 snap-open on both sides along outer radius
- 4 Series 2400 snap-open on both sides along inner radius
- 5 Integrated strain relief possible
- 6 Modular interior separation
- 7 Easy assembly by optimized pin
- 8 Double stop dog for long unsupported length
- 9 Crossbars with high retention force
- 10 Also available as ESD version
- 11 Strain relief separator available

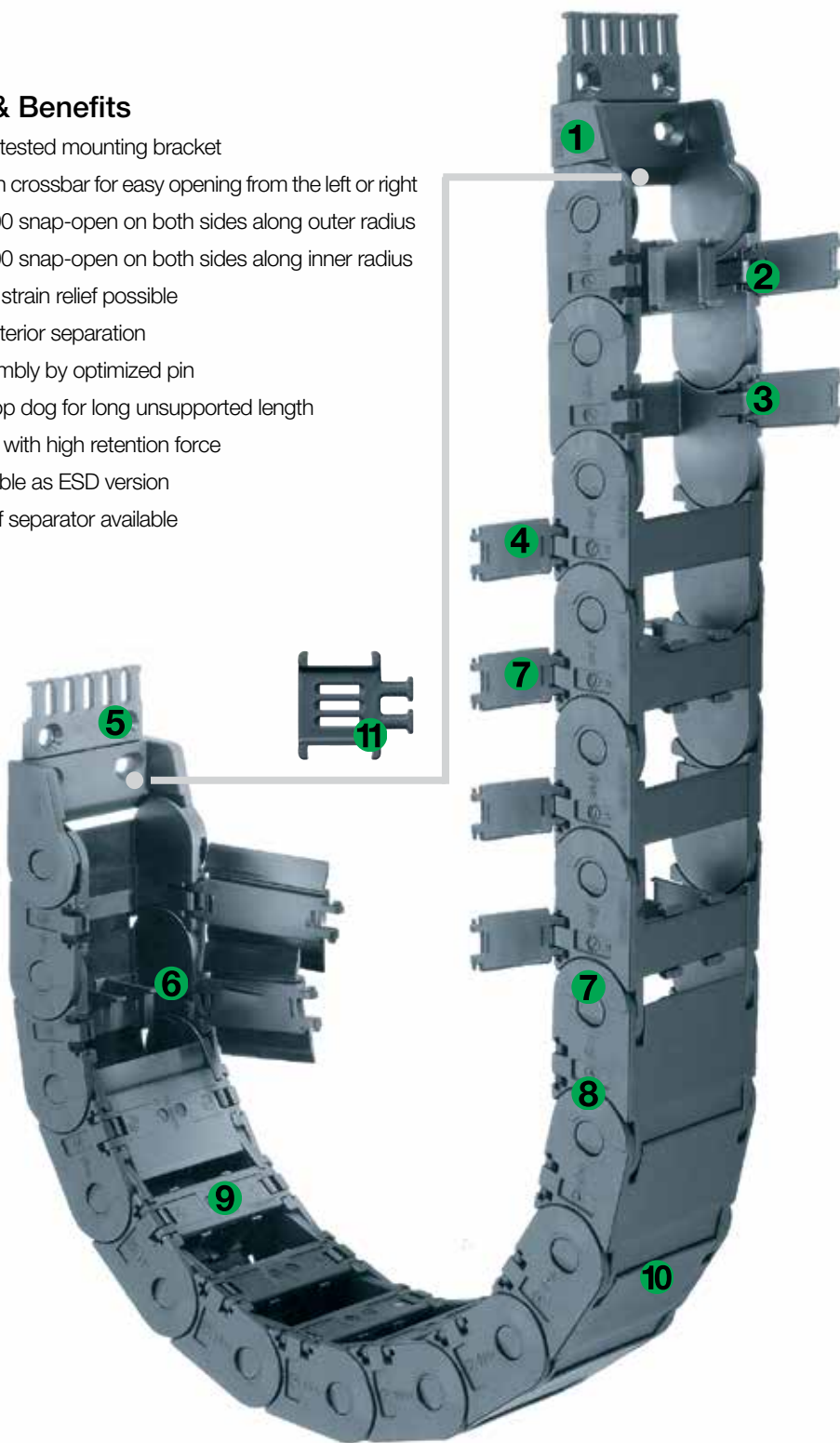

Order Example: Complete e-chain®

Please indicate chain length or number of links. Example:

9.84 ft (3 m) 2500-10-100-0



e-chain®

With 2 separators 25.1 assembled every 2nd link



Interior Separation

1 Set 2100-34PZB



Mounting Bracket

e-chain system® E2/000

Series 2400/2500

Installation Dimensions

Short travel, unsupported length

- FL_B = unsupported with permitted sag
 - FL_G = unsupported with straight upper run
- Further information ► Design, Chapter 1

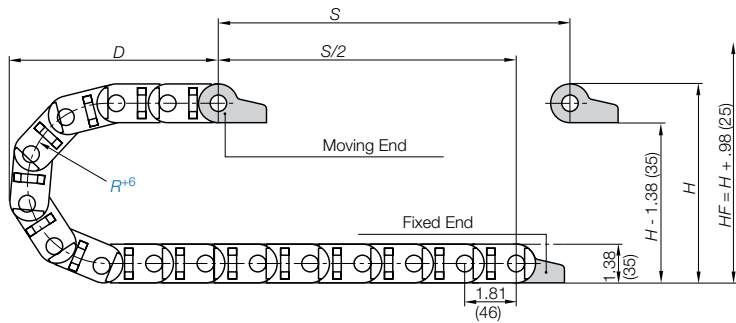
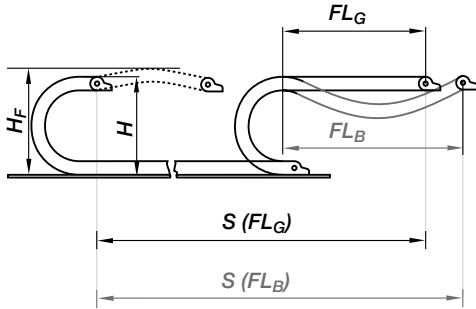

The required clearance height: $H_F = H + .98$ in. (25 mm) (with 1.01 lbs/ft (1.5 kg/m) fill weight). Please consult igus® if space is particularly restricted.

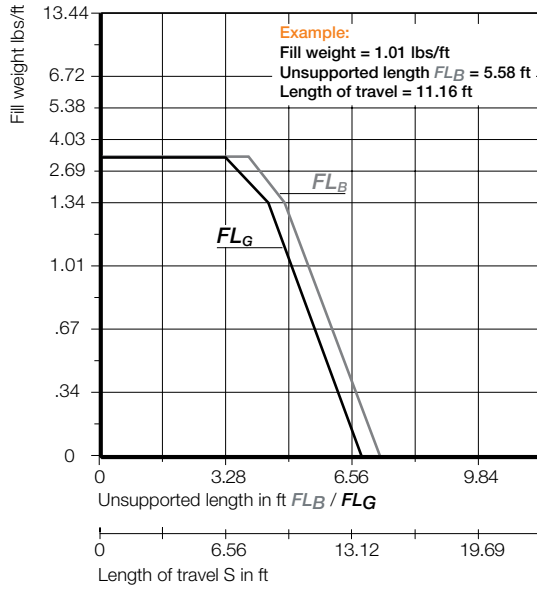

2400
2500

Short Travels - Unsupported



Unsupported e-chains® feature positive camber over short travels. This must be accounted for when specifying the clearance height. Please refer to **Installation dimensions** for further details.

Legend

- S = Length of travel
- R = Bending radius
- H = Nominal clearance height
- D = Overlength e-chain® radius in final position
- $K = \pi \cdot R + \text{safety buffer}$
- H_F = Required clearance height
- H_{RI} = Trough inner height
- H_2 = *Mounting height
- D_2 = Overlength - long travels, gliding
- K_2 = *Add-on

Pitch per link = 1.81" (46 mm)
Links per foot (m) = 6.71 (22)
For center mount applications:
Chain length = $S/2 + K$

*If the mounting bracket location is set lower

R	2.16 (055**)	2.95 (075)	3.94 (100)	4.92 (125)	5.91 (150)	6.89 (175)	7.87 (200)	8.86 (225)	9.84 (250)
H	5.71 (145)	7.28 (185)	9.25 (235)	11.22 (285)	13.19 (335)	15.16 (385)	17.13 (435)	19.09 (485)	21.06 (535)
D	5.59 (142)	6.38 (162)	7.36 (187)	8.35 (212)	9.33 (237)	10.31 (262)	11.30 (287)	12.28 (312)	13.27 (337)
K	10.43 (265)	12.99 (330)	16.14 (410)	19.09 (485)	22.24 (565)	25.39 (645)	28.54 (725)	31.50 (800)	34.65 (880)

**upon request

For long travels with lowered mounting height

Long travel lengths from 32.8 ft. (10 m) to max. 328 ft. (100 m)

Note: For using Series 2400 for long travels (gliding), please consult with igus® first.

For long travels, igus® specifies Series 2500 that snap open on the outer radius.

For center mount applications:

Chain length = $S/2 + K_2$

Long Travels - Gliding



If the unsupported length is exceeded, the e-chain®/ Tube must glide on itself. This requires a guide trough.

Design, Chapter 1

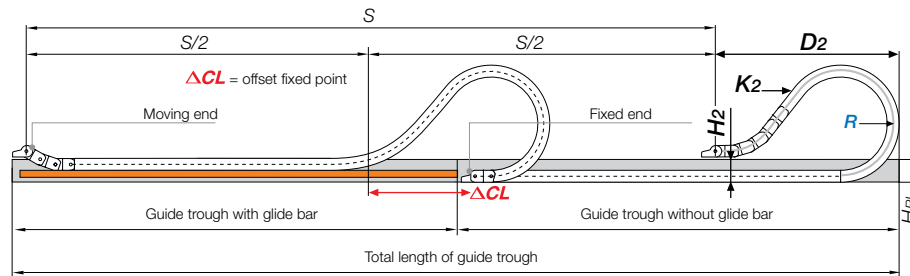

R	2.16 (055)	2.95 (075)	3.94 (100)	4.92 (125)	5.91 (150)	6.89 (175)	7.87 (200)	8.86 (225)	9.84 (250)
H_2	4.33 (110)	5.91 (150)	3.94 (100)	3.94 (100)	3.94 (100)	3.94 (100)	3.94 (100)	3.94 (100)	3.94 (100)
D_2^{25}	5.59 (142)	6.38 (162)	14.96 (380)	17.32 (440)	23.23 (590)	29.72 (755)	37.40 (950)	40.94 (1040)	44.49 (1130)
K_2	10.43 (265)	12.99 (330)	25.35 (644)	28.98 (736)	39.84 (1012)	48.90 (1242)	57.95 (1472)	63.39 (1610)	70.63 (1794)
ΔCL	—	—	8.03 (204)	9.61 (244)	14.33 (364)	19.84 (504)	26.54 (674)	29.69 (754)	31.65 (804)

Speed / acceleration FL_G	max. 65.6 ft/s (20 m/s) / max. 656 ft/s ² (200 m/s ²)
Speed / acceleration FL_B	max. 9.84 ft/s (3 m/s) / max. 19.69 ft/s ² (6 m/s ²)
Gliding speed / acceleration (maximum)	max. 32.8 ft/s (10 m/s) / max. 164 ft/s ² (50 m/s ²)
Material - permitted temperature	igumid G / -40°F (-40°C) up to +248°F (+120°C)
Flammability Class, igumid G	VDE 0304 IIC UL94 HB

Technical Data



Details of material properties

► Chapter 1



PDF: igus.com/e-chain-pdfs
Product information: igus.com/e-chains



2400
2500



e-chain system® E2/000
Series 2400/2500

igus®
e-chain system®

Series 2400 - snap-open along the inner radius

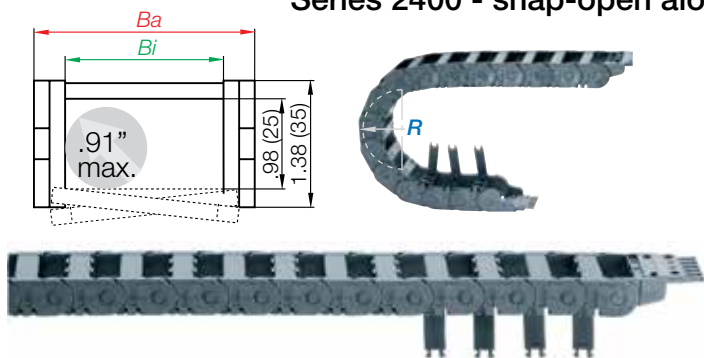

Part Number Structure

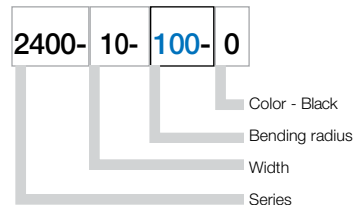

Series 2500 - snap-open along the outer radius

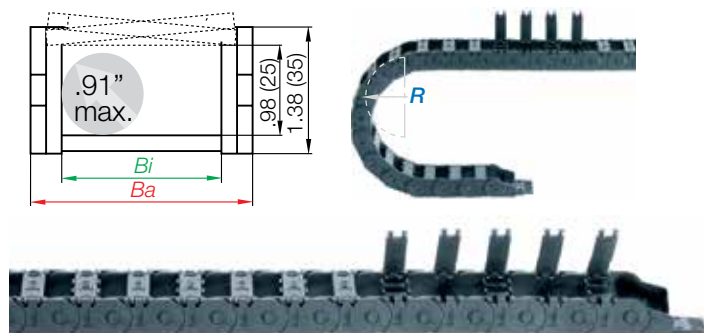

Part Number Structure

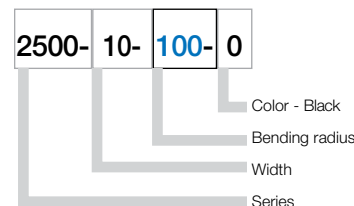

Telephone 1-800-521-2747

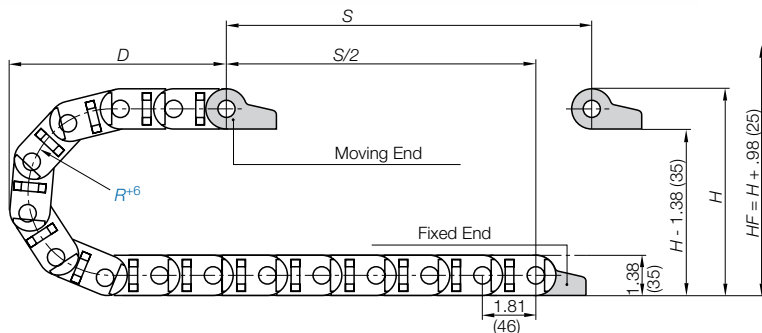

Supplement part number with required radius. Example: 2400-10--0
Pitch: 1.81 in. (46 mm) per link links/ft(m) = 6.71 (22)

Part Number.

2400-02- <input type="text"/> -0	2500-02- <input type="text"/> -0	Bi in. (mm)	Ba in. (mm)	Weight lbs/ft (kg/m)
2400-03- <input type="text"/> -0	2500-03- <input type="text"/> -0	1.50 (38)	2.13 (54)	≈ 0.56 (0.83)
2400-05- <input type="text"/> -0	2500-05- <input type="text"/> -0	2.24 (57)	2.87 (73)	≈ 0.61 (0.91)
2400-07- <input type="text"/> -0	2500-07- <input type="text"/> -0	3.03 (77)	3.66 (93)	≈ 0.68 (1.01)
2400-09- <input type="text"/> -0	2500-09- <input type="text"/> -0	3.50 (89)	4.13 (105)	≈ 0.73 (1.08)
2400-10- <input type="text"/> -0	2500-10- <input type="text"/> -0	4.06 (103)	4.69 (119)	≈ 0.77 (1.15)
2400-12- <input type="text"/> -0	2500-12- <input type="text"/> -0	4.92 (125)	5.55 (141)	≈ 0.82 (1.22)

Choose from the radii below for all of the above sizes
Radius (mm) Example: 2400-10--0

	055	075	100	125	150	175	200	225	250
R	2.16 (055)	2.95 (075)	3.94 (100)	4.92 (125)	5.91 (150)	6.89 (175)	7.87 (200)	8.86 (225)	9.84 (250)
H	5.71 (145)	7.28 (185)	9.25 (235)	11.22 (285)	13.19 (335)	15.16 (385)	17.13 (435)	19.09 (485)	21.06 (535)
D	5.59 (142)	6.38 (162)	7.36 (187)	8.35 (212)	9.33 (237)	10.31 (262)	11.30 (287)	12.28 (312)	13.27 (337)
K	10.43 (265)	12.99 (330)	16.14 (410)	19.09 (485)	22.24 (565)	25.39 (645)	28.54 (725)	31.50 (800)	34.65 (880)

Internet: igus.com
email: sales@igus.com
QuickSpec: igus.com/quickspec

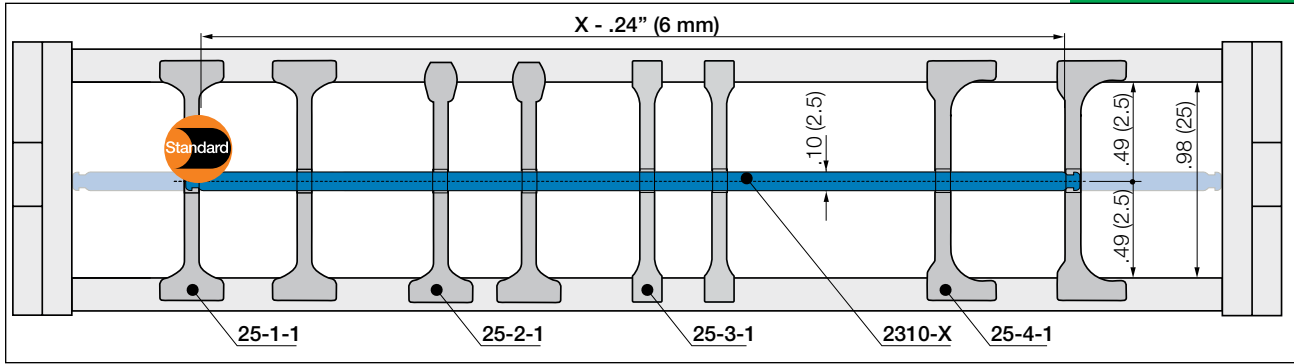

In the standard configuration separators are assembled every 2nd e-chain® link

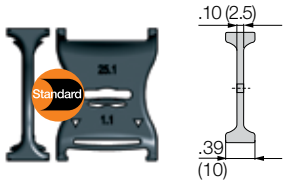

Separator, wide base

Unassembled	Part No. 25.1
Assembled	Part No. 25.1.1

- **Standard separator 25.1 for all applications**

Separator with wide base for maximum locking strength and safe standing in e-chains®.

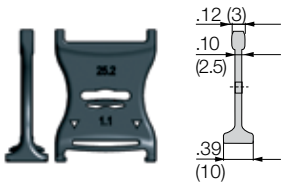

Separator, narrow head

Unassembled	Part No. 25.2
Assembled	Part No. 25.2.1

- **Separator 25.2**

For even faster installation
is used when vertical and horizontal separation is required. Due to its slot, it allows basic vertical/horizontal shelving arrangements.

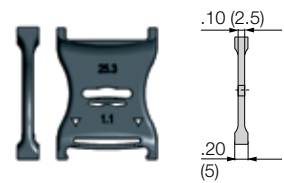

Separator, narrow base

Unassembled	Part No. 25.3
Assembled	Part No. 25.3.1

- **Separator 25.3**

For many thin cables
is used when vertical and horizontal separation is required. Due to its slot, it allows basic vertical/horizontal shelving arrangements.



Separator, asymmetrical

Unassembled	Part No. 25.4
Assembled	Part No. 25.4.1

- **Separator 25.4**

For side mounted applications
is used when vertical and horizontal separation is required. Due to its slot, it allows basic vertical/horizontal shelving arrangements.

Lockable full-width shelves - for the standard interior separation

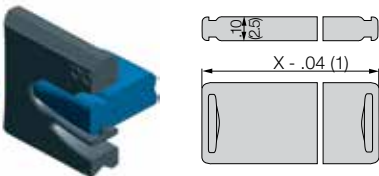

Full width shelf, lockable

Unassembled	Part No. 2300-X
Assembled	Part No. 2310-X

- **Full width shelf, lockable**

is used when vertical and horizontal separation is required. .

Width X in. (mm)	Part No. Unassembled	Part No. Assembled	Width X in. (mm)	Part No. Unassembled	Part No. Assembled	Width X in. (mm)	Part No. Unassembled	Part No. Assembled
0.59 (015)	2300-15	2310-15	2.36 (060)	2300-60	2310-60	3.43 (087)	2300-87	2310-87
0.98 (025)	2300-25	2310-25	2.44 (062)	2300-62	2310-62	3.54 (090)	2300-90	2310-90
1.18 (030)	2300-30	2310-30	2.56 (065)	2300-65	2310-65	3.94 (100)	2300-100	2310-100
1.50 (038)	2300-38	2310-38	2.76 (070)	2300-70	2310-70	4.06 (103)	2300-103	2310-103
1.57 (040)	2300-40	2310-40	2.95 (075)	2300-75	2310-75	4.33 (110)	2300-110	2310-110
1.97 (050)	2300-50	2310-50	3.03 (077)	2300-77	2310-77	4.72 (120)	2300-120	2310-120
2.24 (057)	2300-57	2310-57	3.15 (080)	2300-80	2310-80	4.92 (125)	2300-125	2310-125



2400
2500



e-chain system® E2/000
Series 2400/2500
Extender crossbars

igus®
e-chain system®

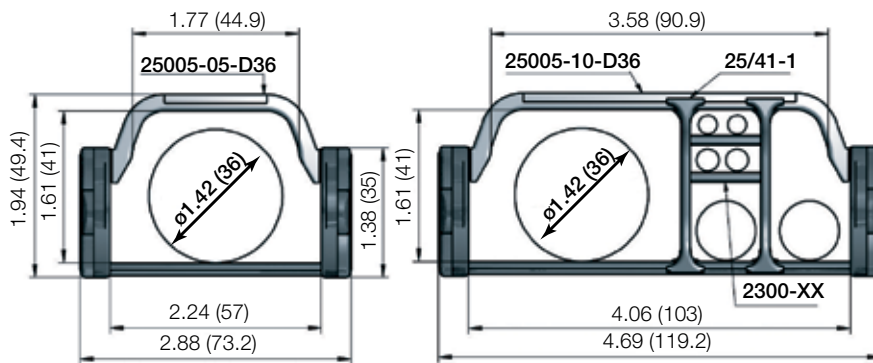

Part Number.

Extender crossbars
for e-chains®
that snap-open
along inner radius

Extender crossbars
for e-chains®
that snap-open
along outer radius

Bi

Ba

in. (mm)

in. (mm)

2400-05D36- -0

2500-05D36- -0

2.24 (57)

2.87 (73)

2400-10D36- -0

2500-10D36- -0

4.06 (103)

4.69 (119)

Choose from the radii below for all of the above sizes

Radius (mm)

Example: 2400-10D36- -0

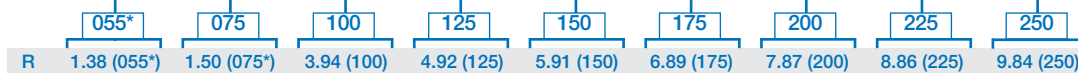

*Radius 055 only possible with Series 2500 e-chains®

Telephone 1-800-521-2747

Interior separation for extender crossbars

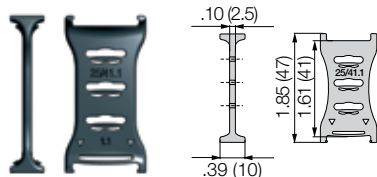

Separator, wide base

Unassembled Part No. 25/41.1

Assembled Part No. 25/41.1.1

- **Standard separator 25/41-1, wide base**
For maximum locking strength and base standing. In standard configuration separators are assembled every 2nd e-chain® link.

Lockable full-width shelves - for the standard interior separation

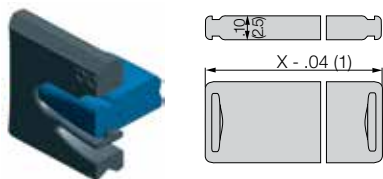

Full width shelf, lockable

Unassembled Part No. 2300-X

Assembled Part No. 2310-X

- **Full width shelf, lockable**
is used when vertical and horizontal separation is required. Due to its slot, it allows basic vertical/horizontal shelving arrangements.

Width X in. (mm)	Part No. Unassembled	Part No. Assembled	Width X in. (mm)	Part No. Unassembled	Part No. Assembled	Width X in. (mm)	Part No. Unassembled	Part No. Assembled
0.59 (015)	2300-15	2310-15	2.36 (060)	2300-60	2310-60	3.43 (087)	2300-87	2310-87
0.98 (025)	2300-25	2310-25	2.44 (062)	2300-62	2310-62	3.54 (090)	2300-90	2310-90
1.18 (030)	2300-30	2310-30	2.56 (065)	2300-65	2310-65	3.94 (100)	2300-100	2310-100
1.50 (038)	2300-38	2310-38	2.76 (070)	2300-70	2310-70	4.06 (103)	2300-103	2310-103
1.57 (040)	2300-40	2310-40	2.95 (075)	2300-75	2310-75	4.33 (110)	2300-110	2310-110
1.97 (050)	2300-50	2310-50	3.03 (077)	2300-77	2310-77	4.72 (120)	2300-120	2310-120
2.24 (057)	2300-57	2310-57	3.15 (080)	2300-80	2310-80	4.92 (125)	2300-125	2310-125

Separator with integrated strain relief

Strain relief separator Part No. 2020-Z can be integrated into the mounting bracket and can be placed there at any point of the e-chain®. It combines strain relief and interior separation, it can be installed on the first or last e-chain® link and is easy to assemble without any screws.

For more information ► Chapter 10, Strain Relief



Internet: igus.com
email: sales@igus.com
QuickSpec: igus.com/quickspec

e-chain system® E2/000

Series 2400/2500

Mounting Bracket - Plastic



2400
2500

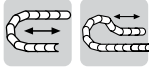

Option 1: pivoting

- For unsupported and gliding applications
- Well suited for tight installation conditions
- Detachable strain relief tiwrap plates
- Can be mounted on the fixed and/or moving end

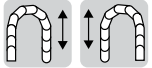
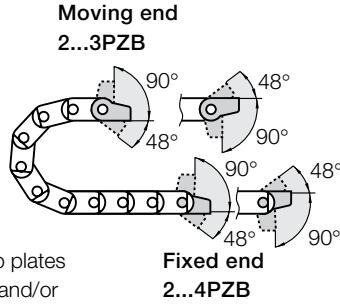

Option 2: locking

- For unsupported and gliding applications
- Extreme speed and/or accelerations
- For height restricted applications
- Can be mounted on the fixed and/or moving end

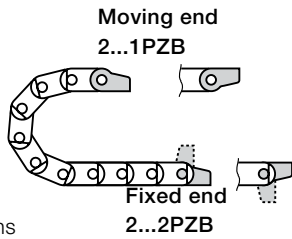

Part Number Structure



- With 10 cable tiwraps
- With tiwrap plates
- Complete Set
34 = Pivoting
12 = Locking
- Mounting brackets for selected chain type

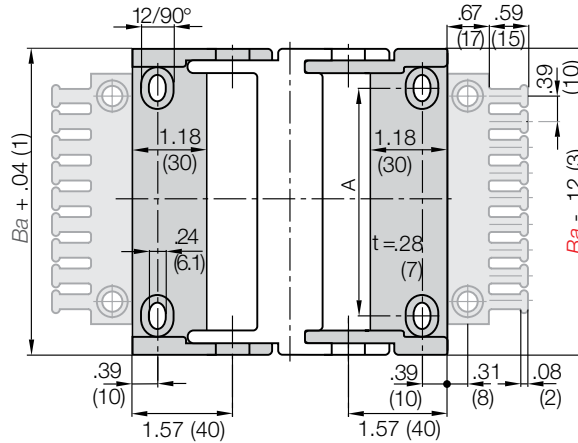

Full set, for both ends:

2020- 34 PZB Full set, each part with pin/bore + tiwrap plate

Single-part order:

- 2020- 3 PZB Mounting bracket with bore + tiwrap plate
- 2020- 4 PZB Mounting bracket with pin + tiwrap plate

Part No. Full Set (pivoting)

With Tiwrap Plates
Series 2400/2500:
2020-34PZB

Part No. Full Set (locking)

With Tiwrap Plates
+ 10 cable ties
Series 2400/2500:
2020-34PZBK1

For Chain Type	Part No. Full set without Tiwrap Plate	Part No. Full Set with Tiwrap Plate	Part No. Full Set with Tiwrap Plate + 10 cable ties	Dimension A in. (mm)	Number of teeth
2400/2500-02	2020- <input type="checkbox"/> PZ	2020- <input type="checkbox"/> PZB	2020- <input type="checkbox"/> PZBK1	.47 (12)	3
2400/2500-03	2030- <input type="checkbox"/> PZ	2030- <input type="checkbox"/> PZB	2030- <input type="checkbox"/> PZBK1	.98 (25)	4
2400/2500-05	2050- <input type="checkbox"/> PZ	2050- <input type="checkbox"/> PZB	2050- <input type="checkbox"/> PZBK1	1.73 (44)	6
2400/2500-07	2070- <input type="checkbox"/> PZ	2070- <input type="checkbox"/> PZB	2070- <input type="checkbox"/> PZBK1	2.52 (64)	8
2400/2500-09	2090- <input type="checkbox"/> PZ	2090- <input type="checkbox"/> PZB	2090- <input type="checkbox"/> PZBK1	3.03 (77)	9
2400/2500-10	2100- <input type="checkbox"/> PZ	2100- <input type="checkbox"/> PZB	2100- <input type="checkbox"/> PZBK1	3.54 (90)	10
2400/2500-12	2125- <input type="checkbox"/> PZ	2125- <input type="checkbox"/> PZB	2125- <input type="checkbox"/> PZBK1	4.41 (112)	12

34 or 12

For pivoting brackets choose 34
For locking brackets choose 12
Example: 2020- 34 PZB

PDF: igus.com/e-chain-pdfs
Product information: igus.com/e-chains



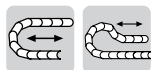

Option 1: pivoting

- For unsupported applications
- Bolted connection outside of chain cross section
- Confined installation conditions
- Attachment points on all sides
- Stackable

Moving end
24001...1

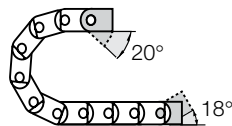

Fixed end
24001...2

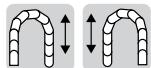

Option 2: locking

- For vertical hanging/standing applications
- Bolted connection outside of chain cross section
- For very high speeds and accelerations
- Attachment points on all sides
- Stackable

Moving end
24101...1

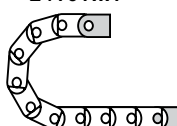

Fixed end
24101...2



Part Number Structure

24001-02-12ZB

- With tiwrap plates
- Complete Set
- Width
- Mounting brackets for selected chain type
24001 = Pivoting
24101 = Locking

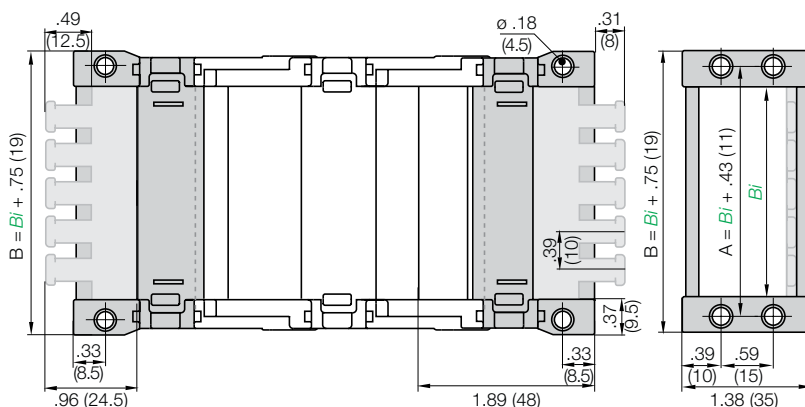

Full set, for both ends:

24001-12ZB Full set, each part with pin/bore + tiwrap plate

Single-part order:

24001-1ZB Mounting bracket with bore + tiwrap plate

24001-2ZB Mounting bracket with pin + tiwrap plate

Part No. Full Set (pivoting)

With Tiwrap Plates

Series 2480:

24001-Width-12ZB

Part No. Full Set (pivoting)

Without Tiwrap Plates

Series 2480:

24001-Width-12

For Chain Type	Part No. Full set with Tiwrap Plate	Part No. Full Set without Tiwrap Plate	Dimension A in.	Dimension A (mm)	Number of Teeth
2400/2500-02	24001-02-12ZB	24001-02-12	1.42	(36)	2
2400/2500-03	24001-03-12ZB	24001-03-12	1.93	(49)	4
2400/2500-05	24001-05-12ZB	24001-05-12	2.68	(68)	6
2400/2500-07	24001-07-12ZB	24001-07-12	3.46	(88)	7
2400/2500-09	24001-09-12ZB	24001-09-12	3.94	(100)	9
2400/2500-10	24001-10-12ZB	24001-10-12	4.49	(114)	10
2400/2500-12	24001-12-12ZB	24001-12-12	5.35	(136)	12

24001 or 24101

For pivoting brackets choose 24001

For locking brackets choose 24101

Example: 24001-02-12ZB

e-chain system® E2/000
 Series 2400/2500
 Mounting Bracket - Steel



2400
 2500

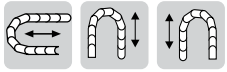

Option 1: Steel

- Pivoting connections
- One part (two-piece) for all chain widths
- Electrically conductive
- Bolted connection outside of chain cross-section possible

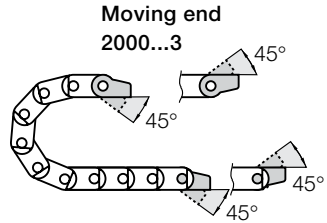

**Fixed end
 2000...2**

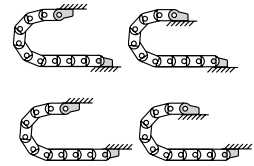
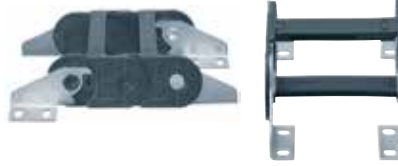

Possible installation configurations -

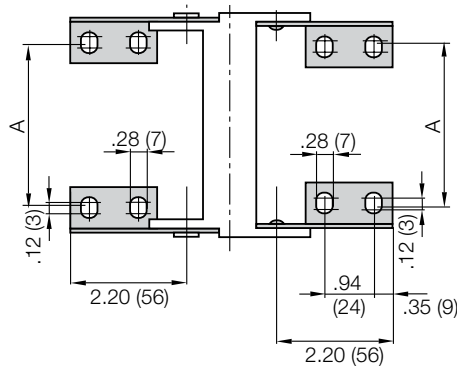
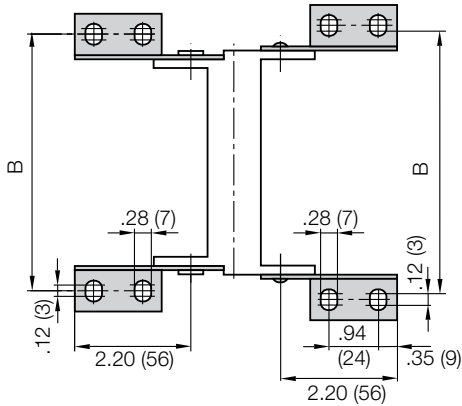

Chain Type	Part No. Full Set	Dimension A		Dimension B	
		in.	(mm)	in.	(mm)
2400/2500-02	2000-32	—	—	2.36	(60)
2400/2500-03	2000-32	.98	(25)	2.87	(73)
2400/2500-05	2000-32	1.73	(44)	3.62	(92)
2400/2500-07	2000-32	2.52	(64)	4.41	(112)
2400/2500-09	2000-32	2.99	(76)	4.88	(124)
2400/2500-10	2000-32	3.54	(90)	5.43	(138)
2400/2500-12	2000-32	4.41	(112)	6.30	(160)

Part No. Mounting Brackets Full Set
 4 parts, 2 with pin, 2 with bore
 Series 2400/2500:
2000-32

Part No. Mounting Bracket Moving End
 2 parts, 1 left & 1 right
 Series 2400/2500:
2000-3

Part No. Mounting Bracket Fixed End
 2 parts, 1 left & 1 right
 Series 2400/2500:
2000-2

PDF: igus.com/e-chain-pdfs
 Product information: igus.com/e-chains



Tiewrap Plates

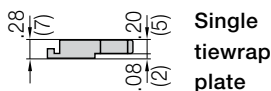
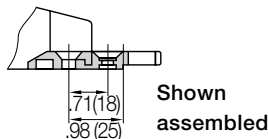

Option 1:

Tiewrap plates as an individual part

Available as an individual component, can be fixed onto a mounting bracket with the use of a profile rail.

Tiewrap Plates	n Number of Teeth	Dimension C	Dimension B
2020-ZB	3	1.18 (30)	.59 (15)
2030-ZB	4	1.57 (40)	.79 (20)
2040-ZB	5	1.97 (50)	1.18 (30)
2050-ZB	6	2.36 (60)	1.57 (40)
2070-ZB	8	3.15 (80)	2.36 (60)
2090-ZB	9	3.54 (90)	2.76 (70)
2100-ZB	10	3.94 (100)	3.15 (80)
2125-ZB	12	4.72 (120)	3.94 (100)

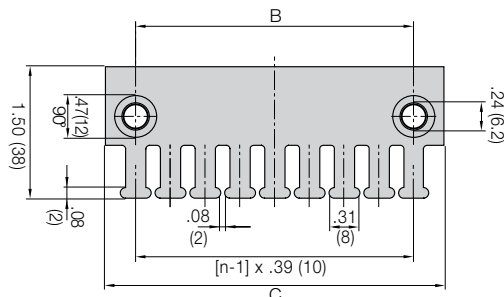

For more information please refer to strain relief section of Chapter 10



Cable tiewraps as individual parts

Cable tiewraps 100 pieces/bag	Width x Length		Maximum Ø		Tensile Strength	
	in.	(mm)	in.	(mm)	lbs	(N)
CFB-001	.19 x 5.91	(4.8 x 150)	1.42	(36)	50	(222)

Strain relief for steel mounting brackets

Clip-on connection is not possible with steel mounting brackets. In this case, the tie-wrap plates must be bolted directly into separate bore holes in front of the mounting bracket. Alternatively the tie-wrap plates **20XX-ZB** can be also used here. **Details chapter 10**

e-chain[®] E2/000

Series 2400/2500

Guide Trough



2400
2500

Guide troughs are used with applications where the upper run of the e-chain[®] glides on the lower run. If using igus[®] steel guide troughs, the following components are required:

- Full travel length of guide trough
Part Number 92-30
- 1/2 travel length of glide bars
Part Number 92-01
- Installation sets as end connectors
Part Number 92-50-XX

-XX indicates the length of the profile rail on which the guide trough is mounted. The values and part numbers are specified in the table on the left. The standard length of the trough components and glide bars is 6.56 ft (2 m.) The required overall length of the guide trough directly correlates to the length of travel.

Example:
Length of travel 164 ft (50 m)
Center mounted
Required guide troughs:
164 ft (50 m) guide trough
82 ft (25 m) glide bar
= 25 sections of 6.56 ft
(2 m) guide trough
Part No. 92-30
= 13 sections of 6.56 ft (2 m) glide bar
Part No. 92-01



Required number of installation sets:
= Number of guide trough components + 1
= 25 + 1 = 26
Part number of the installation sets

Example: 92-50-400 for 15.75" (400 mm) long profile rail.

Width of Crossbar
2500-05-200-0

	B_{Ri}	Installation Part No.
-02*	1.81 (46)	—
-03	2.32 (59)	92-50-175
-05	3.07 (78)	92-50-200
-07	3.86 (98)	92-50-225
-09	4.37 (111)	92-50-225
-10	4.88 (124)	92-50-250
-12	5.75 (146)	92-50-275

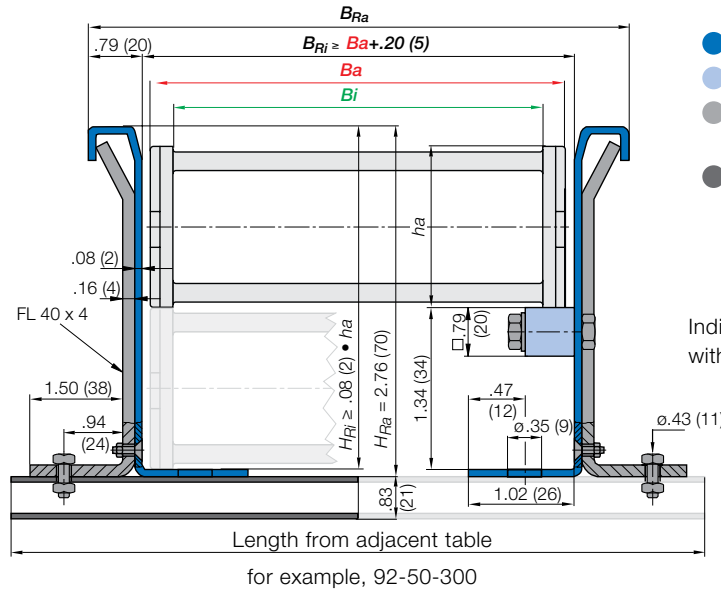

- Guide trough
- Glide bars
- Installation set "Basic"
- Profile rail

Individual attachment without profile rail

* Specialized guide trough available upon request

PDF: igus.com/e-chain-pdfs
Product information: igus.com/e-chains



Price Index



Series 2450/2480

Special Features / Options

IPA Qualification Certificate, Air Cleanliness Class ISO Class 3 (at v = 2 m/s) upon request

ESD classification: Electrically conductive ESD/ATEX version upon request

UL94 V2 classifications upon request

Assembly Tips



Insert screwdriver into the slot, using a lever action apply pressure to the screwdriver to release

Other Installation Methods

Vertical, hanging ≤ 131 ft (40 m)

Vertical, standing ≤ 9.84 ft (3 m)

Side-mounted, un_supp. ≤ 3.28 ft (1 m)

Rotary requires further calculation

Usage Guidelines



- If snap-open accessibility along the inner or outer radius is required
- If integrated strain relief at the mounting point is required
- If modular interior separation is needed
- If long service life is required
- If easy installation is required



- If the application is very simple
➤ Series E200 E-Z Chain
- If greater stability is required
➤ Series E4-21 E4-1 Series

Features & Benefits

- 1 Tried-and-tested mounting bracket
- 2 Snap-open crossbar for easy opening from the left or right
- 3 Series 2450 snap-open on both sides along inner radius
- 4 Series 2480 snap-open on both sides along inner radius
- 5 Integrated strain relief possible
- 6 Modular interior separation
- 7 Easy assembly by optimized pin
- 8 Double stop dog for long unsupported length
- 9 Crossbars with high retention force
- 10 Also available as ESD version
- 11 Strain relief separator available

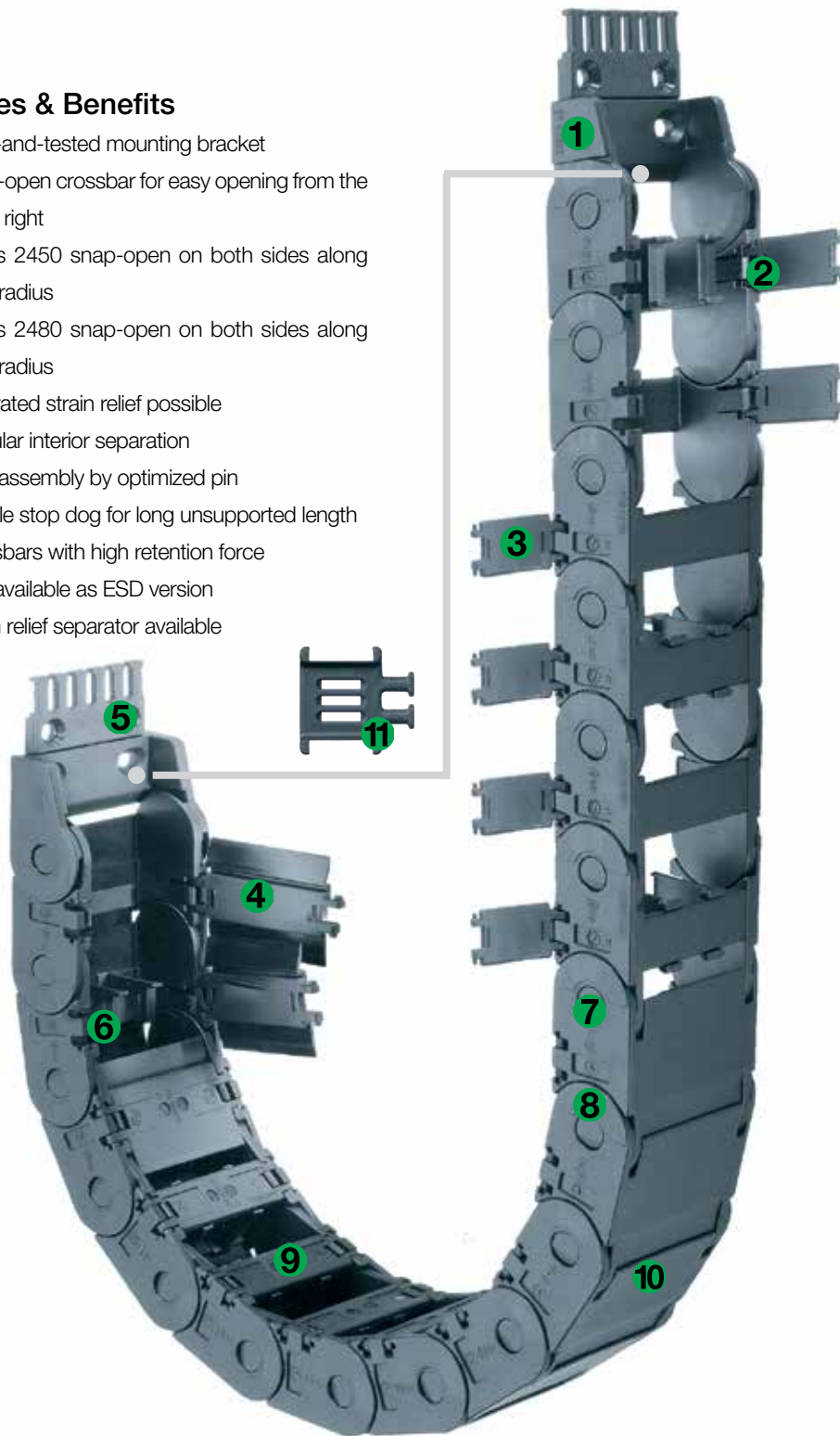

Order Example: Complete e-chain®

Please indicate chain length or number of links. Example:

9.84 ft (3 m) 2450-10-100-0



e-chain®

With 2 separators 24501 assembled every 2nd link



Interior Separation

1 Set 2100-34PZB



Mounting Bracket

e-chain system® E2/000

Series 2450/2480 Half-Tubes and Full Tubes

Installation Dimensions



2450
2480

Short travel, unsupported length

- FL_B = unsupported with permitted sag
 - FL_G = unsupported with straight upper run
- Further information ► Design, Chapter 1

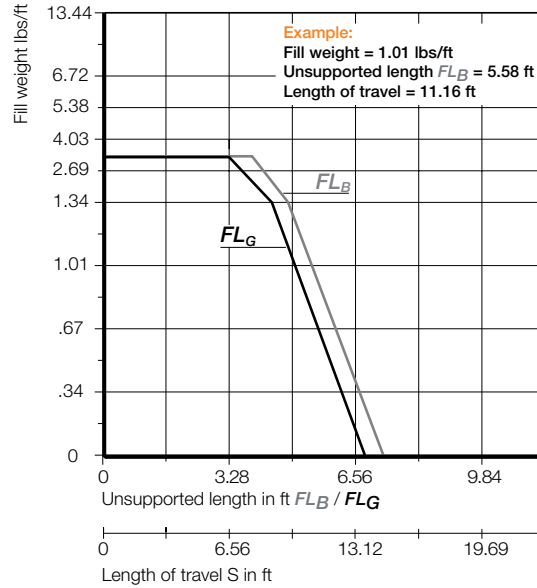
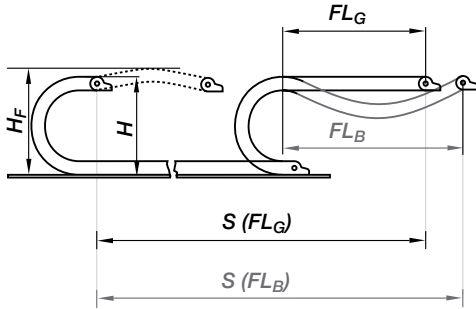

Short Travels - Unsupported

Unsupported e-chains® feature positive camber over short travels. This must be accounted for when specifying the clearance height. Please refer to **Installation dimensions** for further details.

Legend

- S = Length of travel
- R = Bending radius
- H = Nominal clearance height
- D = Overlength e-chain® radius in final position
- $K = \pi \cdot R + \text{safety buffer}$
- H_f = Required clearance height

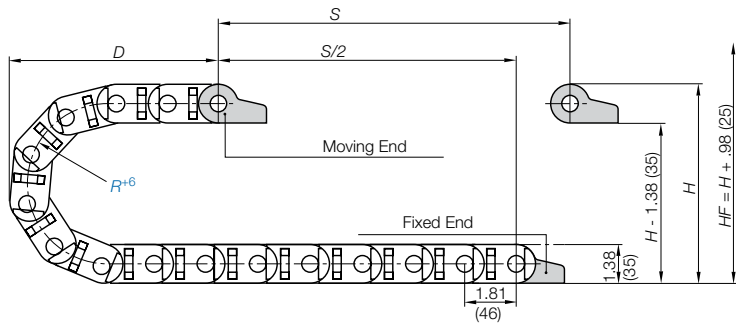

Pitch per link = 1.81" (46 mm)
Links per ft (m) = 6.71 (22)
For center mount applications:
Chain length = $S/2 + K$

The required clearance height: $H_f = H + .98$ in. (25 mm) (with 1.01 lbs/ft (1.5 kg/m) fill weight). Please consult igus® if space is particularly restricted.

R	2.16 (055*)	2.95 (075*)	3.94 (100)	4.92 (125)	5.91 (150)	6.89 (175)	7.87 (200)	8.86 (225)	9.84 (250)
H	5.71 (145)	7.28 (185)	9.25 (235)	11.22 (285)	13.19 (335)	15.16 (385)	17.13 (435)	19.09 (485)	21.06 (535)
D	5.59 (142)	6.38 (162)	7.36 (187)	8.35 (212)	9.33 (237)	10.31 (262)	11.30 (287)	12.28 (312)	13.27 (337)
K	10.43 (265)	12.99 (330)	16.14 (410)	19.09 (485)	22.24 (565)	25.39 (645)	28.54 (725)	31.50 (800)	34.65 (880)

*upon request
Radii 055: the e-tube is not completely enclosed.
Please consult igus®



PDF: igus.com/e-chain-pdfs
Product information: igus.com/e-chains



Speed / acceleration FL_G	max. 65.6 ft/s (20 m/s) / max. 656 ft/s ² (200 m/s ²)
Speed / acceleration FL_B	max. 9.84 ft/s (3 m/s) / max. 19.69 ft/s ² (6 m/s ²)
Gliding speed / acceleration (maximum)	max. 32.8 ft/s (10 m/s) / max. 164 ft/s ² (50 m/s ²)
Material - permitted temperature	igumid G / -40°F (-40°C) up to +248°F (+120° C)
Flammability Class, igumid G	VDE 0304 IIC UL94 HB

Technical Data



Details of material properties

► Chapter 1

Series 2450 - Half tube, hinged, snap-open along the inner radius

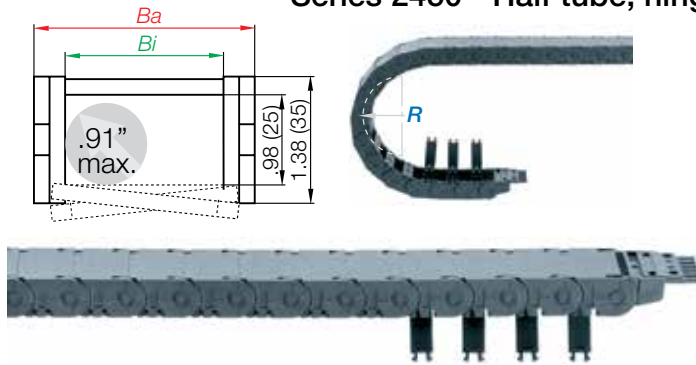

Part Number Structure

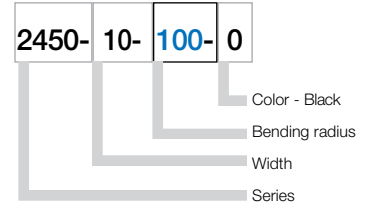

Series 2480 - Full tube, hinged, snap-open along the inner radius

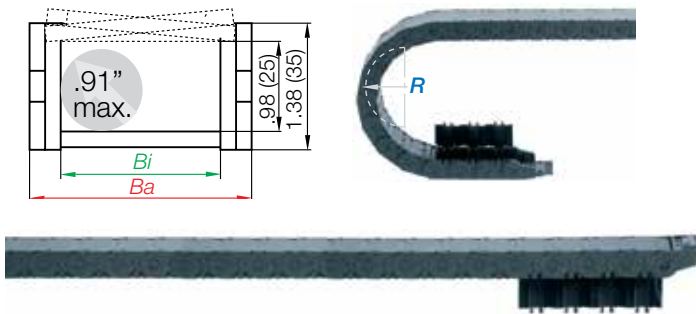

Part Number Structure

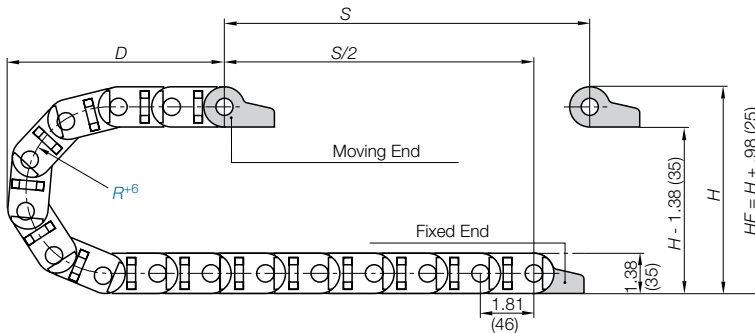
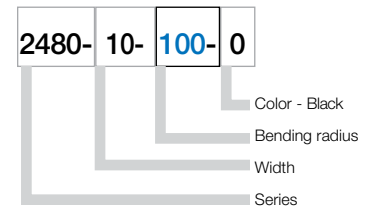

Supplement part number with required radius. Example: 2480-10-**100**-0
Pitch: 1.81 in. (46 mm) per link links/ft(m) = 6.71 (22)

Part Number	Series 2450 Weight	Series 2480 Weight
Snap-open inner radius	lbs/ft (kg/m)	lbs/ft (kg/m)
2450-02- <input type="text"/> -0	≈ 0.54 (0.80)	≈ 0.55 (0.82)
2450-03- <input type="text"/> -0	≈ 0.59 (0.88)	≈ 0.62 (0.92)
2450-05- <input type="text"/> -0	≈ 0.66 (0.99)	≈ 0.69 (1.03)
2450-07- <input type="text"/> -0	≈ 0.75 (1.12)	≈ 0.79 (1.17)
2450-09- <input type="text"/> -0	≈ 0.81 (1.20)	≈ 0.85 (1.26)
2450-10- <input type="text"/> -0	≈ 0.85 (1.27)	≈ 0.90 (1.34)
2450-12- <input type="text"/> -0	≈ 0.91 (1.35)	≈ 0.96 (1.43)

Choose from the radii below for all of the above sizes

Radius (mm) Example: 2400-10-**100**-0

	055*	075*	100	125	150	175	200	225	250
R	2.16 (055)	2.95 (075)	3.94 (100)	4.92 (125)	5.91 (150)	6.89 (175)	7.87 (200)	8.86 (225)	9.84 (250)
H	5.71 (145)	7.28 (185)	9.25 (235)	11.22 (285)	13.19 (335)	15.16 (385)	17.13 (435)	19.09 (485)	21.06 (535)
D	5.59 (142)	6.38 (162)	7.36 (187)	8.35 (212)	9.33 (237)	10.31 (262)	11.30 (287)	12.28 (312)	13.27 (337)
K	10.43 (265)	12.99 (330)	16.14 (410)	19.09 (485)	22.24 (565)	25.39 (645)	28.54 (725)	31.50 (800)	34.65 (880)

*upon request
Radii 055: the e-tube is not completely enclosed. Please consult igus®

e-chain system® E2/000
 Series 2450/2480 Half-Tubes and Full Tubes
 Interior Separation



2450
 2480

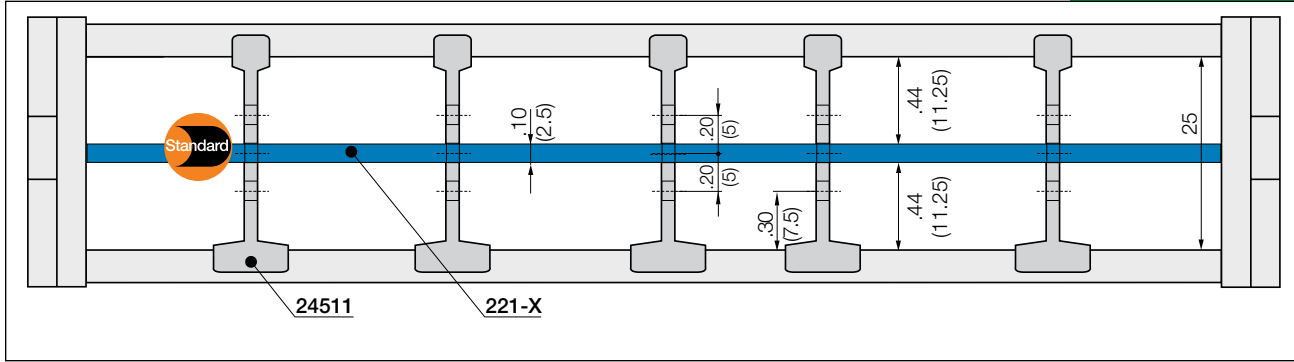

In the standard configuration separators are assembled every 2nd e-chain® link

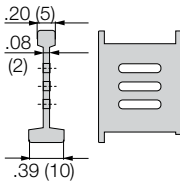

Separator, wide base

Unassembled	Part No. 24501
Assembled	Part No. 24511

● **Slotted separator 24501**

Separator with wide base for maximum locking strength and safe standing in e-chains®.

Full-width shelves - for the standard interior separation

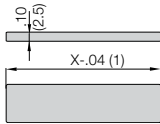

Separator, narrow head

Unassembled	Part No. 220-X
Assembled	Part No. 221-X

● **Full-width shelf 220-X**

this option makes sense in applications with many thin cables with similar diameters. For a consequent subdivision. Full-width shelves can be inserted at 3 different heights in .20" (5 mm) increments

Width X in. (mm)	Part No. Unassembled	Part No. Assembled	Width X in. (mm)	Part No. Unassembled	Part No. Assembled
.98 (25)	220-25	221-25	3.54 (90)	220-90	221-90
1.50 (38)	220-38	221-38	4.06 (103)	220-103	221-103
2.24 (57)	220-57	221-57	4.92 (125)	220-125	221-125
3.03 (77)	220-77	221-77			

PDF: igus.com/e-chain-pdfs
 Product information: igus.com/e-chains



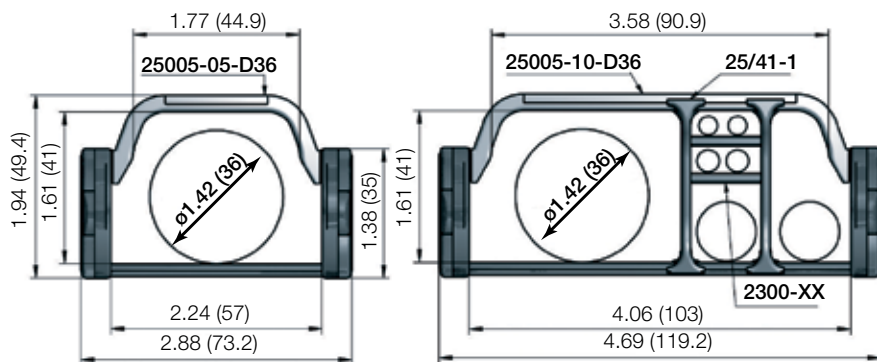

Part Number.
Extender crossbars
for e-chains®
that snap-open
along inner radius

		<i>Bi</i>	<i>Ba</i>
		in. (mm)	in. (mm)
2450-05D36-	<input type="checkbox"/> -0	2.24 (57)	2.87 (73)
2450-10D36-	<input type="checkbox"/> -0	4.06 (103)	4.69 (119)

Choose from the radii below for all of the above sizes

Radius (mm)	Example: 2400-10D36-
<input type="checkbox"/> 075	<input type="checkbox"/> 100
<input type="checkbox"/> 125	<input type="checkbox"/> 150
<input type="checkbox"/> 150	<input type="checkbox"/> 175
<input type="checkbox"/> 175	<input type="checkbox"/> 200
<input type="checkbox"/> 200	<input type="checkbox"/> 225
<input type="checkbox"/> 225	<input type="checkbox"/> 250

R 1.50 (075) 3.94 (100) 4.92 (125) 5.91 (150) 6.89 (175) 7.87 (200) 8.86 (225) 9.84 (250)

Interior separation for extender crossbars

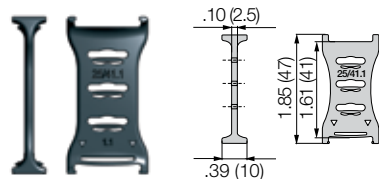

Separator, wide base

Unassembled	Part No. 25/41.1
Assembled	Part No. 25/41.1.1

- **Standard separator 25/41-1, wide base**
For maximum locking strength and safe standing. In standard configuration separators are assembled every 2nd e-chain® link.

Lockable full-width shelves - for the standard interior separation

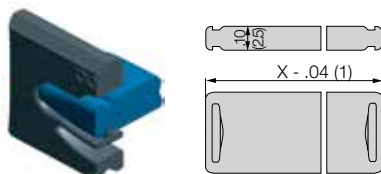

Full width shelf, lockable

Unassembled	Part No. 2300-X
Assembled	Part No. 2310-X

- **Full width shelf, lockable**
is used when vertical and horizontal separation is required.

Width X	Part No.	Part No.	Width X	Part No.	Part No.	Width X	Part No.	Part No.
in. (mm)	Unassembled	Assembled	in. (mm)	Unassembled	Assembled	in. (mm)	Unassembled	Assembled
0.59 (015)	2300-15	2310-15	2.36 (060)	2300-60	2310-60	3.43 (087)	2300-87	2310-87
0.98 (025)	2300-25	2310-25	2.44 (062)	2300-62	2310-62	3.54 (090)	2300-90	2310-90
1.18 (030)	2300-30	2310-30	2.56 (065)	2300-65	2310-65	3.94 (100)	2300-100	2310-100
1.50 (038)	2300-38	2310-38	2.76 (070)	2300-70	2310-70	4.06 (103)	2300-103	2310-103
1.57 (040)	2300-40	2310-40	2.95 (075)	2300-75	2310-75	4.33 (110)	2300-110	2310-110
1.97 (050)	2300-50	2310-50	3.03 (077)	2300-77	2310-77	4.72 (120)	2300-120	2310-120
2.24 (057)	2300-57	2310-57	3.15 (080)	2300-80	2310-80	4.92 (125)	2300-125	2310-125

Separator with integrated strain relief

Strain relief separator Part No. 2020-ZR can be integrated into the mounting bracket and can be placed there at any point of the e-chain®. It combines strain relief and interior separation, it can be installed on the first or last e-chain® link and is easy to assemble without any screws.



For more information ► Chapter 10, Strain Relief

e-chain system® E2/000

Series 2450/2480 Half-Tubes and Full Tubes

Mounting Bracket - Plastic



2450
2480

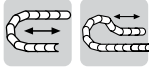

Option 1: pivoting

- For unsupported and gliding applications
- Well suited for tight installation conditions
- Detachable strain relief tiwrap plates
- Can be mounted on the fixed and/or moving end

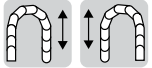
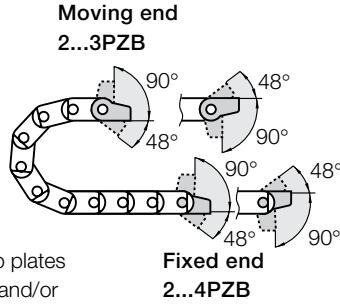

Option 2: locking

- For unsupported and gliding applications
- Extreme speed and/or accelerations
- For height restricted applications
- Can be mounted on the fixed and/or moving end

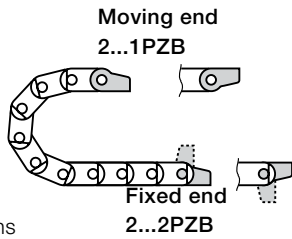

Part Number Structure



- With 10 cable tiwraps
- With tiwrap plates
- Complete Set
34 = Pivoting
12 = Locking
- Mounting brackets for selected chain type

Full set, for both ends:

2020- 34 PZB Full set, each part with pin/bore + tiwrap plate

Single-part order:

- 2020- 3 PZB Mounting bracket with bore + tiwrap plate
- 2020- 4 PZB Mounting bracket with pin + tiwrap plate

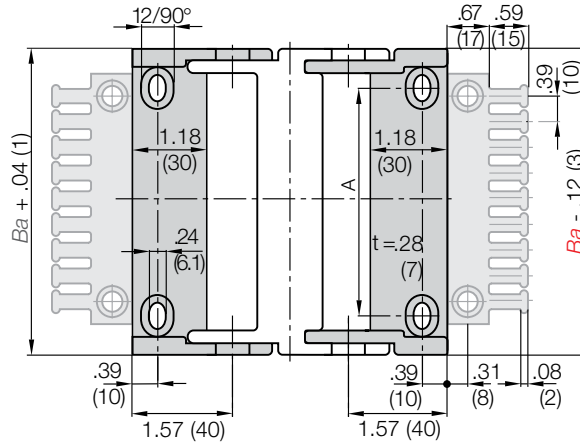

Part No. Full Set (pivoting)
With Tiwrap Plates
Series 2400/2500:
2020-34PZB

Part No. Full Set (pivoting)
With Tiwrap Plates
+ 10 cable ties
Series 2400/2500:
2020-34PZBK1

For Chain Type	Part No. Full set without Tiwrap Plate	Part No. Full Set with Tiwrap Plate	Part No. Full Set with Tiwrap Plate + 10 cable ties	Dimension A	
				in.	(mm)
2450/2480-02	2020- <input type="checkbox"/> PZ	2020- <input type="checkbox"/> PZB	2020- <input type="checkbox"/> PZBK1	.47	(12)
2450/2480-03	2030- <input type="checkbox"/> PZ	2030- <input type="checkbox"/> PZB	2030- <input type="checkbox"/> PZBK1	.98	(25)
2450/2480-05	2050- <input type="checkbox"/> PZ	2050- <input type="checkbox"/> PZB	2050- <input type="checkbox"/> PZBK1	1.73	(44)
2450/2480-07	2070- <input type="checkbox"/> PZ	2070- <input type="checkbox"/> PZB	2070- <input type="checkbox"/> PZBK1	2.52	(64)
2450/2480-09	2090- <input type="checkbox"/> PZ	2090- <input type="checkbox"/> PZB	2090- <input type="checkbox"/> PZBK1	3.03	(77)
2450/2480-10	2100- <input type="checkbox"/> PZ	2100- <input type="checkbox"/> PZB	2100- <input type="checkbox"/> PZBK1	3.54	(90)
2450/2480-12	2125- <input type="checkbox"/> PZ	2125- <input type="checkbox"/> PZB	2125- <input type="checkbox"/> PZBK1	4.41	(112)

34 or 12

For pivoting brackets choose 34
For locking brackets choose 12
Example: 2020- 34 PZB

PDF: igus.com/e-chain-pdfs
Product information: igus.com/e-chains



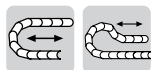

Option 1: pivoting

- For unsupported applications
- Bolted connection outside of chain cross section
- Confined installation conditions
- Attachment points on all sides
- Stackable

Moving end
2450 = 24501...1
2480 = 24801...1

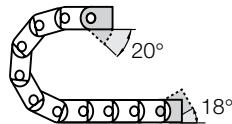

Fixed end
2450 = 24501...2
2480 = 24801...2

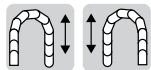

Option 2: locking

- For vertical hanging/standing applications
- Bolted connection outside of chain cross section
- For very high speeds and accelerations
- Attachment points on all sides
- Stackable

Moving end
2450 = 24511...1
2480 = 24811...1

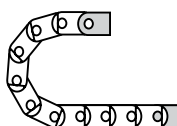

Fixed end
2450 = 24511...2
2480 = 24811...2

Part Number Structure

24501-02-12 ZB

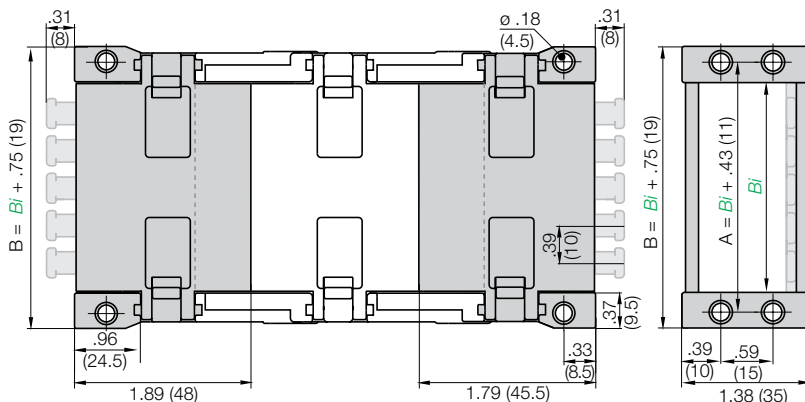
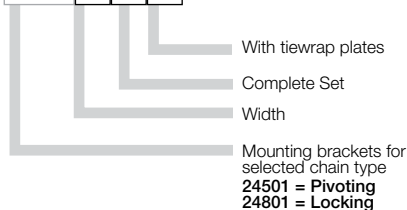

Full set, for both ends:

24501-12 ZB Full set, each part with pin/bore + tiewrap plate

Single-part order:

24501-1 ZB Mounting bracket with bore + tiewrap plate

24501-2 ZB Mounting bracket with pin + tiewrap plate

Part No. Full Set (pivoting)

With Tiewrap Plates

Series 2450:

24501-Width-12ZB

Part No. Full Set (pivoting)

Without Tiewrap Plates

Series 2450:

24501-Width-12

For Chain Type	Part No. Full set with Tiewrap Plate	Part No. Full Set without Tiewrap Plate	Dimension A in. (mm)	Number of Teeth
2450/2480-02	24501-02-12ZB	24501-02-12	1.42 (36)	2
2450/2480-03	24501-03-12ZB	24501-03-12	1.93 (49)	4
2450/2480-05	24501-05-12ZB	24501-05-12	2.68 (68)	6
2450/2480-07	24501-07-12ZB	24501-07-12	3.46 (88)	7
2450/2480-09	24501-09-12ZB	24501-09-12	3.94 (100)	9
2450/2480-10	24501-10-12ZB	24501-10-12	4.49 (114)	10
2450/2480-12	24501-12-12ZB	24501-12-12	5.35 (136)	12

24501 or 24511
24801 or 24811

For pivoting brackets choose 24501 or 24801

For locking brackets choose 24511 or 24811

Example: 24501-02-12ZB

e-chain system® E2/000

Series 2450/2480 e-chain® Half-Tubes and Full Tubes

Mounting Bracket - Steel



2450
2480

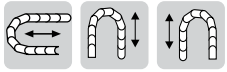

Option 1: Steel

- Pivoting connections
- One part (two-piece) for all chain widths
- Electrically conductive
- Bolted connection outside of chain cross-section possible

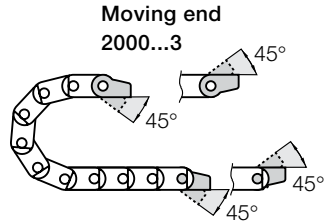

Fixed end
2000...2

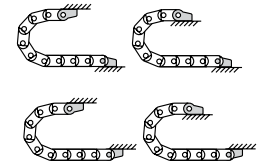
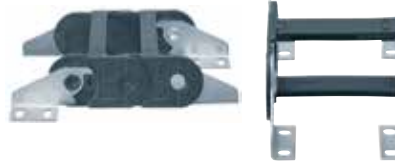

Possible installation configurations -

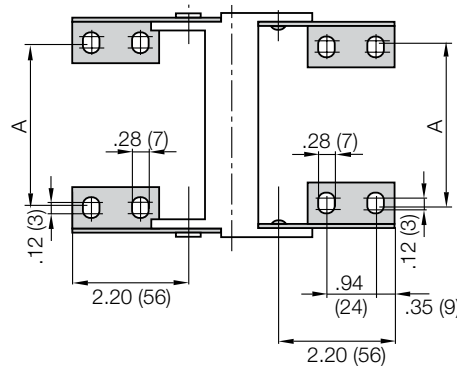
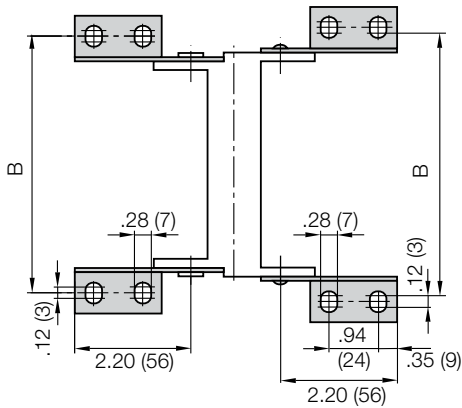

Chain Type	Part No. Full Set	Dimension A		Dimension B	
		in.	(mm)	in.	(mm)
2450/2480-02	2000-32			2.36	(60)
2450/2480-03	2000-32	.98	(25)	2.87	(73)
2450/2480-05	2000-32	1.73	(44)	3.62	(92)
2450/2480-07	2000-32	2.52	(64)	4.41	(112)
2450/2480-09	2000-32	2.99	(76)	4.88	(124)
2450/2480-10	2000-32	3.54	(90)	5.43	(138)
2450/2480-12	2000-32	4.41	(112)	6.30	(160)

Part No. Mounting Brackets Full Set
4 parts, 2 with pin, 2 with bore
Series 2450/2480:
2000-32

Part No. Mounting Bracket Moving End
2 parts, 1 left & 1 right
Series 2450/2480:
2000-3

Part No. Mounting Bracket Fixed End
2 parts, 1 left & 1 right
Series 2450/2480:
2000-2

PDF: igus.com/e-chain-pdfs
Product information: igus.com/e-chains



Tiewrap Plates

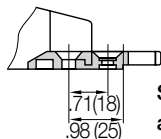

Shown assembled

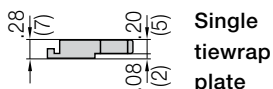

Single tie-wrap plate

Option 1:

Tiewrap plates as an individual part

Available as an individual component, can be fixed onto a mounting bracket with the use of a profile rail.

Tiewrap Plates	n Number of Teeth	Dimension C	Dimension B
2020-ZB	3	1.18 (30)	.59 (15)
2030-ZB	4	1.57 (40)	.79 (20)
2040-ZB	5	1.97 (50)	1.18 (30)
2050-ZB	6	2.36 (60)	1.57 (40)
2070-ZB	8	3.15 (80)	2.36 (60)
2090-ZB	9	3.54 (90)	2.76 (70)
2100-ZB	10	3.94 (100)	3.15 (80)
2125-ZB	12	4.72 (120)	3.94 (100)

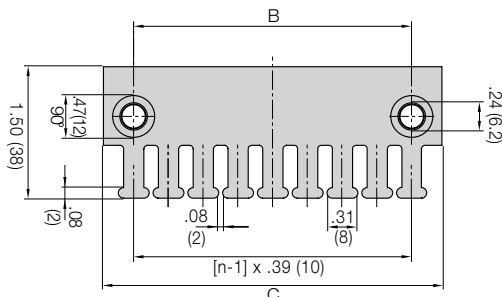

For more information please refer to strain relief section of Chapter 10



Cable tiewraps as individual parts

Cable tiewraps 100 pieces/bag	Width x Length		Maximum Ø		Tensile Strength	
	in.	(mm)	in.	(mm)	lbs	(N)
CFB-001	.19 x 5.91	(4.8 x 150)	1.42	(36)	50	(222)



Strain relief for steel mounting brackets

Clip-on connection is not possible with steel mounting brackets. In this case, the tie-wrap plates must be bolted directly into separate bore holes in front of the mounting bracket. Alternatively the tie-wrap plates 20XX-ZB can be also used here. Details chapter 10



PDF: igus.com/e-chain-pdfs
Product information: igus.com/e-chains



2600
2700



e-chain system® E2/000

Series 2600/2700

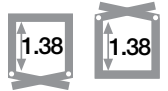

Price Index



Series 2600/2700

Special Features / Options

IPA IPA Qualification Certificate, Air Cleanliness Class ISO Class 3 (at v = 2 m/s) upon request

EX ESD classification: Electrically conductive ESD/ATEX version upon request

UL UL94 V2 classifications upon request

Assembly Tips



Snap-open mechanism, choice of snap-open on left or right. Hinged crossbar can be swiveled by more than 180° on both sides. Lightning-fast closing by hand. Secure fit without additional locking devices.

Other Installation Methods

Vertical, hanging ≤ 164 ft (50 m)

Vertical, standing ≤ 9.84 ft (3 m)

Side-mounted, un_supp. ≤ 3.28 ft (1 m)

Rotary requires further calculation

Usage Guidelines



- If snap-open accessibility along the inner or outer radius is required
- If integrated strain relief at the mounting point is required
- If modular interior separation is needed
- If long service life is required
- If easy installation is required



- If the application is very simple
➤ **Series E26 E-Z Chain**
- If greater stability is required
➤ **Series E4-32 E4-1 Series**

Features & Benefits

- 1 Tried-and-tested mounting bracket
- 2 Snap-open crossbar for easy opening from the left or right
- 3 Series 2600 snap-open on both sides along inner radius
- 4 Series 2700 snap-open on both sides along outer radius
- 5 Integrated strain relief possible
- 6 Modular interior separation
- 7 Easy assembly by optimized pin
- 8 Double stop dog for long unsupported length
- 9 Crossbars with high retention force
- 10 Also available as ESD version
- 11 Strain relief separator available

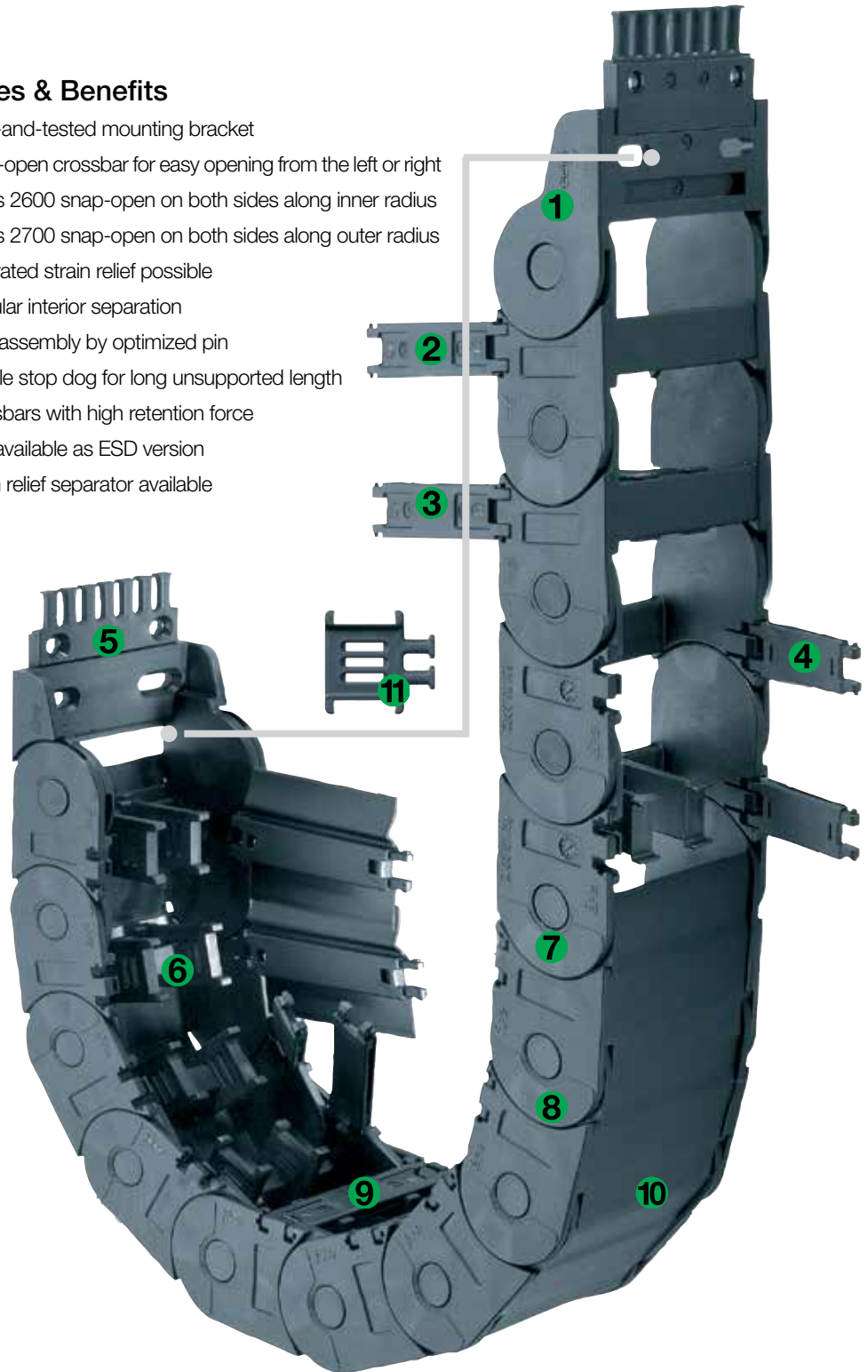

Order Example: Complete e-chain®

Please indicate chain length or number of links. Example:

9.84 ft (3 m) **2700-10-100-0**



e-chain®

With 2 separators **35.1** assembled every 2nd link



Interior Separation

1 Set **2610-34PZB**



Mounting Bracket

e-chain system® E2/000

Series 2600/2700

Installation Dimensions

Short travel, unsupported length

- FL_B = unsupported with permitted sag
 - FL_G = unsupported with straight upper run
- Further information ► Design, Chapter 1

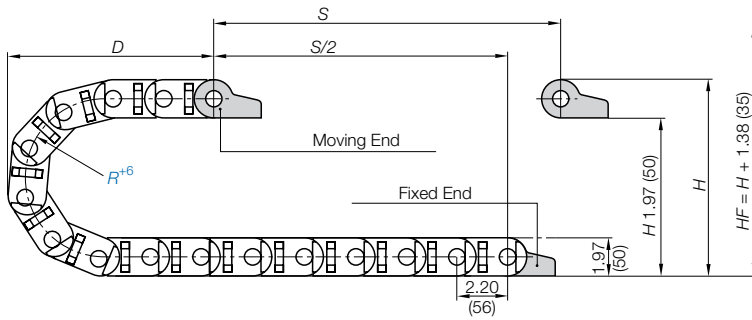
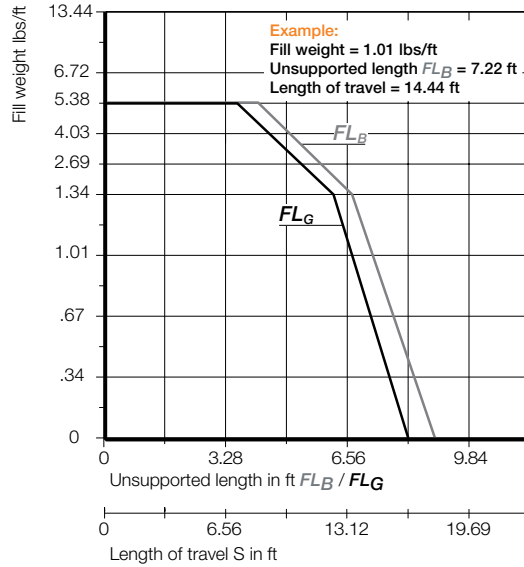
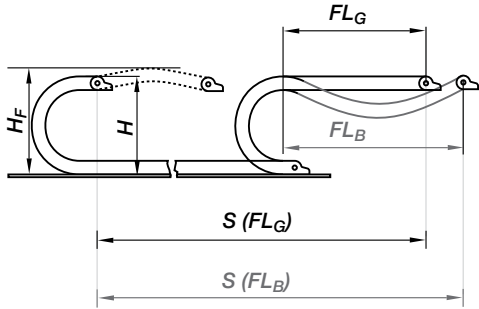

Pitch per link: = 2.20" (56 mm)
 Links per ft (m): = 5.49 (18)
 For center mount applications:
 Chain length = $S/2 + K$

The required clearance height: $H_f = H + 1.38$ in. (35 mm) (with 1.34 lbs/ft (2.0 kg/m) fill weight). Please consult igus® if space is particularly restricted.

R	2.48 (063)	2.95 (075)	3.94 (100)	4.92 (125)	5.91 (150)	6.89 (175)	7.87 (200)	9.84 (250)
H	6.93 (176)	7.87 (200)	9.84 (250)	11.81 (300)	13.78 (350)	15.75 (400)	17.72 (450)	21.65 (550)
D	6.77 (172)	7.24 (184)	8.23 (209)	9.21 (234)	10.20 (259)	11.18 (284)	12.17 (309)	14.13 (359)
K	12.20 (310)	13.78 (350)	16.93 (430)	19.88 (505)	23.03 (585)	26.18 (665)	29.33 (745)	35.43 (900)



2600
2700

Short Travels - Unsupported



Unsupported e-chains® feature positive camber over short travels. This must be accounted for when specifying the clearance height. Please refer to Installation dimensions for further details.



Legend

- S = Length of travel
- R = Bending radius
- H = Nominal clearance height
- D = Overlength e-chain® radius in final position
- $K = \pi \cdot R + \text{safety buffer}$
- H_f = Required clearance height
- H_{ri} = Trough inner height
- H_z = *Mounting height
- D_z = Overlength - long travels, gliding
- K_z = *Add-on

*If the mounting bracket location is set lower

For long travels with lowered mounting height

Long travel lengths from 32.8 ft. (10 m) to max. 394 ft. (120 m)

For long travels, igus® specifies Series 2700 that snap open on the outer radius.

For center mount applications:

Chain length: = $S/2 + K_z$

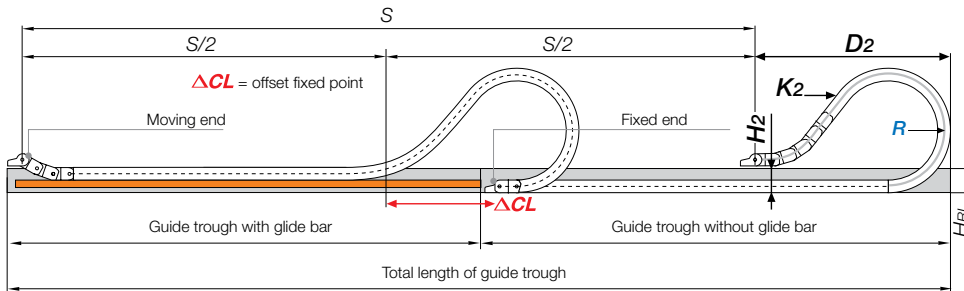

R	2.48 (063)	2.95 (075)	3.94 (100)	4.92 (125)	5.91 (150)	6.89 (175)	7.87 (200)	9.84 (250)
H _z	5.12 (130)	5.91 (150)	6.54 (166)	6.54 (166)	6.54 (166)	6.54 (166)	6.54 (166)	6.54 (166)
D _z ²⁵	5.51 (140)	5.91 (150)	13.78 (350)	18.70 (475)	19.69 (500)	25.79 (655)	30.31 (770)	37.40 (950)
K _z	13.19 (335)	14.76 (375)	24.25 (616)	30.87 (784)	35.28 (896)	44.09 (1120)	50.71 (1288)	63.94 (1624)
ΔCL	—	—	5.67 (144)	9.61 (244)	9.61 (244)	14.72 (374)	18.27 (464)	23.39 (594)

Long Travels - Gliding



If the unsupported length is exceeded, the e-chain® must glide on itself. This requires a guide trough. Design, Chapter 1

Speed / acceleration FL_G	max. 65.6 ft/s (20 m/s) / max. 656 ft/s ² (200 m/s ²)
Speed / acceleration FL_B	max. 9.84 ft/s (3 m/s) / max. 19.69 ft/s ² (6 m/s ²)
Gliding speed / acceleration (maximum)	max. 32.8 ft/s (10 m/s) / max. 164 ft/s ² (50 m/s ²)
Material - permitted temperature	igumid G / -40°F (-40°C) up to +248°F (+120° C)
Flammability Class, igumid G	VDE 0304 IIC UL94 HB

Technical Data



Details of material properties

► Chapter 1

PDF: igus.com/e-chain-pdfs
 Product information: igus.com/e-chains



Series 2600 - snap-open along the inner radius

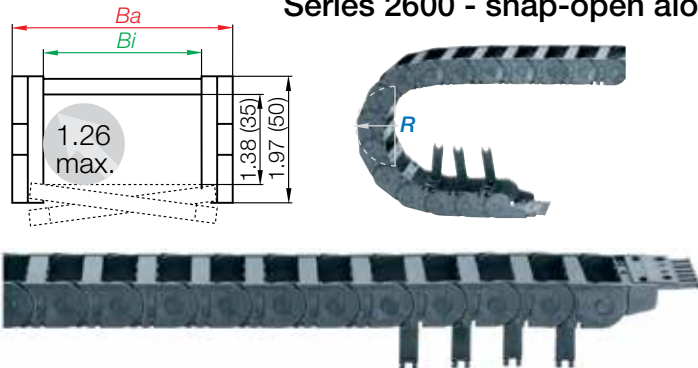

Part Number Structure

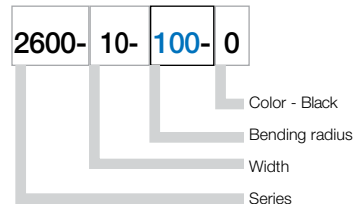

Series 2700 - snap-open along the outer radius

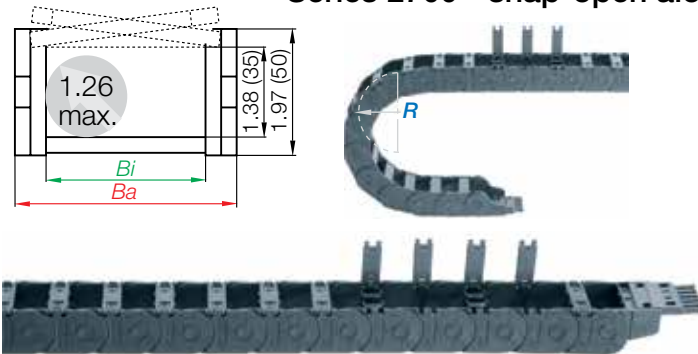

Part Number Structure

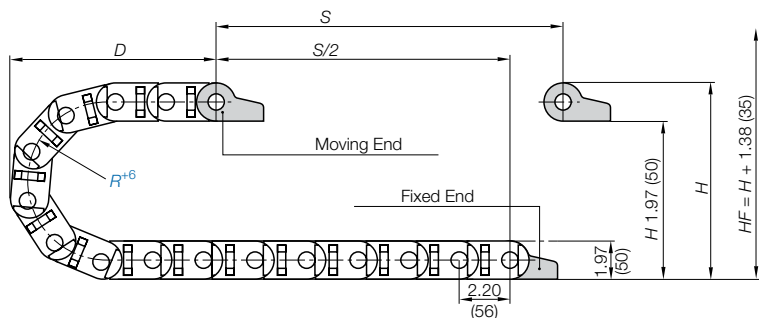
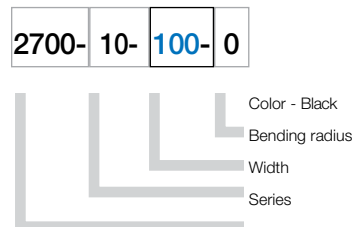

Supplement part number with required radius. Example: 2600-10--0
Pitch: 2.20 in. (56 mm) per link links/ft(m) = 5.49 (18)

Part Number.

Snap-open inner radius	Snap-open outer radius	Bi in. (mm)	Ba in. (mm)	Weight lbs/ft (kg/m)
2600-05- <input type="text"/> -0	2700-05- <input type="text"/> -0	1.97 (50)	2.60 (66)	≈ 0.79 (1.17)
2600-06- <input type="text"/> -0	2700-06- <input type="text"/> -0	2.56 (65)	3.19 (81)	≈ 0.83 (1.24)
2600-07- <input type="text"/> -0	2700-07- <input type="text"/> -0	2.95 (75)	3.58 (91)	≈ 0.87 (1.30)
2600-09- <input type="text"/> -0	2700-09- <input type="text"/> -0	3.54 (90)	4.17 (106)	≈ 0.92 (1.37)
2600-10- <input type="text"/> -0	2700-10- <input type="text"/> -0	3.94 (100)	4.57 (116)	≈ 0.93 (1.39)
2600-12- <input type="text"/> -0	2700-12- <input type="text"/> -0	4.92 (125)	5.55 (141)	≈ 0.99 (1.48)
2600-15- <input type="text"/> -0	2700-15- <input type="text"/> -0	5.91 (150)	6.53 (166)	≈ 1.09 (1.62)
2600-17- <input type="text"/> -0	2700-17- <input type="text"/> -0	6.89 (175)	7.64 (194)	≈ 1.24 (1.85)

Choose from the radii below for all of the above sizes

Radius (mm) Example: 2400-10--0

	063	075	100	125	150	175	200	250
R	2.48 (063)	2.95 (075)	3.94 (100)	4.92 (125)	5.91 (150)	6.89 (175)	7.87 (200)	9.84 (250)
H	6.93 (176)	7.87 (200)	9.84 (250)	11.81 (300)	13.78 (350)	15.75 (400)	17.72 (450)	21.65 (550)
D	6.77 (172)	7.24 (184)	8.23 (209)	9.21 (234)	10.20 (259)	11.18 (284)	12.17 (309)	14.13 (359)
K	12.20 (310)	13.78 (350)	16.93 (430)	19.88 (505)	23.03 (585)	26.18 (665)	29.33 (745)	35.43 (900)

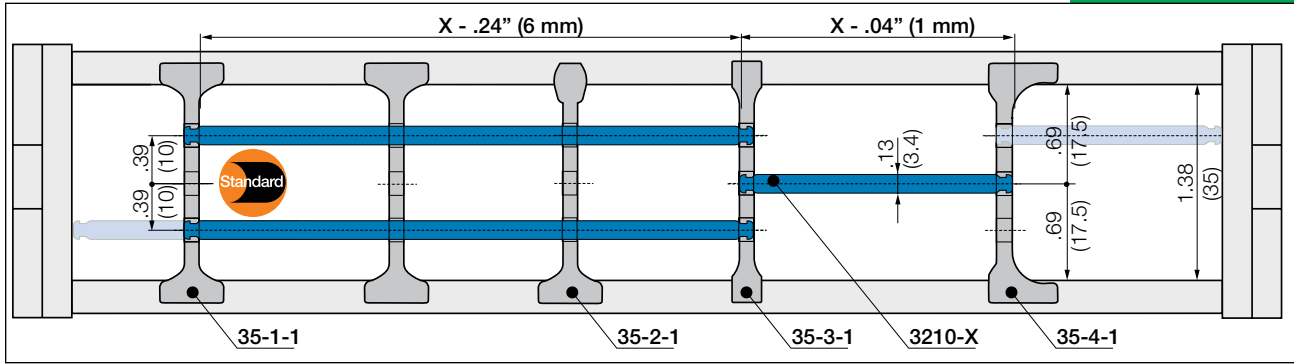

In the standard configuration separators are assembled every 2nd e-chain® link

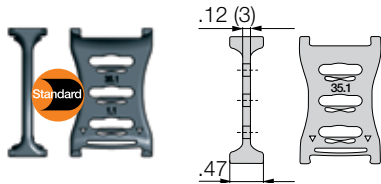

Separator, wide base

Unassembled	Part No. 35.1
Assembled	Part No. 35.1.1

- **Standard separator 35.1 for all applications**
Separator with wide base for maximum locking strength and safe standing in e-chains®.

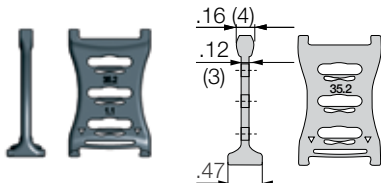

Separator, narrow head

Unassembled	Part No. 35.2
Assembled	Part No. 35.2.1

- **Separator 35.2 For even faster installation**
is used when vertical and horizontal separation is required. Due to its slot, it allows basic vertical/horizontal shelving arrangements.

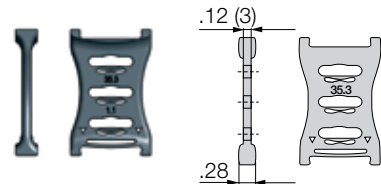

Separator, narrow base

Unassembled	Part No. 35.3
Assembled	Part No. 35.3.1

- **Separator 35.3 For many thin cables**
is used when vertical and horizontal separation is required. Due to its slot, it allows basic vertical/horizontal shelving arrangements.

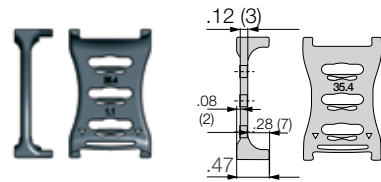

Separator, asymmetrical

Unassembled	Part No. 35.4
Assembled	Part No. 35.4.1

- **Separator 35.4 For side mounted applications**
is used when vertical and horizontal separation is required. Due to its slot, it allows basic vertical/horizontal shelving arrangements.

Lockable full-width shelves - for the standard interior separation

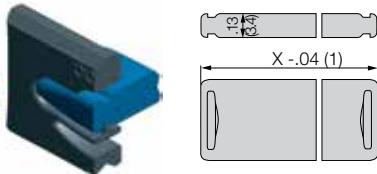

Full width shelf, lockable

Unassembled	Part No. 3200-X
Assembled	Part No. 3210-X

- **Full width shelf, lockable**
is used when vertical and horizontal separation is required. .

Width X in. (mm)	Part No. Unassembled	Part No. Assembled	Width X in. (mm)	Part No. Unassembled	Part No. Assembled
1.97 (050)	3200-50	3210-50	5.91 (150)	3200-150	3210-150
2.95 (075)	3200-75	3210-75	6.89 (175)	3200-175	3210-175
3.94 (100)	3200-100	3210-100	7.87 (200)	3200-200	3210-200
4.53 (115)	3200-115	3210-115	8.86 (225)	3200-225	3210-225
4.92 (125)	3200-125	3210-125	9.84 (250)	3200-250	3210-250



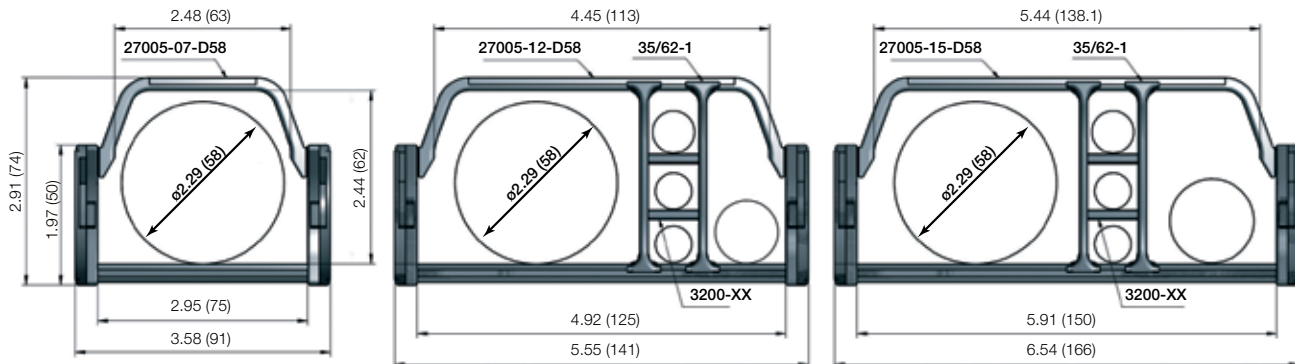

Part Number.

Extender crossbars
for e-chains®
that snap-open
along **inner** radius

Extender crossbars
for e-chains®
that snap-open
along **outer** radius

				<i>Bi</i>	<i>Ba</i>
				in. (mm)	in. (mm)
2600-07D58-	<input type="checkbox"/> -0	2700-07D58-	<input type="checkbox"/> -0	2.95 (75)	3.58 (91)
2600-12D58-	<input type="checkbox"/> -0	2700-12D58-	<input type="checkbox"/> -0	4.92 (125)	5.55 (141)
2600-15D58-	<input type="checkbox"/> -0	2700-15D58-	<input type="checkbox"/> -0	5.91 (150)	6.54 (166)

Choose from the radii below for all of the above sizes

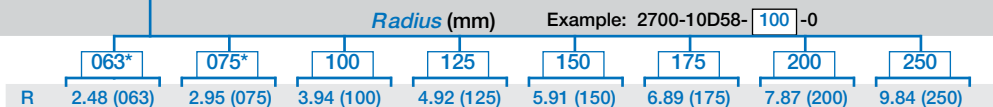

*Radius 063 and 075 only available for 2700 series

Interior separation for extender crossbars

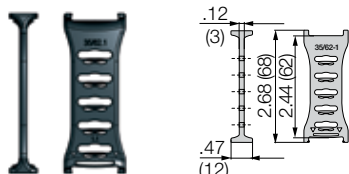

Separator, wide base

Unassembled	Part No. 35/62-1
Assembled	Part No. 35/62-1-1

- **Standard separator 35/62-1, wide base**
For maximum locking strength and safe standing. In standard configuration separators are assembled every 2nd e-chain® link.

Lockable full-width shelves - for the standard interior separation

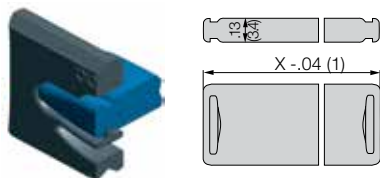

Full width shelf, lockable

Unassembled	Part No. 3200-X
Assembled	Part No. 3210-X

- **Full width shelf, lockable**
is used when vertical and horizontal separation is required. Due to its slot, it allows basic vertical/horizontal shelving arrangements.

Width X in. (mm)	Part No. Unassembled	Part No. Assembled	Width X in. (mm)	Part No. Unassembled	Part No. Assembled
1.97 (050)	3200-50	3210-50	5.91 (150)	3200-150	3210-150
2.95 (075)	3200-75	3210-75	6.89 (175)	3200-175	3210-175
3.94 (100)	3200-100	3210-100	7.87 (200)	3200-200	3210-200
4.53 (115)	3200-115	3210-115	8.86 (225)	3200-225	3210-225
4.92 (125)	3200-125	3210-125	9.84 (250)	3200-250	3210-250

Separator with integrated strain relief

Strain relief separator Part No. 262-Z can be integrated into the mounting bracket and can be placed there at any point of the e-chain®. It combines strain relief and interior separation, it can be installed on the first or last e-chain® link and is easy to assemble without any screws.



For more information ► **Chapter 10, Strain Relief**

e-chain system® E2/000

Series 2600/2700

Mounting Bracket - Plastic



2600
2700

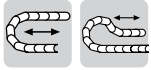

Option 1: pivoting

- For unsupported and gliding applications
- Well suited for tight installation conditions
- Detachable strain relief tiwrap plates
- Can be mounted on the fixed and/or moving end

Moving end
26...3PZB

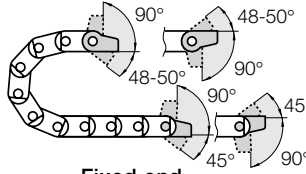

Fixed end
26...4PZB

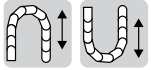

Option 2: locking

- For unsupported and gliding applications
- Extreme speed and/or accelerations
- For height restricted applications
- Can be mounted on the fixed and/or moving end

Moving end
26...1PZB

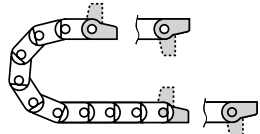

Fixed end
26...2PZB



Part Number Structure

2605- 34 PZB K1

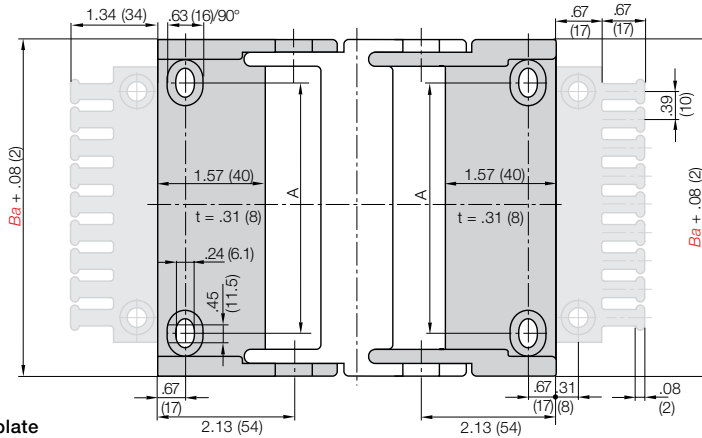
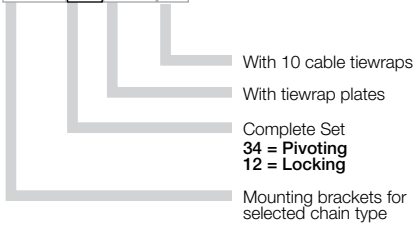

Full set, for both ends:

2605- [34] [PZB] Full set, each part with pin/bore + tiwrap plate

Single-part order:

2605- [3] [PZB] Mounting bracket with bore + tiwrap plate

2605- [4] [PZB] Mounting bracket with pin + tiwrap plate

Part No. Full Set (pivoting)

With Tiwrap Plates

Series 2600:

2605-34PZB

Part No. Full Set (pivoting)

With Tiwrap Plates + 10 cable ties

Series 2600:

2605-34PZBK1

For Chain Type	Part No. Full Set without Tiwrap Plate	Part No. Full Set with Tiwrap Plate	Part No. Full Set with Tiwrap Plate + 10 cable ties	Dimension A in. (mm)	Number of Teeth
2600/2700-05	2605- [] PZ	2605- [] PZB	2605- [] PZBK1	1.18 (30)	5
2600/2700-06	2606- [] PZ	2606- [] PZB	2606- [] PZBK1	1.77 (45)	5
2600/2700-07	2607- [] PZ	2607- [] PZB	2607- [] PZBK1	2.17 (55)	7
2600/2700-09	2609- [] PZ	2609- [] PZB	2609- [] PZBK1	2.76 (70)	9
2600/2700-10	2610- [] PZ	2610- [] PZB	2610- [] PZBK1	3.15 (80)	10
2600/2700-12	2612- [] PZ	2612- [] PZB	2612- [] PZBK1	4.13 (105)	12
2600/2700-15	2615- [] PZ	2615- [] PZB	2615- [] PZBK1	5.12 (130)	15
2600/2700-17	2617- [] PZ	2617- [] PZB	2617- [] PZBK1	6.10 (155)	17

34 or 12

For pivoting brackets choose 34

For locking brackets choose 12

Example: 2605- [34] PZB

PDF: igus.com/e-chain-pdfs
Product information: igus.com/e-chains



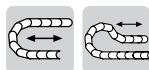

Option 1: pivoting

- For unsupported applications
- Bolted connection outside of chain cross section
- Confined installation conditions
- Attachment points on all sides
- Stackable

Moving end
26001...1

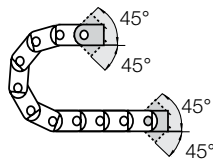

Fixed end
26001...2

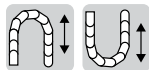
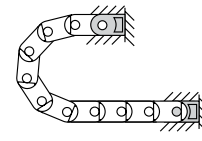

Option 2: locking

- For vertical hanging/standing applications
- Bolted connection outside of chain cross section
- For very high speeds and accelerations
- Attachment points on all sides
- Stackable

Moving end
26101...1

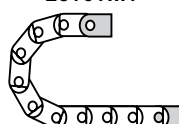

Fixed end
26101...2

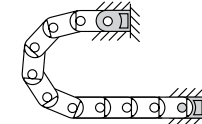

Part Number Structure

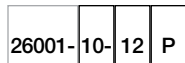

- With profile rail
- Complete Set
- Width
- Mounting brackets for selected chain type
26001 = Pivoting
26101 = Locking

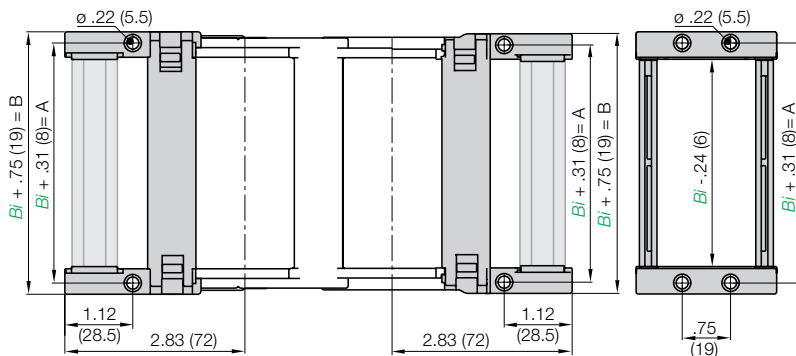

Full set, for both ends:

26001-12 P Full set, each part with pin/bore + profile rail

Single-part order:

26001-1 P Mounting bracket with bore + profile rail

26001-2 P Mounting bracket with pin + profile rail

Part No. Full Set (pivoting)

With Profile Rail
Series 2600/2700:
26001-Width-12P

Part No. Full Set (pivoting)

Without Profile Rail
Series 2600/2700:
26001-Width-12

For Chain Type	Part No. Full set with Profile Rail	Part No. Full Set without Profile Rail	Dimension A in. (mm)	Dimension B in. (mm)
2600/2700-05	-05-12P	-05-12	2.28 (58)	2.72 (69)
2600/2700-06	-06-12P	-06-12	2.87 (73)	3.31 (84)
2600/2700-07	-07-12P	-07-12	3.27 (83)	3.70 (94)
2600/2700-09	-09-12P	-09-12	3.86 (98)	4.29 (109)
2600/2700-10	-10-12P	-10-12	4.25 (108)	4.69 (119)
2600/2700-12	-12-12P	-12-12	5.24 (133)	5.67 (144)
2600/2700-15	-15-12P	-15-12	6.22 (158)	6.65 (169)
2600/2700-17	-17-12P	-17-12	7.20 (183)	7.64 (194)

For pivoting brackets choose **26001**
For locking brackets choose **26101**
Example: **26001**-10-12P

e-chain system® E2/000
Series 2600/2700
Mounting Bracket - Steel



2600
2700

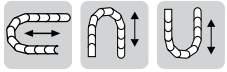

Option 1: Steel

- One part (two-piece) for all chain widths
- Electrically conductive
- Bolted connection outside of chain cross-section possible

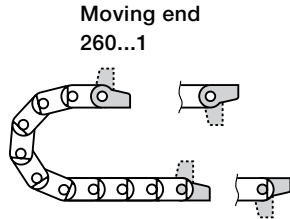

Fixed end
260...2

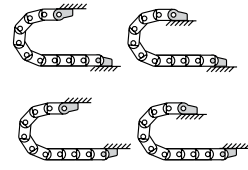

Possible installation configurations -

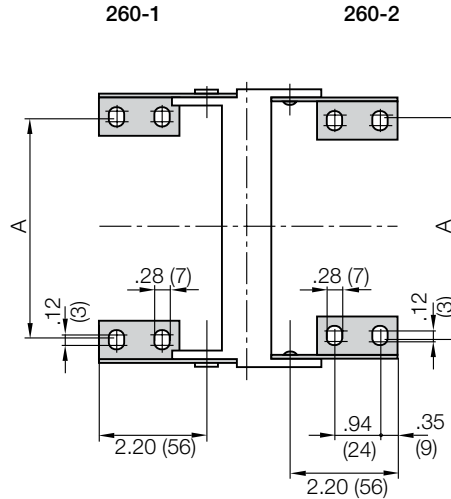
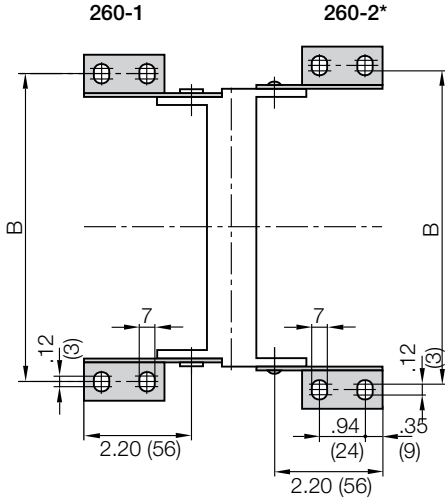

*pivoting with no stop, (360°)

Chain Type	Part No. Full Set	Dimension A		Dimension B	
		in.	(mm)	in.	(mm)
2600/2700-05	260-12	1.46	(37)	3.27	(83)
2600/2700-07	260-12	2.44	(62)	4.25	(108)
2600/2700-10	260-12	3.43	(87)	5.24	(133)
2600/2700-12	260-12	4.41	(112)	6.22	(158)

Part No. Mounting Brackets Full Set
4 parts, 2 with pin, 2 with bore
Series 2680:
260-12

Part No. Mounting Bracket Moving End
2 parts, 1 left & 1 right
Series 2680:
260-1

Part No. Mounting Bracket Fixed End
2 parts, 1 left & 1 right
Series 2680:
260-2

PDF: igus.com/e-chain-pdfs
Product information: igus.com/e-chains



Chainfix clamps for the profile rail

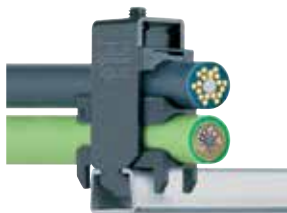

igus® Chainfix strain relief elements are available in either steel or stainless steel. They can be adjusted with a hexagon socket and are available in single, double and triple configurations.

Part No. Single Clamp		Part No. Double Clamp		Part No. Triple Clamp		Cable ø	
Steel	Stainless	Steel	Stainless	Steel	Stainless	in.	(mm)
CFX12-1	CFX12-1E	CFX12-2	CFX12-2E	CFX12-3	-	.24 - .47	(06 - 12)
CFX14-1	CFX14-1E	CFX14-2	CFX14-2E	CFX14-3	-	.47 - .55	(12 - 14)
CFX16-1	CFX16-1E	CFX16-2	CFX16-2E	CFX16-3	-	.55 - .63	(14 - 16)
CFX18-1	CFX18-1E	CFX18-2	CFX18-2E	CFX18-3	-	.63 - .71	(16 - 18)
CFX20-1	CFX20-1E	CFX20-2	CFX20-2E	CFX20-3	-	.71 - .79	(18 - 20)
CFX22-1	CFX22-1E	CFX22-2	CFX22-2E	CFX22-3	-	.79 - .87	(20 - 22)
CFX26-1	CFX26-1E	CFX26-2	CFX26-2E	-	-	.87 - 1.02	(22 - 26)
CFX30-1	CFX30-1E	CFX30-2	CFX30-2E	-	-	1.02 - 1.18	(26 - 30)
CFX34-1	CFX34-1E	CFX34-2	CFX34-2E	-	-	1.18 - 1.34	(30 - 34)
CFX38-1	CFX38-1E	-	-	-	-	1.34 - 1.50	(34 - 38)
CFX42-1	CFX42-1E	-	-	-	-	1.50 - 1.65	(38 - 42)

For more information please refer to strain relief section of Chapter 10

Tiewrap Plates

**Option 1:
Tiewrap plates as an individual part**

Available as an individual component, can be fixed onto a mounting bracket with the use of a profile rail.

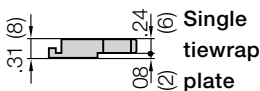
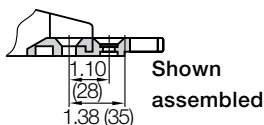

Tiewrap Plate	n Number of Teeth	C Overall Width in. (mm)	B Bore Width in. (mm)	Center Bore
3050-ZB	5	1.97 (50)	1.18 (30)	no
3075-ZB	7	2.95 (75)	2.16 (55)	no
3100-ZB	10	3.94 (100)	3.15 (80)	no
3115-ZB	11	4.53 (115)	3.74 (95)	no
3125-ZB	12	4.92 (125)	4.13 (105)	no
3150-ZB	15	5.91 (150)	5.12 (130)	no
3175-ZB	17	6.89 (175)	6.10 (155)	no
3200-ZB	20	7.87 (200)	7.09 (180)	yes
3225-ZB	22	8.86 (225)	8.07 (205)	yes
3250-ZB	25	9.84 (250)	9.06 (230)	yes

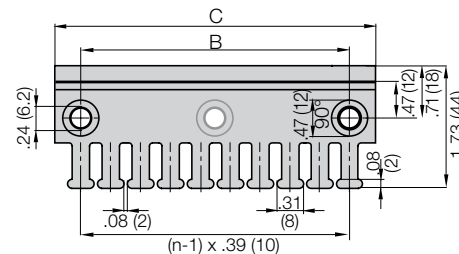

For more information please refer to strain relief section of Chapter 10



**Option 2:
Clip-on Tiewrap plates**

Available as a clip-on tiewrap plate without the use of bolts. They are inserted and removed with a screwdriver used as a lever. Clip-on tiewrap plates are also available as an attachment to the opening crossbars.

Part No.	Number of Teeth	Width of Strain Relief in. (mm)
3050-ZC	5	1.97 (50)
3075-ZC	7	2.95 (75)

For more information please refer to strain relief section of Chapter 10

Strain relief for steel mounting brackets

Clip-on connection is not possible with steel mounting brackets. In this case, the tiewrap plates must be bolted directly into separate bore holes in front of the mounting bracket. Alternatively the tiewrap plates 30XX-Z and ZS can be also used here. Details chapter 10

e-chain system® E2/000

Series 2600/2700

Strain Relief



2600
2700

Guide troughs are used with applications where the upper run of the e-chain® glides on the lower run. If using igus® steel guide troughs, the following components are required:

- Full travel length of guide trough
Part Number 95-30
- 1/2 travel length of glide bars
Part number 92-01
- Installation sets as end connectors
Part Number 95-50-XX

-XX indicates the length of the profile rail on which the guide trough is mounted. The values and part numbers are specified in the table on the left. The standard length of the trough components and glide bars is 6.56 ft (2 m.) The required overall length of the guide trough directly correlates to the length of travel.

Example:

Length of travel 164 ft (50 m)
Center mounted

Required guide troughs:

164 ft (50 m) guide trough
82 ft (25 m) glide bar
= 25 sections of 6.56 ft (2 m) guide trough

Part No. 95-30

= 13 sections of 6.56 ft (2 m) glide bar

Part No. 92-01

Required number of installation sets:

= Number of guide trough components + 1
= 25 + 1 = 26

Part number of the installation sets

Example: 95-50-400 for 15.75" (400 mm) long profile rail.



Width of Crossbar
2700-05-200-0

	B_{Ri}	Installation Part No.
-05	2.80 (71)	95-50-200
-06	3.38 (86)	95-50-200
-07	3.78 (96)	95-50-225
-09	4.37 (111)	95-50-225
-10	4.76 (121)	95-50-250
-12	5.75 (146)	95-50-275
-15	6.73 (171)	95-50-300
-17	7.83 (199)	95-50-325

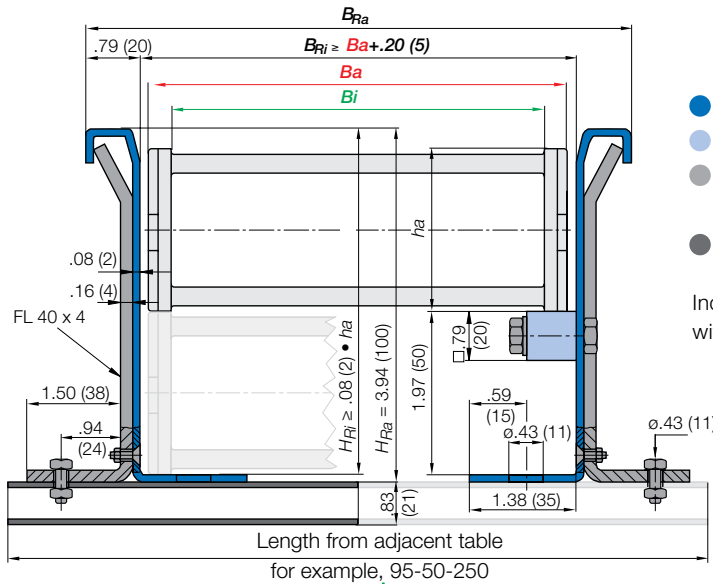

- Guide trough
- Glide bars
- Installation set "Basic"
- Profile rail

Individual attachment without profile rail

Standard length profile rail

* Specialized guide trough available upon request

PDF: igus.com/e-chain-pdfs
Product information: igus.com/e-chains



Price Index



Series 2650/2680

Special Features / Options



IPA Qualification Certificate, Air Cleanliness Class ISO Class 3 (at v = 2 m/s) upon request



ESD classification: Electrically conductive ESD/ATEX version upon request



UL94 V2 classifications upon request

Assembly Tips



Insert screwdriver into the slot, using a lever action apply pressure to the screwdriver to release

Other Installation Methods

Vertical, hanging ≤ 164 ft (50 m)

Vertical, standing ≤ 9.84 ft (3 m)

Side-mounted, un_supp. ≤ 3.28 ft (1 m)

Rotary requires further calculation

Usage Guidelines



- If snap-open accessibility along the inner or outer radius is required
- If integrated strain relief at the mounting point is required
- If modular interior separation is needed
- If long service life is required
- If easy installation is required
- If a half-Tube is required Series 2650
- If a fully enclosed e-tube is required Series 2680



- If the application is very simple
➤ **Series E26 E-Z Chain**
- If greater stability is required
➤ **Series E4-32 E4-1 Series**
- If e-tubes with small bending radii are needed
➤ **Series R58 E2 Tubes**

Features & Benefits

- 1 Tried-and-tested mounting bracket
- 2 Snap-open crossbar for easy opening from the left or right
- 3 Series 2650 snap-open on both sides along inner radius
- 4 Series 2680 snap-open on both sides along inner radius
- 5 Integrated strain relief possible
- 6 Modular interior separation
- 7 Easy assembly by optimized pin
- 8 Double stop dog for long unsupported length
- 9 Crossbars with high retention force
- 10 Also available as ESD version

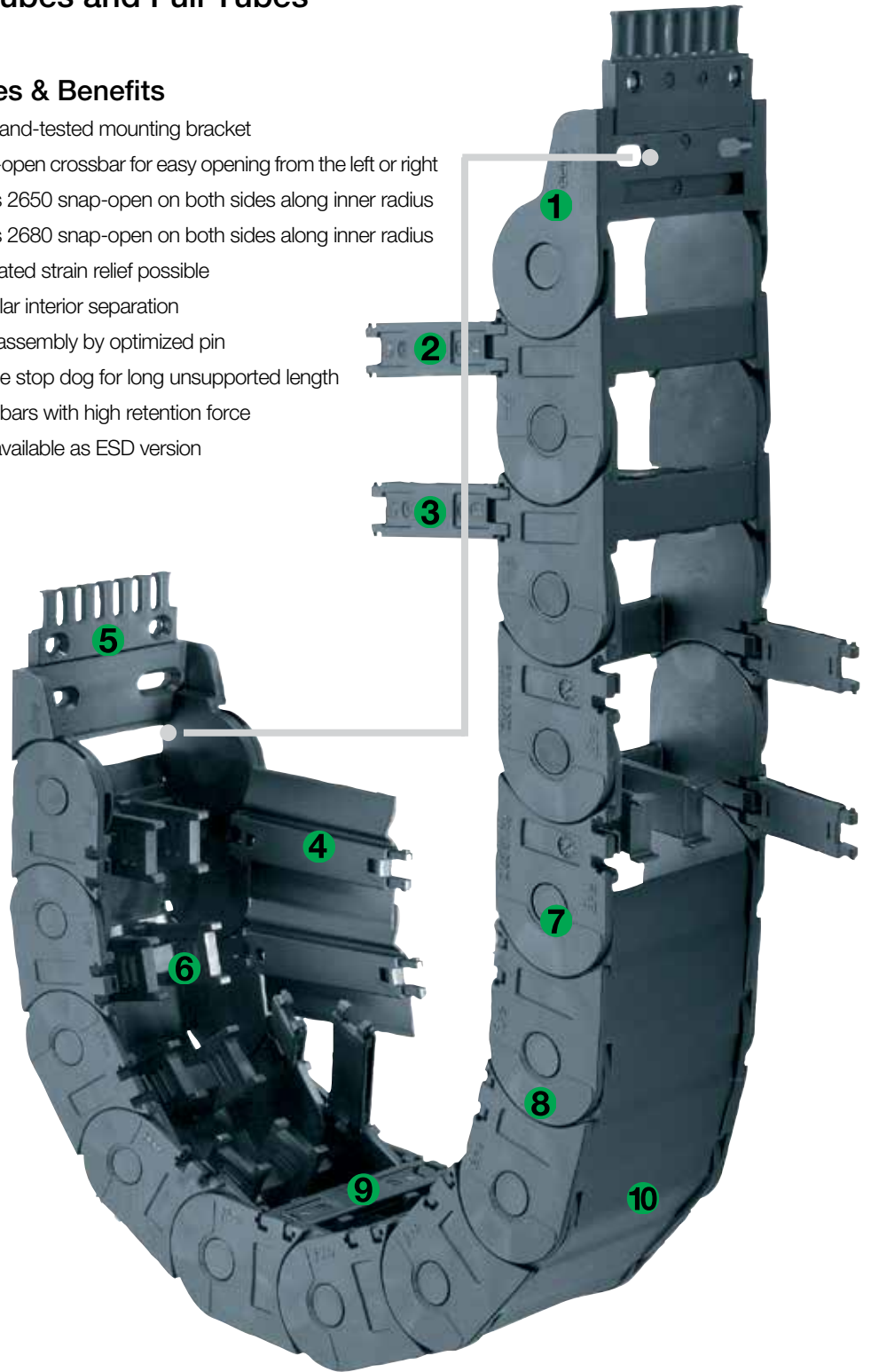

Order Example: Complete e-chain®

Please indicate chain length or number of links. Example:

9.84 ft (3 m) 2680-10-100-0	e-chain®
With 2 separators 26501 assembled every 2nd link	Interior Separation
1 Set 26500-10-12PZB	Mounting Bracket

e-chain system® E2/000

Series 2650/2680 e-chain® Half-Tubes and Full Tubes

Installation Dimensions



2600
2700

Short travel, unsupported length

- FL_B = unsupported with permitted sag
 - FL_G = unsupported with straight upper run
- Further information ► Design, Chapter 1

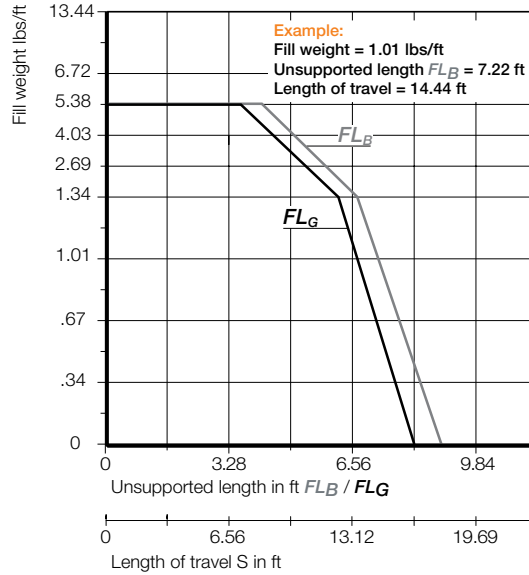
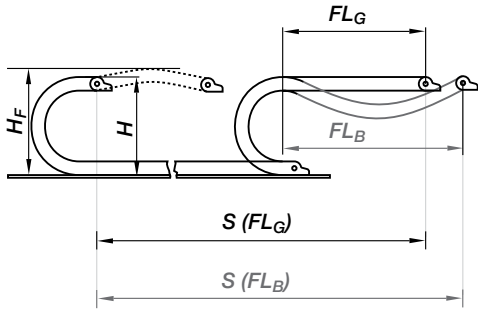

Short Travels - Unsupported

Unsupported e-chains® feature positive camber over short travels. This must be accounted for when specifying the clearance height. Please refer to **Installation dimensions** for further details.

Legend

- S = Length of travel
- R = Bending radius
- H = Nominal clearance height
- D = Overlength e-chain® radius in final position
- $K = \pi \cdot R + \text{safety buffer}$
- H_F = Required clearance height

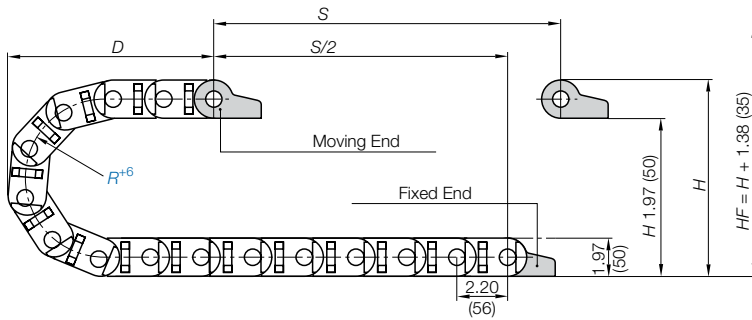

Pitch per link: = 2.20" (56 mm)
Links per ft (m): = 5.49 (18)
For center mount applications:
Chain length = $S/2 + K$

The required clearance height: $H_F = H + 1.38$ in. (35 mm) (with 1.34 lbs/ft (2.0 kg/m) fill weight). Please consult igus® if space is particularly restricted.

R	2.48 (063*)	2.95 (075*)	3.94 (100)	4.92 (125)	5.91 (150)	6.89 (175)	7.87 (200)	9.84 (250)
H	6.93 (176)	7.87 (200)	9.84 (250)	11.81 (300)	13.78 (350)	15.75 (400)	17.72 (450)	21.65 (550)
D	6.77 (172)	7.24 (184)	8.23 (209)	9.21 (234)	10.20 (259)	11.18 (284)	12.17 (309)	14.13 (359)
K	12.20 (310)	13.78 (350)	16.93 (430)	19.88 (505)	23.03 (585)	26.18 (665)	29.33 (745)	35.43 (900)

* Radius available upon request, please consult igus® for delivery time
Radii 063, 075: the e-tube is not completely enclosed. Please consult igus®

Speed / acceleration FL_G	max. 65.6 ft/s (20 m/s) / max. 656 ft/s ² (200 m/s ²)
Speed / acceleration FL_B	max. 9.84 ft/s (3 m/s) / max. 19.69 ft/s ² (6 m/s ²)
Gliding speed / acceleration (maximum)	max. 32.8 ft/s (10 m/s) / max. 164 ft/s ² (50 m/s ²)
Material - permitted temperature	igumid G / -40°F (-40°C) up to +248°F (+120° C)
Flammability Class, igumid G	VDE 0304 IIC UL94 HB

Technical Data



Details of material properties

► Chapter 1



PDF: igus.com/e-chain-pdfs
Product information: igus.com/e-chains



Series 2650 - snap-open along the inner radius

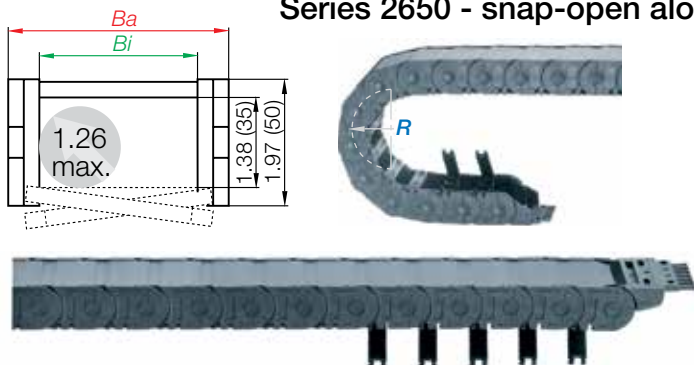

Part Number Structure

2650-	10-	100-	0
-------	-----	------	---

Color - Black
Bending radius
Width
Series

Series 2680 - snap-open along the inner radius

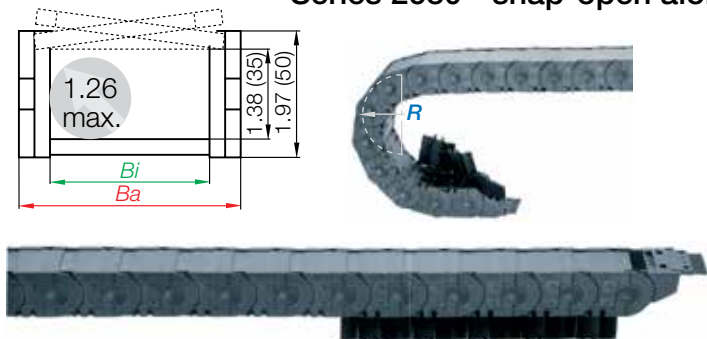

Part Number Structure

2680-	10-	100-	0
-------	-----	------	---

Color - Black
Bending radius
Width
Series

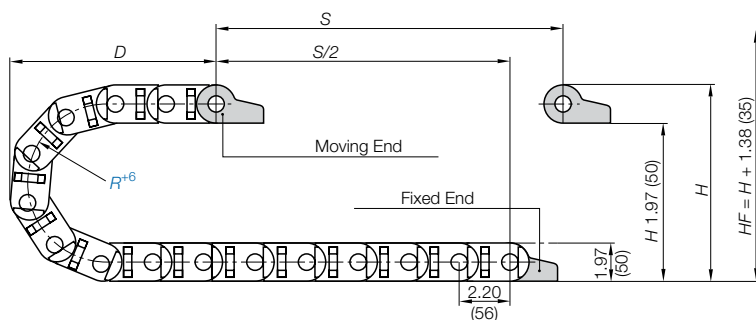

Supplement part number with required radius. Example: 2650-10-100-0
Pitch: 2.20 in. (56 mm) per link links/ft(m) = 5.49 (18)

Part Number.

2650-Snap-open inner radius	2680-Snap-open outer radius	Bi in. (mm)	Ba in. (mm)	Weight 2650 lbs/ft (kg/m)	Weight 2680 lbs/ft (kg/m)
2650-05-□-0	2680-05-□-0	1.97 (50)	2.60 (66)	≈ 0.84 (1.25)	≈ 0.89 (1.33)
2650-06-□-0	2680-06-□-0	2.56 (65)	3.19 (81)	≈ 0.91 (1.36)	≈ 0.96 (1.43)
2650-07-□-0	2680-07-□-0	2.95 (75)	3.58 (91)	≈ 0.94 (1.40)	≈ 1.01 (1.51)
2650-09-□-0	2680-09-□-0	3.54 (90)	4.17 (106)	≈ 1.04 (1.55)	≈ 1.09 (1.62)
2650-10-□-0	2680-10-□-0	3.94 (100)	4.57 (116)	≈ 1.08 (1.61)	≈ 1.22 (1.81)
2650-12-□-0	2680-12-□-0	4.92 (125)	5.55 (141)	≈ 1.14 (1.70)	≈ 1.34 (1.99)
2650-15-□-0	2680-15-□-0	5.91 (150)	6.53 (166)	≈ 1.21 (1.80)	≈ 1.46 (2.17)
2650-17-□-0	2680-17-□-0	6.89 (175)	7.64 (194)	≈ 1.34 (2.00)	≈ 1.58 (2.35)

Choose from the radii below for all of the above sizes
Radius (mm) Example: 2650-10-100-0

	063*	075*	100	125	150	175	200	250
R	2.48 (063*)	2.95 (075*)	3.94 (100)	4.92 (125)	5.91 (150)	6.89 (175)	7.87 (200)	9.84 (250)
H	6.93 (176)	7.87 (200)	9.84 (250)	11.81 (300)	13.78 (350)	15.75 (400)	17.72 (450)	21.65 (550)
D	6.77 (172)	7.24 (184)	8.23 (209)	9.21 (234)	10.20 (259)	11.18 (284)	12.17 (309)	14.13 (359)
K	12.20 (310)	13.78 (350)	16.93 (430)	19.88 (505)	23.03 (585)	26.18 (665)	29.33 (745)	35.43 (900)

* Radius available upon request, please consult igus® for delivery time
Radii 063, 075: the e-tube is not completely enclosed. Please consult igus®

e-chain system® E2/000
 Series 2650/2680 e-chain® Half-Tubes and Full Tubes
 Interior Separation



2650
 2680

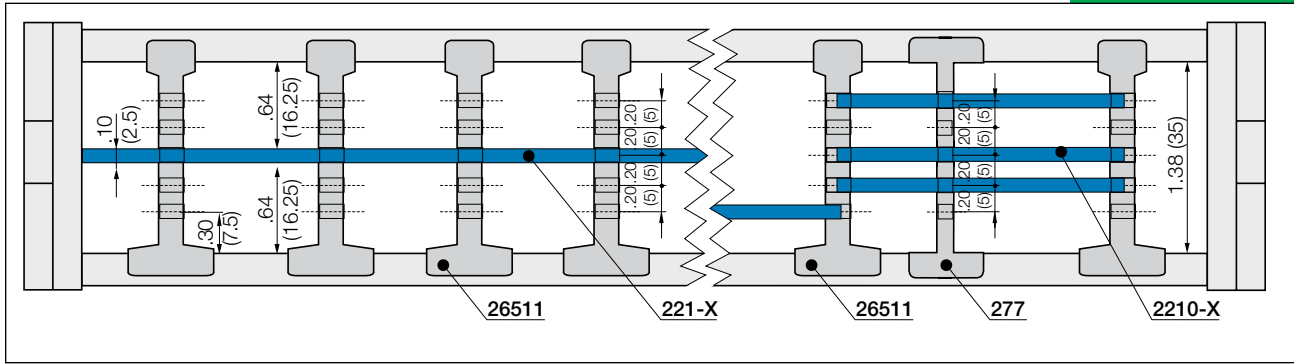

In the standard configuration separators are assembled every 2nd e-chain® link

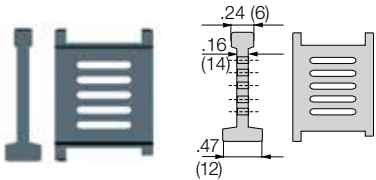

Separator, wide base

Unassembled	Part No. 26501
Assembled	Part No. 26511

● **Slotted separator 26501**

Separator with wide base for maximum locking strength and safe standing in e-chains®.

Full-width shelves - for the standard interior separation

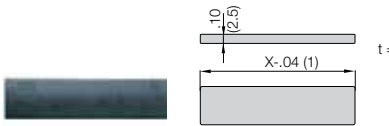

Separator, narrow head

Unassembled	Part No. 220-X
Assembled	Part No. 221-X

● **Full-width shelf 220-X**

this option makes sense in applications with many thin cables with similar diameters. For a consequent subdivision. Full-width shelves can be inserted at 5 different heights in .20" (5 mm) increments

Width X in. (mm)	Part No. Unassembled	Part No. Assembled	Width X in. (mm)	Part No. Unassembled	Part No. Assembled
.98 (25)	220-25	221-25	3.54 (90)	220-90	221-90
1.50 (38)	220-38	221-38	4.06 (103)	220-103	221-103
2.24 (57)	220-57	221-57	4.92 (125)	220-125	221-125
3.03 (77)	220-77	221-77			

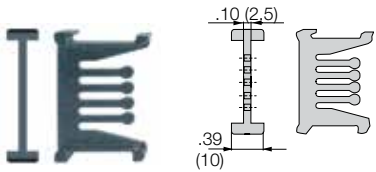

Separator, wide base

Unassembled	Part No. 276
Assembled	Part No. 276

● **Slotted separator 276**

Separator with wide base for maximum locking strength and safe standing in e-chains®.

Full-width shelves - for the standard interior separation

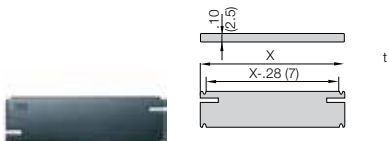

Separator, narrow head

Unassembled	Part No. 2200-X
Assembled	Part No. 2210-X

● **Full-width shelf 2200-X**

this option makes sense in applications with many thin cables with similar diameters. For a consequent subdivision. Full-width shelves can be inserted at 5 different heights in .20" (5 mm) increments

Width X in. (mm)	Part No. Unassembled	Part No. Assembled	Width X in. (mm)	Part No. Unassembled	Part No. Assembled
.98 (25)	2200-25	2210-25	3.54 (90)	2200-90	221-90
1.50 (38)	2200-38	2210-38	4.06 (103)	2200-103	2210-103
2.24 (57)	2200-57	2210-57	4.92 (125)	2200-125	2210-125
3.03 (77)	2200-77	2210-77			

PDF: igus.com/e-chain-pdfs
 Product information: igus.com/e-chains



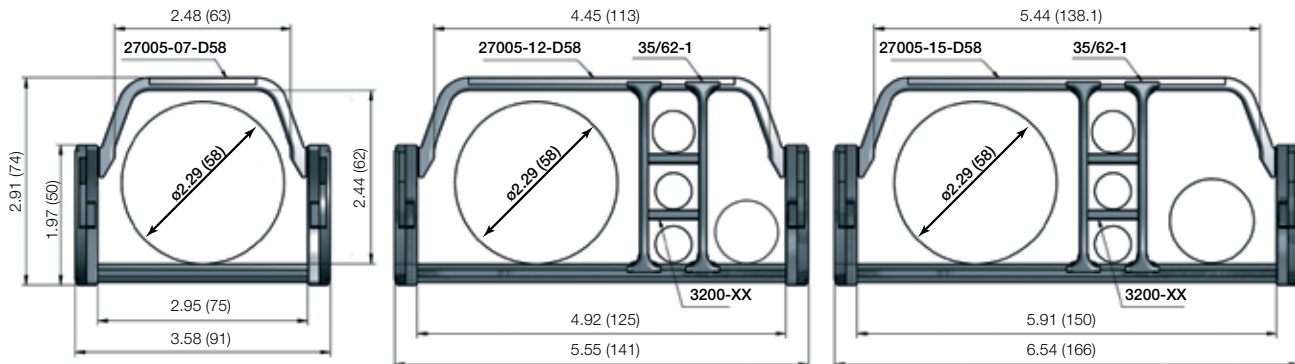

Part Number.
Extender crossbars
for e-chains®
that snap-open
along inner radius

		<i>Bi</i>	<i>Ba</i>
		in. (mm)	in. (mm)
2650-07D58-	<input type="checkbox"/> -0	2.95 (75)	3.58 (91)
2650-12D58-	<input type="checkbox"/> -0	4.92 (125)	5.55 (141)
2650-15D58-	<input type="checkbox"/> -0	5.91 (150)	6.54 (166)

Choose from the radii below for all of the above sizes

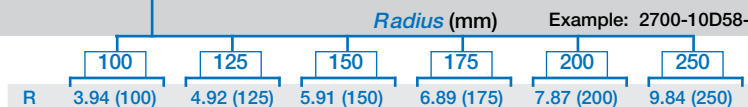

Interior separation for extender crossbars

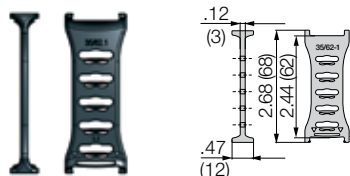

Separator, wide base

Unassembled	Part No. 35/62-1
Assembled	Part No. 35/62-1-1

- **Standard separator 35/62-1, wide base**
For maximum locking strength and safe standing. In standard configuration separators are assembled every 2nd e-chain® link.

Lockable full-width shelves - for the standard interior separation

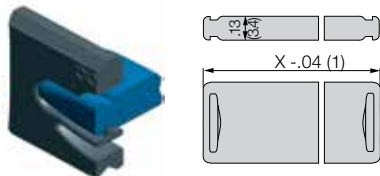

Full width shelf, lockable

Unassembled	Part No. 3200-X
Assembled	Part No. 3210-X

- **Full width shelf, lockable**
is used when vertical and horizontal separation is required.

Width X in. (mm)	Part No. Unassembled	Part No. Assembled	Width X in. (mm)	Part No. Unassembled	Part No. Assembled
1.97 (050)	3200-50	3210-50	5.91 (150)	3200-150	3210-150
2.95 (075)	3200-75	3210-75	6.89 (175)	3200-175	3210-175
3.94 (100)	3200-100	3210-100	7.87 (200)	3200-200	3210-200
4.53 (115)	3200-115	3210-115	8.86 (225)	3200-225	3210-225
4.92 (125)	3200-125	3210-125	9.84 (250)	3200-250	3210-250

Separator with integrated strain relief

Strain relief separator Part No. 262-Z can be integrated into the mounting bracket and can be placed there at any point of the e-chain®. It combines strain relief and interior separation, it can be installed on the first or last e-chain® link and is easy to assemble without any screws.

For more information ► Chapter 10, Strain Relief



e-chain system® E2/000

Series 2650/2680 e-chain® Half-Tubes and Full Tubes

Mounting Bracket - Plastic



2650
2680

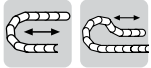

Option 1: pivoting

- For unsupported and gliding applications
- Well suited for tight installation conditions
- Detachable strain relief tiwrap plates
- Can be mounted on the fixed and/or moving end

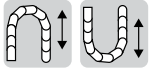

Option 2: locking

- For unsupported and gliding applications
- Extreme speed and/or accelerations
- For height restricted applications
- Can be mounted on the fixed and/or moving end



Part Number Structure

2605- 34 PZB K1

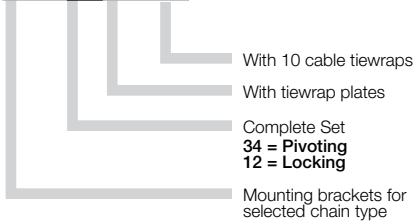

- With 10 cable tiwraps
- With tiwrap plates
- Complete Set
34 = Pivoting
12 = Locking
- Mounting brackets for selected chain type

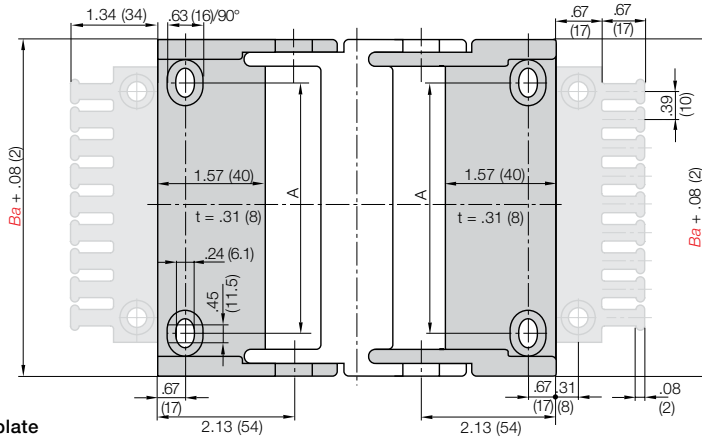

Full set, for both ends:

2605- [34] [PZB] Full set, each part with pin/bore + tiwrap plate

Single-part order:

2605- [3] [PZB] Mounting bracket with bore + tiwrap plate

2605- [4] [PZB] Mounting bracket with pin + tiwrap plate

Part No. Full Set (pivoting)

With Tiwrap Plates

Series 2650:

2605-34PZB

Part No. Full Set (locking)

With Tiwrap Plates + 10 cable ties

Series 2650:

2605-34PZBK1

For Chain Type	Part No. Full Set without Tiwrap Plate	Part No. Full Set with Tiwrap Plate	Part No. Full Set with Tiwrap Plate + 10 cable ties	Dimension A in. (mm)	Number of Teeth
2650/2680-05	2605- [] PZ	2605- [] PZB	2605- [] PZBK1	1.18 (30)	5
2650/2680-06	2606- [] PZ	2606- [] PZB	2606- [] PZBK1	1.77 (45)	5
2650/2680-07	2607- [] PZ	2607- [] PZB	2607- [] PZBK1	2.17 (55)	7
2650/2680-09	2609- [] PZ	2609- [] PZB	2609- [] PZBK1	2.76 (70)	9
2650/2680-10	2610- [] PZ	2610- [] PZB	2610- [] PZBK1	3.15 (80)	10
2650/2680-12	2612- [] PZ	2612- [] PZB	2612- [] PZBK1	4.13 (105)	12
2650/2680-15	2615- [] PZ	2615- [] PZB	2615- [] PZBK1	5.12 (130)	15
2650/2680-17	2617- [] PZ	2617- [] PZB	2617- [] PZBK1	6.10 (155)	17

34 or 12

For pivoting brackets choose 34

For locking brackets choose 12

Example: 2605- [34] PZB

PDF: igus.com/e-chain-pdfs
Product information: igus.com/e-chains



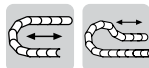

Option 1: pivoting

- For unsupported applications
- Bolted connection outside of chain cross section
- Confined installation conditions
- Attachment points on all sides
- Stackable

Moving end
2650 = 26500...1
2680 = 24800...1

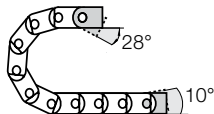

Fixed end
2650 = 26500...2
2680 = 26800...2

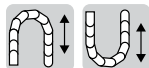

Option 2: locking

- For vertical hanging/standing applications
- Bolted connection outside of chain cross section
- For very high speeds and accelerations
- Attachment points on all sides
- Stackable

Moving end
2650 = 24510...1
2680 = 24810...1

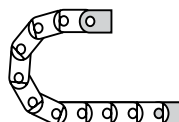

Fixed end
2650 = 24510...2
2680 = 24810...2



Part Number Structure

26500-10-12 P

- With profile rail
- Complete Set
- Width
- Mounting brackets for selected chain type
26500 = Pivoting
26800 = Locking

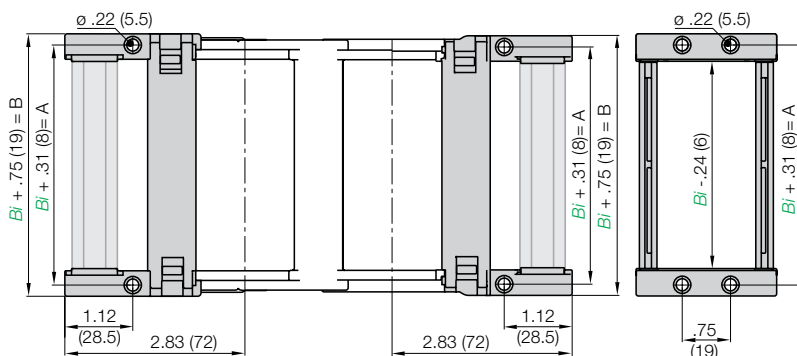

Full set, for both ends:

26500-12 P Full set, each part with pin/bore + profile rail

Single-part order:

26500-1 P Mounting bracket with bore + profile rail

26500-2 P Mounting bracket with pin + profile rail

Part No. Full Set (pivoting)

With Profile Rail

Series 2650/2680:

26500-Width-12P

Part No. Full Set (pivoting)

Without Profile Rail

Series 2650/2680:

26500-Width-12

For Chain Type	Part No. Full set with Profile Rail	Part No. Full Set without Profile Rail	Dimension A in. (mm)	Dimension B in. (mm)
2650/2680-05	<input type="text"/> -05-12P	<input type="text"/> -05-12	2.28 (58)	2.72 (69)
2650/2680-06	<input type="text"/> -06-12P	<input type="text"/> -06-12	2.87 (73)	3.31 (84)
2650/2680-07	<input type="text"/> -07-12P	<input type="text"/> -07-12	3.27 (83)	3.70 (94)
2650/2680-09	<input type="text"/> -09-12P	<input type="text"/> -09-12	3.86 (98)	4.29 (109)
2650/2680-10	<input type="text"/> -10-12P	<input type="text"/> -10-12	4.25 (108)	4.69 (119)
2650/2680-12	<input type="text"/> -12-12P	<input type="text"/> -12-12	5.24 (133)	5.67 (144)
2650/2680-15	<input type="text"/> -15-12P	<input type="text"/> -15-12	6.22 (158)	6.65 (169)
2650/2680-17	<input type="text"/> -17-12P	<input type="text"/> -17-12	7.20 (183)	7.64 (194)

26500
26800

or

26510
26810

For pivoting brackets choose 26500 or 26800

For locking brackets choose 26510 or 26810

Example: 26500 -10-12P

e-chain system® E2/000

Series 2650/2680 e-chain® Half-Tubes and Full Tubes

Mounting Bracket - Steel



2650
2680

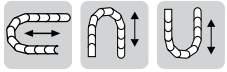

Option 1: Steel

- One part (two-piece) for all chain widths
- Electrically conductive
- Bolted connection outside of chain cross-section possible

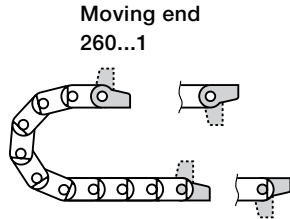

Fixed end
260...2

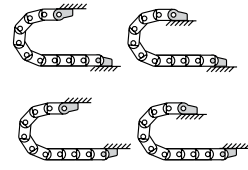

Possible installation configurations -

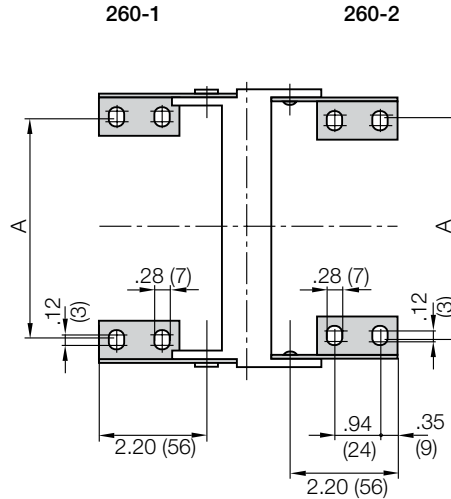
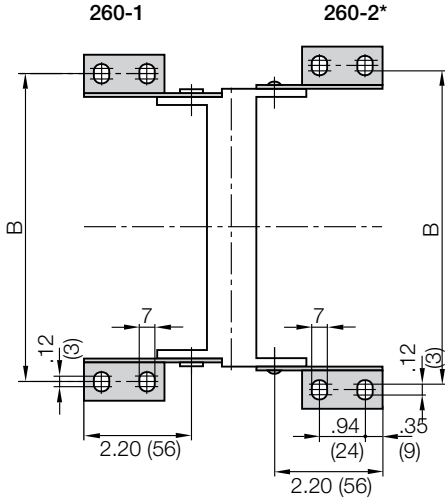

*pivoting with no stop, (360°)

Chain Type	Part No. Full Set	Dimension A		Dimension B	
		in.	(mm)	in.	(mm)
2650/2680-05	260-12	1.46	(37)	3.27	(83)
2650/2680-06	260-12	2.05	(52)	3.86	(98)
2650/2680-07	260-12	2.44	(62)	4.25	(108)
2650/2680-09	260-12	3.03	(77)	4.84	(123)
2650/2680-10	260-12	3.43	(87)	5.24	(133)
2650/2680-12	260-12	4.41	(112)	6.22	(158)
2650/2680-15	260-12	5.39	(137)	7.20	(183)
2650/2680-17	260-12	6.42	(163)	8.23	(209)

Part No. Mounting Brackets Full Set

4 parts, 2 with pin, 2 with bore
Series 2650/2680:
260-12

Part No. Mounting Bracket Moving End

2 parts, 1 left & 1 right
Series 2650/2680:
260-1

Part No. Mounting Bracket Fixed End

2 parts, 1 left & 1 right
Series 2650/2680:
260-2

PDF: igus.com/e-chain-pdfs
Product information: igus.com/e-chains



Chainfix clamps for the profile rail



igus® Chainfix strain relief elements are available in either steel or stainless steel. They can be adjusted with a hexagon socket and are available in single, double and triple configurations.

Part No. Single Clamp		Part No. Double Clamp		Part No. Triple Clamp		Cable ø	
Steel	Stainless	Steel	Stainless	Steel	Stainless	in.	(mm)
CFX12-1	CFX12-1E	CFX12-2	CFX12-2E	CFX12-3	-	.24 - .47	(06 - 12)
CFX14-1	CFX14-1E	CFX14-2	CFX14-2E	CFX14-3	-	.47 - .55	(12 - 14)
CFX16-1	CFX16-1E	CFX16-2	CFX16-2E	CFX16-3	-	.55 - .63	(14 - 16)
CFX18-1	CFX18-1E	CFX18-2	CFX18-2E	CFX18-3	-	.63 - .71	(16 - 18)
CFX20-1	CFX20-1E	CFX20-2	CFX20-2E	CFX20-3	-	.71 - .79	(18 - 20)
CFX22-1	CFX22-1E	CFX22-2	CFX22-2E	CFX22-3	-	.79 - .87	(20 - 22)
CFX26-1	CFX26-1E	CFX26-2	CFX26-2E	-	-	.87 - 1.02	(22 - 26)
CFX30-1	CFX30-1E	CFX30-2	CFX30-2E	-	-	1.02 - 1.18	(26 - 30)
CFX34-1	CFX34-1E	CFX34-2	CFX34-2E	-	-	1.18 - 1.34	(30 - 34)
CFX38-1	CFX38-1E	-	-	-	-	1.34 - 1.50	(34 - 38)
CFX42-1	CFX42-1E	-	-	-	-	1.50 - 1.65	(38 - 42)

For more information please refer to strain relief section of Chapter 10

Tiewrap Plates

**Option 1:
Tiewrap plates as an individual part**

Available as an individual component, can be fixed onto a mounting bracket with the use of a profile rail.

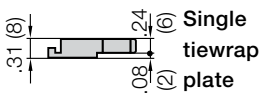
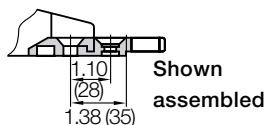

Tiewrap Plate	n Number of Teeth	C Overall Width in. (mm)	B Bore Width in. (mm)	Center Bore
3050-ZB	5	1.97 (50)	1.18 (30)	no
3075-ZB	7	2.95 (75)	2.16 (55)	no
3100-ZB	10	3.94 (100)	3.15 (80)	no
3115-ZB	11	4.53 (115)	3.74 (95)	no
3125-ZB	12	4.92 (125)	4.13 (105)	no
3150-ZB	15	5.91 (150)	5.12 (130)	no
3175-ZB	17	6.89 (175)	6.10 (155)	no
3200-ZB	20	7.87 (200)	7.09 (180)	yes
3225-ZB	22	8.86 (225)	8.07 (205)	yes
3250-ZB	25	9.84 (250)	9.06 (230)	yes

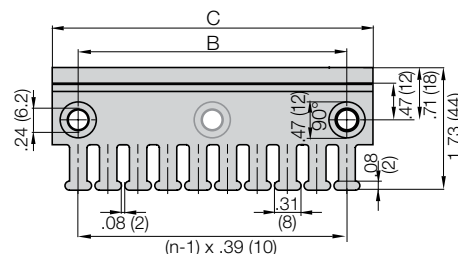

For more information please refer to strain relief section of Chapter 10

**Option 2:
Clip-on Tiewrap plates**

Available as a clip-on tiewrap plate without the use of bolts They are inserted and removed with a screwdriver used as a lever. Clip-on tiewrap plates are also available as an attachment to the opening crossbars.

Part No.	Number of Teeth	Width of Strain Relief in. (mm)
3050-ZC	5	1.97 (50)
3075-ZC	7	2.95 (75)

For more information please refer to strain relief section of Chapter 10

Strain relief for steel mounting brackets

Clip-on connection is not possible with steel mounting brackets. In this case, the tiewrap plates must be bolted directly into separate bore holes in front of the mounting bracket. Alternatively the tiewrap plates 30XX-Z and ZS can be also used here. Details chapter 10





2650
2680

PDF: igus.com/e-chain-pdfs
Product information: igus.com/e-chains



3400
3500



e-chain system® E2/000 Series 3400/3500



Price Index



Series 3400/3500

Special Features / Options



IPA Qualification Certificate, Air Cleanliness Class ISO Class 3 (at v = 2 m/s) upon request



ESD classification: Electrically conductive ESD/ATEX version upon request



UL94 V2 classifications upon request

Assembly Tips



Snap-open mechanism, choice of snap-open on left or right. Hinged crossbar can be swiveled by more than 180° on both sides. Lightning-fast closing by hand. Secure fit without additional locking devices.

Other Installation Methods

Vertical, hanging ≤ 262 ft (80 m)

Vertical, standing ≤ 9.84 ft (3 m)

Side-mounted, un_supp. ≤ 3.28 ft (1 m)

Rotary requires further calculation

Usage Guidelines



- If snap-open accessibility along the inner or outer radius is required
- If integrated strain relief at the mounting point is required
- If modular interior separation is needed
- If long service life is required
- If easy installation is required



- If the application is very simple
➤ Series E300 E-Z Chain
- If greater stability is required
➤ Series E4-42 E4-1 Series

Features & Benefits

- 1 Tried-and-tested mounting bracket
- 2 Snap-open crossbar for easy opening from the left or right
- 3 Series 3500 snap-open on both sides along outer radius
- 4 Series 3400 snap-open on both sides along inner radius
- 5 Integrated strain relief possible
- 6 Modular interior separation
- 7 Easy assembly by optimized pin
- 8 Double stop dog for long unsupported length
- 9 Crossbars with high retention force
- 10 Also available as ESD version
- 11 Strain relief separator available

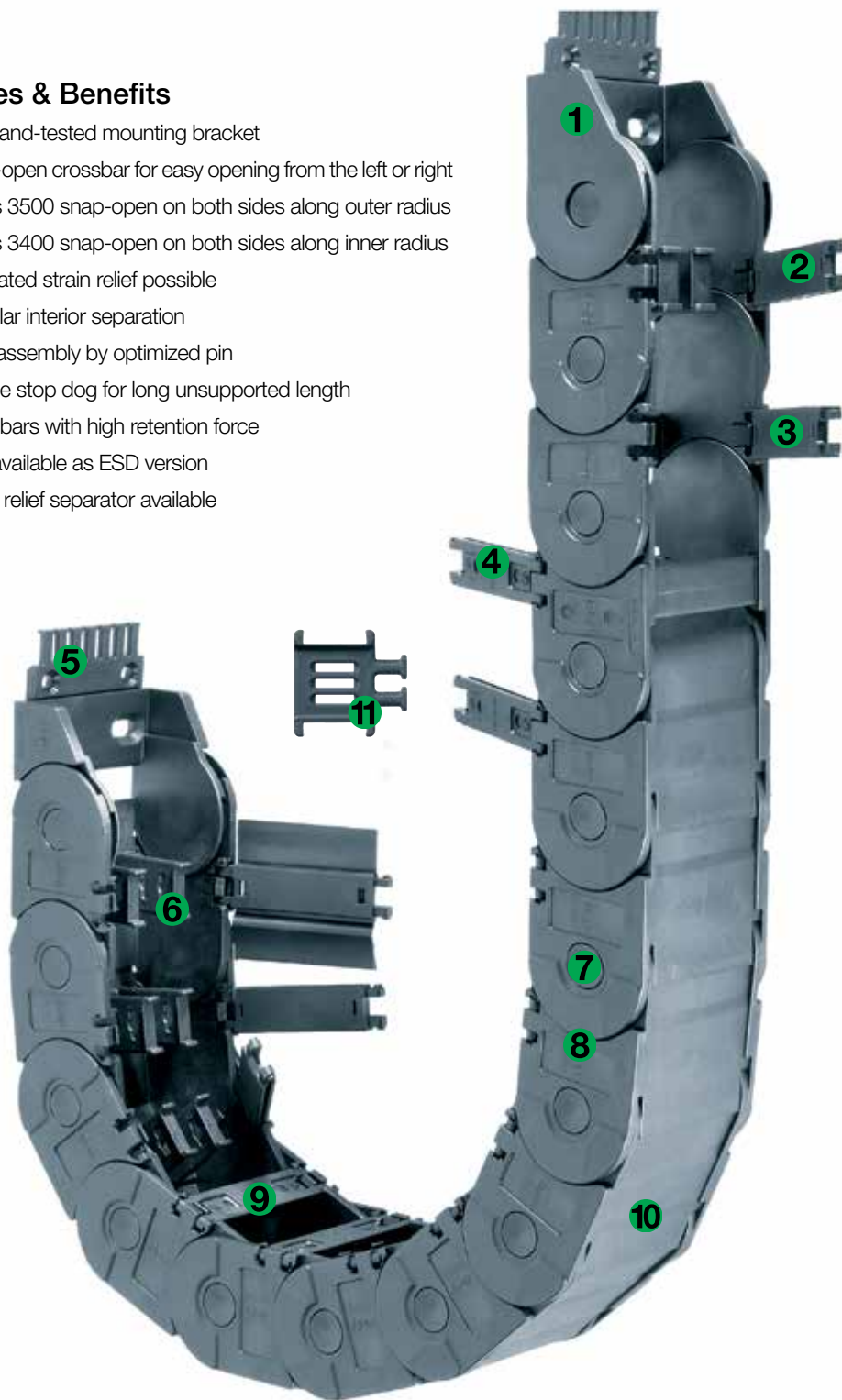

Order Example: Complete e-chain®

Please indicate chain length or number of links. Example:

9.84 ft (3 m) **3400-100-100-0**



e-chain®

With 2 separators **45.1.1** assembled every 2nd link



Interior Separation

1 Set **3100-34PZB**



Mounting Bracket

e-chain system® E2/000

Series 3400/3500

Installation Dimensions

Short travel, unsupported length

- FL_B = unsupported with permitted sag
 - FL_G = unsupported with straight upper run
- Further information ► Design, Chapter 1

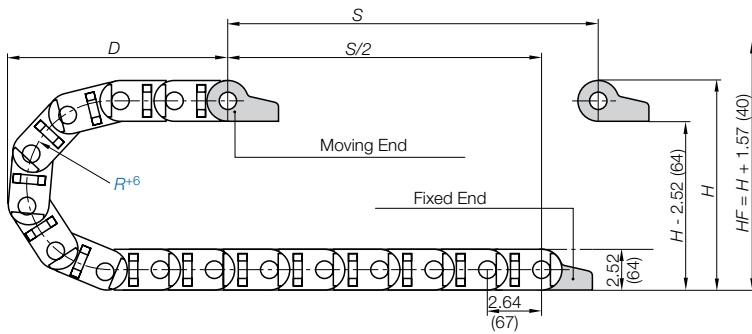
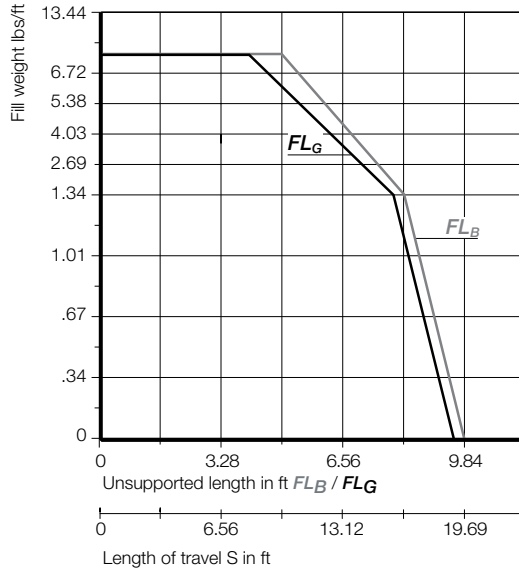
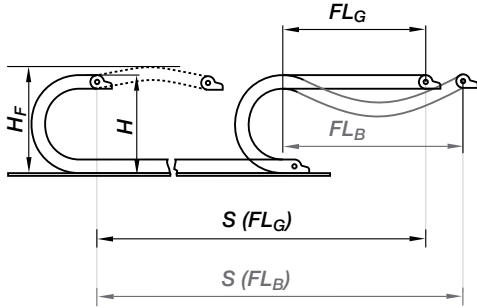

Pitch per link: = 2.64" (67 mm)
 Links per ft (m): = 4.57 (15)
 For center mount applications:
 Chain length = $S/2 + K$

The required clearance height: $H_f = H + 1.57$ in. (40 mm) (with 1.68 lbs/ft (2.5 kg/m) fill weight).
 Please consult igus® if space is particularly restricted.

R	1.50 (075)	3.94 (100)	4.92 (125)	5.91 (150)	7.87 (200)	9.84 (250)	11.81 (300)
H	8.43 (214)	10.39 (264)	12.36 (314)	14.33 (364)	18.27 (464)	22.20 (564)	26.14 (664)
D	8.19 (208)	9.17 (233)	10.16 (258)	11.14 (283)	13.11 (333)	15.08 (383)	17.05 (433)
K	14.57 (370)	17.72 (450)	20.87 (530)	24.02 (610)	30.11 (765)	36.22 (920)	42.52 (1080)

For long travels with lowered mounting height

Long travel lengths from 32.8 ft. (10 m) to max. 492 ft. (150 m)

For long travels, igus® specifies Series 3500 that snap open on the outer radius.

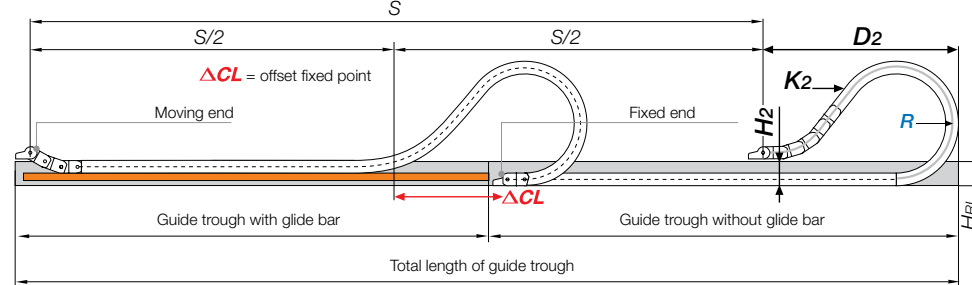

For center mount applications:
 Chain length: = $S/2 + K_2$

R	1.50 (075)	3.94 (100)	4.92 (125)	5.91 (150)	7.87 (200)	9.84 (250)	11.81 (300)
H_2	5.91 (150)	7.87 (200)	7.32 (186)	7.32 (186)	7.32 (186)	7.32 (186)	7.32 (186)
D_2^{25}	8.19 (208)	9.17 (233)	18.70 (475)	22.44 (570)	30.71 (780)	39.76 (1010)	45.28 (1150)
K_2	14.57 (370)	17.72 (450)	31.65 (804)	39.57 (1005)	52.76 (1340)	65.94 (1675)	76.50 (1943)
ΔCL	—	—	9.17 (233)	11.93 (303)	18.23 (463)	25.31 (643)	28.86 (733)

Speed / acceleration FL_G	max. 65.6 ft/s (20 m/s) / max. 656 ft/s ² (200 m/s ²)
Speed / acceleration FL_B	max. 9.84 ft/s (3 m/s) / max. 19.69 ft/s ² (6 m/s ²)
Gliding speed / acceleration (maximum)	max. 32.8 ft/s (10 m/s) / max. 164 ft/s ² (50 m/s ²)
Material - permitted temperature	igumid G / -40°F (-40°C) up to +248°F (+120°C)
Flammability Class, igumid G	VDE 0304 IIC UL94 HB



3400
3500

Short Travels - Unsupported



Unsupported e-chains® feature positive camber over short travels. This must be accounted for when specifying the clearance height. Please refer to Installation dimensions for further details.

Legend

- S = Length of travel
- R = Bending radius
- H = Nominal clearance height
- D = Overlength e-chain® radius in final position
- $K = \pi \cdot R + \text{safety buffer}$
- H_f = Required clearance height
- H_{R1} = Trough inner height
- H_2 = *Mounting height
- D_2 = Overlength - long travels, gliding
- K_2 = *Add-on

*If the mounting bracket location is set lower

Long Travels - Gliding



If the unsupported length is exceeded, the e-chain® must glide on itself. This requires a guide trough. Design, Chapter 1

Technical Data



Details of material properties

► Chapter 1



PDF: igus.com/e-chain-pdfs
 Product information: igus.com/e-chains



Series 3400 - snap-open along the inner radius

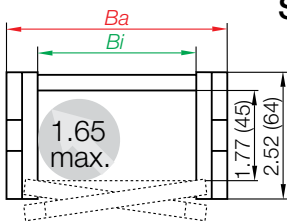

Part Number Structure

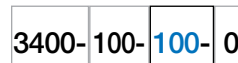

Color - Black
Bending radius
Width
Series

Series 3500 - snap-open along the outer radius

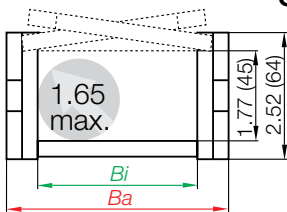

Part Number Structure



Color - Black
Bending radius
Width
Series

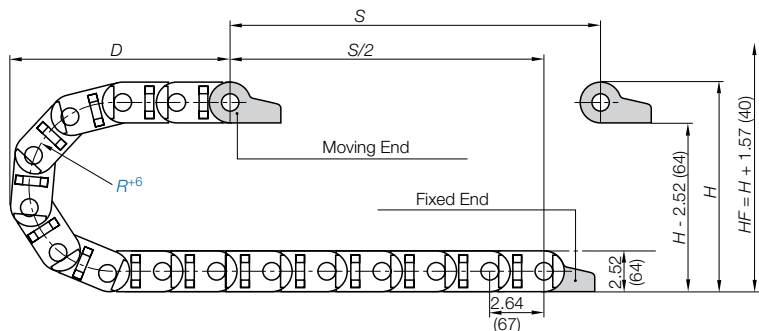

Supplement part number with required radius.
Example: 3500-100-100-0
Pitch: 264 in. (67 mm) per link links/ft(m) = 4.57 (15)

Part Number.

Snap-open inner radius	Snap-open outer radius	Bi in. (mm)	Ba in. (mm)	Weight lbs/ft (kg/m)
3400-050-□-0	3500-050-□-0	1.97 (50)	2.76 (70)	≈ 1.07 (1.60)
3400-075-□-0	3500-075-□-0	2.95 (75)	3.74 (95)	≈ 1.20 (1.78)
3400-100-□-0	3500-100-□-0	3.94 (100)	4.72 (120)	≈ 1.30 (1.93)
3400-115-□-0	3500-115-□-0	4.53 (115)	5.31 (135)	≈ 1.34 (1.99)
3400-125-□-0	3500-125-□-0	4.92 (125)	5.71 (145)	≈ 1.36 (2.03)
3400-150-□-0	3500-150-□-0	5.91 (150)	6.69 (170)	≈ 1.46 (2.17)
3400-175-□-0	3500-175-□-0	6.89 (175)	7.68 (195)	≈ 1.53 (2.28)
3400-200-□-0	3500-200-□-0	7.87 (200)	8.66 (220)	≈ 1.65 (2.45)
3400-225-□-0	3500-225-□-0	8.86 (225)	9.65 (245)	≈ 1.74 (2.59)
3400-250-□-0	3500-250-□-0	9.84 (250)	10.63 (270)	≈ 1.83 (2.73)

Choose from the radii below for all of the above sizes

Radius (mm) Example: 3500-100-100-0

	075	100	125	150	200	250	300
R	1.50 (075)	3.94 (100)	4.92 (125)	5.91 (150)	7.87 (200)	9.84 (250)	11.81 (300)
H	8.43 (214)	10.39 (264)	12.36 (314)	14.33 (364)	18.27 (464)	22.20 (564)	26.14 (664)
D	8.19 (208)	9.17 (233)	10.16 (258)	11.14 (283)	13.11 (333)	15.08 (383)	17.05 (433)
K	14.57 (370)	17.72 (450)	20.87 (530)	24.02 (610)	30.11 (765)	36.22 (920)	42.52 (1080)

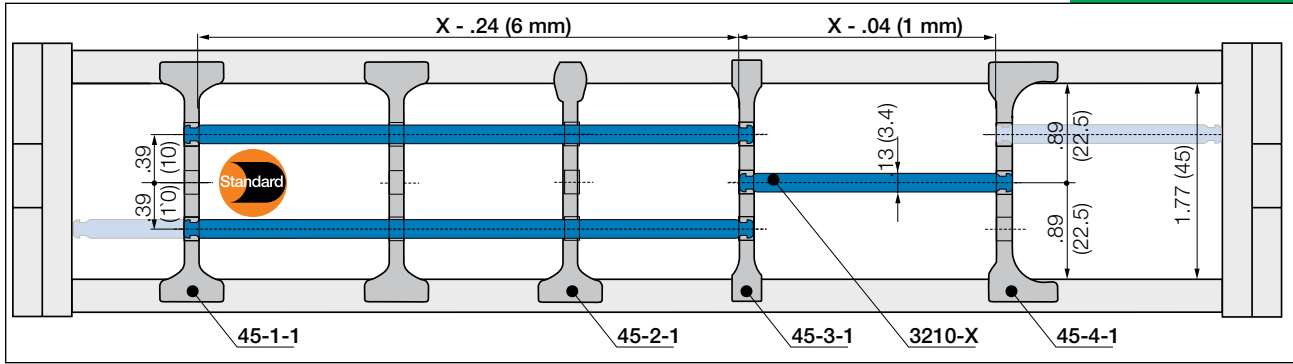

In the standard configuration separators are assembled every 2nd e-chain® link

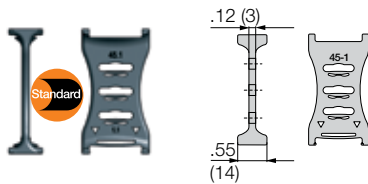

Separator, wide base

Unassembled	Part No. 45.1
Assembled	Part No. 45.1.1

- **Standard separator 45.1 for all applications**

Separator with wide base for maximum locking strength and safe standing in e-chains®.

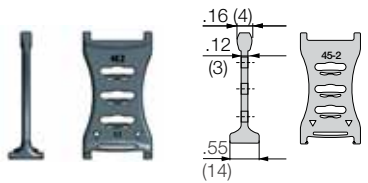

Separator, narrow head

Unassembled	Part No. 45.2
Assembled	Part No. 45.2.1

- **Separator 45.2 For even faster installation**

is used when vertical and horizontal separation is required. Due to its slot, it allows basic vertical/horizontal shelving arrangements.

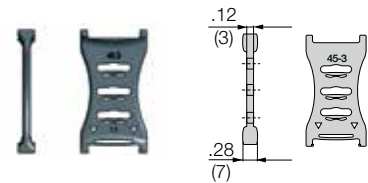

Separator, narrow base

Unassembled	Part No. 45.3
Assembled	Part No. 45.3.1

- **Separator 45.3 For many thin cables**

is used when vertical and horizontal separation is required. Due to its slot, it allows basic vertical/horizontal shelving arrangements.

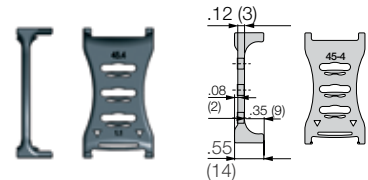

Separator, asymmetrical

Unassembled	Part No. 45.4
Assembled	Part No. 45.4.1

- **Separator 45.4 For side mounted applications**

is used when vertical and horizontal separation is required. Due to its slot, it allows basic vertical/horizontal shelving arrangements.

Lockable full-width shelves - for the standard interior separation

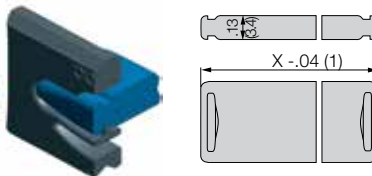

Full width shelf, lockable

Unassembled	Part No. 3200-X
Assembled	Part No. 3210-X

- **Full width shelf, lockable**

is used when vertical and horizontal separation is required.

Width X in. (mm)	Part No. Unassembled	Part No. Assembled	Width X in. (mm)	Part No. Unassembled	Part No. Assembled
1.97 (050)	3200-50	3210-50	5.91 (150)	3200-150	3210-150
2.95 (075)	3200-75	3210-75	6.89 (175)	3200-175	3210-175
3.94 (100)	3200-100	3210-100	7.87 (200)	3200-200	3210-200
4.53 (115)	3200-115	3210-115	8.86 (225)	3200-225	3210-225
4.92 (125)	3200-125	3210-125	9.84 (250)	3200-250	3210-250



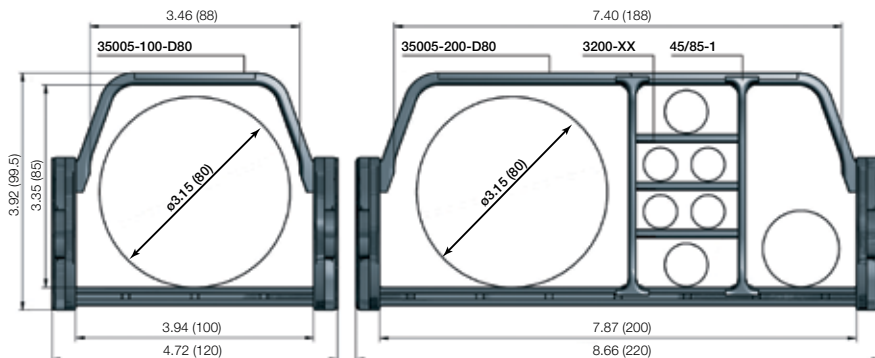

Part Number.

Extender crossbars for e-chains® that snap-open along inner radius		Extender crossbars for e-chains® that snap-open along outer radius		<i>Bi</i>	<i>Ba</i>
				in. (mm)	in. (mm)
3400-100D80-	<input type="checkbox"/> -0	3500-100D80-	<input type="checkbox"/> -0	2.95 (100)	3.58 (120)
3400-200D80-	<input type="checkbox"/> -0	3400-200D80-	<input type="checkbox"/> -0	4.92 (200)	5.55 (220)

Choose from the radii below for all of the above sizes

Radius (mm)		Example: 2700-10D58-	
<i>R</i>	075*	100*	100
	2.95 (075)	3.94 (100)	9.84 (250)

*Radius 075 and 100 are only available for Series 3500 e-chains®

Interior separation for extender crossbars

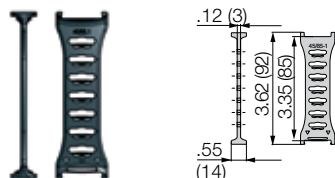

Separator, wide base

Unassembled	Part No. 45/85.1
Assembled	Part No. 45/85.1.1

- **Standard separator 45/85.1, wide base**
For maximum locking strength and safe standing. In standard configuration separators are assembled every 2nd e-chain® link.

Lockable full-width shelves - for the standard interior separation

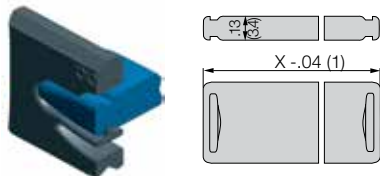

Full width shelf, lockable

Unassembled	Part No. 3200-X
Assembled	Part No. 3210-X

- **Full width shelf, lockable**
is used when vertical and horizontal separation is required.

Width X in. (mm)	Part No. Unassembled	Part No. Assembled	Width X in. (mm)	Part No. Unassembled	Part No. Assembled
1.97 (050)	3200-50	3210-50	5.91 (150)	3200-150	3210-150
2.95 (075)	3200-75	3210-75	6.89 (175)	3200-175	3210-175
3.94 (100)	3200-100	3210-100	7.87 (200)	3200-200	3210-200
4.53 (115)	3200-115	3210-115	8.86 (225)	3200-225	3210-225
4.92 (125)	3200-125	3210-125	9.84 (250)	3200-250	3210-250

Separator with integrated strain relief

Strain relief separator Part No. 301-Z can be integrated into the mounting bracket and can be placed there at any point of the e-chain®. It combines strain relief and interior separation, it can be installed on the first or last e-chain® link and is easy to assemble without any screws.



For more information ► Chapter 10, Strain Relief

e-chain system® E2/000

Series 3400/3500

Mounting Bracket - Plastic



3400
3500

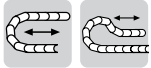

Option 1: pivoting

- For unsupported and gliding applications
- Well suited for tight installation conditions
- Detachable strain relief tiwrap plates
- Can be mounted on the fixed and/or moving end

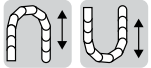

Option 2: locking

- For unsupported and gliding applications
- Extreme speed and/or accelerations
- For height restricted applications
- Can be mounted on the fixed and/or moving end



Part Number Structure

3075- 34 PZB K1

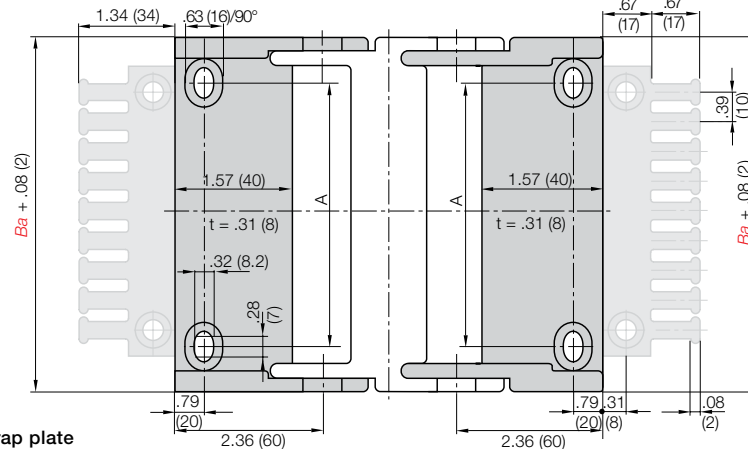
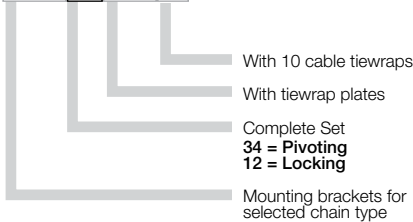

Full set, for both ends:

3075- [34] PZB Full set, each part with pin/bore + tiwrap plate

Single-part order:

3075- [3] PZB Mounting bracket with bore + tiwrap plate

3075- [4] PZB Mounting bracket with pin + tiwrap plate

Part No. Full Set (pivoting)

Without Tiwrap Plates

Series 3400:

3075-34PZ

Part No. Full Set (pivoting)

With Tiwrap Plates

Series 3400:

3075-34PZB

Part No. Full Set (pivoting)

With Tiwrap Plates + 10 cable ties

Series 3400:

3075-34PZBK1

For Chain Type	Part No. Full Set without Tiwrap Plate	Part No. Full Set with Tiwrap Plate	Part No. Full Set with Tiwrap Plate + 10 cable ties	Dimension A in. (mm)	Number of Teeth
3400/3500-050	3050- [] PZ	3050- [] PZB	3050- [] PZBK1	2.09 (28)	5
3400/3500-075	3075- [] PZ	3075- [] PZB	3075- [] PZBK1	2.09 (53)	7
3400/3500-100	3100- [] PZ	3100- [] PZB	3100- [] PZBK1	3.07 (78)	10
3400/3500-115	3115- [] PZ	3115- [] PZB	3115- [] PZBK1	3.66 (93)	11
3400/3500-125	3125- [] PZ	3125- [] PZB	3125- [] PZBK1	4.06 (103)	12
3400/3500-150	3150- [] PZ	3150- [] PZB	3150- [] PZBK1	5.04 (128)	15
3400/3500-175	3175- [] PZ	3175- [] PZB	3175- [] PZBK1	6.02 (153)	17
3400/3500-200	3200- [] PZ	3200- [] PZB	3200- [] PZBK1	7.01 (178)	20
3400/3500-225	3225- [] PZ	3225- [] PZB	3225- [] PZBK1	7.99 (203)	22
3400/3500-250	3250- [] PZ	3250- [] PZB	3250- [] PZBK1	8.98 (228)	25

34 or 12

For pivoting brackets choose 34

For locking brackets choose 12

Example: 3075- 34 PZB

PDF: igus.com/e-chain-pdfs
Product information: igus.com/e-chains



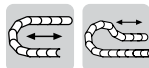

Option 1: pivoting

- For unsupported applications
- Bolted connection outside of chain cross section
- Confined installation conditions
- Attachment points on all sides
- Stackable

Moving end
34001...1

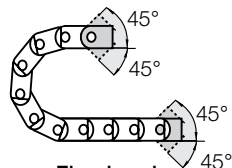

Fixed end
34001...2

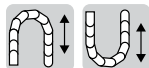

Option 2: locking

- For vertical hanging/standing applications
- Bolted connection outside of chain cross section
- For very high speeds and accelerations
- Attachment points on all sides
- Stackable

Moving end
34101...1

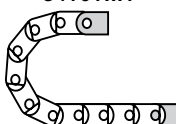

Fixed end
34101...2



Part Number Structure

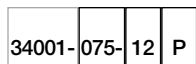

- 34001 - With profile rail
- 075 - Complete Set
- 12 - Width
- P - Mounting brackets for selected chain type
34001 = Pivoting
34101 = Locking

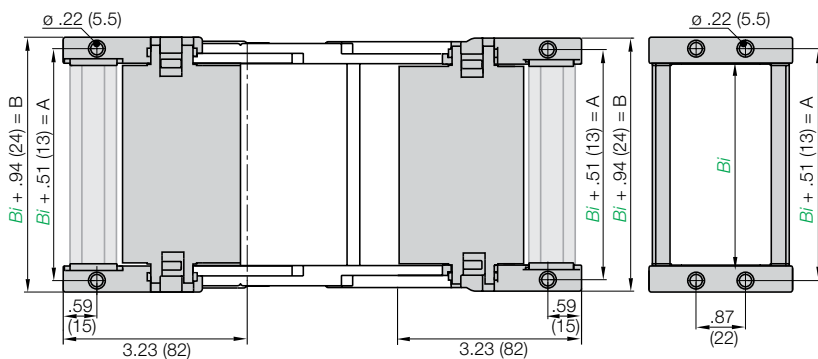

Full set, for both ends:

34001-12 P Full set, each part with pin/bore + profile rail

Single-part order:

34001-1 P Mounting bracket with bore + profile rail

34001-2 P Mounting bracket with pin + profile rail

Part No. Full Set (pivoting)

With Profile Rail

Series 3400/3500:

34001-Width-12P

Part No. Full Set (pivoting)

Without Profile Rail

Series 3400/3500:

34001-Width-12

For Chain Type	Part No. Full set with Profile Rail	Part No. Full Set without Profile Rail	Dimension A in. (mm)	Dimension B in. (mm)
3400/3500-050	34001-050-12P	34001-050-12	2.48 (63)	2.91 (74)
3400/3500-075	34001-075-12P	34001-075-12	3.46 (88)	3.90 (99)
3400/3500-100	34001-100-12P	34001-100-12	4.45 (113)	4.88 (124)
3400/3500-115	34001-115-12P	34001-115-12	5.04 (128)	5.47 (139)
3400/3500-150	34001-150-12P	34001-150-12	6.42 (163)	6.85 (174)
3400/3500-175	34001-175-12P	34001-175-12	7.40 (188)	7.83 (199)

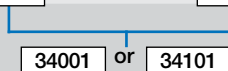

For pivoting brackets choose **34001**

For locking brackets choose **34101**

Example: **34001-075-12P**

e-chain system® E2/000

Series 3400/3500

Mounting Bracket - Steel



3400
3500

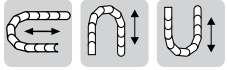

Option 1: Steel

- One part (two-piece) for all chain widths
- Electrically conductive
- Bolted connection outside of chain cross-section possible

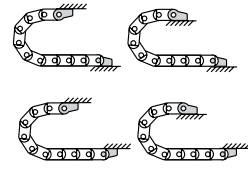
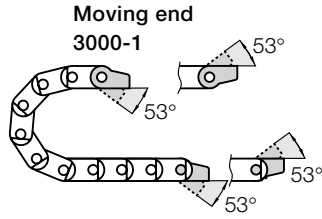

Possible installation configurations -

Fixed end
3000-2

3000-1

3000-2*

3000-1

3000-2

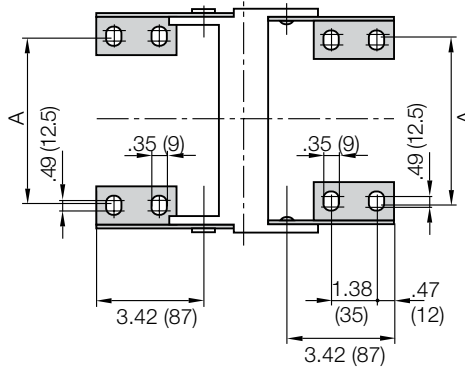
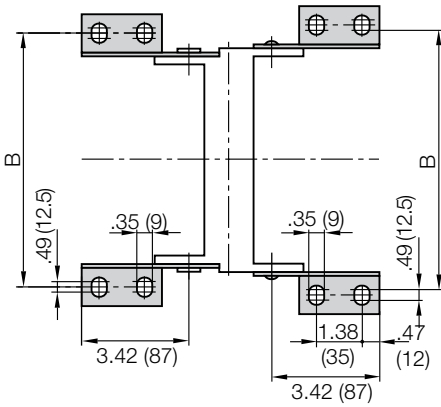

*pivoting with no stop, (360°)

Chain Type	Part No. Full Set	Dimension A		Dimension B	
		in.	(mm)	in.	(mm)
3400/3500-075	3000-12	2.09	(53)	4.37	(111)
3400/3500-100	3000-12	3.07	(78)	5.35	(136)
3400/3500-115	3000-12	3.66	(93)	5.94	(151)
3400/3500-150	3000-12	5.04	(128)	7.32	(186)
3400/3500-175	3000-12	6.02	(153)	8.35	(212)

Part No. Mounting Brackets Full Set

4 parts, 2 with pin, 2 with bore
Series 3400/3500:
3000-12

Part No. Mounting Bracket Moving End

2 parts, 1 left & 1 right
Series 3400/3500:
3000-1

Part No. Mounting Bracket Fixed End

2 parts, 1 left & 1 right
Series 3400/3500:
3000-2

PDF: igus.com/e-chain-pdfs
Product information: igus.com/e-chains



Chainfix clamps for the profile rail

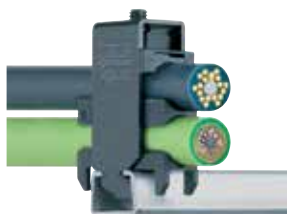

igus® Chainfix strain relief elements are available in either steel or stainless steel. They can be adjusted with a hexagon socket and are available in single, double and triple configurations.

Part No. Single Clamp		Part No. Double Clamp		Part No. Triple Clamp		Cable ø	
Steel	Stainless	Steel	Stainless	Steel	Stainless	in.	(mm)
CFX12-1	CFX12-1E	CFX12-2	CFX12-2E	CFX12-3	-	.24 - .47	(06 - 12)
CFX14-1	CFX14-1E	CFX14-2	CFX14-2E	CFX14-3	-	.47 - .55	(12 - 14)
CFX16-1	CFX16-1E	CFX16-2	CFX16-2E	CFX16-3	-	.55 - .63	(14 - 16)
CFX18-1	CFX18-1E	CFX18-2	CFX18-2E	CFX18-3	-	.63 - .71	(16 - 18)
CFX20-1	CFX20-1E	CFX20-2	CFX20-2E	CFX20-3	-	.71 - .79	(18 - 20)
CFX22-1	CFX22-1E	CFX22-2	CFX22-2E	CFX22-3	-	.79 - .87	(20 - 22)
CFX26-1	CFX26-1E	CFX26-2	CFX26-2E	-	-	.87 - 1.02	(22 - 26)
CFX30-1	CFX30-1E	CFX30-2	CFX30-2E	-	-	1.02 - 1.18	(26 - 30)
CFX34-1	CFX34-1E	CFX34-2	CFX34-2E	-	-	1.18 - 1.34	(30 - 34)
CFX38-1	CFX38-1E	-	-	-	-	1.34 - 1.50	(34 - 38)
CFX42-1	CFX42-1E	-	-	-	-	1.50 - 1.65	(38 - 42)

For more information please refer to strain relief section of Chapter 10

Tiewrap Plates

**Option 1:
Tiewrap plates as an individual part**

Available as an individual component, can be fixed onto a mounting bracket with the use of a profile rail.

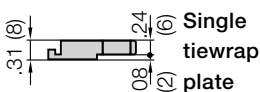
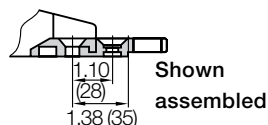

Tiewrap Plate	n Number of Teeth	C Overall Width in. (mm)	B Bore Width in. (mm)	Center Bore
3050-ZB	5	1.97 (50)	1.18 (30)	no
3075-ZB	7	2.95 (75)	2.16 (55)	no
3100-ZB	10	3.94 (100)	3.15 (80)	no
3115-ZB	11	4.53 (115)	3.74 (95)	no
3125-ZB	12	4.92 (125)	4.13 (105)	no
3150-ZB	15	5.91 (150)	5.12 (130)	no
3175-ZB	17	6.89 (175)	6.10 (155)	no
3200-ZB	20	7.87 (200)	7.09 (180)	yes
3225-ZB	22	8.86 (225)	8.07 (205)	yes
3250-ZB	25	9.84 (250)	9.06 (230)	yes

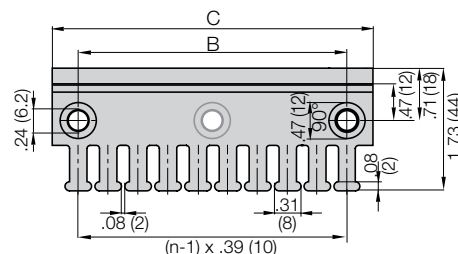

For more information please refer to strain relief section of Chapter 10

**Option 2:
Clip-on Tiewrap plates**

Available as a clip-on tiewrap plate without the use of bolts They are inserted and removed with a screwdriver used as a lever. Clip-on tiewrap plates are also available as an attachment to the opening crossbars.



Part No.	Number of Teeth	Width of Strain Relief in. (mm)
3050-ZC	5	1.97 (50)
3075-ZC	7	2.95 (75)

For more information please refer to strain relief section of Chapter 10

Strain relief for steel mounting brackets

Clip-on connection is not possible with steel mounting brackets. In this case, the tiewrap plates must be bolted directly into separate bore holes in front of the mounting bracket. Alternatively the tiewrap plates 30XX-Z and ZS can be also used here. **Details chapter 10**

e-chain[®] E2/000

Series 3400/3500

Guide Troughs



3400
3500

Guide troughs are used with applications where the upper run of the e-chain[®] glides on the lower run. If using igus[®] steel guide troughs, the following components are required:

- Full travel length of guide trough
Part Number 93-30
- 1/2 travel length of glide bars
Part number 93-01
- Installation sets as end connectors
Part Number 93-50 -XX

-XX indicates the length of the profile rail on which the guide trough is mounted. The values and part numbers are specified in the table on the left. The standard length of the trough components and glide bars is 6.56 ft (2 m.) The required overall length of the guide trough directly correlates to the length of travel.

Example:

Width of Crossbar
3500-075-200-0

	B_{Ri}	Installation Part No.
-050	2.95 (75)	93-50-200
-075	3.94 (100)	93-50-225
-100	4.92 (125)	93-50-250
-115	5.51 (140)	93-50-250
-125	5.91 (150)	93-50-275
-150	6.89 (175)	93-50-300
-175	7.87 (200)	93-50-325
-200	8.86 (225)	93-50-350
-225	9.84 (250)	93-50-375
-250	10.83 (275)	93-50-400

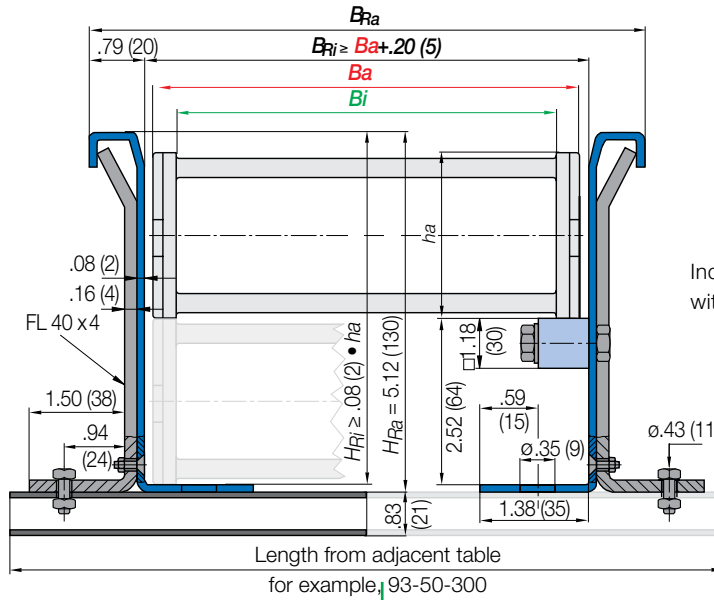

Length of travel 164 ft (50 m)
Center mounted
Required guide troughs:
164 ft (50 m) guide trough
82 ft (25 m) glide bar
= 25 sections of 6.56 ft (2 m) guide trough
Part No. 93-30
= 13 sections of 6.56 ft (2 m) glide bar
Part No. 93-01
Required number of installation sets:
= Number of guide trough components + 1
= 25 + 1 = 26
Part number of the installation sets
Example: 93-50-300 for 15.75" (400 mm) long profile rail.

- Guide trough
- Glide bars
- Installation set "Basic"
- Profile rail

Individual attachment without profile rail

* Specialized guide trough available upon request

PDF: igus.com/e-chain-pdfs
Product information: igus.com/e-chains



3450
3480



e-chain system® E2/000

Series 3450/3480 e-chain®

Half-Tubes and Full Tubes



Price Index



Series 3450/3480

Special Features / Options



IPA Qualification Certificate, Air Cleanliness Class ISO Class 3 (at v = 2 m/s) upon request



ESD classification: Electrically conductive ESD/ATEX version upon request



UL94 V2 classifications upon request

Assembly Tips



Insert screwdriver into the slot, using a lever action apply pressure to the screwdriver to release

Other Installation Methods

Vertical, hanging ≤ 262 ft (80 m)

Vertical, standing ≤ 9.84 ft (3 m)

Side-mounted, un_supp. ≤ 3.28 ft (1 m)

Rotary requires further calculation

Usage Guidelines



- If snap-open accessibility along the inner or outer radius is required
- If integrated strain relief at the mounting point is required
- If modular interior separation is needed
- If long service life is required
- If easy installation is required



- If the application is very simple
 - Series E300 E-Z Chain
- If greater stability is required
 - Series E4-42 E4-1 Series

Features & Benefits

- 1 Tried-and-tested mounting bracket
- 2 Snap-open crossbar for easy opening from the left or right
- 3 Series 3450 snap-open on both sides along inner radius
- 4 Series 3480 snap-open on both sides along inner radius
- 5 Integrated strain relief possible
- 6 Modular interior separation
- 7 Easy assembly by optimized pin
- 8 Double stop dog for long unsupported length
- 9 Crossbars with high retention force
- 10 Also available as ESD version
- 11 Strain relief separator available

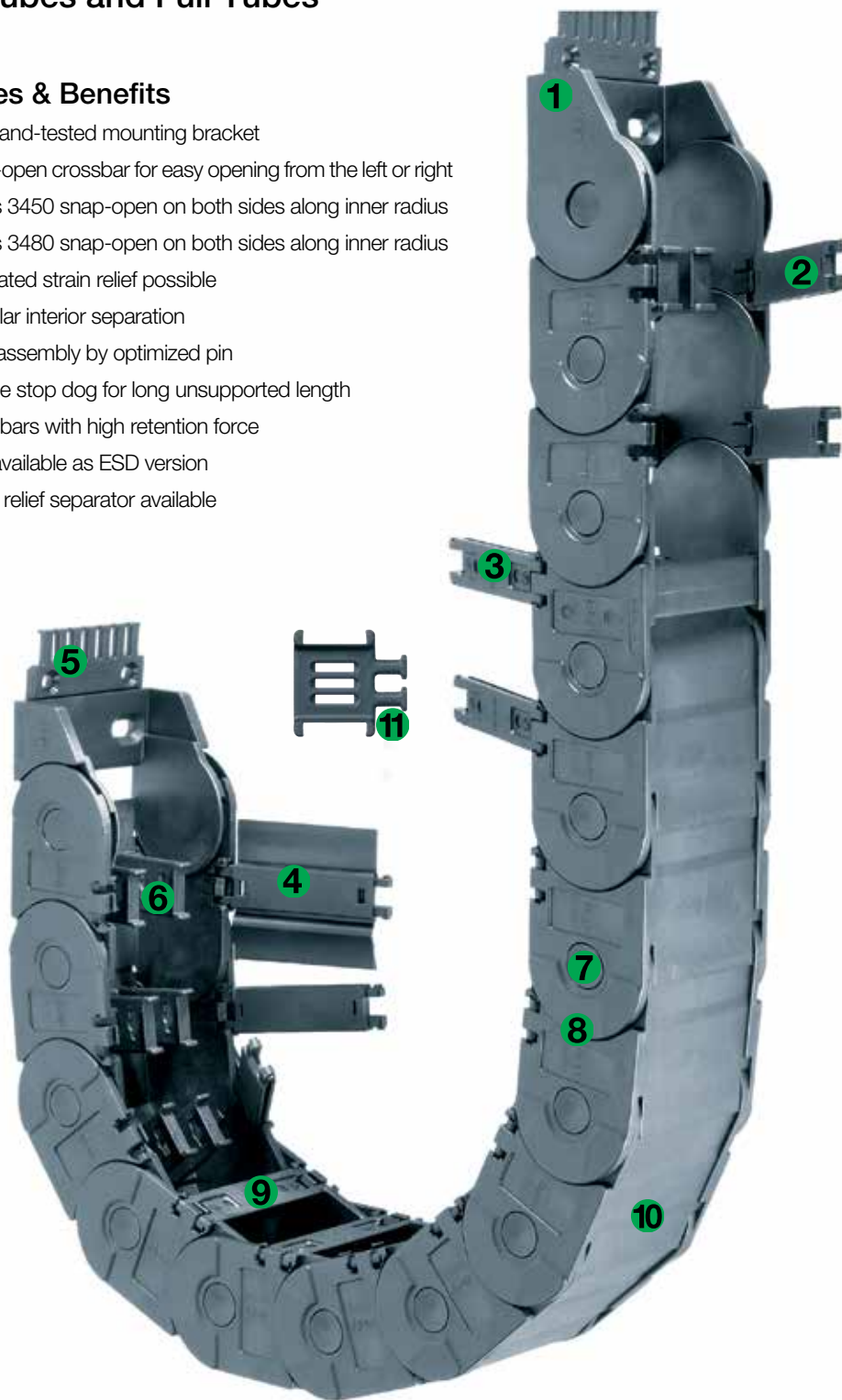

Order Example: Complete e-chain®

Please indicate chain length or number of links. Example:

9.84 ft (3 m) 3450-100-125-0



e-chain®

With 2 separators 45.1.1 assembled every 2nd link



Interior Separation

1 Set 3125-34PZB



Mounting Bracket

e-chain system® E2/000

Series 3450/3480 e-chain® Half-Tubes and Full Tubes

Installation Dimensions



3450
3480

Short travel, unsupported length

- FL_B = unsupported with permitted sag
 - FL_G = unsupported with straight upper run
- Further information ► Design, Chapter 1

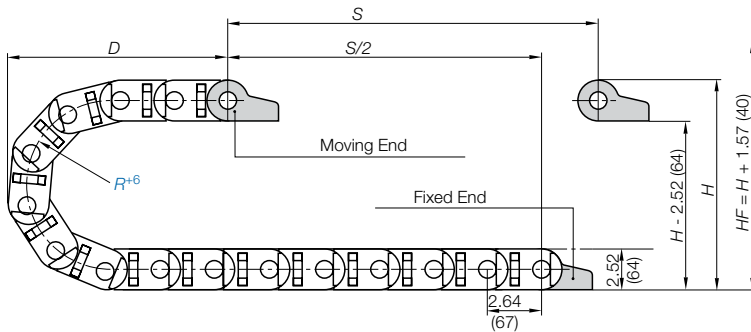
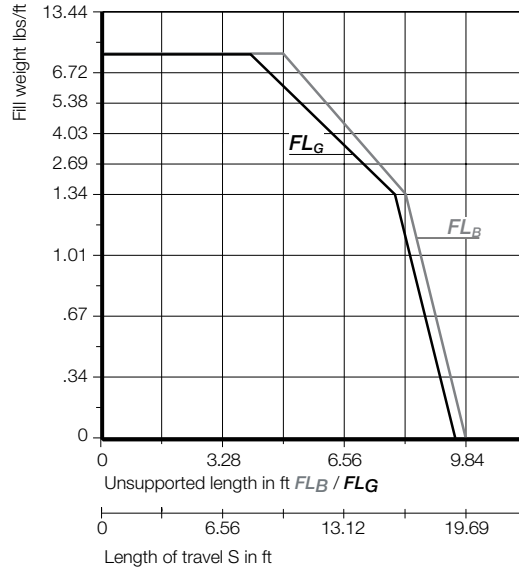
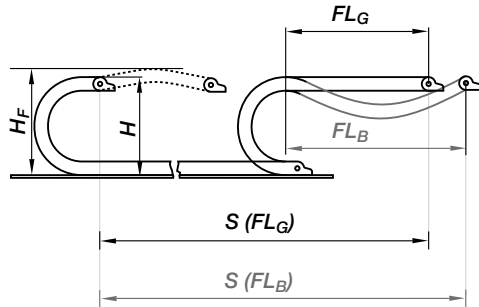

Pitch per link: = 2.64" (67 mm)
 Links per ft (m): = 4.57 (15)
 For center mount applications:
 Chain length = $S/2 + K$

The required clearance height: $HF = H + 1.57$ in. (40 mm) (with 1.68 lbs/ft (2.5 kg/m) fill weight).
 Please consult igus® if space is particularly restricted.

R	2.95 (075*)	3.94 (100*)	4.92 (125)	5.91 (150)	7.87 (200)	9.84 (250)	11.81 (300)
H	8.42 (214)	10.39 (264)	12.36 (314)	14.33 (364)	18.27 (464)	22.20 (564)	26.14 (664)
D	8.19 (208)	9.17 (233)	10.16 (258)	11.14 (283)	13.11 (333)	15.08 (383)	17.05 (433)
K	14.57 (370)	17.72 (450)	20.87 (530)	24.02 (610)	30.11 (765)	36.22 (920)	42.52 (1080)

* Radius available upon request, please consult igus® for delivery time
 Radii 075, 100: the e-tube is not completely enclosed. Please consult igus®
 Before using Series 3450/3480 on long travels please consult igus®.

Short Travels - Unsupported



Unsupported e-chains® feature positive camber over short travels. This must be accounted for when specifying the clearance height. Please refer to **Installation dimensions** for further details.

Legend

- S = Length of travel
- R = Bending radius
- H = Nominal clearance height
- D = Overlength e-chain® radius in final position
- $K = \pi \cdot R + \text{safety buffer}$
- HF = Required clearance height



PDF: igus.com/e-chain-pdfs
 Product information: igus.com/e-chains



Speed / acceleration FL_G	max. 65.6 ft/s (20 m/s) / max. 656 ft/s ² (200 m/s ²)
Speed / acceleration FL_B	max. 9.84 ft/s (3 m/s) / max. 19.69 ft/s ² (6 m/s ²)
Gliding speed / acceleration (maximum)	max. 32.8 ft/s (10 m/s) / max. 164 ft/s ² (50 m/s ²)
Material - permitted temperature	igumid G / -40°F (-40°C) up to +248°F (+120° C)
Flammability Class, igumid G	VDE 0304 IIC UL94 HB

Technical Data



Details of material properties

► Chapter 1

Series 3450 - snap-open along the inner radius, closed along the outer

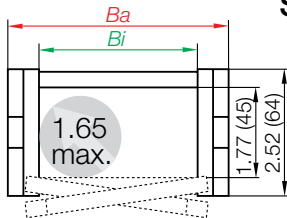

Part Number Structure



Color - Black
Bending radius
Width
Series

Series 3480 - snap-open along the inner radius, fully enclosed

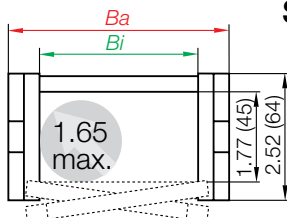

Part Number Structure

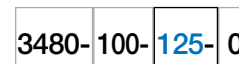

Color - Black
Bending radius
Width
Series

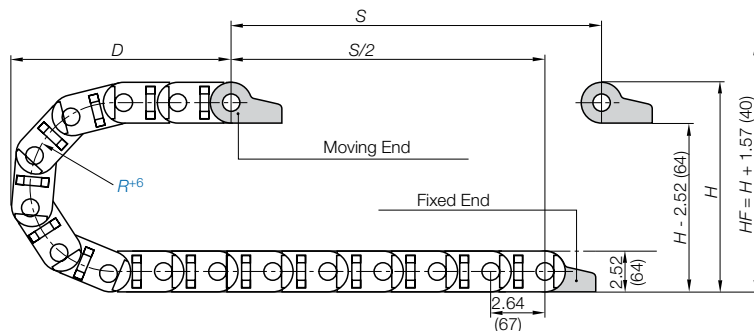

Supplement part number with required radius.
Example: 3450-100-125-0
Pitch: 264 in. (67 mm) per link links/ft(m) = 4.57 (15)

Part Number.		Weight	
Snap-open inner radius	Snap-open outer radius	3450 lbs/ft (kg/m)	3480 lbs/ft (kg/m)
3450-050-□-0	3480-050-□-0	≈ 1.19 (1.77)	≈ 1.32 (1.96)
3450-075-□-0	3480-075-□-0	≈ 1.31 (1.95)	≈ 1.39 (2.07)
3450-100-□-0	3480-100-□-0	≈ 1.44 (2.15)	≈ 1.55 (2.30)
3450-115-□-0	3480-115-□-0	≈ 1.55 (2.30)	≈ 1.65 (2.46)
3450-125-□-0	3480-125-□-0	≈ 1.63 (2.42)	≈ 1.67 (2.49)
3450-150-□-0	3480-150-□-0	≈ 1.75 (2.60)	≈ 1.76 (2.62)
3450-175-□-0	3480-175-□-0	≈ 1.84 (2.75)	≈ 1.88 (2.80)
3450-200-□-0	3480-200-□-0	≈ 1.95 (2.90)	≈ 1.98 (2.94)
3450-225-□-0	3480-225-□-0	≈ 2.12 (3.15)	≈ 2.10 (3.12)
3450-250-□-0	3480-250-□-0	≈ 2.22 (3.30)	≈ 2.20 (3.28)

Choose from the radii below for all of the above sizes
Radius (mm) Example: 3450-100-125-0

	075*	100*	125	150	200	250	300
R	2.95 (075*)	3.94 (100*)	4.92 (125)	5.91 (150)	7.87 (200)	9.84 (250)	11.81 (300)
H	8.42 (214)	10.39 (264)	12.36 (314)	14.33 (364)	18.27 (464)	22.20 (564)	26.14 (664)
D	8.19 (208)	9.17 (233)	10.16 (258)	11.14 (283)	13.11 (333)	15.08 (383)	17.05 (433)
K	14.57 (370)	17.72 (450)	20.87 (530)	24.02 (610)	30.11 (765)	36.22 (920)	42.52 (1080)

* Radius available upon request, please consult igus® for delivery time
Radii 075, 100: the e-tube is not completely enclosed. Please consult igus®

e-chain system® E2/000
 Series 3450/3480 e-chain® Half-Tubes and Full Tubes
 Interior Separation



3450
 3480

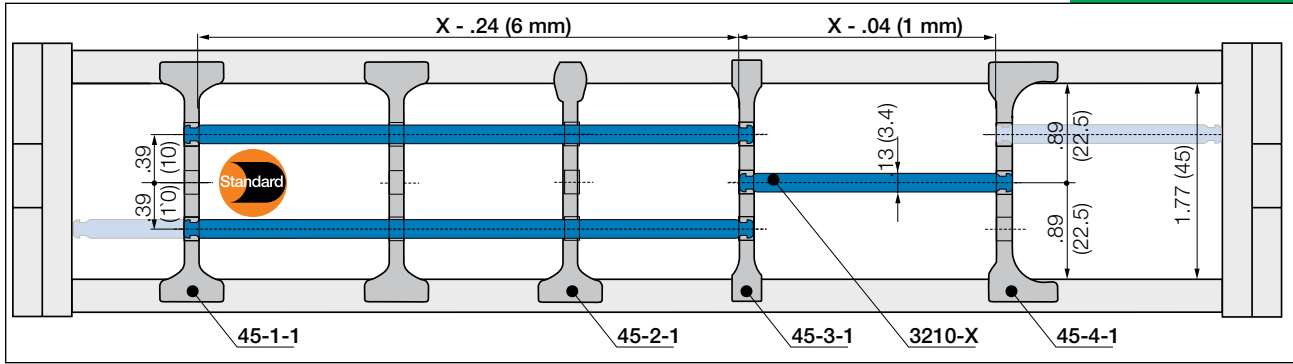

In the standard configuration separators are assembled every 2nd e-chain® link

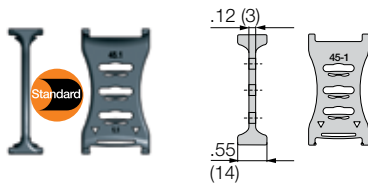

Separator, wide base

Unassembled	Part No. 45.1
Assembled	Part No. 45.1.1

- **Standard separator 45.1 for all applications**

Separator with wide base for maximum locking strength and safe standing in e-chains®.

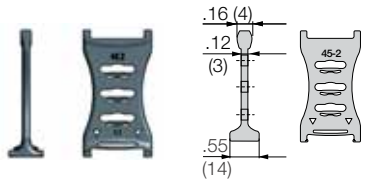

Separator, narrow head

Unassembled	Part No. 45.2
Assembled	Part No. 45.2.1

- **Separator 45.2**

For even faster installation

is used when vertical and horizontal separation is required. Due to its slot, it allows basic vertical/horizontal shelving arrangements.

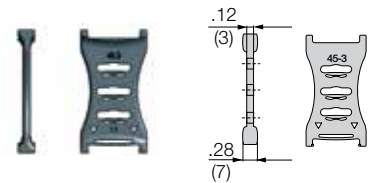

Separator, narrow base

Unassembled	Part No. 45.3
Assembled	Part No. 45.3.1

- **Separator 45.3**

For many thin cables

is used when vertical and horizontal separation is required. Due to its slot, it allows basic vertical/horizontal shelving arrangements.

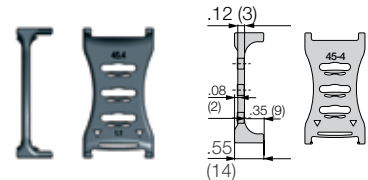

Separator, asymmetrical

Unassembled	Part No. 45.4
Assembled	Part No. 45.4.1

- **Separator 45.4**

For side mounted applications

is used when vertical and horizontal separation is required.

Lockable full-width shelves - for the standard interior separation

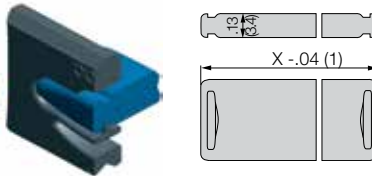

Full width shelf, lockable

Unassembled	Part No. 3200-X
Assembled	Part No. 3210-X

- **Full width shelf, lockable**

is used when vertical and horizontal separation is required.

Width X in. (mm)	Part No. Unassembled	Part No. Assembled	Width X in. (mm)	Part No. Unassembled	Part No. Assembled
1.97 (050)	3200-050	3210-050	5.91 (150)	3200-150	3210-150
2.95 (075)	3200-075	3210-075	6.89 (175)	3200-175	3210-175
3.94 (100)	3200-100	3210-100	7.87 (200)	3200-200	3210-200
4.53 (115)	3200-115	3210-115	8.86 (225)	3200-225	3210-225
4.92 (125)	3200-125	3210-125	9.84 (250)	3200-250	3210-250

PDF: igus.com/e-chain-pdfs
 Product information: igus.com/e-chains



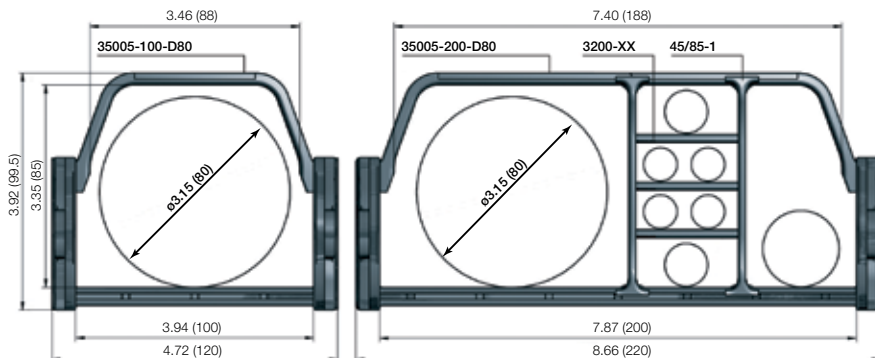

Part Number.

Extender crossbars
for e-chains®
that snap-open
along inner radius

	<i>Bi</i>	<i>Ba</i>
	in. (mm)	in. (mm)
3450-100D80-□-0	2.95 (100)	3.58 (120)
3450-200D80-□-0	4.92 (200)	5.55 (220)

Choose from the radii below for all of the above sizes

	Radius (mm)				
R	125	150	200	250	300
	4.92 (125)	5.91 (150)	6.89 (175)	7.87 (200)	9.84 (250)

*Extender crossbars are only available for Series 3450 e-chains®

Interior separation for extender crossbars

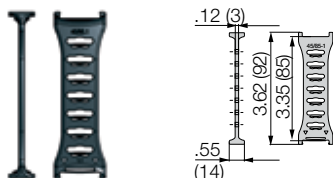

Separator, wide base

Unassembled	Part No. 45/85.1
Assembled	Part No. 45/85.1.1

- **Standard separator 45/85.1, wide base**
For maximum locking strength and safe standing. In standard configuration separators are assembled every 2nd e-chain® link.

Lockable full-width shelves - for the standard interior separation

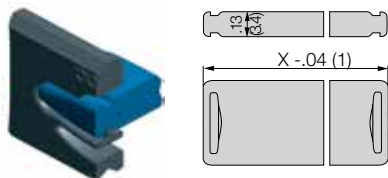

Full width shelf, lockable

Unassembled	Part No. 3200-X
Assembled	Part No. 3210-X

- **Full width shelf, lockable**
is used when vertical and horizontal separation is required.

Width X	Part No.	Part No.	Width X	Part No.	Part No.
in. (mm)	Unassembled	Assembled	in. (mm)	Unassembled	Assembled
1.97 (050)	3200-050	3210-050	5.91 (150)	3200-150	3210-150
2.95 (075)	3200-075	3210-075	6.89 (175)	3200-175	3210-175
3.94 (100)	3200-100	3210-100	7.87 (200)	3200-200	3210-200
4.53 (115)	3200-115	3210-115	8.86 (225)	3200-225	3210-225
4.92 (125)	3200-125	3210-125	9.84 (250)	3200-250	3210-250

Separator with integrated strain relief

Strain relief separator Part No. 34501-Z can be integrated into the mounting bracket and can be placed there at any point of the e-chain®. It combines strain relief and interior separation, it can be installed on the first or last e-chain® link and is easy to assemble without any screws.

For more information ► Chapter 10, Strain Relief



e-chain system® E2/000

Series 3450/3480 e-chain® Half-Tubes and Full Tubes

Mounting Bracket - Plastic



3450
3480

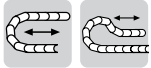

Option 1: pivoting

- For unsupported and gliding applications
- Well suited for tight installation conditions
- Detachable strain relief tiwrap plates
- Can be mounted on the fixed and/or moving end

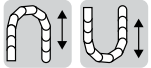

Option 2: locking

- For unsupported and gliding applications
- Extreme speed and/or accelerations
- For height restricted applications
- Can be mounted on the fixed and/or moving end



Part Number Structure

3075- 34 PZB K1

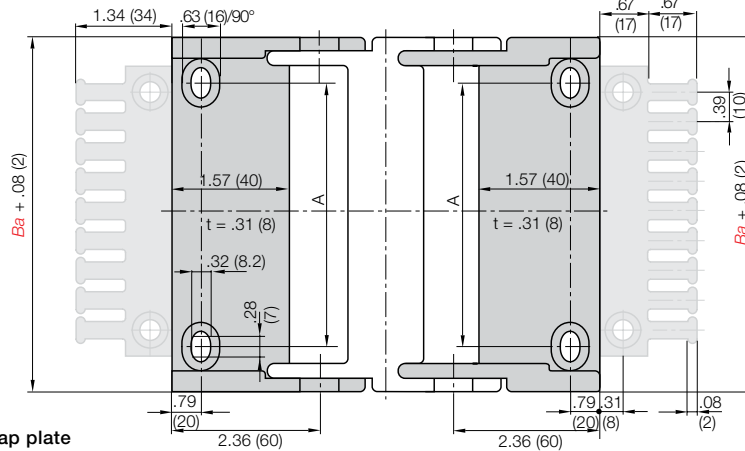
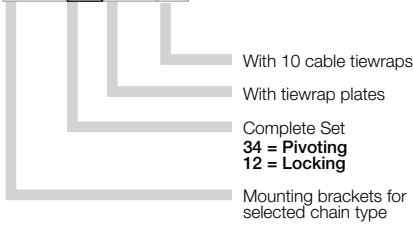

Full set, for both ends:

3075- [34] PZB Full set, each part with pin/bore + tiwrap plate

Single-part order:

3075- [3] PZB Mounting bracket with bore + tiwrap plate

3075- [4] PZB Mounting bracket with pin + tiwrap plate

Part No. Full Set (pivoting)

Without Tiwrap Plates

Series 3450:

3075-34PZ

Part No. Full Set (pivoting)

With Tiwrap Plates

Series 3450:

3075-34PZB

Part No. Full Set (pivoting)

With Tiwrap Plates + 10 cable ties

Series 3450:

3075-34PZBK1

For Chain Type	Part No. Full Set without Tiwrap Plate	Part No. Full Set with Tiwrap Plate	Part No. Full Set with Tiwrap Plate + 10 cable ties	Dimension A in. (mm)	Number of Teeth
3450/3480-050	3050- [] PZ	3050- [] PZB	3050- [] PZBK1	2.09 (28)	5
3450/3480-075	3075- [] PZ	3075- [] PZB	3075- [] PZBK1	2.09 (53)	7
3450/3480-100	3100- [] PZ	3100- [] PZB	3100- [] PZBK1	3.07 (78)	10
3450/3480-115	3115- [] PZ	3115- [] PZB	3115- [] PZBK1	3.66 (93)	11
3450/3480-125	3125- [] PZ	3125- [] PZB	3125- [] PZBK1	4.06 (103)	12
3450/3480-150	3150- [] PZ	3150- [] PZB	3150- [] PZBK1	5.04 (128)	15
3450/3480-175	3175- [] PZ	3175- [] PZB	3175- [] PZBK1	6.02 (153)	17
3450/3480-200	3200- [] PZ	3200- [] PZB	3200- [] PZBK1	7.01 (178)	20
3450/3480-225	3225- [] PZ	3225- [] PZB	3225- [] PZBK1	7.99 (203)	22
3450/3480-250	3250- [] PZ	3250- [] PZB	3250- [] PZBK1	8.98 (228)	25

34 or 12

For pivoting brackets choose 34

For locking brackets choose 12

Example: 3075-34PZB

PDF: igus.com/e-chain-pdfs
Product information: igus.com/e-chains



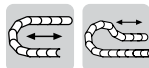

Option 1: pivoting

- For unsupported applications
- Bolted connection outside of chain cross section
- Confined installation conditions
- Attachment points on all sides
- Stackable

Moving end
34800...1

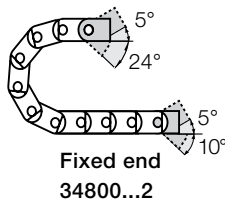

Fixed end
34800...2

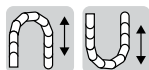

Option 2: locking

- For vertical hanging/standing applications
- Bolted connection outside of chain cross section
- For very high speeds and accelerations
- Attachment points on all sides
- Stackable

Moving end
34810...1

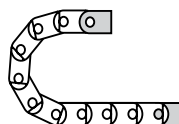

Fixed end
34810...2



Part Number Structure

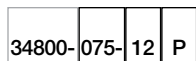

- With profile rail
- Complete Set
- Width
- Mounting brackets for selected chain type
34800 = Pivoting
34810 = Locking

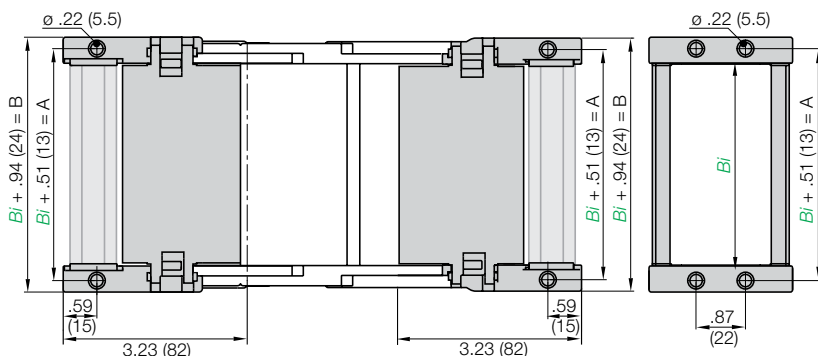

Full set, for both ends:

34800-12 P Full set, each part with pin/bore + profile rail

Single-part order:

34800-1 P Mounting bracket with bore + profile rail

34800-2 P Mounting bracket with pin + profile rail

Part No. Full Set (pivoting)

With Profile Rail

Series 3480:

34800-Width-12P

Part No. Full Set (pivoting)

Without Profile Rail

Series 3480:

34800-Width-12

For Chain Type	Part No. Full set with Profile Rail	Part No. Full Set without Profile Rail	Dimension A in. (mm)	Dimension B in. (mm)
3450/3480-050	<input type="text"/> -050-12P	<input type="text"/> -050-12	2.48 (63)	2.91 (74)
3450/3480-075	<input type="text"/> -075-12P	<input type="text"/> -075-12	3.46 (88)	3.90 (99)
3450/3480-100	<input type="text"/> -100-12P	<input type="text"/> -100-12	4.45 (113)	4.88 (124)
3450/3480-115	<input type="text"/> -115-12P	<input type="text"/> -115-12	5.04 (128)	5.47 (139)
3450/3480-125	<input type="text"/> -125-12P	<input type="text"/> -125-12	5.43 (138)	5.87 (149)
3450/3480-150	<input type="text"/> -150-12P	<input type="text"/> -150-12	6.42 (163)	6.85 (174)
3450/3480-175	<input type="text"/> -175-12P	<input type="text"/> -175-12	7.40 (188)	7.83 (199)
3450/3480-200	<input type="text"/> -200-12P	<input type="text"/> -200-12	8.38 (213)	8.82 (224)
3450/3480-225	<input type="text"/> -225-12P	<input type="text"/> -225-12	9.37 (238)	9.80 (249)
3450/3480-250	<input type="text"/> -250-12P	<input type="text"/> -250-12	10.35 (263)	10.79 (274)

34800 or 34810

For pivoting brackets choose **34800**

For locking brackets choose **34810**

Example: **34800**-075-12P

e-chain system® E2/000

Series 3450/3480 e-chain® Half-Tubes and Full Tubes

Mounting Bracket - Steel



3450
3480

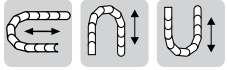

Option 1: Steel

- One part (two-piece) for all chain widths
- Electrically conductive
- Bolted connection outside of chain cross-section possible

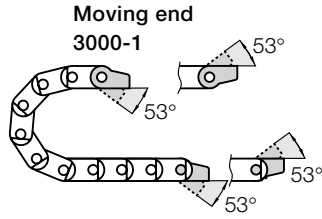

Fixed end
3000-2

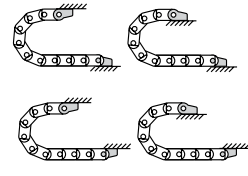

Possible installation configurations -

3000-1

3000-2*

3000-1

3000-2

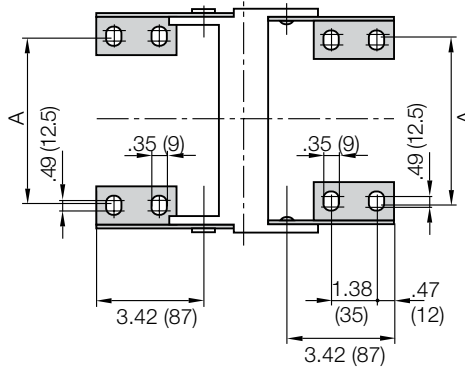
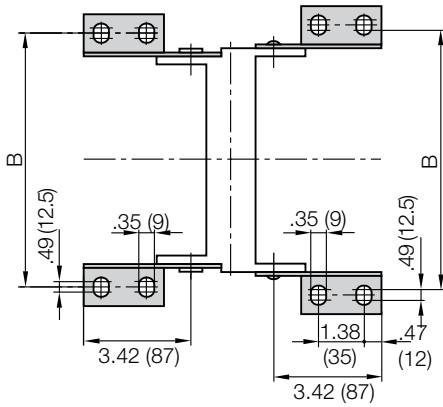

*pivoting with no stop, (360°)

Chain Type	Part No. Full Set	Dimension A in. (mm)	Dimension B in. (mm)
3450/3480-050	3000-12	1.10 (28)	3.39 (86)
3450/3480-075	3000-12	2.09 (53)	4.37 (111)
3450/3480-100	3000-12	3.07 (78)	5.35 (136)
3450/3480-115	3000-12	3.66 (93)	5.94 (151)
3450/3480-125	3000-12	4.06 (103)	6.34 (161)
3450/3480-150	3000-12	5.04 (128)	7.32 (186)
3450/3480-175	3000-12	6.02 (153)	8.35 (212)
3450/3480-200	3000-12	7.01 (178)	9.29 (236)
3450/3480-225	3000-12	7.99 (203)	10.28 (261)
3450/3480-250	3000-12	8.98 (228)	11.26 (286)

Part No. Mounting Brackets Full Set

4 parts, 2 with pin, 2 with bore
Series 3480:
3000-12

Part No. Mounting Bracket Moving End

2 parts, 1 left & 1 right
Series 3480:
3000-1

Part No. Mounting Bracket Fixed End

2 parts, 1 left & 1 right
Series 3480:
3000-2

PDF: igus.com/e-chain-pdfs
Product information: igus.com/e-chains



Chainfix clamps for the profile rail

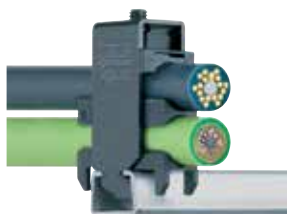

igus® Chainfix strain relief elements are available in either steel or stainless steel. They can be adjusted with a hexagon socket and are available in single, double and triple configurations.

Part No. Single Clamp		Part No. Double Clamp		Part No. Triple Clamp		Cable ø	
Steel	Stainless	Steel	Stainless	Steel	Stainless	in.	(mm)
CFX12-1	CFX12-1E	CFX12-2	CFX12-2E	CFX12-3	-	.24 - .47	(06 - 12)
CFX14-1	CFX14-1E	CFX14-2	CFX14-2E	CFX14-3	-	.47 - .55	(12 - 14)
CFX16-1	CFX16-1E	CFX16-2	CFX16-2E	CFX16-3	-	.55 - .63	(14 - 16)
CFX18-1	CFX18-1E	CFX18-2	CFX18-2E	CFX18-3	-	.63 - .71	(16 - 18)
CFX20-1	CFX20-1E	CFX20-2	CFX20-2E	CFX20-3	-	.71 - .79	(18 - 20)
CFX22-1	CFX22-1E	CFX22-2	CFX22-2E	CFX22-3	-	.79 - .87	(20 - 22)
CFX26-1	CFX26-1E	CFX26-2	CFX26-2E	-	-	.87 - 1.02	(22 - 26)
CFX30-1	CFX30-1E	CFX30-2	CFX30-2E	-	-	1.02 - 1.18	(26 - 30)
CFX34-1	CFX34-1E	CFX34-2	CFX34-2E	-	-	1.18 - 1.34	(30 - 34)
CFX38-1	CFX38-1E	-	-	-	-	1.34 - 1.50	(34 - 38)
CFX42-1	CFX42-1E	-	-	-	-	1.50 - 1.65	(38 - 42)

For more information please refer to strain relief section of Chapter 10

Tiewrap Plates

**Option 1:
Tiewrap plates as an individual part**

Available as an individual component, can be fixed onto a mounting bracket with the use of a profile rail.

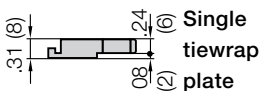
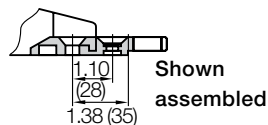

Tiewrap Plate	n Number of Teeth	C Overall Width in. (mm)	B Bore Width in. (mm)	Center Bore
3050-ZB	5	1.97 (50)	1.18 (30)	no
3075-ZB	7	2.95 (75)	2.16 (55)	no
3100-ZB	10	3.94 (100)	3.15 (80)	no
3115-ZB	11	4.53 (115)	3.74 (95)	no
3125-ZB	12	4.92 (125)	4.13 (105)	no
3150-ZB	15	5.91 (150)	5.12 (130)	no
3175-ZB	17	6.89 (175)	6.10 (155)	no
3200-ZB	20	7.87 (200)	7.09 (180)	yes
3225-ZB	22	8.86 (225)	8.07 (205)	yes
3250-ZB	25	9.84 (250)	9.06 (230)	yes

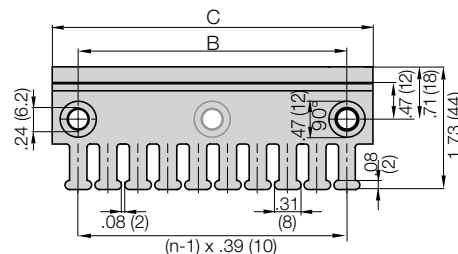

For more information please refer to strain relief section of Chapter 10

**Option 2:
Clip-on Tiewrap plates**

Available as a clip-on tiewrap plate without the use of bolts They are inserted and removed with a screwdriver used as a lever. Clip-on tiewrap plates are also available as an attachment to the opening crossbars.



Part No.	Number of Teeth	Width of Strain Relief in. (mm)
3050-ZC	5	1.97 (50)
3075-ZC	7	2.95 (75)

For more information please refer to strain relief section of Chapter 10

Strain relief for steel mounting brackets

Clip-on connection is not possible with steel mounting brackets. In this case, the tiewrap plates must be bolted directly into separate bore holes in front of the mounting bracket. Alternatively the tiewrap plates 30XX-Z and ZS can be also used here. **Details chapter 10**



PDF: igus.com/e-chain-pdfs
Product information: igus.com/e-chains



Price Index

Series 255

Special Features / Options

 IPA Qualification Certificate, Air
 Cleanliness Class ISO Class 3
 (at v = 2 m/s) upon request

 ESD classification:
 Electrically conductive ESD/
 ATEX version upon request

 UL94 V2 classifications
 upon request

Assembly Tips

 Insert screwdriver into the slot, using a
 lever action apply pressure to the screw-
 driver to release

Other Installation Methods

Vertical, hanging ≤ 131 ft (40 m)

Vertical, standing ≤ 9.84 ft (3 m)

Side-mounted, un_supp. ≤ 3.28 ft (1 m)

Rotary requires further calculation

Usage Guidelines

- If quieter operation at very high speeds is required
- If integrated strain relief at the mounting point is required
- If modular interior separation is needed
- If easy installation is required



- If each link requires snap-open accessibility on both sides
 - **Series E4-21 E4-1**
- If maximum stability is required
 - **Series E4-21 E4-1**
- If the application is very simple and easy filling is required
 - **Series E300 E-Z Chain**

Features & Benefits

- 1 Tried-and-tested mounting bracket
- 2 Snap-open crossbar for easy opening from the left or right
- 3 Series 255 snap-open on both sides along outer radius
- 4 Integrated strain relief possible
- 5 Modular interior separation
- 6 Easy assembly by optimized pin
- 7 Double stop dog for long unsupported length
- 8 Crossbars with high retention force
- 9 Also available as ESD version

Order Example: Complete e-chain®

Please indicate chain length or number of links. Example:

 3.28 ft (1 m) **255-10-200-0**

e-chain®

 With 2 separators **2552** assembled every 2nd link

Interior Separation

 1 Set **2105-34PZ1B** with tiewrap plate

Mounting Bracket

e-chain system® E2 Medium Series 255 e-chain® Installation Dimensions

Short travel, unsupported length

- FL_B = unsupported with permitted sag
 - FL_G = unsupported with straight upper run
- Further information ► Design, Chapter 1

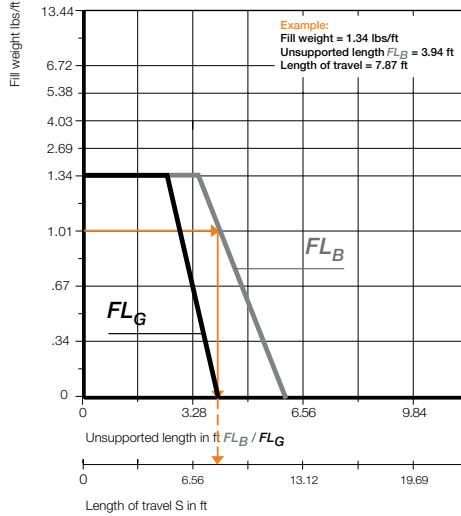
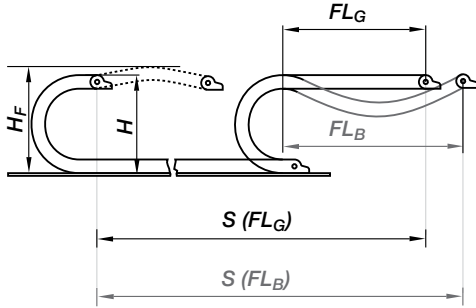

Short Travels - Unsupported

Unsupported e-chains® feature positive camber over short travels. This must be accounted for when specifying the clearance height. Please refer to **Installation dimensions** for further details.

Legend

- S = Length of travel
- R = Bending radius
- H = Nominal clearance height
- D = Overlength e-chain® radius in final position
- $K = \pi \cdot R + \text{safety buffer}$
- H_F = Required clearance height

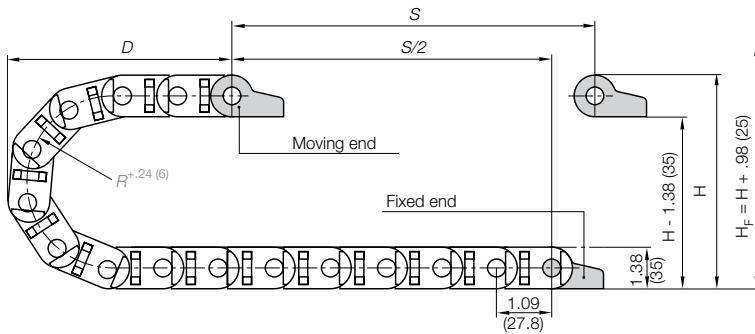

Pitch per link = 1.09° (27.8 mm)
Links per ft (m) = 11 (36)
For center mount applications:
Chain length = $S/2 + K$

The required clearance height: $H_F = H + .98$ in. (25 mm) (with 1.01 lbs/ft (1.5 kg/m) fill weight). Please consult igus® if space is particularly restricted.

R	2.17 (055)	2.95 (075)	3.94 (100)	4.92 (125)	5.91 (150)	6.89 (175)	7.87 (200)	8.86 (225)	9.84 (250)
H ⁴	5.71 (145)	7.28 (185)	9.25 (235)	11.22 (285)	13.19 (335)	15.16 (385)	17.13 (435)	19.09 (485)	21.06 (535)
D	4.48 (114)	5.28 (134)	6.26 (159)	7.24 (184)	8.23 (209)	9.21 (234)	10.20 (259)	11.18 (284)	12.17 (309)
K	9.06 (230)	11.61 (295)	14.57 (370)	17.72 (450)	20.87 (530)	24.02 (610)	26.97 (685)	30.12 (765)	33.27 (845)

For long travels with lowered mounting height

Long travel lengths from 32.8 ft. (10 m) to max. 328 ft. (100 m)

For center mount applications:
Chain length = $S/2 + K_2$

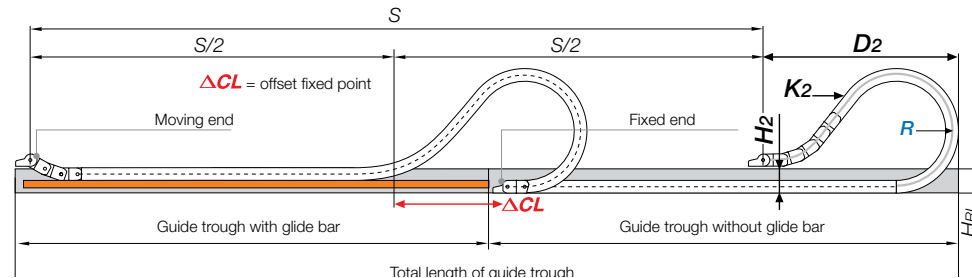

In the case of travels between 13 ft. (4m) and 32.8 ft. (10m) we recommend a longer unsupported length.

R	2.17 (055)	2.95 (075)	3.94 (100)	4.92 (125)	5.91 (150)	6.89 (175)	7.87 (200)	8.86 (225)	9.84 (250)
H ₂	4.33 (110)	5.91 (150)	3.94 (100)	3.94 (100)	3.94 (100)	3.94 (100)	3.94 (100)	3.94 (100)	3.94 (100)
D ²⁺²⁵	4.49 (114)	5.28 (134)	14.96 (380)	19.49 (495)	22.44 (570)	26.18 (665)	29.13 (740)	40.94 (1040)	44.49 (1130)
K ₂	9.06 (230)	11.61 (295)	24.09 (612)	31.73 (806)	37.20 (945)	43.78 (1112)	48.15 (1223)	63.39 (1610)	70.04 (1779)
ΔCL	—	—	8.74 (222)	12.68 (322)	14.65 (372)	17.20 (437)	19.57 (497)	—	32.36 (822)

Long Travels - Gliding

If the unsupported length is exceeded, the e-chain® must glide on itself. This requires a guide trough. **Design, Chapter 1**

Speed / acceleration FL_G	max. 65.6 ft/s (20 m/s) / max. 656 ft/s ² (200 m/s ²)
Speed / acceleration FL_B	max. 9.84 ft/s (3 m/s) / max. 19.69 ft/s ² (6 m/s ²)
Gliding speed / acceleration (maximum)	max. 32.8 ft/s (10 m/s) / max. 164 ft/s ² (50 m/s ²)
Material - permitted temperature	igumid G / -40°F (-40°C) up to +248°F (+120° C)
Flammability Class, igumid G	VDE 0304 IIC UL94 HB

Technical Data



Details of material properties

► Chapter 1



PDF: igus.com/e-chain-pdfs
Product information: igus.com/e-chains



Series 255 - snap-open along the outer radius

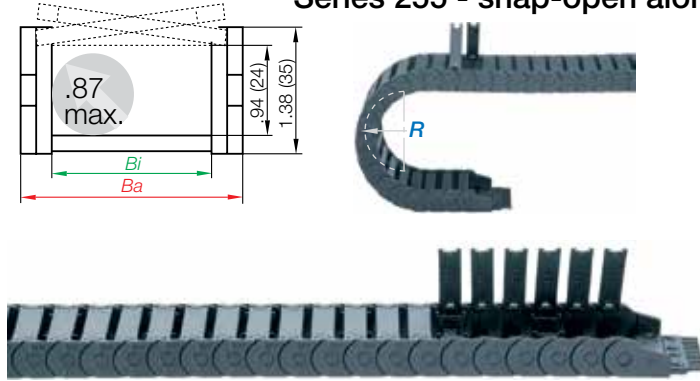

Part Number Structure

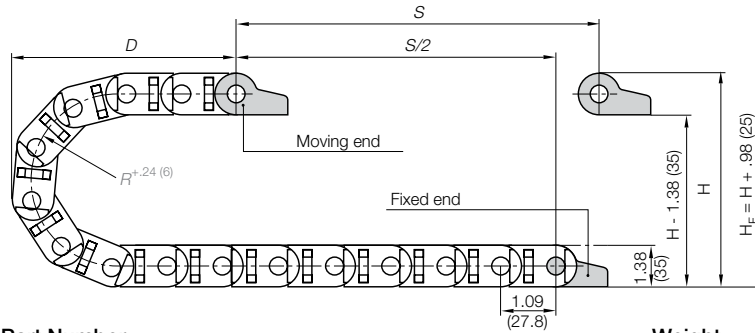
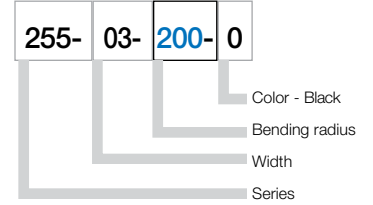

Supplement part number with required radius.

Example: 255-03-**200**-0
Pitch: 1.09 in. (27.8 mm) per link
links/ft(m) = 11 (36)

Part Number.	<i>Bi</i>	<i>Ba</i>	Weight
Snap-open inner radius	in. (mm)	in. (mm)	lbs/ft (kg/m)
255-03-□-0	1.97 (38)	2.76 (54)	≈ 0.54 (0.81)
255-05-□-0	2.95 (57)	3.74 (73)	≈ 0.60 (0.90)
255-07-□-0	3.94 (77)	4.72 (93)	≈ 0.68 (1.01)
255-10-□-0	4.53 (103)	5.31 (119)	≈ 0.77 (1.15)

Choose from the radii below for all of the above sizes
Radius (mm) Example: 255-03-**200**-0

055	075	100	125	150	175	200	225	250
2.17 (055)	2.95 (075)	3.94 (100)	4.92 (125)	5.91 (150)	6.89 (175)	7.87 (200)	8.86 (225)	9.84 (250)
5.71 (145)	7.28 (185)	9.25 (235)	11.22 (285)	13.19 (335)	15.16 (385)	17.13 (435)	19.09 (485)	21.06 (535)
4.48 (114)	5.28 (134)	6.26 (159)	7.24 (184)	8.23 (209)	9.21 (234)	10.20 (259)	11.18 (284)	12.17 (309)
9.06 (230)	11.61 (295)	14.57 (370)	17.72 (450)	20.87 (530)	24.02 (610)	26.97 (685)	30.12 (765)	33.27 (845)

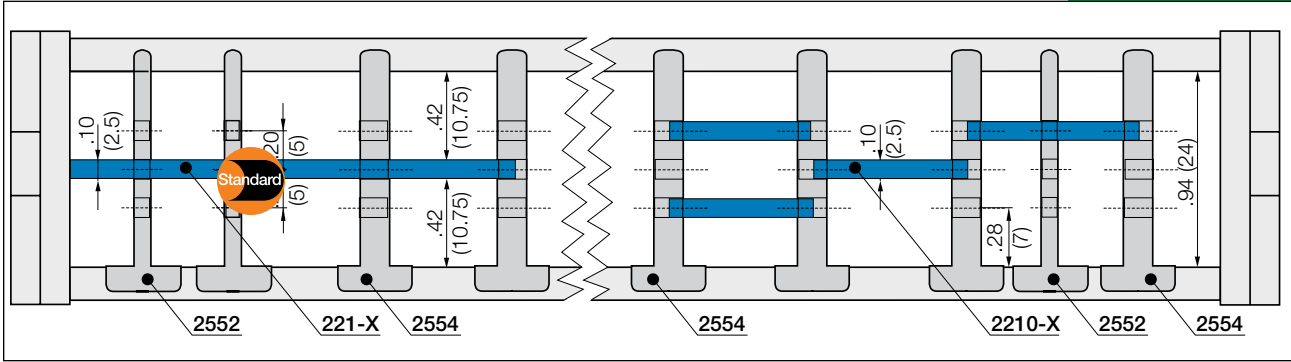

In the standard configuration separators are assembled every 2nd e-chain® link

Separators

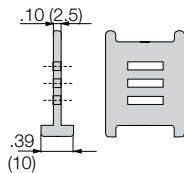

Slotted Separator for e-chains®
 Unassembled Part No. 2551
 Assembled Part No. 2552

- **Standard slotted separator 2551**
 Separator with wide base for maximum locking strength and safe standing in e-chains®.

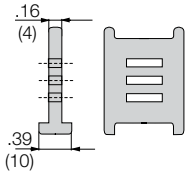

Slotted separator for e-chains®
 Unassembled Part No. 2553
 Assembled Part No. 2554

- **Slotted Separator 2553**
 is used when vertical and horizontal separation is required. Due to its slot, it allows basic vertical/horizontal shelving arrangements.

Full-width shelves

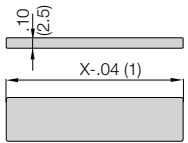

Full-width shelf for e-chains®
 Unassembled Part No. 220-X
 Assembled Part No. 221-X

- **Full-width shelf 220-X**
 is used when vertical and horizontal separation is required. Due to its slot, it allows basic vertical/horizontal shelving arrangements.

Width X	Part No.	Part No.	Width X	Part No.	Part No.
in. (mm)	Unassembled	Assembled	in. (mm)	Unassembled	Assembled
1.50 (038)	2200-38	2210-38	3.03 (077)	2200-73	2210-73
2.24 (057)	2200-58	2210-58	4.06 (103)	2200-88	2210-88

Shelves

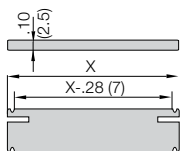

Shelf for e-chains®
 Unassembled Part No. 2200-X
 Assembled Part No. 2210-X

- **Shelf 2200-X**
 is used when vertical and horizontal separation is required.

Width X	Part No.	Part No.	Width X	Part No.	Part No.	Width X	Part No.	Part No.
in. (mm)	Unassembled	Assembled	in. (mm)	Unassembled	Assembled	in. (mm)	Unassembled	Assembled
0.71 (018)	2200-18	2210-18	1.69 (043)	2200-43	2210-43	3.46 (088)	2200-88	2210-88
0.91 (023)	2200-23	2210-23	1.89 (048)	2200-48	2210-48	3.90 (099)	2200-99	2210-99
1.10 (028)	2200-28	2210-28	2.28 (058)	2200-58	2210-58			
1.30 (033)	2200-33	2210-33	2.68 (068)	2200-68	2210-68			
1.50 (038)	2200-38	2210-38	2.87 (073)	2200-73	2210-73			



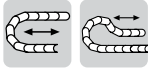

Option 1: pivoting

- For unsupported and gliding applications
- Well suited for tight installation conditions
- Detachable strain relief tiwrap plates
- Can be mounted on the fixed and/or moving end

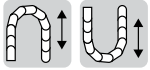
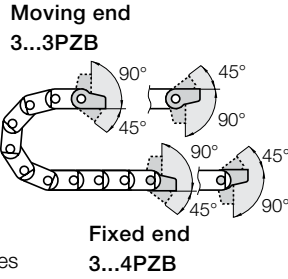

Option 2: locking

- For vertical hanging and standing applications
- Extreme speed and/or accelerations
- For height restricted applications
- Can be mounted on the fixed and/or moving end

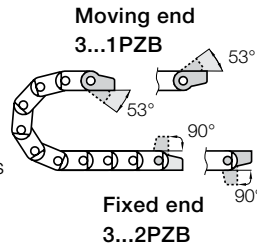

Part Number Structure

2035- 34 PZB K1

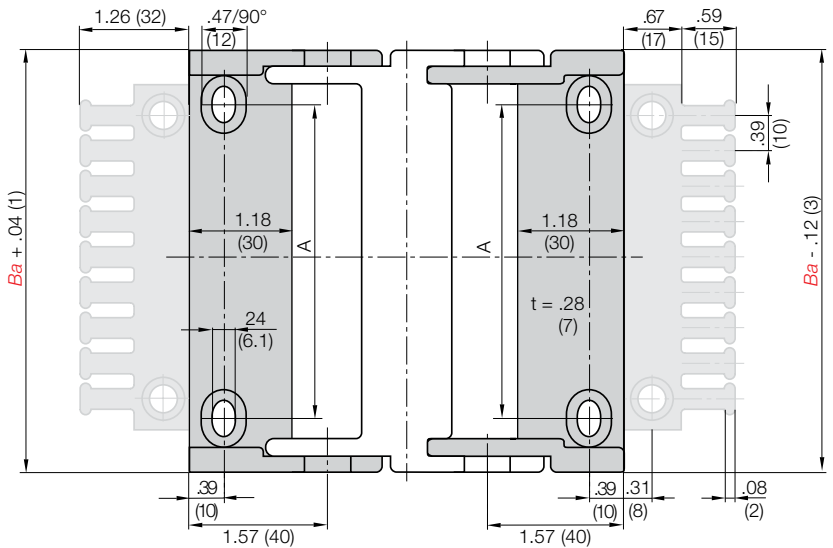
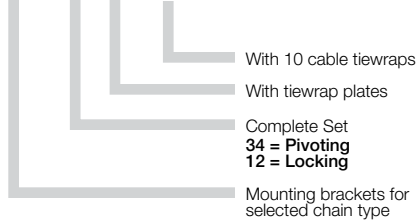

Full set, for both ends:

2035- 34 PZB Full set, each part with pin/bore + tiwrap plate

Single-part order:

2035- 3 PZB Mounting bracket with bore + tiwrap plate

2035- 4 PZB Mounting bracket with pin + tiwrap plate

Part No. Full Set (pivoting)

Without Tiwrap Plates

Series 255:
2035-34PZ1

Part No. Full Set (pivoting)

With Tiwrap Plates

Series 255:
2035-34PZ1B

Part No. Full Set (pivoting)

With Tiwrap Plates + 10 cable ties

Series 255:
2035-34PZ1BK1

For Chain Type	Part No. Full Set without Tiwrap Plate	Part No. Full Set with Tiwrap Plate	Part No. Full Set with Tiwrap Plate + 10 cable ties	Dimension A in. (mm)	Number of Teeth
255-03	2035- <input type="checkbox"/> PZ1	2035- <input type="checkbox"/> PZ1B	2035- <input type="checkbox"/> PZ1BK1	.98 (25)	4
255-05	2055- <input type="checkbox"/> PZ1	2055- <input type="checkbox"/> PZ1B	2055- <input type="checkbox"/> PZ1BK1	1.73 (44)	6
255-07	2075- <input type="checkbox"/> PZ1	2075- <input type="checkbox"/> PZ1B	2075- <input type="checkbox"/> PZ1BK1	2.52 (64)	8
255-10	2105- <input type="checkbox"/> PZ1	2105- <input type="checkbox"/> PZ1B	2105- <input type="checkbox"/> PZ1BK1	3.54 (90)	10

34 or 12

For pivoting brackets choose 34
For locking brackets choose 12
Example: 2035- 34 PZ1B

Tiewrap Plates



Option 1:
 Tiewrap plates as an individual part

Available as an individual component or can be fixed onto a mounting bracket with the use of a profile rail.

Series 2000

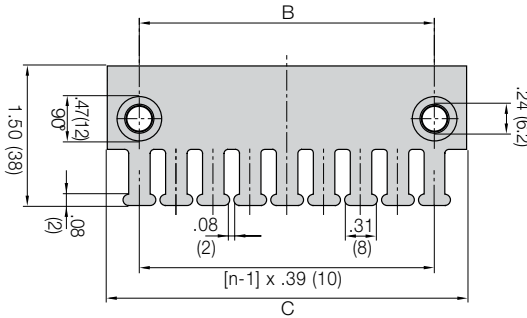
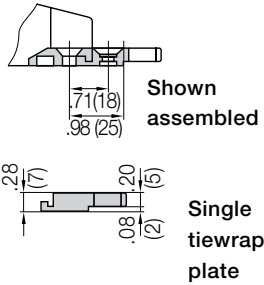

Tiewrap Plates	n Number of Teeth	Dimension C	Dimension B
2020-ZB	3	1.18 (30)	.59 (15)
2030-ZB	4	1.57 (40)	.79 (20)
2040-ZB	5	1.97 (50)	1.18 (30)
2050-ZB	6	2.36 (60)	1.57 (40)
2070-ZB	8	3.15 (80)	2.36 (60)
2090-ZB	9	3.54 (90)	2.76 (70)
2100-ZB	10	3.94 (100)	3.15 (80)
2125-ZB	12	4.72 (120)	3.94 (100)

If used with KMA brackets with profile rail please add "KMA" to the end of the part number.

Example: 2020-ZBKMA

= 2030-ZB + 2040-ZB combined

= 2050-ZB x 2 pieces combined

PDF: igus.com/e-chain-pdfs
 Product information: igus.com/e-chains



Guide troughs are used with applications where the upper run of the e-chain® glides on the lower run. If using igus® steel guide troughs, the following components are required:

- Full travel length of guide trough
Part Number 92-30
- 1/2 travel length of glide bars
Part Number 92-01
- Installation sets as end connectors
Part Number 92-50-XX

-XX indicates the length of the profile rail on which the guide trough is mounted. The values and part numbers are specified in the table on the left. The standard length of the trough components and glide bars is 6.56 ft (2 m.) The required overall length of the guide trough directly correlates to the length of travel.

Example:
Length of travel 164 ft (50 m)
Center mounted

Required guide troughs:
164 ft (50 m) guide trough
82 ft (25 m) glide bar
= 25 sections of 6.56 ft (2 m) guide trough
Part No. 92-30
= 13 sections of 6.56 ft (2 m) glide bar
Part No. 92-01



Required number of installation sets:
= Number of guide trough components + 1
= 25 + 1 = 26
Part number of the installation sets

Example: 92-50-400 for 15.75" (400 mm) long profile rail.

Width of Crossbar
255-03-200-0

	B_{Ri}	Installation Part No.
-03	2.32 (59)	92-50-175
-05	3.07 (78)	92-50-200
-07	3.86 (98)	92-50-225
-10	4.88 (124)	92-50-250

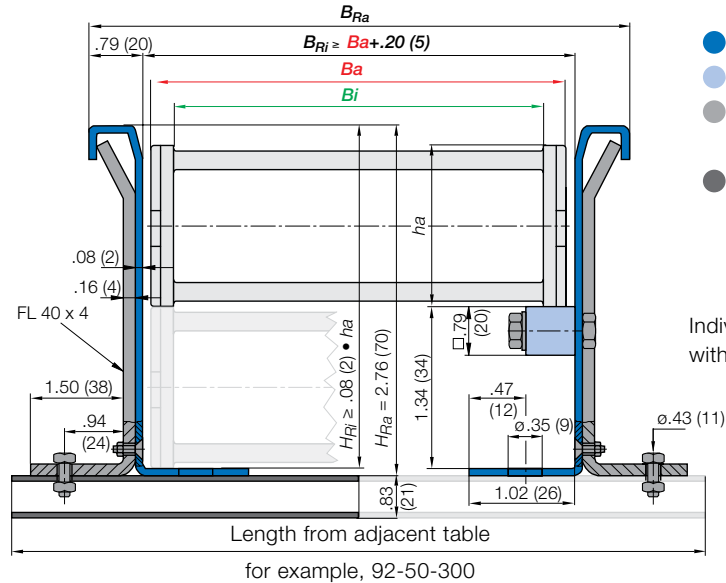

- Guide trough
- Glide bars
- Installation set "Basic"
- Profile rail

Individual attachment without profile rail

Standard length profile rail

* Specialized guide trough available upon request



PDF: igus.com/e-chain-pdfs
Product information: igus.com/e-chains

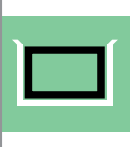



igus[®] E2 tubes



E2 tubes - protection against hot chips and debris

E2 e-tube

Series R100, R and R1000

Laboratory tests and numerous field applications over the past 20 years prove that igus® e-chains® and fully enclosed e-tubes protect cables used in welding robots and machine tools. For extreme-temperature applications, igus® offers e-tubes made from its igumid HT material, which repels hot chips and flying debris reaching 1,562°F (850°C). All standard E2 and E4 e-tubes are available made from igumid HT, upon request.

Typical industries and applications

- Tooling machines
- Woodworking machines
- All kind of industries and machines with chip, dirt and dust



iF-Design Awards -
Series R117/118 and Series R68



ESD Classification: Electrically conductive
ESD/ATEX version upon request



Flammability Class
VDE 0304 IIC UL94 HB



Series R - For higher speeds and smooth running

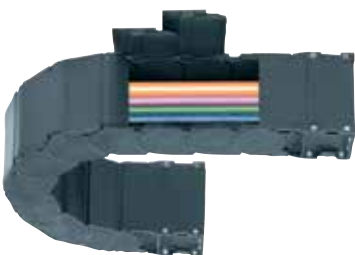

Series R100 - Cost effective alternative, for applications with low and medium speeds





E2 e-tubes in chip-area of a tooling machine. Resistant against hot metal chips up to 1,562°F (850°C)



U-shaped supported e-tube
for high lateral acceleration



Standing application - R68 Tube -
Note: the first links are supported

RX system e-tube with chip repellent design

Repels chips, is extremely tight,
and can still be opened!

Series RX ► Page 5.69



e-chain system® E2 tubes

Selection Guide

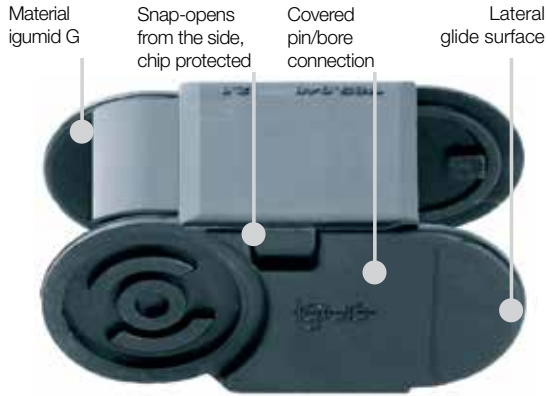

E2 Series R100 - robust and tight

- Very good protection against chips (also hot chips)
- Hinged, snap-open, removable lids along inner or outer radius reduce assembly time
- Space-efficient with optimized ratio of inner dimension to outer dimension
- Double stop dog for long service life and strong unsupported lengths
- Universal KMA mounting brackets with attachment capability on all sides
- You can find more technical data about the material, chemical resistance, temperatures ➤ **Design, Chapter 1**

Series	Inner height <i>hi</i>		Inner width <i>Bi</i>		Outer width <i>Ba</i>		Outer height <i>ha</i>		Bending radius <i>R</i>	
	in.	(mm)	in.	(mm)	in.	(mm)	in.	(mm)	in.	(mm)
R117/118	.83	(21)	.79-3.94	(20-100)	1.26-4.41	(32-112)	1.10	(28)	2.48-7.09	(63 - 180)
R157/158	1.57	(40)	1.57-7.87	(40-200)	2.20-8.50	(56-216)	1.97	(50)	3.94-9.84	(100 - 250)
R167/168	1.97	(50)	1.97-9.84	(50-250)	2.68-10.55	(68-268)	2.52	(64)	3.94-11.81	(100 - 300)

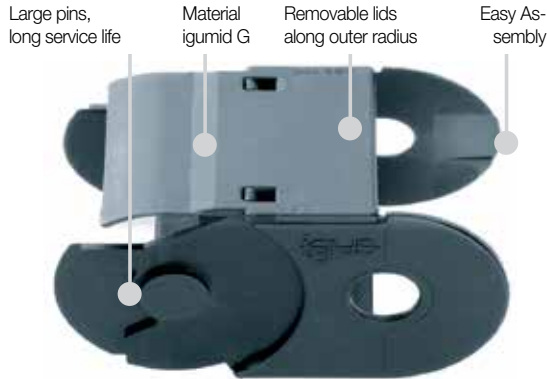

E2 Series R - small pitch for smooth motion

- Protection for cables and hoses against chips (also hot chips)
- Small pitch for low noise, smooth operation
- Smooth, chip repellent exterior
- Lids removable for assembly time reduction
- Double stop dog for strong unsupported lengths
- KMA mounting brackets with attachment capability on all sides
- Very small radii possible due to small pitch
- You can find more technical data about the material, chemical resistance, temperatures ➤ **Design, Chapter 1**

Series	Inner height <i>hi</i>		Inner width <i>Bi</i>		Outer width <i>Ba</i>		Outer height <i>ha</i>		Bending radius <i>R</i>	
	in.	(mm)	in.	(mm)	in.	(mm)	in.	(mm)	in.	(mm)
R48	.98	(25)	.98-5.12	(25-130)	1.42-5.55	(36-141)	1.42	(36)	2.36-9.84	(60 - 250)
R58	1.38	(35)	1.97-7.87	(50-200)	2.60-8.50	(66-216)	1.97	(50)	2.95-9.84	(75 - 250)
R68	1.77	(45)	1.97-9.84	(50-250)	2.68-10.55	(68-268)	2.52	(64)	3.94-11.81	(100 - 300)



Series R2 - Cost-effective chip protection

- Protection for cables and hoses against chips (also hot chips)
- Covered in/bore connection
- Smooth, chip repellent exterior
- Lids openable along the outer radius from left or right sides
- Double stop dog for strong unsupported lengths
- KMA mounting brackets with attachment capability on all sides
- Light with large inner height
- You can find more technical data about the material, chemical resistance, temperatures ➤ **Design, Chapter 1**

Series	Inner height <i>hi</i>		Inner width <i>Bi</i>		Outer width <i>Ba</i>		Outer height <i>ha</i>		Bending radius <i>R</i>	
	in.	(mm)	in.	(mm)	in.	(mm)	in.	(mm)	in.	(mm)
R2.75	2.95	(75)	4.37-7.87	(111-200)	5.31-8.82	(135-224)	3.54	(90)	5.12-9.84	(130-250)



Available from stock. Orders ship as early as today.*

*On average 90% of orders ship the same day..

e-chain system® E2 tubes

Assembly Instructions

e-chains® - Assembling E2 Series R100 e-tubes

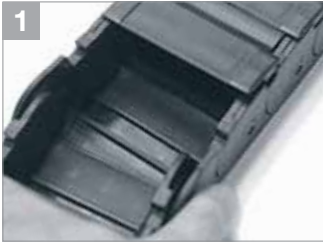

1 Push, click - and snap in pin



2 Swivel lids - push and snap

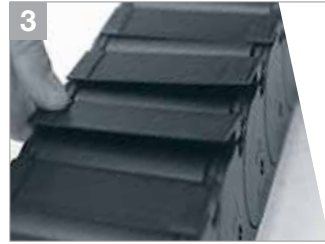

3 Slide last lid



4 Push and snap

e-chains® - Separating E2 Series R100 e-tubes

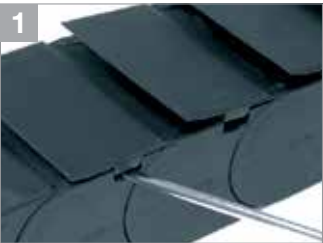

1 Lever open lid



2 Bend e-tube to remove lid



1 Release side-link



2 Twist and pull apart

e-chains® - Assembling E2 Series R48, R58, R68 e-tubes



1 Push and click

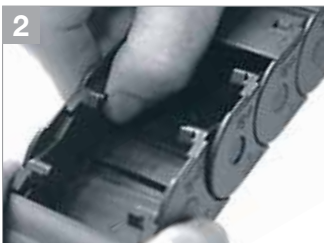

2 Snap in pin



3 Slide lid



4 Push and snap

e-chains® - Separating E2 Series R48, R58, R68 e-tubes



1 Lever open lid



2 Remove lid



3 Release side-link



4 Twist and pull apart

e-chains® - Separating E2 Series R2.75 e-tubes



1 Lever open lid



2 Remove lid



3 Release side-link



4 Twist and pull apart

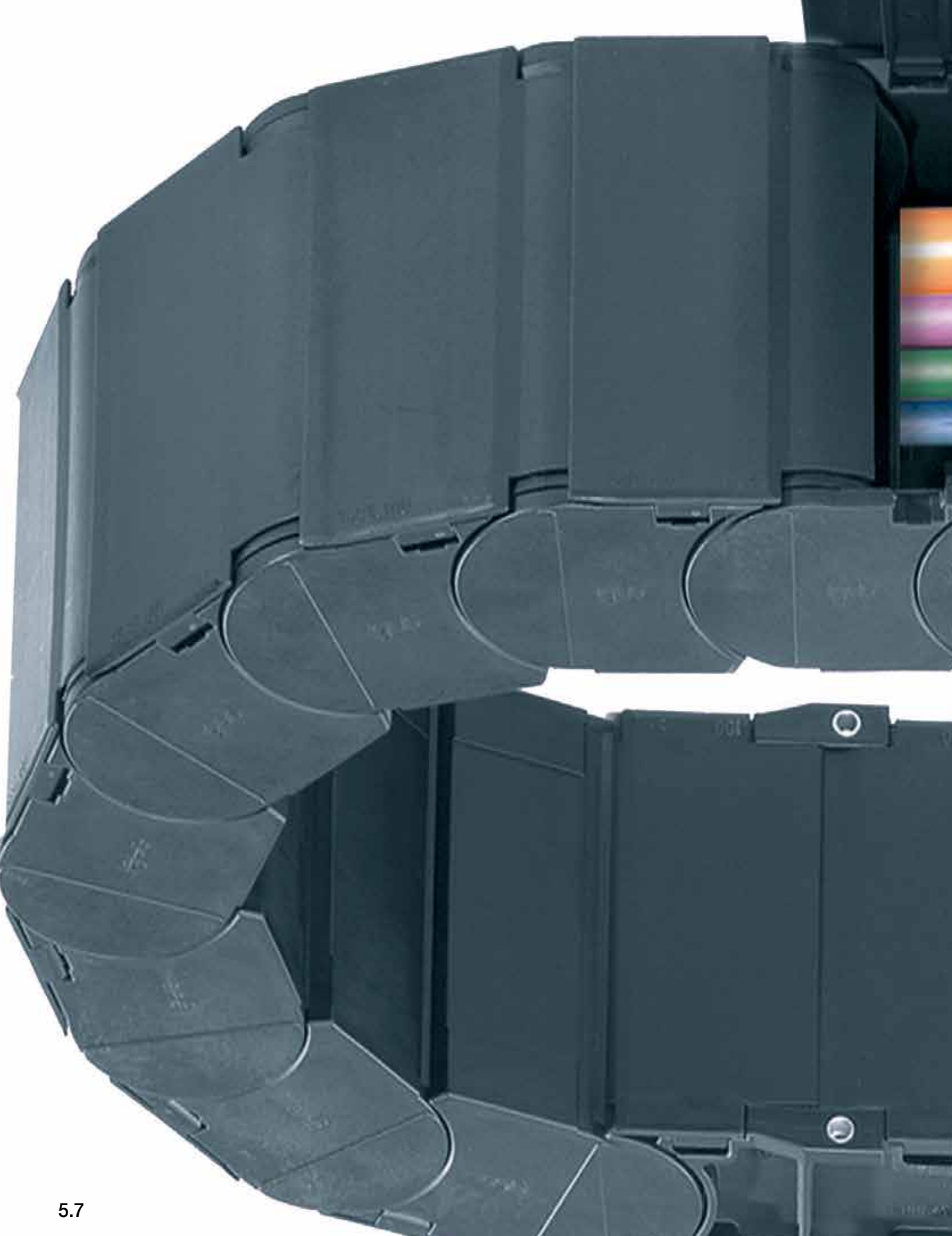



E2 R100

**e-tubes for cost-effective
protection against dirt and chips**



Price Index



Series R117/R118

Special Features / Options



ESD classification:
Electrically conductive ESD/
ATEX version upon request



Flammability Class
VDE 0304 IIC UL94 HB



iF-Design Award Winner

Assembly Tips

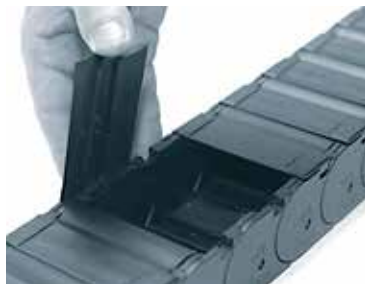

Lids of the e-tube Series R100 are hinged for easy access

Other Installation Methods

Vertical, hanging ≤ 65.6 ft (20 m)

Vertical, standing ≤ 6.56 ft (2 m)

Side-mounted, un supp. ≤ 2.29 ft (0.7 m)

Rotary requires further calculation

Usage Guidelines



- If snap-open accessibility along inner or outer radius is required
- If price is an issue
- If flush attachment is required



- For smoother running and smaller pitch
➤ Series R48 E2 tubes
- If accessibility along the sides of the radius is required
➤ Series R4-28 E4-1

Features & Benefits

- 1 Effective chip protection, even against hot metal
- 2 chips
- 3 Double stop dog for strong unsupported length
- 4 Smooth, chip-repellent exterior
- 5 Lateral glide surfaces for side-mounted operation
Universal KMA mounting brackets with attachment
- 6 capability on all sides
Snap-open from the side, covered pin/bore
- 7 connection
Space-efficient with optimized ratio of inner to outer
- 8 dimension
Snap-open lids along the inner or outer radius

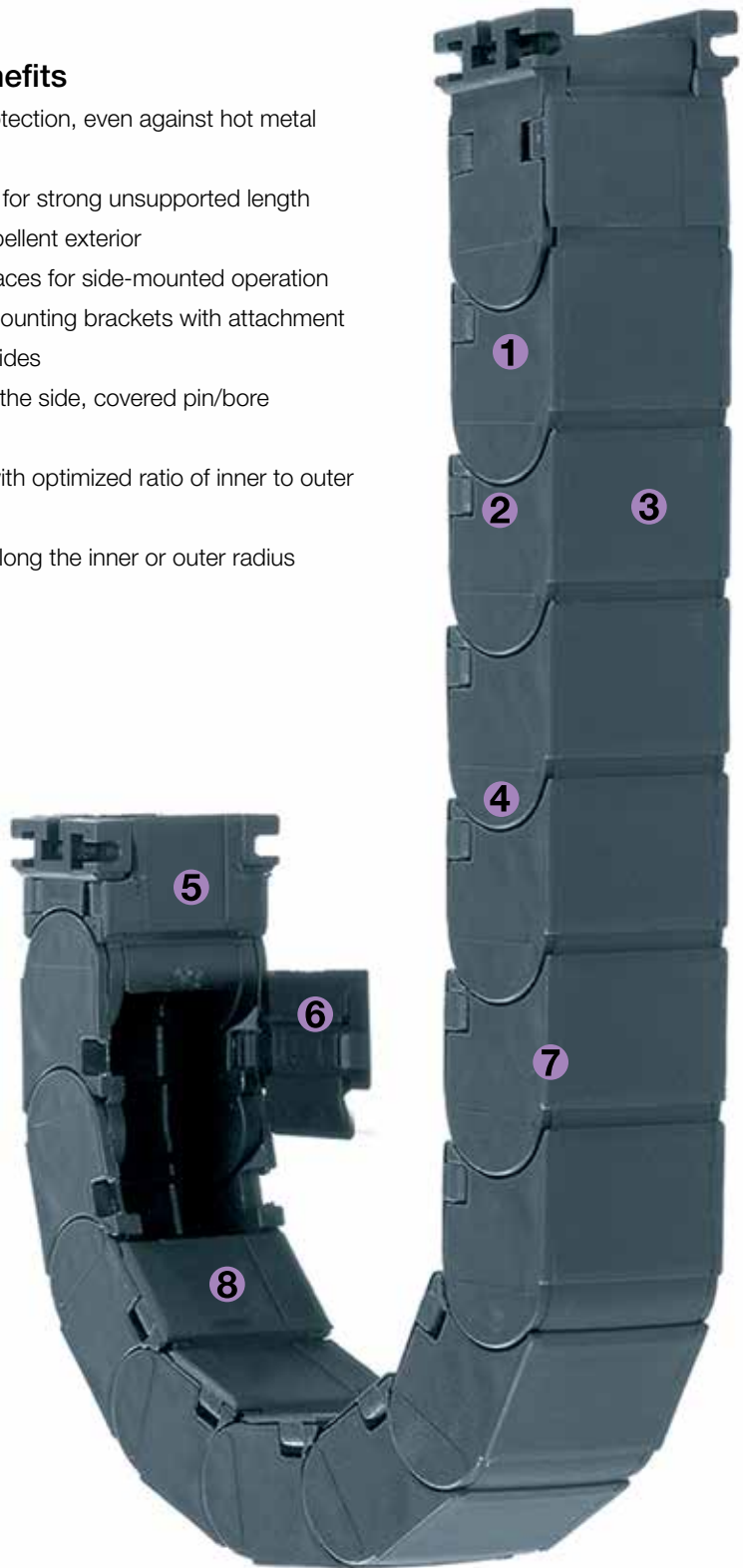

Order Example: Complete e-chain®

Please indicate chain length or number of links. Example:

3.28 ft (1 m) 117-100-100-0



e-chain®

With 2 separators 1186-01 assembled every 2nd link



Interior Separation

1 Set 11800-100-14



Mounting Bracket

e-chain system® E2 tubes

Series R117/R118

Installation Dimensions



R117
R118

Short travel, unsupported length

- FL_B = unsupported with permitted sag
 - FL_G = unsupported with straight upper run
- Further information ► Design, Chapter 1

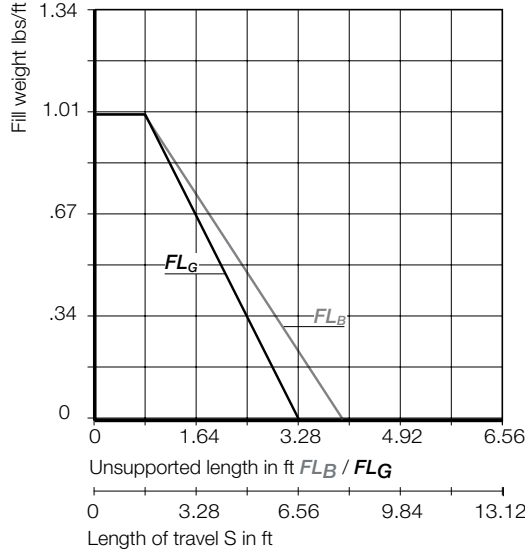
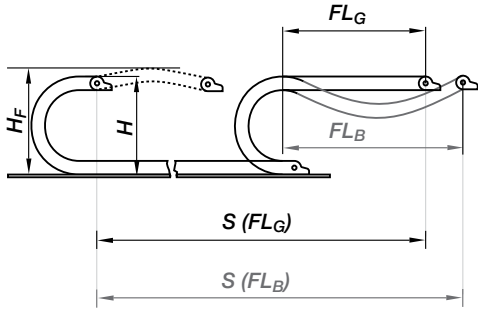

Short Travels - Unsupported



Unsupported e-chains® feature positive camber over short travels. This must be accounted for when specifying the clearance height. Please refer to **Installation dimensions** for further details.

Legend

- S = Length of travel
- R = Bending radius
- H = Nominal clearance height
- D = Overlength e-chain® radius in final position
- $K = \pi \cdot R + \text{safety buffer}$
- H_F = Required clearance height

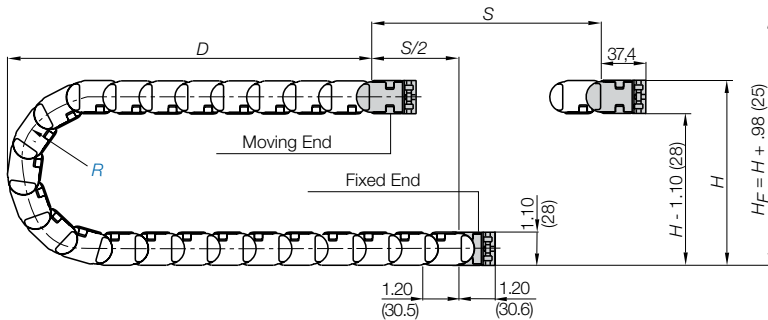

Pitch per link: = 1.20" (30.5 mm)
 Links per ft (m): = 10.06 (33)
 For center mount applications:
 Chain length = $\frac{S}{2} + K$

The required clearance height: $H_F = H + .98 \text{ in. (25 mm)}$ (with .67 lbs/ft (1.0 kg/m) fill weight). Please consult igus® if space is particularly restricted.

R	2.48 (063)	2.95 (075)	3.94 (100)	4.33 (110)	4.92 (125)	5.71 (145)	7.09 (180)
H	6.06 (154)	7.01 (178)	8.98 (228)	9.76 (248)	10.94 (278)	12.52 (318)	15.28 (388)
D	4.84 (123)	5.31 (135)	6.30 (160)	6.69 (170)	7.28 (185)	8.07 (205)	9.45 (240)
K	10.24 (260)	11.81 (300)	14.96 (380)	16.14 (410)	17.91 (455)	20.47 (520)	24.80 (630)

Speed / acceleration FL_G	max. 32.8 ft/s (10 m/s) / max. 328 ft/s ² (100 m/s ²)
Speed / acceleration FL_B	max. 9.84 ft/s (3 m/s) / max. 19.69 ft/s ² (6 m/s ²)
Gliding speed / acceleration (maximum)	max. 1.64 ft/s (0.5 m/s) / max. 16.4 ft/s ² (5 m/s ²)
Material - permitted temperature	igumid G / -40°F (-40°C) up to +248°F (+120° C)
Flammability Class, igumid G	VDE 0304 IIC UL94 HB

Technical Data



Details of material properties

► Chapter 1



PDF: igus.com/e-chain-pdfs
 Product information: igus.com/e-chains



Series R117 - hinged, snap-open on both sides of the inner radius

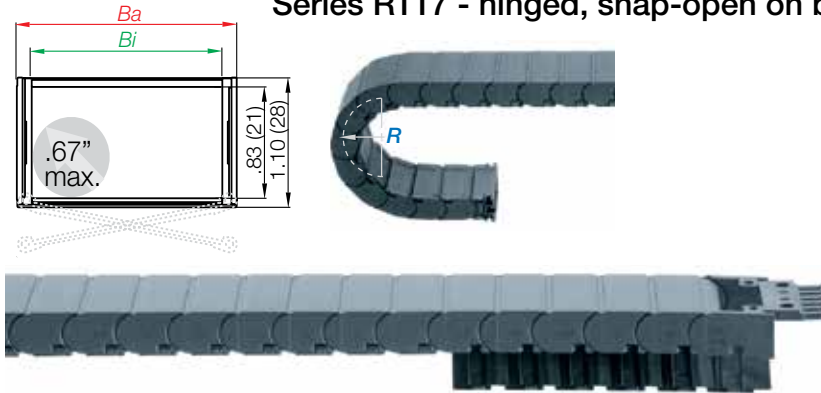

Part Number Structure

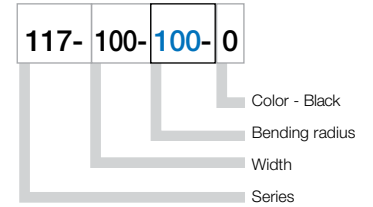

Series R118 - hinged, snap-open on both sides of the outer radius

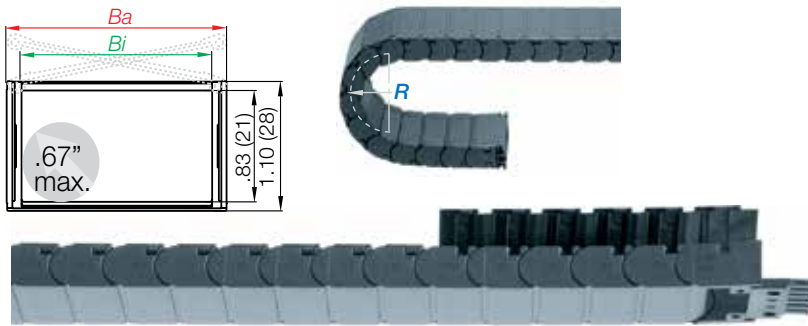

Part Number Structure

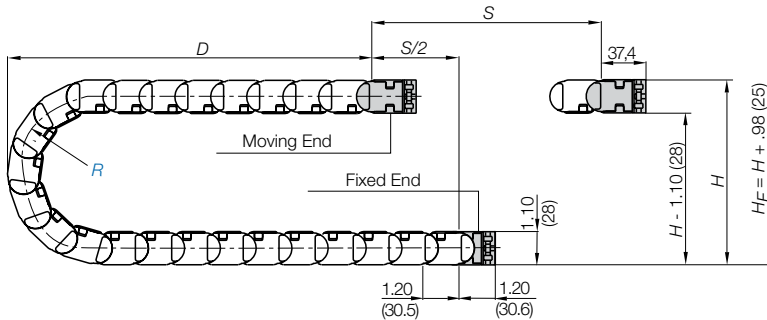
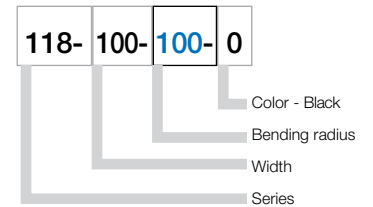

Supplement part number with required radius. Example: 117-100-100-0
Pitch: 1.20 in. (30.5 mm) per link links/ft (m) = 10.06 (33)

Part Number.

Snap-open inner radius	Snap-open outer radius		Bi in. (mm)	Ba in. (mm)	Weight lbs/ft (kg/m)
117-020-		<input type="text"/> -0	.79 (20)	1.26 (32)	≈ 0.29 (0.43)
117-025-	118-025-	<input type="text"/> -0	.98 (25)	1.46 (37)	≈ 0.31 (0.46)
117-038-		<input type="text"/> -0	1.50 (38)	1.97 (50)	≈ 0.38 (0.56)
117-048-	118-048-	<input type="text"/> -0	1.89 (48)	2.40 (60)	≈ 0.44 (0.66)
117-063-		<input type="text"/> -0	2.48 (63)	2.95 (75)	≈ 0.51 (0.76)
117-080-	118-080-	<input type="text"/> -0	3.15 (80)	3.62 (92)	≈ 0.60 (0.89)
117-100-		<input type="text"/> -0	3.94 (100)	4.41 (112)	≈ 0.71 (1.06)

Choose from the radii below for all of the above sizes

Radius (mm) Example: 117-100-100-0

	063	075	100	110	125	145	180
R	2.48 (063)	2.95 (075)	3.94 (100)	4.33 (110)	4.92 (125)	5.71 (145)	7.09 (180)
H	6.06 (154)	7.01 (178)	8.98 (228)	9.76 (248)	10.94 (278)	12.52 (318)	15.28 (388)
D	4.84 (123)	5.31 (135)	6.30 (160)	6.69 (170)	7.28 (185)	8.07 (205)	9.45 (240)
K	10.24 (260)	1181 (300)	14.96 (380)	16.14 (410)	17.91 (455)	20.47 (520)	24.80 (630)

e-chain system® E2 tubes Series R117/R118 Interior Separation Mounting Brackets - KMA



R117
R118

Option 1: Vertical separators and spacers

Vertical separators are used if a vertical subdivision of the e-chain® interior is required. By standard, vertical separators are assembled every other e-chain® link. .

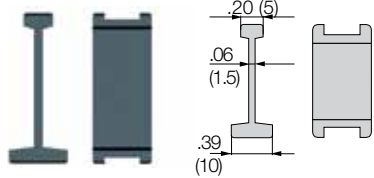
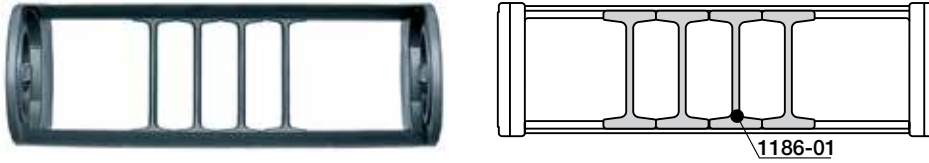

Vertical Separator

Unassembled **Part No. 1185-01**

Assembled **Part No. 1186-01**

- **Standard separator 1185-01 for e-chains®**
This separator is used for general subdivision of e-chain®.

Mounting Brackets - KMA

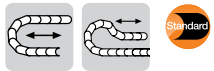

Option: KMA pivoting

- Short and long travels
- Space restricted
- Corrosion-resistant

Moving end
11800...1

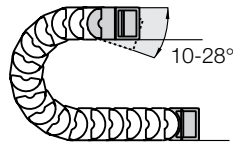

Fixed end
11800...4

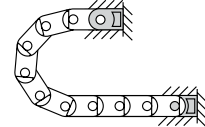

Part Number Structure

11800- 020- 14

Complete Set

Width

KMA Pivoting for selected chain type

Full set, for both ends:

11800-020-14 Full set, each part with pin/bore

Single-part order:

11800-020-1 Mounting bracket with bore

11800-020-4 Mounting bracket with pin

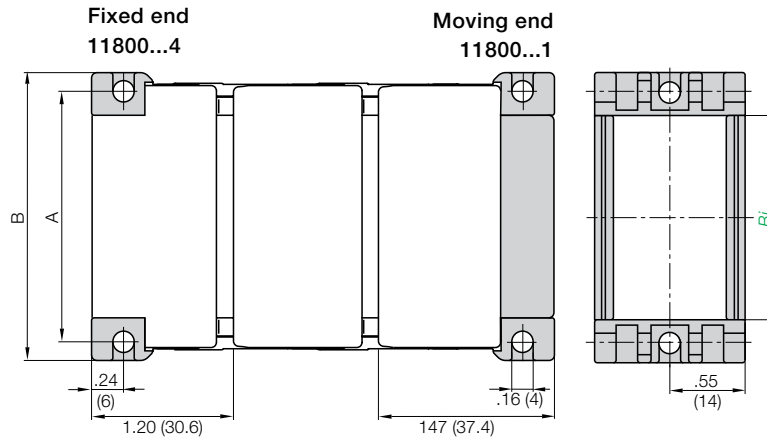

Series	Part No.	Dimension A		Dimension B	
		in.	(mm)	in.	(mm)
117-020	11800-020-14	1.14	(29)	1.42	(36)
117/118-025	11800-025-14	1.34	(34)	1.61	(41)
117-038	11800-038-14	1.85	(47)	2.13	(54)
117/118-048	11800-048-14	2.24	(57)	2.52	(64)
117-063	11800-063-14	2.83	(72)	3.11	(79)
117/118-080	11800-080-14	3.50	(89)	3.78	(96)
117-100	11800-100-14	4.29	(109)	4.57	(116)

- The mounting brackets are supplied with hexagon nuts and can be attached with M4 bolts, or the mounting brackets may also be attached with M4 socket head cap bolts

PDF: igus.com/e-chain-pdfs
Product information: igus.com/e-chains

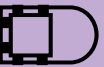

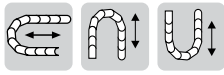

Option: plastic bracket

- For long travels
- Attachment option for strain relief tiewrap plate
- Locked connection to e-tube
- Minimized external width

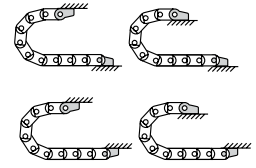
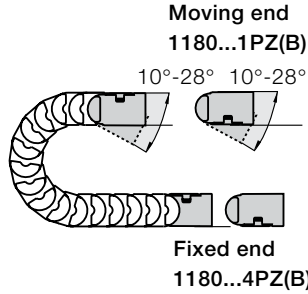

Possible installation configurations -

Moving end
1180...1PZ(B)

Fixed end
1180...4PZ(B)

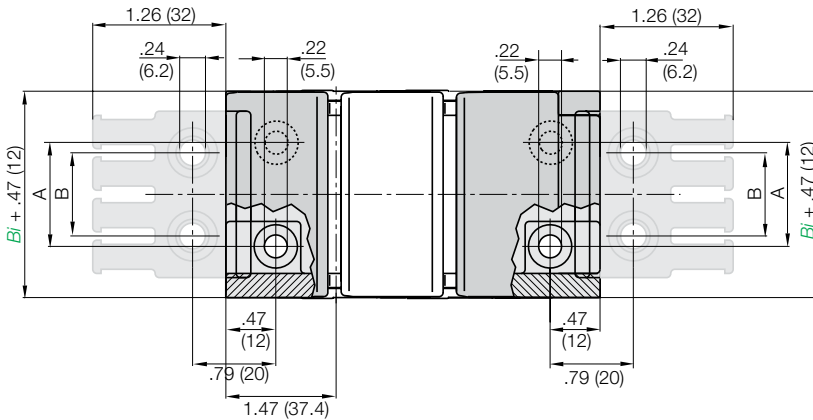

Part Number Structure

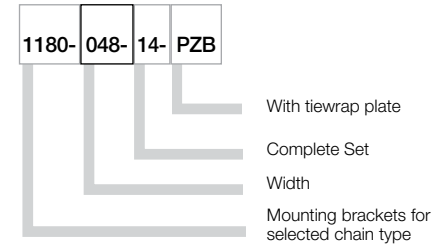

Full set, for both ends:

1180-048-14 Full set, each part with pin/bore

Single-part order:

1180-048-1 Mounting bracket with bore

1180-048-4 Mounting bracket with pin

Part No. Mounting Brackets Full Set

4 parts, 2 with pin, 2 with bore
Series R117/R118:
1180-Width-14

Part No. Mounting bracket with bore

2 parts, 1 left & 1 right
Series R117/R118:
1180-Width-1

Part No. Mounting bracket with pin

2 parts, 1 left & 1 right
Series R117/R118:
1180-Width-4

For Series	Part No. Full Set without Tiewrap Plate	Part No. Full Set with Tiewrap Plate	Dimension A in. (mm)	Dimension B in. (mm)
R117/R118-025	1180-025-14PZ	1180-025-14PZB	.47 (12)	.59 (15)
R117-038	1180-038-14PZ	1180-038-14PZB	.98 (25)	.79 (20)
R117/R118-048	1180-048-14PZ	1180-048-14PZB	1.38 (35)	1.18 (30)
R117-063	1180-063-14PZ	1180-063-14PZB	1.97 (50)	1.57 (40)
R117/R118-080	1180-080-14PZ	1180-080-14PZB	2.64 (67)	2.36 (60)
R117-100	1180-100-14PZ	1180-100-14PZB	3.43 (87)	3.15 (80)

The following parts are required for attachment of the mounting brackets:

- Countersunk bolt M5* DIN 912-8.8
- Hexagon nut M5 DIN 934-8
4 pieces/set

* The length of the socket head cap bolt is dependent on the thickness of the attachment base.

Tiewrap Plates

Option 1:
Tiewrap plates as an individual part

Available as an individual component, can be fixed onto a mounting bracket with the use of a profile rail.

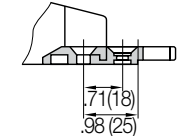

Shown assembled

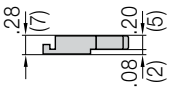

Single tiewrap plate

Tiewrap Plates	n Number of Teeth	Dimension C	Dimension B
2020-ZB	3	1.18 (30)	.59 (15)
2030-ZB	4	1.57 (40)	.79 (20)
2040-ZB	5	1.97 (50)	1.18 (30)
2050-ZB	6	2.36 (60)	1.57 (40)
2070-ZB	8	3.15 (80)	2.36 (60)
2090-ZB	9	3.54 (90)	2.76 (70)
2100-ZB	10	3.94 (100)	3.15 (80)
2125-ZB	12	4.72 (120)	3.94 (100)

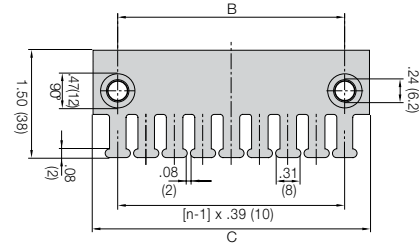

For more information please refer to strain relief section of Chapter 10



Cable tiewraps as individual parts

Cable tiewraps 100 pieces/bag	Width x Length		Maximum Ø		Tensile Strength	
	in.	(mm)	in.	(mm)	lbs	(N)
CFB-001	.19 x 5.91	(4.8 x 150)	1.42	(36)	50	(222)

PDF: igus.com/e-chain-pdfs
Product information: igus.com/e-chains



R157
R158



e-chain system® E2 tubes Series R157/R158



Price Index



Series R157/R158

Special Features / Options



ESD classification:
Electrically conductive ESD/
ATEX version upon request



Flammability Class
VDE 0304 IIC UL94 HB

Assembly Tips

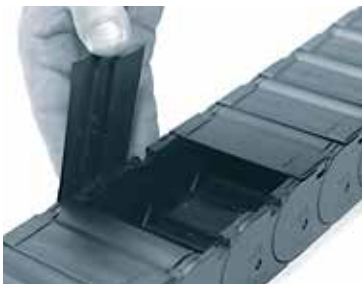

Lids of the e-tube Series R100 are hinged for easy access

Other Installation Methods

Vertical, hanging ≤ 131.2 ft (40 m)

Vertical, standing ≤ 9.84 ft (3 m)

Side-mounted, un_supp. ≤ 3.28 ft (1 m)

Rotary requires further calculation

Usage Guidelines



- If hinged, snap-open accessibility along inner or outer radius is required
- If a low-cost, lightweight e-tube for many types of applications is required
- If flush attachment is required
- If chip-repellent features are required



- If particularly quiet operation is required
 - Series R58 E2 tubes
- If snap-open accessibility along both radii simultaneously is required
 - Series R4-32 E4-1

Features & Benefits

- 1 Effective chip protection even against hot chips
- 2 Space-efficient with optimized ratio of inner dimension to outer dimension
- 3 Snap-open lids along the inner and outer radius
- 4 Snap-open from the side, covered pin/bore connection
- 5 Double stop dog for strong unsupported length
- 6 Universal KMA mounting brackets with attachment capability on all sides
- 7 Lateral glide surfaces for side mounted operation



Order Example: Complete e-chain®

Please indicate chain length or number of links. Example:

3.28 ft (1 m) 157-088-100-0



e-chain®

With 2 separators 1586-01 assembled every 2nd link



Interior Separation

1 Set 15800-088-12



Mounting Bracket

e-chain system® E2 tubes Series R157/R158 Installation Dimensions



R157
R158

Short travel, unsupported length

- FL_B = unsupported with permitted sag
 - FL_G = unsupported with straight upper run
- Further information ► Design, Chapter 1

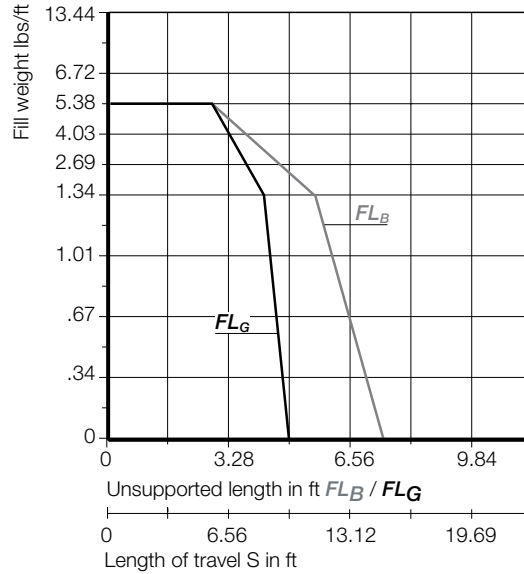
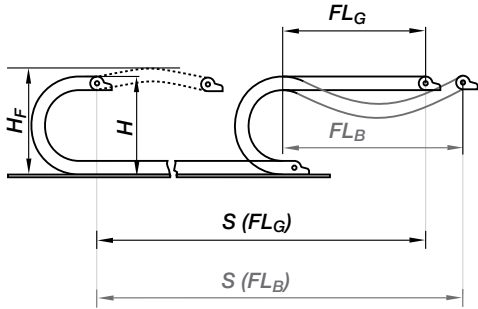

Short Travels - Unsupported



Unsupported e-chains® feature positive camber over short travels. This must be accounted for when specifying the clearance height. Please refer to **Installation dimensions** for further details.

Legend

- S = Length of travel
- R = Bending radius
- H = Nominal clearance height
- D = Overlength e-chain® radius in final position
- $K = \pi \cdot R + \text{safety buffer}$
- $H_F = \text{Required clearance height}$

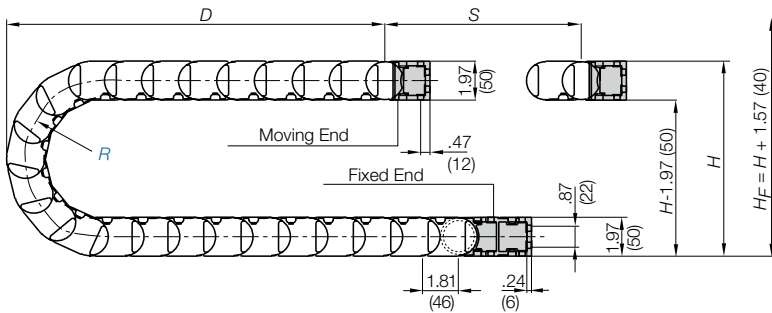

Pitch per link: = 1.81" (46 mm)
Links per ft (m): = 6.71 (22)
For center mount applications:
Chain length = $S/2 + K$

The required clearance height: $H_F = H + 1.57$ in. (40 mm) (with .67 lbs/ft (1.0 kg/m) fill weight. Please consult igus® if space is particularly restricted.

R	3.94 (100)	4.92 (125)	5.91 (150)	6.89 (175)	7.87 (200)	9.84 (250)
H	9.84 (250)	11.81 (300)	13.78 (350)	15.75 (400)	17.72 (450)	21.65 (550)
D	7.64 (194)	8.62 (219)	9.61 (244)	10.59 (269)	11.57 (294)	13.54 (344)
K	16.14 (410)	19.09 (485)	22.24 (565)	25.39 (645)	28.54 (725)	34.65 (880)

Speed / acceleration FL_G	max. 32.8 ft/s (10 m/s) / max. 328 ft/s ² (100 m/s ²)
Speed / acceleration FL_B	max. 9.84 ft/s (3 m/s) / max. 19.69 ft/s ² (6 m/s ²)
Gliding speed / acceleration (maximum)	max. 1.64 ft/s (0.5 m/s) / max. 16.4 ft/s ² (5 m/s ²)
Material - permitted temperature	igumid G / -40°F (-40°C) up to +248°F (+120° C)
Flammability Class, igumid G	VDE 0304 IIC UL94 HB

Technical Data



Details of material properties

► Chapter 1

PDF: igus.com/e-chain-pdfs
Product information: igus.com/e-chains



Series R157 - hinged, snap-open on both sides of the inner radius

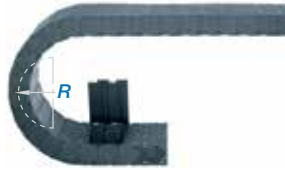
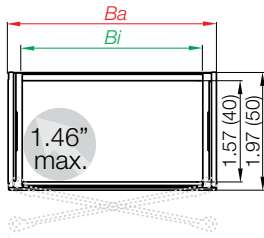

Part Number Structure

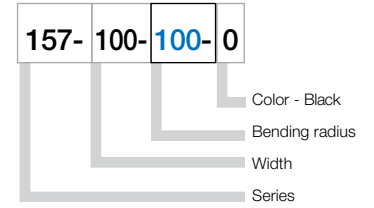

Series R158 - hinged, snap-open on both sides of the outer radius

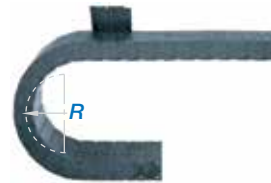
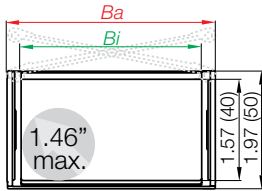

Part Number Structure

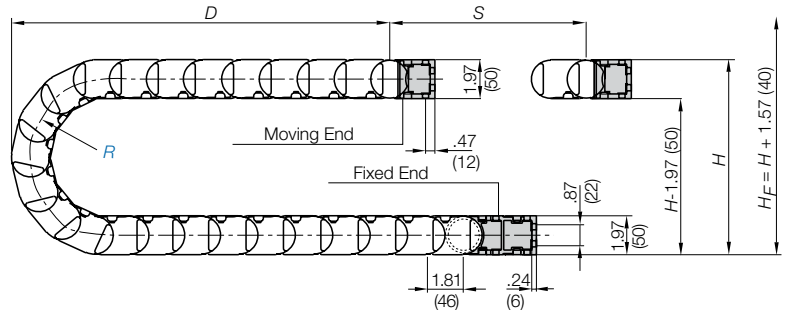
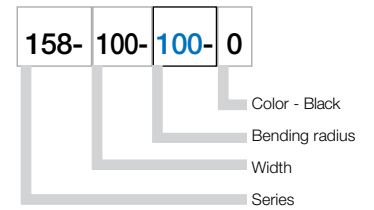

Supplement part number with required radius.
Example: 157-100--0
Pitch: 1.81 in. (46 mm) per link links/ft (m) = 6.71 (22)

Part Number.			<i>Bi</i>	<i>Ba</i>	Weight
Snap-open inner radius	Snap-open outer radius		in. (mm)	in. (mm)	lbs/ft (kg/m)
157-040-*	158-040-*	<input type="text" value="0"/> -0	1.57 (40)	2.20 (56)	≈ 0.81 (1.21)
157-050-	158-050-	<input type="text" value="0"/> -0	1.97 (50)	2.60 (66)	≈ 0.87 (1.30)
157-075-	158-075-	<input type="text" value="0"/> -0	2.95 (75)	3.58 (91)	≈ 1.01 (1.50)
157-088-	158-088-	<input type="text" value="0"/> -0	3.46 (88)	4.09 (104)	≈ 1.06 (1.57)
157-090-**	158-090-**	<input type="text" value="0"/> -0	3.46 (88)	4.09 (104)	≈ 1.10 (1.63)
157-100-	158-100-	<input type="text" value="0"/> -0	3.94 (100)	4.57 (116)	≈ 1.15 (1.71)
157-125-	158-125-	<input type="text" value="0"/> -0	4.92 (125)	5.55 (141)	≈ 1.29 (1.92)
157-135-	158-135-	<input type="text" value="0"/> -0	5.31 (135)	5.91 (150)	≈ 1.41 (2.10)
157-150-	158-150-	<input type="text" value="0"/> -0	5.91 (150)	6.54 (166)	≈ 1.43 (2.13)
157-175-	158-175-	<input type="text" value="0"/> -0	6.89 (175)	7.52 (191)	≈ 1.57 (2.34)
157-200-	158-200-	<input type="text" value="0"/> -0	7.87 (200)	8.50 (216)	≈ 1.71 (2.55)

Choose from the radii below for all of the above sizes
Radius (mm) Example: 157-100--0

	100	125	150	175	200	250
R	3.94 (100)	4.92 (125)	5.91 (150)	6.89 (175)	7.87 (200)	9.84 (250)
H	9.84 (250)	11.81 (300)	13.78 (350)	15.75 (400)	17.72 (450)	21.65 (550)
D	7.64 (194)	8.62 (219)	9.61 (244)	10.59 (269)	11.57 (294)	13.54 (344)
K	16.14 (410)	19.09 (485)	22.24 (565)	25.39 (645)	28.54 (725)	34.65 (880)

*Removable lid only, not hinged
**Same dimensions as 157/158-088 - removable lids only

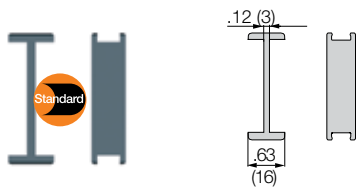
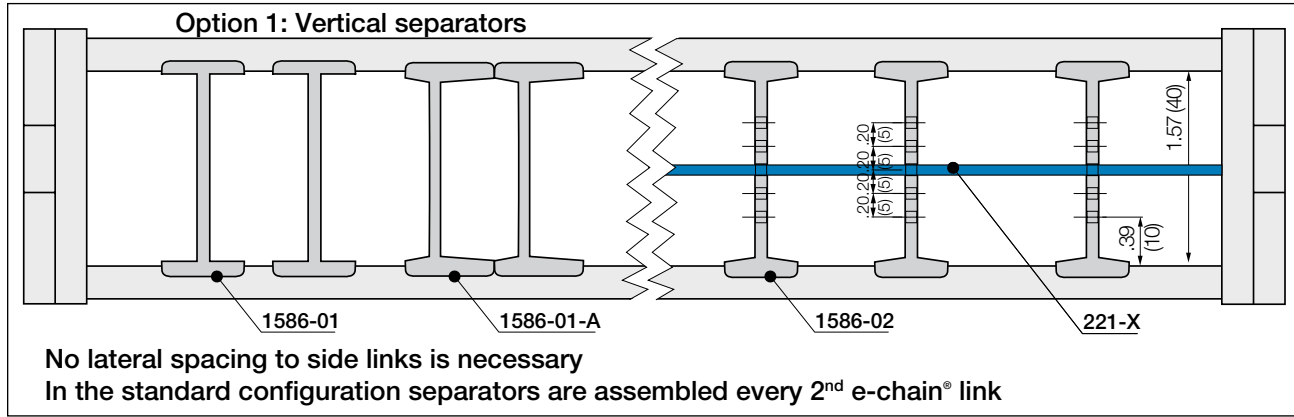

Separator for e-tubes

Unassembled	Part No. 1585-01
Assembled	Part No. 1586-01

- **Separator 1585-01**
 For vertical separation with wide base for maximum stability when used with thick cables or hoses

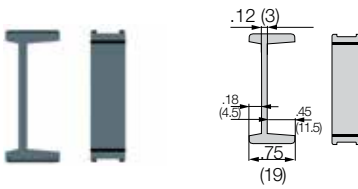

Asymmetrical separator for e-tubes

Unassembled	Part No. 1585-01-A
Assembled	Part No. 1586-01-A

- **Asymmetrical separator 1585-01-A**
 For side-mounted applications. Asymmetrical separator for defined distance. No additional spacers necessary.

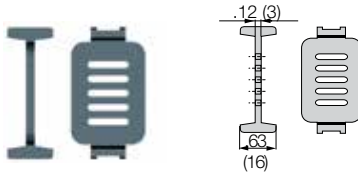

Slotted Separator for e-tubes

Unassembled	Part No. 1585-02
Assembled	Part No. 1586-02

- **Slotted separator 1585-02**
 is used when vertical and horizontal separation is required. Due to its slot, it allows basic vertical/horizontal shelving arrangements.

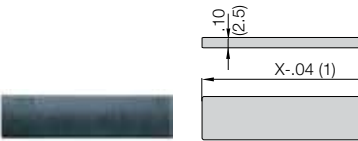

Full width shelf for e-tubes

Unassembled	Part No. 220-X
Assembled	Part No. 221-X

- **Full width shelf 220-X**
 is used in applications with many thin cables with similar diameters. Full-width shelves can be arranged at 5 different heights in .20" (5mm) increments.

Width X	Part No.	Part No.	Width X	Part No.	Part No.	Width X	Part No.	Part No.
in. (mm)	Unassembled	Assembled	in. (mm)	Unassembled	Assembled	in. (mm)	Unassembled	Assembled
1.57 (040)	220-40	221-40	3.94 (100)	220-100	221-100	6.89 (175)	220-175	221-175
1.97 (050)	220-50	221-50	4.92 (125)	220-125	221-125	7.87 (200)	220-200	221-200
2.95 (075)	220-75	221-75	5.31 (135)	220-135	221-135			
3.46 (088)	220-88	221-88	5.91 (150)	220-150	221-150			



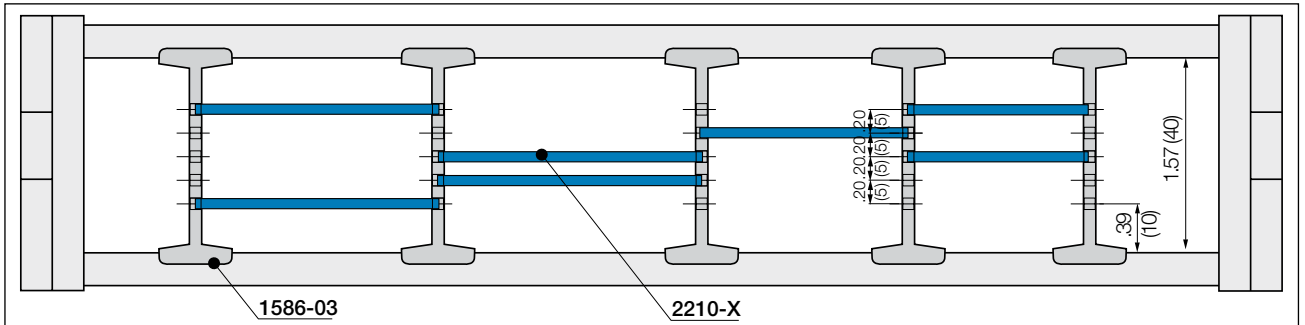

No lateral spacing to side links is necessary
In the standard configuration separators are assembled every 2nd e-chain® link

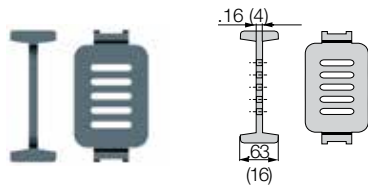

Separator, narrow base

Unassembled	Part No. 1585-03
Assembled	Part No. 1586-03

- **Slotted separator 1585-03**
is used when vertical and horizontal separation is required. Due to its slot, it allows basic vertical/horizontal shelving arrangements.

Full-width shelves - for the standard interior separation

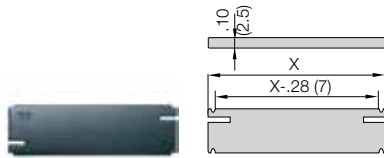

Full width shelf

Unassembled	Part No. 2200-X
Assembled	Part No. 2210-X

- **Full width shelf 2200-X**
For applications involving many cables with different diameters, shelves can be arranged at alternate heights. They can be arranged at 5 different heights in .20" (5mm) increments.

Width X in. (mm)	Part No. Unassembled	Part No. Assembled	Width X in. (mm)	Part No. Unassembled	Part No. Assembled	Width X in. (mm)	Part No. Unassembled	Part No. Assembled
.71 (18)	2200-18	2210-18	1.69 (43)	2200-43	2210-43	3.46 (88)	2200-88	2210-88
.91 (23)	2200-23	2210-23	1.89 (48)	2200-48	2210-48	3.90 (99)	2200-99	2210-99
1.10 (28)	2200-28	2210-28	2.28 (58)	2200-58	2210-58	4.88 (124)	2200-124	2210-124
1.30 (33)	2200-33	2210-33	2.68 (68)	2200-68	2210-68	5.87 (149)	2200-149	2210-149
1.50 (38)	2200-38	2210-38	2.87 (73)	2200-73	2210-73			

Separator with integrated strain relief

Strain relief separator Part No. 1585-01-Z can be integrated into the mounting bracket and can be placed there at any point of the e-tube®. It combines strain relief and interior separation, it can be installed on the first or last e-tube® link and is easy to assemble without any screws.

For more information ► **Chapter 10, Strain Relief**

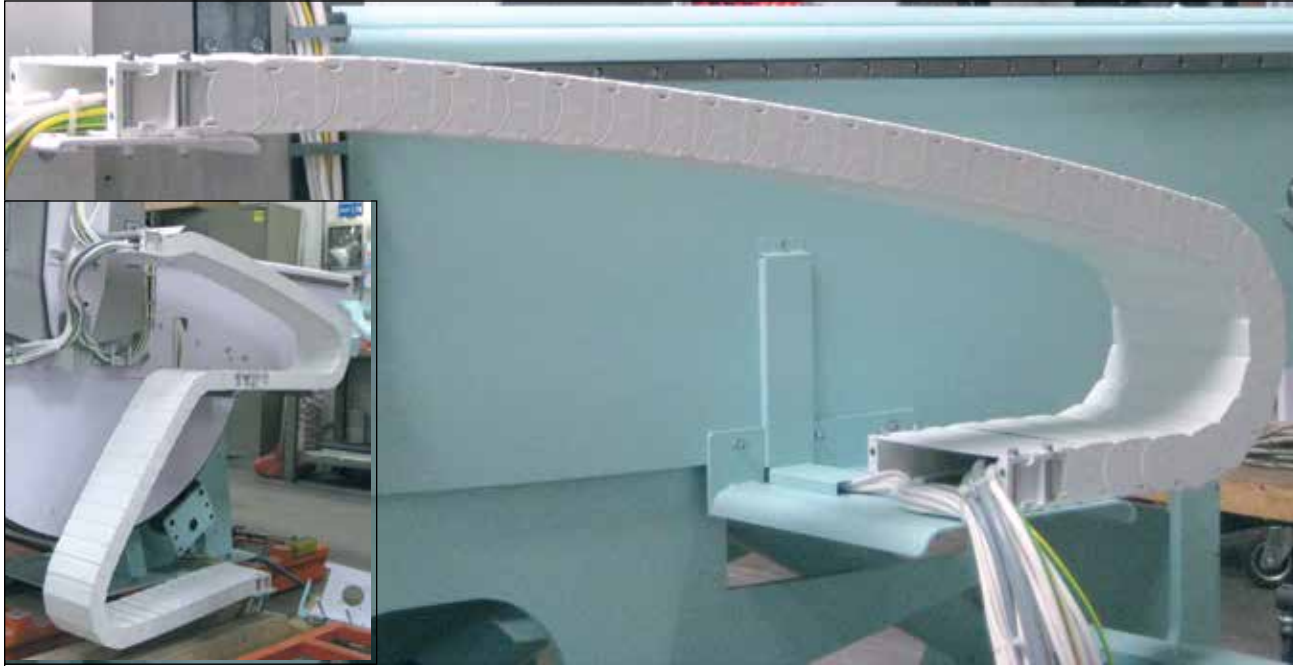

PDF: igus.com/e-chain-pdfs
Product information: igus.com/e-chains



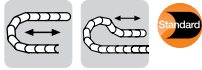

Option 1: KMA pivoting

- Extended, pivoting
- Easy to install
- Universal use
- Corrosion-resistant
- Long travels with lowered mounting height possible

Moving end
15800/15801...1

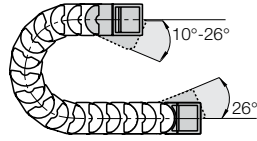

Fixed end
15800/15801...2

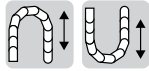

Option 2: KMA locking

- Extended, locking
- Easy to install
- Flush mounting at both ends of the e-tube
- Mounting points on all sides
- Corrosion resistant

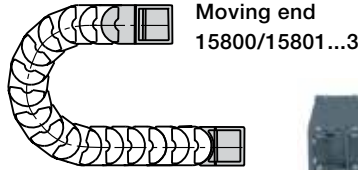

Moving end
15800/15801...3

Fixed end
15800/15801...4



Part Number Structure

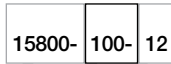

Complete Set
12 = Pivoting
34 = Locking

Width

KMA Pivoting for selected chain type

Moving end
1580...1/1580...3

Fixed end
1580...2/1580...4

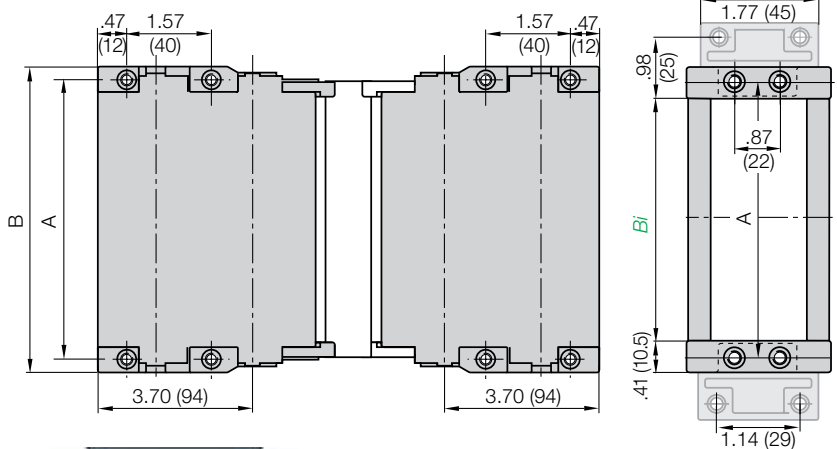

Full set, for both ends:

15800-100-12 Full set, each part with pin/bore

Single-part order:

15800-100-1 Mounting bracket with bore

15800-100-2 Mounting bracket with pin



Quickflange upon request

- Unassembled

Part number 15800-QF

Series	Part No.	Dimension A		Dimension B	
		in.	(mm)	in.	(mm)
157/158-040	15801-040- <input type="checkbox"/>	1.97	(50)	2.40	(61)
157/158-050	15800-050- <input type="checkbox"/>	2.40	(60)	2.80	(71)
157/158-075	15800-075- <input type="checkbox"/>	3.35	(85)	3.78	(96)
157/158-088	15800-088- <input type="checkbox"/>	3.86	(98)	4.29	(109)
157/158-090	15801-090- <input type="checkbox"/>	3.86	(98)	4.29	(109)
157/158-100	15800-100- <input type="checkbox"/>	4.33	(110)	4.76	(121)
157/158-125	15800-125- <input type="checkbox"/>	5.31	(135)	5.75	(146)
157/158-135	15800-135- <input type="checkbox"/>	5.71	(145)	6.14	(156)
157/158-150	15800-150- <input type="checkbox"/>	6.30	(160)	6.73	(171)
157/158-175	15800-175- <input type="checkbox"/>	7.28	(185)	7.72	(196)
157/158-200	15800-200- <input type="checkbox"/>	8.27	(210)	8.70	(221)

The following parts are required for attachment of the mounting brackets:

- **Socket head cap bolt**
M5* DIN 912-8.8
8 pieces/set
- **Washer**
5.3 DIN 125-ST
8 pieces/set
- **Hexagon nut**
M5 DIN 934-8
8 pieces/set

* The length of the socket head cap bolt is dependent on the thickness of the attachment base.

For pivoting brackets choose 12
For locking brackets choose 34
Example: 15800-100- 34

e-chain system® E2 tubes Series R157/R158 Mounting Brackets - KMA Abbreviated



R157
R158

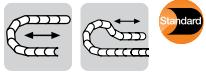

Option 1: KMA pivoting

- Extended, pivoting
- Easy to install
- Universal use
- Corrosion-resistant
- Long travels with lowered mounting height possible

Moving end
1580...1

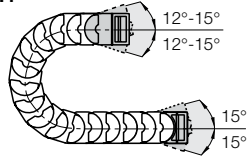

Fixed end
1580...2

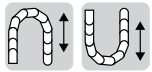

Option 2: KMA locking

- Extended, locking
- Easy to install
- Flush mounting at both ends of the e-tube
- Mounting points on all sides
- Corrosion resistant

Moving end
1585...1

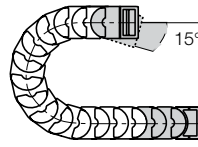

Fixed end
1585...2



Part Number Structure

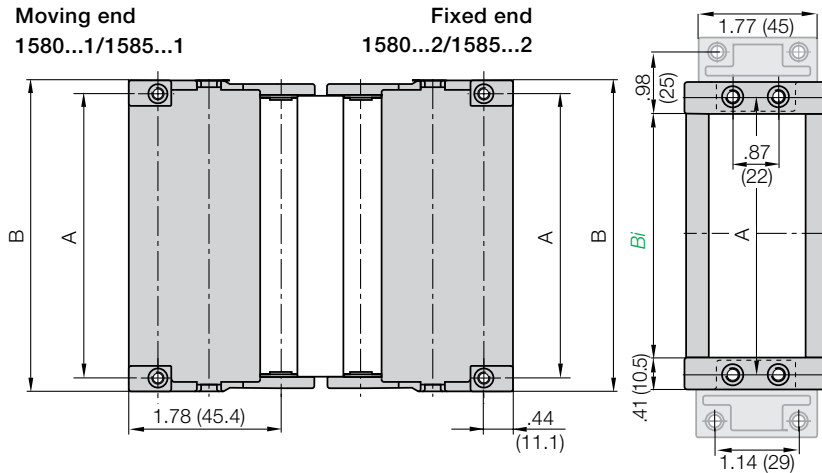
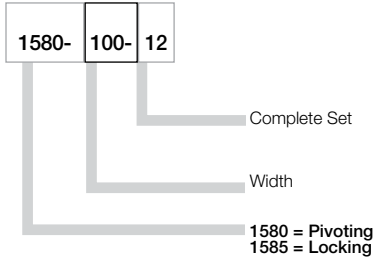

Part number examples are shown for pivoting brackets.
For locking brackets change part number to 1585

Full set, for both ends:

1580-100-12 Full set, each part with pin/bore

Single-part order:

1580-100-1 Mounting bracket with bore

1580-100-2 Mounting bracket with pin



Quickflange upon request

- Unassembled

Part number 15800-QF

Series	Part No. Full Set		Dimension A		Dimension B	
	Pivoting	Locking	in.	(mm)	in.	(mm)
157/158-040	1580-040-12	1585-040-12	1.97	(50)	2.40	(61)
157/158-050	1580-050-12	1585-050-12	2.40	(60)	2.80	(71)
157/158-075	1580-075-12	1585-075-12	3.35	(85)	3.78	(96)
157/158-088	1580-088-12	1585-088-12	3.86	(98)	4.29	(109)
157/158-090	1580-090-12	1585-090-12	3.86	(98)	4.29	(109)
157/158-100	1580-100-12	1585-100-12	4.33	(110)	4.76	(121)
157/158-125	1580-125-12	1585-125-12	5.31	(135)	5.75	(146)
157/158-135	1580-135-12	1585-135-12	5.71	(145)	6.14	(156)
157/158-150	1580-150-12	1585-150-12	6.30	(160)	6.73	(171)
157/158-175	1580-175-12	1585-175-12	7.28	(185)	7.72	(196)
157/158-200	1580-200-12	1585-200-12	8.27	(210)	8.70	(221)

The following parts are required for attachment of the mounting brackets:

- **Socket head cap bolt**
M5* DIN 912-8.8
8 pieces/set
- **Washer**
5.3 DIN 125-ST
8 pieces/set
- **Hexagon nut**
M5 DIN 934-8
8 pieces/set

* The length of the socket head cap bolt is dependent on the thickness of the attachment base.

PDF: igus.com/e-chain-pdfs
Product information: igus.com/e-chains





Series R167/R168

Special Features / Options



ESD classification:
Electrically conductive ESD/
ATEX version upon request



Flammability Class
VDE 0304 IIC UL94 HB

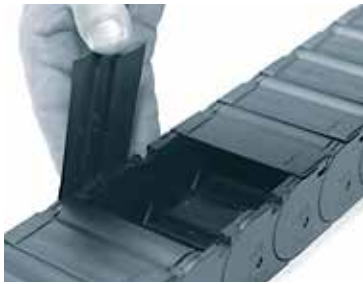

Lids of the e-tube Series R100 are hinged for easy access

Other Installation Methods

Vertical, hanging ≤ 164 ft (50 m)

Vertical, standing ≤ 9.84 ft (3 m)

Side-mounted, un_supp. ≤ 3.28 ft (1 m)

Rotary requires further calculation

Usage Guidelines



- If snap-open accessibility along inner outer radius is required
- If a low-cost, lightweight e-tube for many types of applications is required
- If flush attachment is required
- If chip-repellent features are required



- If very smooth travel due to small pitch is required
➤ **Series R68 E2 tubes**
- If snap-open accessibility along both radii simultaneously is required
➤ **Series R4-42 E4-1**

Features & Benefits

- 1 Lateral glide surfaces for side mounted operation
- 2 Snap-open lids along the inner and outer radius
- 3 Lids can be swiveled from the left to the right
- 4 Universal KMA mounting brackets with attachment capability on all sides
- 5 Double stop dog for strong unsupported length
- 6 Effective chip protection even against hot chips
- 7 Space-efficient with optimized ratio of inner dimension to outer dimension
- 8 Covered pin/bore connection



Order Example: Complete e-chain®

Please indicate chain length or number of links. Example:

3.28 ft (1 m) **167-100-100-0**



e-chain®

With 2 separators **1686-01** assembled every 2nd link



Interior Separation

1 Set **1680-100-12**



Mounting Bracket

e-chain system® E2 tubes

Series R167/R168

Installation Dimensions



R167
R168

Short travel, unsupported length

- FL_B = unsupported with permitted sag
 - FL_G = unsupported with straight upper run
- Further information ► Design, Chapter 1

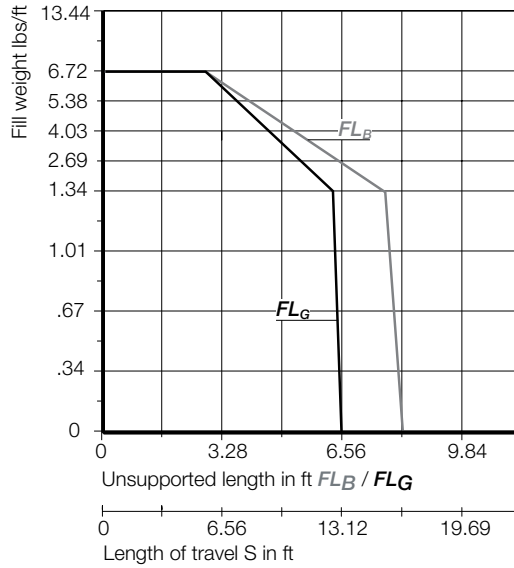
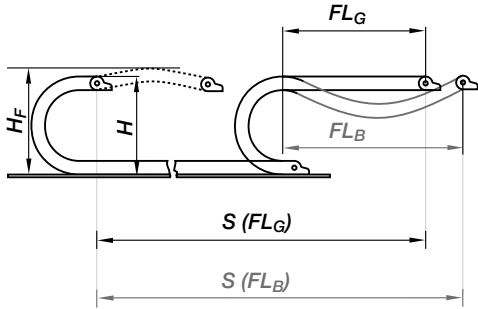

Short Travels - Unsupported



Unsupported e-chains® feature positive camber over short travels. This must be accounted for when specifying the clearance height. Please refer to **Installation dimensions** for further details.

Legend

- S = Length of travel
- R = Bending radius
- H = Nominal clearance height
- D = Overlength e-chain® radius in final position
- $K = \pi \cdot R + \text{safety buffer}$
- H_F = Required clearance height

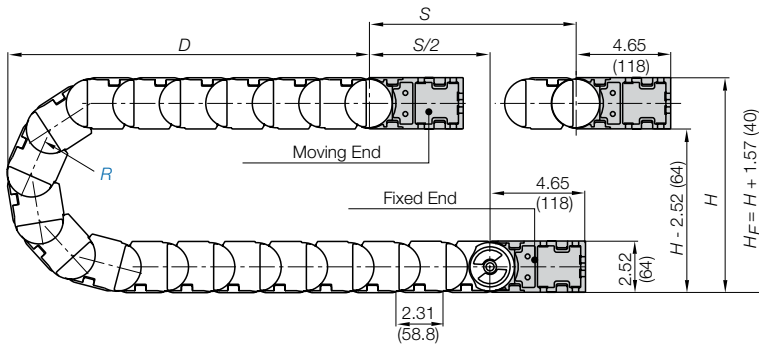

Pitch per link = 2.31" (58.8 mm)

Links per ft (m) = 5.18 (17)

For center mount applications:

Chain length = $S/2 + K$

The required clearance height: $H_F = H + 1.57$ in. (40 mm) (with 1.34 lbs/ft (2.0 kg/m) fill weight). Please consult igus® if space is particularly restricted.

R	3.94 (100)	4.92 (125)	5.91 (150)	6.89 (175)	7.87 (200)	8.86 (225)	9.84 (250)	11.81 (300)
H	10.39 (264)	12.36 (314)	14.33 (364)	16.30 (414)	18.27 (464)	20.24 (514)	22.20 (564)	26.14 (664)
D	8.66 (220)	9.65 (245)	10.63 (270)	11.61 (295)	12.60 (320)	13.58 (345)	14.57 (370)	16.54 (420)
K	17.12 (435)	20.28 (515)	23.23 (590)	26.38 (670)	29.53 (750)	32.48 (825)	35.63 (905)	41.93 (1065)

Speed / acceleration FL_G	max. 32.8 ft/s (10 m/s) / max. 328 ft/s ² (100 m/s ²)
Speed / acceleration FL_B	max. 9.84 ft/s (3 m/s) / max. 19.69 ft/s ² (6 m/s ²)
Gliding speed / acceleration (maximum)	max. 1.64 ft/s (0.5 m/s) / max. 16.4 ft/s ² (5 m/s ²)
Material - permitted temperature	igumid G / -40°F (-40°C) up to +248°F (+120° C)
Flammability Class, igumid G	VDE 0304 IIC UL94 HB

Technical Data



Details of material properties

► Chapter 1



PDF: igus.com/e-chain-pdfs
Product information: igus.com/e-chains



Series R167 - hinged, snap-open on both sides of the inner radius

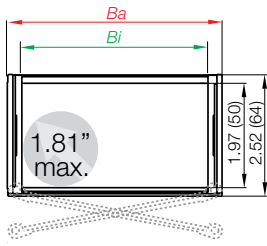

Part Number Structure

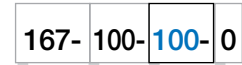

- Color - Black
- Bending radius
- Width
- Series

Series R168 - hinged, snap-open on both sides of the outer radius

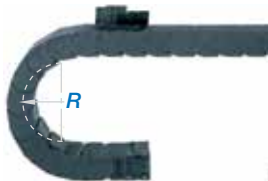
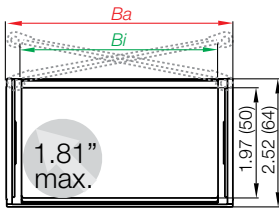

Part Number Structure

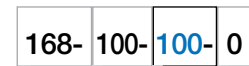

- Color - Black
- Bending radius
- Width
- Series

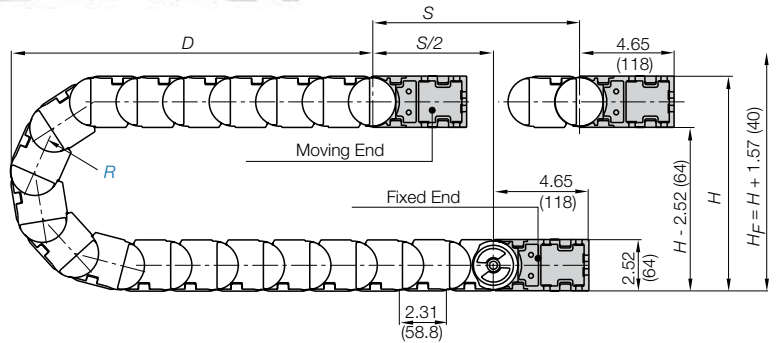

Supplement part number with required radius.
Example: 167-100--0
Pitch: 2.31 in. (58.8 mm) per link links/ft (m) = 5.18 (17)

Part Number.			<i>Bi</i>	<i>Ba</i>	Weight
Snap-open inner radius	Snap-open outer radius		in. (mm)	in. (mm)	lbs/ft (kg/m)
167-050-	168-050-	<input type="text" value=""/> -0	1.97 (50)	2.68 (68)	≈ 1.06 (1.58)
167-075-	168-075-	<input type="text" value=""/> -0	2.95 (75)	3.66 (93)	≈ 1.24 (1.84)
167-100-	168-100-	<input type="text" value=""/> -0	3.94 (100)	4.65 (118)	≈ 1.40 (2.09)
167-115-	168-115-	<input type="text" value=""/> -0	4.53 (115)	5.24 (133)	≈ 1.51 (2.24)
167-125-	—	<input type="text" value=""/> -0	4.92 (125)	5.63 (143)	≈ 1.58 (2.35)
167-150-	168-150-	<input type="text" value=""/> -0	5.91 (150)	6.61 (168)	≈ 1.75 (2.60)
167-175-	168-175-	<input type="text" value=""/> -0	6.89 (175)	7.60 (193)	≈ 1.92 (2.86)
167-200-	168-200-	<input type="text" value=""/> -0	7.87 (200)	8.58 (218)	≈ 2.09 (3.11)
167-225-	—	<input type="text" value=""/> -0	8.86 (225)	9.57 (243)	≈ 2.26 (3.37)
167-250-	—	<input type="text" value=""/> -0	9.84 (250)	10.55 (268)	≈ 2.43 (3.62)

Choose from the radii below for all of the above sizes

Radius (mm) Example: 167-100--0

100	125	150	175	200	225	250	300
10.39 (264)	12.36 (314)	14.33 (364)	16.30 (414)	18.27 (464)	20.24 (514)	22.20 (564)	26.14 (664)
8.66 (220)	9.65 (245)	10.63 (270)	11.61 (295)	12.60 (320)	13.58 (345)	14.57 (370)	16.54 (420)
17.12 (435)	20.28 (515)	23.23 (590)	26.38 (670)	29.53 (750)	32.48 (825)	35.63 (905)	41.93 (1065)

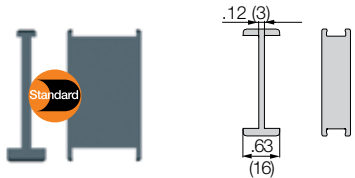
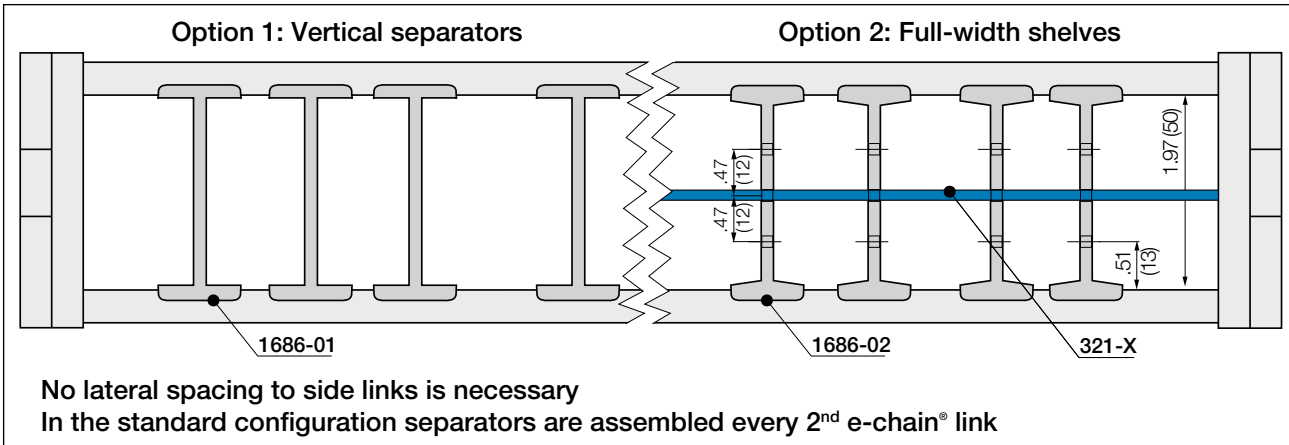

Separator for e-tubes

Unassembled	Part No. 1685-01
Assembled	Part No. 1686-01

- **Separator 1685-01**
 For vertical separation with wide base for maximum stability when used with thick cables or hoses

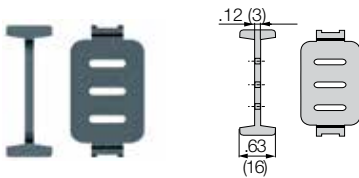

Slotted Separator for e-tubes

Unassembled	Part No. 1685-02
Assembled	Part No. 1686-02

- **Slotted separator 1685-02**
 is used when vertical subdivision is required. Due to its slot, it allows basic vertical/horizontal shelving arrangements.

Full-width shelves - for the standard interior separation

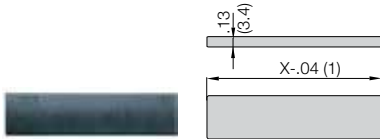

Full width shelf for e-tubes

Unassembled	Part No. 320-X
Assembled	Part No. 321-X

- **Full width shelf 320-X**
 is used in applications with many thin cables with similar diameters. Full-width shelves can be arranged at 3 different heights in .47" (12mm) increments.

Width X in. (mm)	Part No. Unassembled	Part No. Assembled	Width X in. (mm)	Part No. Unassembled	Part No. Assembled	Width X in. (mm)	Part No. Unassembled	Part No. Assembled
1.97 (50)	320-50	321-50	4.92 (125)	320-125	321-125	7.87 (200)	320-200	321-200
2.95 (75)	320-75	321-75	5.91 (150)	320-150	321-150	8.86 (225)	320-225	321-225
4.53 (115)	320-115	321-115	6.89 (175)	320-175	321-175	9.84 (250)	320-250	321-250



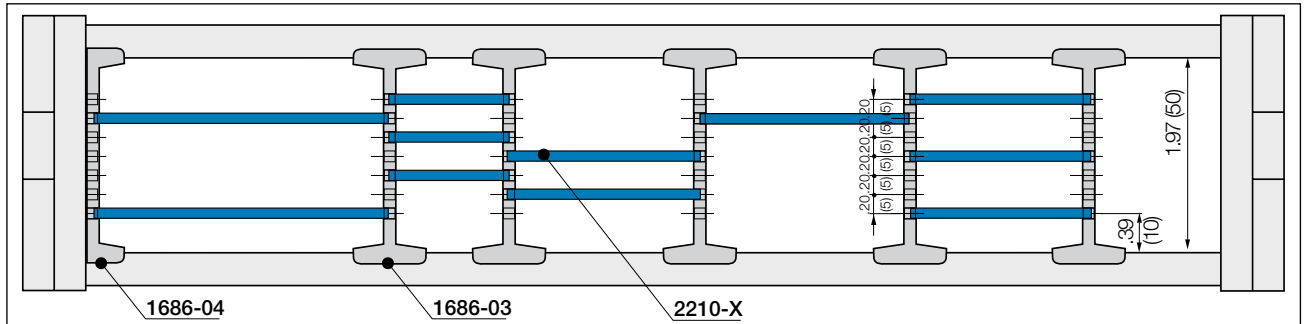

No lateral spacing to side links is necessary
In the standard configuration separators are assembled every 2nd e-chain® link

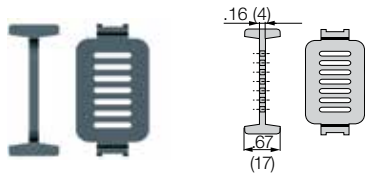

Separator, narrow base

Unassembled	Part No. 1685-03
Assembled	Part No. 1686-03

● **Middle plate 1685-03**

To achieve modular separation the shelf 2200-X can be arranged at 7 different heights in .20" (5mm) increments.

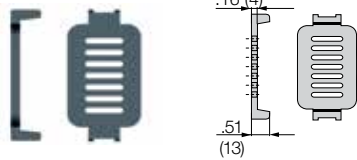

Separator, narrow base

Unassembled	Part No. 1685-04
Assembled	Part No. 1686-04

● **Side plate 1685-04**

For use with shelf 2200-X and middle plate 1685-03

Full-width shelves - for the standard interior separation

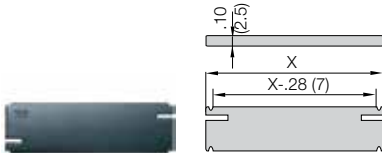

Full width shelf

Unassembled	Part No. 2200-X
Assembled	Part No. 2210-X

● **Full width shelf 2200-X**

For applications involving many cables with different diameters, shelves can be arranged at alternate heights. They can be arranged at 5 different heights in .20" (5mm) increments.

Width X in. (mm)	Part No. Unassembled	Part No. Assembled	Width X in. (mm)	Part No. Unassembled	Part No. Assembled	Width X in. (mm)	Part No. Unassembled	Part No. Assembled
.71 (18)	2200-18	2210-18	1.69 (43)	2200-43	2210-43	3.46 (88)	2200-88	2210-88
.91 (23)	2200-23	2210-23	1.89 (48)	2200-48	2210-48	3.90 (99)	2200-99	2210-99
1.10 (28)	2200-28	2210-28	2.28 (58)	2200-58	2210-58	4.88 (124)	2200-124	2210-124
1.30 (33)	2200-33	2210-33	2.68 (68)	2200-68	2210-68	5.87 (149)	2200-149	2210-149
1.50 (38)	2200-38	2210-38	2.87 (73)	2200-73	2210-73			

Separator with integrated strain relief

Strain relief separator Part No. 1685-01-Z can be integrated into the mounting bracket and can be placed there at any point of the e-tube®. It combines strain relief and interior separation, it can be installed on the first or last e-tube® link and is easy to assemble without any screws.

For more information ► Chapter 10, Strain Relief



e-chain system® E2 tubes Series R167/R168 Mounting Brackets - KMA Extended



R167
R168

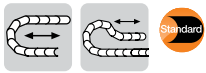

Option 1: pivoting

- Unsupported and gliding applications
- Mounting points on all sides
- Quickflange Option, bolted outside of e-tube cross section
- Long travels with lowered mounting height possible
- Corrosion-resistant

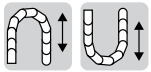

Option 2: locking

- Vertical hanging/standing applications
- Quickflange Option, bolted outside of e-tube cross section
- Extreme speeds and accelerations
- Mounting points on all sides
- Flush mounting at both ends of the e-tube



Part Number Structure

1680-	100-	12	QF
-------	------	----	----

- With Quickflange
- Complete Set
12 = Pivoting
14 = Locking
- Width
- Mounting brackets for selected chain type

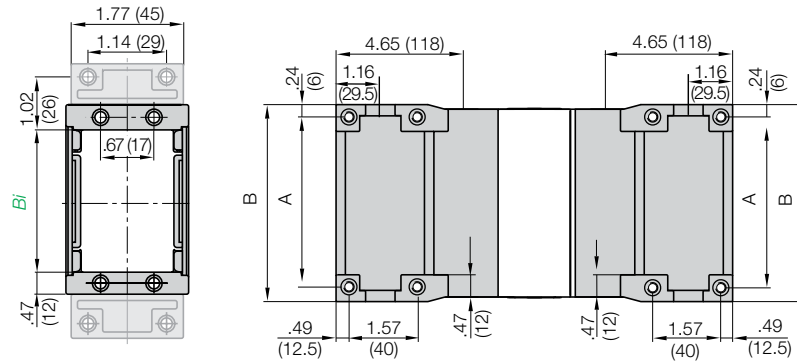

Full set, for both ends:

1680-100-12 QF Full set, each part with pin/bore + tiewrap plate

Single-part order:

1680-100-1 QF Mounting bracket with bore + tiewrap plate

1680-100-2 QF Mounting bracket with pin + tiewrap plate



Quickflange Unassembled
Part number 1680-QF

For Tube Type	Part No. Full set with Tiewrap Plate	Part No. Full Set with Quickflange	Dimension A in. (mm)	Dimension B in. (mm)
167/168-050	1680-050- <input type="checkbox"/>	1680-050- <input type="checkbox"/> QF	2.44 (62)	2.91 (74)
167/168-075	1680-075- <input type="checkbox"/>	1680-075- <input type="checkbox"/> QF	3.43 (87)	3.90 (99)
167/168-100	1680-100- <input type="checkbox"/>	1680-100- <input type="checkbox"/> QF	4.41 (112)	4.88 (124)
167/168-115	1680-115- <input type="checkbox"/>	1680-115- <input type="checkbox"/> QF	5.00 (127)	5.47 (139)
167/168-125	1680-125- <input type="checkbox"/>	1680-125- <input type="checkbox"/> QF	5.39 (137)	5.87 (149)
167/168-150	1680-150- <input type="checkbox"/>	1680-150- <input type="checkbox"/> QF	6.38 (162)	6.85 (174)
167/168-175	1680-175- <input type="checkbox"/>	1680-175- <input type="checkbox"/> QF	7.36 (187)	7.83 (199)
167/168-200	1680-200- <input type="checkbox"/>	1680-200- <input type="checkbox"/> QF	8.35 (212)	8.82 (224)
167/168-225	1680-225- <input type="checkbox"/>	1680-225- <input type="checkbox"/> QF	9.33 (237)	9.80 (249)
167/168-250	1680-250- <input type="checkbox"/>	1680-250- <input type="checkbox"/> QF	10.31 (262)	10.79 (274)

For pivoting brackets choose **12**
 12 or 14
 For locking brackets choose **14**
 Example: 1680-100-14 QF

The following parts are required for attachment of the mounting brackets:

* The length of the socket head cap bolt is dependent on the thickness of the attachment base.

PDF: igus.com/e-chain-pdfs
Product information: igus.com/e-chains





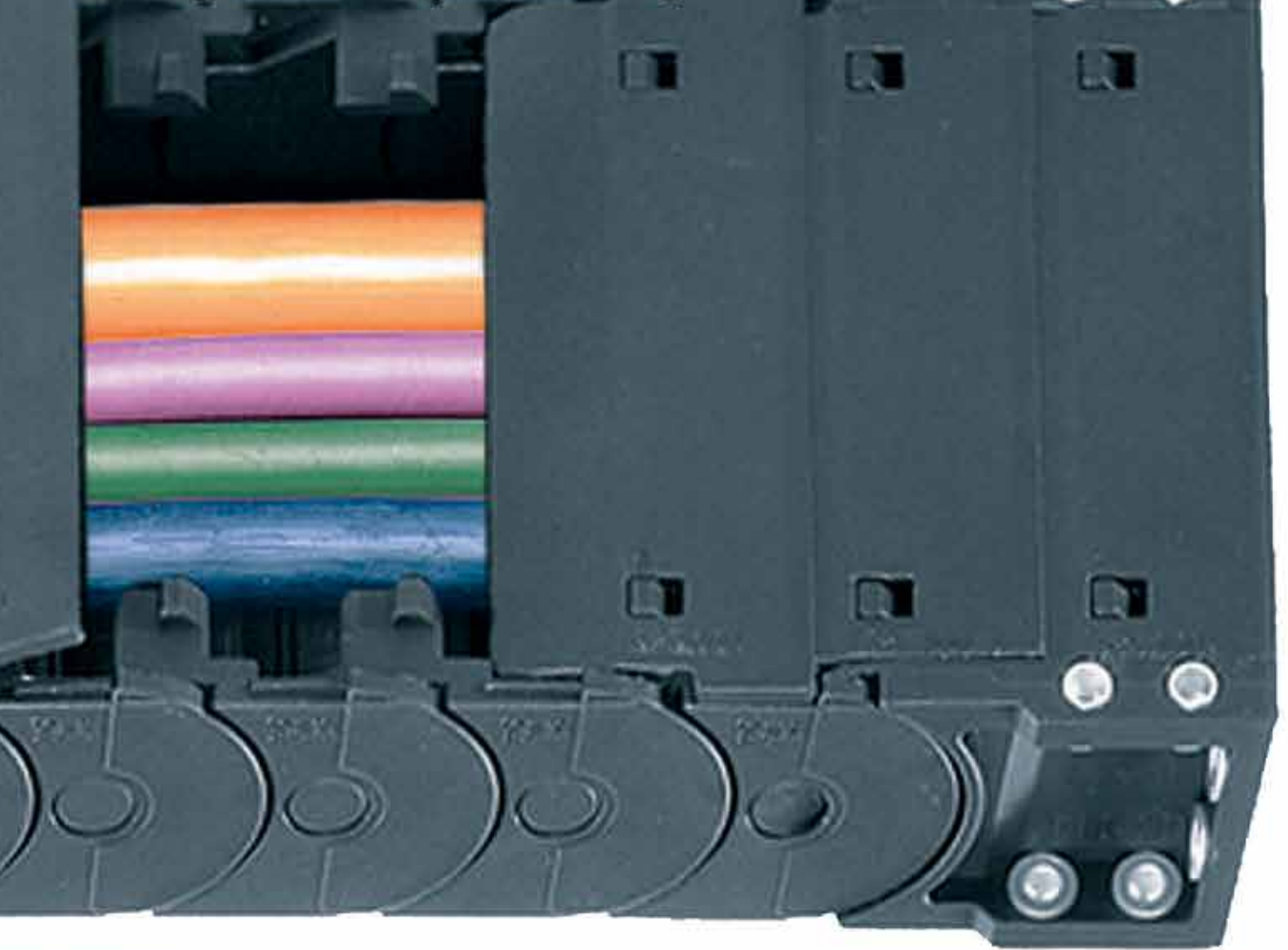

E2R

**e-tubes for chip protection
at higher speeds and
smooth running**



Chip protection at higher speeds and smooth running - E2 R e-tubes

E2 R e-tubes - small pitch for higher speeds and smooth motion. igus® e-tubes work in hot chip areas, in areas of dirt and dust generated by woodworking, steel mills, pulp and paper, textile, agriculture, coal plant and many other hostile environments.

- High level of protection against chips (including hot chips)
- Robust and sealed
- Space-efficient with optimized ratio of inner to outer dimensions
- Modular interior separation
- Universal KMA mounting brackets with attachment options from any side

Typical industries and applications

- Machine tools
- Wood processing machines
- General mechanical engineering
- In all areas with dirt and chips



e-tubes with igumid HT-Material for hot chips up to +1,562°F available upon request



Electrically conductive ESD e-tubes upon request



UL94-V0 classifications upon request



iF product design award

1987 igus® series R68

Energy Chain System® E2 R tubes

Selection Guide

Series	Inner height <i>hi</i>		Inner width <i>Bi</i>		Outer width <i>Ba</i>		Outer height <i>ha</i>		Bend radius <i>R</i>		Unsupported length ≤ ft. (m)
	in.	(mm)	in.	(mm)	in.	(mm)	in.	(mm)	in.	(mm)	



R48	.98	(25)	.98-5.12	(25-130)	1.42-5.55	(36-141)	1.42	(36)	2.36-9.84	(060-250)	4.92	(1.50)
R58	1.38	(35)	1.97-7.87	(50-200)	2.60-8.50	(66-216)	1.97	(50)	2.95-9.84	(075-250)	7.55	(2.30)
R68	1.77	(45)	1.97-9.84	(50-250)	2.68-10.55	(68-268)	2.52	(64)	3.94-11.81	(100-300)	8.20	(2.50)



Available from stock. Orders ship as early as today.*

*On average 90% of orders ship the same day..



E2 e-tubes in chip area of a machine tool. Resistant to chips up to +1,562°F with special igumid HT material

Price Index

Series R48

Special Features / Options

ESD classification:
Electrically conductive ESD/
ATEX version upon request



Flammability Class
VDE 0304 IIC UL94 HB

Assembly Tips

To open the e-tube Series R, lift up the lid (with a screwdriver) and remove the lid

Other Installation Methods

Vertical, hanging ≤ 164 ft (50 m)

Vertical, standing ≤ 13.12 ft (4 m)

Side-mounted, un_supp. ≤ 4.92 ft (1.5 m)

Rotary requires further calculation

Usage Guidelines



- If particularly quiet operation is required
- If very high speeds are required
- If chip repellent features are required



- If a particularly low-cost solution is the main factor
➤ **Series R117/R118 E2 tubes**
- If no chip protection is required
➤ **Series 2500 E2/000**

Features & Benefits

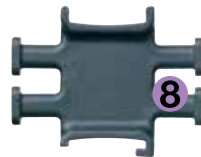
- 1 Large pins for high stability
- 2 Protection for cables and hoses against hot chips
- 3 Removable lids along the outer radius
- 4 Small pitch for low-noise, smooth operation
- 5 KMA mounting brackets with attachment capabilities on all sides
- 6 Smooth, chip-repellent exterior
- 7 Fully enclosed
- 8 Strain relief separator option: Separator with integrated strain relief for use in the first or last chain link ➤ **Strain Relief, Chapter 10**

Order Example: Complete e-chain®

Please indicate chain length or number of links. Example:

3.28 ft (1 m) **48-075-060-0**

e-chain®

With 2 separators **482** assembled every 2nd link

Interior Separation

1 Set **480-075-12**

Mounting Bracket

e-chain system® E2 tubes

Series R48

Installation Dimensions



R48

Short travel, unsupported length

- FL_B = unsupported with permitted sag
 - FL_G = unsupported with straight upper run
- Further information ► Design, Chapter 1

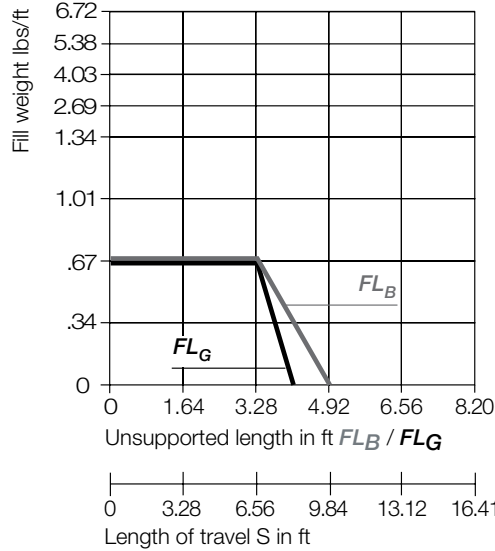
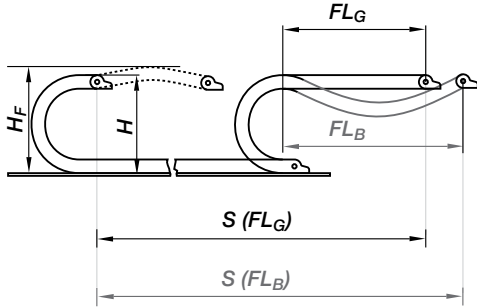

Short Travels - Unsupported

Unsupported e-chains® feature positive camber over short travels. This must be accounted for when specifying the clearance height. Please refer to **Installation dimensions** for further details.

Legend

- S = Length of travel
- R = Bending radius
- H = Nominal clearance height
- D = Overlength e-chain® radius in final position
- $K = \pi \cdot R + \text{safety buffer}$
- $H_f = \text{Required clearance height}$

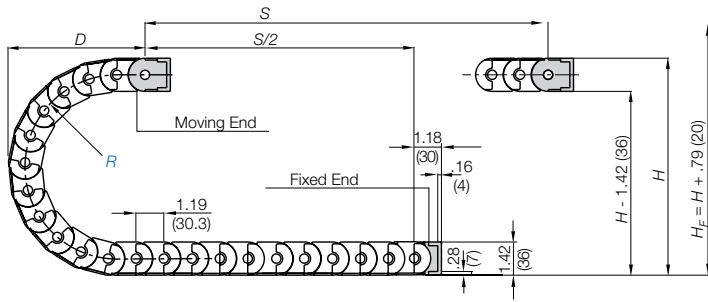

Pitch per link = 1.19" (30.3 mm)
 Links per ft (m) = 10.06 (33)
 For center mount applications:
 Chain length = $\frac{S}{2} + K$

The required clearance height: $H_f = H + .79$ in. (20 mm) (with .34 lbs/ft (0.5 kg/m) fill weight). Please consult igus® if space is particularly restricted.

R	2.36 (060)	2.95 (075)	3.94 (100)	4.92 (125)	5.91 (150)	6.89 (175)	7.87 (200)	9.84 (250)
H	6.14 (156)	7.32 (186)	9.29 (236)	11.26 (286)	13.23 (336)	15.20 (386)	17.17 (436)	21.10 (536)
D	4.84 (123)	5.43 (138)	6.42 (163)	7.40 (188)	8.39 (213)	9.37 (238)	10.35 (263)	12.32 (313)
K	9.84 (250)	11.81 (300)	14.76 (375)	17.91 (455)	21.06 (535)	24.21 (615)	27.17 (690)	33.46 (850)

For long travels with lowered mounting height

Long travel lengths from 16.41 ft. (5 m) to max. 164 ft. (50 m)

For center mount applications:

Chain length = $\frac{S}{2} + K_2$

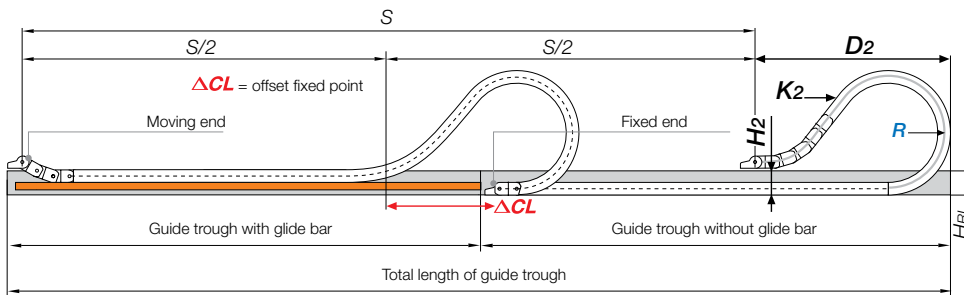

Long Travels - Gliding



If the unsupported length is exceeded, the e-chain®/ Tube must glide on itself. This requires a guide trough.

Design, Chapter 1

R	2.36 (060)	2.95 (075)	3.94 (100)	4.92 (125)	5.91 (150)	6.89 (175)	7.87 (200)	9.84 (250)
H	6.14 (156)	7.32 (186)	6.93 (176)	6.93 (176)	6.93 (176)	6.93 (176)	6.93 (176)	*
D	4.33 (110)	4.92 (125)	12.99 (330)	17.72 (450)	24.02 (610)	28.74 (730)	27.16 (690)	*
K	9.84 (250)	11.81 (300)	21.46 (545)	29.84 (758)	38.19 (970)	45.31 (1151)	46.54 (1182)	*
ΔCL	*	*	6.69 (170)	10.63 (270)	14.96 (380)	18.50 (470)	*	*

Speed / acceleration FL_G	max. 32.8 ft/s (10 m/s) / max. 328 ft/s ² (100 m/s ²)
Speed / acceleration FL_B	max. 9.84 ft/s (3 m/s) / max. 19.69 ft/s ² (6 m/s ²)
Gliding speed / acceleration (maximum)	max. 9.84 ft/s (3 m/s) / max. 32.8 ft/s ² (10 m/s ²)
Material - permitted temperature	igumid G / -40°F (-40°C) up to +248°F (+120°C)
Flammability Class, igumid G	VDE 0304 IIC UL94 HB

Technical Data



Details of material properties

► Chapter 1



PDF: igus.com/e-chain-pdfs
 Product information: igus.com/e-chains



Series R48 - e-tube snap-open along the outer radius

igus®
e-chain system®

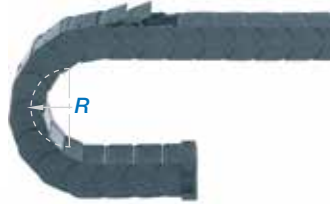
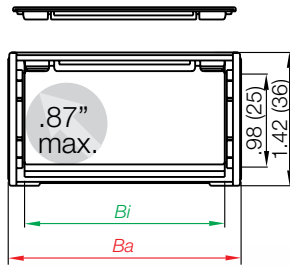

Part Number Structure



- Color - Black
- Bending radius
- Width
- Series

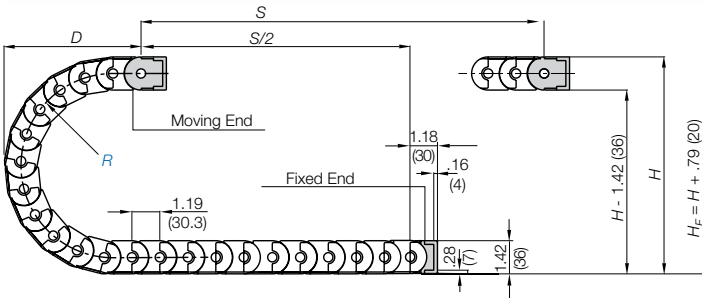

Supplement part number with required radius. Example: R48-100-100-0
Pitch: 1.19 in. (30.3 mm) per link links/ft (m) = 10.06 (33)

Part Number	<i>Bi</i> in. (mm)	<i>Ba</i> in. (mm)	Weight lbs/ft (kg/m)
48-025- <input type="text"/> -0	.98 (25)	1.42 (36)	≈ 0.43 (0.64)
48-050- <input type="text"/> -0	1.97 (50)	2.40 (61)	≈ 0.56 (0.84)
48-075- <input type="text"/> -0	2.95 (75)	3.39 (86)	≈ 0.69 (1.03)
48-100- <input type="text"/> -0	3.94 (100)	4.37 (111)	≈ 0.83 (1.23)
48-130- <input type="text"/> -0	5.12 (130)	5.55 (141)	≈ 0.98 (1.46)

Choose from the radii below for all of the above sizes

Radius (mm) Example: R48-100-100-0

	060	075	100	125	150	175	200	250
R	2.36 (060)	2.95 (075)	3.94 (100)	4.92 (125)	5.91 (150)	6.89 (175)	7.87 (200)	9.84 (250)
H	6.14 (156)	7.32 (186)	9.29 (236)	11.26 (286)	13.23 (336)	15.20 (386)	17.17 (436)	21.10 (536)
D	4.84 (123)	5.43 (138)	6.42 (163)	7.40 (188)	8.39 (213)	9.37 (238)	10.35 (263)	12.32 (313)
K	9.84 (250)	11.81 (300)	14.76 (375)	17.91 (455)	21.06 (535)	24.21 (615)	27.17 (690)	33.46 (850)

Telephone 1-800-521-2747

Internet: igus.com
email: sales@igus.com
QuickSpec: igus.com/quickspec

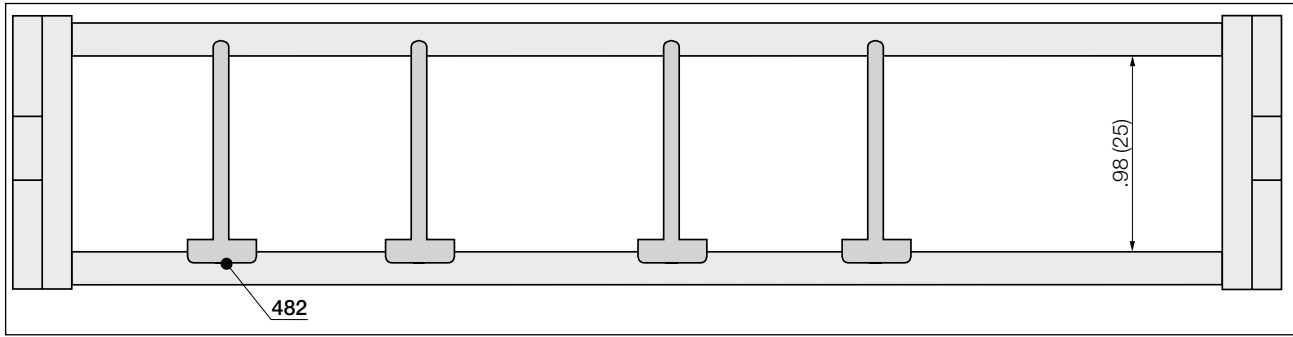

No lateral spacing to side links is necessary.
 In the standard configuration separators are assembled every 2nd e-chain[®] link

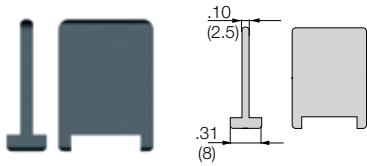

Separator, wide base

Unassembled	Part No. 481
Assembled	Part No. 482

• **Standard separator 481**

Vertical separators are used if a vertical subdivision of the e-tube is required. By standard vertical separators are assembled every other e-tube link.

Separator with integrated strain relief

Strain relief separator Part No. 481-ZR can be integrated into the mounting bracket and can be placed there at any point of the e-tube[®]. It combines strain relief and interior separation, it can be installed on the first or last e-tube[®] link and is easy to assemble without any screws.
 For more information ► **Chapter 10, Strain Relief**



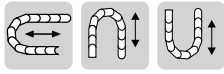

Option 1: Plastic

- Attachment option for strain relief tiewrap plate
- Locked connection to e-tube
- Minimized external width

Moving end
4800...1

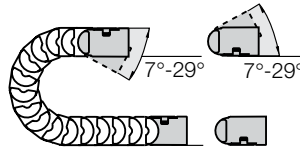

Fixed end
4800...2

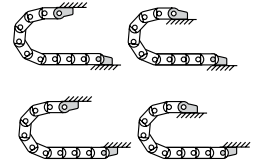

Possible installation configurations -

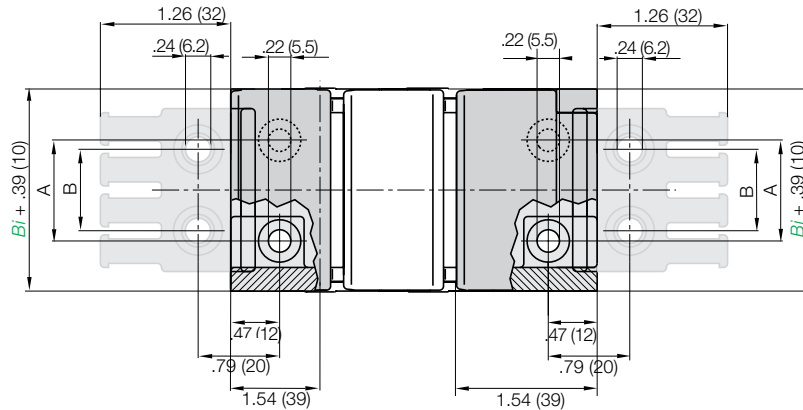

Part Number Structure

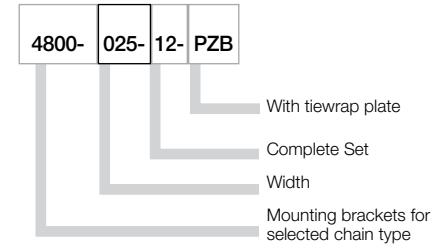

Full set, for both ends:

4800-025-12 Full set, each part with pin/bore

Single-part order:

4800-025-1 Mounting bracket with bore

4800-025-2 Mounting bracket with pin

Part No. Mounting Brackets Full Set
4 parts, 2 with pin, 2 with bore
Series R48:
4800-Width-12

Part No. Mounting bracket with bore
2 parts, 1 left & 1 right
Series R48:
4800-Width -1

Part No. Mounting bracket with pin
2 parts, 1 left & 1 right
Series R48:
4800-Width-2

For Series	Part No. Full Set	Part No. Full Set with Tiewrap Plate	Dimension A in. (mm)	Dimension B in. (mm)	Number of teeth
48-025	4800-025-12	4800-025-12PZB	.47 (12)	.59 (15)	3
48-050	4800-050-12	4800-050-12PZB	1.46 (37)	1.18 (30)	5
48-075	4800-075-12	4800-075-12PZB	2.44 (62)	2.36 (60)	8
48-100	4800-100-12	4800-100-12PZB	3.43 (87)	3.15 (80)	10
48-130	4800-130-12	4800-130-12PZB	4.61 (117)	-	-

The following parts are required for attachment of the mounting brackets:

- Socket head cap bolt M5* DIN 912-8.8
4 pieces/set
- Washer 5.3 DIN 125-ST
8 pieces/set
- Hexagon nut M5 DIN 934-8
4 pieces/set

* The length of the socket head cap bolt is dependent on the thickness of the attachment base.

e-chain system® E2 tubes

Series R48

Mounting Bracket - KMA



R48

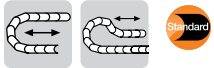

Option 1: KMA pivoting

- Attachment points on all sides
- Corrosion resistant

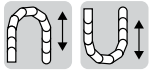
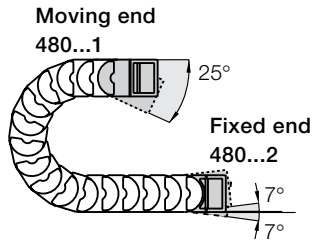

Option 2: KMA locking

- Vertical hanging, standing travel
- Attachment points on all sides
- Corrosion resistant

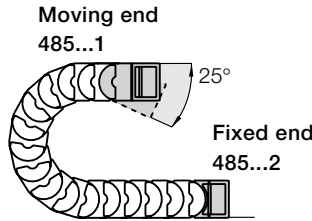

Part Number Structure

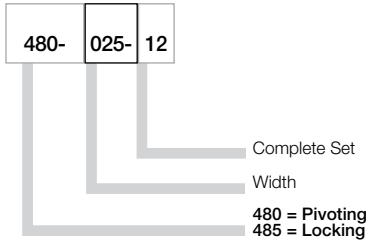

Full set, for both ends:

480- 025- 12 Full set, each part with pin/bore

Single-part order:

- 480- 025- 1 Mounting bracket with bore
- 480- 025- 2 Mounting bracket with pin

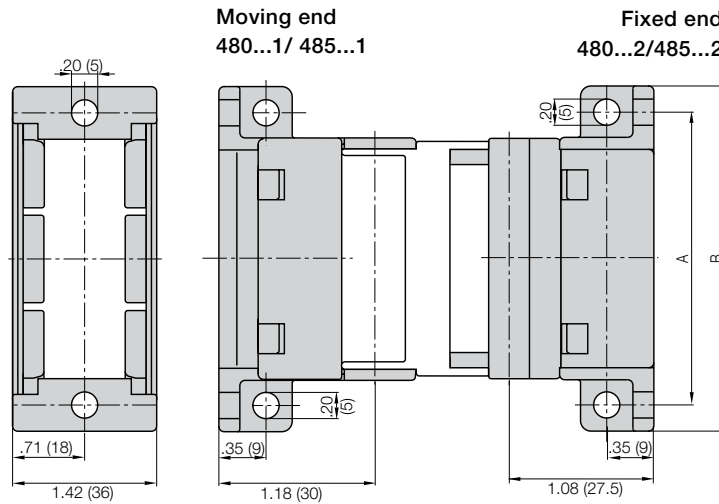

Width	Part No. Full Set			Dimension A		Dimension B	
	Pivoting	Locking		in.	(mm)	in.	(mm)
-025	480	485	-025-12	1.77	(45)	2.17	(55)
-050	480	485	-050-12	2.76	(70)	3.15	(80)
-075	480	485	-075-12	3.74	(95)	4.13	(105)
-100	480	485	-100-12	4.72	(120)	5.12	(130)
-130	480	485	-130-12	5.91	(150)	6.30	(160)

The following parts are required for attachment of the mounting brackets:

- Socket head cap bolt M5* DIN 912-8.8
4 pieces/set
- Washer 5.3 DIN 125-ST
8 pieces/set
- Hexagon nut M5 DIN 934-8
4 pieces/set

* The length of the socket head cap bolt is dependent on the thickness of the attachment base.

PDF: igus.com/e-chain-pdfs
Product information: igus.com/e-chains



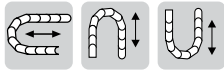

Option 1: Steel

- Locked connection to e-tube
- Electrically conductive
- Minimized external width

Moving end
482...1

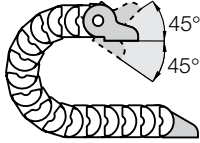

Fixed end
482...2

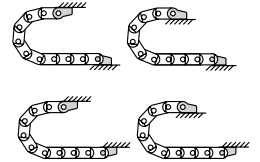

Possible installation configurations -

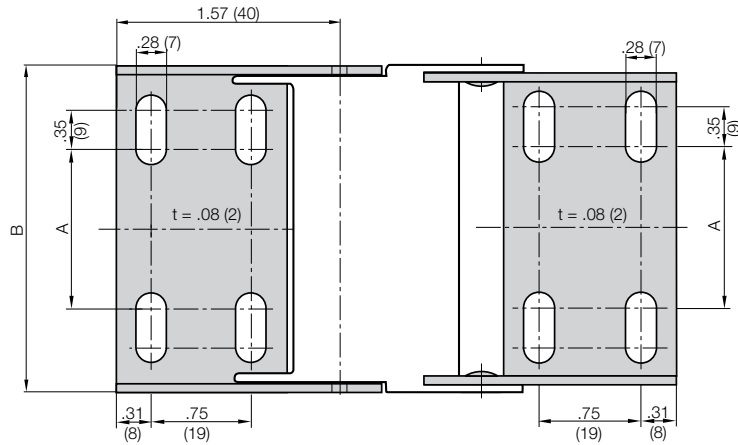

Full set, for both ends:

482- 025- 12 Full set, each part with pin/bore

Single-part order:

482- 025- 1 Mounting bracket with bore

482- 025- 2 Mounting bracket with pin

For Series	Part No. Full Set	Dimension A in. (mm)	Dimension B in. (mm)
48-025	482-025-12	-	1.38 (35)
48-050	482-050-12	.87 (22)	2.36 (60)
48-075	482-075-12	1.85 (47)	3.35 (85)
48-100	482-100-12	2.83 (72)	4.33 (110)
48-130	482-130-12	4.02 (102)	5.51 (140)

Part No. Mounting Brackets Full Set

4 parts, 2 with pin, 2 with bore
Series R48:

482-Width-12

Part No. Mounting bracket with bore

2 parts, 1 left & 1 right
Series R48:

482-Width -1

Part No. Mounting bracket with pin

2 parts, 1 left & 1 right
Series R48:

482-Width-2

The following parts are required for attachment of the mounting brackets:

- Socket head cap bolt M5* DIN 912-8.8
4 pieces/set
- Washer 5.3 DIN 125-ST
8 pieces/set
- Hexagon nut M5 DIN 934-8
4 pieces/set

* The length of the socket head cap bolt is dependent on the thickness of the attachment base.

Tiewrap Plates

Option 1:
Tiewrap plates as an individual part

Available as an individual component that can be fixed external to the mounting bracket.

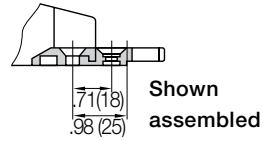

Shown assembled

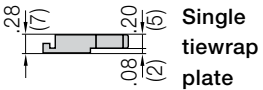

Single tiewrap plate

Tiewrap Plates	n Number of Teeth	Dimension C	Dimension B
2020-ZB	3	1.18 (30)	.59 (15)
2030-ZB	4	1.57 (40)	.79 (20)
2040-ZB	5	1.97 (50)	1.18 (30)
2050-ZB	6	2.36 (60)	1.57 (40)
2070-ZB	8	3.15 (80)	2.36 (60)
2090-ZB	9	3.54 (90)	2.76 (70)
2100-ZB	10	3.94 (100)	3.15 (80)
2120-ZB	12	4.72 (120)	3.94 (100)

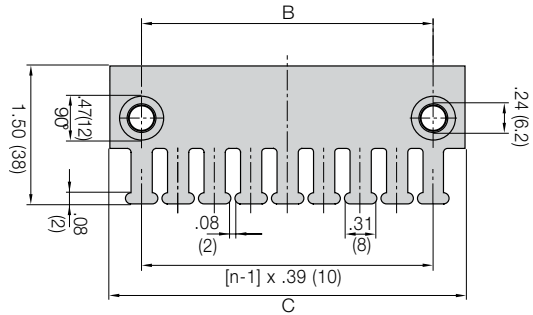

For more information please refer to strain relief section of Chapter 10



Cable tiewraps as individual parts

Cable tiewraps 100 pieces/bag	Width x Length		Maximum Ø		Tensile Strength	
	in.	(mm)	in.	(mm)	lbs	(N)
CFB-001	.19 x 5.91	(4.8 x 150)	1.42	(36)	50	(222)



Price Index

Series R58

Special Features / Options

ESD classification:
Electrically conductive ESD/
ATEX version upon request



Flammability Class
VDE 0304 IIC UL94 HB

Assembly Tips

To open the e-tube Series R, lift up the lid (with a screwdriver) and remove the lid

Other Installation Methods

Vertical, hanging ≤ 164 ft (50 m)

Vertical, standing ≤ 13.12 ft (4 m)

Side-mounted, un supp. ≤ 6.56 ft (2 m)

Rotary requires further calculation

Usage Guidelines



- If particularly quiet operation is required
- If very high speeds are required
- If chip protection is subject to stringent requirements



- If a particularly low-cost solution is the main factor
 - **Series R157/R158 E2 tubes**
- If no chip protection is required
 - **Series 2500 E2/000**

Features & Benefits

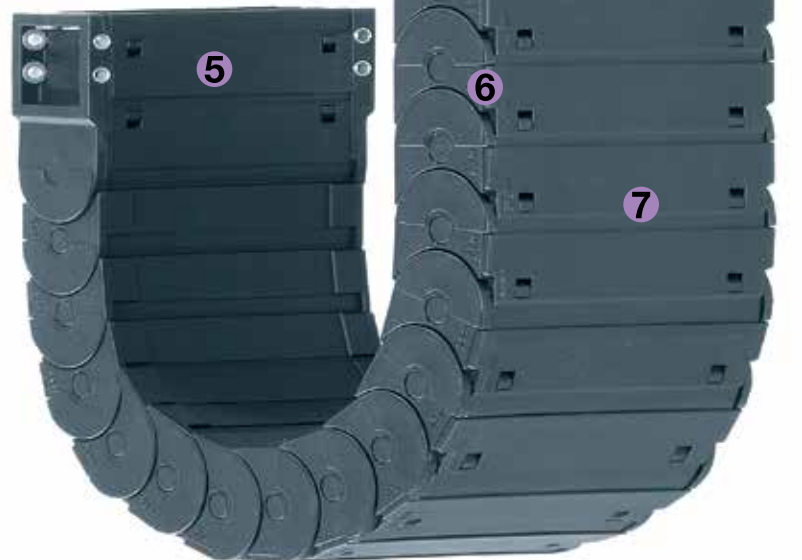
- 1 Protection for cables and hoses against hot chips
- 2 Large pins for high stability
- 3 Removable lids along the outer radius
- 4 Small pitch - low-noise, smooth operation, very small radii
- 5 KMA mounting brackets with attachment capabilities on all sides
- 6 Smooth, chip-repellent exterior
- 7 Fully enclosed
- 8 Integrated strain relief available especially for e-tubes

Order Example: Complete e-chain®

Please indicate chain length or number of links. Example:

3.28 ft (1 m) **58-100-100-0**

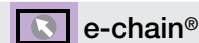

e-chain®

With 2 separators **582** assembled every 2nd link



Interior Separation

1 Set **580-100-12**



Mounting Bracket

e-chain system® E2 tubes

Series R58

Installation Dimensions

Short travel, unsupported length

- FL_B = unsupported with permitted sag
 - FL_G = unsupported with straight upper run
- Further information ► Design, Chapter 1

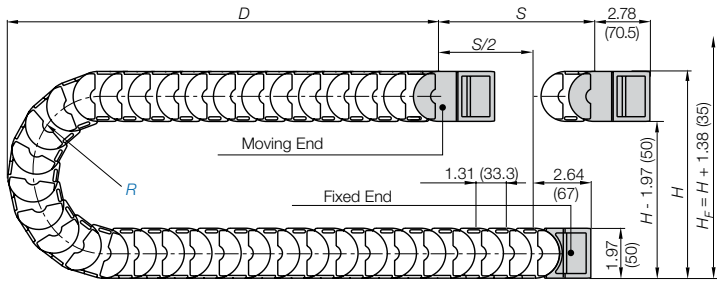
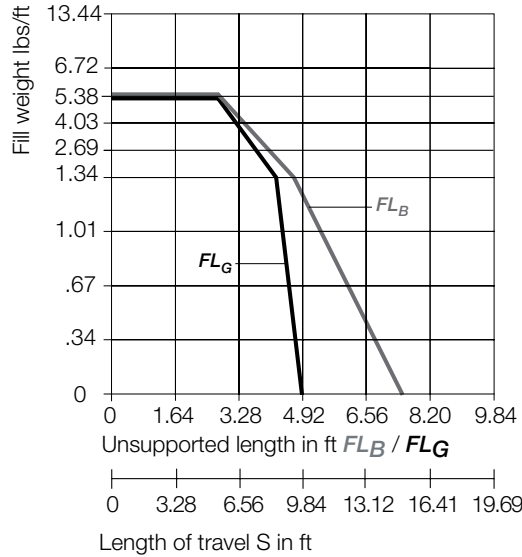
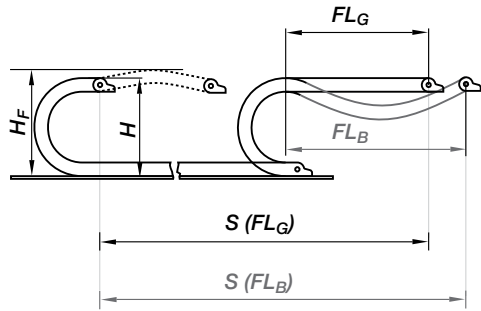

Pitch per link = 1.31" (33.3 mm)
 Links per ft (m) = 9.14 (30)
 For center mount applications:
 Chain length = $\frac{S}{2} + K$

The required clearance height: $H_F = H + 1.38$ in. (35 mm) (with .34 lbs/ft (0.5 kg/m) fill weight). Please consult igus® if space is particularly restricted.

R	2.95 (075)	3.94 (100)	4.92 (125)	5.91 (150)	7.87 (200)	9.84 (250)
H	7.87 (200)	9.84 (250)	11.81 (300)	13.78 (350)	17.72 (450)	21.65 (550)
D	5.91 (150)	6.89 (175)	7.87 (200)	8.86 (225)	10.83 (275)	12.80 (325)
K	12.96 (305)	15.16 (385)	18.11 (460)	21.26 (540)	27.36 (695)	33.66 (855)



R58

Short Travels - Unsupported



Unsupported e-chains® feature positive camber over short travels. This must be accounted for when specifying the clearance height. Please refer to Installation dimensions for further details.

Legend

- S = Length of travel
- R = Bending radius
- H = Nominal clearance height
- D = Overlength e-chain® radius in final position
- $K = \pi \cdot R + \text{safety buffer}$
- H_F = Required clearance height
- H_{R1} = Trough inner height
- H_2 = *Mounting height
- D_2 = Overlength - long travels, gliding
- K_2 = *Add-on

*If the mounting bracket location is set lower

For long travels with lowered mounting height

Long travel lengths from 32.8 ft. (10 m) to max. 246 ft. (75 m)

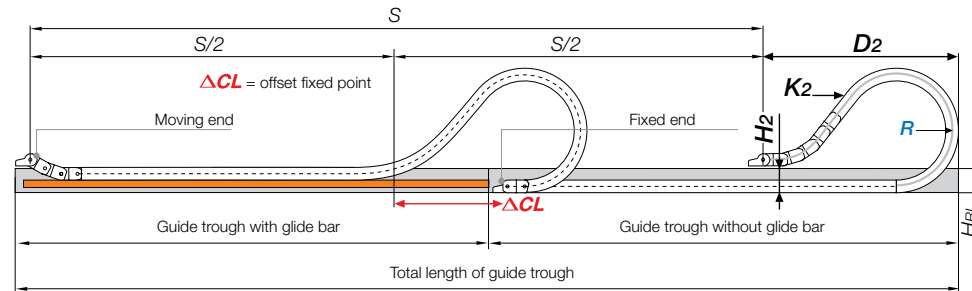

For center mount applications:
 Chain length = $\frac{S}{2} + K_2$

Long Travels - Gliding



If the unsupported length is exceeded, the e-chain®/ Tube must glide on itself. This requires a guide trough.

Design, Chapter 1

R	2.95 (075)	3.94 (100)	4.92 (125)	5.91 (150)	7.87 (200)	9.84 (250)
H_2	5.91 (150)	6.54 (166)	6.54 (166)	6.54 (166)	6.54 (166)	6.54 (166)
D_2	5.91 (150)	12.20 (310)	14.96 (380)	18.90 (480)	31.50 (800)	41.34 (1050)
K_2	14.76 (375)	19.69 (500)	27.52 (699)	34.09 (866)	49.80 (1265)	65.55 (1665)
ΔCL	—	4.80 (122)	6.57 (167)	9.72 (247)	20.16 (512)	28.23 (717)

Speed / acceleration FL_G	max. 32.8 ft/s (10 m/s) / max. 328 ft/s ² (100 m/s ²)
Speed / acceleration FL_B	max. 9.84 ft/s (3 m/s) / max. 19.69 ft/s ² (6 m/s ²)
Gliding speed / acceleration (maximum)	max. 9.84 ft/s (3 m/s) / max. 32.8 ft/s ² (10 m/s ²)
Material - permitted temperature	igumid G / -40°F (-40°C) up to +248°F (+120° C)
Flammability Class, igumid G	VDE 0304 IIC UL94 HB

Technical Data



Details of material properties

► Chapter 1

PDF: igus.com/e-chain-pdfs
 Product information: igus.com/e-chains



Series R58 - e-tube snap-open along the outer radius

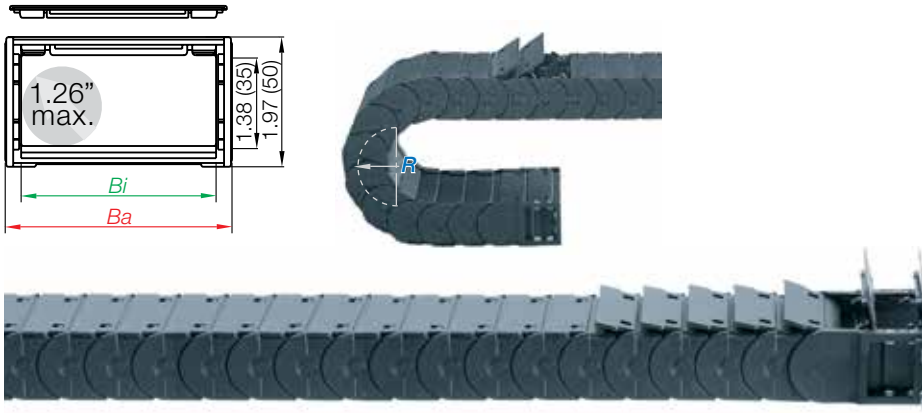

Part Number Structure

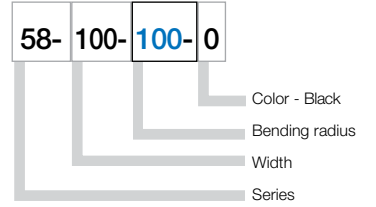

Telephone 1-800-521-2747

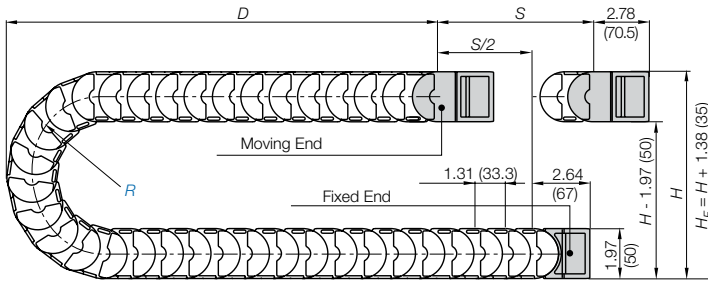

Supplement part number with required radius. Example: R58-100--0
Pitch: 1.31 in. (33.3 mm) per link links/ft (m) = 9.14 (30)

Part Number		Bi in. (mm)	Ba in. (mm)	Weight lbs/ft (kg/m)
58-050-	<input type="text" value=""/>	1.97 (50)	2.60 (66)	≈ 1.01 (1.50)
58-075-	<input type="text" value=""/>	2.95 (75)	3.58 (91)	≈ 1.19 (1.77)
58-100-	<input type="text" value=""/>	3.94 (100)	4.57 (116)	≈ 1.37 (2.04)
58-125-	<input type="text" value=""/>	4.92 (125)	5.55 (141)	≈ 1.55 (2.31)
58-150-	<input type="text" value=""/>	5.91 (150)	6.54 (166)	≈ 1.75 (2.61)
58-175-	<input type="text" value=""/>	6.89 (175)	7.52 (191)	≈ 1.94 (2.88)
58-200-	<input type="text" value=""/>	7.87 (200)	8.50 (216)	≈ 2.12 (3.15)

Choose from the radii below for all of the above sizes
Radius (mm) Example: R58-100--0

	<input type="text" value="075"/>	<input type="text" value="100"/>	<input type="text" value="125"/>	<input type="text" value="150"/>	<input type="text" value="200"/>	<input type="text" value="250"/>
R	2.95 (75)	3.94 (100)	4.92 (125)	5.91 (150)	7.87 (200)	9.84 (250)
H	7.87 (200)	9.84 (250)	11.81 (300)	13.78 (350)	17.72 (450)	21.65 (550)
D	5.91 (150)	6.89 (175)	7.87 (200)	8.86 (225)	10.83 (275)	12.80 (325)
K	12.96 (305)	15.16 (385)	18.11 (460)	21.26 (540)	27.36 (695)	33.66 (855)

Internet: igus.com
email: sales@igus.com
QuickSpec: igus.com/quickspec

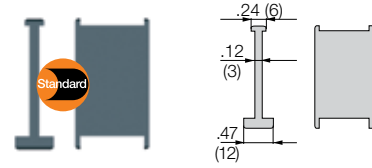
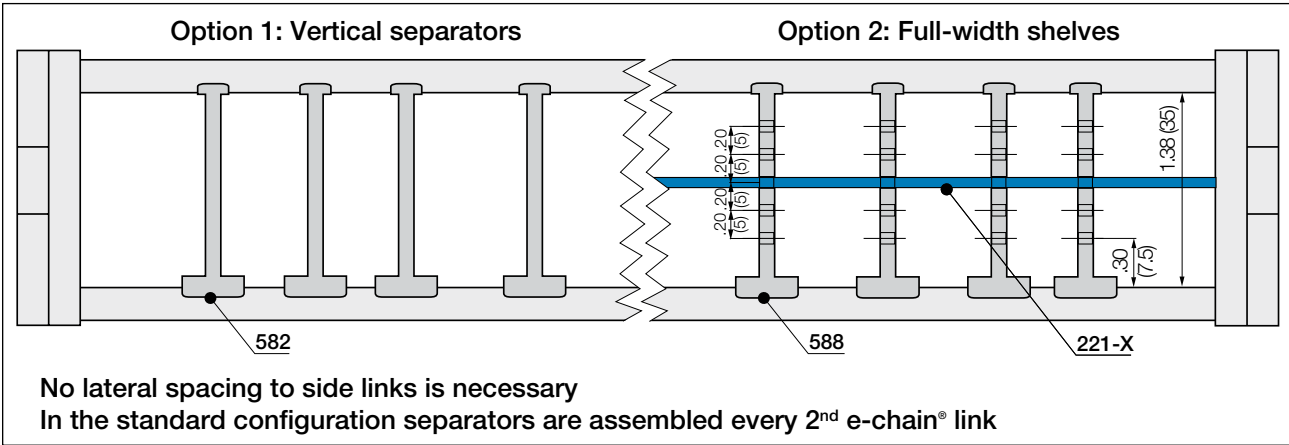

Separator for e-tubes

Unassembled	Part No. 581
Assembled	Part No. 582

- **Separator 581**
 For vertical separation with wide base for maximum stability when used with thick cables or hoses

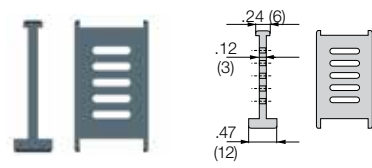

Slotted Separator for e-tubes

Unassembled	Part No. 587
Assembled	Part No. 588

- **Separator 587**
 is used when vertical and horizontal separation is required. Due to its slot, it allows basic vertical/horizontal shelving arrangements.

Full-width shelves - for the standard interior separation

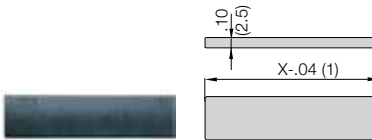

Full width shelf for e-tubes

Unassembled	Part No. 220-X
Assembled	Part No. 221-X

- **Full width shelf 220-X**
 is used in applications with many thin cables with similar diameters. Full-width shelves can be arranged at 5 different heights in .20" (5mm) increments..

Width X	Part No.	Part No.	Width X	Part No.	Part No.	Width X	Part No.	Part No.
in. (mm)	Unassembled	Assembled	in. (mm)	Unassembled	Assembled	in. (mm)	Unassembled	Assembled
1.97 (50)	220-50	221-50	4.92 (125)	220-125	221-125	7.87 (200)	220-200	221-200
2.95 (75)	220-75	221-75	5.91 (150)	220-150	221-150			
3.94 (100)	220-100	221-100	6.89 (175)	220-175	221-175			

PDF: igus.com/e-chain-pdfs
 Product information: igus.com/e-chains

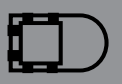

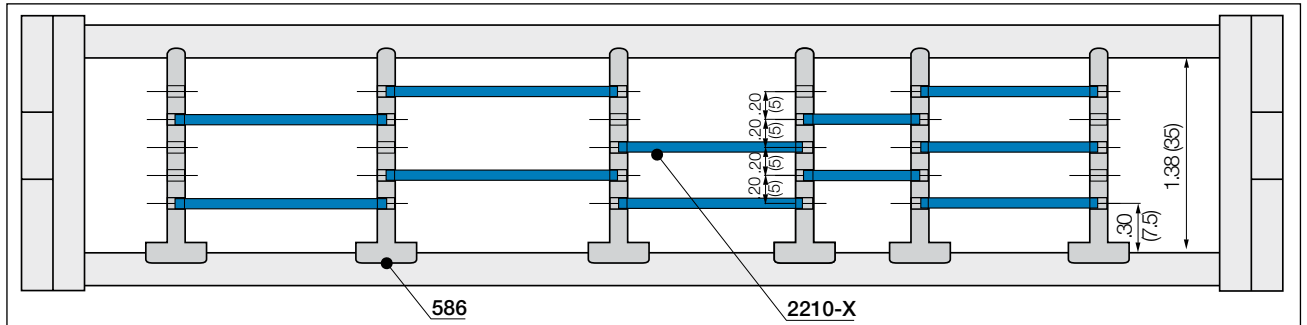

No lateral spacing to side links is necessary
In the standard configuration separators are assembled every 2nd e-chain® link

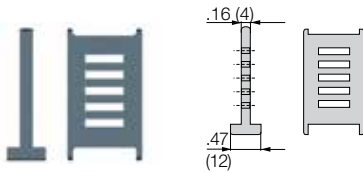

Separator, narrow base

Unassembled	Part No. 585
Assembled	Part No. 586

- **Slotted separator 585**
is used when vertical and horizontal separation is required. Due to its slot, it allows basic vertical/horizontal shelving arrangements.

Full-width shelves - for the standard interior separation

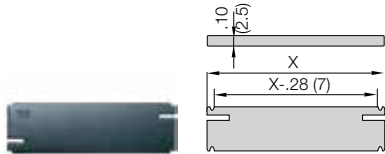

Full width shelf

Unassembled	Part No. 2200-X
Assembled	Part No. 2210-X

- **Full width shelf 2200-X**
For applications involving many cables with different diameters, shelves can be arranged at alternate heights. They can be arranged at 5 different heights in .20" (5mm) increments.

Width X in. (mm)	Part No. Unassembled	Part No. Assembled	Width X in. (mm)	Part No. Unassembled	Part No. Assembled	Width X in. (mm)	Part No. Unassembled	Part No. Assembled
.71 (18)	2200-18	2210-18	1.69 (43)	2200-43	2210-43	3.46 (88)	2200-88	2210-88
.91 (23)	2200-23	2210-23	1.89 (48)	2200-48	2210-48	3.90 (99)	2200-99	2210-99
1.10 (28)	2200-28	2210-28	2.28 (58)	2200-58	2210-58	4.88 (124)	2200-124	2210-124
1.30 (33)	2200-33	2210-33	2.68 (68)	2200-68	2210-68	5.87 (149)	2200-149	2210-149
1.50 (38)	2200-38	2210-38	2.87 (73)	2200-73	2210-73			

e-chain system® E2 tubes

Series R58

Mounting Brackets - KMA



R58

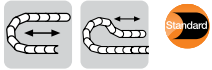

Option 1: pivoting

- Unsupported and gliding applications
- Space-restricted conditions
- Mounting points on all sides
- KMA with Quickflange option available for short and long travels

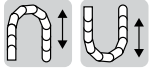

Option 2: locking

- Vertical hanging/standing travels
- Extreme speeds and accelerations
- Mounting points on all sides
- Flush mounting at both ends of the e-tube
- KMA with Quickflange option



Part Number Structure

580-050-12 QF

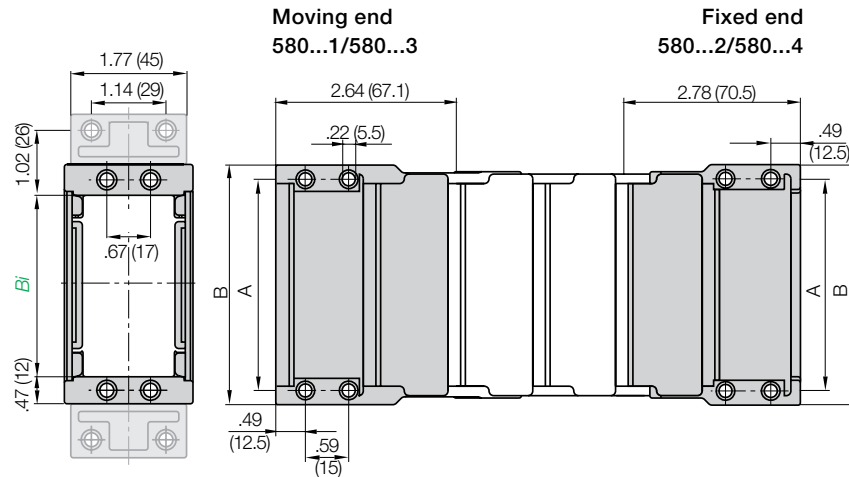
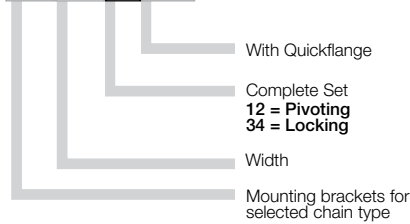

Full set, for both ends:

580-050-12 QF Full set, each part with pin/bore + Quickflange

Single-part order:

580-050-1 QF Mounting bracket with bore + Quickflange

580-050-2 QF Mounting bracket with pin + Quickflange



Quickflange upon request
• Unassembled

For Tube Type	Part No. Full set without Quickflange	Part No. Full Set with Quickflange	Dimension A in. (mm)	Dimension B in. (mm)
58-050	580-050-□	580-050-□ QF	2.44 (62)	2.91 (74)
58-075	580-075-□	580-075-□ QF	3.43 (87)	3.90 (99)
58-100	580-100-□	580-100-□ QF	4.41 (112)	4.88 (124)
58-125	580-125-□	580-125-□ QF	5.39 (137)	5.87 (149)
58-150	580-150-□	580-150-□ QF	6.38 (162)	6.85 (174)
58-175	580-175-□	580-175-□ QF	7.36 (187)	7.83 (199)
58-200	580-200-□	580-200-□ QF	8.35 (212)	8.82 (224)

For pivoting brackets choose **12**
For locking brackets choose **34**
Example: 580-050-**34** QF

The following parts are required for attachment of the mounting brackets:

- Socket head cap bolt M5* DIN 912-8.8
8 pieces/set
- Washer 5.3 DIN 125-ST
8 pieces/set
- Hexagon nut M5 DIN 934-8
8 pieces/set

* The length of the socket head cap bolt is dependent on the thickness of the attachment base.

PDF: igus.com/e-chain-pdfs
Product information: igus.com/e-chains





- Strain relief disappears completely within the e-tube
- Easy to assemble, no screws required

Part. No.	Width (mm)	Number of teeth
5850-Z	1.81 (46)	4

Number of tiewrap plates 5850-Z for selected inner width *Bi*

<i>Bi</i> in. (mm)	Width tiewrap plate in. (mm)	Number of tiewrap plates <i>n</i>	Total number of teeth
1.97 (50)	–	–	–
2.95 (75)	1.81 (46)	1	4
3.94 (100)	1.81 (46)	1	4
4.92 (125)	1.81 (46)	2	8
5.91 (150)	1.81 (46)	2	8
6.89 (175)	1.81 (46)	3	12
7.87 (200)	1.81 (46)	3	12

e-chain® E2 tubes

Series R58

Guide Trough



R58

Guide troughs are used with applications where the upper run of the e-chain® glides on the lower run. If using igus® steel guide troughs, the following components are required:

- Full travel length of guide trough
Part number 95-30
- 1/2 travel length glide bars
Part number 92-01
- Installation sets as end connectors
Part number 95-50-XX

-XX indicates the length of the profile rails on which the guide trough is mounted. The values and part numbers are specified in the table on the right. The standard length of the trough components and glide bars is 6.56 ft (2 m). The required overall length of the guide trough directly correlates to the length of travel.

Example:

Length of travel 164 ft (50 m)
Center mounted

Required guide troughs:

164 ft (50 m) guide trough without glide bar
82 ft (25 m) glide bar
= 25 sections of 6.56 ft (2 m) guide trough

Part No. 95-30

= 13 sections of 6.56 ft (2 m) glide bar

Part No. 92-01

Required number of installation sets:

= Number of guide trough components + 1
= 25 + 1 = 26

Part number of the installation sets

95-50-XXX

Example:

95-50-250 for 9.84" (250 mm) long profile rail.



Width of Crossbar
58-075-200-0

	B_{Ri}	Part No. Installation Set
-050	2.80 (71)	95-50-200
-075	3.78 (96)	95-50-225
-100	4.76 (121)	95-50-250
-125	5.75 (146)	95-50-275
-150	6.73 (171)	95-50-300
-175	7.72 (196)	95-50-325
-200	8.70 (221)	95-50-350

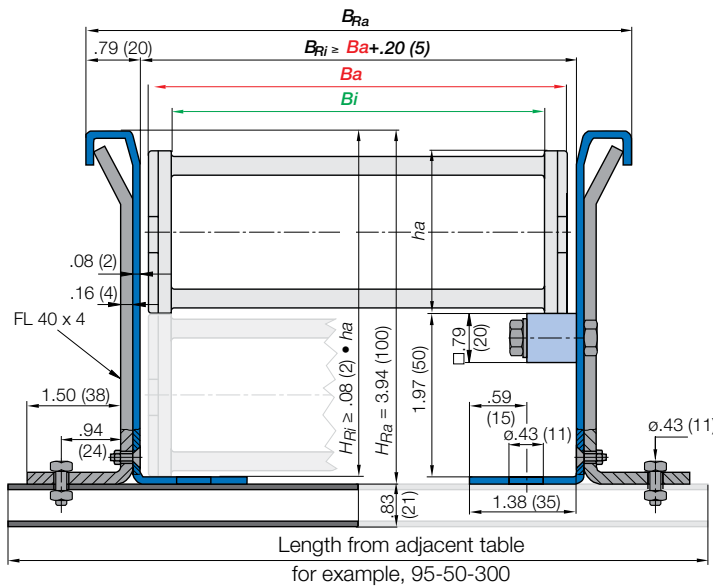

- Guide trough
- Glide bars
- Installation set "Basic"
- C-profile rail

Individual attachment without profile rail

Standard length profile rail

* Specialized guide trough available upon request

PDF: igus.com/e-chain-pdfs
Product information: igus.com/e-chains



Price Index

Series R68

Special Features / Options

ESD classification:
Electrically conductive ESD/
ATEX version upon request



Flammability Class
VDE 0304 IIC UL94 HB



iF-Design Award Winner

Assembly Tips

To open the e-tube Series R, lift up the lid (with a screwdriver) and remove the lid

Other Installation Methods

Vertical, hanging ≤ 197 ft (60 m)

Vertical, standing ≤ 13.12 ft (4 m)

Side-mounted, un supp. ≤ 6.56 ft (2 m)

Rotary requires further calculation

Usage Guidelines

- If particularly quiet operation is required
- If very high speeds are required
- If chip protection is subject to stringent requirements



- If a particularly low-cost solution is the main factor
 - **Series R167/R168 E2 tubes**
- If no chip protection is required
 - **Series 3500 E2/000**

Features & Benefits

- 1 Large pins for high stability
- 2 Protection for cables and hoses against hot chips
- 3 Small pitch for low-noise, smooth operation
- 4 Removable lids along the outer radius
- 5 Smooth, chip-repellent exterior
- 6 KMA mounting brackets with attachment capabilities on all sides
- 7 Fully enclosed
- 8 Integrated strain relief available especially for e-tubes

Order Example: Complete e-chain®

Please indicate chain length or number of links. Example:

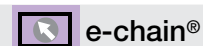
3.28 ft (1 m) **68-100-100-0**

e-chain®

With 2 separators **311** assembled every 2nd link

Interior Separation

1 Set **680-100-12**

Mounting Bracket

e-chain system® E2 tubes

Series R68

Installation Dimensions



R68

Short travel, unsupported length

- FL_B = unsupported with permitted sag
 - FL_G = unsupported with straight upper run
- Further information ► Design, Chapter 1

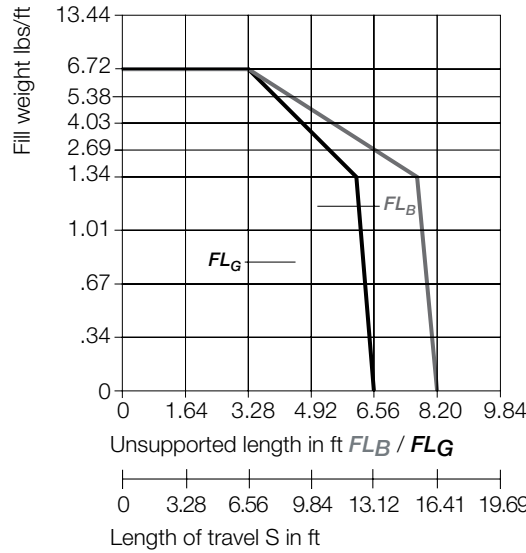
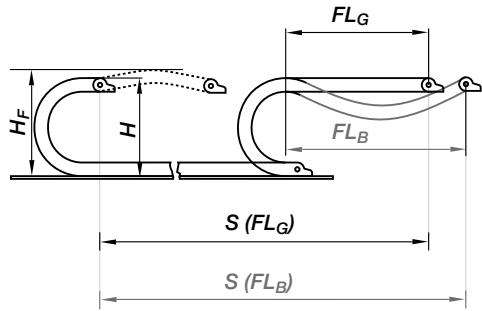

Short Travels - Unsupported

Unsupported e-chains® feature positive camber over short travels. This must be accounted for when specifying the clearance height. Please refer to **Installation dimensions** for further details.

Legend

- S = Length of travel
- R = Bending radius
- H = Nominal clearance height
- D = Overlength e-chain® radius in final position
- $K = \pi \cdot R + \text{safety buffer}$
- H_f = Required clearance height
- H_{R1} = Trough inner height
- H_2 = *Mounting height
- D_2 = Overlength - long travels, gliding
- K_2 = *Add-on

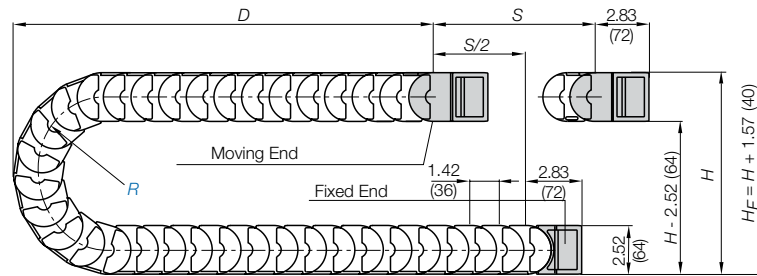

Pitch per link = 1.42" (36 mm)
 Links per foot (m) = 8.53 (28)
 For center mount applications:
 Chain length = $\frac{S}{2} + K$

The required clearance height: $H_f = H + 1.57$ in. (40 mm) (with 1.68 lbs/ft (2.5 kg/m) fill weight. Please consult igus® if space is particularly restricted.

R	3.94 (100)	4.92 (125)	5.91 (150)	6.89 (175)	7.87 (200)	8.86 (225)	9.84 (250)	11.81 (300)
H	10.39 (264)	12.36 (314)	14.33 (364)	16.30 (414)	18.27 (464)	20.24 (514)	22.20 (564)	26.14 (664)
D	7.32 (186)	8.31 (211)	9.29 (236)	10.28 (261)	11.26 (286)	12.24 (311)	13.23 (336)	15.20 (386)
K	15.35 (390)	18.31 (465)	21.46 (545)	24.60 (625)	27.76 (705)	30.71 (780)	33.86 (860)	39.96 (1015)

*If the mounting bracket location is set lower

For long travels with lowered mounting height

Long travel lengths from 32.8 ft. (10 m) to max. 328 ft. (100 m)

For center mount applications:
 Chain length = $\frac{S}{2} + K_2$

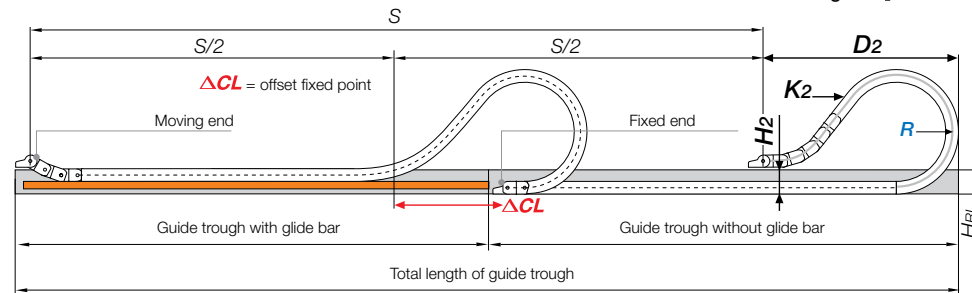

Long Travels - Gliding

If the unsupported length is exceeded, the e-chain®/ Tube must glide on itself. This requires a guide trough. **Design, Chapter 1**

R	3.94 (100)	4.92 (125)	5.91 (150)	6.89 (175)	7.87 (200)	8.86 (225)	9.84 (250)	11.81 (300)
H_2	7.91 (201)	8.66 (220)	8.66 (220)	8.66 (220)	8.66 (220)	8.66 (220)	8.66 (220)	8.66 (220)
D_2	7.87 (200)	14.57 (370)	17.32 (440)	21.26 (540)	25.59 (650)	27.56 (700)	33.46 (850)	41.34 (1050)
K_2	19.69 (500)	25.51 (648)	31.18 (792)	35.43 (900)	43.94 (1116)	49.96 (1269)	58.11 (1476)	70.87 (1800)
ΔCL	—	6.46 (164)	8.03 (204)	11.57 (294)	14.33 (364)	17.28 (439)	20.24 (514)	26.14 (664)

Speed / acceleration FL_G	max. 32.8 ft/s (10 m/s) / max. 328 ft/s ² (100 m/s ²)
Speed / acceleration FL_B	max. 9.84 ft/s (3 m/s) / max. 19.69 ft/s ² (6 m/s ²)
Gliding speed / acceleration (maximum)	max. 9.84 ft/s (3 m/s) / max. 32.8 ft/s ² (10 m/s ²)
Material - permitted temperature	igumid G / -40°F (-40°C) up to +248°F (+120° C)
Flammability Class, igumid G	VDE 0304 IIC UL94 HB

Technical Data



Details of material properties

► Chapter 1

PDF: igus.com/e-chain-pdfs
 Product information: igus.com/e-chains



Series R68 - e-tube snap-open along the outer radius

igus®
e-chain system®

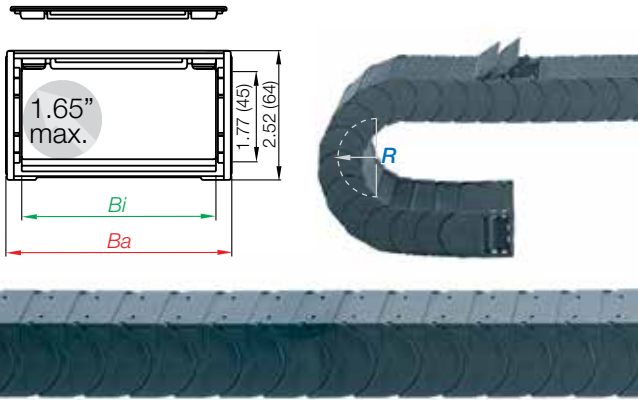

Part Number Structure

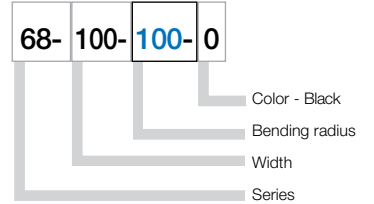

Telephone 1-800-521-2747

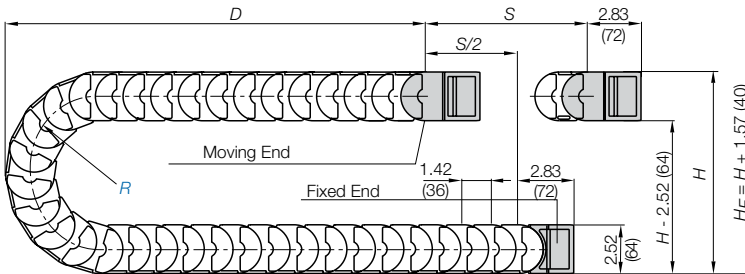

Supplement part number with required radius. Example: R68-100--0
Pitch: 1.42 in. (36 mm) per link links/ft (m) = 8.53 (28)

Part Number	<i>Bi</i> in. (mm)	<i>Ba</i> in. (mm)	Weight lbs/ft (kg/m)
68-050- <input type="text" value=""/> -0	1.97 (50)	2.68 (68)	≈ 1.28 (1.90)
68-075- <input type="text" value=""/> -0	2.95 (75)	3.66 (93)	≈ 1.46 (2.18)
68-100- <input type="text" value=""/> -0	3.94 (100)	4.65 (118)	≈ 1.65 (2.46)
68-115- <input type="text" value=""/> -0	4.53 (115)	5.24 (133)	≈ 1.77 (2.63)
68-125- <input type="text" value=""/> -0	4.92 (125)	5.63 (143)	≈ 1.86 (2.77)
68-150- <input type="text" value=""/> -0	5.91 (150)	6.61 (168)	≈ 2.05 (3.05)
68-175- <input type="text" value=""/> -0	6.89 (175)	7.60 (193)	≈ 2.26 (3.36)
68-200- <input type="text" value=""/> -0	7.87 (200)	8.58 (218)	≈ 2.45 (3.64)
68-225- <input type="text" value=""/> -0	8.86 (225)	9.57 (243)	≈ 2.63 (3.92)
68-250- <input type="text" value=""/> -0	9.84 (250)	10.55 (268)	≈ 2.84 (4.23)

Choose from the radii below for all of the above sizes

Radius (mm) Example: R68-100--0

	100	125	150	175	200	225	250	300
R	3.94 (100)	4.92 (125)	5.91 (150)	6.89 (175)	7.87 (200)	8.86 (225)	9.84 (250)	11.81 (300)
H	10.39 (264)	12.36 (314)	14.33 (364)	16.30 (414)	18.27 (464)	20.24 (514)	22.20 (564)	26.14 (664)
D	7.32 (186)	8.31 (211)	9.29 (236)	10.28 (261)	11.26 (286)	12.24 (311)	13.23 (336)	15.20 (386)
K	15.35 (390)	18.31 (465)	21.46 (545)	24.60 (625)	27.76 (705)	30.71 (780)	33.86 (860)	39.96 (1015)

Separator with integrated strain relief

Strain relief separator Part No. 34501-Z can be integrated into the mounting bracket and can be placed there at any point of the e-chain®. It combines strain relief and interior separation, it can be installed on the first or last e-chain® link and is easy to assemble without any screws.



For more information ► Chapter 10, Strain Relief

Internet: igus.com
email: sales@igus.com
QuickSpec: igus.com/quickspec

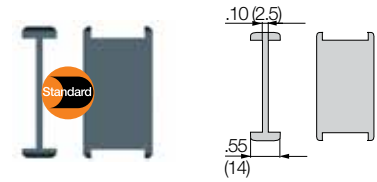
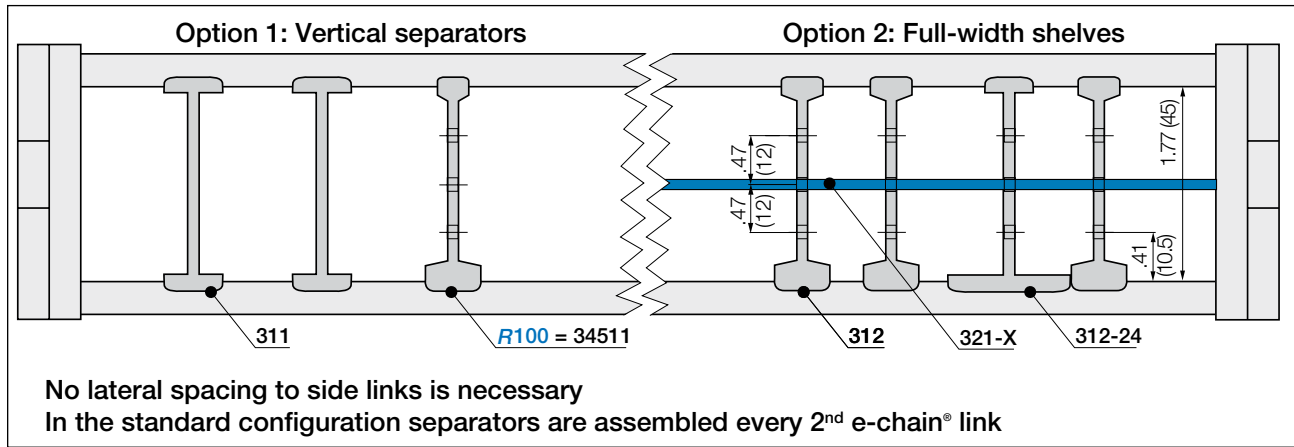

Separator for e-tubes

Unassembled	Part No. 301
Assembled	Part No. 311

- **Separator 301**
For vertical separation with wide base for maximum stability when used with thick cables or hoses

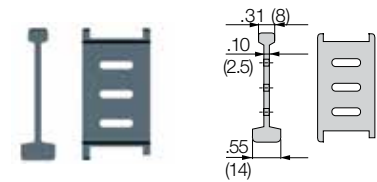

Slotted Separator for e-tubes (for radius R 100)

Unassembled	Part No. 34501
Assembled	Part No. 34511

- **Separator 34501 (for radius R 100)**
if you select bending radius R 100 please use this separator for a vertical subdivision.

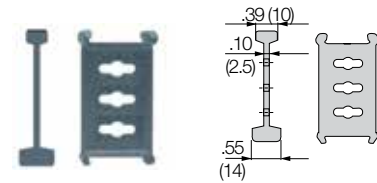

Slotted Separator for e-tubes

Unassembled	Part No. 302
Assembled	Part No. 312

- **Separator 302**
is used when vertical separation is required. Due to its slot, it allows basic vertical/horizontal shelving arrangements.

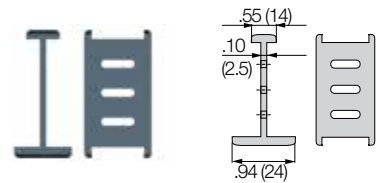

Slotted Separator with wide base* for e-tubes

Unassembled	Part No. 302-24
Assembled	Part No. 312-24

- **Separator 302-24**
If a wide space between the separators must be maintained or separators must be in a fixed position. Features a wide base. *(for side mounted applications).

Full-width shelves - for the standard interior separation

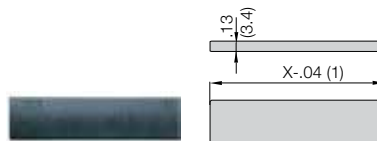

Full width shelf for e-tubes

Unassembled	Part No. 320-X
Assembled	Part No. 321-X

- **Full width shelf 320-X**
is used in applications with many thin cables with similar diameters. Full-width shelves can be arranged at 5 different heights in .20" (5mm) increments..

Width X	Part No.	Part No.	Width X	Part No.	Part No.	Width X	Part No.	Part No.
in. (mm)	Unassembled	Assembled	in. (mm)	Unassembled	Assembled	in. (mm)	Unassembled	Assembled
1.97 (50)	320-50	321-50	4.92 (125)	320-125	321-125	7.87 (200)	320-200	321-200
2.95 (75)	320-75	321-75	5.91 (150)	320-150	321-150	8.86 (225)	320-225	321-225
4.53 (115)	320-115	321-115	6.89 (175)	320-175	321-175	9.84 (250)	320-250	321-250



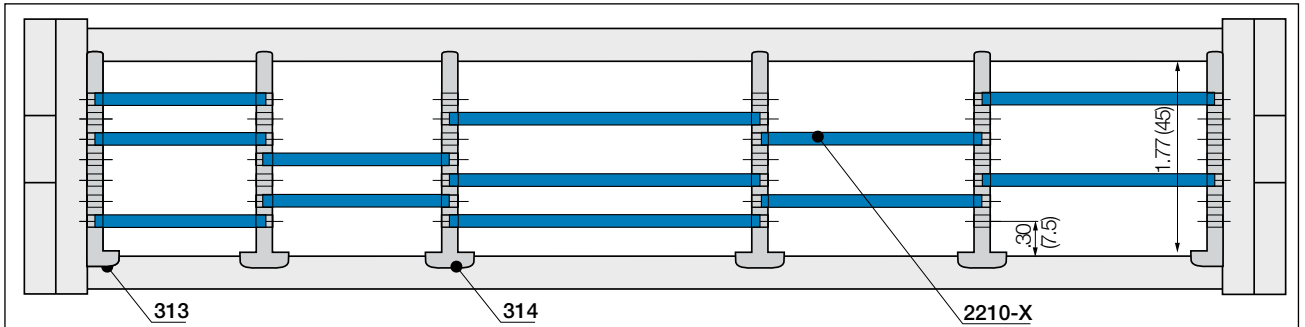

No lateral spacing to side links is necessary
In the standard configuration separators are assembled every 2nd e-chain® link

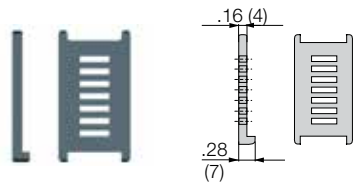

Separator, narrow base

Unassembled	Part No. 303
Assembled	Part No. 313

• **Side plate 303**

Side plate for use with full-width shelf 2200-X and middle plate 304

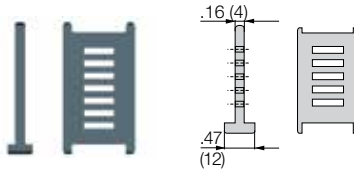

Separator, narrow base

Unassembled	Part No. 304
Assembled	Part No. 314

• **Middle plate 304**

To achieve a modular interior separation the shelf 2200-X can be arranged at 7 different heights in .20" (5mm) increments.

Full-width shelves - for the standard interior separation

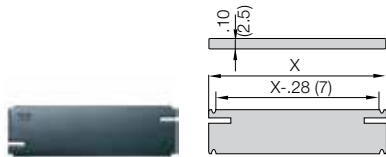

Full width shelf, lockable

Unassembled	Part No. 2200-X
Assembled	Part No. 2210-X

• **Full width shelf 2200-X**

For applications involving many cables with different diameters, shelves can be arranged at alternate heights. They can be arranged at 7 different heights in .20" (5mm) increments.

Width X in. (mm)	Part No. Unassembled	Part No. Assembled	Width X in. (mm)	Part No. Unassembled	Part No. Assembled	Width X in. (mm)	Part No. Unassembled	Part No. Assembled
.71 (18)	2200-18	2210-18	1.69 (43)	2200-43	2210-43	3.46 (88)	2200-88	2210-88
.91 (23)	2200-23	2210-23	1.89 (48)	2200-48	2210-48	3.90 (99)	2200-99	2210-99
1.10 (28)	2200-28	2210-28	2.28 (58)	2200-58	2210-58	4.88 (124)	2200-124	2210-124
1.30 (33)	2200-33	2210-33	2.68 (68)	2200-68	2210-68	5.87 (149)	2200-149	2210-149
1.50 (38)	2200-38	2210-38	2.87 (73)	2200-73	2210-73			

e-chain system® E2 tubes

Series R68

Mounting Bracket



R68

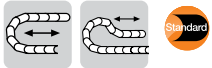

Option 1: pivoting

- Unsupported and gliding applications
- Space-restricted conditions
- Mounting points on all sides
- KMA with Quickflange option available for short and long travels

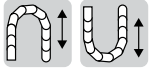

Option 2: locking

- Vertical hanging/standing travels
- Extreme speeds and accelerations
- Mounting points on all sides
- Flush mounting at both ends of the e-tube
- KMA with Quickflange option



Part Number Structure

680-050-12 QF

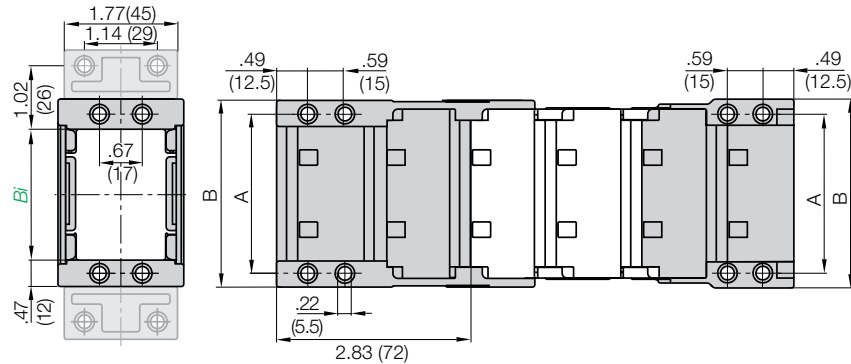
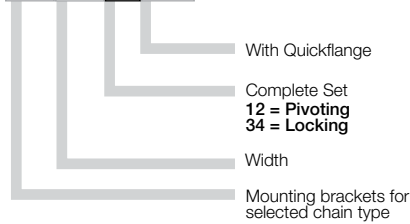

Full set, for both ends:

680-050-12 QF Full set, each part with pin/bore + tiewrap plate

Single-part order:

680-050-1 QF Mounting bracket with bore + tiewrap plate

680-050-2 QF Mounting bracket with pin + tiewrap plate



Quickflange unassembled
Part number 16800-QF

For Tube Type	Part No. Full set with Tiewrap Plate	Part No. Full Set with Quickflange	Dimension A in. (mm)	Dimension B in. (mm)
68-050	680-050- <input type="checkbox"/>	680-050- <input type="checkbox"/> QF	2.44 (62)	2.91 (74)
68-075	680-075- <input type="checkbox"/>	680-075- <input type="checkbox"/> QF	3.43 (87)	3.90 (99)
68-100	680-100- <input type="checkbox"/>	680-100- <input type="checkbox"/> QF	4.41 (112)	4.88 (124)
68-115	680-115- <input type="checkbox"/>	680-115- <input type="checkbox"/> QF	5.00 (127)	5.47 (139)
68-125	680-125- <input type="checkbox"/>	680-125- <input type="checkbox"/> QF	5.39 (137)	5.87 (149)
68-150	680-150- <input type="checkbox"/>	680-150- <input type="checkbox"/> QF	6.38 (162)	6.85 (174)
68-175	680-175- <input type="checkbox"/>	680-175- <input type="checkbox"/> QF	7.36 (187)	7.83 (199)
68-200	680-200- <input type="checkbox"/>	680-200- <input type="checkbox"/> QF	8.35 (212)	8.82 (224)
68-225	680-225- <input type="checkbox"/>	680-225- <input type="checkbox"/> QF	9.33 (237)	9.80 (249)
68-250	680-250- <input type="checkbox"/>	680-250- <input type="checkbox"/> QF	10.31 (262)	10.79 (274)

The following parts are required for attachment of the mounting brackets:

- Socket head cap bolt
M5* DIN 912-8.8
8 pieces/set
- Washer
5.3 DIN 125-ST
8 pieces/set
- Hexagon nut
M5 DIN 934-8
8 pieces/set

* The length of the socket head cap bolt is dependent on the thickness of the attachment base.

For pivoting brackets choose 12
For locking brackets choose 34
Example: 680-050- 34 QF

PDF: igus.com/e-chain-pdfs
Product information: igus.com/e-chains





Integrated strain relief for E2 e-tubes - Series R

- Strain relief disappears completely within the e-tube
- Easy to assemble, no screws required

Part. No.	Width (mm)	Number of teeth
3050-Z	1.97 (50)	5
3075-Z	2.95 (75)	7

Number of tiewrap plates 3050-Z for selected inner width *Bi*

<i>Bi</i> in. (mm)	Width tiewrap plate in. (mm)	Number of tiewrap plates <i>n</i>	Total number of teeth
1.97 (50)	–	–	–
2.95 (75)	–	–	–
3.94 (100)	1.97 (50)	1	5
4.52 (115)	1.97 (50)	1	5
4.92 (125)	1.97 (50)	1	5
5.91 (150)	1.97 (50)	2	10
6.89 (175)	1.97 (50)	2	10
7.87 (200)	1.97 (50)	3	15
8.86 (225)	1.97 (50)	3	15
9.89 (250)	1.97 (50)	4	20

Number of tiewrap plates 3075-Z for selected inner width *Bi*

<i>Bi</i> in. (mm)	Width tiewrap plate in. (mm)	Number of tiewrap plates <i>n</i>	Total number of teeth
1.97 (50)	–	–	–
2.95 (75)	–	–	–
3.94 (100)	–	–	–
4.52 (115)	2.95 (75)	1	7
4.92 (125)	2.95 (75)	1	7
5.91 (150)	2.95 (75)	1	7
6.89 (175)	2.95 (75)	2	14
7.87 (200)	2.95 (75)	2	14
8.86 (225)	2.95 (75)	3	21
9.89 (250)	2.95 (75)	3	21

e-chain system® E2 tubes

Series R68

Guide Trough



R68

Guide troughs are used with applications where the upper run of the e-tube glides on the lower run. If using igus® steel guide troughs, the following components are required:

- Full travel length of guide trough
Part number 93-30
- 1/2 travel length glide bars
Part number 93-01
- Installation sets as end connectors
Part number 93-50-XX

-XX indicates the length of the profile rail on which the guide trough is mounted. The values and part numbers are specified in the table on the right. The standard length of the trough components and glide bars is 6.56 ft (2 m). The required overall length of the guide trough directly correlates to the length of travel.

Example:

Length of travel 164 ft (50 m)
Center mounted

Required guide troughs:

164 ft (50 m) guide trough, 82 ft (25 m) glide bar
= 25 sections of 6.56 ft (2 m) guide trough
Part No. 93-30

= 13 sections of 6.56 ft (2 m) glide bar
Part No. 93-01

Required number of installation sets:

= Number of guide trough components + 1
= 25 + 1 = 26

Part number of the installation sets

93-50-XXX

Example:

93-50-250 for 9.84" (250 mm) long profile rail.



Width of Crossbar
68-075-200-0

	B_{Ri}	Installation Part No.
-050	2.87 (73)	93-50-200
-075	3.86 (98)	93-50-225
-100	4.84 (123)	93-50-250
-115	5.43 (138)	93-50-250
-125	5.83 (148)	93-50-275
-150	6.81 (173)	93-50-300
-175	7.80 (198)	93-50-325
-200	8.78 (223)	93-50-350
-225	9.76 (248)	93-50-375
-250	10.75 (273)	93-50-400

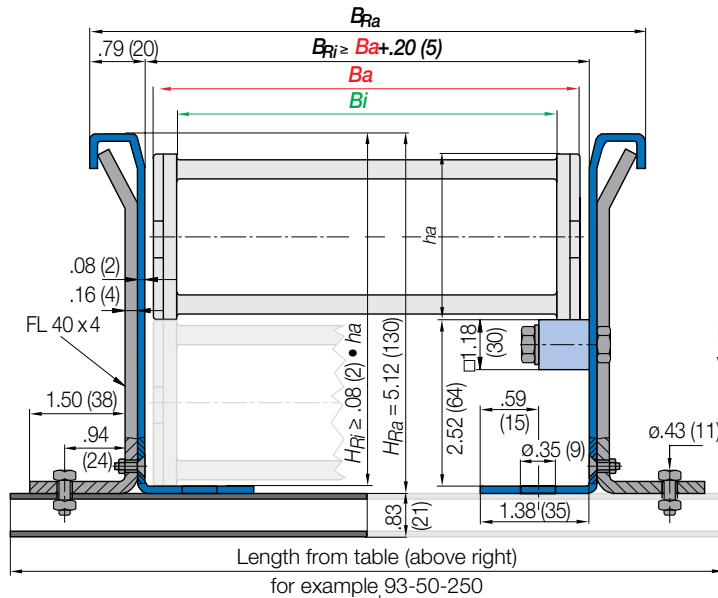

- Guide trough
- Glide bars
- Installation set "Basic"
- C-profile rail

Individual attachment without profile rail

* Specialized guide trough available upon request

PDF: igus.com/e-chain-pdfs
Product information: igus.com/e-chains





R2.1

Cost-effective chip protection



reddot design award
winner 2018



Cost-effective Chip protection - R2.1 e-tubes

Cost-effective, strong e-tubes with 1.02" (26mm), 1.57" (40mm), 1.89" (48mm) and 2.95" (75mm) inner height. Openable and removable lids along inner or outer radius, openable from both sides. Very sealed design and strong double stop-dogs for high fill weights and unsupported lengths.

- Large inner height and therefore cost-effective
- Cables are protected from chips
- Easy to fill, lids openable along the inner or outer radius, from both sides
- Low noise operation due to integrated brake
- Notch separator, recommended for side-mounted applications

Typical industries and applications

- Machine tools
- Wood processing machines
- Textile machines
- General mechanical engineering
- In all areas with dirt and chips



e-tubes with igumid HT-Material for hot chips
up to +1,562°F available upon request



Electrically conductive ESD
e-tubes upon request



UL94-V0 classifications upon request



iF product design award

1987 igus® series R68

Energy Chain System® E2 R tubes

Selection Guide

Series	Inner height <i>hi</i>		Inner width <i>Bi</i>		Outer width <i>Ba</i>		Outer height <i>ha</i>		Bend radius <i>R</i>		Unsupported length ≤ ft. (m)
	in.	(mm)	in.	(mm)	in.	(mm)	in.	(mm)	in.	(mm)	



R2.75	2.95	(75)	4.37-7.87	(111-200)	5.31-8.82	(135-224)	3.54	(90)	5.12-9.84	(130-250)	9.84	(3.00)
-------	------	------	-----------	-----------	-----------	-----------	------	------	-----------	-----------	------	--------



Available from stock. Orders ship as early as today.*

*On average 90% of orders ship the same day..



E2 e-tubes in chip area of a machine tool. Resistant to chips up to +1,562°F with special igumid HT material

Price Index

Series R2.75

Special Features / Options

ESD classification:
Electrically conductive ESD
version upon request



UL94-V0 classifications upon
request

Assembly Tips

To open the e-tube Series R, pry open the lid (with a screwdriver)

Other Installation Methods

Vertical, hanging ≤ 164 ft (50 m)

Vertical, standing ≤ 16.4 ft (5 m)

Side-mounted, un_supp. ≤ 6.56 ft (2 m)

Rotary requires further calculation

Usage Guidelines



- If a lightweight e-tube ideal for high dynamics is desired
- If a cost-effective carrier with large inner height is required
- If chip resistant features are required
- If lids openable from both sides is required
- If low noise operation is required



- For extreme chip protection according to IP40
➤ **Series RX tubes**
- For higher fill weights and unsupported lengths
➤ **Series E4-1 e-tubes**

Features & Benefits

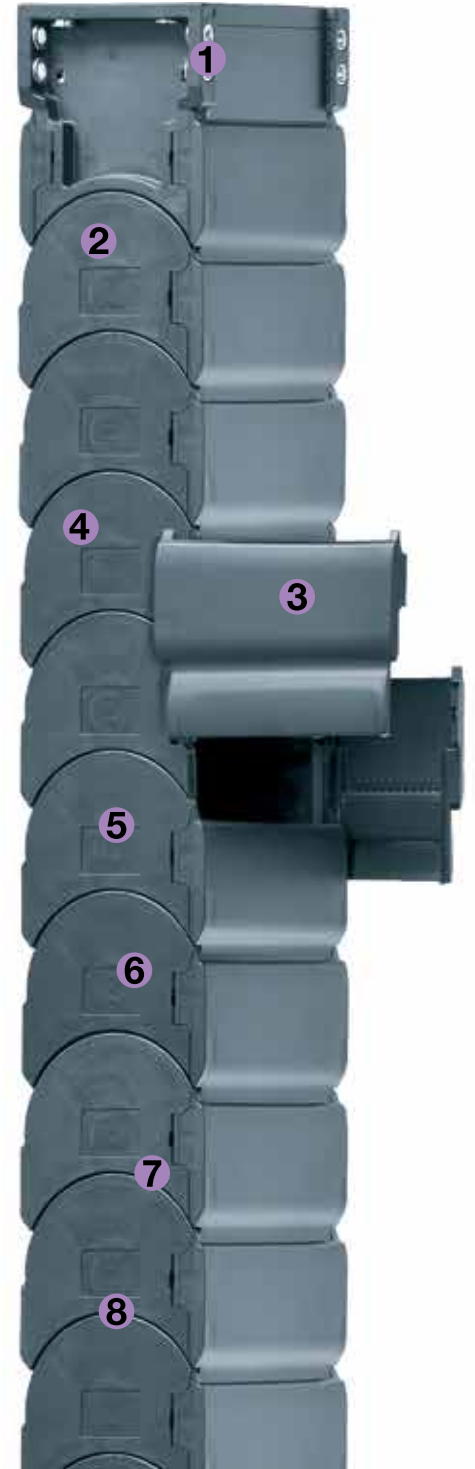
- 1 KMA mounting brackets with attachment capabilities on all sides
- 2 Smooth design, chips cannot stick
- 3 Lids openable from both sides
- 4 Ideal for 90° rotating applications
- 5 Covered pin/bore connection
- 6 Low noise operation due to built in brake
- 7 Lightweight with large inner height, good ratio of inner to outer dimensions
- 8 Strong double stop-dog system for large unsupported lengths

Order Example: Complete e-chain®

Please indicate chain length or number of links. Example:

3.28 ft (1 m) **R2.75.111.130.0**



e-chain®

With 2 separators **75.1.1** assembled every 2nd link



Interior Separation

1 Set **R2.750.111.12**



Mounting Bracket

e-chain system® E2 tubes

Series R2.75

Installation Dimensions



R2.75

Short travel, unsupported length

- FL_B = unsupported with permitted sag
 - FL_G = unsupported with straight upper run
- Further information ► Design, Chapter 1

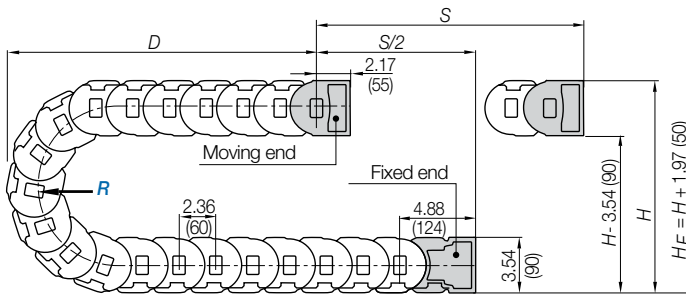
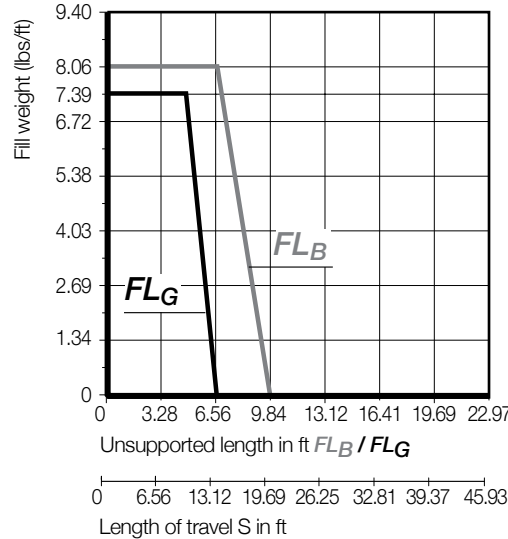
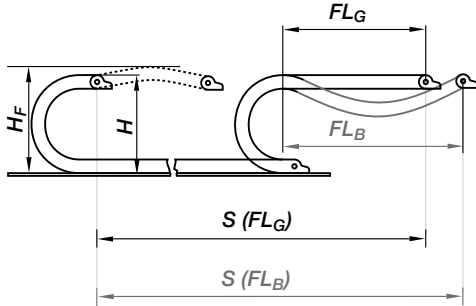

Pitch per link = 2.36" (60 mm)
 Links per ft (m) = 5.1 (17)
 For center mount applications:
 Chain length = $S/2 + K$

The required clearance height: $H_f = H + 1.97$ in. (50 mm) (with 2.02 lbs/ft (3 kg/m) fill weight). Please consult igus® if space is particularly restricted.

R	5.12 (130)	5.91 (150)	7.87 (200)	9.84 (250)
H	13.78 (350)	15.35 (390)	19.29 (490)	23.23 (590)
D	10.43 (265)	11.22 (285)	13.19 (335)	15.16 (385)
K	20.87(530)	23.43 (595)	29.53 (750)	35.83 (910)



If a gliding application for a long travel is required, please consult igus®

Short Travels - Unsupported



Unsupported e-chains® feature positive camber over short travels. This must be accounted for when specifying the clearance height. Please refer to **Installation dimensions** for further details.

Legend

- S = Length of travel
- R = Bending radius
- H = Nominal clearance height
- D = Overlength e-chain® radius in final position
- $K = \pi \cdot R + \text{safety buffer}$
- H_f = Required clearance height

2.95

PDF: igus.com/e-chain-pdfs
 Product information: igus.com/e-chains



Speed / acceleration FL_G	max. 32.8 ft/s (10 m/s) / max. 328 ft/s ² (100 m/s ²)
Speed / acceleration FL_B	max. 9.84 ft/s (3 m/s) / max. 19.69 ft/s ² (6 m/s ²)
Gliding speed / acceleration (maximum)	max. 9.84 ft/s (3 m/s) / max. 32.8 ft/s ² (10 m/s ²)
Material - permitted temperature	igumid G / -40°F (-40°C) up to +248°F (+120°C)
Flammability Class, igumid G	VDE 0304 IIC UL94 HB

Technical Data



Details of material properties

► Chapter 1

5.62

Series R2.75 - lids openable from both sides
along the outer radius

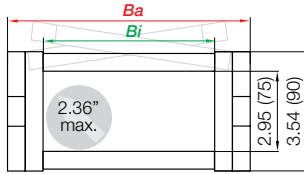

Part Number Structure



- Color - Black
- Bending radius
- Width
- Series

Telephone 1-800-521-2747

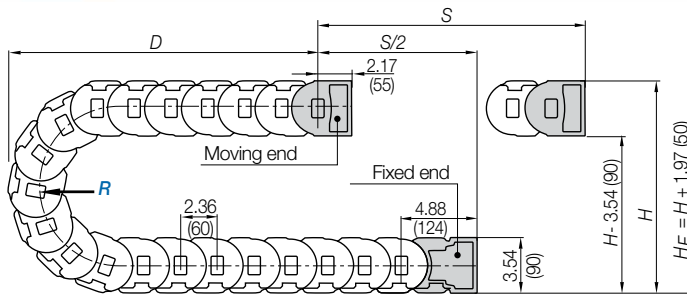

Supplement part number with required radius. Example: R2.75.111. .0
Pitch: 2.36 in. (60 mm) per link links/ft (m) = 5.1 (17)

Part Number	<i>Bi</i> in. (mm)	<i>Ba</i> in. (mm)	Weight lbs/ft (kg/m)
R2.75.111. <input type="text" value="130"/> .0	4.37 (111)	5.31 (135)	≈ 2.13 (3.175)
R2.75.111. <input type="text" value="150"/> .0	6.42 (163)	7.36 (187)	≈ 2.47 (3.672)
R2.75.111. <input type="text" value="200"/> .0	7.87 (200)	8.82 (224)	≈ 2.70 (4.012)

Choose from the radii below for all of the above sizes
Radius (mm) Example: R2.75.111. .0

	<input type="text" value="130"/>	<input type="text" value="150"/>	<input type="text" value="200"/>	<input type="text" value="250"/>
R	5.12 (130)	5.91 (150)	7.87 (200)	9.84 (250)
H	13.78 (350)	15.35 (390)	19.29 (490)	23.23 (590)
D	10.43 (265)	11.22 (285)	13.19 (335)	15.16 (385)
K	20.87(530)	23.43 (595)	29.53 (750)	35.83 (910)

Internet: igus.com
email: sales@igus.com
QuickSpec: igus.com/quickspec

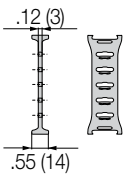
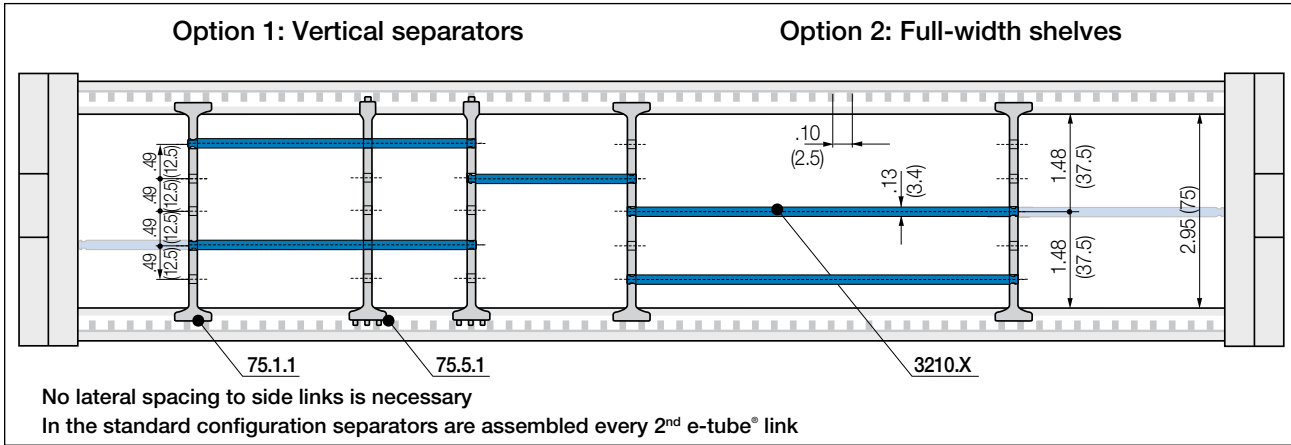

Standard separator

Unassembled	Part No. 75.1
Assembled	Part No. 75.1.1

- **Separator 75.1**
 Separator with wide base for maximum holding force in the e-tube.

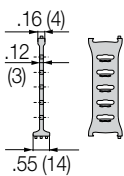

Notch Separator for notched crossbar

Unassembled	Part No. 75.5
Assembled	Part No. 75.5.1

- **Notch separator 75.5**
 Notch separator for exact positioning in an e-tube®. Recommended for side mounted applications

Full-width shelves - for the standard interior separation

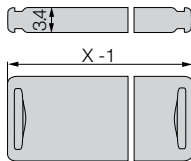

Full width shelf for e-tubes, lockable

Unassembled	Part No. 3200-X
Assembled	Part No. 3210-X

- **Full width shelf 3200-X**
 Full-width shelf locks securely into separators at both ends, giving a fixed width. Can be used as full-width or partial shelf

Width X in. (mm)	Part No. Unassembled	Part No. Assembled	Width X in. (mm)	Part No. Unassembled	Part No. Assembled	Width X in. (mm)	Part No. Unassembled	Part No. Assembled
1.97 (050)	3200-050	3210-50	4.53 (115)	3200-115	3210-115	6.89 (175)	3200-175	3210-175
2.95 (075)	3200-075	3210-75	4.92 (125)	3200-125	3210-125	7.87 (200)	3200-200	3210-200
3.94 (100)	3200-100	3210-100	5.91 (150)	3200-150	3210-150			



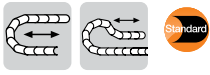

Option 1: pivoting

- Unsupported and gliding applications
- Space-restricted conditions
- Mounting points on all sides
- Corrosion-resistant

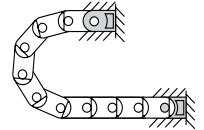
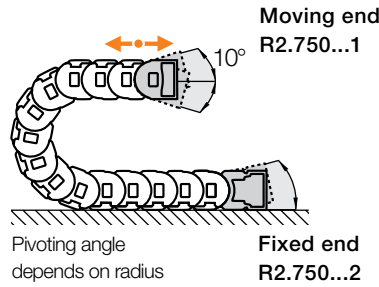

Part Number Structure

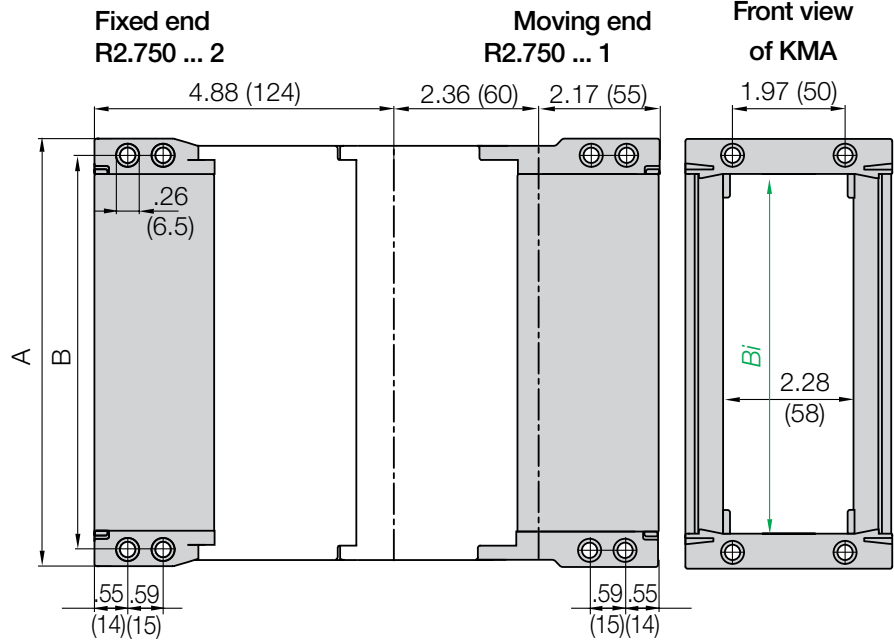
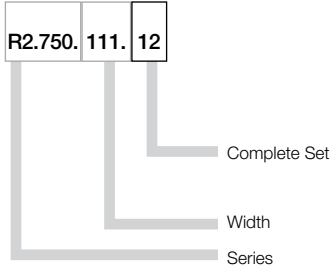

Width index	Standard	Part no. full set		A		B		Bi	
		KMA pivoting	KMA locking	in.	(mm)	in.	(mm)	in.	(mm)
.111		R2.750.111.12	-	5.55	(141)	5.00	(127)	4.37	(111)
.163		R2.750.163.12	-	7.59	(193)	7.05	(179)	6.42	(163)
.200		R2.750.200.12	-	9.06	(230)	8.50	(216)	7.87	(200)

Telephone 1-800-521-2747

Internet: igus.com
 email: sales@igus.com
 QuickSpec: igus.com/quickspec



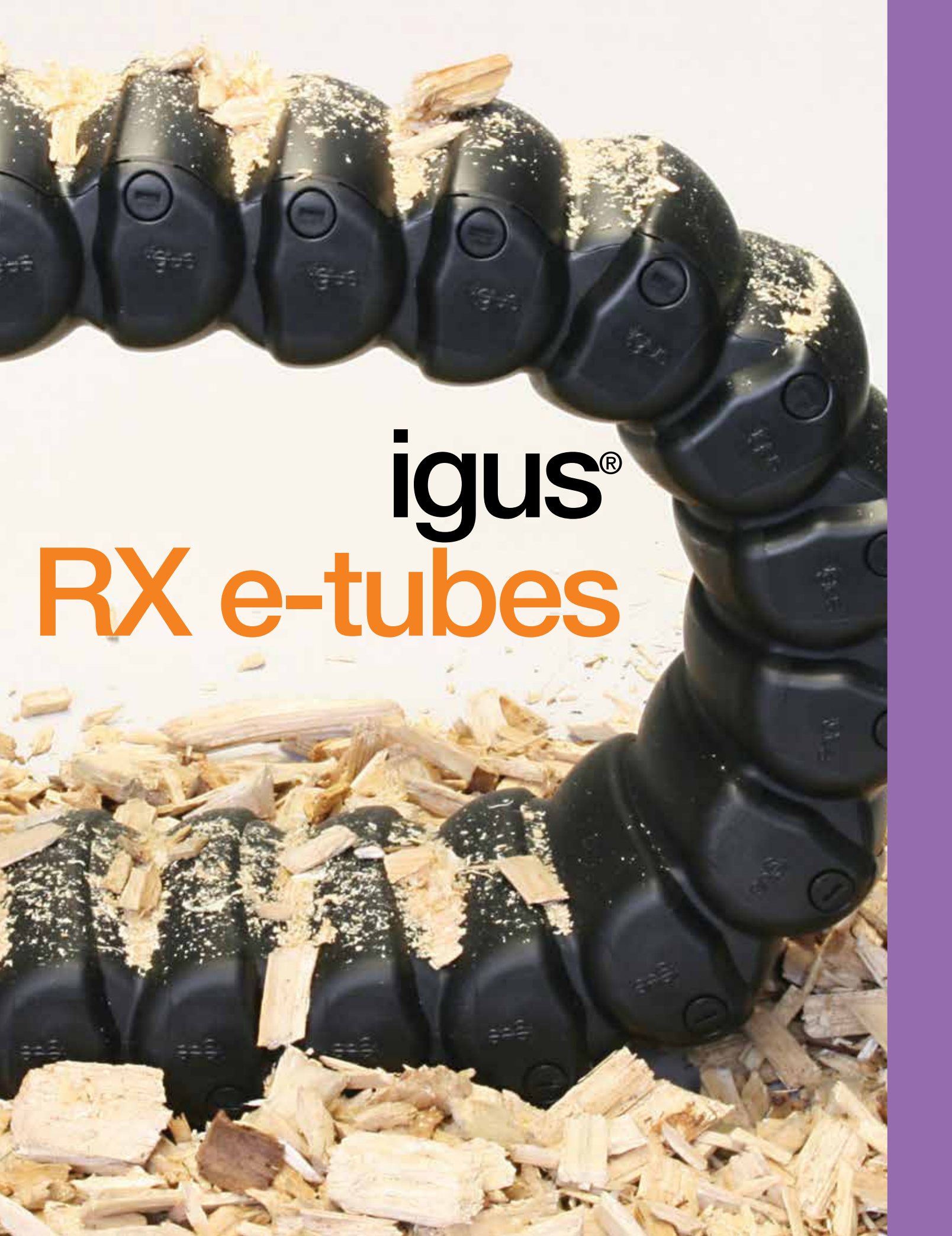

igus[®]
RX e-tubes

RX e-tube - with chip repellent design

igus® e-tube repels chips, is extremely tight, and can be opened!

- Full chip protection without undercuts, projecting edges and gaps
- Round contour prevents chip accumulation
- Large interior cross section with 2.87" (73 mm) max. inner height
- Covered pin/bore connection and stop dogs
- Reverse bending radius (RBR) becomes a standard option

Typical industries and applications

- Tooling machines
- Woodworking machines
- All kind of industries and machines with chip, dirt and dust



ESD Classification: Electrically conductive
ESD/ATEX version upon request



Flammability Class
VDE 0304 IIC UL94 HB



e-tubes with HT-material for hot chips
up to 1562°F (850°C) available upon request





RX e-tubes, without undercuts, projecting edges or gaps

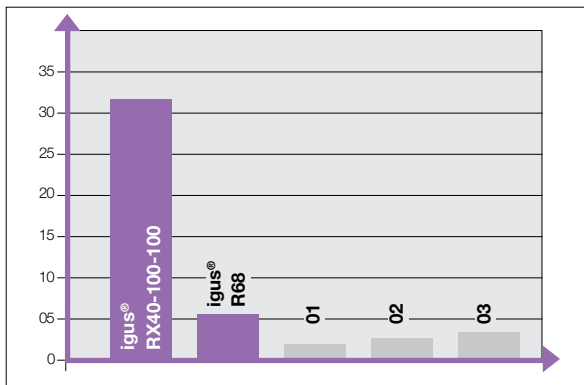

Test 1: Drowning - Various tube styles were submerged under water. For the RX e-tube, it takes more than 30 sec. to fill up with water

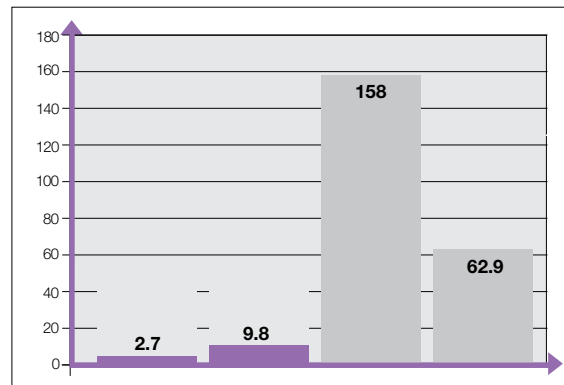

Test 2: Chip intrusion - Various tube styles were charged with a defined quantity of chips. Only 3.7 g of chips were found inside the new RX e-tube after 251,900 cycles



Chip-test at the igus® test-lab proven enormous tightness.

e-chain system® RX e-tubes

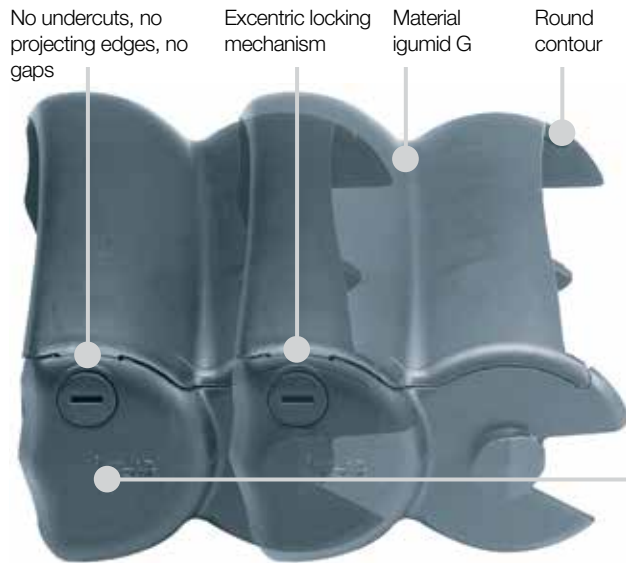

Series RX - chip protected design, small pitch, lids open

- Full chip protection without undercuts, projecting edges or gaps
- Round contour prevents chip accumulation
- Large interior cross section with 2.05 (52 mm) maximum inner height
- Covered pin/bore connection and stop dogs
- Reverse bending radius (RBR) becomes a standard option
- Perfect fastening with flange mounting brackets
- You can find more technical data about the material, chemical resistance, temperatures ► **Design, Chapter 1**

Fully covered stop dogs and connections

Selection table

Series	Inner height <i>hi</i>		Inner width <i>Bi</i>		Outer width <i>Ba</i>		Outer height <i>ha</i>		Bending radius <i>R</i>	
	in.	(mm)	in.	(mm)	in.	(mm)	in.	(mm)	in.	(mm)
RX32	1.02-1.65	(26-42)	3.15	(80)	3.87	(98.4)	2.20	(56)	3.15-5.91	(80-150)
RX40	1.26/2.05	(32/52)	3.94	(100)	4.84	(123)	2.76	(70)	3.94-11.81	(100-300)
RX48	1.38-2.44	(35-62)	4.72	(120)	5.81	(147.6)	3.31	(84)	4.72-5.91	(120-150)
RX56	1.61-2.87	(41-73)	5.51	(140)	6.78	(172.2)	3.86	(98)	5.51	(140)



Protection from all kinds of chips



Available from stock. Orders ship as early as today.*

*On average 90% of orders ship the same day..

e-chain system® RX e-tubes

e-tubes - Assembling RX e-tube



Easy opening of lids on the outer radius with embedded eccentric locking mechanism

e-tubes - Interior Separation of the RX e-tube



Interior separation with cable-friendly separators and shelves

Price Index



Series RX32

Special Features / Options



ESD classification:
Electrically conductive ESD/
ATEX version upon request



Flammability Class
VDE 0304 IIC UL94 HB

Assembly Tips



Easy opening of lids on the outer radius with embedded excentric locking mechanism

Features & Benefits

- 1 Mounting bracket available with or without strain relief
- 2 Full chip protection without undercuts, projecting edges or gaps
- 3 Large interior cross section
- 4 Round contour prevents chip accumulation
- 5 Covered pin/bore connection and stop dogs
- 6 Lids open from outer radius
- 7 Interior separation available



Usage Guidelines



- If fully protected e-tube is desired
- If easy access from the outside is required



- If a particularly low-cost solution is the main factor
 - Series R168 E2 tubes
- If no chip protection is required
 - Series E4-56 E4-1

Order Example: Complete e-chain®

Please indicate chain length or number of links. Example:

3.28 ft (1 m) RX32-080-080-0	e-chain®
With 3 separators RX32-1-1/RX32-1-2 assemb. every 2nd link	Interior Separation
1 Set RX321-080-12	Mounting Bracket

Short travel, unsupported length

- FL_B = unsupported with permitted sag
 - FL_G = unsupported with straight upper run
- Further information ► Design, Chapter 1

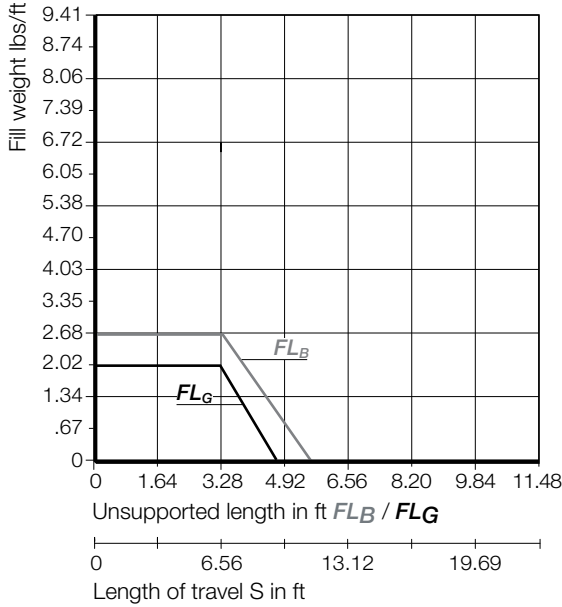
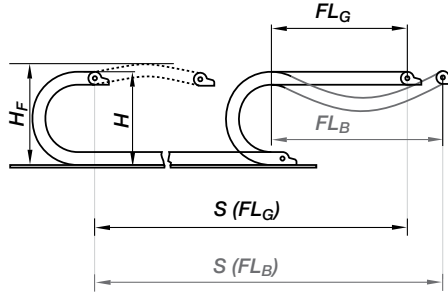

Short Travels - Unsupported



Unsupported e-chains® feature positive camber over short travels. This must be accounted for when specifying the clearance height. Please refer to **Installation dimensions** for further details.

1.65

Legend

- S = Length of travel
- R = Bending radius
- H = Nominal clearance height
- D = Overlength e-chain® radius in final position
- $K = \pi \cdot R + \text{safety buffer}$
- H_f = Required clearance height

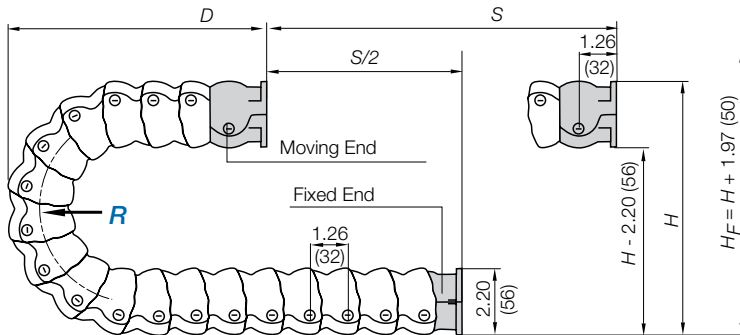

Pitch per link: = 1.26" (32 mm)
 Links per ft (m): = 9.52 (32)
 For center mount applications:
 Chain length = $\frac{S}{2} + K$

R	3.15 (080)	5.91 (150)
H	8.50 (216)	14.02 (356)
D	6.14 (156)	8.89 (226)
K	12.60 (320)	21.26 (540)

The required clearance height: $H_f = H + 1.97$ in. (50 mm) (with .34 lbs/ft (0.5 kg/m) fill weight).
 Please consult igus® if space is particularly restricted.

PDF: igus.com/e-chain-pdfs
 Product information: igus.com/e-chains



Technical Data

Speed / acceleration FL_G	max. 32.8 ft/s (10 m/s) / max. 328 ft/s ² (100 m/s ²)
Speed / acceleration FL_B	max. 9.84 ft/s (3 m/s) / max. 19.69 ft/s ² (6 m/s ²)
Material - permitted temperature	igumid G / -40°F (-40°C) up to +248°F (+120° C)
Flammability Class, igumid G	VDE 0304 IIC UL94 HB



Details of material properties

► Chapter 1

Series RX32 - snap-open along the outer radius

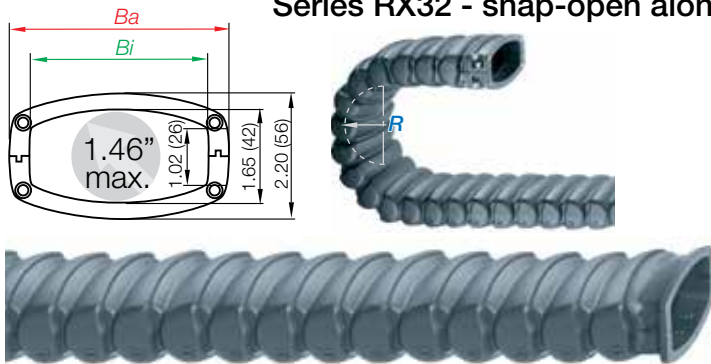

Part Number Structure

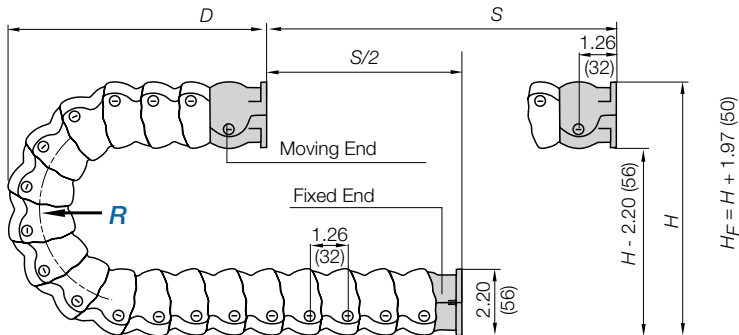
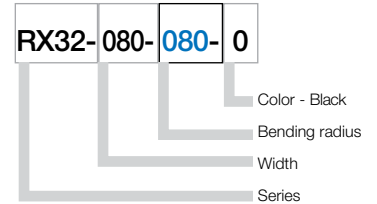

Supplement part number with required radius. Example: RX32-080-080-0
 Pitch: 1.26 in. (32 mm) per link links/ft (m) = 9.52 (32)

Part Number	Bi in. (mm)	Ba in. (mm)	Weight lbs/ft (kg/m)
RX32-080- <input type="text"/> -0	3.15 (80)	3.87 (98.4)	≈ 0.83 (1.23)

Choose from the radii below for all of the above sizes
 Radius (mm) Example: RX32-080-080-0

	080	150
R	3.15 (080)	5.91 (150)
H	8.50 (216)	14.02 (356)
D	6.14 (156)	8.89 (226)
K	12.60 (320)	21.26 (540)

Separators and shelves

Vertical separators are used if a vertical subdivision of the e-tube interior is required. By standard, vertical separators are assembled every other e-tube link.

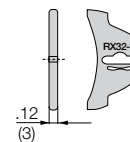
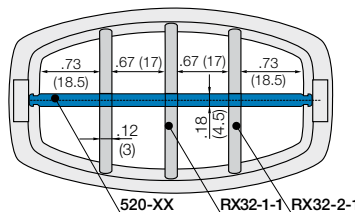

Separator, central
 Unassembled Part No. RX32-1
 Assembled Part No. RX32-1-1

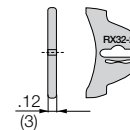

Slotted Separator, lateral
 Unassembled Part No. RX32-1
 Assembled Part No. RX32-2-1

Shelves 520-XX

Full width shelves lock into separators on both ends, fixed width possible.

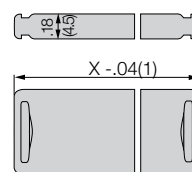

Width X in. (mm)	Part No. Unassembled	Part No. Assembled
1.14 (29)	520-29	521-29
2.13 (54)	520-54	521-54
3.11 (79)	520-79	521-79
4.09 (104)	520-104	521-104

e-chain system® RX e-tubes Series RX32 Mounting Brackets



RX32



Option: Flange mounting brackets

- Universally mountable with flange attachment capability
- Optional strain relief tiwrap plates
- Easy to open
- Optional M4 insert nuts

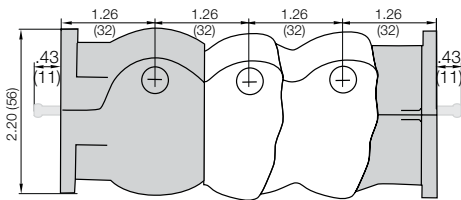
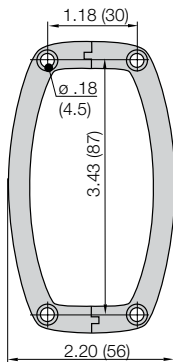
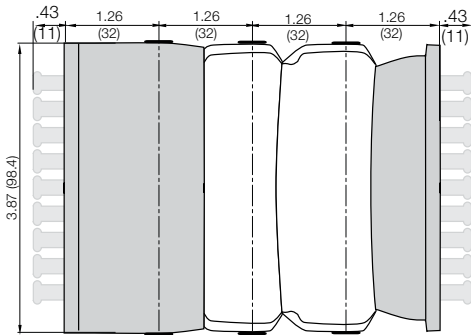
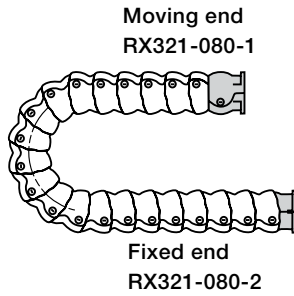

Shown with strain relief



Chain Type	Part No. full set with tiwrap plate	Part No. full set without tiwrap plate	Number of Teeth
RX32	RX321-080-12ZB	RX321-080-12	8

Full set, for both ends:

RX321-080-12

Single-part order:

RX321-080-1 Mounting bracket moving end

RX321-080-2 Mounting bracket fixed end

PDF: igus.com/e-chain-pdfs
Product information: igus.com/e-chains



Price Index



Series RX40

Special Features / Options



ESD classification:
Electrically conductive ESD/
ATEX version upon request



Flammability Class
VDE 0304 IIC UL94 HB



e-tubes with HT-material for
hot chips up to 1562°F (850°C)
available upon request

Assembly Tips



Easy opening of lids on the outer
radius with embedded excentric
locking mechanism

Features & Benefits

- 1 Mounting bracket available with or without strain relief
- 2 Full chip protection without undercuts, projecting edges or gaps
- 3 Large interior cross section
- 4 Round contour prevents chip accumulation
- 5 Covered pin/bore connection and stop dogs
- 6 Lids open from outer radius
- 7 Interior separation available



Usage Guidelines



- If a fully protected e-tube is desired
- If easy access from the outside is required



- If a particularly low-cost solution is the main factor
 - Series R68 E2 tubes
- If no chip protection is required
 - Series 3500 E2/000

Order Example: Complete e-chain®

Please indicate chain length or number of links. Example:

3.28 ft (1 m) RX-40-100-100-0



e-chain®

With 3 separators RX40-1-1/RX40-1-2 assemb. every 2nd link



Interior Separation

1 Set RX401-100-12



Mounting Bracket

e-chain system® RX e-tubes Series RX40 Installation Dimensions

Short travel, unsupported length

- FL_B = unsupported with permitted sag
 - FL_G = unsupported with straight upper run
- Further information ► Design, Chapter 1

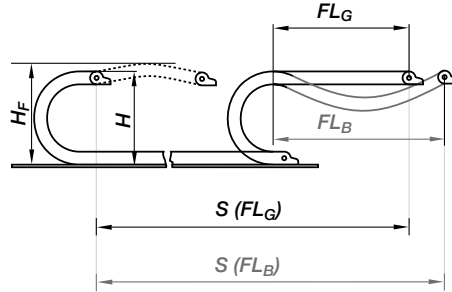
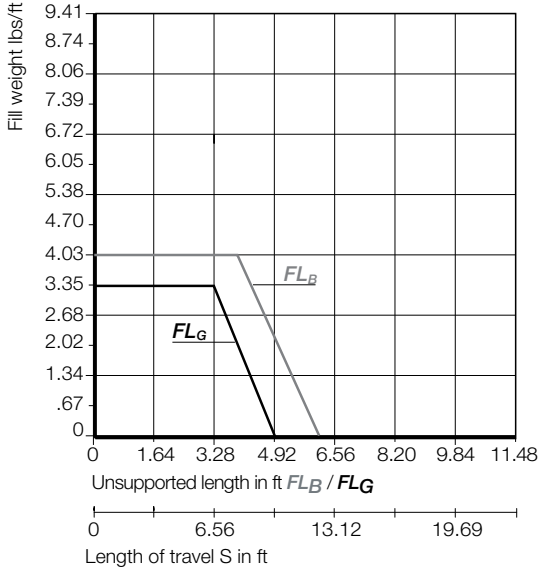

Short Travels - Unsupported



Unsupported e-chains® feature positive camber over short travels. This must be accounted for when specifying the clearance height. Please refer to **Installation dimensions** for further details.

Legend

- S = Length of travel
- R = Bending radius
- H = Nominal clearance height
- D = Overlength e-chain® radius in final position
- $K = \pi \cdot R + \text{safety buffer}$
- H_F = Required clearance height

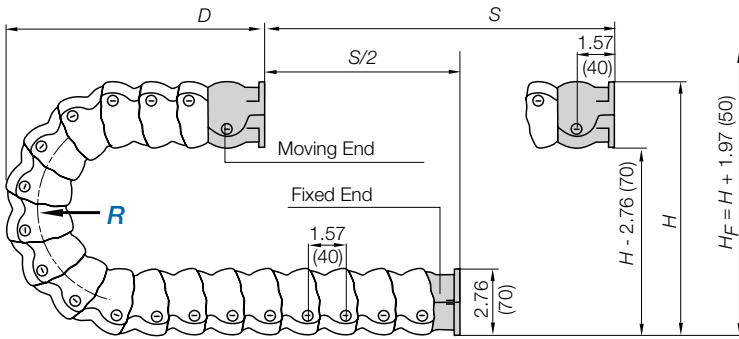

Pitch per link = 1.57" (40 mm)
Links per ft (m) = 7.62 (25)
For center mount applications:
Chain length = $\frac{S}{2} + K$

The required clearance height: $H_F = H + 1.97$ in. (50 mm) (with 1.68 lbs/ft (2.5 kg/m) fill weight). Please consult igus® if space is particularly restricted.

R	3.94 (100)	4.92 (125)	5.91 (150)	6.89 (175)	7.87 (200)	8.86 (225)	9.84 (250)	10.83 (275)	11.81 (300)
H	10.63 (270)	12.59 (320)	14.57 (370)	16.54 (420)	18.50 (470)	20.47 (520)	22.44 (570)	24.41 (620)	26.38 (670)
D	7.68 (195)	8.66 (220)	9.65 (245)	10.63 (270)	11.61 (295)	12.60 (320)	13.58 (345)	14.57 (370)	15.55 (395)
K	15.55 (395)	18.70 (475)	21.85 (555)	24.80 (630)	27.95(710)	31.10 (790)	34.25 (870)	37.20 (945)	40.35(1025)

Technical Data

Speed / acceleration FL_G	max. 32.8 ft/s (10 m/s) / max. 328 ft/s ² (100 m/s ²)
Speed / acceleration FL_B	max. 9.84 ft/s (3 m/s) / max. 19.69 ft/s ² (6 m/s ²)
Material - permitted temperature	igumid G / -40°F (-40°C) up to +248°F (+120° C)
Flammability Class, igumid G	VDE 0304 IIC UL94 HB



Details of material properties

► Chapter 1

RX40

2.05

PDF: igus.com/e-chain-pdfs
Product information: igus.com/e-chains



5.78

Series RX40 - snap-open along the outer radius

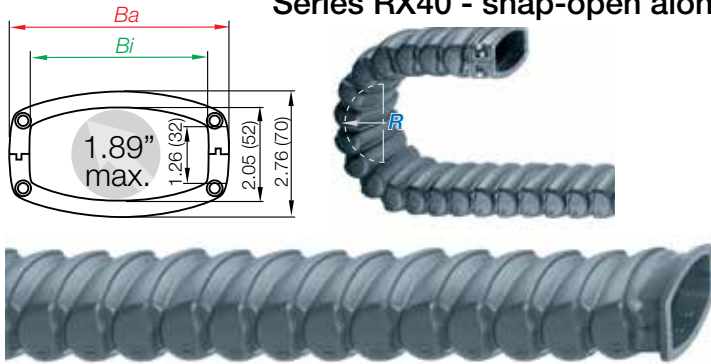

Part Number Structure

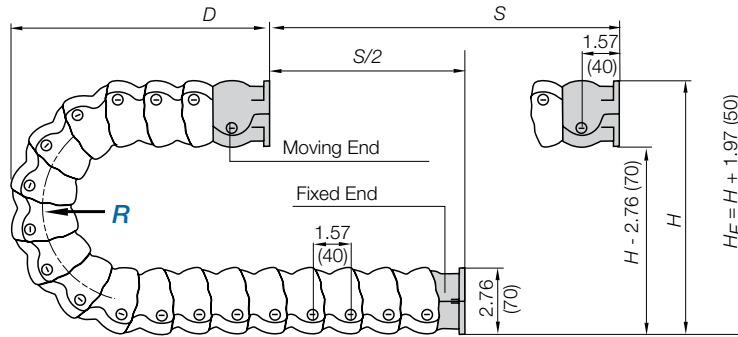
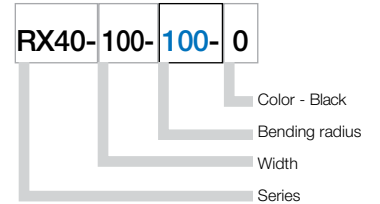

Supplement part number with required radius. Example: RX40-100-**100**-0
Pitch: 1.57 in. (40 mm) per link links/ft(m) = 7.62 (25)

Part Number	Bi in. (mm)	Ba in. (mm)	Weight lbs/ft (kg/m)
RX40-100- <input type="text"/> -0	3.94 (100)	4.84 (123)	≈ 1.27 (1.89)

Choose from the radii below for all of the above sizes
Radius (mm) Example: RX40-100-**100**-0

	100	125	150	175	200	225	250	275	300
R	3.94 (100)	4.92 (125)	5.91 (150)	6.89 (175)	7.87 (200)	8.86 (225)	9.84 (250)	10.83 (275)	11.81 (300)
H	10.63 (270)	12.59 (320)	14.57 (370)	16.54 (420)	18.50 (470)	20.47 (520)	22.44 (570)	24.41 (620)	26.38 (670)
D	7.68 (195)	8.66 (220)	9.65 (245)	10.63 (270)	11.61 (295)	12.60 (320)	13.58 (345)	14.57 (370)	15.55 (395)
K	15.55 (395)	18.70 (475)	21.85 (555)	24.80 (630)	27.95(710)	31.10 (790)	34.25 (870)	37.20 (945)	40.35(1025)

Separators and shelves

Vertical separators are used if a vertical subdivision of the e-tube interior is required. By standard, vertical separators are assembled every other e-tube link.

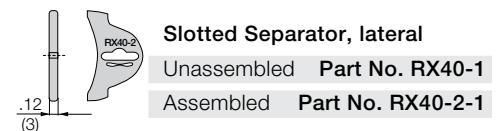
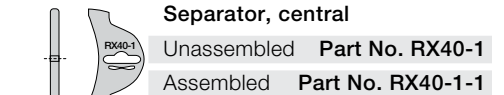
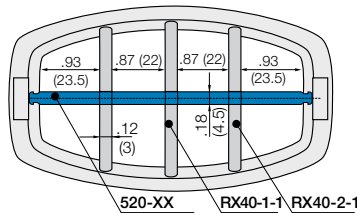

Shelves 520-XX

Full width shelves lock into separators on both ends, fixed width possible. Separators can be moved freely over the shelf horizontally.

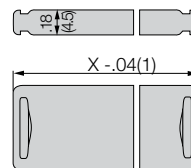

Width X in. (mm)	Part No. Unassembled	Part No. Assembled
1.14 (29)	520-24	521-24
2.13 (54)	520-44	521-44
3.11 (79)	520-64	521-64
4.09 (104)	520-84	521-84

e-chain system® RX e-tubes Series RX40 Mounting Brackets



RX40



Option: Flange mounting brackets

- Universally mountable with flange attachment capability
- Optional strain relief tiwrap plates
- Easy to open
- Optional M4 insert nuts

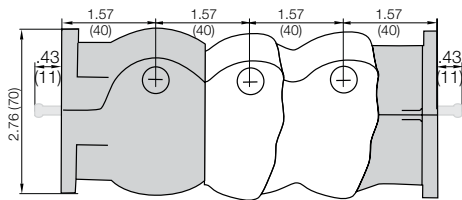
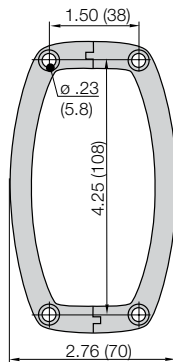
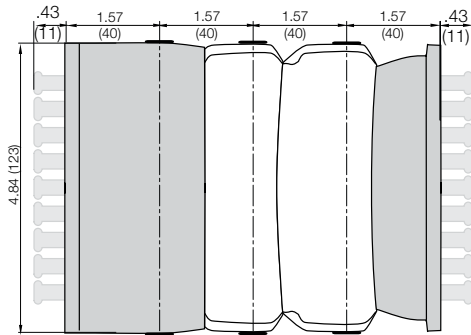
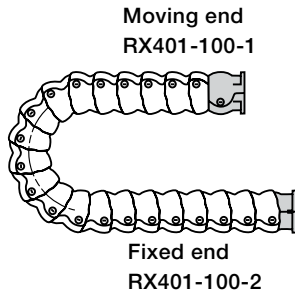

Shown with strain relief



Chain Type	Part No. full set with tiwrap plate	Part No. full set without tiwrap plate	Number of Teeth
RX40	RX401-100-12ZB	RX401-100-12	10

Full set, for both ends:

RX401-100-12

Single-part order:

RX401-100-1 Mounting bracket moving end

RX401-100-2 Mounting bracket fixed end

PDF: igus.com/e-chain-pdfs
Product information: igus.com/e-chains



Price Index

Series RX48

Special Features / Options

ESD classification:
 Electrically conductive ESD/
 ATEX version upon request

Flammability Class
 VDE 0304 IIC UL94 HB

Assembly Tips

Easy opening of lids on the outer radius with embedded excentric locking mechanism

Features & Benefits

- 1 Mounting bracket available with or without strain relief
- 2 Full chip protection without undercuts, projecting edges or gaps
- 3 Large interior cross section
- 4 Round contour prevents chip accumulation
- 5 Covered pin/bore connection and stop dogs
- 6 Lids open from outer radius
- 7 Interior separation available

Usage Guidelines

- If a fully protected e-tube is desired
- If easy access from the outside is required



- For chip protection in gliding applications
 ► Series R18840 E4 Light

Order Example: Complete e-chain®

Please indicate chain length or number of links. Example:

 9.84 ft (3 m) **RX48-120-120-0**

e-chain®

 With 3 separators **RX48-1-1/RX48-1-2** assemb. every 2nd link

Interior Separation

 1 Set **RX48-120-12**

Mounting Bracket

e-chain system® RX e-tubes

Series RX48

Installation Dimensions

Short travel, unsupported length

- FL_B = unsupported with permitted sag
 - FL_G = unsupported with straight upper run
- Further information ► Design, Chapter 1

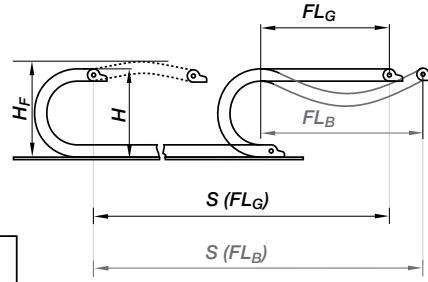
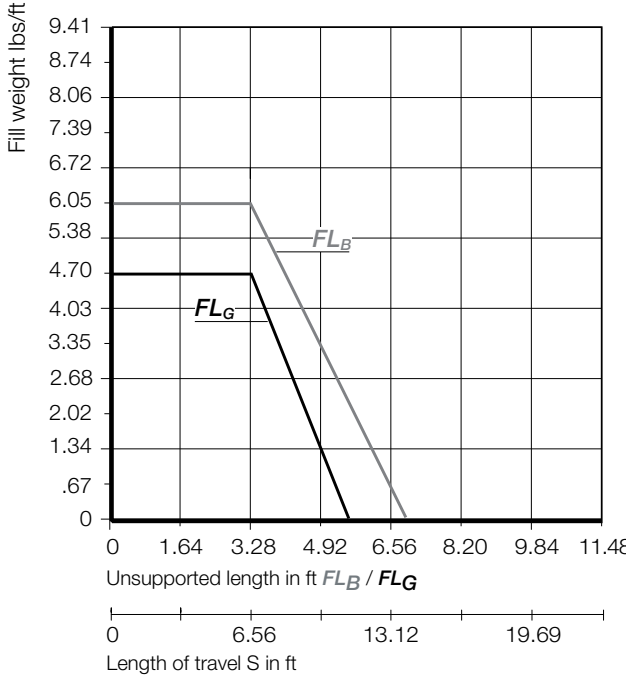

RX48

Short Travels - Unsupported



Unsupported e-chains® feature positive camber over short travels. This must be accounted for when specifying the clearance height. Please refer to **Installation dimensions** for further details.

Legend

- S = Length of travel
- R = Bending radius
- H = Nominal clearance height
- D = Overlength e-chain® radius in final position
- $K = \pi \cdot R + \text{safety buffer}$
- H_F = Required clearance height

2.44

PDF: igus.com/e-chain-pdfs
Product information: igus.com/e-chains

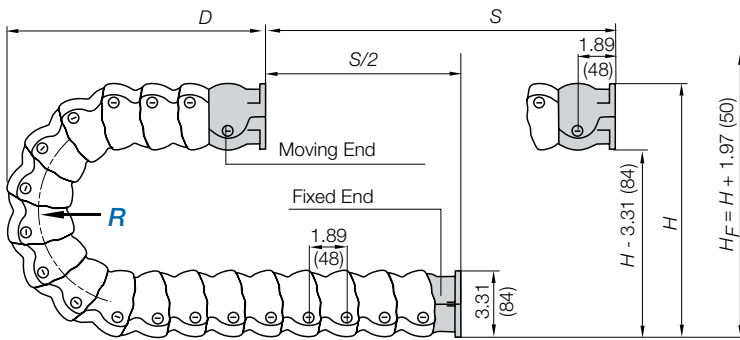

Pitch per link = 1.89" (48 mm)

Links per ft (m) = 6.35 (21)

For center mount applications:

Chain length = $S/2 + K$

The required clearance height: $H_F = H + 1.97$ in. (50 mm) (with .34 lbs/ft (0.5 kg/m) fill weight). Please consult igus® if space is particularly restricted.

R	4.72 (120)	5.91 (150)
H	12.76 (324)	15.12 (384)
D	9.21 (234)	10.39 (264)
K	18.70 (475)	22.44 (570)

Technical Data

Speed / acceleration FL_G	max. 32.8 ft/s (10 m/s) / max. 328 ft/s ² (100 m/s ²)
Speed / acceleration FL_B	max. 9.84 ft/s (3 m/s) / max. 19.69 ft/s ² (6 m/s ²)
Material - permitted temperature	igumid G / -40°F (-40°C) up to +248°F (+120°C)
Flammability Class, igumid G	VDE 0304 IIC UL94 HB



Details of material properties

► Chapter 1

Series RX48 - snap-open along the outer radius

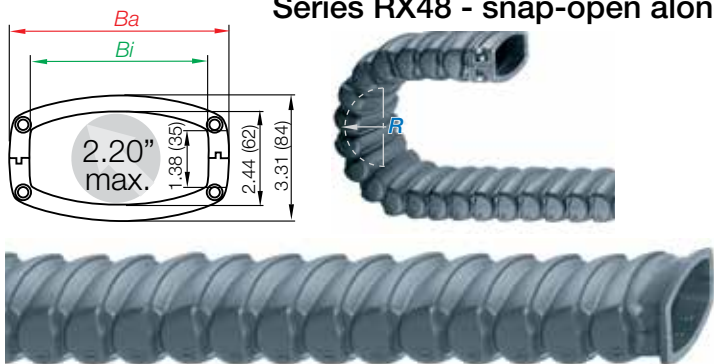

Part Number Structure

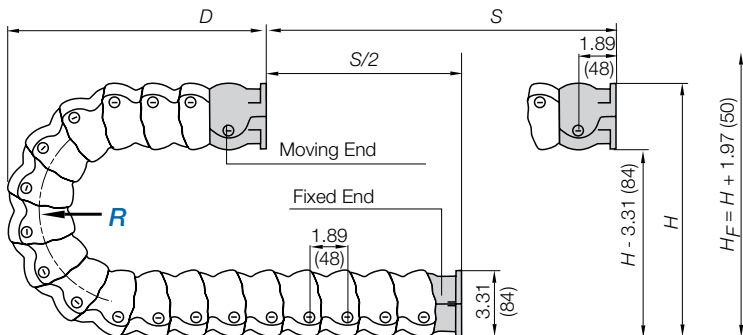
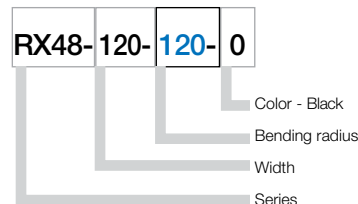

Supplement part number with required radius. Example: RX48-120-**120**-0
 Pitch: 1.89 in. (48 mm) per link links/ft(m) = 6.35 (21)

Part Number	Bi in. (mm)	Ba in. (mm)	Weight lbs/ft (kg/m)
RX48-120- <input type="text"/> -0	4.72 (120)	5.81 (147.6)	≈ 1.85 (2.76)

Choose from the radii below for all of the above sizes
 Radius (mm) Example: RX48-120-**120**-0

	120	150
R	4.72 (120)	5.91 (150)
H	12.76 (324)	15.12 (384)
D	9.21 (234)	10.39 (264)
K	18.70 (475)	22.44 (570)

Separators and shelves

Vertical separators are used if a vertical subdivision of the e-tube interior is required. By standard, vertical separators are assembled every other e-tube link.

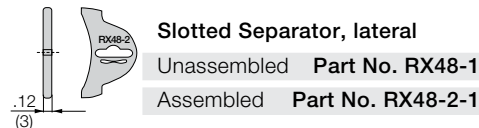
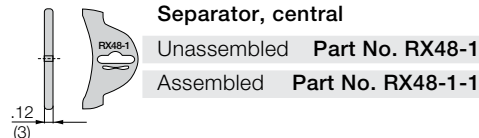
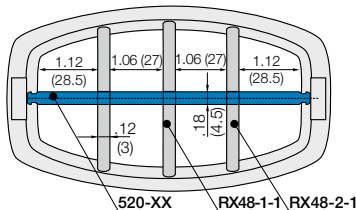

Shelves 520-XX

Full width shelves lock into separators on both ends, fixed width possible. Separators can be moved freely over the shelf horizontally.

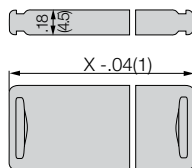

Width X in. (mm)	Part No. Unassembled	Part No. Assembled
1.34 (34)	520-34	521-34
2.52 (64)	520-64	521-64
3.70 (94)	520-94	521-94
4.88 (124)	520-124	521-124

e-chain system® RX e-tubes Series RX48 Mounting Brackets



RX48



Option: Flange mounting brackets

- Universally mountable with flange attachment capability
- Optional strain relief tiwrap plates
- Easy to open
- Optional M4 insert nuts

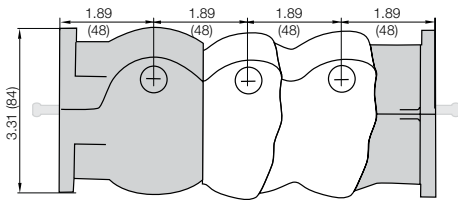
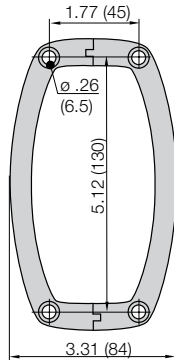
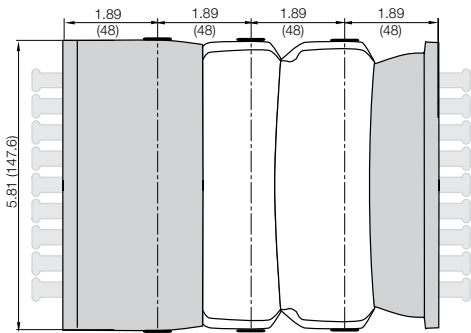
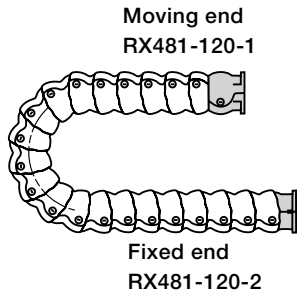

Shown with strain relief



Full set, for both ends:

RX481-120-12

Single-part order:

RX481-120-1 Mounting bracket moving end

RX481-120-2 Mounting bracket fixed end

Chain Type	Part No. full set with tiwrap plate	Part No. full set without tiwrap plate	Number of Teeth
RX48	upon request	RX481-120-12	upon request

PDF: igus.com/e-chain-pdfs
Product information: igus.com/e-chains



Price Index



Series RX56

Special Features / Options



ESD classification:
Electrically conductive ESD/
ATEX version upon request



Flammability Class
VDE 0304 IIC UL94 HB

Assembly Tips



Easy opening of lids on the outer radius with embedded excentric locking mechanism

Features & Benefits

- 1 Mounting bracket available with or without strain relief
- 2 Full chip protection without undercuts, projecting edges or gaps
- 3 Large interior cross section
- 4 Round contour prevents chip accumulation
- 5 Covered pin/bore connection and stop dogs
- 6 Lids open from outer radius
- 7 Interior separation available



Usage Guidelines



- If a fully protected e-tube is desired
- If easy access from the outside is required



- For chip protection in gliding applications
➤ Series R19850 E4 Light

Order Example: Complete e-chain®

Please indicate chain length or number of links. Example:

9.84 ft (3 m) RX56-140-140-0	e-chain®
With 3 separators RX56-1-1/RX56-1-2 assemb. every 2nd link	Interior Separation
1 Set RX561-140-12	Mounting Bracket

e-chain system® RX e-tubes

Series RX56

Installation Dimensions

Short travel, unsupported length

- FL_B = unsupported with permitted sag
 - FL_G = unsupported with straight upper run
- Further information ► Design, Chapter 1

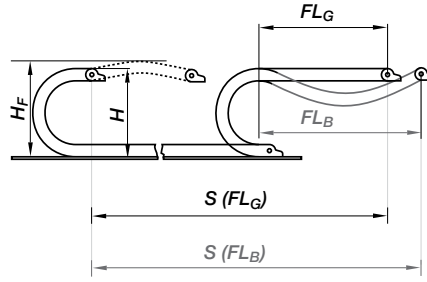
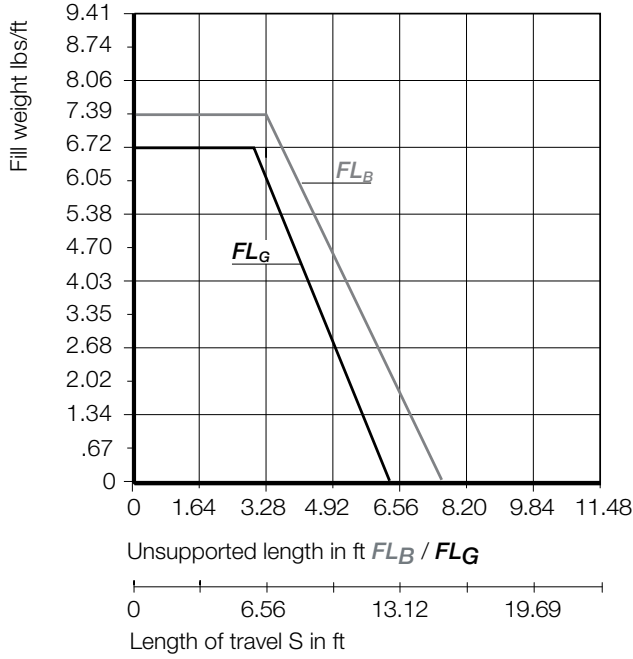

RX56

Short Travels - Unsupported

2.87



Unsupported e-chains® feature positive camber over short travels. This must be accounted for when specifying the clearance height. Please refer to **Installation dimensions** for further details.

Legend

- S = Length of travel
- R = Bending radius
- H = Nominal clearance height
- D = Overlength e-chain® radius in final position
- $K = \pi \cdot R + \text{ safety buffer }$
- H_F = Required clearance height

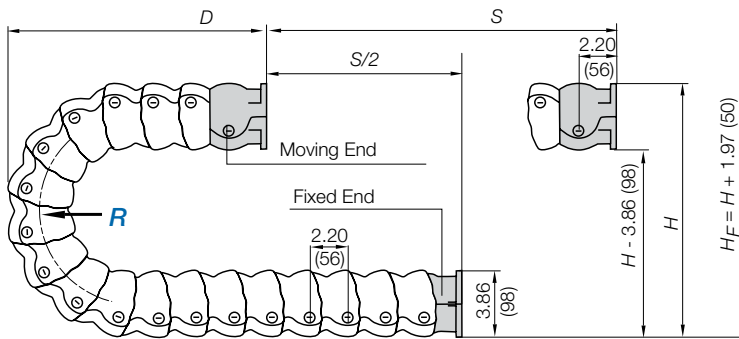

Pitch per link = 2.20" (56 mm)

Links per ft (m) = 5.45 (18)

For center mount applications:

Chain length = $\frac{S}{2} + K$

The required clearance height: $H_F = H + 1.97$ in. (50 mm) (with .34 lbs/ft (0.5 kg/m) fill weight). Please consult igus® if space is particularly restricted.

R	5.51 (140)
H	14.88 (378)
D	10.75 (273)
K	21.85 (555)

PDF: igus.com/e-chain-pdfs
Product information: igus.com/e-chains



Technical Data

Speed / acceleration FL_G	max. 32.8 ft/s (10 m/s) / max. 328 ft/s ² (100 m/s ²)
Speed / acceleration FL_B	max. 9.84 ft/s (3 m/s) / max. 19.69 ft/s ² (6 m/s ²)
Material - permitted temperature	igumid G / -40°F (-40°C) up to +248°F (+120° C)
Flammability Class, igumid G	VDE 0304 IIC UL94 HB



Details of material properties

► Chapter 1

Series RX56 - snap-open along the outer radius

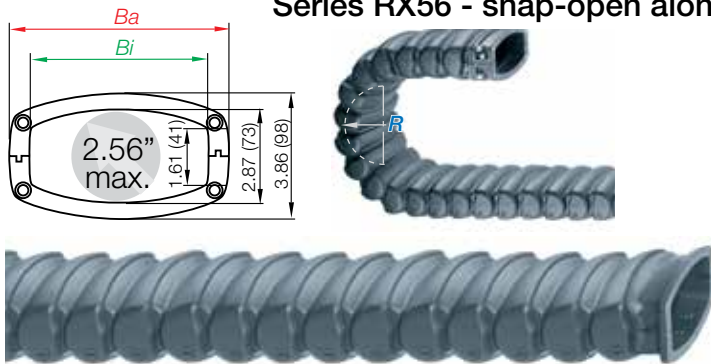

Part Number Structure

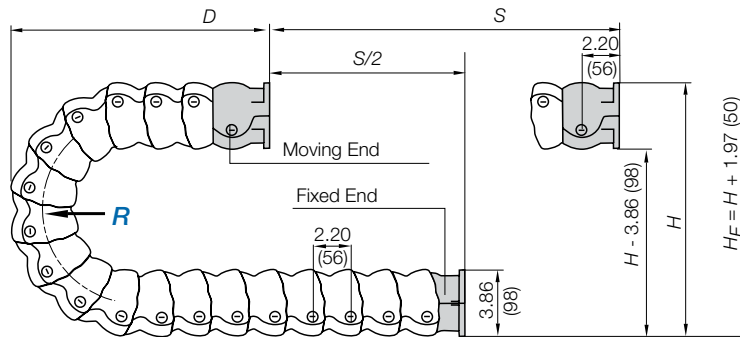
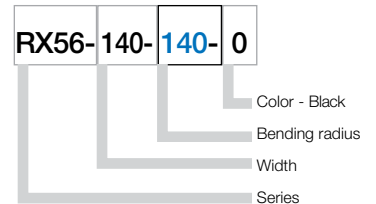

Supplement part number with required radius. Example: RX56-140-**140**-0
 Pitch: 2.20 in. (56 mm) per link links/ft(m) = 5.45 (18)

Part Number	Bi in. (mm)	Ba in. (mm)	Weight lbs/ft (kg/m)
RX56-140- <input type="text"/> -0	5.51 (140)	6.78 (172.2)	≈ 2.57 (3.83)
Choose from the radii below for all of the above sizes			
	Radius (mm)		Example: RX56-140- <input type="text"/> -0

R	<input type="text" value="140"/> 5.51 (140)
H	14.88 (378)
D	10.75 (273)
K	21.85 (555)

Separators and shelves

Vertical separators are used if a vertical subdivision of the e-tube interior is required. By standard, vertical separators are assembled every other e-tube link.

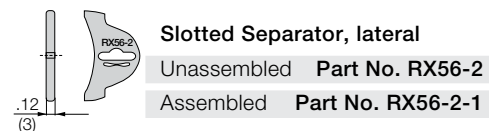
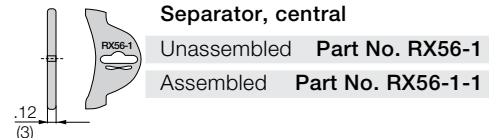
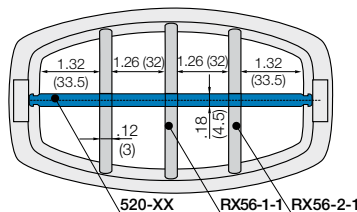

Shelves RX520-XX

Full width shelves lock into separators on both ends, fixed width possible. Separators can be moved freely over the shelf horizontally.

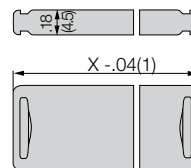

Width X in. (mm)	Part No. Unassembled	Part No. Assembled
1.54 (39)	520-39	521-39
2.91 (74)	520-74	521-74
4.29 (109)	520-109	521-109
5.67 (144)	520-144	521-144

e-chain system® RX e-tubes Series RX56 Mounting Brackets



RX56



Option: Flange mounting brackets

- Universally mountable with flange attachment capability
- Optional strain relief tiwrap plates
- Easy to open
- Optional M4 insert nuts

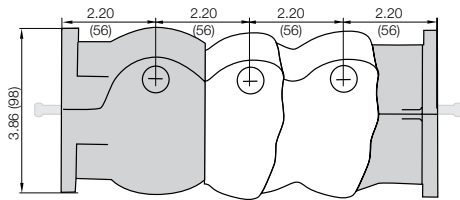
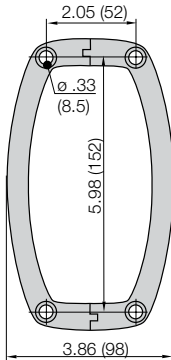
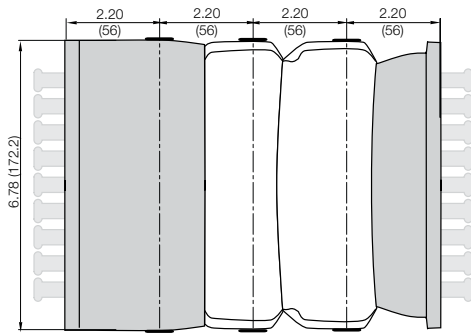
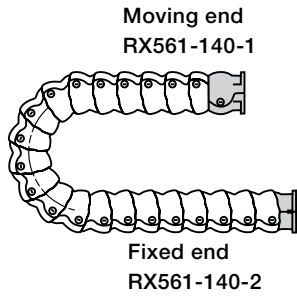

Shown with strain relief



Full set, for both ends:

RX561-140-12

Single-part order:

RX561-140-1 Mounting bracket moving end

RX561-140-2 Mounting bracket fixed end

Chain Type	Part No. full set with tiwrap plate	Part No. full set without tiwrap plate	Number of Teeth
RX56	upon request	RX561-120-12	upon request

PDF: igus.com/e-chain-pdfs
Product information: igus.com/e-chains



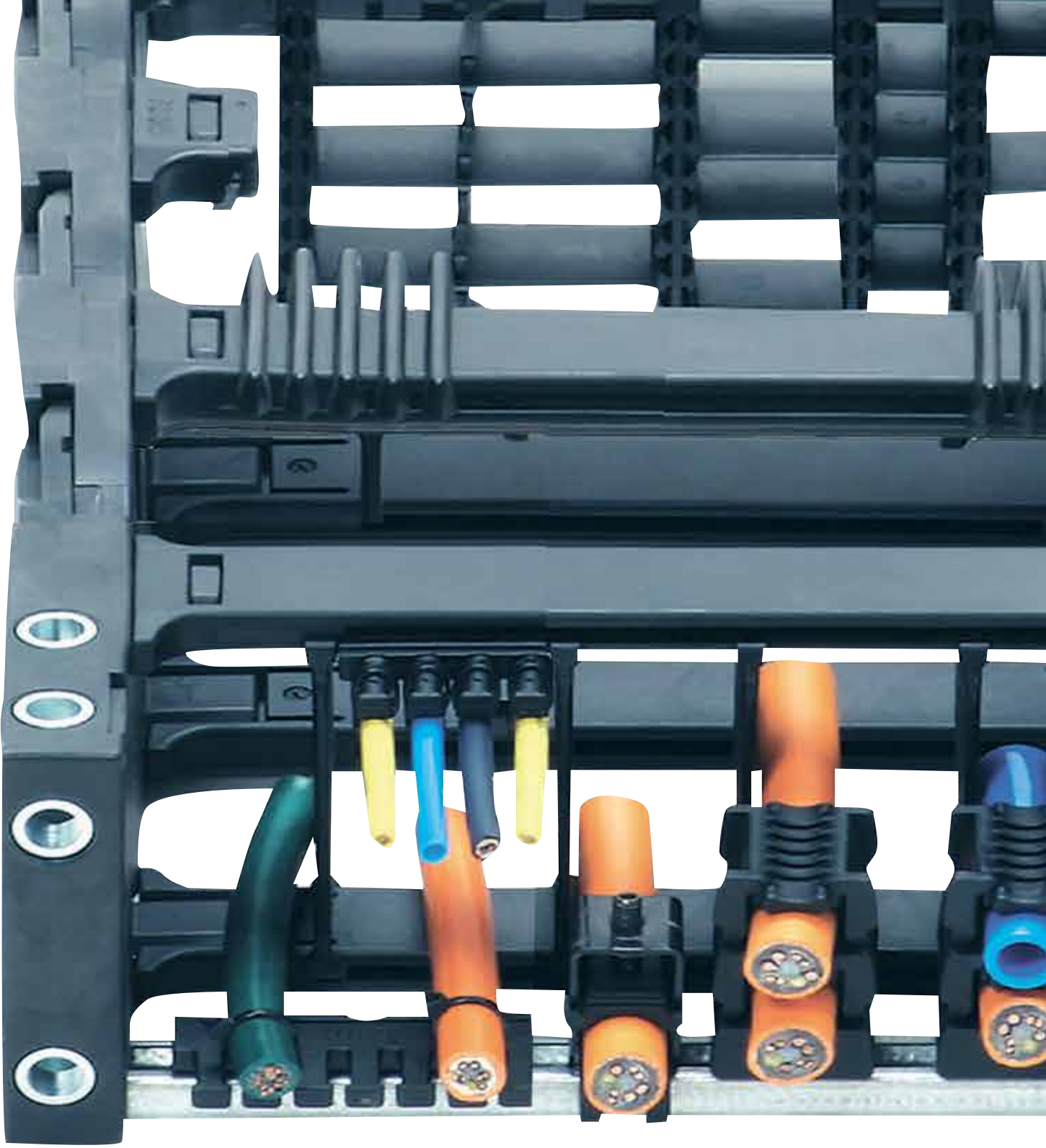

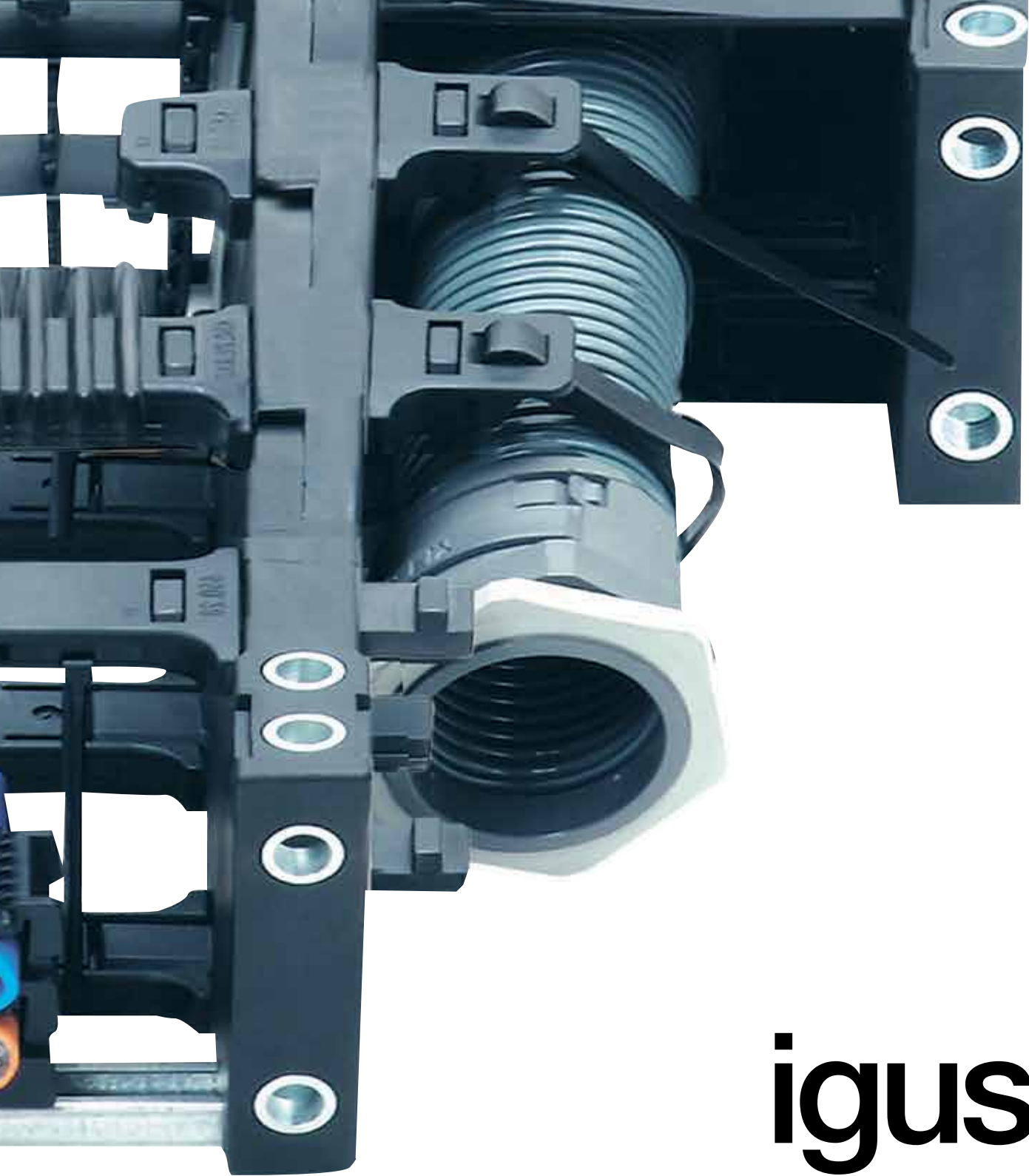

igus[®]
System E4
E4-1, E4-1 light, E4/light

E4-1 e-chain® series for almost all applications

The E4-1 system combines all the advantages of its three predecessors:

- Tongue and groove design provides greater lateral stability, high shear force on long travels and for longer unsupported lengths
- Ideal for side-mounted applications
- Noise dampening “brakes” and rubber dampers available
- Snap-open links for quick assembly, with or without pretension
- Dirt repellent and wear-resistant
- Side wear pads

Almost all accessories and mounting dimensions are identical. With the E4-1, the service life of your application can be still increased with lower costs.

Typical industries and applications

- Crane
- Indoor crane
- Composting plants
- Sewage plants
- Machine tools
- General mechanical engineering
- Material handling technology
- Refrigeration engineering
- Construction machinery
- Wood working
- Robotics and handling systems



Cleanroom test upon request



Reduced noise due to special rubber pads and special stop dog design



ESD classification: Electrically conductive ESD/ATEX version upon request



System E4-1 field proven in long travels



Fully enclosed e-tubes available as special design with HT material for 1562°F hot chips

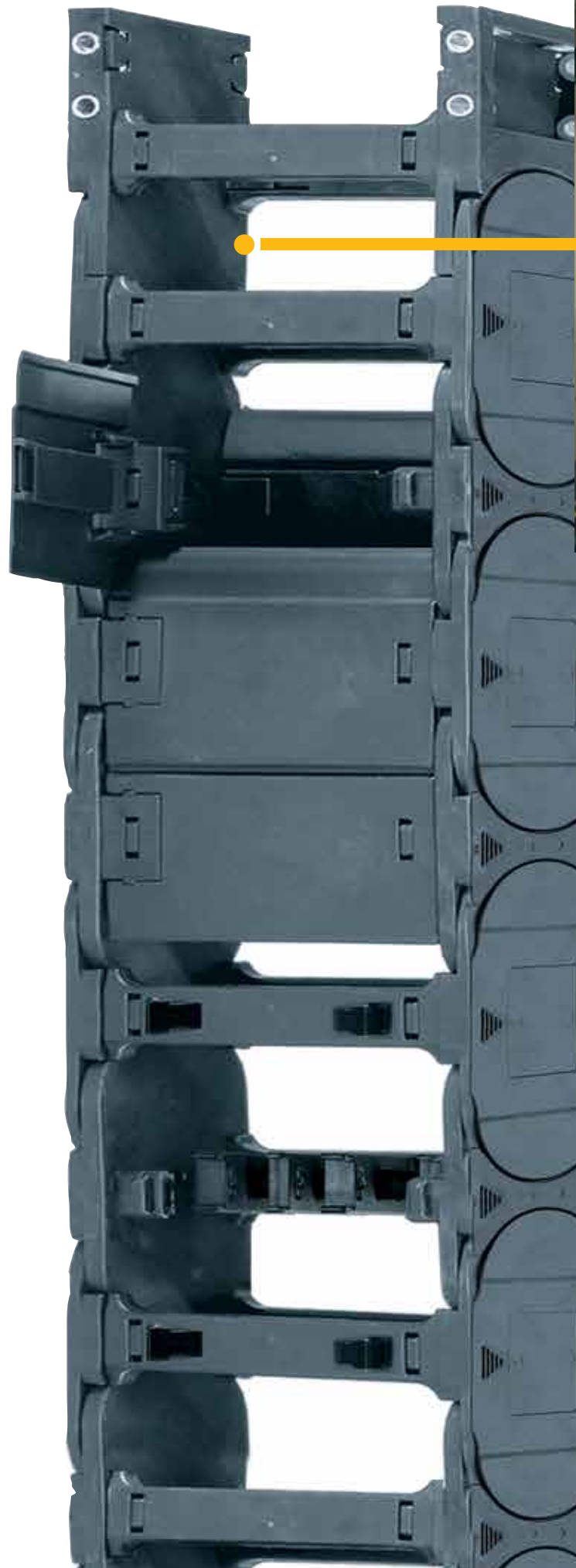



The E4-42 series in a machine tool, completely assembled with igus® chainflex® cables

Application	Design feature
Long unsupported length	Special stop dogs, tongue and groove link design
Low-noise operation, unsupported gliding	Integrated “brake”, smooth gliding surfaces - rubber dampers optional
Hanging and standing installation	Torsional stability through tongue and groove link design, “no camber” option by flipping the outer link
Long travels	High push/pull forces through tongue and groove link design and stop dogs, large and smooth gliding surfaces
Side-mounted, unsupported	Tongue and groove link design increases unsupported length by about 30% mounted on the side
Fast assembly	“Inner link/outer link” design
Rotary motion	Through simple flipping of links or easy modification, gliding surfaces on the side
Increase service life of cable	Smooth, wide solid polymer support for cables, many quick-mounting shelving options
Increase service life of chains	Large pins, optimized material, high stability
ESD, ATEX	Tongue and groove link design for secure contact surfaces in motion (special version in conductive material)
Operation under dirt, chips, humidity	Tongue and groove link design design prevents chain breakage, dirt-resistant design

E4-1 Design Features

The E4-1 Series combines the tongue and groove link design and the inner and outer link design of previous E4 constructions – all in one e-chain®

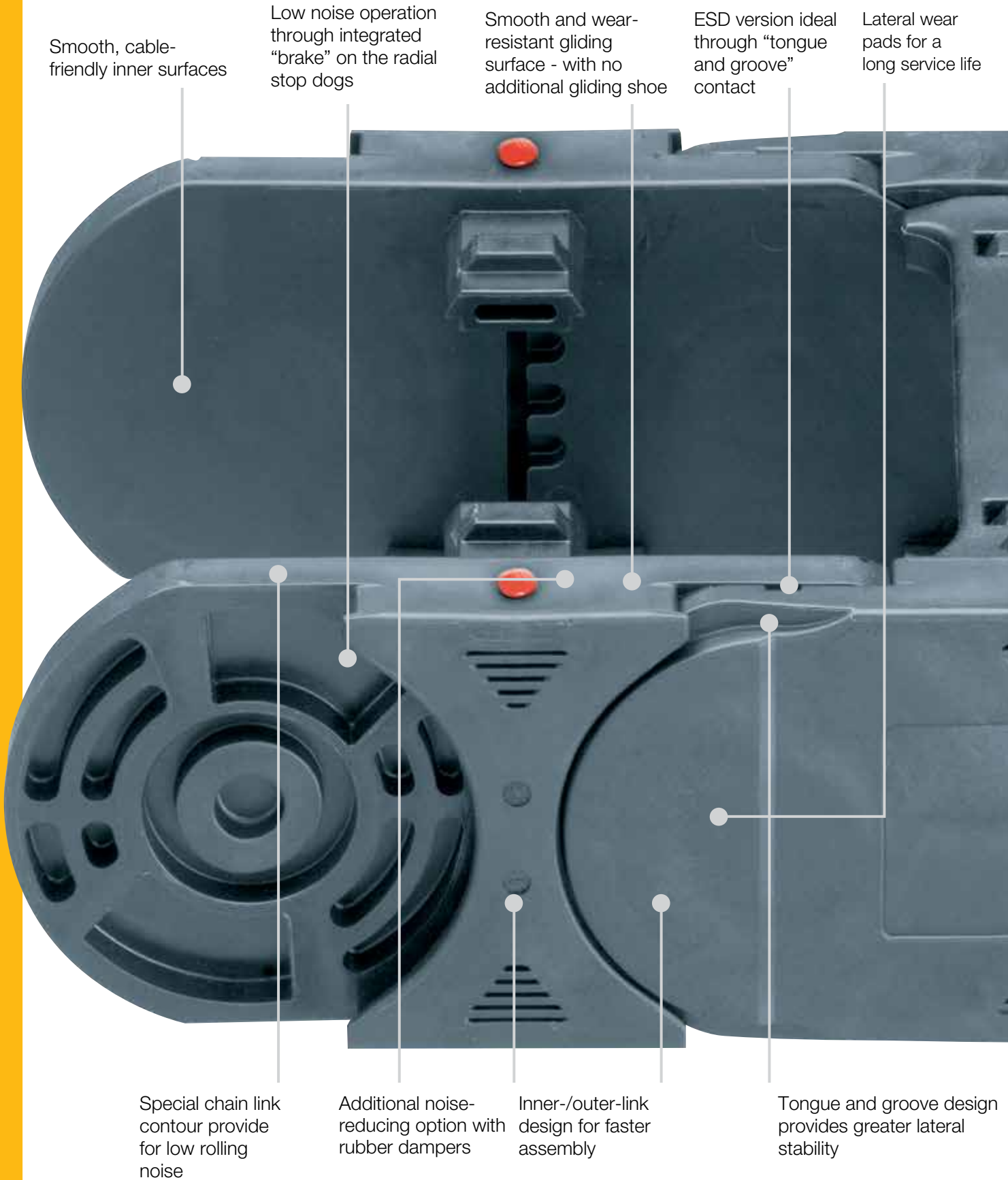

E4-1 Design Features



Cut costs by eliminating additional components with E4-1 e-chains® - Proven durability and stability

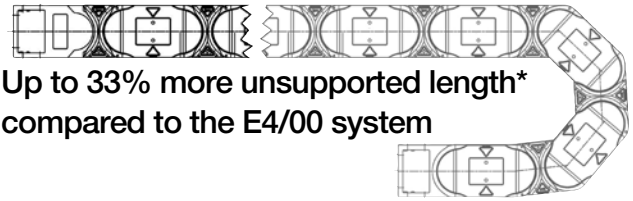

- Up to 133% higher tensile strength*
- Up to 33% more unsupported length*. Save in the purchase cost, as you can now use smaller e-chains®
- Due to the large unsupported lengths or loads, oversized energy supply systems can be optimized with the igus® E4-1 system

* Compared to the igus® E4/00 system series

** Test at igus® laboratory: Sag tested with defined weight and length over 96h

Selection table and assembly instructions
 ► page 6.7

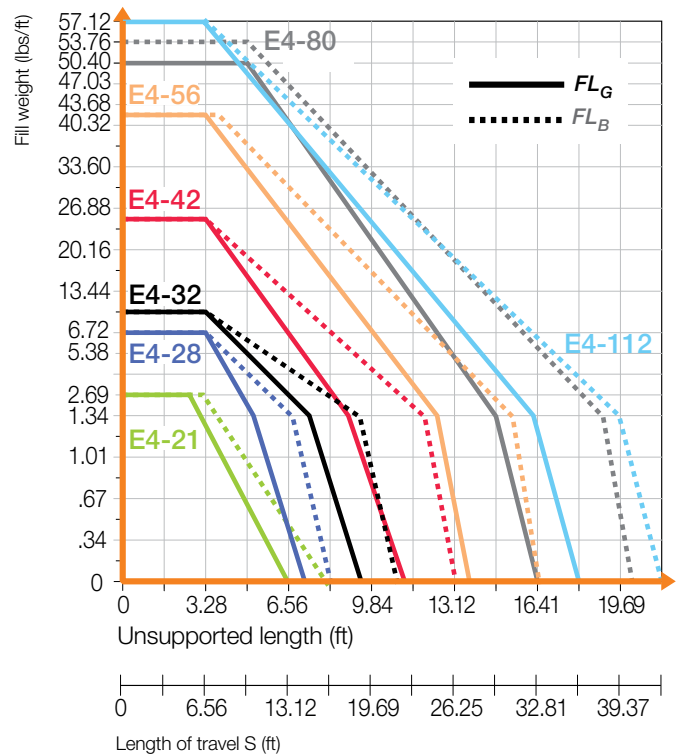

E4-1 Design Features

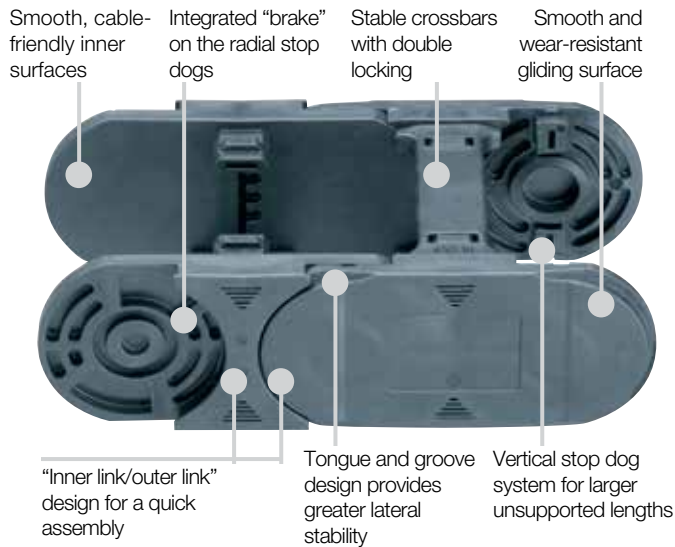

- Available in 40 width sizes in both e-chain® and e-tube
- Interlocking side links for optimum lateral stability, for high push/pull force on long travels
- Long unsupported lengths
- "Brake" and rubber dampers as additional noise-reducing options
- Inner link/outer link design for quick assembly with various interior separation options
- Double locking stable crossbars that open from both sides
- Support Tray tool kit for the support of the lower run
- **Chapter 9**
- Find more technical data about the material, chemical resistance, temperatures ➤ **Chapter 1**

Crossbars every link for particularly demanding applications



Series	Inner height h_i in. (mm)	Inner width B_i in. (mm)	Outer width B_a in. (mm)	Outer height h_a in. (mm)	Bending radius R in. (mm)
E4-21	.82 (21)	1.18-5.51 (30-140)	1.73-5.28 (44-134)	1.10 (28)	1.50-7.87 (38-200)
E4-28	1.10 (28)	1.57-11.81 (40-300)	2.36-12.60 (60-320)	1.65 (42)	2.16-9.84 (55-250)
E4-32	1.26 (32)	1.97-15.75 (50-400)	2.87-16.65 (73-423)	2.13 (54)	2.48-11.81 (63-300)
E4-42	1.65 (42)	1.97-15.75 (50-400)	2.99-16.77 (76-426)	2.52 (64)	2.95-13.78 (75-350)
E4-56	2.20 (56)	1.97-23.62 (50-600)	3.31-24.96 (84-634)	3.31 (84)	5.31-19.69 (135-500)
E4-80	3.15 (80)	1.97-23.62 (50-600)	3.94-25.59 (100-650)	4.25 (108)	5.91-39.37 (150-1000)
E4-112	4.41 (112)	1.97-23.62 (50-600)	4.02-25.67 (102-652)	5.51 (140)	7.87-39.37 (200-1000)
E4-162	6.38 (162)	7.87-23.62 (200-600)	10.08-25.83 (256-656)	7.68 (195)	9.84-39.37 (250-1000)
800	7.87 (200)	7.87-23.62 (200-600)	10.24-25.98 (260-660)	9.29 (236)	12.80-39.37 (325-1000)
840	8.03 (204)	3.94-22.16 (100-563)	6.30-24.53 (160-623)	9.29 (236)	12.80-39.37 (325-1000)
E4-350	13.78 (350)	15.75-31.50 (400-800)	21.26-37.01 (540-940)	17.72 (450)	19.69-39.37 (500-1000)

Crossbars every 2nd link for almost all applications



Series	Inner height h_i in. (mm)	Inner width B_i in. (mm)	Outer width B_a in. (mm)	Outer height h_a in. (mm)	Bending radius R in. (mm)
H4-32	1.26 (32)	1.97-15.75 (50-400)	2.87-16.65 (73-423)	2.13 (54)	2.48-11.81 (63-300)
H4-42	1.65 (42)	1.97-15.75 (50-400)	2.99-16.77 (76-426)	2.52 (64)	2.95-13.78 (75-350)
H4-56	2.20 (56)	1.97-23.62 (50-600)	3.31-24.96 (84-634)	3.31 (84)	5.31-19.69 (135-500)
H4-80	3.15 (80)	1.97-23.62 (50-600)	3.94-25.59 (100-650)	4.25 (108)	5.91-39.37 (150-1000)

e-tubes fully enclosed, for complete cable protection



Series	Inner height h_i in. (mm)	Inner width B_i in. (mm)	Outer width B_a in. (mm)	Outer height h_a in. (mm)	Bending radius R in. (mm)
R4-28	1.10 (28)	1.97-11.81 (50-300)	2.76-12.60 (70-320)	1.65 (42)	2.95-9.84 (75-250)
R4-32	1.26 (32)	1.97-11.81 (50-300)	2.87-12.72 (73-323)	2.13 (54)	4.92-11.81 (125-300)
R4-42	1.65 (42)	1.97-11.81 (50-300)	2.99-12.83 (76-326)	2.52 (64)	4.92-13.78 (125-350)
R4-56	2.20 (56)	2.95-18.19 (75-462)	4.29-19.57 (109-497)	3.31 (84)	5.31-19.69 (135-500)
R4-80	3.15 (80)	5.91-18.19 (150-462)	7.87-20.20 (200-513)	4.25 (108)	7.87-39.37 (200-1000)
R4-112	4.25 (108)	7.87-19.69 (200-500)	9.92-21.73 (252-552)	5.51 (140)	9.84-39.37 (250-1000)

e-chain system® E4-1

Assembly instructions

e-chains® - Opening



1 Remove crossbars - Insert screwdriver into the slot, using a lever action, apply pressure to the screwdriver to remove the crossbar.

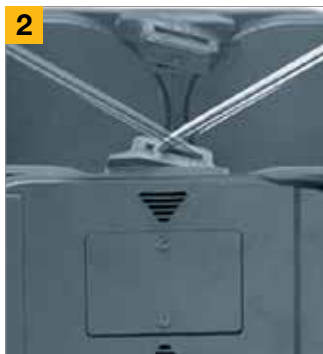

2 Remove clips - Insert screwdriver into the slot, using a lever action, apply pressure to the screwdriver to remove the clip

e-tube - Opening



1 Remove lids/bottoms - Insert screwdriver into the slot, using a lever action apply pressure to the screwdriver to release



2 Release only **one side** to open the lid

e-chains® and e-tubes - Assembling



1 Line up two inner side links side by side. Attach an outer side link between

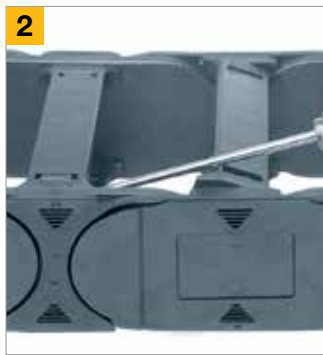

2 Assemble crossbars - push down and snap in using a screwdriver



3 Assemble clips (for e-chains with crossbars every other link) - push down and snap in using a screwdriver



4 Assemble e-tube lids and bottoms - Attach to the connector at an angle and snap in place

e-chains® and e-tubes - Separating



1 Remove crossbars, clips, lids and bottoms at the outer links



2 Insert screwdriver into the slot between the side links. Using a lever action, release the side links



3 Remove the outer links



4 Separate the e-chain®



Available from stock. Orders ship as early as today.*

*On average 90% of orders ship the same day..

Price Index

Series E4-21

Special Options Available

Low noise version available
with special rubber pads



Cleanroom test upon request



ESD classification:
Electrically conductive ESD/
ATEX version upon request

Assembly Tips

Opening e-chains®: Remove crossbars
and clips - Insert screwdriver into the slot,
push down, release by lever action

Other Installation Methods

Vertical, hanging ≤ 131 ft (40 m)

Vertical, standing ≤ 9.84 ft (3 m)

Side-mounted, un_supp. ≤ 3.28 ft (1 m)

Rotary requires further calculation

Usage Guidelines



- If quiet operation is required
- If very high speeds and/or accelerations are required
- Long travels
- High fill weights



- When an economic one-sided snap-open e-chain/tube is required
➤ **Series 1400/1500**
- When a one-sided snap-open e-tube is required at a low price
➤ **Series 1450/1480**

Features & Benefits

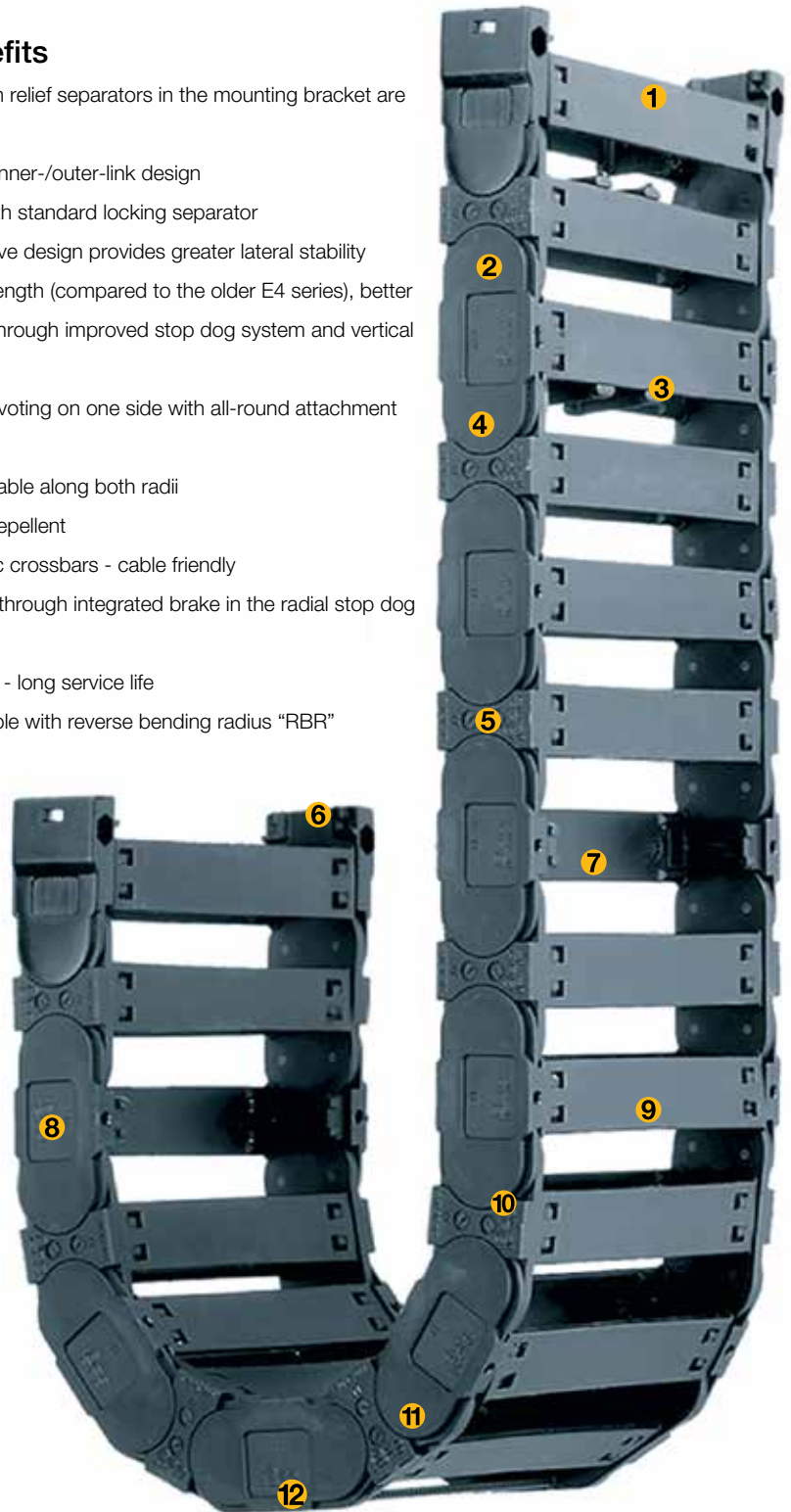
- 1 Strain relief with strain relief separators in the mounting bracket are available
- 2 Straight run through inner-/outer-link design
- 3 Interior separation with standard locking separator
- 4 The tongue and groove design provides greater lateral stability
- 5 15% more tensile strength (compared to the older E4 series), better unsupported length through improved stop dog system and vertical radial stops
- 6 Mounting brackets pivoting on one side with all-round attachment option
- 7 Crossbars are removable along both radii
- 8 Smooth outline, dirt repellent
- 9 Wide, rounded plastic crossbars - cable friendly
- 10 Low-noise operation through integrated brake in the radial stop dog system
- 11 Optimized glide pads - long service life
- 12 e-chains® also available with reverse bending radius "RBR"

Order Example: Complete e-chain®

Please indicate chain length or number of links. Example:

6.56 ft (2 m) **E4-21-120-100-0**

e-chain®

With 2 separators **T2112** assembled every 2nd link

Interior Separation

1 Set **E4-210-120-12**

Mounting Bracket

e-chain system® E4-1

Series E4-21

Installation Dimensions

Short travel, unsupported length

- FL_B = unsupported with permitted sag
- FL_G = unsupported with straight upper run

Further information ► Design, Chapter 1

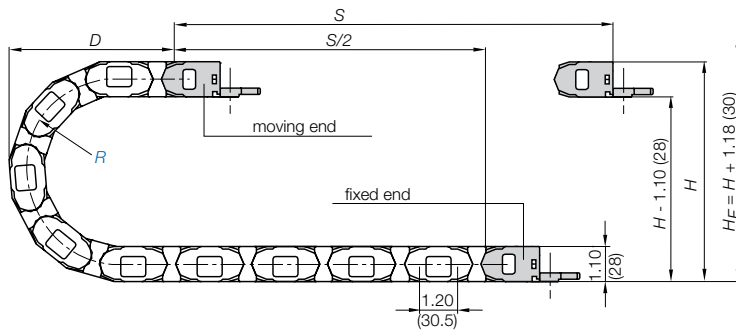
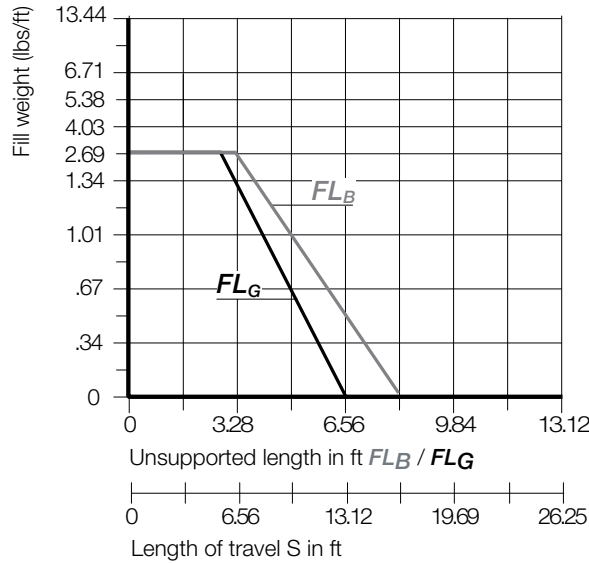
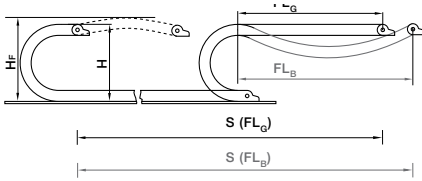

Pitch per link = 1.20" (30.5 mm)
 Links per ft (m) = 10.06 (33)
 For center mount applications:
 Chain length = $\frac{S}{2} + K$

The required clearance height:
 $H_f = H + 1.18$ in. (30 mm) (with 1.01 lbs/ft (1.5 kg/m) fill weight).
 Please consult igus® if space is particularly restricted.

R	1.50 (038)	1.89 (048)	2.48 (063)	2.95 (075)	3.94 (100)	5.91 (150)	7.87 (200)
H	4.09 (104)	4.88 (124)	6.06 (154)	7.01 (178)	8.98 (228)	12.91 (328)	16.85 (428)
D	3.86 (98)	4.25 (108)	4.84 (123)	5.31 (135)	6.30 (160)	8.27 (210)	10.24 (260)
K	7.28 (185)	8.46 (215)	10.24 (260)	11.81 (300)	14.96 (380)	21.06 (535)	27.17 (690)

For long travels with lowered mounting height

Long travel lengths from 32.8 ft. (10m) to max. 394 ft. (120m)

For center mount applications:
 Chain length = $\frac{S}{2} + K_2$

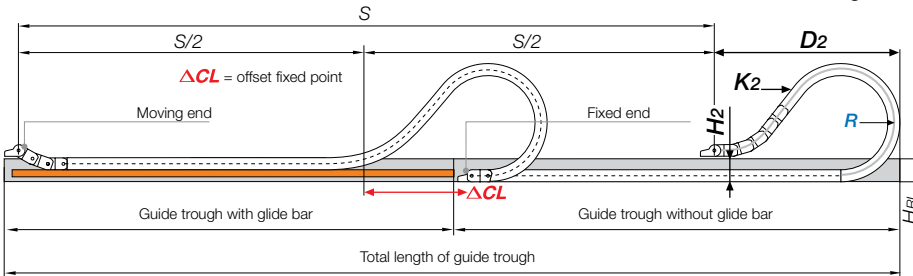

R	1.50 (038)	1.89 (048)	2.48 (063)	2.95 (075)	3.94 (100)	5.91 (150)	7.87 (200)
H ₂	-	-	-	-	5.31 (135)	5.31 (135)	5.31 (135)
D ₂₊₂₅	-	-	-	-	19.29 (490)	20.87 (530)	26.18 (665)
K ₂	-	-	-	-	30.79 (782)	36.22 (920)	43.46 (1104)
ΔACL	-	-	-	-	10.63 (270)	14.57 (370)	18.50 (470)

In case of travels between 13 and 32.8 ft (4 and 10 m) we recommend a longer unsupported length.



E4-21

Short Travels - Unsupported

Unsupported e-chains® feature positive camber over short travels. This must be accounted for when specifying the clearance height. Please refer to **Installation dimensions** for further details.

Legend

- S = Length of travel
 - R = Bending radius
 - H = Nominal clearance height
 - D = Overlength e-chain® radius in final position
 - $K = \pi \cdot R + \text{safety buffer}$
 - H_f = Required clearance height
 - H_{in} = Trough inner height
 - H₂ = *Mounting height
 - D₂ = Overlength - long travels, gliding
 - K₂ = *Add-on
- *If the mounting bracket location is set lower



PDF: igus.com/e-chain-pdfs
 Product information: igus.com/e-chains

Long Travels - Gliding



If the unsupported length is exceeded, the e-chain®/ Tube must glide on itself. This requires a guide trough.

Design, Chapter 1 main catalog



For support of the lower run, see Chapter 9 of the main catalog for the Support Tray tool kit

Technical Data



Details of material properties

► Chapter 1

Speed / acceleration FL_G	max. 65.6 ft/s (20 m/s) / max. 656 ft/s ² (200 m/s ²)
Speed / acceleration FL_B	max. 9.84 ft/s (3 m/s) / max. 19.69 ft/s ² (6 m/s ²)
Gliding speed / acceleration (maximum)	max. 32.8 ft/s (10 m/s) / max. 164 ft/s ² (50 m/s ²)
Material - permitted temperature	igumid G / -40°F (-40°C) up to +248°F (+120°C)
Flammability Class, igumid G	VDE 0304 IIC UL94 HB

Series E4-21 - e-chain® with crossbars every link

igus®
e-chain system®

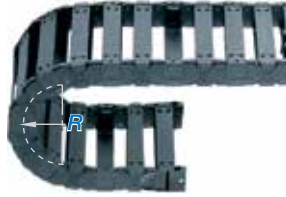
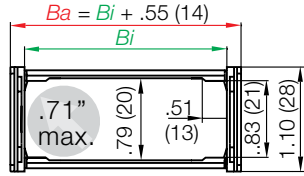

- Crossbars every link
- Removable crossbars
- Separator for locking crossbar (fixable) Standard
- Can be opened from both sides

Part Number Structure

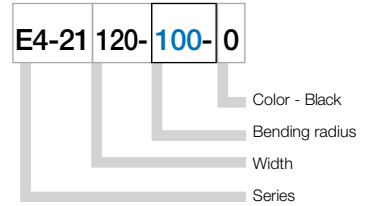

e-chain® as separate parts, links and side plates

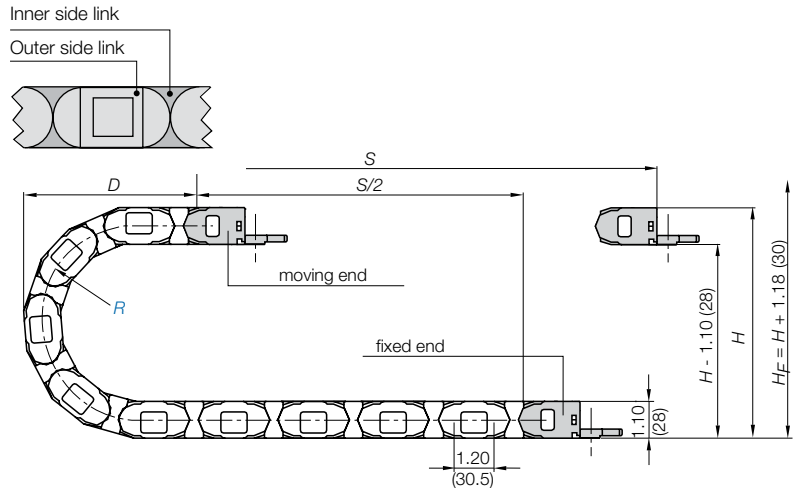
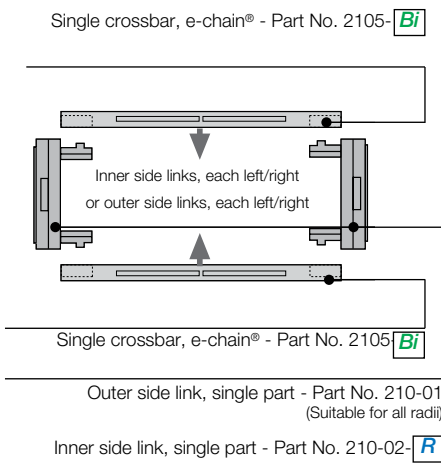

Supplement part number with required radius. Example: E4-21-120-100-0
Pitch: 1.20 in. (30.5 mm) per link links/ft(m) = 10.06 (33)

Part Number.	<i>Bi</i>	<i>Ba</i>	Weight
Snap-open inner radius	in. (mm)	in. (mm)	lbs/ft (kg/m)
E4-21-030-□-0	1.18 (30)	1.73 (44)	≈ 0.40 (0.60)
E4-21-040-□-0	1.57 (40)	2.13 (54)	≈ 0.43 (0.64)
E4-21-050-□-0	1.97 (50)	2.52 (64)	≈ 0.45 (0.67)
E4-21-060-□-0	2.36 (60)	2.91 (74)	≈ 0.48 (0.71)
E4-21-070-□-0	2.76 (70)	3.31 (84)	≈ 0.50 (0.74)
E4-21-080-□-0	3.15 (80)	3.70 (94)	≈ 0.52 (0.78)
E4-21-090-□-0	3.54 (90)	4.09 (104)	≈ 0.55 (0.82)
E4-21-100-□-0	3.94 (100)	4.49 (114)	≈ 0.57 (0.85)
E4-21-110-□-0	4.33 (110)	4.88 (124)	≈ 0.60 (0.89)
E4-21-120-□-0	4.72 (120)	5.28 (134)	≈ 0.62 (0.92)
E4-21-140-□-0	5.51 (140)	6.06 (154)	≈ 0.67 (0.99)

Choose from the radii below for all of the above sizes

Radius (mm) Example: E4-21-120-100-0

	038	048	063	075	100	150	200
<i>R</i>	1.50 (038)	1.89 (048)	2.48 (063)	2.95 (075)	3.94 (100)	5.91 (150)	7.87 (200)
<i>H</i>	4.09 (104)	4.88 (124)	6.06 (154)	7.01 (178)	8.98 (228)	12.91 (328)	16.85 (428)
<i>D</i>	3.86 (98)	4.25 (108)	4.84 (123)	5.31 (135)	6.30 (160)	8.27 (210)	10.24 (260)
<i>K</i>	7.28 (185)	8.46 (215)	10.24 (260)	11.81 (300)	14.96 (380)	21.06 (535)	27.17 (690)

Telephone 1-800-521-2747

Internet: igus.com
email: sales@igus.com
QuickSpec: igus.com/quickSpec

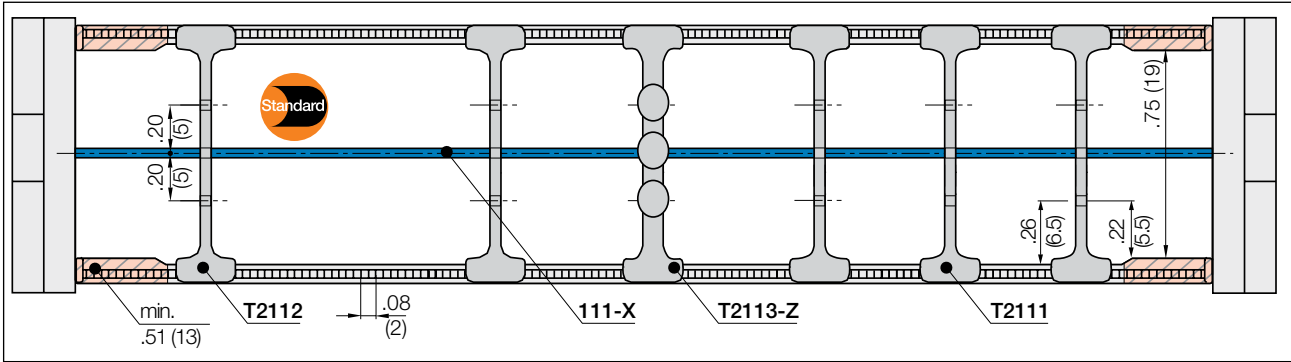

Note: Please maintain a lateral spacing of .51" (13 mm) between the separators and the side links. In the standard configuration separators are assembled every 2nd e-chain® link

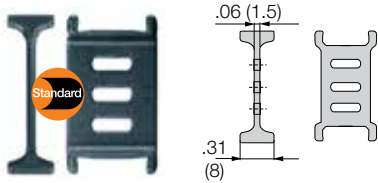

Separator, wide base

Unassembled	Part No. T2102
Assembled	Part No. T2112

- **Standard separator T2102**
 is used when vertical separation is required. Due to its slot, it allows basic vertical/horizontal shelving arrangements.

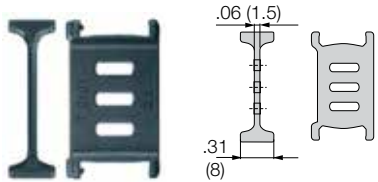

Separator, narrow head

Unassembled	Part No. T2101
Assembled	Part No. T2111

- **Notch separator T2101**
 Can be locked in .08 (2mm) increments due to notches on the crossbars of the e-chain®. The separator cannot slide sideways during operation.

Full-width shelves - for the standard interior separation

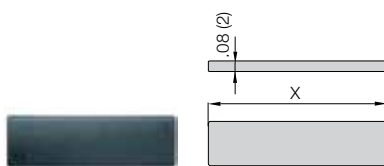

Full width shelf

Unassembled	Part No. 110-X
Assembled	Part No. 111-X

- **Full width shelf 110-X**
 is used in applications with many thin cables with similar diameters. Full width shelves can be arranged at 3 different heights in .20" (5 mm) increments.

Width X in. (mm)	Part No. Unassembled	Part No. Assembled	Width X in. (mm)	Part No. Unassembled	Part No. Assembled	Width X in. (mm)	Part No. Unassembled	Part No. Assembled
1.18 (30)	110-30	111-30	2.76 (70)	110-70	111-70	4.33 (110)	110-110	111-110
1.57 (40)	110-40	111-40	3.15 (80)	110-80	111-80	4.72 (120)	110-120	111-120
1.97 (50)	110-50	111-50	3.54 (90)	110-90	111-90			
2.36 (60)	110-60	111-60	3.94 (100)	110-100	111-100			



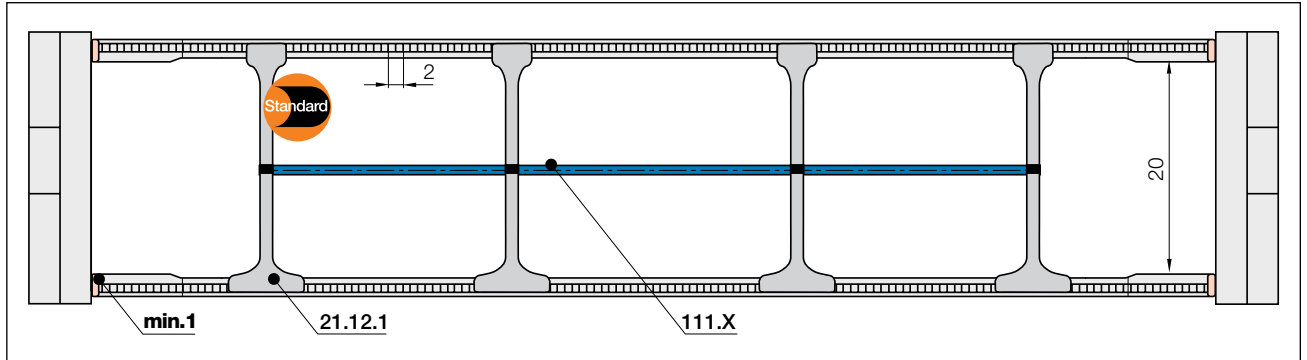

Note: Please maintain a lateral spacing of .51" (13 mm) between the separators and the side links. In the standard configuration separators are assembled every 2nd e-chain® link

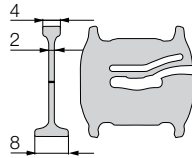

Lean Separator

Unassembled	Part No. 21-12
Assembled	Part No. 21-12-1

- **Lean separators 31-12**

New design allows extremely fast fitting of shelves in several layers, which significantly reduces assembly time. Enables extremely fast replacement of individual cables in a very full e-chain®.



- **Lean separator design - several layers of cables fitted quickly, save up to 50%* assembly time** (*Lean separator vs. standard separator - measured on a 4m long e-chain® fitted with 12 cables in the igus® harnessing factory)

Separator with integrated strain relief teeth

- Can be integrated into the mounting bracket or placed at any point in the e-chain®
- Combines strain relief and interior separation, for restricted space conditions
- Strain relief separator is easy to assemble without any screws

Part No. T2103.Z. **More information** ► Chapter 10



Aluminum support tray

- Corrosion-resistant and seawater-resistant aluminium rails with adjustable width
- Noise-reducing glide strip integrated as standard
- Easy installation and connection of the e-chain®
- Open design - dirt and debris fall through

More information ► Chapter 9



Reduce assembly time - E4 e-chain® opener

- e-chain® opener tools for easy opening and closing of e-chains®
- Simple opening and closing of e-chain® crossbars
- Also for use in hard to reach locations
- Significant assembly time reduction

More information ► www.igus.com/E4savetime



e-chain system® E4-1

Series E4-21

Mounting Brackets - Polymer



E4-21



Option: pivoting

- Recommended for unsupported and gliding applications
- KMA mounting bracket with attachment points on all sides
- Well suited for tight installation conditions
- Integrated strain relief possible



Part Number Structure

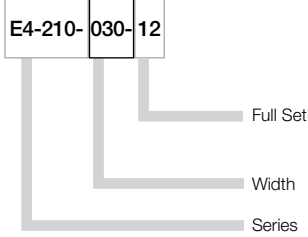

Full set, for both ends:

E4-210-030-12

Single-part order:

E4-210-030-1 Mounting bracket moving end

E4-210-030-2 Mounting bracket fixed end

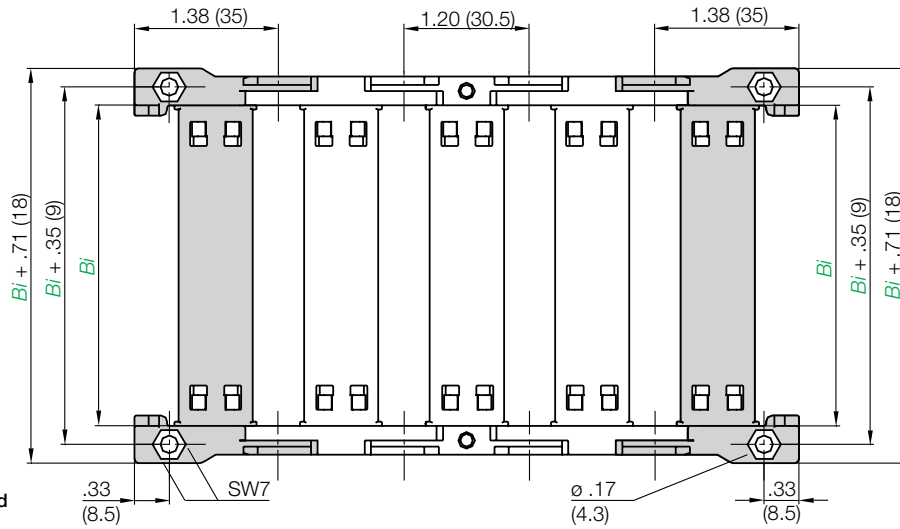

Width	Part No. Full Set	Bi in. (mm)	Width	Part No. Full Set	Bi in. (mm)
-030	E4-210-030-12	1.18 (30)	-090	E4-210-090-12	3.54 (90)
-040	E4-210-040-12	1.57 (40)	-100	E4-210-100-12	3.94 (100)
-050	E4-210-050-12	1.97 (50)	-110	E4-210-110-12	4.33 (110)
-060	E4-210-060-12	2.36 (60)	-120	E4-210-120-12	4.72 (120)
-070	E4-210-070-12	2.75 (70)	-140	E4-210-140-12	5.51 (140)
-080	E4-210-080-12	3.15 (80)			



Special feature mounting brackets KMA: Series E4-21

- Mounting brackets with attachment points on all sides
- Mounting hole is countersunk for socket head screw (M4) and hexagon nut (M4)
- **Attention:** Series E4-21 always needs to end with an inner link (odd number of links)



igus®
e-chain system®

Telephone 1-800-521-2747

Internet: igus.com
email: sales@igus.com
QuickSpec: igus.com/quickspec

E4-28
R4-28



e-chain system® E4-1 Series E4-28/R4-28



Price Index

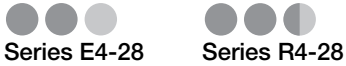

Special Options Available

- Low noise version available with special rubber pads
- Cleanroom test upon request
- ESD classification: Electrically conductive ESD/ATEX version upon request

Assembly Tips



Opening e-chains®: Remove crossbars and clips - Insert screwdriver into the slot, push down, release by lever action



Remove lids/bottoms (e-tubes) - Insert screwdriver into the slot, release by lever action

Other Installation Methods

- Vertical, hanging ≤ 262 ft (80 m)
- Vertical, standing ≤ 16.4 ft (5 m)
- Side-mounted, unsupp. ≤ 3.94 ft (1.2 m)
- Rotary requires further calculation

Usage Guidelines

- If quiet operation is required
- If very high speeds and/or accelerations are required
- Long travels
- High fill weights
- When an extremely low vibration e-chain®/e-tube is required
 - Series E6-29
 - Series R6-29
- When an economic one-sided snap-open e-chain®/e-tube is required
 - Series 2400/2450/2480/2500

Features & Benefits

- Wide, rounded plastic crossbars - cable friendly
- Low-noise operation through integrated brake in the radial stop dog system
- Hinged snap-open removable lids along outer radius of e-tube
- Straight run through inner-/outer-link design
- The tongue and groove design provides greater lateral stability
- 15% more tensile strength (compared to the older E4 series), better Optimized glide pads - long service life
- Shelving program with a wide range of options
- Crossbars are removable along both radii
- 15% more tensile strength (compared to the best E4 series), better unsupported length through improved stop dog system and vertical radial stops
- Version NCST "without camber" simply by turning outer links without unnecessary rework

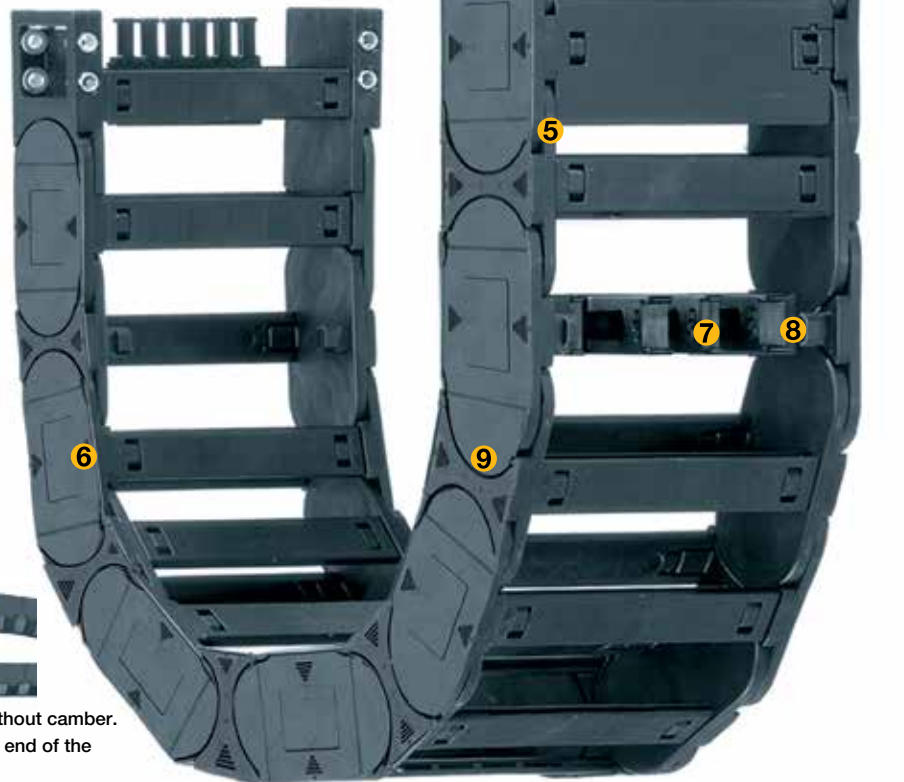

Also available without camber. Add NCST to the end of the part number.
Ex: E4-28-300-250NCST

Order Example: Complete e-chain®

Please indicate chain length or number of links. Example:

9.84 ft (3 m) **E4-28-300-250-0**

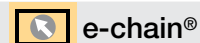

With 2 separators **2211** assembled every 2nd link

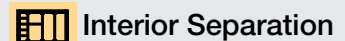

1 Set **E4-280-300-12**



e-chain system® E4-1

Series E4-28/R4-28

Installation Dimensions



E4-28
R4-28

Short travel, unsupported length

- FL_B = unsupported with permitted sag
 - FL_G = unsupported with straight upper run
- Further information ► Design, Chapter 1

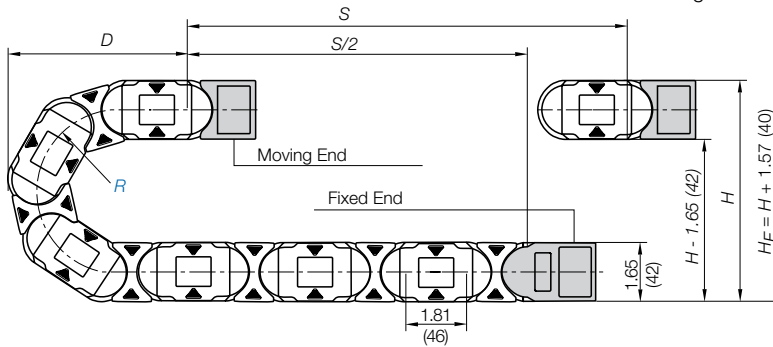
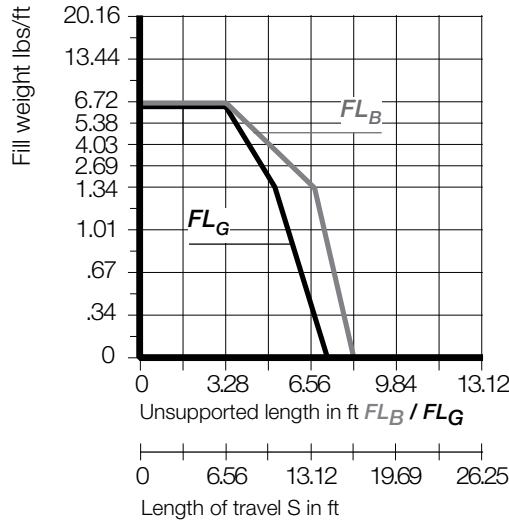
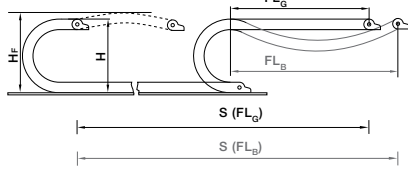

Pitch per link = 1.81" (46 mm)
Links per ft (m) = 6.71 (22)
For center mount applications:
Chain length = $\frac{S}{2} + K$

The required clearance height: $H_f = H +$ (with .67 lbs/ft (1.0 kg/m) fill weight).
Please consult igus® if space is particularly restricted.

R	2.17 (055)	2.48 (063)	2.95 (075)	3.94 (100)	4.92 (125)	5.91 (150)	6.89 (175)	7.87 (200)	9.84 (250)
H	5.98 (152)	6.61 (168)	7.56 (192)	9.53 (242)	11.50 (292)	13.46 (342)	15.43 (392)	17.40 (442)	21.34 (542)
D	5.71 (145)	6.02 (153)	6.50 (165)	7.48 (190)	8.46 (215)	9.45 (240)	10.43 (265)	11.42 (290)	13.39 (340)
K	10.43 (265)	11.42 (290)	12.99 (330)	16.14 (410)	19.09 (485)	22.24 (565)	25.39 (645)	28.54 (725)	34.65 (880)

For long travels with lowered mounting height

Long travel lengths from 32.8 ft.(10m) to max. 656 ft. (200m)

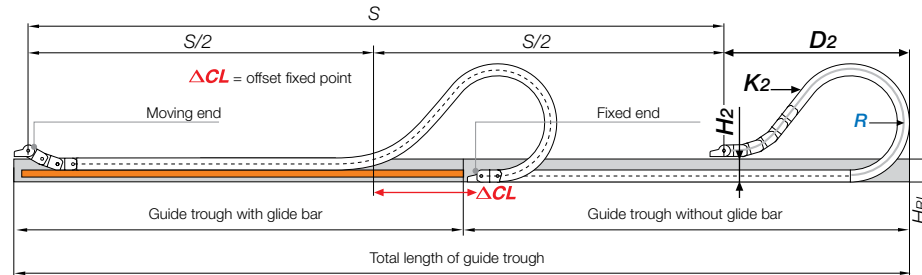

R	2.17 (055)	2.48 (063)	2.95 (075)	3.94 (100)	4.92 (125)	5.91 (150)	6.89 (175)	7.87 (200)	9.84 (250)
H ₂	-	-	-	6.22 (158)	6.22 (158)	6.22 (158)	6.22 (158)	6.22 (158)	6.22 (158)
D ₂	-	-	-	13.78 (350)	19.29 (490)	20.87 (530)	26.18 (665)	28.74 (730)	36.81 (935)
K ₂	-	-	-	23.54 (598)	30.79 (782)	36.22 (920)	43.46 (1104)	48.89 (1242)	63.39 (1610)
ΔCL	-	-	-	5.91 (150)	10.63 (270)	11.81 (300)	15.75 (400)	17.72 (450)	23.62 (600)

In case of travels between 13 and 32.8 ft (4 and 10 m) we recommend a longer unsupported length.

For center mount applications:
Chain length = $\frac{S}{2} + K_2$

Short Travels - Unsupported

Unsupported e-chains® feature positive camber over short travels. This must be accounted for when specifying the clearance height. Please refer to **Installation dimensions** for further details.

Legend

- S = Length of travel
- R = Bending radius
- H = Nominal clearance height
- D = Overlength e-chain® radius in final position
- $K = \pi \cdot R + \text{safety buffer}$
- H_f = Required clearance height
- H_{in} = Trough inner height
- H₂ = *Mounting height
- D₂ = Overlength - long travels, gliding
- K₂ = *Add-on

*If the mounting bracket location is set lower

Long Travels - Gliding



If the unsupported length is exceeded, the e-chain®/ Tube must glide on itself. This requires a guide trough.

Design, Chapter 1



For support of the lower run, see **Chapter 9** of the main catalog for the **Support Tray** tool kit

Technical Data



Details of material properties

► Chapter 1



PDF: igus.com/e-chain-pdfs
Product information: igus.com/e-chains



Series E4-28 - e-chain® with crossbars every link

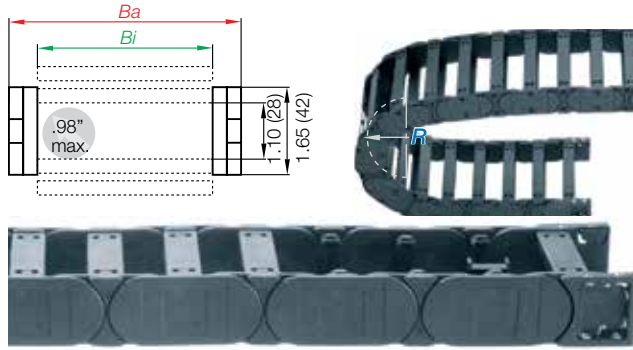

- Robust solution with crossbars every link
- Can be opened from two sides
- Removable crossbars

Part Number Structure

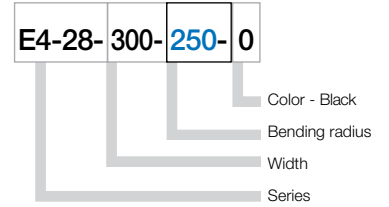

Series R4-28 - fully enclosed e-tube

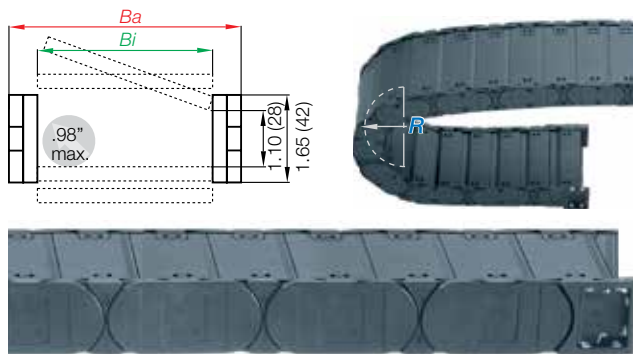

- Fully enclosed
- Excellent cable and hose protection against dirt
- Protection against hot chips
- Lids along inner radius are completely removable
- Lids along the outer radius are single-sided, snap open, hinged on one side as well as completely removable

Part Number Structure

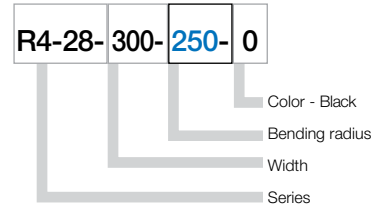

e-chain® as separate parts, links and side plates

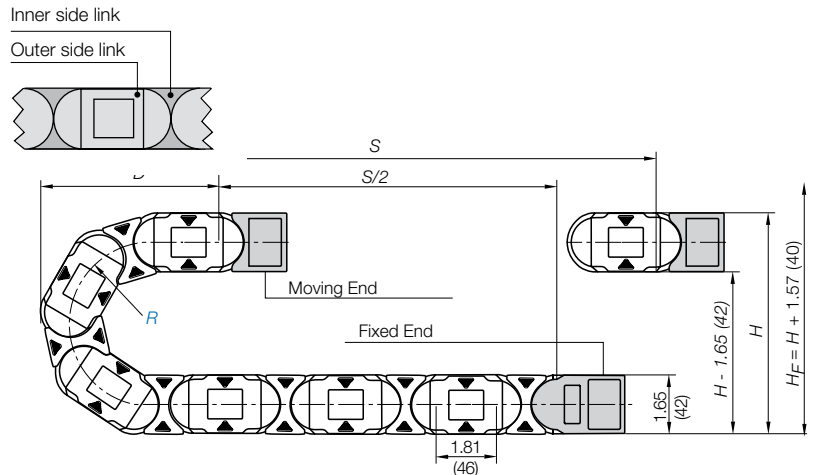
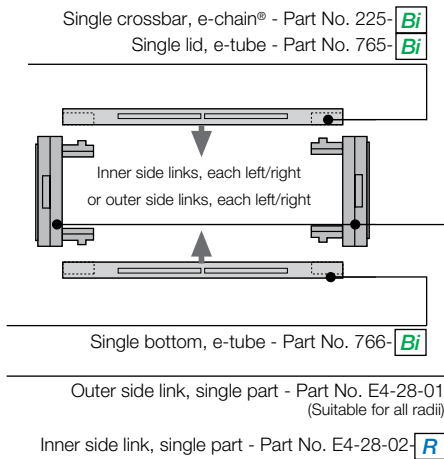

e-chain system® E4-1

Series E4-28/R4-28

Product Range



E4-28
R4-28

Supplement part number with required radius. Example: E4-28-300--0
Pitch: 1.81 in. (46mm) per link links/ft (m) = 6.71 (22)

Part Number.				<i>Bi</i>	<i>Ba</i>	E4-28	R4-28
Crossbars	Tube			in. (mm)	in. (mm)	lbs/ft (kg/m)	lbs/ft (kg/m)
Every link	Version						
E4-28-040-		<input type="text" value=""/>	-0	1.57 (40)	2.36 (60)	≈ 0.71 (1.06)	–
E4-28-050-	R4-28-050-	<input type="text" value=""/>	-0	1.97 (50)	2.76 (70)	≈ 0.75 (1.11)	≈ 1.48 (2.20)
E4-28-052		<input type="text" value=""/>	-0	2.05 (52)	2.83 (72)	≈ 0.76 (1.13)	–
E4-28-062-		<input type="text" value=""/>	-0	2.44 (62)	3.23 (82)	≈ 0.79 (1.17)	–
E4-28-070-		<input type="text" value=""/>	-0	2.76 (70)	3.54 (90)	≈ 0.81 (1.20)	–
E4-28-075-	R4-28-075	<input type="text" value=""/>	-0	2.95 (75)	3.74 (95)	≈ 0.83 (1.23)	≈ 1.56 (2.32)
E4-28-087-		<input type="text" value=""/>	-0	3.43 (87)	4.21 (107)	≈ 0.86 (1.28)	–
E4-28-100-	R4-28-100-	<input type="text" value=""/>	-0	3.94 (100)	4.72 (120)	≈ 0.92 (1.37)	≈ 1.71 (2.54)
E4-28-125-	R4-28-125-	<input type="text" value=""/>	-0	4.92 (125)	5.71 (145)	≈ 1.01 (1.51)	≈ 1.87 (2.78)
E4-28-150-	R4-28-150-	<input type="text" value=""/>	-0	5.91 (150)	6.69 (170)	≈ 1.08 (1.61)	≈ 2.03 (3.02)
E4-28-175-	R4-28-175-	<input type="text" value=""/>	-0	6.89 (175)	7.68 (195)	≈ 1.15 (1.71)	≈ 2.19 (3.26)
E4-28-200-	R4-28-200-	<input type="text" value=""/>	-0	7.87 (200)	8.66 (220)	≈ 1.24 (1.84)	≈ 2.35 (3.50)
E4-28-225-	R4-28-225-	<input type="text" value=""/>	-0	8.86 (225)	9.65 (245)	≈ 1.34 (1.99)	≈ 2.57 (3.82)
E4-28-250-	R4-28-250-	<input type="text" value=""/>	-0	9.84 (250)	10.63 (270)	≈ 1.44 (2.14)	≈ 2.67 (3.98)
E4-28-275-		<input type="text" value=""/>	-0	10.83 (275)	11.61 (295)	≈ 1.53 (2.27)	–
E4-28-300-	R4-28-300-	<input type="text" value=""/>	-0	11.81 (300)	12.60 (320)	≈ 1.61 (2.39)	≈ 3.00 (4.46)

Choose from the radii below for all of the above sizes
Radius (mm) Example: E4-28-300--0

	<input type="text" value="055*"/>	<input type="text" value="063*"/>	<input type="text" value="075"/>	<input type="text" value="100"/>	<input type="text" value="125"/>	<input type="text" value="150"/>	<input type="text" value="175"/>	<input type="text" value="200"/>	<input type="text" value="250"/>
<i>R</i>	2.17 (055*)	2.48 (063*)	2.95 (075)	3.94 (100)	4.92 (125)	5.91 (150)	6.89 (175)	7.87 (200)	9.84 (250)
<i>H</i>	5.98 (152)	6.61 (168)	7.56 (192)	9.53 (242)	11.50 (292)	13.46 (342)	15.43 (392)	17.40 (442)	21.34 (542)
<i>D</i>	5.71 (145)	6.02 (153)	6.50 (165)	7.48 (190)	8.46 (215)	9.45 (240)	10.43 (265)	11.42 (290)	13.39 (340)
<i>K</i>	10.43 (265)	11.42 (290)	12.99 (330)	16.14 (410)	19.09 (485)	22.24 (565)	25.39 (645)	28.54 (725)	34.65 (880)

* This radius is not available for the R4-28 Series

0 = Standard color black.

For other colors see Chapter 1

PDF: igus.com/e-chain-pdfs
Product information: igus.com/e-chains



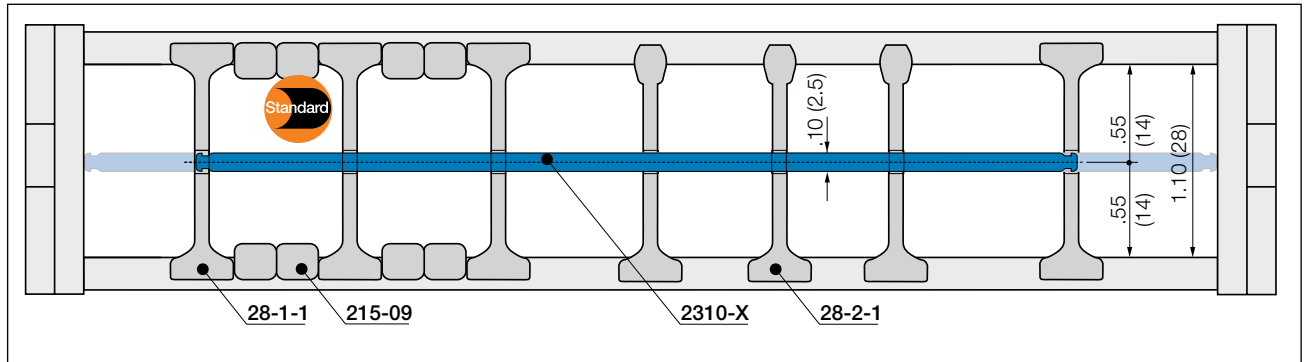

In the standard configuration separators are assembled every 2nd e-chain® link

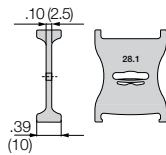

Separator, wide base

Unassembled	Part No. 28-1
Assembled	Part No. 28-1-1

- **Standard separator 28-1 for all applications**

Separator with wide base for maximum locking strength and safe standing in e-chains®.

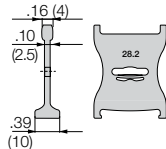

Separator, narrow head

Unassembled	Part No. 28-2
Assembled	Part No. 28-2-1

- **Separator 28-2 For even faster installation**
is used when vertical and horizontal separation is required. Due to its slot, it allows basic vertical/horizontal shelving arrangements.

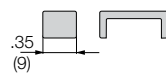

Spacer for e-chains®

Unassembled	Part No. 205-09
Assembled	Part No. 215-09

- **Spacer 205-09**
Separators can be fixed in position by spacers. The available interior height is reduced by .08 (2 mm) per spacer (.16 (4 mm) when spacers are fitted on both sides. To avoid this, the parts can also be installed from the outside on the opening crossbar. (Not for long travel applications.)

Lockable full-width shelves - for the standard interior separation

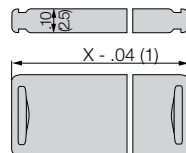

Full width shelf, lockable

Unassembled	Part No. 2300-X
Assembled	Part No. 2310-X

- **Full width shelf, lockable**
is used when vertical and horizontal separation is required. Due to its slot, it allows basic vertical/horizontal shelving arrangements.

Width X in. (mm)	Part No. Unassembled	Part No. Assembled	Width X in. (mm)	Part No. Unassembled	Part No. Assembled	Width X in. (mm)	Part No. Unassembled	Part No. Assembled
015	2300-15	2310-15	060	2300-60	2310-60	087	2300-87	2310-87
025	2300-25	2310-25	062	2300-62	2310-62	090	2300-90	2310-90
030	2300-30	2310-30	065	2300-65	2310-65	100	2300-100	2310-100
038	2300-38	2310-38	070	2300-70	2310-70	103	2300-103	2310-103
040	2300-40	2310-40	075	2300-75	2310-75	110	2300-110	2310-110
050	2300-50	2310-50	077	2300-77	2310-77	120	2300-120	2310-120
057	2300-57	2310-57	080	2300-80	2310-80	125	2300-125	2310-125

Separator with integrated strain relief teeth

- Can be integrated into the mounting bracket or placed at any point in the e-chain®
- Combines strain relief and interior separation, for restricted space conditions
- Strain relief separator is easy to assemble without any screws

Part No. T2103.Z. More information ► Chapter 10



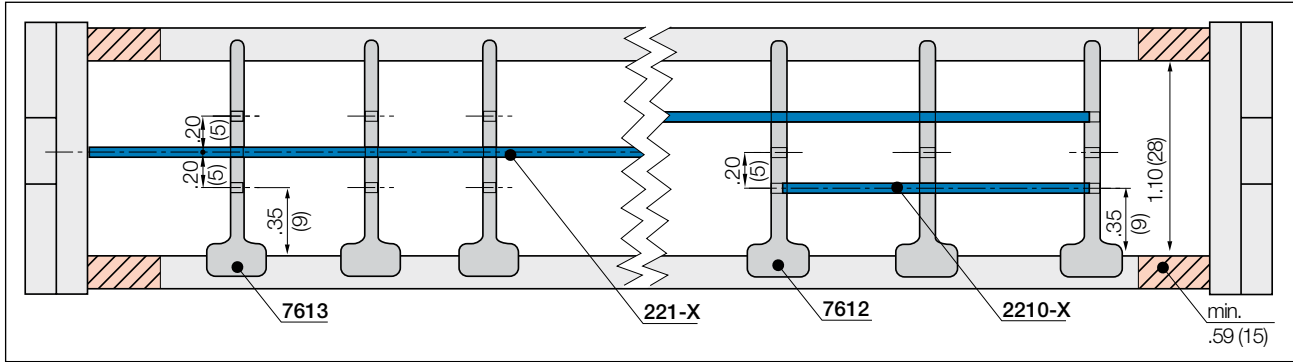

Note e-tube: Please maintain a lateral spacing of .59" (15 mm) between the separators and the side links. In the standard configuration separators are assembled every 2nd e-chain® link

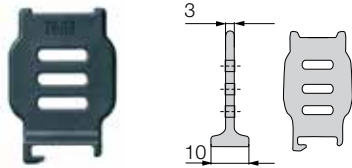

Separator, e-tubes only

Unassembled	Part No. 7603
Assembled	Part No. 7613

- **Slotted separator for full-width shelves** is used when vertical separation is required. Due to its slot, it allows basic vertical/horizontal shelving arrangements.

Full-width shelves - for the standard interior separation

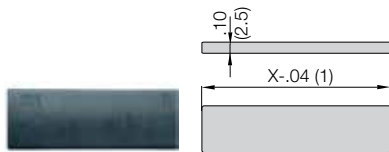

Full width shelf

Unassembled	Part No. 220-X
Assembled	Part No. 221-X

- **Full width shelf 220-X** is used in applications with many thin cables with similar diameters. Full width shelves can be arranged at 3 different heights in .20" (5 mm) increments.

Width X in. (mm)	Part No. Unassembled	Part No. Assembled	Width X in. (mm)	Part No. Unassembled	Part No. Assembled	Width X in. (mm)	Part No. Unassembled	Part No. Assembled
1.57 (40)	220-40	221-40	2.95 (75)	220-75	221-75	5.91 (150)	220-150	221-150
1.97 (50)	220-50	221-50	3.43 (87)	220-87	221-87	6.89 (175)	220-175	221-175
2.44 (62)	220-62	221-62	3.94 (100)	220-100	221-100	7.87 (200)	220-200	221-200
2.76 (70)	220-70	221-70	1.92 (125)	220-125	221-125			

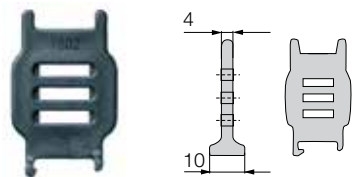

Slotted separator

Unassembled	Part No. 7602
Assembled	Part No. 7612

- **Slotted separator for partial shelves 7602** Can be locked in .08 (2mm) increments due to notches on the crossbars of the e-chain®. The separator cannot slide sideways during operation.

Shelves - for the standard interior separation

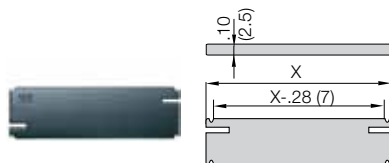

Shelf for e-tubes

Unassembled	Part No. 2200-X
Assembled	Part No. 2210-X

- **Shelves 2200-X** is used in applications with many cables with different diameters. Shelves can be fitted at different heights.

Width X	Part No. Unassembled	Part No. Assembled	Width X	Part No. Unassembled	Part No. Assembled	Width X	Part No. Unassembled	Part No. Assembled
018	2200-18	2210-40	043	2200-43	2210-87	088	2200-88	2210-200
023	2200-23	2210-50	048	2200-48	221-100	099	2200-99	2210-200
028	2200-28	2210-62	058	2200-58	2210-125	124	2200-124	2210-200
033	2200-33	2210-70	068	2200-68	2210-150	149	2200-149	2210-200
038	2200-38	2210-75	073	2200-73	2210-175			





Option 1: Vertical separators and spacers

Vertical separators are used if a vertical subdivision of the e-chain® interior is required. By standard, vertical separators are assembled every other e-chain® link.

NOTE: Observe a lateral spacing of at least .79 in. (20mm) for e-tubes and

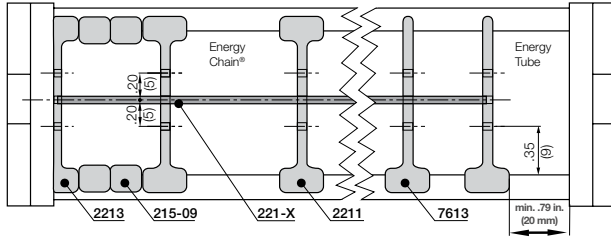

STANDARD



Vertical separator 2201

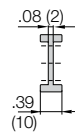

Vertical separator (Chain only)

Unassembled	Part No. 2201
Assembled	Part No. 2211

- **Vertical separator 2201 for e-chains®**
This separator is used for vertical subdivision. Because they are slotted, separators can also be used horizontally to form simple compartments.



Side plate 2203

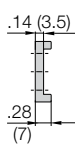

Side plate (chain only)

Unassembled	Part No. 2203
Assembled	Part No. 2213

- **Side plate 2203 for e-chains®**
Used in conjunction with full-width shelf 220-X, this option is used for applications involving many thin cables with similar diameters.



Spacers 205-09



Spacer (chain only)

Unassembled	Part No. 205-09
Assembled	Part No. 215-09

- **NOTE ON SPACERS**
Vertical separators are adjustable, but can be fixed in position by means of a spacer. Spacers are most often necessary for side mounted applications. The available inner height is reduced by .08" (2mm) **per spacer** (for example if one spacer is placed on either side of the separator, the overall inner height is reduced by .16" (4mm)). To avoid this, place the spacers on the **outside** of the opening crossbar (**not for long travels**).

Full-width shelf 220-XX

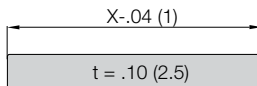

Width X in. (mm)	Part No.		Width X in. (mm)	Part No.	
	Unassembled	Assembled		Unassembled	Assembled
1.57 (040)	220-40	221-40	3.94 (100)	220-100	221-100
1.97 (050)	220-50	221-50	4.92 (125)	220-125	221-125
2.44 (062)	220-62	221-62	5.91 (150)	220-150	221-150
2.76 (070)	220-70	221-70	6.89 (175)	220-175	221-175
2.95 (075)	220-75	221-75	7.87 (200)	220-200	221-200
3.43 (087)	220-87	221-87			

e-chain system® E4-1
 Series R4-28
 Interior Separation - Previous Generation



E4-28
 R4-28



Option 2: Shelves

e-chains® and e-tubes can be subdivided both vertically and horizontally using the various interior separation elements.

► **Design, Chapter 1**, for layout recommendations.

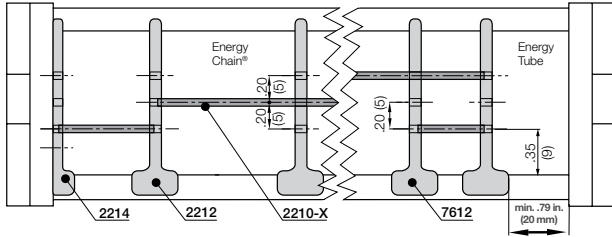

• **Side plates 2204**

This component is used to form the basic pattern of a shelf system.

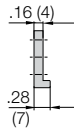

Side plate

Unassembled	Part No. 2204
Assembled	Part No. 2214

Side plate
2204



• **Vertical separator 2202 for e-chain®**

This component is used to form the basic pattern of a shelf system.

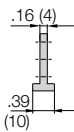

**Vertical separator
(chain only)**

Unassembled	Part No. 2202
Assembled	Part No. 2212

Vertical separator
2202



Shelves 420-XX

These components form the basic pattern of a shelf system. Shelves of various widths can be arranged at 3 different heights in .20" (5mm) increments

Width X in. (mm)	Part No. Unassembled	Part No. Assembled	Width X in. (mm)	Part No. Unassembled	Part No. Assembled
.71 (18)	2200-18	2210-18	2.28 (58)	2200-58	2210-58
.91 (23)	2200-23	2210-23	2.68 (68)	2200-68	2210-68
1.10 (28)	2200-28	2210-28	2.87 (73)	2200-73	2210-73
1.30 (33)	2200-33	2210-33	3.46 (88)	2200-88	2210-88
1.50 (38)	2200-38	2210-38	3.90 (99)	2200-99	2210-99
1.69 (43)	2200-43	2210-43	4.88 (124)	2200-124	2210-124
1.89 (48)	2200-48	2210-48	5.87 (149)	2200-149	2210-149

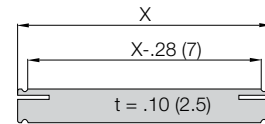

PDF: igus.com/e-chain-pdfs
 Product information: igus.com/e-chains



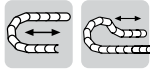

Standard

Option 1: pivoting

- Unsupported and gliding applications
- mounting capabilities on all sides
- Bolted connection outside of chain cross-section
- Space-restricted conditions
- corrosion-resistant

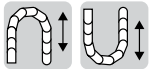
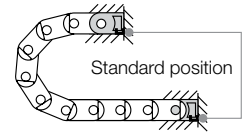
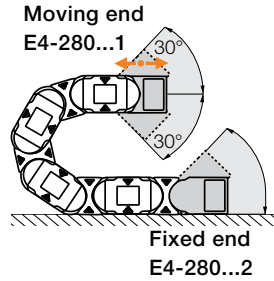

Option 2: locking

- Vertical hanging/standing applications
- For high accelerations
- Universally mountable
- Various mounting positions
- Corrosion-resistant

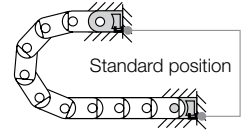
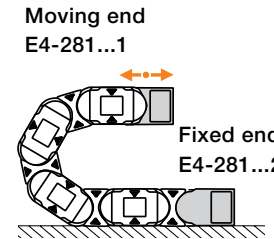

Part Number Structure

E4-281-040-2-12

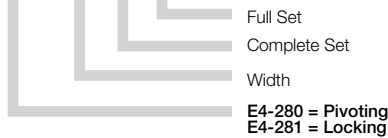

Full set, for both ends:

E4-280-040-12

Single-part order:

E4-280-040-1

Mounting bracket moving end

E4-280-040-2

Mounting bracket fixed end

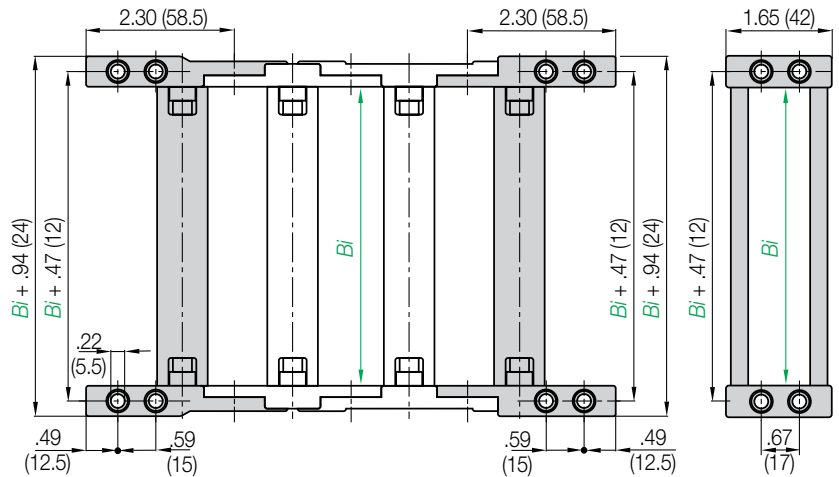

Part number example is shown for pivoting brackets.
For locking brackets change part number to E4-281

Part No. Full Set (pivoting)
Series E4-28
E4-28-Width-12

Width	Part No. Full Set			Bi in. (mm)
	Pivoting	Locking		
-040	E4-280	E4-281	-040-12	1.57 (40)
-050	E4-280	E4-281	-050-12	1.97 (50)
-052	E4-280	E4-281	-052-12	2.05 (52)
-062	E4-280	E4-281	-062-12	2.44 (62)
-070	E4-280	E4-281	-070-12	2.76 (70)
-075	E4-280	E4-281	-075-12	2.95 (75)
-087	E4-280	E4-281	-087-12	3.43 (87)
-100	E4-280	E4-281	-100-12	3.94 (100)
-125	E4-280	E4-281	-125-12	4.92 (125)
-150	E4-280	E4-281	-150-12	5.91 (150)
-175	E4-280	E4-281	-175-12	6.89 (175)
-200	E4-280	E4-281	-200-12	7.87 (200)
-225	E4-280	E4-281	-225-12	8.86 (225)
-250	E4-280	E4-281	-250-12	9.84 (250)
-275	E4-280	E4-281	-275-12	10.83 (275)
-300	E4-280	E4-281	-300-12	11.81 (300)

Due to the design of the E4-28 series chains,
please note the following when ordering brackets:

Even number of links = full set, part number ending in -12
Odd number of links = 2 pieces, part number ending in -1

Strain relief tiwrap plate
Part No. 2050-Z can be fixed
on the last crossbar.
Details ► chapter 10 main catalog

Part. No.	Width [mm]	Number of teeth
2050.Z	60	6

e-chain system® E4-1

Series R4-28

Mounting Bracket - KMA



E4-28
R4-28



Option 1: pivoting

- Unsupported and gliding applications
- mounting capabilities on all sides
- Bolted connection outside of chain cross-section
- Space-restricted conditions
- corrosion-resistant

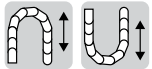
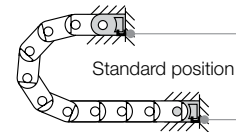
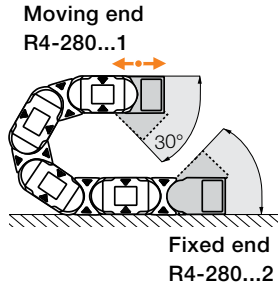

Option 2: locking

- Vertical hanging/standing applications
- For high accelerations
- Universally mountable
- Various mounting positions
- Corrosion-resistant

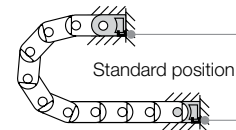
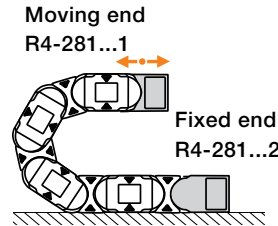

Part Number Structure

R4-281-040-2-12

- Full Set
- Complete Set
- Width
- R4-280 = Pivoting
- R4-281 = Locking

Full set, for both ends:

R4-280-040-12

Single-part order:

R4-280-040-1

Mounting bracket moving end

R4-280-040-2

Mounting bracket fixed end

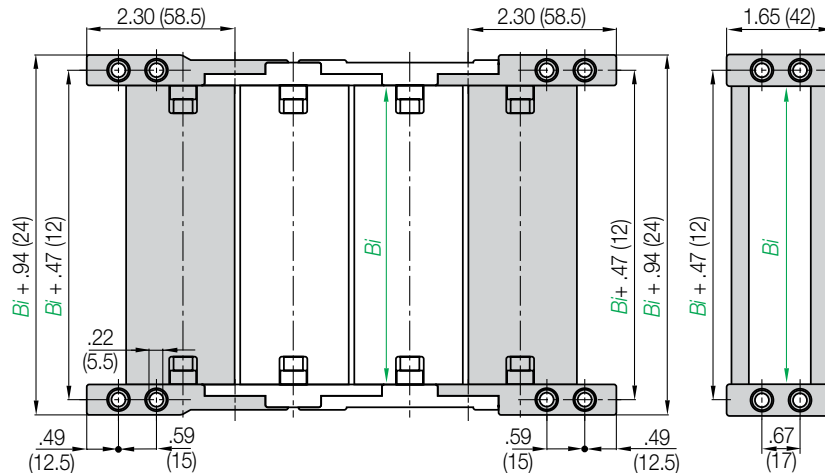

Part number example is shown for pivoting brackets.
For locking brackets change part number to R4-281

Part No. Full Set (pivoting)
Series R4-28
R4-28-Width-12

Width	Part No. Full Set		Bi	in. (mm)
	Pivoting	Locking		
-050	R4-280	R4-281	-050-12	1.97 (50)
-075	R4-280	R4-281	-075-12	2.95 (75)
-100	R4-280	R4-281	-100-12	3.94 (100)
-125	R4-280	R4-281	-125-12	4.92 (125)
-150	R4-280	R4-281	-150-12	5.91 (150)
-175	R4-280	R4-281	-175-12	6.89 (175)
-200	R4-280	R4-281	-200-12	7.87 (200)
-225	R4-280	R4-281	-225-12	8.86 (225)
-250	R4-280	R4-281	-250-12	9.84 (250)
-300	R4-280	R4-281	-300-12	11.81 (300)

Due to the design of the E4-28 series chains,
please note the following when ordering brackets:

Even number of links = full set, part number ending in -12
Odd number of links = 2 pieces, part number ending in -1



Strain relief tiwrap plate
Part No. 2050-Z can be fixed
on the last crossbar.
Details ► chapter 10 main catalog

Part. No.	Width [mm]	Number of teeth
2050.Z	60	6

PDF: igus.com/e-chain-pdfs
Product information: igus.com/e-chains

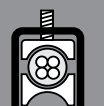

Guide troughs are used with applications where the upper run of the e-chain® glides on the lower run. If using igus® steel guide troughs, the following components are required:

- Full travel length of guide trough
Part No. 96-30
- 1/2 travel length of glide bars
Part No. 92-01
- Installation sets as end connectors
Part No. 95-50-XX

-XX indicates the length of the profile rail on which the guide trough is mounted. The values and part numbers are specified in the table on the left. Standard length of the trough components and glide bars is 6.56 ft (2m). The required overall length of the guide trough directly correlates to the length of travel.

Example:

Length of travel 164 ft. (50 m)
Center mounted

Required guide troughs:

164 ft (50 m) guide trough,
82 ft (25 m) glide bar
= 25 sections of 6.56 ft (2 m) guide trough

Part No. 96-30

= 13 sections of 6.56 ft. (2 m) glide bar

Part No. 92-01

Required number of installation sets

= Number of guide trough components + 1
= 25 + 1 = 26

Part number of the installation sets

95-50-XXX

Example: 95-50-400 for
15.75 (400 mm) long profile rail



Left: Guide trough with glide bars
Right: Guide troughs without glide bars



Installation sets as section connectors

Width of Crossbar
E4-28-040-200-0

	B_{Ri}	Installation Part No.
-040	2.56 (65)	*
-050	2.95 (75)	95-50-200
-052	2.99 (76)	95.50-200
-062	3.43 (87)	95-50-200
-070	3.74 (95)	95-50-200
-075	3.94 (100)	95-50-225
-100	4.92 (125)	95-50-250
-125	5.91 (150)	95-50-275
-150	6.89 (175)	95-50-300
-175	7.87 (200)	95-50-325
-200	8.86 (225)	95-50-350
-225	9.84 (250)	95-50-375
-250	10.83 (275)	95-50-400
-275	11.81 (300)	95-50-425
-300	12.80 (325)	95-50-450

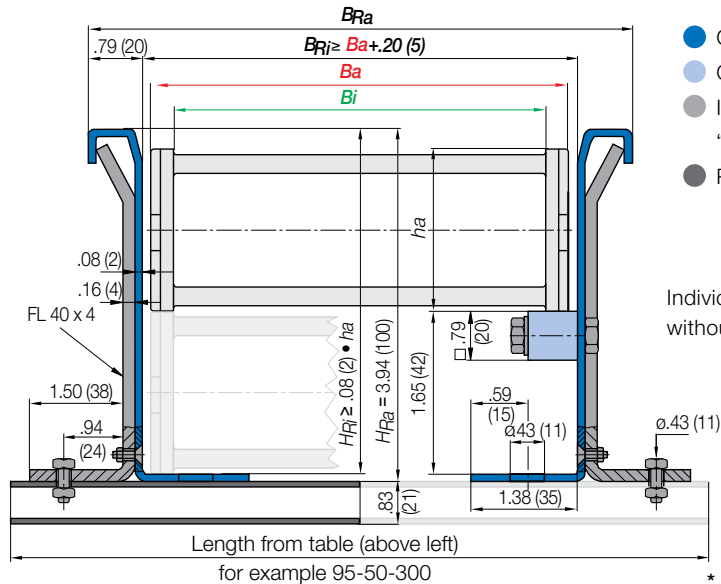

- Guide trough
- Glide bars
- Installation set "Basic"
- Profile rail

Individual attachment without profile rail

* Specialized guide trough available upon request

Standard length profile rail

Hot chips up to 1562°F

- e-tubes to withstand 1,562°F hot chips, as a special option
- No hot chips melting or embedding into the chain
- igus® igumid HT material

More information ► www.igus.com/HT

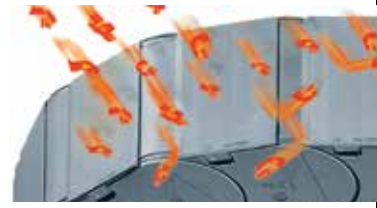

Aluminum support tray

- Corrosion-resistant and seawater-resistant aluminium rails with adjustable width
- Noise-reducing glide strip integrated as standard
- Easy installation and connection of the e-chain®
- Open design - dirt and debris fall through

More information ► Chapter 9



Reduce assembly time - E4 e-chain® opener

- e-chain® opener tools for easy opening and closing of e-chains®
- Simple opening and closing of e-chain® crossbars
- Also for use in hard to reach locations
- Significant assembly time reduction

More information ► www.igus.com/E4savetime



E4-32
H4-32
R4-32



e-chain system® E4-1

Series E4-32/H4-32/R4-32

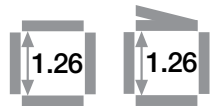

Price Index

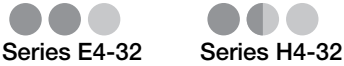

Series E4-32

Series H4-32



Series R4-32

Special Options Available



Low noise version available with special rubber pads



Cleanroom test upon request



ESD classification:
Electrically conductive ESD/
ATEX version upon request

Assembly Tips



Opening e-chains®: Remove crossbars and clips - Insert screwdriver into the slot, push down, release by lever action



Remove lids/bottoms (e-tubes) - Insert screwdriver into the slot, release by lever action

Other Installation Methods

- Vertical, hanging ≤ 262 ft (80 m)
- Vertical, standing ≤ 16.4 ft (5 m)
- Side-mounted, un supp. ≤ 4.92 ft (1.5 m)
- Rotary requires further calculation

Usage Guidelines



- If quiet operation is required
- If very high speeds and/or accelerations are required
- Long travels
- High additional loads



- When an extremely low vibration e-chain® is required
➤ Series E6-35
- When an economic one-sided snap-open e-chain®/e-tube is required
➤ Series 2600/2650/2680/2700

Features & Benefits

- 1 Wide, rounded plastic crossbars - cable friendly
- 2 Low-noise operation through integrated brake in the radial stop dog system
- 3 Hinged snap-open removable lids - e-tube
- 4 Straight run through inner-/outer-link design
- 5 Strain relief with strain relief separators in the mounting bracket are available
- 6 The tongue and groove design provides greater lateral stability
- 7 QuickLock Crossbar, 385-X-Q, available for faster assembly/disassembly
- 8 Optimized glide pads - long service life
- 9 New Interior separation kit available
- 10 Crossbars are removable along both radii
- 11 15% more tensile strength (compared to the older E4 series), better unsupported length through improved stop dog system and vertical radial stops
- 12 Smooth outline, dirt repellent
- 13 Version NCST "without camber" simply by turning outer links without unnecessary rework

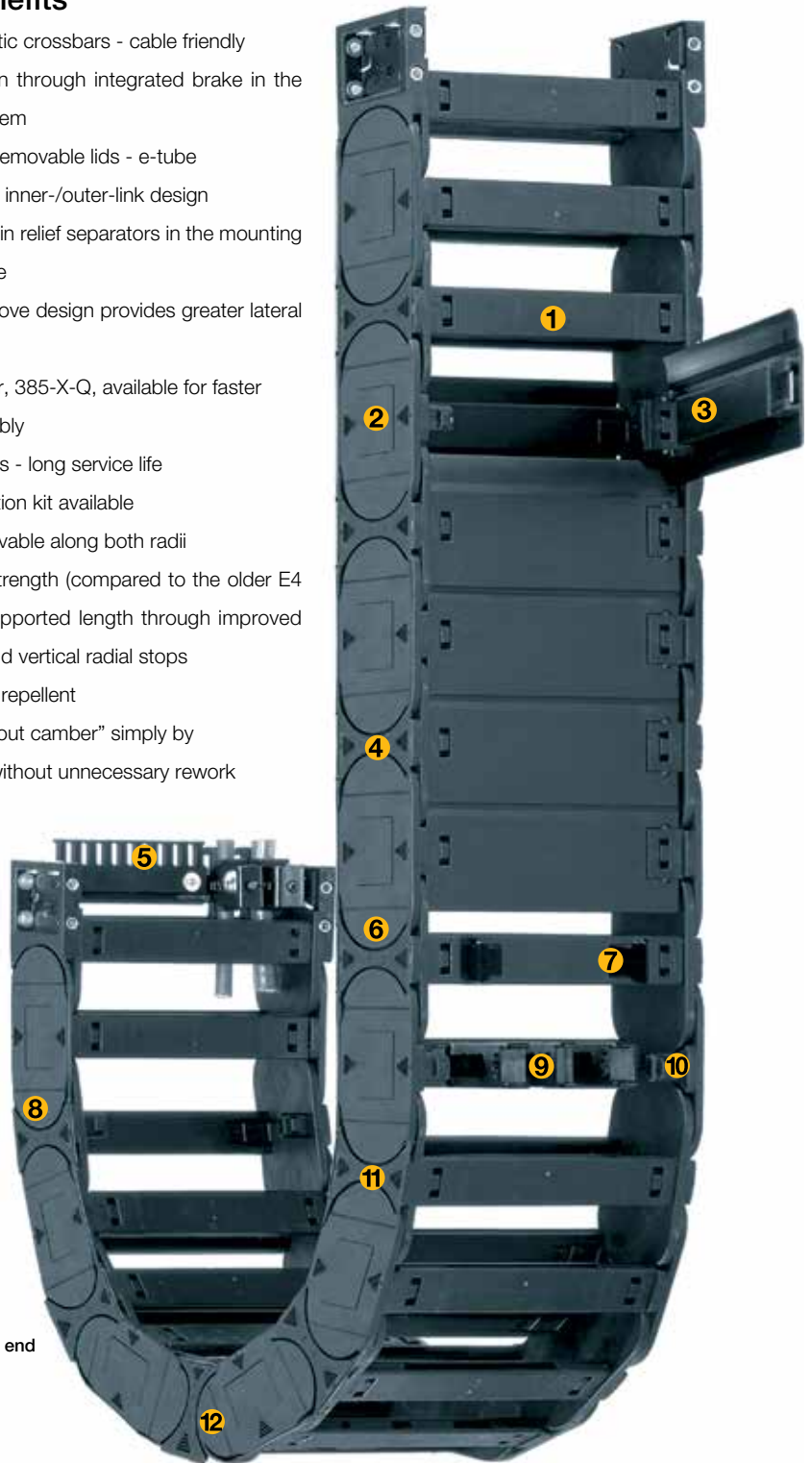

Also available without camber. Add NCST to the end of the part number.
Ex: E4-32-30-300NCST

Order Example: Complete e-chain®

Please indicate chain length or number of links. Example:

13.12 ft (4 m) **E4-32-30-300-0**



e-chain®

With 2 separators **282** assembled every 2nd link



Interior Separation

1 Set **E4-320-30-12P**



Mounting Bracket

e-chain system® E4-1

Series E4-32/H4-32/R4-32

Installation Dimensions



E4-32
H4-32
R4-32

Short travel, unsupported length

- FL_B = unsupported with permitted sag
 - FL_G = unsupported with straight upper run
- Further information ► Design, Chapter 1

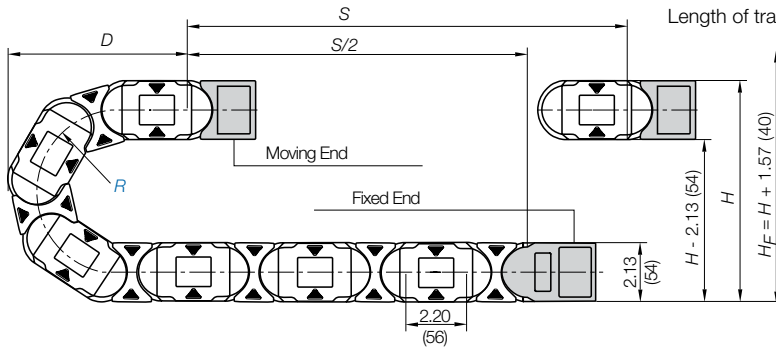
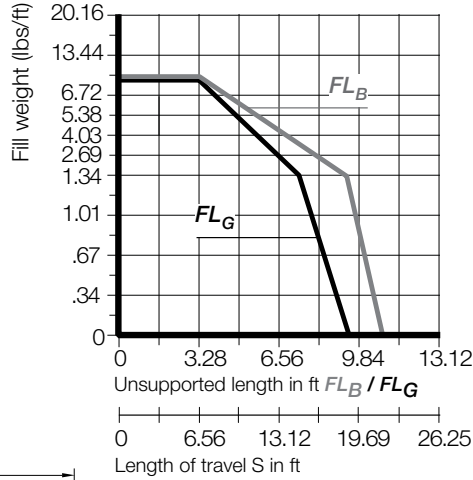
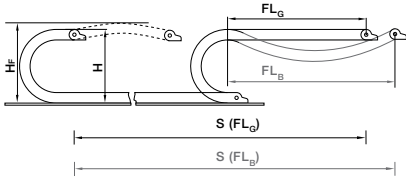

Pitch per link = 2.20" (56 mm)
Links per ft (m) = 5.49 (18)
For center mount applications:
Chain length = $\frac{S}{2} + K$

The required clearance height: $H_F = H + 1.57$ in. (40 mm) (with 1.34 lbs/ft (2.0 kg/m) fill weight. Please consult igus® if space is particularly restricted.

R	2.48 (063)	2.95 (075)	3.94 (100)	4.92 (125)	5.91 (150)	6.89 (175)	7.87 (200)	8.66 (220)	9.84 (250)	11.81 (300)
H	7.09 (180)	8.03 (204)	10.00 (254)	11.97 (304)	13.94 (354)	15.91 (404)	17.87 (454)	19.45 (494)	21.81 (554)	25.75 (654)
D	6.85 (174)	7.32 (186)	8.31 (211)	9.29 (236)	10.28 (261)	11.26 (286)	12.24 (311)	13.03 (331)	14.21 (361)	16.18 (411)
K	12.20 (310)	13.78 (350)	16.93 (430)	19.88 (505)	23.03 (585)	26.18 (665)	29.33 (745)	31.69 (805)	35.43 (900)	41.54 (1055)

Short Travels - Unsupported

Unsupported e-chains® feature positive camber over short travels. This must be accounted for when specifying the clearance height. Please refer to for further details.

Legend

- S = Length of travel
 - R = Bending radius
 - H = Nominal clearance height
 - D = Overlength e-chain® radius in final position
 - $K = \pi \cdot R + \text{safety buffer}$
 - H_F = Required clearance height
 - H_{ri} = Trough inner height
 - H₂ = *Mounting height
 - D₂ = Overlength - long travels, gliding
 - K₂ = *Add-on
- *If the mounting bracket location is set lower

For long travels with lowered mounting height

Long travel lengths from 32.8 ft.(10m) to max. 656 ft. (200m)

For center mount applications:
Chain length = $\frac{S}{2} + K_2$

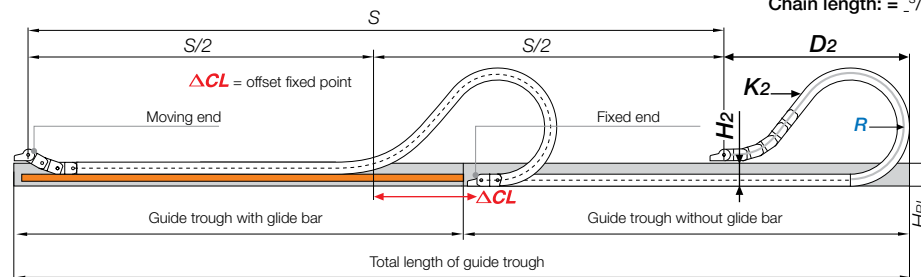

Long Travels - Gliding

If the unsupported length is exceeded, the e-chain®/ Tube must glide on itself. This requires a guide trough. Design, Chapter 1

R	2.48 (063)	2.95 (075)	3.94 (100)	4.92 (125)	5.91 (150)	6.89 (175)	7.87 (200)	8.66 (220)	9.84 (250)	11.81 (300)
H ₂	-	-	6.54 (166)	6.54 (166)	6.54 (166)	6.54 (166)	6.54 (166)	6.54 (166)	6.54 (166)	6.54 (166)
D ₂	-	-	14.57 (370)	18.50 (470)	19.69 (500)	25.79 (655)	30.31 (770)	35.43 (900)	36.61 (930)	43.31 (1100)
K ₂	-	-	24.25 (616)	30.87 (784)	35.27 (896)	44.10 (1120)	50.71 (1288)	57.32 (1456)	61.73 (1568)	75.00 (1904)
ΔCL	-	-	6.30 (160)	8.27 (210)	9.45 (240)	14.57 (370)	18.11 (460)	21.26 (540)	22.44 (570)	27.17 (690)

In case of travels between 22.9 and 32.8 ft (7 and 10 m) we recommend a longer unsupported length.



For support of the lower run, see Chapter 9 of the main catalog for the Support Tray tool kit

Speed / acceleration FL_G	max. 65.6 ft/s (20 m/s) / max. 656 ft/s ² (200 m/s ²)
Speed / acceleration FL_B	max. 9.84 ft/s (3 m/s) / max. 19.69 ft/s ² (6 m/s ²)
Gliding speed / acceleration (maximum)	max. 32.8 ft/s (10 m/s) / max. 164 ft/s ² (50 m/s ²)
Material - permitted temperature	igumid G / -40°F (-40°C) up to +248°F (+120°C)
Flammability Class, igumid G	VDE 0304 IIC UL94 HB

Technical Data



Details of material properties

► Chapter 1

PDF: igus.com/e-chain-pdfs
Product information: igus.com/e-chains



Series E4-32 - e-chain® with crossbars every link

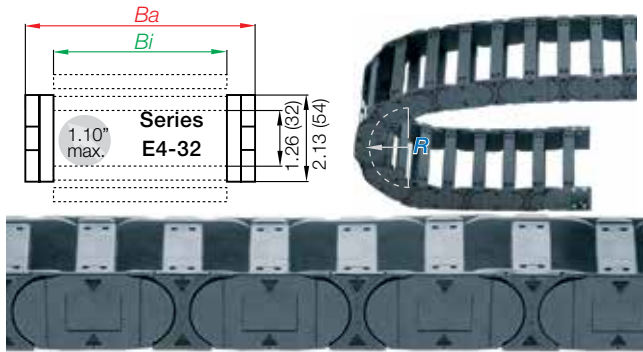

- Crossbars every link
- For use with rigid hydraulic hoses
- For particularly demanding applications
- Can be opened from both sides

Part Number Structure

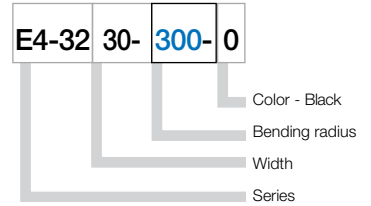

Series H4-32 - e-chain® with crossbars every other link

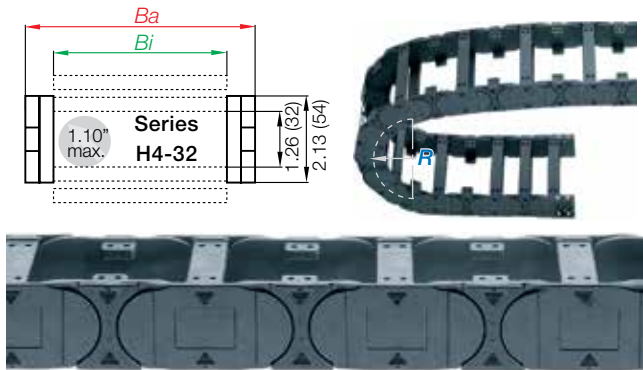

- Crossbars every other link
- Standard configuration
- For nearly every situation
- Can be opened from both sides
- Easy assembly
- Stable
- Cost-effective

Part Number Structure

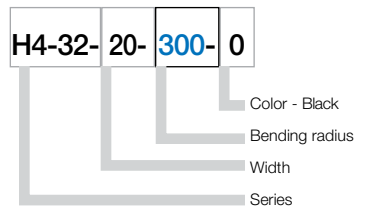

Series R4-32 - fully enclosed e-tube

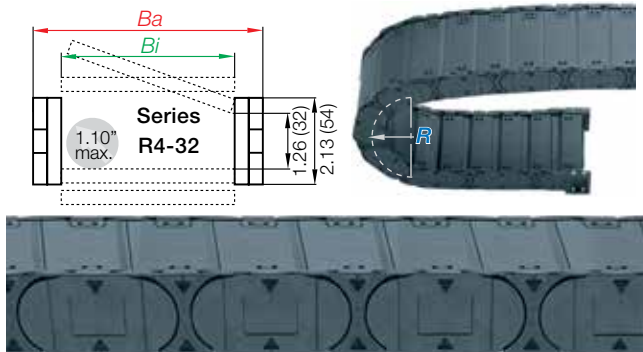

- Fully enclosed
- Excellent cable and hose protection against dirt
- Protection against hot chips
- Lids along inner radius are completely removable
- Lids along the outer radius are single-sided, snap open, hinged on one side as well as completely removable

Part Number Structure

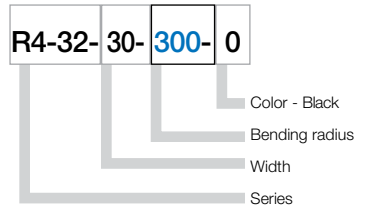

e-chain® as separate parts, links and side plates

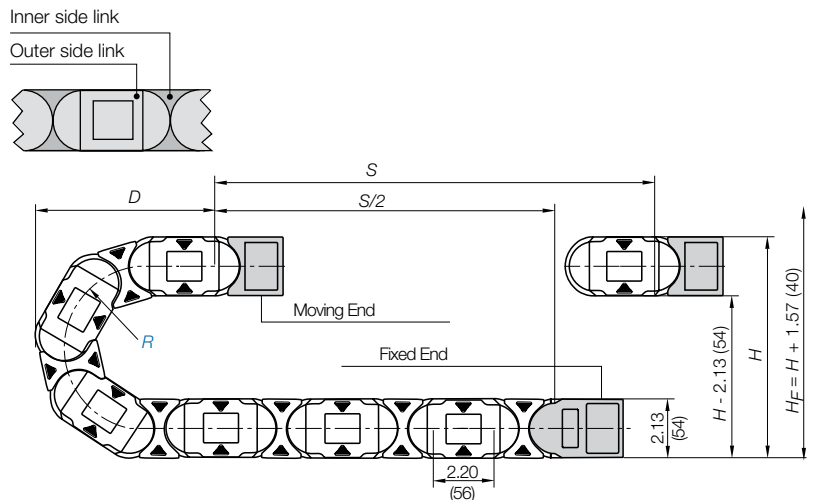
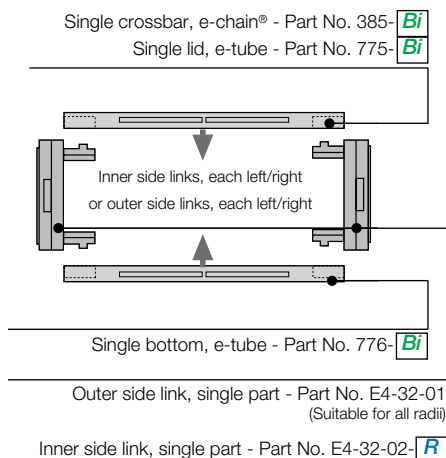

e-chain system® E4-1

Series E4-32/H4-32/R4-32

Product Range



E4-32
H4-32
R4-32

Supplement part number with required radius. Example: E4-32-30-300-0
Pitch: 2.20 in. (56mm) per link links/ft(m) = 5.49 (18)

Part Number			Weight					
Crossbars	Crossbars	Tube	<i>Bi</i>	<i>Ba</i>	E4-32	H4-32	R4-32	
Every link	Every other	Version	in. (mm)	in. (mm)	lbs/ft (kg/m)	lbs/ft (kg/m)	lbs/ft (kg/m)	
E4-32-05-	H4-32-05-	*R4-32-05-	<input type="checkbox"/> -0	1.97 (50)	2.87 (73)	≈ 1.05 (1.57)	≈ 0.96 (1.43)	≈ 1.65 (2.45)
E4-32-06-	H4-32-06-		<input type="checkbox"/> -0	2.68 (68)	3.58 (91)	≈ 1.14 (1.70)	≈ 1.00 (1.49)	-
E4-32-07-	H4-32-07-	R4-32-07-	<input type="checkbox"/> -0	2.95 (75)	3.86 (98)	≈ 1.16 (1.73)	≈ 1.01(1.51)	≈ 1.73 (2.57)
E4-32-087-	H4-32-087-		<input type="checkbox"/> -0	3.43 (87)	4.33 (110)	≈ 1.21 (1.80)	≈ 1.03 (1.54)	-
E4-32-097-	H4-32-097-		<input type="checkbox"/> -0	3.82 (97)	4.72 (120)	≈ 1.25 (1.86)	≈ 1.05 (1.57)	-
E4-32-10-	H4-32-10-	R4-32-10-	<input type="checkbox"/> -0	3.94 (100)	4.84 (123)	≈ 1.27 (1.89)	≈ 1.06 (1.58)	≈ 1.78 (2.65)
E4-32-11-	H4-32-11-	R4-32-11-	<input type="checkbox"/> -0	4.25 (108)	5.16 (131)	≈ 1.30 (1.94)	≈ 1.08 (1.61)	≈ 1.85 (2.76)
E4-32-112-	H4-32-112-		<input type="checkbox"/> -0	4.41(112)	5.35 (136)	≈ 1.32 (1.96)	≈ 1.09 (1.62)	-
E4-32-12-	H4-32-12-	R4-32-12-	<input type="checkbox"/> -0	4.92 (125)	5.83 (148)	≈ 1.39 (2.07)	≈ 1.13 (1.68)	≈ 1.92 (2.85)
E4-32-137-	H4-32-137-		<input type="checkbox"/> -0	5.39 (137)	6.34 (161)	≈ 1.42 (2.12)	≈ 1.14 (1.70)	-
E4-32-15-	H4-32-15-	R4-32-15-	<input type="checkbox"/> -0	5.91 (150)	6.81 (173)	≈ 1.49 (2.21)	≈ 1.18 (1.75)	≈ 2.02 (3.01)
E4-32-162-	H4-32-162-		<input type="checkbox"/> -0	6.38 (162)	7.32 (186)	≈ 1.50 (2.24)	≈ 1.18 (1.76)	-
E4-32-17-	H4-32-17-	R4-32-17-	<input type="checkbox"/> -0	6.61 (168)	7.52 (191)	≈ 1.56 (2.32)	≈ 1.21 (1.80)	≈ 2.16 (3.21)
E4-32-18-	H4-32-18-		<input type="checkbox"/> -0	6.89 (175)	7.80 (198)	≈ 1.58 (2.35)	≈ 1.22 (1.81)	-
E4-32-187-	H4-32-187-		<input type="checkbox"/> -0	7.36 (187)	8.31 (211)	≈ 1.61 (2.39)	≈ 1.24 (1.84)	-
E4-32-20-	H4-32-20-	R4-32-20-	<input type="checkbox"/> -0	7.87 (200)	8.78 (223)	≈ 1.69 (2.52)	≈ 1.28 (1.90)	≈ 2.29 (3.41)
E4-32-212-	H4-32-212-		<input type="checkbox"/> -0	8.35 (212)	9.29 (236)	≈ 1.73 (2.57)	≈ 1.30 (1.93)	-
E4-32-23-	H4-32-23-		<input type="checkbox"/> -0	8.86 (225)	9.76 (248)	≈ 1.79 (2.67)	≈ 1.33 (1.98)	-
E4-32-237-	H4-32-237-		<input type="checkbox"/> -0	9.33 (237)	10.28 (261)	≈ 1.81 (2.70)	≈ 1.34 (1.99)	-
E4-32-25-	H4-32-25-	R4-32-25-	<input type="checkbox"/> -0	9.84 (250)	10.75 (273)	≈ 1.90 (2.83)	≈ 1.38 (2.06)	≈ 2.59 (3.86)
E4-32-262-	H4-32-262-		<input type="checkbox"/> -0	10.31 (262)	11.26 (286)	≈ 1.96 (2.92)	≈ 1.41 (2.10)	-
E4-32-28	H4-32-28-		<input type="checkbox"/> -0	10.83 (275)	11.73 (298)	≈ 2.01 (2.99)	≈ 1.44 (2.14)	-
E4-32-29-	H4-32-29-		<input type="checkbox"/> -0	11.30 (287)	12.24 (311)	≈ 2.02 (3.02)	≈ 1.44 (2.15)	-
E4-32-30-	H4-32-30-	R4-32-30-	<input type="checkbox"/> -0	11.81 (300)	12.72 (323)	≈ 2.12 (3.15)	≈ 1.49 (2.22)	≈ 2.85 (4.25)
E4-32-312-	H4-32-312-		<input type="checkbox"/> -0	12.28 (312)	13.23 (336)	≈ 2.14 (3.18)	≈ 1.50 (2.23)	-
E4-32-325-	H4-32-325-		<input type="checkbox"/> -0	12.79 (325)	13.70 (348)	≈ 2.20 (3.28)	≈ 1.53 (2.28)	-
E4-32-337-	H4-32-337-		<input type="checkbox"/> -0	13.27 (337)	14.21 (361)	≈ 2.24 (3.34)	≈ 1.55 (2.31)	-
E4-32-350-	H4-32-350-		<input type="checkbox"/> -0	13.78 (350)	14.69 (373)	≈ 2.40 (3.57)	≈ 1.63 (2.42)	-
E4-32-362-	H4-32-362-		<input type="checkbox"/> -0	14.25 (362)	15.20 (386)	≈ 2.46 (3.66)	≈ 1.66 (2.47)	-
E4-32-375-	H4-32-375-		<input type="checkbox"/> -0	14.76 (375)	15.67 (398)	≈ 2.51 (3.74)	≈ 1.69 (2.51)	-
E4-32-387-	H4-32-387-		<input type="checkbox"/> -0	15.24 (387)	16.18 (411)	≈ 2.55 (3.80)	≈ 1.71 (2.54)	-
E4-32-400	H4-32-400-		<input type="checkbox"/> -0	15.75 (400)	16.65 (423)	≈ 2.60 (3.87)	≈ 1.73 (2.58)	-

Choose from the radii below for all of the above sizes

Radius (mm) Example: E4-32-30-300-0

	063**	075**	100	125	150	175	200	220	250	300
<i>R</i>	2.48 (063**)	2.95 (075**)	3.94 (100)	4.92 (125)	5.91 (150)	6.89 (175)	7.87 (200)	8.66 (220)	9.84 (250)	11.81 (300)
<i>H</i> $_{-0}^{+20}$	7.09 (180)	8.03 (204)	10.00 (254)	11.97 (304)	13.94 (354)	15.91 (404)	17.87 (454)	19.45 (494)	21.81 (554)	25.75 (654)
<i>D</i>	6.85 (174)	7.32 (186)	8.31 (211)	9.29 (236)	10.28 (261)	11.26 (286)	12.24 (311)	13.03 (331)	14.21 (361)	16.18 (411)
<i>K</i>	12.20 (310)	13.78 (350)	16.93 (430)	19.88 (505)	23.03 (585)	26.18 (665)	29.33 (745)	31.69 (805)	35.43 (900)	41.54 (1055)

** This radius is not available for the R4-32 Series

*Removable lid only, no hinged option

0 = Standard color black.

For other colors see Chapter 1

For wider chains see page 6.36

For large diameter hoses see page 6.37

PDF: igus.com/e-chain-pdfs
Product information: igus.com/e-chains



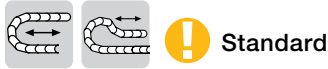

Option 1: pivoting

- Recommended for unsupported and gliding applications
- Attachment capability on all sides
- Bolted connection outside of chain cross-section
- Space restricted conditions
- Corrosion resistant

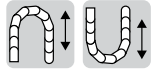

Option 2: locking

- Profile rail option
- Universal use
- Corrosion resistant
- Vertical hanging/standing travels
- Extreme accelerations

Part Number Structure

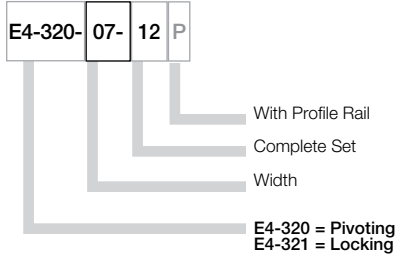

Due to the design of the E4-32 series chains, please note the following when ordering brackets:

Even number of links = full set, part number ending in -12; Odd number of links = 2 pieces, part number ending in -1

Part No. Full Set (pivoting)
Series E4-32 or H4-32
E4-320-Width-12

Part No. Full Set (pivoting)
with profile rail
Series E4-32 or H4-32
E4-320-Width-12P

Part number examples are shown for pivoting brackets for e-chain.
For locking brackets change part number to 321

Width	Part No. Full Set chain		With Profile Rail	Bi in. (mm)	Width	Part No. Full Set chain		With Profile Rail	Bi in. (mm)
	Pivoting	Locking				Pivoting	Locking		
-05	E4-320	E4-321	-05-12	1.97 (50)	-212	E4-320	E4-321	-212-12	8.35 (212)
-06	E4-320	E4-321	-06-12	2.68 (68)	-23	E4-320	E4-321	-23-12	8.86 (225)
-07	E4-320	E4-321	-07-12	2.95 (75)	-237	E4-320	E4-321	-237-12	9.33 (237)
-087	E4-320	E4-321	-087-12	3.43 (87)	-25	E4-320	E4-321	-25-12	9.84 (250)
-097	E4-320	E4-321	-097-12	3.82 (97)	-262	E4-320	E4-321	-262-12	10.31 (262)
-10	E4-320	E4-321	-10-12	3.94 (100)	-28	E4-320	E4-321	-28-12	10.83 (275)
-11	E4-320	E4-321	-11-12	4.25 (108)	-29	E4-320	E4-321	-29-12	11.30 (287)
-112	E4-320	E4-321	-112-12	4.41 (112)	-30	E4-320	E4-321	-30-12	11.81 (300)
-12	E4-320	E4-321	-12-12	4.92 (125)	-312	E4-320	E4-321	-312-12	12.28 (312)
-137	E4-320	E4-321	-137-12	5.39 (137)	-325	E4-320	E4-321	-325-12	12.79 (325)
-15	E4-320	E4-321	-15-12	5.91 (150)	-337	E4-320	E4-321	-337-12	13.27 (337)
-162	E4-320	E4-321	-162-12	6.38 (162)	-350	E4-320	E4-321	-350-12	13.78 (350)
-17	E4-320	E4-321	-17-12	6.61 (168)	-362	E4-320	E4-321	-362-12	14.25 (362)
-18	E4-320	E4-321	-18-12	6.89 (175)	-375	E4-320	E4-321	-375-12	14.76 (375)
-187	E4-320	E4-321	-187-12	7.36 (187)	-387	E4-320	E4-321	-387-12	15.24 (387)
-20	E4-320	E4-321	-20-12	7.87 (200)	-400	E4-320	E4-321	-400-12	15.75 (400)

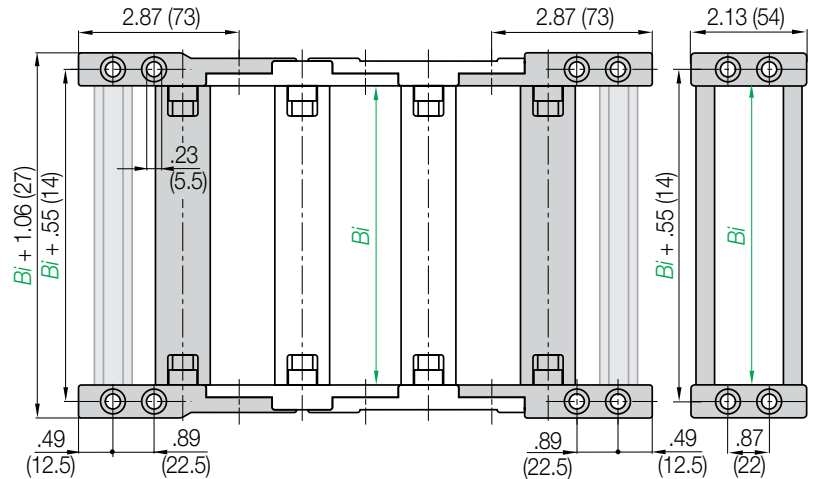
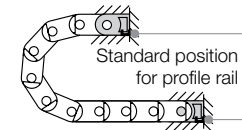
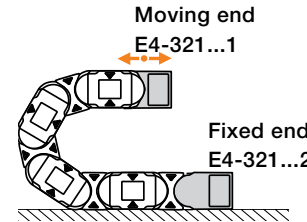
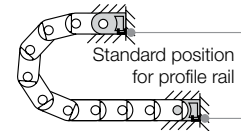
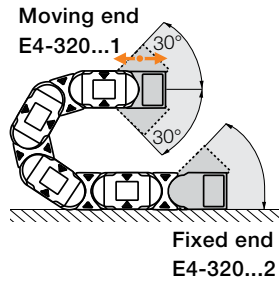

e-chain system® E4-1

Series R4-32

Mounting Brackets - KMA



E4-32
H4-32
R4-32



Option 1: pivoting

- Recommended for unsupported and gliding applications
- Attachment capability on all sides
- Bolted connection outside of chain cross-section
- Space restricted conditions
- Corrosion resistant

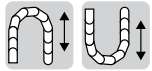
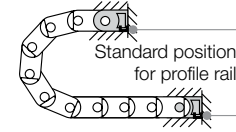
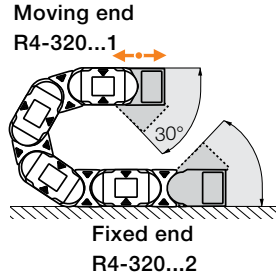

Option 2: locking

- Profile rail option
- Universal use
- Corrosion resistant
- Vertical hanging/standing travels
- Extreme accelerations

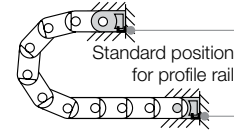
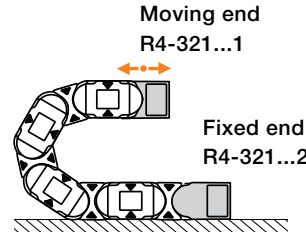

Part Number Structure

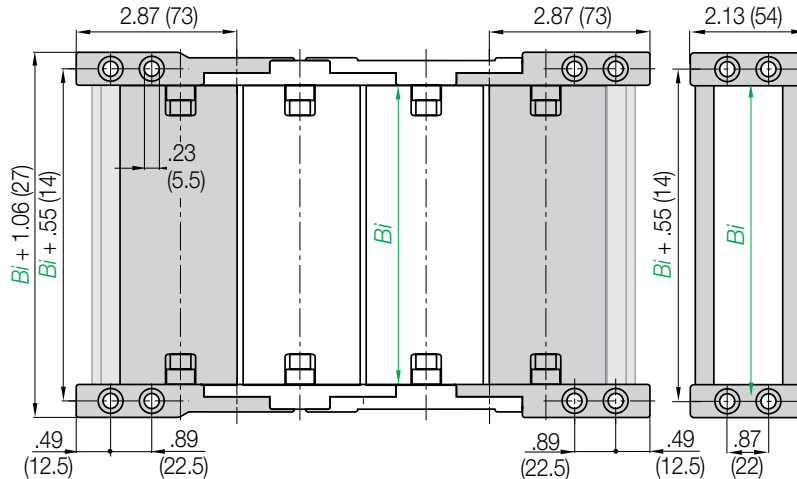
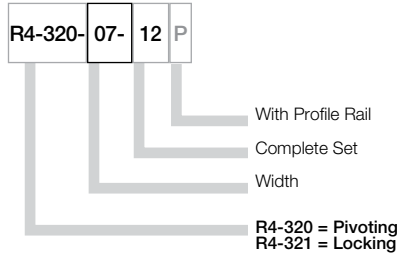

Due to the design of the E4-32 series chains, please note the following when ordering brackets:

Even number of links = full set, part number ending in -12; Odd number of links = 2 pieces, part number ending in -1

Part No. Full Set (pivoting)
Tube Series R4-32
R4-320-Width-12

Part No. Full Set (pivoting)
with Profile Rail
Tube Series R4-32
R4-320-Width-12P

Part number examples are shown for pivoting brackets for e-chain.
For locking brackets change part number to 321

Width	Part No. Full Set tube		With Profile Rail	Bi in. (mm)	Width	Part No. Full Set tube		With Profile Rail	Bi in. (mm)		
	Pivoting	Locking				Pivoting	Locking				
-05	R4-320	R4-321	-05-12	P	1.97 (50)	-15	R4-320	R4-321	-15-12	P	5.91 (150)
-07	R4-320	R4-321	-07-12	P	2.95 (75)	-17	R4-320	R4-321	-17-12	P	6.61 (168)
-10	R4-320	R4-321	-10-12	P	3.94 (100)	-20	R4-320	R4-321	-20-12	P	7.87 (200)
-11	R4-320	R4-321	-11-12	P	4.25 (108)	-25	R4-320	R4-321	-25-12	P	9.84 (250)
-12	R4-320	R4-321	-12-12	P	4.92 (125)	-30	R4-320	R4-321	-30-12	P	11.81 (300)

PDF: igus.com/e-chain-pdfs
Product information: igus.com/e-chains



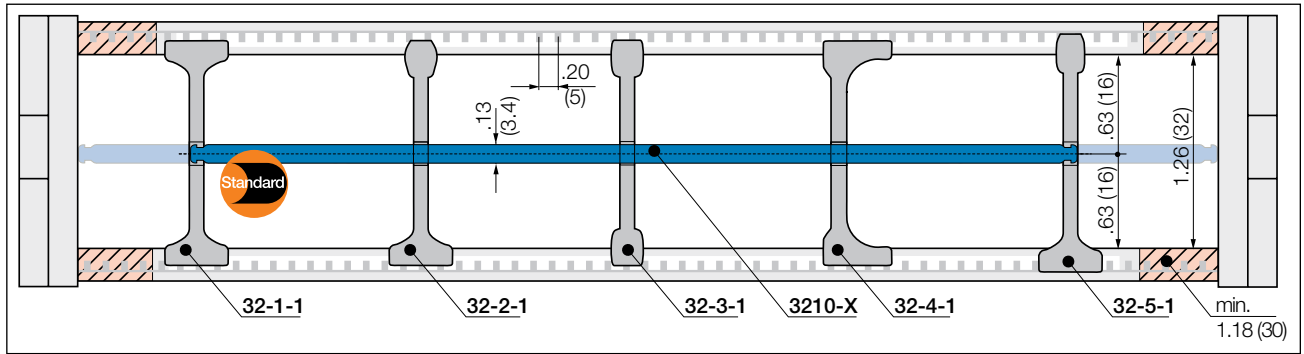

Note e-tube: Please maintain a lateral spacing of 1.18" (30 mm) between the separators and the side links. In the standard configuration separators are assembled every 2nd e-chain® link

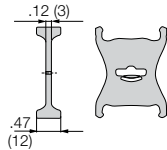

Separator, wide base

Unassembled	Part No. 32-1
Assembled	Part No. 32-1-1

- **Standard separator 32-1 for all applications**
Separator with wide base for maximum locking strength and safe standing in e-chains®.

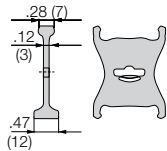

Separator, narrow head

Unassembled	Part No. 32-2
Assembled	Part No. 32-2-1

- **Separator 32-2 For even faster installation**
is used when vertical and horizontal separation is required. Due to its slot, it allows basic vertical/horizontal shelving arrangements.

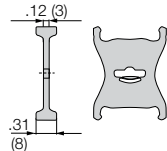

Separator, narrow base

Unassembled	Part No. 32-3
Assembled	Part No. 32-3-1

- **Separator 32-3 For many thin cables**
is used when vertical and horizontal separation is required. Due to its slot, it allows basic vertical/horizontal shelving arrangements.

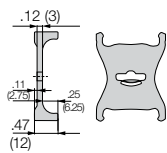

Separator, asymmetrical

Unassembled	Part No. 32-4
Assembled	Part No. 32-4-1

- **Separator 32-4 For side mounted applications**
is used when vertical and horizontal separation is required. Due to its slot, it allows basic vertical/horizontal shelving arrangements.

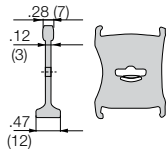

Separator, asymmetrical

Unassembled	Part No. 32-5
Assembled	Part No. 32-5-1

- **Separator 32-5 Locks safely in .20" (5 mm) increments**
Notch separator for exact positioning in e-chains®. Recommended for side-mounted applications.

Lockable full-width shelves - for the standard interior separation

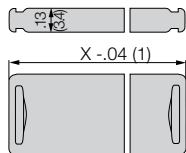

Full width shelf, lockable

Unassembled	Part No. 3200-X
Assembled	Part No. 3210-X

- **Full width shelf, lockable**
Shelf locks safely into separators on both ends, fixed width possible. Separators can be moved freely over the shelf in horizontal direction. Can be used at one height.

Width X in. (mm)	Part No. Unassembled	Part No. Assembled	Width X in. (mm)	Part No. Unassembled	Part No. Assembled	Width X in. (mm)	Part No. Unassembled	Part No. Assembled
1.97 (050)	3200-50	3210-50	4.92 (125)	3200-125	3210-125	8.86 (225)	3200-225	3210-225
2.95 (075)	3200-75	3210-75	5.91 (150)	3200-150	3210-150	9.84 (250)	3200-250	3210-250
3.94 (100)	3200-100	3210-100	6.89 (175)	3200-175	3210-175			
4.53 (115)	3200-115	3210-115	7.87 (200)	3200-200	3210-200			

e-chain system® E4-1

Series Series E4-32/H4-32/R4-32

Interior Separation - Previous Generation



E4-32
H4-32
R4-32



Shelves and Separators

e-chains® and e-tubes can be subdivided both vertically and horizontally using the various interior separation elements. ➤

Design, Chapter 1 for layout recommendations.

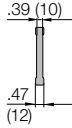
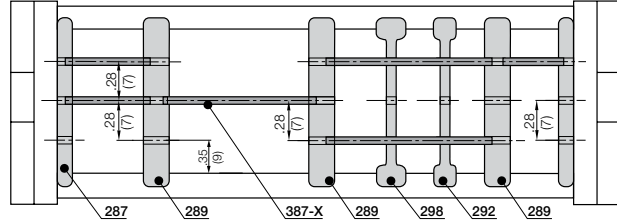

Split Separator (chain only)

Unassembled	Part No. T323
Assembled	Part No. T323M

- **Split separator T323 for e-chains®**
This separator is ideal for subsequent shelving or the initial assembly of the e-chain. Fast assembly and disassembly using a hinge/push mechanism. Enhances flexibility

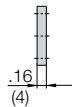

Side Plate

Unassembled	Part No. 286
Assembled	Part No. 287

- **Side plates 286**
This component is used to form the basic pattern of a shelf system.



Vertical Separator

Unassembled	Part No. 288
Assembled	Part No. 289

- **Vertical separator 288**
This component is used to form the basic pattern of a shelf system.

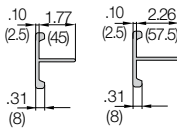

Separators w/Integrated Shelf

Unassembled	Part No. 281-S-45
Assembled	Part No. 282-S-45
Unassembled	Part No. 281-S-57
Assembled	Part No. 282-S-57

- **Locking vertical separator 281-S**
This separator is slotted and able to be combined with shelves

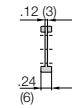

Slotted Separators

Unassembled	Part No. 291
Assembled	Part No. 292

- **Closed Slotted separators 291**
These are used for complex subdivisions. However, they cannot be retrofitted into an existing interior separation system without removing the shelves first.

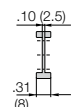

Slotted Separators, Open

Unassembled	Part No. 297
Assembled	Part No. 298

- **Open slotted separator 297**
This separator can be retrofitted into an existing interior separation system without removing the shelves, as long as these shelves fit into the middle slot only.

Width X in. (mm)	Usable Width in. (mm)	Part No. Unassembled	Part No. Assembled
.71 (18)	.39 (10)	386-18	387-18
.91 (23)	.59 (15)	386-23	387-23
.98 (25)	.67 (17)	386-25	387-25
1.10 (28)	.79 (20)	386-28	387-28
1.30 (33)	.98 (25)	386-33	387-33
1.69 (43)	1.38 (35)	386-43	387-43
1.97 (50)	1.65 (42)	386-50	387-50
2.13 (54)	1.81 (46)	386-54	387-54
2.44 (62)	2.13 (54)	386-62	387-62
2.95 (75)	2.64 (67)	386-75	387-75
3.43 (87)	3.12 (87)	386-87	387-87
3.94 (100)	3.62 (92)	386-100	387-100
4.25 (108)	3.94 (100)	386-108	387-108
4.92 (125)	4.61 (117)	386-125	387-125
5.91 (150)	5.59 (142)	386-150	387-150
6.89 (175)	6.57 (167)	386-175	387-175
7.87 (200)	7.56 (192)	386-200	387-200
8.19 (208)	7.87 (200)	386-208	387-208
8.86 (225)	8.54 (217)	386-225	387-225

Shelves 386-XX

These components form the basic pattern of a shelf system. Shelves of various widths can be arranged at 3 different heights in .28" (7mm) increments

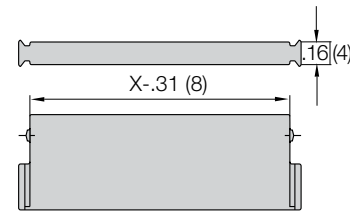

The diagram below is for reference purposes only. Multiple configurations are possible. To create your e-chain shelving cross section please see our online e-chain configurator. Call 1-800-521-2747 for assistance and/or go to igus.com click on the **Products** drop down menu, choose **e-chain Cable Carriers** and on the next drop down menu simply click on **e-chain Configurator**.

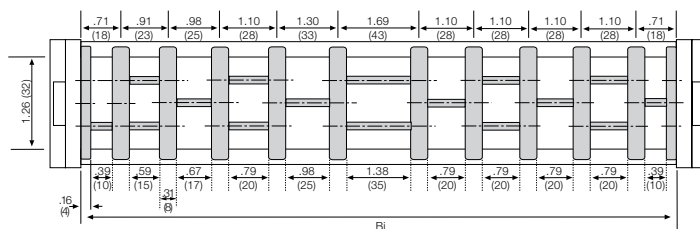

PDF: igus.com/e-chain-pdfs
Product information: igus.com/e-chains





Vertical separators and spacers

Vertical separators are used if a vertical subdivision of the e-chain® interior is required. By standard, vertical separators are assembled every other e-chain® link.

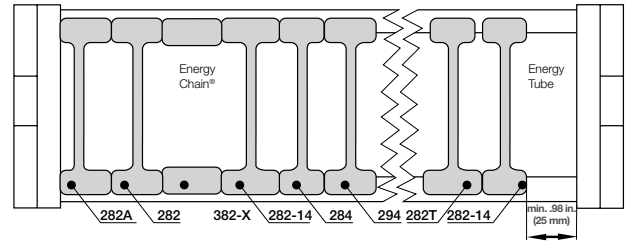

NOTE: Observe a lateral spacing of at least .98 in. (25mm) for e-tubes

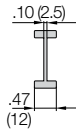

Separator (chain/tube)

Unassembled	Part No. 280
Assembled	Part No. 281

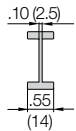

Separator (chain/tube)

Unassembled	Part No. 280-14
Assembled	Part No. 281-14

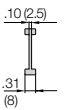

Separator (chain only)

Unassembled	Part No. 283
Assembled	Part No. 284

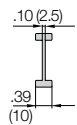

Locking Separator (chain only)

Unassembled	Part No. 293
Assembled	Part No. 294

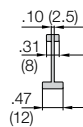

Locking Separator (tubes only)

Unassembled	Part No. 281T
Assembled	Part No. 282T

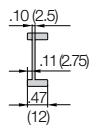

Asymmetric separator (chain only)

Unassembled	Part No. 280A
Assembled	Part No. 281A



Spacer (chain only)

Unassembled	Part No. 381-XX
Assembled	Part No. 382-XX

XX = width of the spacer

Spacers available in the following sizes:

Part No. Unassembled	Part No. Assembled	in.	(mm)
381 -10	382 -10	.39"	(10)
381 -15	382 -15	.59"	(15)
381 -20	382 -20	.79"	(20)

- Standard separator 280 for e-chains® and e-tubes**
This separator offers safe stability due to its wide base design, also when used with thick cables or hoses.
- Vertical separator 280-14 for e-chains® and e-tubes**
This separator offers safe stability due to its broad base design when used with thick cables or hoses.
- Vertical separator 283 for e-chains®**
This separator features a narrow base for use in applications where a large number of small cables need to be individually separated.
- Locking separator 293 for e-chains®**
This separator is used in applications with very high relative humidity. It features increased retention force which is produced by asymmetrical retention "clamps" attached to the chain's crossbar. Please ensure that they are properly aligned.
- Locking separator 281T for e-tubes**
It clamps to the fixed radius and remains free along the other radius to facilitate lid removal.
- Asymmetrical separator 281A for e-chains®**
This separator features an (12mm) base. It can be used in combinations between spacers of different widths and vertical separators in side mounted applications.
- NOTE ON SPACERS**
Vertical separators are adjustable, but can be fixed in position by means of a spacer. Spacers are most often necessary for side mounted applications. The available inner height is reduced by .08" (2mm) **per spacer** (for example if one spacer is placed on either side of the separator, the overall inner height is reduced by .16" (4mm). To avoid this, place the spacers on the **outside** of the opening crossbar (**not for long travels**).

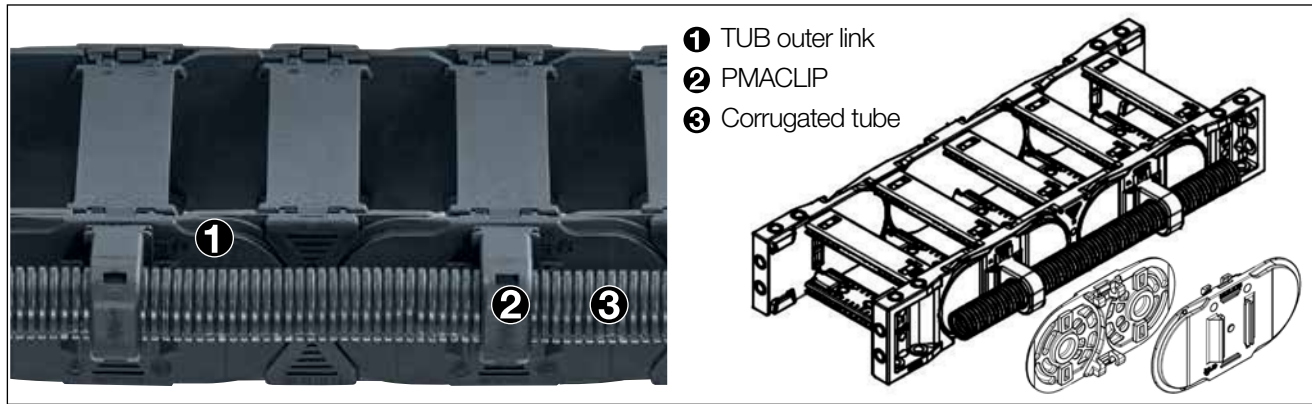

- ❶ TUB outer link
- ❷ PMACLIP
- ❸ Corrugated tube

TUB | Safe guidance for corrugated tubes parallel to the e-chain®

- Additional, simple guidance for corrugated tubes on the outside of the e-chain®
- PMACLIP allows corrugated tubes with nominal widths .28 (07mm), .39 (10mm), .47 (12mm), .67 (17mm) to be easily clipped on
- Easy access to the corrugated tubes, fast replacement of the hoses
- Reduce assembly time and cost - easy to assemble, without any additional screws or tools
- The part number includes the e-chain® with TUB side sections; the PMACLIP support and the hose are ordered separately

Part No. TUB	Part No. TUB	Part No. TUB	For corrugated tube nominal diameter
Outer link right*	Outer link left*	Outer link at both ends*	Ø [mm]
E4-32-XXXTUBR-R-0	E4-32-XXXTUBL-R-0	E4-32-XXXTUB-R-0	.28 (07), .39 (10), .47 (12), .67 (17)

*View from the fixed end

Part number appended with width index **XXX Bi** and radius (**R**) e.g.

E4-32-100TUBR-150-0 = with TUB outer sections every 2nd right hand link



Extension links - for extremely wide e-chains® up to 9.84 ft (3m)

- For applications in which particularly high fill weights necessitate extremely wide e-chains®
- The extension link design allows virtually limitless side-by-side attachment of chains
- The unsupported length of a chain can be increased when additional loads are required
- Extension links can be used with e-chains®, e-tubes or a combination of both
- They are suitable for unsupported and gliding applications in a guide trough
- e-chains® with extension links are attached with KMA or steel mounting brackets.

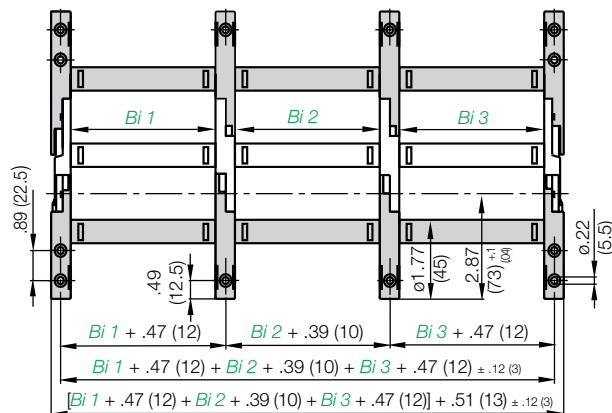

Part number example for e-chain®

E4-32-10/20/10-**200**-0
E4-32-**Bi1/Bi2/Bi3**-**R**-0

We **strongly recommend** on-site consultation with an igus® technician for individual advice regarding mounting brackets, guide troughs and other design details.

Part No.	Part No.	Part No.
Extension link e-chain®	Extension link e-tube	Extension link as an individual part
E4-32- Bi1/Bi2/Bi3 -R-0	R4-32- Bi1/Bi2/Bi3 -R-0	284-R-

Complete Part No. with the width index **Bi1/Bi2/Bi3/etc.** and the radius (**R**). Example: E4-32-10/20/10-200-0



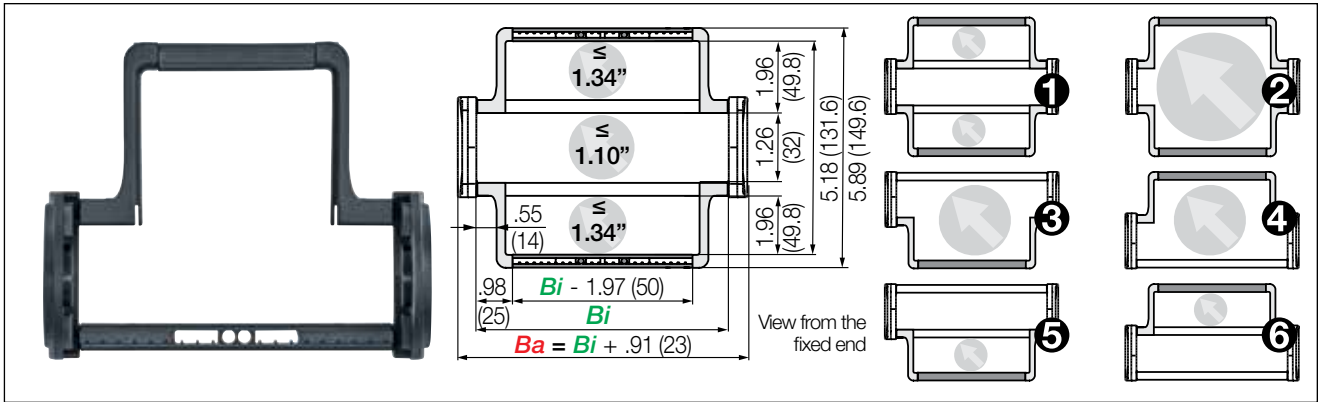

Extender crossbars with flexible width | Safe guiding for large hoses

- For guiding and protecting large hoses
- With mounting for noise dampers
- Cable-friendly design, high crossbar holding force
- The openable extender crossbars can be fitted in different ways and combinations
- Optionally openable along the inner or outer radius

Versions e-chain® with extender crossbar

	Hose Ø ≤ in. (mm)	Part No. e-chain® with extender crossbar
❶ Extender crossbar and standard crossbar alternating along the inner and outer radius ¹⁾	1.34 (34)	E4-32-XXXHB50-R-0
❷ Extender crossbar on both sides along the inner and outer radius ²⁾	4.72 (120)	E4-32-XXXB50-R-0
❸ Extender crossbar along the outer radius ³⁾	2.83 (72)	E4-32-XXXBE50-R-0
❹ Extender crossbar along the inner radius ²⁾	2.83 (72)	E4-32-XXXBZ50-R-0
❺ Extender crossbar and standard crossbar alternating along the outer radius ³⁾	1.34 (34)	E4-32-XXXHBE50-R-0
❻ Extender crossbar and standard crossbar alternating along inner radius ¹⁾	1.34 (34)	E4-32-XXXHBZ50-R-0

1) Minimum bend radius: **R 125**

2) Minimum bend radius: **R 150**

3) Minimum bend radius: **R 063** *Width available upon request. Delivery time upon request

Bi [mm] Available inner widths

| 100 | 125 | 137 | 150 | 162 | 175 | 187 | 200 | 212 | 225 | 237 | 250 |
| 262 | 275 | 287 | 300 | 312 | 325 | 337 | 350 | 362 | 375 | 387 | 400 |

Complete Part No. with the width index **XXX Bi** and the radius (**R**). Example
E4-32-100B50-150-0 = extender crossbar on both sides along inner and outer radius



The E4.1 can be fitted with openable extender crossbars, which increase the size of the interior of the e-chain®. Crossbars can be fitted in various ways: from one or both sides, alternating with standard crossbars and or any combination

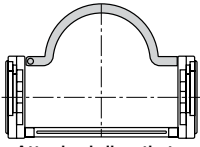

Attached directly to the side link.

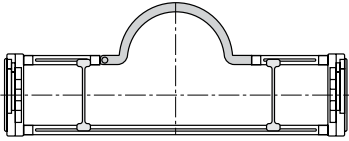

Round extender crossbar combined with standard snap-open crossbars.

Extender crossbars

For careful guiding of large diameter cables and hoses

- Intended for cables and hoses with a maximum outer diameter of 4.13 in. (105 mm).
- Gliding operation with crossbars assembled along the outer radius in conjunction with a special guide trough
- Gliding operation not guaranteed with crossbars assembled along the inner radius
- The extender crossbar can either be attached to the side links directly or can be used in combination with two standard snap-open crossbars.



Part No.	Max Ø Hose in. (mm)	Style	Installation Side Link	Combined with Snap-Open Crossbars
385-15-RHD115	4.13 (105)	Round	No	Yes
385-18-RD115	4.13 (105)	Round	Yes	No

Hinged crossbars

- Typically, e-chain® crossbars are completely removable. In cases where it is preferable that the opening crossbars remain on the e-chain®, a hinged design has been developed.
- Hinged crossbar: Part No. 385-02
- Snap-open crossbar (shortened): Bi-1.48" (37.5 mm) Part No. 385-03 (smallest inner width Bi = 3.44" (87.5 mm))

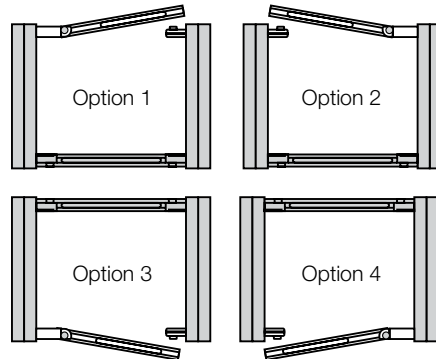
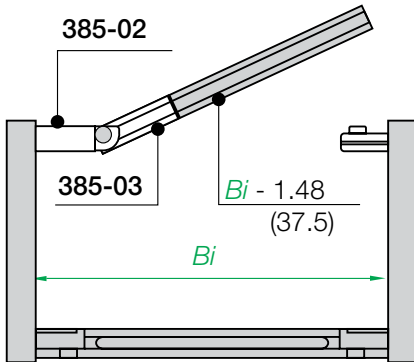

Part No. e-chain® with hinged crossbar	Part No. swivel clip as an individual part	Part No. openable crossbar as an individual part
E4-32-Bi-Z-R-0	385-02	385-03



Chainfix clamps for the profile rail

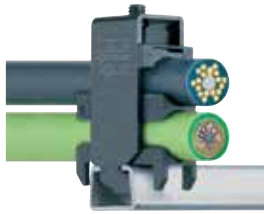

igus® Chainfix strain relief elements are available in either steel or stainless steel. They can be adjusted with a hexagon socket and are available in single, double and triple configurations.

Part No. Single Clamp		Part No. Double Clamp		Part No. Triple Clamp		Cable ø	
Steel	Stainless	Steel	Stainless	Steel	Stainless	in.	(mm)
CFX12-1M	CFX12-1ME	CFX12-2M	CFX12-2ME	CFX12-3M	-	.24 - .47	(06 - 12)
CFX14-1M	CFX14-1ME	CFX14-2M	CFX14-2ME	CFX14-3M	-	.47 - .55	(12 - 14)
CFX16-1M	CFX16-1ME	CFX16-2M	CFX16-2ME	CFX16-3M	-	.55 - .63	(14 - 16)
CFX18-1M	CFX18-1ME	CFX18-2M	CFX18-2ME	CFX18-3M	-	.63 - .71	(16 - 18)
CFX20-1M	CFX20-1ME	CFX20-2M	CFX20-2ME	CFX20-3M	-	.71 - .79	(18 - 20)
CFX22-1M	CFX22-1ME	CFX22-2M	CFX22-2ME	CFX22-3M	-	.79 - .87	(20 - 22)
CFX26-1M	CFX26-1ME	CFX26-2M	CFX26-2ME	-	-	.87 - 1.02	(22 - 26)
CFX30-1M	CFX30-1ME	CFX30-2M	CFX30-2ME	-	-	1.02 - 1.18	(26 - 30)
CFX34-1M	CFX34-1ME	CFX34-2M	CFX34-2ME	-	-	1.18 - 1.34	(30 - 34)
CFX38-1M	CFX38-1ME	-	-	-	-	1.34 - 1.50	(34 - 38)
CFX42-1M	CFX42-1ME	-	-	-	-	1.50 - 1.65	(38 - 42)

For more information please refer to strain relief section of Chapter 10

Tiewrap Plates

Option 1:

Tiewrap plates as an individual part

Available as an individual component, can be fixed onto a mounting bracket with the use of a profile rail.

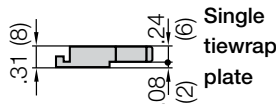
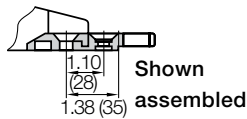

Tiewrap Plate	n Number of Teeth	C Overall Width in. (mm)	B Bore Width in. (mm)	Center Bore
3050-ZB	5	1.97 (50)	1.18 (30)	no
3075-ZB	7	2.95 (75)	2.16 (55)	no
3100-ZB	10	3.94 (100)	3.15 (80)	no
3115-ZB	11	4.53 (115)	3.74 (95)	no
3125-ZB	12	4.92 (125)	4.13 (105)	no
3150-ZB	15	5.91 (150)	5.12 (130)	no
3175-ZB	17	6.89 (175)	6.10 (155)	no
3200-ZB	20	7.87 (200)	7.09 (180)	yes
3225-ZB	22	8.86 (225)	8.07 (205)	yes
3250-ZB	25	9.84 (250)	9.06 (230)	yes

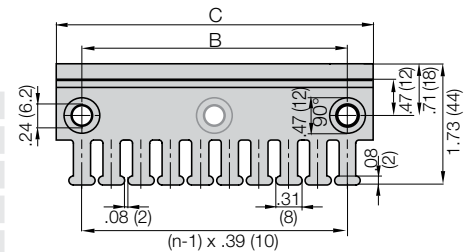

If used with KMA brackets with profile rail please add "KMA" to the end of the part number.

Example: 3050-ZBKMA

For more information please refer to strain relief section of Chapter 10

Option 2:
Clip-on Tiewrap plates

Available as a clip-on tiewrap plate without the use of bolts They are inserted and removed with a screwdriver used as a lever. Clip-on tiewrap plates are also available as an attachment to the opening crossbars.



Part No.	Number of Teeth	Width of Strain Relief in. (mm)
3050-ZC	5	1.97 (50)
3075-ZC	7	2.95 (75)

e-chain system® E4-1

Series E4-32/H4-32/R4-32

Guide Trough



E4-32
H4-32
R4-32

Guide troughs are used with applications where the upper run of the e-chain® glides on the lower run. If using igus® steel guide troughs, the following components are required:

- Full travel length of guide trough
Part Number 98-30
- 1/2 travel length of glide bars
Part number 92-01
- Installation sets as end connectors
Part Number 93-50-XX

-XX indicates the length of the profile rail on which the guide trough is mounted. The values and part numbers are specified in the table on the left. The standard length of the trough components and glide bars is 6.56 ft (2 m.) The required overall length of the guide trough directly correlates to the length of travel.

Example:
Length of travel 164 ft (50 m)
Center mounted

Required guide troughs:
164 ft (50 m) guide trough
82 ft (25 m) glide bar

= 25 sections of 6.56 ft (2 m) guide trough

Part No. 98-30

= 13 sections of 6.56 ft (2 m) glide bar

Part No. 92-01

Required number of installation sets:

= Number of guide trough components + 1
= 25 + 1 = 26

Part number of the installation sets

93-50-XXX

Example: 93-50-400 for 15.75" (400 mm) long profile rail.



Left: Guide trough with glide bars
Right: Guide troughs without glide bars



Installation sets as section connectors

Width of Crossbar
E4-32-05-200-0

	B_{Ri}	Installation Part No.
-05	3.15 (78)	93-50-200
-06	3.86 (96)	93-50-225
-07	4.13 (103)	93-50-225
-087	4.61 (115)	93-50-225
-097	4.92 (125)	93-50-250
-10	5.12 (128)	93-50-250
-11	5.43 (136)	93-50-250
-112	5.59 (141)	93-50-250
-12	6.10 (153)	93-50-275
-137	6.57 (166)	93-50-275
-15	7.09 (178)	93-50-300
-162	7.56 (191)	93-50-300
-17	7.80 (196)	93-50-325
-18	8.07 (203)	93-50-325
-187	8.54 (216)	93-50-325
-20	9.06 (228)	93-50-350
-212	9.53 (241)	93-50-350
-23	10.04 (253)	93-50-375
-237	10.51 (266)	93-50-375
-25	11.02 (278)	93-50-400
-262	11.50 (291)	93-50-400
-28	12.01 (303)	93-50-425
-29	12.48 (316)	93-50-425
-30	12.99 (328)	93-50-450
-312	13.46 (341)	93-50-450
-325	13.98 (353)	93-50-475
-337	14.45 (366)	93-50-475
-350	14.96 (378)	93-50-500
-362	15.43 (391)	93-50-500
-375	15.94 (403)	93-50-525
-387	16.42 (416)	93-50-525
-400	16.93 (428)	93-50-550

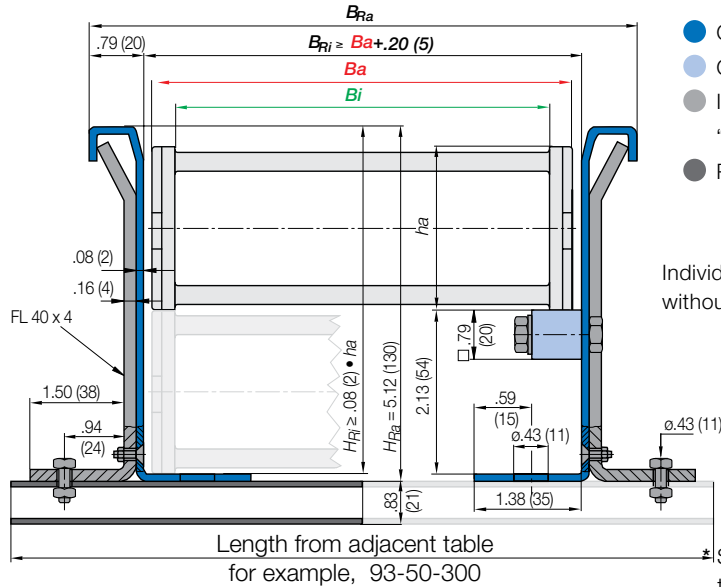

- Guide trough
- Glide bars
- Installation set "Basic"
- Profile rail

Individual attachment without profile rail

* Specialized guide trough available upon request

Standard length profile rail

PDF: igus.com/e-chain-pdfs
Product information: igus.com/e-chains



E4-42
H4-42
R4-42



e-chain system® E4-1

Series E4-42/H4-42/R4-42

Price Index



Series E4-42



Series H4-42



Series R4-42

Special Options Available



Low noise version available with special rubber pads



Cleanroom test upon request



ESD classification:
Electrically conductive ESD/
ATEX version upon request

Assembly Tips



Opening e-chains®: Remove crossbars and clips - Insert screwdriver into the slot, push down, release by lever action



Remove lids/bottoms (e-tubes) - Insert screwdriver into the slot, release by lever action

Other Installation Methods

Vertical, hanging ≤ 328 ft (100 m)

Vertical, standing ≤ 19.69 ft (6 m)

Side-mounted, un_supp. ≤ 6.56 ft (2 m)

Rotary requires further calculation

Usage Guidelines



- If quiet operation is required
- If very high speeds and/or accelerations are required
- Long travels
- High additional loads



- When an extremely low vibration e-chain®/e-tube is required
➤ Series E6-40/R6-40
- When an economic one-sided snap-open e-chain®/e-tube is required
➤ Series 3400/3450/3480/3500

Features & Benefits

- 1 Wide, rounded plastic crossbars - cable friendly
- 2 Low-noise operation through integrated brake in the radial stop dog system
- 3 Hinged snap-open removable lids along the outer radius of the e-tube
- 4 Straight run through inner-/outer-link design
- 5 QuickLock Crossbar, 385-X-Q, available for faster assembly/disassembly
- 6 The tongue and groove design provides greater lateral stability
- 7 New Interior separation kit available
- 8 Crossbars are removable along both radii
- 9 15% more tensile strength (compared to the older E4 series), better unsupported length through improved stop dog system and vertical radial stops
- 10 Version NCST "without camber" simply by turning outer links without unnecessary rework



Also available without camber.
Add NCST to the end of the part number.
Ex: E4-42-20-300NCST

Order Example: Complete e-chain®

Please indicate chain length or number of links. Example:

16.4 ft (5 m) E4-42-20-300-0

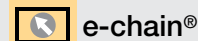

e-chain®

With 2 separators 42.1.1 assembled every 2nd link



Interior Separation

1 Set E4-420-20-12P



Mounting Bracket

e-chain system® E4-1

Series E4-42/H4-42/R4-42

Installation Dimensions



E4-42
H4-42
R4-42

Short travel, unsupported length

- FL_B = unsupported with permitted sag
 - FL_G = unsupported with straight upper run
- Further information ► Design, Chapter 1

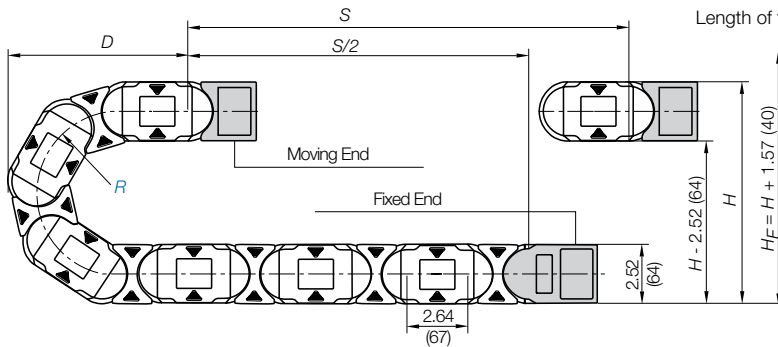
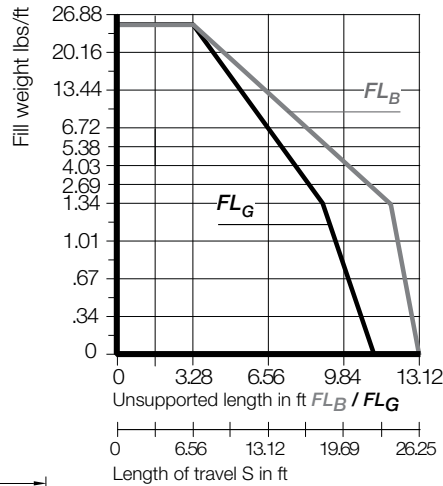
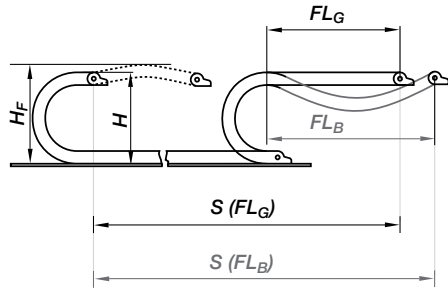

Pitch per link = 2.64" (67 mm)
Links per ft (m) = 4.57 (15)
For center mount applications:
Chain length = $\frac{S}{2} + K$

The required clearance height: $H_F = H + 1.57$ in. (40 mm) (with 2.02 lbs/ft (3 kg/m) fill weight).
Please consult igus® if space is particularly restricted.

R	2.95 (075*)	3.94 (100*)	4.53 (115*)	4.92 (125)	5.91 (150)	6.30 (160)	6.69 (175)	7.87 (200)	9.84 (250)	11.81 (300)	13.78 (350)
H ± 0.25	8.43 (214)	10.39 (264)	11.57 (294)	12.36 (314)	14.33 (364)	15.12 (384)	16.30 (414)	18.27 (464)	22.20 (564)	26.14 (664)	30.08 (764)
D	8.19 (208)	9.17 (233)	9.76 (248)	10.15 (258)	11.14 (283)	11.54 (293)	12.13 (308)	13.11 (333)	15.08 (383)	17.05 (433)	19.02 (483)
K	14.57 (370)	17.72 (450)	19.69 (500)	20.87 (530)	24.02 (610)	25.20 (640)	26.97 (685)	30.12 (765)	36.22 (920)	42.52 (1080)	48.62 (1235)

*Radius not available for e-tubes

For long travels with lowered mounting height

Long travel lengths from 32.8 ft. (10 m) to max. 984 ft. (300 m)

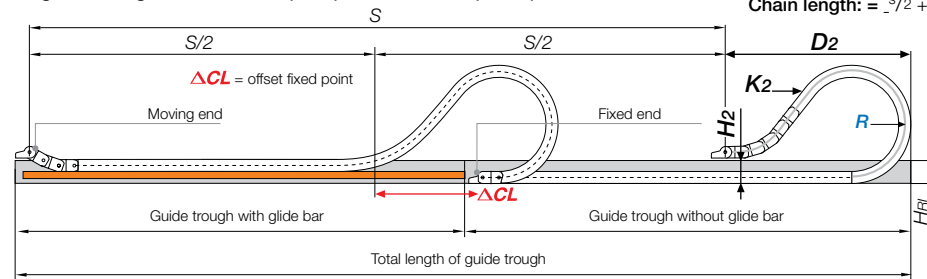

For center mount applications:
Chain length = $\frac{S}{2} + K_2$

R	2.95 (075*)	3.94 (100*)	4.53 (115*)	4.92 (125)	5.91 (150)	6.30 (160)	6.69 (175)	7.87 (200)	9.84 (250)	11.81 (300)	13.78 (350)
H ₂	-	-	9.06 (230)	7.32 (186)	7.32 (186)	7.32 (186)	7.32 (186)	7.32 (186)	7.32 (186)	7.32 (186)	7.32 (186)
D ₂ ± 25	-	-	17.13 (435)	18.70 (475)	22.44 (570)	24.53 (623)	26.38 (670)	30.71 (780)	40.55 (1030)	45.28 (1150)	59.06 (1500)
K ₂	-	-	29.02 (737)	31.65 (804)	36.93 (938)	42.20 (1072)	44.84 (1139)	52.76 (1340)	65.94 (1675)	76.50 (1943)	94.96 (2412)
delta CL	-	-	7.87 (200)	9.06 (230)	11.81 (300)	14.96 (380)	14.96 (380)	18.11 (460)	25.98 (660)	28.74 (730)	40.55 (1030)

In case of travels between 26.3 and 29.4 ft (8 and 12 m) we recommend a longer unsupported length.

For support of the lower run, see Chapter 9 for the Support Tray tool kit

*Radius not available for e-tubes

Short Travels - Unsupported

Unsupported e-chains® feature positive camber over short travels. This must be accounted for when specifying the clearance height. Please refer to **Installation dimensions** for further details.

Legend

- S = Length of travel
- R = Bending radius
- H = Nominal clearance height
- D = Overlength e-chain® radius in final position
- K = $\pi \cdot R + \text{ safety buffer}$
- H_F = Required clearance height
- H_{R1} = Trough inner height
- H₂ = *Mounting height
- D₂ = Overlength - long travels, gliding
- K₂ = *Add-on

*If the mounting bracket location is set lower

Long Travels - Gliding



If the unsupported length is exceeded, the e-chain®/ Tube must glide on itself. This requires a guide trough.

Design, Chapter 1

Technical Data

Speed / acceleration FL_G	max. 65.6 ft/s (20 m/s) / max. 656 ft/s ² (200 m/s ²)
Speed / acceleration FL_B	max. 9.84 ft/s (3 m/s) / max. 19.69 ft/s ² (6 m/s ²)
Gliding speed / acceleration (maximum)	max. 32.8 ft/s (10 m/s) / max. 164 ft/s ² (50 m/s ²)
Material - permitted temperature	igumid G / -40°F (-40°C) up to +248°F (+120°C)
Flammability Class, igumid G	VDE 0304 IIC UL94 HB



Details of material properties

► Chapter 1



PDF: igus.com/e-chain-pdfs
Product information: igus.com/e-chains



Series E4-42 - e-chain® with crossbars every link

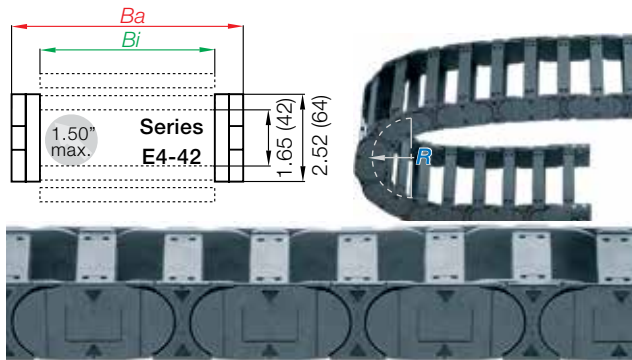

- Crossbars every link
- For use with rigid hydraulic hoses
- For particularly demanding applications
- Can be opened from both sides

Part Number Structure

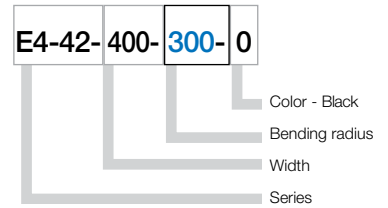

Series H4-42 - e-chain® with crossbars every other link

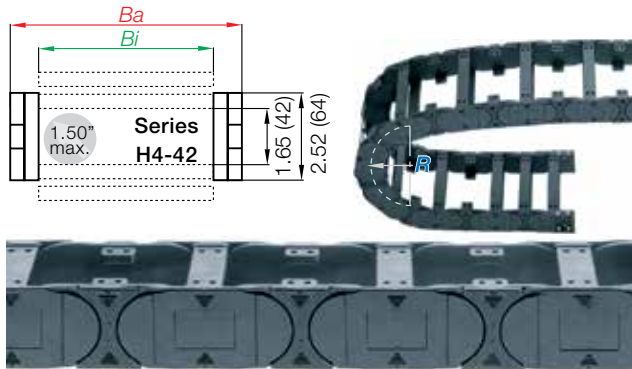

- Crossbars every other link
- Standard configuration
- For nearly every situation
- Can be opened from both sides
- Easy assembly
- Stable
- Cost-effective

Part Number Structure

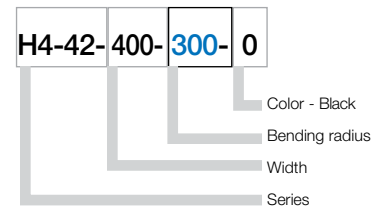

Series R4-42 - fully enclosed e-tube

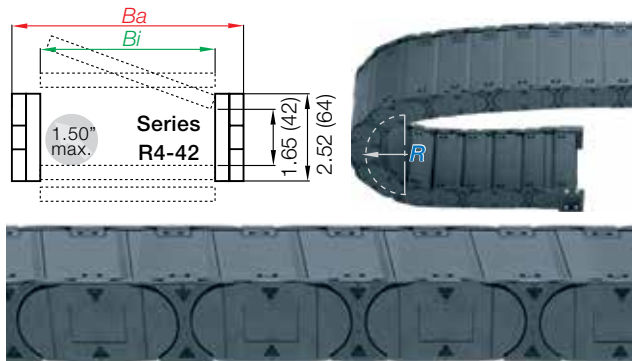

- Fully enclosed
- Excellent cable and hose protection against dirt
- Protection against hot chips
- Lids along inner radius are completely removable
- Lids along the outer radius are single-sided, snap open, hinged on one side as well as completely removable

Part Number Structure

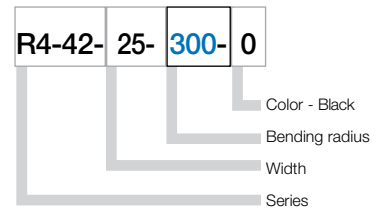

e-chain® as separate parts, links and side plates

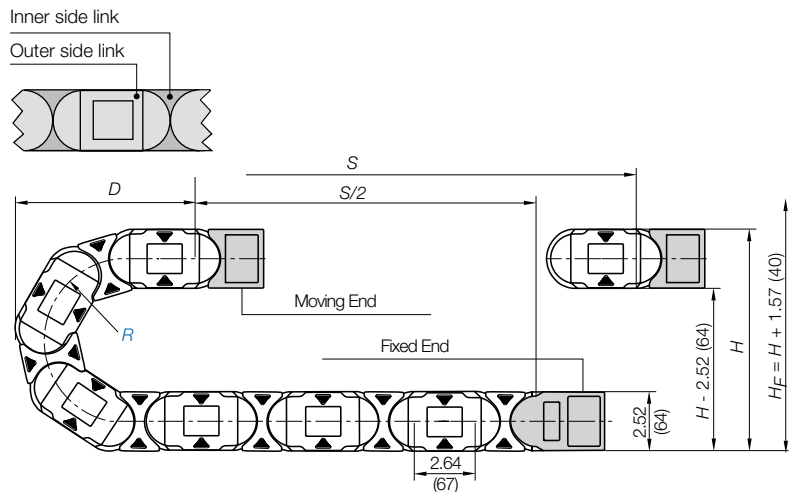
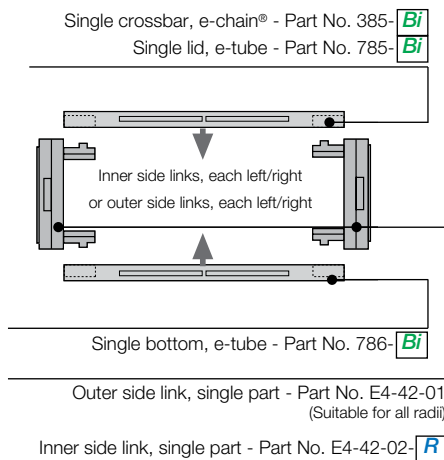

e-chain system® E4-1

Series E4-42/H4-42/R4-42

Product Range



E4-42
H4-42
R4-42

Supplement part number with required radius. Example: E4-42-400-300-0
Pitch: 2.64 in. (67mm) per link, links/ft(m) = 4.57 (15)

Part Number			<i>Bi</i>	<i>Ba</i>	Weight		
Crossbars Every link	Crossbars Every other	Tube Version			in. (mm)	in. (mm)	E4-42 lbs/ft (kg/m)
E4-42-05-	H4-42-05	*R4-42-05- <input type="checkbox"/> -0	1.97 (50)	2.99 (76)	≈ 1.29 (1.92)	≈ 1.21 (1.80)	≈ 1.44 (2.15)
E4-42-06-	H4-42-06-	<input type="checkbox"/> -0	2.68 (68)	3.70 (94)	≈ 1.36 (2.03)	≈ 1.25 (1.86)	–
E4-42-07-	H4-42-07	R4-42-07- <input type="checkbox"/> -0	2.95 (75)	3.98 (101)	≈ 1.38 (2.06)	≈ 1.26 (1.87)	≈ 1.53 (2.28)
E4-42-087-	H4-42-087-	<input type="checkbox"/> -0	3.43 (87)	4.49 (114)	≈ 1.42 (2.12)	≈ 1.28 (1.90)	≈ 1.62 (2.41)
E4-42-097	H4-42-097	<input type="checkbox"/> -0	3.82 (97)	4.72 (120)	≈ 1.43 (2.14)	≈ 1.29 (1.92)	–
E4-42-10-	H4-42-10-	R4-42-10- <input type="checkbox"/> -0	3.94 (100)	4.96 (126)	≈ 1.47 (2.19)	≈ 1.32 (1.96)	≈ 1.69 (2.52)
E4-42-11-	H4-42-11-	R4-42-11- <input type="checkbox"/> -0	4.25 (108)	5.28 (134)	≈ 1.50 (2.24)	≈ 1.32 (1.97)	≈ 1.73 (2.57)
E4-42-112-	H4-42-112-	<input type="checkbox"/> -0	4.41(112)	5.47 (139)	≈ 1.51 (2.25)	≈ 1.32 (1.97)	–
E4-42-12-	H4-42-12-	R4-42-12- <input type="checkbox"/> -0	4.92 (125)	5.94 (151)	≈ 1.57 (2.34)	≈ 1.35 (2.01)	≈ 1.83 (2.73)
E4-42-137-	H4-42-137-	<input type="checkbox"/> -0	5.39 (137)	6.46 (164)	≈ 1.61 (2.39)	≈ 1.37 (2.04)	–
E4-42-15-	H4-42-15-	R4-42-15- <input type="checkbox"/> -0	5.91 (150)	6.93 (176)	≈ 1.65 (2.46)	≈ 1.39 (2.07)	≈ 2.00 (2.98)
E4-42-162-	H4-42-162-	<input type="checkbox"/> -0	6.38 (162)	7.44 (189)	≈ 1.67 (2.48)	≈ 1.40 (2.09)	–
E4-42-17-	H4-42-17-	R4-42-17- <input type="checkbox"/> -0	6.61 (168)	7.64 (194)	≈ 1.71 (2.55)	≈ 1.42 (2.12)	≈ 2.12 (3.15)
E4-42-18-	H4-42-18-	<input type="checkbox"/> -0	6.89 (175)	7.91 (201)	≈ 1.73 (2.57)	≈ 1.43 (2.13)	–
E4-42-187-	H4-42-187-	<input type="checkbox"/> -0	7.36 (187)	8.43 (214)	≈ 1.75 (2.61)	≈ 1.44 (2.15)	–
E4-42-20-	H4-42-20-	R4-42-20- <input type="checkbox"/> -0	7.87 (200)	8.90 (226)	≈ 1.83 (2.72)	≈ 1.48 (2.20)	≈ 2.32 (3.45)
E4-42-212-	H4-42-212-	<input type="checkbox"/> -0	8.35 (212)	9.41 (239)	≈ 1.85 (2.76)	≈ 1.49 (2.22)	–
E4-42-23-	H4-42-23-	<input type="checkbox"/> -0	8.86 (225)	9.88 (251)	≈ 1.90 (2.84)	≈ 1.52 (2.26)	–
E4-42-237-	H4-42-237-	<input type="checkbox"/> -0	9.33 (237)	10.39 (264)	≈ 1.93 (2.87)	≈ 1.53 (2.28)	–
E4-42-25-	H4-42-25-	R4-42-25- <input type="checkbox"/> -0	9.84 (250)	10.87 (276)	≈ 2.00 (2.98)	≈ 1.57 (2.33)	≈ 2.86 (4.25)
E4-42-262-	H4-42-262-	<input type="checkbox"/> -0	10.31 (262)	11.38 (289)	≈ 2.05 (3.05)	≈ 1.59 (2.37)	–
E4-42-28	H4-42-28-	<input type="checkbox"/> -0	10.83 (275)	11.85 (301)	≈ 2.09 (3.11)	≈ 1.61 (2.40)	–
E4-42-29-	H4-42-29-	<input type="checkbox"/> -0	11.30 (287)	12.36 (314)	≈ 2.11 (3.14)	≈ 1.62 (2.41)	–
E4-42-30-	H4-42-30-	R4-42-30- <input type="checkbox"/> -0	11.81 (300)	12.83 (326)	≈ 2.18 (3.24)	≈ 1.65 (2.46)	≈ 3.29 (4.89)
E4-42-312-	H4-42-312-	<input type="checkbox"/> -0	12.28 (312)	13.35 (339)	≈ 2.19 (3.26)	≈ 1.66 (2.47)	–
E4-42-325-	H4-42-325-	<input type="checkbox"/> -0	12.79 (325)	13.82 (351)	≈ 2.24 (3.34)	≈ 1.69 (2.52)	–
E4-42-337-	H4-42-337-	<input type="checkbox"/> -0	13.27 (337)	14.33 (364)	≈ 2.28 (3.40)	≈ 1.71 (2.54)	–
E4-42-350-	H4-42-350-	<input type="checkbox"/> -0	13.78 (350)	14.80 (376)	≈ 2.41 (3.59)	≈ 1.77 (2.64)	–
E4-42-362-	H4-42-362-	<input type="checkbox"/> -0	14.25 (362)	15.31 (389)	≈ 2.47 (3.67)	≈ 1.80 (2.68)	–
E4-42-375-	H4-42-375-	<input type="checkbox"/> -0	14.76 (375)	15.83 (402)	≈ 2.51 (3.73)	≈ 1.82 (2.71)	–
E4-42-387-	H4-42-387-	<input type="checkbox"/> -0	15.24 (387)	16.30 (414)	≈ 2.55 (3.79)	≈ 1.84 (2.74)	–
E4-42-400	H4-42-400-	<input type="checkbox"/> -0	15.75 (400)	16.77 (426)	≈ 2.58 (3.84)	≈ 1.85 (2.76)	–

Choose from the radii below for all of the above sizes

Radius (mm) Example: E4-42-400-300-0

	075**	100**	115**	125	150	160	175	200	250	300	350
<i>R</i>	2.95 (075*)	3.94 (100*)	4.53 (115*)	4.92 (125)	5.91 (150)	6.30 (160)	6.69 (175)	7.87 (200)	9.84 (250)	11.81 (300)	13.78 (350)
<i>H</i> $\frac{D}{20}$	8.43 (214)	10.39 (264)	11.57 (294)	12.36 (314)	14.33 (364)	15.12 (384)	16.30 (414)	18.27 (464)	22.20 (564)	26.14 (664)	30.08 (764)
<i>D</i>	8.19 (208)	9.17 (233)	9.76 (248)	10.15 (258)	11.14 (283)	11.54 (293)	12.13 (308)	13.11 (333)	15.08 (383)	17.05 (433)	19.02 (483)
<i>K</i>	14.57 (370)	17.72 (450)	19.69 (500)	20.87 (530)	24.02 (610)	25.20 (640)	26.97 (685)	30.12 (765)	36.22 (920)	42.52 (1080)	48.62 (1235)

** This radius is not available for the R4-42 Series

*Removable lid only, no hinged option

0 = Standard color black.

For other colors see Chapter 1

For wider chains see page 6.51

For large diameter hoses see page 6.52

PDF: igus.com/e-chain-pdfs
Product information: igus.com/e-chains



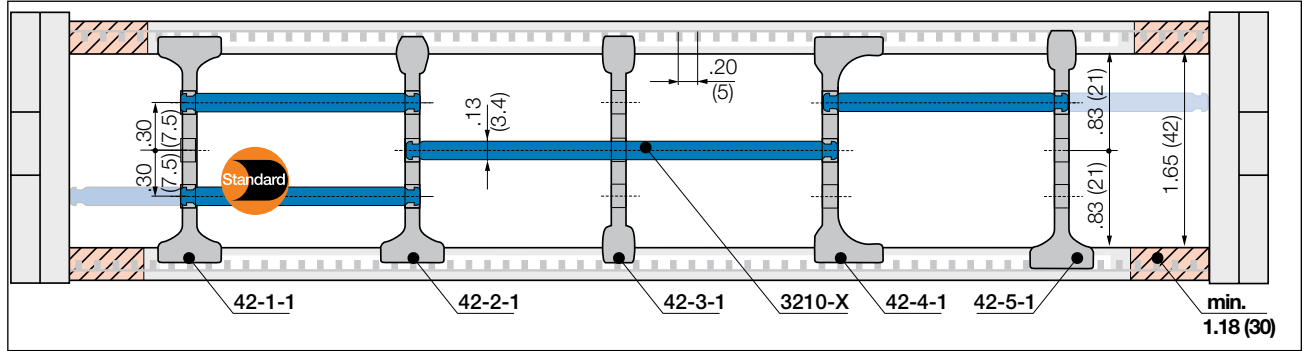

Note e-tube: Please maintain a lateral spacing of 1.18" (30 mm) between the separators and the side links. In the standard configuration separators are assembled every 2nd e-chain® link

Telephone 1-800-521-2747

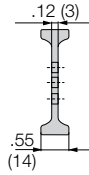

Separator, wide base

Unassembled	Part No. 42-1
Assembled	Part No. 42-1-1

- **Standard separator 42-1 for all applications**

Separator with wide base for maximum locking strength and safe standing in e-chains®.

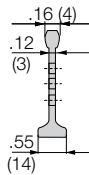

Separator, narrow head

Unassembled	Part No. 42-2
Assembled	Part No. 42-2-1

- **Separator 42-2**

For even faster installation
is used when vertical and horizontal separation is required. Due to its slot, it allows basic vertical/horizontal shelving arrangements.

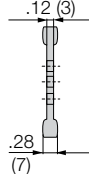

Separator, narrow base

Unassembled	Part No. 42-3
Assembled	Part No. 42-3-1

- **Separator 42-3**

For many thin cables
is used when vertical and horizontal separation is required. Due to its slot, it allows basic vertical/horizontal shelving arrangements.

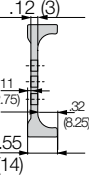

Separator, asymmetrical

Unassembled	Part No. 42-4
Assembled	Part No. 42-4-1

- **Separator 42-4**

For side mounted applications
is used when vertical and horizontal separation is required. Due to its slot, it allows basic vertical/horizontal shelving arrangements.

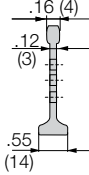

Separator, asymmetrical

Unassembled	Part No. 42-5
Assembled	Part No. 42-5-1

- **Separator 42-5**

Locks safely in .30" (7.5 mm) increments
Notch separator for exact positioning in e-chains®. Recommended for side-mounted applications.

Lockable full-width shelves - for the standard interior separation

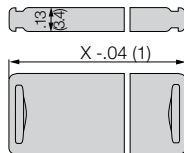

Full width shelf, lockable

Unassembled	Part No. 3200-X
Assembled	Part No. 3210-X

- **Full width shelf, lockable**

Shelf locks safely into separators on both ends, fixed width possible. Separators can be moved freely over the shelf in horizontal direction. Can be used at one height.

Internet: igus.com
email: sales@igus.com
QuickSpec: igus.com/quickspec

Width X in. (mm)	Part No. Unassembled	Part No. Assembled	Width X in. (mm)	Part No. Unassembled	Part No. Assembled	Width X in. (mm)	Part No. Unassembled	Part No. Assembled
1.97 (050)	3200-50	3210-50	4.92 (125)	3200-125	3210-125	8.86 (225)	3200-225	3210-225
2.95 (075)	3200-75	3210-75	5.91 (150)	3200-150	3210-150	9.84 (250)	3200-250	3210-250
3.94 (100)	3200-100	3210-100	6.89 (175)	3200-175	3210-175			
4.53 (115)	3200-115	3210-115	7.87 (200)	3200-200	3210-200			

e-chain system® E4-1
 Series E4-42/H4-42/R4-42
 Interior Separation - Previous Generation



E4-42
 H4-42
 R4-42

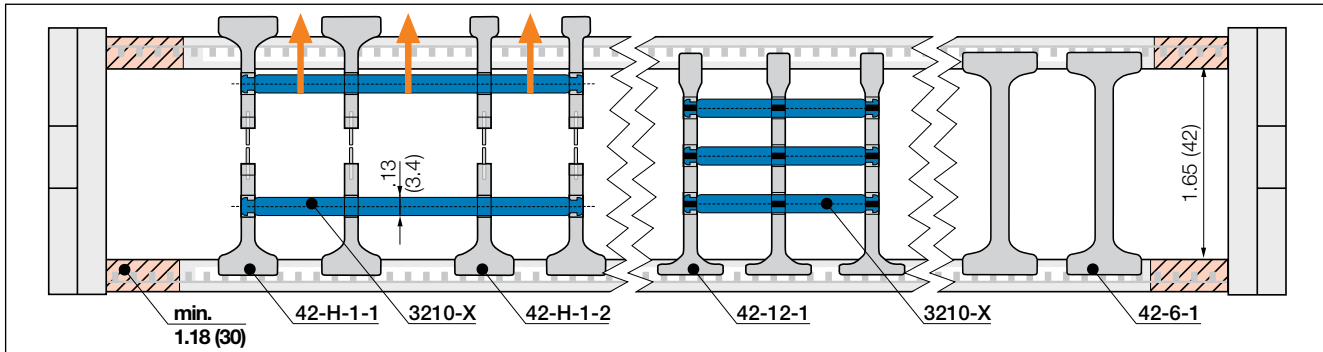

Note e-tube: Please maintain a lateral spacing of 1.18" (30 mm) between the separators and the side links. In the standard configuration separators are assembled every 2nd e-chain® link

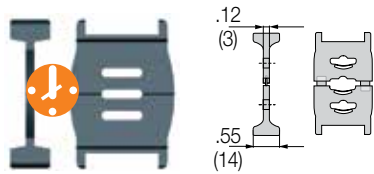

Separator, wide base

Unassembled Part No. 42-H-1
 Assembled Part No. 42-H-1-1

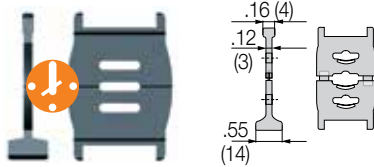

Separator, narrow head

Unassembled Part No. 42-H-2
 Assembled Part No. 42-H-2-1

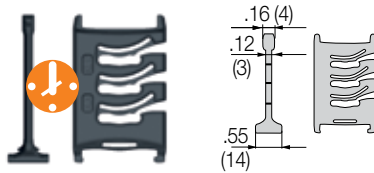

Lean separator

Unassembled Part No. 42-12
 Assembled Part No. 42-12-1



● **Split separators for all applications**

In order to fill e-chains® more easily and effectively, these separators can be split in the middle. This allows easier access to middle shelf partitions. Fast assembly and easy retrofit. 2 types available: with wide or narrow top.

● **Lean separators 42-12**

New design allows extremely fast fitting of shelves in several layers, which significantly reduces assembly time. Enables extremely fast replacement of individual cables in a very full e-chain®.

● **Lean separator design - several layers of cables fitted quickly, save up to 50%* assembly time**

(*Lean separator vs. standard separator - measured on a 4m long e-chain® fitted with 12 cables in the igus® harnessing factory)

More interior separation options

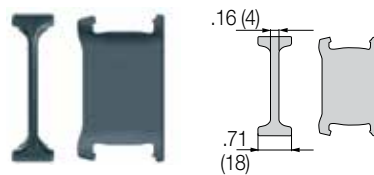

Notch locking separator

Unassembled Part No. 42-6
 Assembled Part No. 42-6-1

● **Notch locking separator for increased holding force**

Notch locking separators offer higher crossbar opening forces for high humidity and/or large hydraulic hoses. They can be positioned precisely and then locked in position

PDF: igus.com/e-chain-pdfs
 Product information: igus.com/e-chains



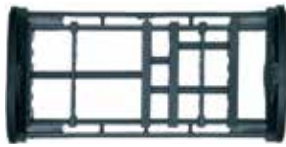

Shelves and Separators

e-chains® and e-tubes can be subdivided both vertically and horizontally using the various interior separation elements. ► **Design, Chapter 1** for layout recommendations.

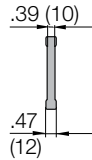
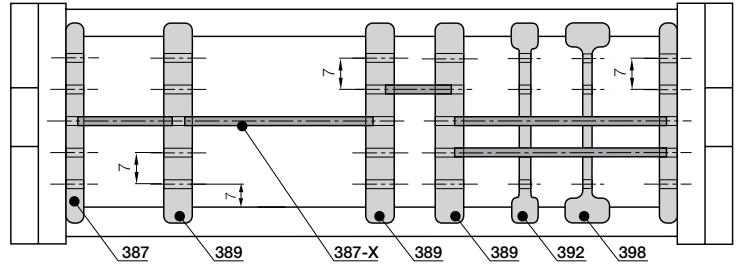

Split separator (chain only)

Unassembled	Part No. T423
Assembled	Part No. T423M

- **Split separator T423 for e-chains®**
This separator is ideal for subsequent shelving or the initial assembly of the e-chain. Fast assembly and disassembly using a hinge/push mechanism. Enhances flexibility

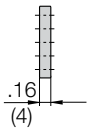

Side Plate

Unassembled	Part No. 386
Assembled	Part No. 387

- **Side plates 386**
This component is used to form the basic pattern of a shelf system.

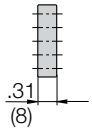

Vertical Separator

Unassembled	Part No. 388
Assembled	Part No. 389

- **Vertical separator 388**
This component is used to form the basic pattern of a shelf system.

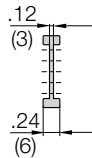

Slotted Separators

Unassembled	Part No. 391
Assembled	Part No. 392

- **Closed Slotted separators 391**
These are used for complex subdivisions. However, they cannot be retrofitted into an existing interior separation system without removing the shelves first.

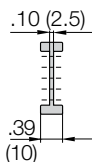

Slotted Separators, Open

Unassembled	Part No. 397
Assembled	Part No. 398

- **Open slotted separator 397**
This separator can be retrofitted into an existing interior separation system without removing the shelves, as long as these shelves fit into the middle 3 slots only.

Width X	Usable Width	Part No.	Part No.
in. (mm)	in. (mm)	Unassembled	Assembled
.71 (18)	.39 (10)	386-18	387-18
.91 (23)	.59 (15)	386-23	387-23
.98 (25)	.67 (17)	386-25	387-25
1.10 (28)	.79 (20)	386-28	387-28
1.30 (33)	.98 (25)	386-33	387-33
1.69 (43)	1.38 (35)	386-43	387-43
1.97 (50)	1.65 (42)	386-50	387-50
2.13 (54)	1.81 (46)	386-54	387-54
2.44 (62)	2.13 (54)	386-62	387-62
2.95 (75)	2.64 (67)	386-75	387-75
3.43 (87)	3.12 (87)	386-87	387-87
3.94 (100)	3.62 (92)	386-100	387-100
4.25 (108)	3.94 (100)	386-108	387-108
4.92 (125)	4.61 (117)	386-125	387-125
5.91 (150)	5.59 (142)	386-150	387-150
6.89 (175)	6.57 (167)	386-175	387-175
7.87 (200)	7.56 (192)	386-200	387-200
8.19 (208)	7.87 (200)	386-208	387-208

Shelves 386-XX

These components form the basic pattern of a shelf system. Shelves of various widths can be arranged at 5 different heights in .28" (7mm) increments

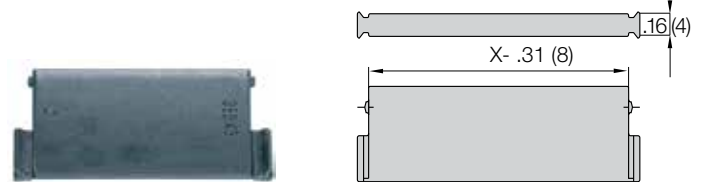

The diagram below is for reference purposes only. Multiple configurations are possible. To create your e-chain shelving cross section please see our online e-chain configurator. Call 1-800-521-2747 for assistance and/or go to igus.com click on the **Products** drop down menu, choose **e-chain Cable Carriers** and on the next drop down menu simply click on **e-chain Configurator**.

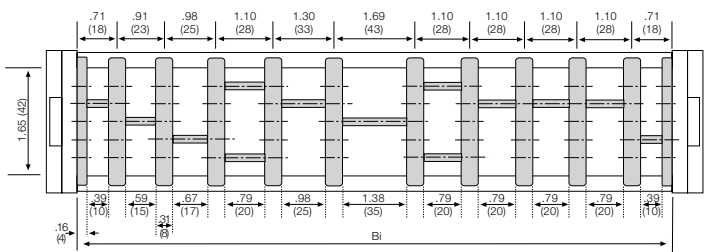

e-chain system® E4-1
 Series E4-42/H4-42/R4-42
 Interior Separation - Previous Generation



E4-42
 H4-42
 R4-42

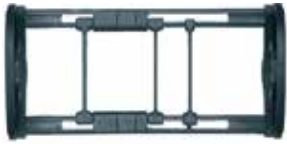

Vertical separators and spacers

Vertical separators are used if a vertical subdivision of the e-chain® interior is required. By standard, vertical separators are assembled every other e-chain® link.

NOTE: Observe a lateral spacing of at least .98 in. (25mm) for e-tubes

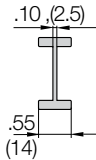
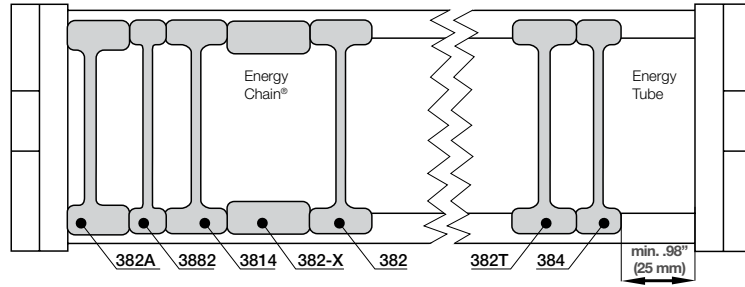

Separator (chain/tube)

Unassembled **Part No. 380**
 Assembled **Part No. 381**

- **Standard separator 380 for e-chains® and e-tubes**
 This separator offers safe stability due to its wide base design, also when used with thick cables or hoses.

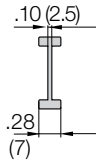

Separator (chain only)

Unassembled **Part No. 3881**
 Assembled **Part No. 3882**

- **Vertical separator 3881 for e-chains®**
 This separator features a narrow 7mm base for applications where a large number of small cables need to be individually separated.

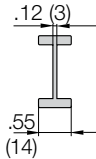

Vertical Separator (tubes only)

Part No. 380T **Part No. 381T**

- **Locking separator 380T for e-tubes**
 It clamps to the fixed radius and remains free along the other radius to facilitate lid removal. When installing please ensure they are identically aligned.

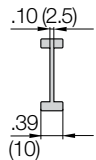

Separator (chain only)

Unassembled **Part No. 383**
 Assembled **Part No. 384**

- **Vertical separator 383 for e-chains®**
 This separator features an increased retention force for applications exposed to very high humidity or extreme loads. It features asymmetric claws for the crossbar which results in the increased retention force.

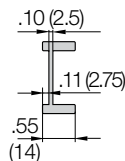

Asymmetric separator (chain only)

Unassembled **Part No. 381A**
 Assembled **Part No. 382A**

- **Asymmetrical separator 381A for e-chains®**
 This separator features an (14mm) base. It can be used in combinations between spacers of different widths and vertical separators in side mounted applications.



Spacer (chain only)

Unassembled **Part No. 381-XX**
 Assembled **Part No. 382-XX**
 XX = width of the spacer

- **NOTE ON SPACERS**
 Vertical separators are adjustable, but can be fixed in position by means of a spacer. Spacers are most often necessary for side mounted applications. The available inner height is reduced by .08" (2mm) **per spacer** (for example if one spacer is placed on either side of the separator, the overall inner height is reduced by .16" (4mm)). To avoid this, place the spacers on the **outside** of the opening crossbar (**not for long travels**).

Spacers available in the following sizes:

Part No. Unassembled	Part No. Assembled	in.	(mm)
381 -10	382 -10	.39"	(10)
381 -15	382 -15	.59"	(15)
381 -20	382 -20	.79"	(20)

PDF: igus.com/e-chain-pdfs
 Product information: igus.com/e-chains



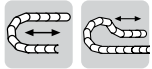

Standard

Option 1: pivoting

- Recommended for unsupported and gliding applications
- Attachment capability on all sides
- Bolted connection outside of chain cross-section
- Space restricted conditions
- Corrosion resistant

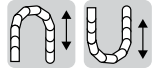

Option 2: locking

- Profile rail option
- Universal use
- Corrosion resistant
- Vertical hanging/standing travels
- Extreme accelerations

Part Number Structure

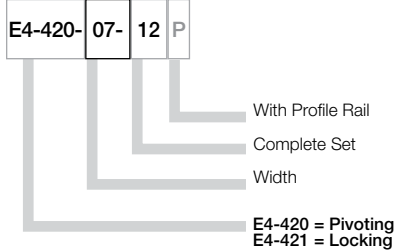

Due to the design of the E4-42 series chains, please note the following when ordering brackets:

Even number of links = full set, part number ending in -12; Odd number of links = 2 pieces, part number ending in -1

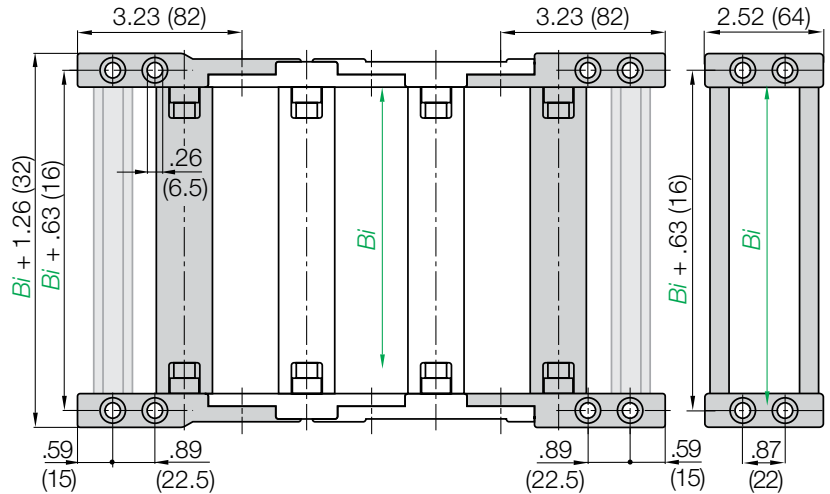
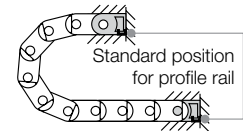
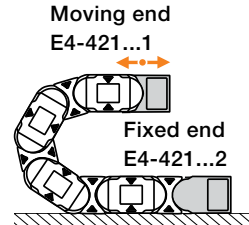
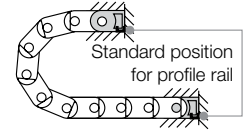
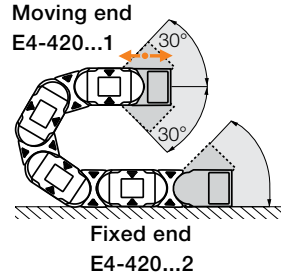

Part No. Full Set (pivoting)
Series E4-42 or H4-42
E4-420-Width-12

Part No. Full Set (pivoting)
with profile rail
Series E4-42 or H4-42
E4-420-Width-12P

Part number examples are shown for pivoting brackets for e-chain.
For locking brackets change part number to 421

Width	Part No. Full Set chain		With Profile Rail	Bi in. (mm)	Width	Part No. Full Set chain		With Profile Rail	Bi in. (mm)
	Pivoting	Locking				Pivoting	Locking		
-05*	E4-420	E4-421	-05-12	1.97 (50)	-212	E4-420	E4-421	-212-12	8.35 (212)
-06	E4-420	E4-421	-06-12	2.68 (68)	-23	E4-420	E4-421	-23-12	8.86 (225)
-07	E4-420	E4-421	-07-12	2.95 (75)	-237	E4-420	E4-421	-237-12	9.33 (237)
-087	E4-420	E4-421	-087-12	3.43 (87)	-25	E4-420	E4-421	-25-12	9.84 (250)
-097	E4-420	E4-421	-097-12	3.82 (97)	-262	E4-420	E4-421	-262-12	10.31 (262)
-10	E4-420	E4-421	-10-12	3.94 (100)	-28	E4-420	E4-421	-28-12	10.83 (275)
-11	E4-420	E4-421	-11-12	4.25 (108)	-29	E4-420	E4-421	-29-12	11.30 (287)
-112	E4-420	E4-421	-112-12	4.41 (112)	-30	E4-420	E4-421	-30-12	11.81 (300)
-12	E4-420	E4-421	-12-12	4.92 (125)	-312	E4-420	E4-421	-312-12	12.28 (312)
-137	E4-420	E4-421	-137-12	5.39 (137)	-325	E4-420	E4-421	-325-12	12.79 (325)
-15	E4-420	E4-421	-15-12	5.91 (150)	-337	E4-420	E4-421	-337-12	13.27 (337)
-162	E4-420	E4-421	-162-12	6.38 (162)	-350	E4-420	E4-421	-350-12	13.78 (350)
-17	E4-420	E4-421	-17-12	6.61 (168)	-362	E4-420	E4-421	-362-12	14.25 (362)
-18	E4-420	E4-421	-18-12	6.89 (175)	-375	E4-420	E4-421	-375-12	14.76 (375)
-187	E4-420	E4-421	-187-12	7.36 (187)	-387	E4-420	E4-421	-387-12	15.24 (387)
-20	E4-420	E4-421	-20-12	7.87 (200)	-400	E4-420	E4-421	-400-12	15.75 (400)

e-chain system® E4-1

Series E4-42/H4-42/R4-42

Mounting Brackets



E4-42
H4-42
R4-42



Option 1: pivoting

- Recommended for unsupported and gliding applications
- Attachment capability on all sides
- Bolted connection outside of chain cross-section
- Space restricted conditions
- Corrosion resistant

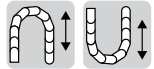

Option 2: locking

- Profile rail option
- Universal use
- Corrosion resistant
- Vertical hanging/standing travels
- Extreme accelerations

Part Number Structure

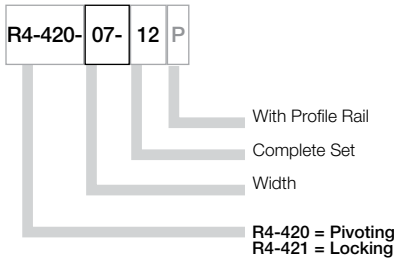

Due to the design of the R4-42 series chains, please note the following when ordering brackets:

Even number of links = full set, part number ending in -12; Odd number of links = 2 pieces, part number ending in -1

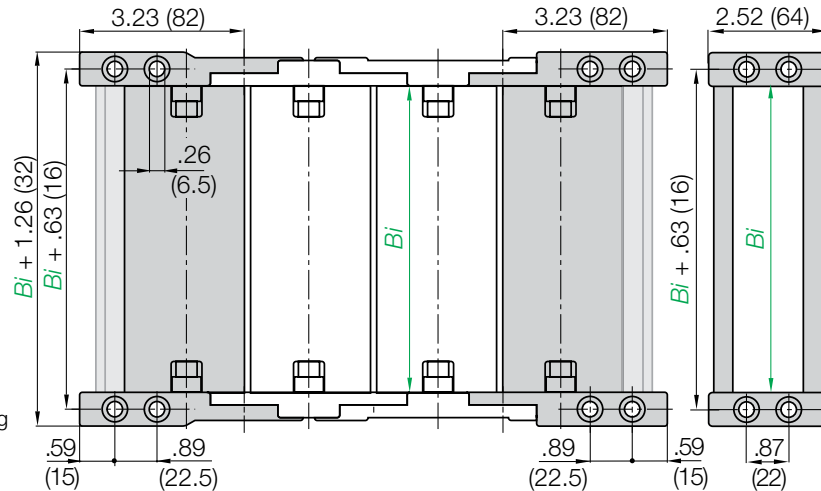
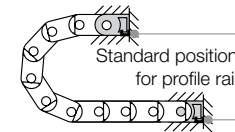
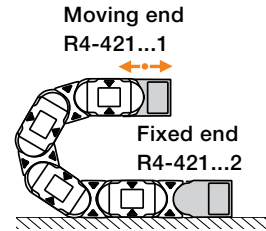
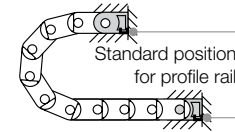
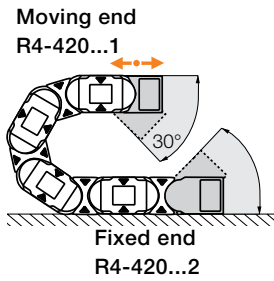

Part No. Full Set (pivoting)
Tube Series R4-42
R4-420-Width-12

Part No. Full Set (pivoting)
with Profile Rail
Tube Series R4-42
R4-420-Width-12P

Part number examples are shown for pivoting brackets for e-chain.
For locking brackets change part number to 421

Width	Part No. Full Set chain		With Profile Rail	Bi
	Pivoting	Locking		in. (mm)
-05*	R4-420	R4-421	-05-12	P 1.97 (50)
-07	R4-420	R4-421	-07-12	P 2.95 (75)
-087	R4-420	R4-421	-087-12	P 3.43 (87)
-10	R4-420	R4-421	-10-12	P 3.94 (100)
-11	R4-420	R4-421	-11-12	P 4.25 (108)
-12	R4-420	R4-421	-12-12	P 4.92 (125)

Width	Part No. Full Set chain		With Profile Rail	Bi
	Pivoting	Locking		in. (mm)
-15	R4-420	R4-421	-15-12	P 5.91 (150)
-17	R4-420	R4-421	-17-12	P 6.61 (168)
-20	R4-420	R4-421	-20-12	P 7.87 (200)
-25	R4-420	R4-421	-25-12	P 9.84 (250)
-30	R4-420	ER4-421	-30-12	P 11.81 (300)

PDF: igus.com/e-chain-pdfs
Product information: igus.com/e-chains



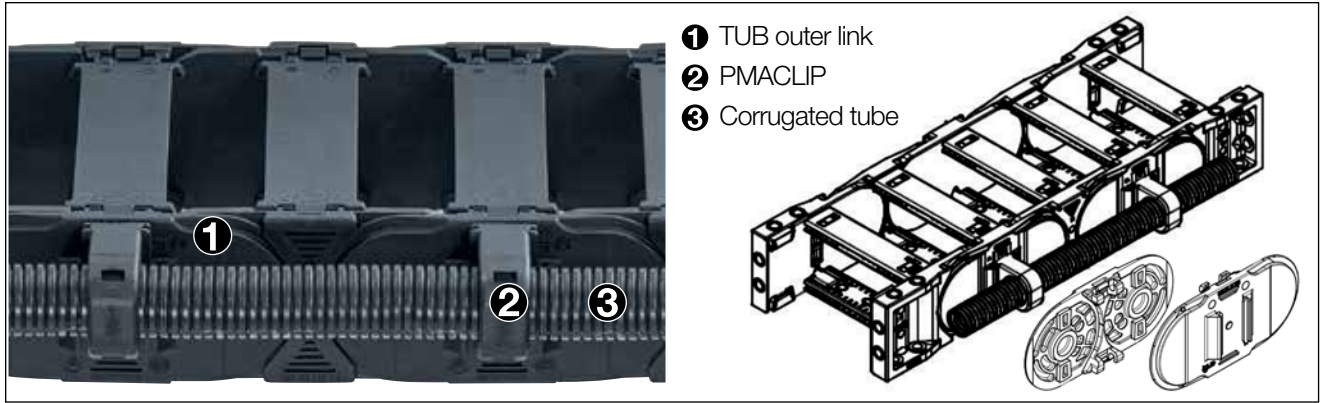

TUB | Safe guidance for corrugated tubes parallel to the e-chain®

- Additional, simple guidance for corrugated tubes on the outside of the e-chain®
- PMACLIP allows corrugated tubes with nominal widths .28 (07mm), .39 (10mm), .47 (12mm), .67 (17mm) to be easily clipped on
- Easy access to the corrugated tubes, fast replacement of the hoses
- Reduce assembly time and cost - easy to assemble, without any additional screws or tools
- The part number includes the e-chain® with TUB side sections; the PMACLIP support and the hose are ordered separately

Part No. TUB	Part No. TUB	Part No. TUB	For corrugated tube nominal diameter
Outer link right*	Outer link left*	Outer link at both ends*	Ø [mm]
E4-42-XXXTUBR-R-0	E4-42-XXXTUBL-R-0	E4-42-XXXTUB-R-0	.28 (07), .39 (10), .47 (12), .67 (17)

*View from the fixed end

Part number appended with width index **XXX Bi** and radius (**R**) e.g.

E4-42-100TUBR-150-0 = with TUB outer sections every 2nd right hand link



Extension links - for extremely wide e-chains® up to 9.84 ft (3m)

- For applications in which particularly high fill weights necessitate extremely wide e-chains®
- The extension link design allows virtually limitless side-by-side attachment of chains
- The unsupported length of a chain can be increased when additional loads are required
- Extension links can be used with e-chains®, e-tubes or a combination of both
- They are suitable for unsupported and gliding applications in a guide trough
- e-chains® with extension links are attached with KMA or steel mounting brackets.

Part number example for e-chain®

E4-42-10/20/10-200-0
E4-42-Bi1/Bi2/Bi3-R-0

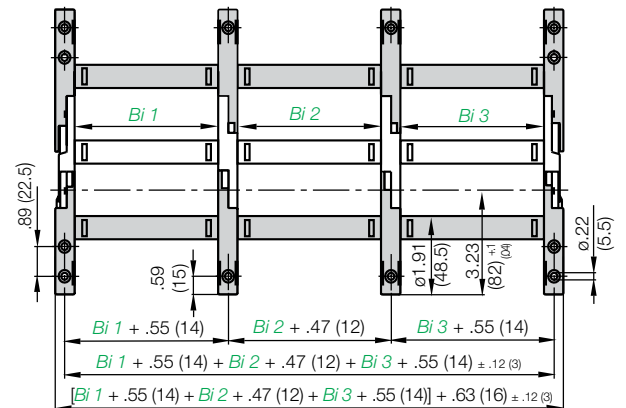

We **strongly recommend** on-site consultation with an igus® technician for individual advice regarding mounting brackets, guide troughs and other design details.

Part No.	Part No.	Part No.
Extension link e-chain®	Extension link e-tube	Extension link as an individual part
E4-42-Bi1/Bi2/Bi3-R-0	R4-42-Bi1/Bi2/Bi3-R-0	384-R-

Complete Part No. with the width index **Bi1/Bi2/Bi3/etc.** and the radius (**R**). Example: E4-32-10/20/10-200-0

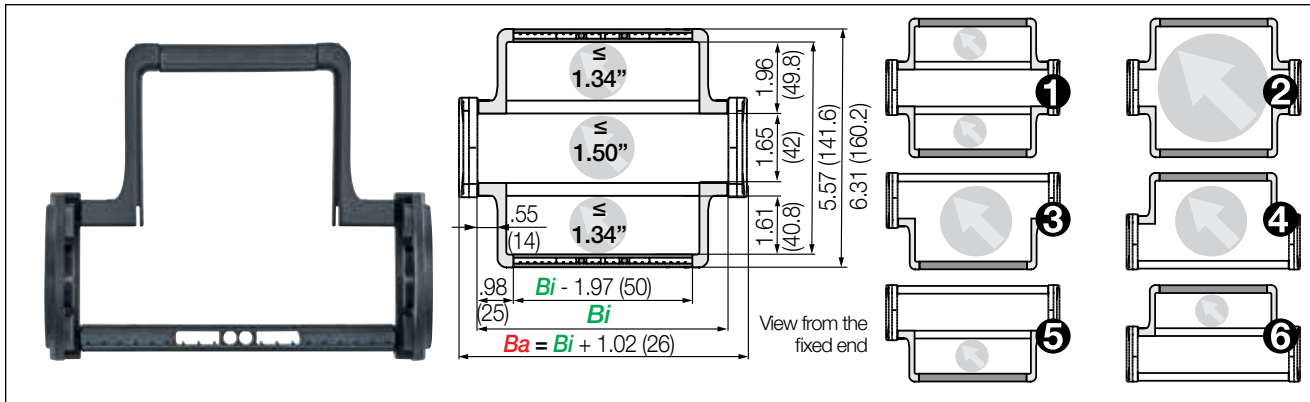

Extender crossbars with flexible width | Safe guiding for large hoses

- For guiding and protecting large hoses
- With mounting for noise dampers
- Cable-friendly design, high crossbar holding force
- The openable extender crossbars can be fitted in different ways and combinations
- Optionally openable along the inner or outer radius

Versions e-chain®

with extender crossbar

	Hose Ø ≤ in. (mm)	Part No. e-chain® with extender crossbar
❶ Extender crossbar and standard crossbar alternating along the inner and outer radius ¹⁾	1.34 (34)	E4-42-XXXHB50-R-0
❷ Extender crossbar on both sides along the inner and outer radius ²⁾	5.12 (130)	E4-42-XXXB50-R-0
❸ Extender crossbar along the outer radius ³⁾	3.35 (85)	E4-42-XXXBE50-R-0
❹ Extender crossbar along the inner radius ²⁾	3.35 (85)	E4-42-XXXBZ50-R-0
❺ Extender crossbar and standard crossbar alternating along the outer radius ³⁾	1.34 (34)	E4-42-XXXHBE50-R-0
❻ Extender crossbar and standard crossbar alternating along inner radius ¹⁾	1.34 (34)	E4-42-XXXHBZ50-R-0

1) Minimum bend radius: **R 125**

2) Minimum bend radius: **R 150**

3) Minimum bend radius: **R 075** *Width available upon request. Delivery time upon request

Bi [mm] Available inner widths

| 100 | 125 | 137 | 150 | 162 | 175 | 187 | 200 | 212 | 225 | 237 | 250 |
| 262 | 275 | 287 | 300 | 312 | 325 | 337 | 350 | 362 | 375 | 387 | 400 |

Complete Part No. with the width index **XXX Bi** and the radius (**R**). Example

E4-42-100B50-150-0 = extender crossbar on both sides along inner and outer radius



The E4.1 can be fitted with openable extender crossbars, which increase the size of the interior of the e-chain®. Crossbars can be fitted in various ways: from one or both sides, alternating with standard crossbars and or any combination

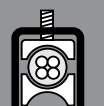

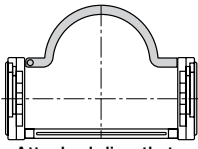

Attached directly to the side link.

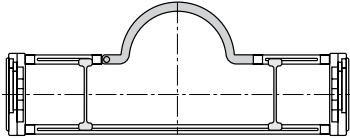

Round extender crossbar combined with standard snap-open crossbars.

Extender crossbars

For careful guiding of large diameter cables and hoses

- Intended for cables and hoses with a maximum outer diameter of 4.13 in. (105 mm).
- Gliding operation with crossbars assembled along the outer radius in conjunction with a special guide trough
- Gliding operation not guaranteed with crossbars assembled along the inner radius
- The extender crossbar can either be attached to the side links directly or can be used in combination with two standard snap-open crossbars.



Part No.	Max Ø Hose in. (mm)	Style	Installation Side Link	Combined with Snap-Open Crossbars
385-15-RHD115	4.13 (105)	Round	No	Yes
385-18-RD115	4.13 (105)	Round	Yes	No

Hinged crossbars

- Typically, e-chain® crossbars are completely removable. In cases where it is preferable that the opening crossbars remain on the e-chain®, a hinged design has been developed.
- Hinged crossbar: Part No. 385-02
- Snap-open crossbar (shortened): Bi-1.48" (37.5 mm) Part No. 385-03 (smallest inner width Bi = 3.44" (87.5 mm))

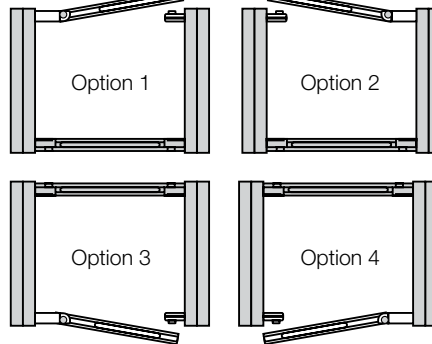
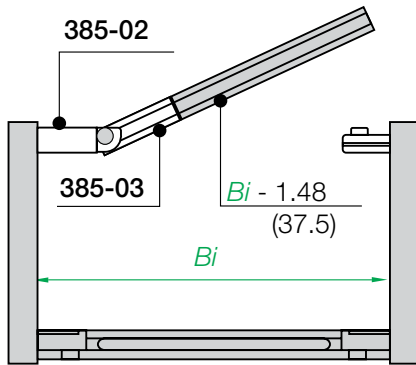

Part No.	Part No.	Part No. openable
e-chain® with hinged crossbar	swivel clip as an individual part	crossbar as an individual part
E4-42-Bi-Z-R-0	385-02	385-03

Chainfix clamps for the profile rail

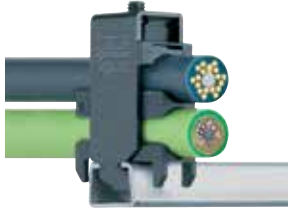

igus® Chainfix strain relief elements are available in either steel or stainless steel. They can be adjusted with a hexagon socket and are available in single, double and triple configurations.

Part No. Single Clamp		Part No. Double Clamp		Part No. Triple Clamp		Cable ø	
Steel	Stainless	Steel	Stainless	Steel	Stainless	in.	(mm)
CFX12-1	CFX12-1E	CFX12-2	CFX12-2E	CFX12-3	–	.24 - .47	(06 - 12)
CFX14-1	CFX14-1E	CFX14-2	CFX14-2E	CFX14-3	–	.47 - .55	(12 - 14)
CFX16-1	CFX16-1E	CFX16-2	CFX16-2E	CFX16-3	–	.55 - .63	(14 - 16)
CFX18-1	CFX18-1E	CFX18-2	CFX18-2E	CFX18-3	–	.63 - .71	(16 - 18)
CFX20-1	CFX20-1E	CFX20-2	CFX20-2E	CFX20-3	–	.71 - .79	(18 - 20)
CFX22-1	CFX22-1E	CFX22-2	CFX22-2E	CFX22-3	–	.79 - .87	(20 - 22)
CFX26-1	CFX26-1E	CFX26-2	CFX26-2E	–	–	.87 - 1.02	(22 - 26)
CFX30-1	CFX30-1E	CFX30-2	CFX30-2E	–	–	1.02 - 1.18	(26 - 30)
CFX34-1	CFX34-1E	CFX34-2	CFX34-2E	–	–	1.18 - 1.34	(30 - 34)
CFX38-1	CFX38-1E	–	–	–	–	1.34 - 1.50	(34 - 38)
CFX42-1	CFX42-1E	–	–	–	–	1.50 - 1.65	(38 - 42)

For more information please refer to strain relief section of Chapter 10.

Tiewrap Plates

Option 1:

Tiewrap plates as an individual part

Available as an individual component, can be fixed onto a mounting bracket with the use of a profile rail.

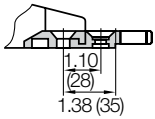

Shown assembled

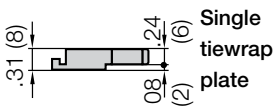

Single tiewrap plate

Tiewrap Plate	n Number of Teeth	C Overall Width in. (mm)	B Bore Width in. (mm)	Center Bore
3050-ZB	5	1.97 (50)	1.18 (30)	no
3075-ZB	7	2.95 (75)	2.16 (55)	no
3100-ZB	10	3.94 (100)	3.15 (80)	no
3115-ZB	11	4.53 (115)	3.74 (95)	no
3125-ZB	12	4.92 (125)	4.13 (105)	no
3150-ZB	15	5.91 (150)	5.12 (130)	no
3175-ZB	17	6.89 (175)	6.10 (155)	no
3200-ZB	20	7.87 (200)	7.09 (180)	yes
3225-ZB	22	8.86 (225)	8.07 (205)	yes
3250-ZB	25	9.84 (250)	9.06 (230)	yes

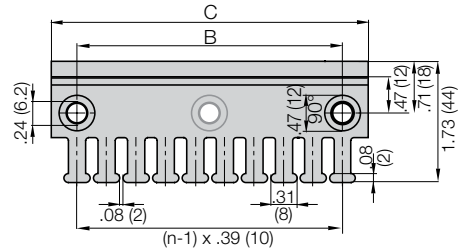

If used with KMA brackets with profile rail please add "KMA" to the end of the part number.

Example: 3050-ZBKMA

For more information please refer to strain relief section of Chapter 10

Option 2:

Clip-on Tiewrap plates

Available as a clip-on tiewrap plate without the use of bolts They are inserted and removed with a screwdriver used as a lever. Clip-on tiewrap plates are also available as an attachment to the opening crossbars.



Part No.	Number of Teeth	Width of Strain Relief in. (mm)
3050-ZC	5	1.97 (50)
3075-ZC	7	2.95 (75)

For more information please refer to strain relief section of Chapter 10.



Width of Crossbar
E4-42-05-200-0

	B_{Ri}	Installation Part No.
-05	3.19 (81)	93-50-200
-06	3.90 (99)	93-50-225
-07	4.17 (106)	93-50-225
-087	4.69 (119)	93-50-250
-097	4.92 (125)	93-50-250
-10	5.16 (131)	93-50-250
-11	5.47 (139)	93-50-250
-112	5.67 (144)	93-50-275
-12	6.14 (156)	93-50-275
-137	6.65 (169)	93-50-300
-15	7.12 (181)	93-50-300
-162	7.64 (194)	93-50-325
-17	7.83 (199)	93-50-325
-18	8.11 (206)	93-50-325
-187	8.62 (219)	93-50-350
-20	9.09 (231)	93-50-350
-212	9.61 (244)	93-50-375
-23	10.08 (256)	93-50-375
-237	10.59 (269)	93-50-400
-25	11.06 (281)	93-50-400
-262	11.57 (294)	93-50-425
-28	12.05 (306)	93-50-425
-29	12.56 (319)	93-50-450
-30	13.03 (331)	93-50-450
-312	13.54 (344)	93-50-475
-325	14.01 (356)	93-50-475
-337	14.52 (369)	93-50-500
-350	15.00 (381)	93-50-500
-362	15.51 (394)	93-50-525
-375	16.02 (407)	93-50-525
-387	16.50 (419)	93-50-550
-400	16.97 (431)	93-50-550

Guide troughs are used with applications where the upper run of the e-chain® glides on the lower run. If using igus® steel guide troughs, the following components are required:

- Full travel length of guide trough
Part No. 93-30
- 1/2 travel length of glide bars
Part No. 93-01
- Installation sets as end connectors
Part No. 93-50-XX

-XX indicates the length of the profile rail on which the guide trough is mounted. The values and part numbers are specified in the table below. The standard length of the trough components and glide bars is 6.56 ft (2 m). The required overall length of the guide trough directly correlates to the length of travel

Example:

Length of travel 164 ft (50 m)
Center mounted

Required guide troughs:

164 ft (50 m) guide trough,
82 ft (25 m) glide bar
= 25 sections of 6.56 ft (2 m) guide trough

Part No. 93-30

= 13 sections of 6.56 ft (2 m) glide bar

Part No. 93-01

Required number of installation sets:

= Number of guide trough components + 1
= 25 + 1 = 26

Part No. of the installation sets **93-50-XXX**

Example: 93-50-400 for 15.75 (400 mm) long profile rail



Left: Guide trough with glide bars
Right: Guide troughs without glide bars



Installation sets as section connectors

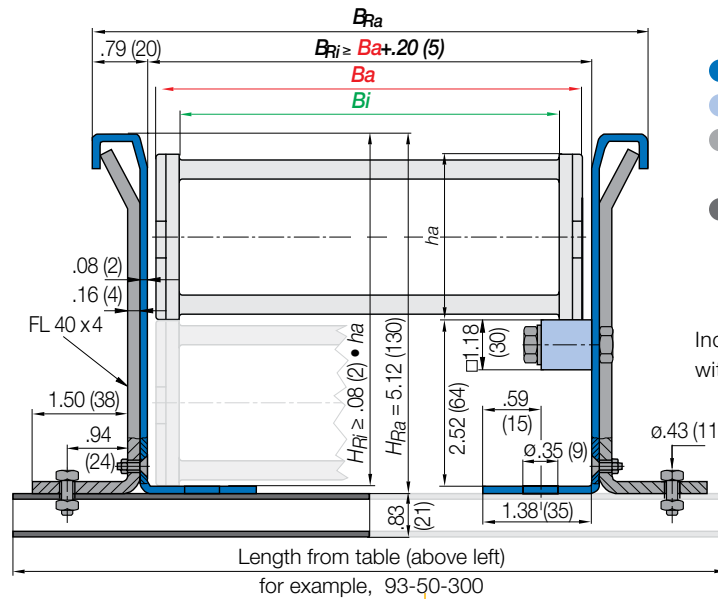

- Guide trough
- Glide bars
- Installation set "Basic"
- Profile rail

Individual attachment without profile rail

* Specialized guide trough available upon request

Standard length profile rail

PDF: igus.com/e-chain-pdfs
Product information: igus.com/e-chains



E4-56
H4-56
R4-56



e-chain system® E4-1

Series E4-56/H4-56/R4-56

Price Index



Series E4-56



Series H4-56



Series R4-56

Special Options Available



Low noise version available with special rubber pads



Cleanroom test upon request



ESD classification: Electrically conductive ESD/ATEX version upon request

Assembly Tips



Opening e-chains®: Remove crossbars and clips - Insert screwdriver into the slot, push down, release by lever action



Remove lids/bottoms (e-tubes) - Insert screwdriver into the slot, release by lever action

Other Installation Methods

Vertical, hanging ≤ 328 ft (100 m)

Vertical, standing ≤ 19.69 ft (6 m)

Side-mounted, un supp. ≤ 8.20 ft (2.5 m)

Rotary requires further calculation

Usage Guidelines



- If quiet operation is required
- If very high speeds and/or accelerations are required
- Long travels
- High additional loads



- When an extremely low vibration e-chain®/e-tube is required
➤ Series E6-52
- When an economic one-sided snap-open e-chain®/e-tube is required
➤ Series 14040/14140/R18840

Features & Benefits

- 1 Wide, rounded plastic crossbars - cable friendly
- 2 Low-noise operation through integrated brake in the radial stop dog system
- 3 Hinged snap-open removable lids along the outer radius of the e-tube
- 4 Straight run through inner-/outer-link design
- 5 The tongue and groove design provides greater lateral stability
- 6 QuickLock Crossbar, 450-X-Q, available for faster assembly/disassembly
- 7 New Interior separation kit available
- 8 Crossbars are removable along both radii
- 9 15% more tensile strength (compared to the older E4 series), better unsupported length through improved stop dog system and vertical radial stops
- 10 Version NCST "without camber" simply by turning outer links without unnecessary rework

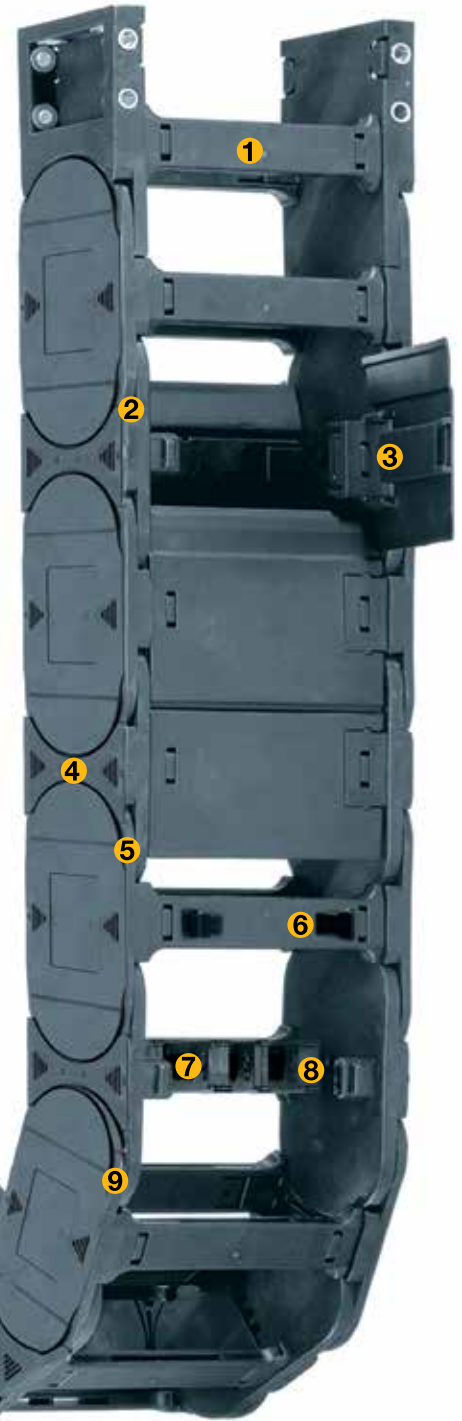

Also available without camber. Add NCST to the end of the part number.
Ex: E4-56-30-300NCST

Order Example: Complete e-chain®

Please indicate chain length or number of links. Example:

9.84 ft (3 m) **E4-56-30-300-0**



e-chain®

With 2 separators **56.1.1** assembled every 2nd link



Interior Separation

1 Set **E4-560-30-12P**



Mounting Bracket

e-chain system® E4-1

Series E4-56/H4-56/R4-56

Installation Dimensions

Short travel, unsupported length

- FL_B = unsupported with permitted sag
 - FL_G = unsupported with straight upper run
- Further information ► Design, Chapter 1

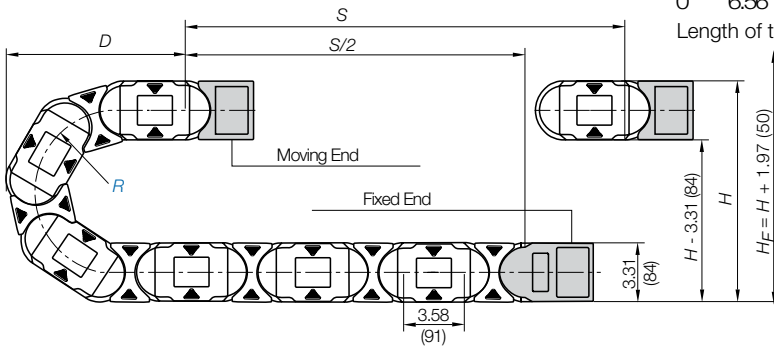
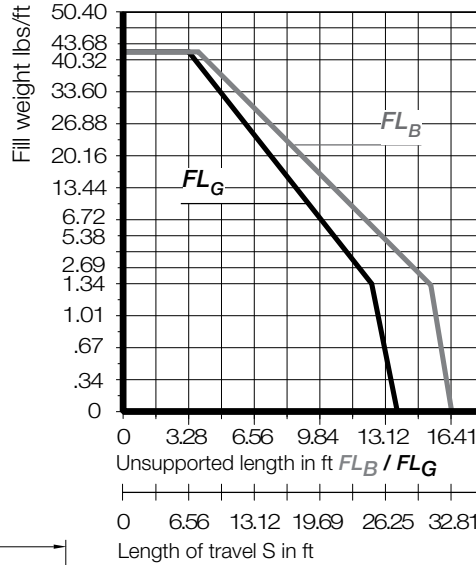
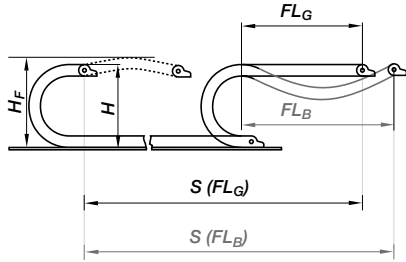

Pitch per link: = 3.58" (91 mm)
 Links per ft (m): = 3.35 (11)
 For center mount applications:
 Chain length = $\frac{S}{2} + K$

The required clearance height: $H_F = H + 1.96$ in. (50 mm) (with 2.02 lbs/ft (3 kg/m) fill weight. Please consult igus® if space is particularly restricted.

R	*5.31 (135)	5.91 (150)	6.89 (175)	7.87 (200)	9.45 (240)	9.84 (250)	11.81 (300)	13.78 (350)	15.75 (400)	17.72 (450)	19.68 (500)
H^{*+25}	13.94 (354)	15.12 (384)	17.09 (434)	19.06 (484)	22.20 (564)	22.99 (584)	26.93 (684)	30.87 (784)	34.80 (884)	38.74 (984)	42.68 (1084)
D	12.36 (314)	12.95 (329)	13.94 (354)	14.92 (379)	16.50 (419)	16.89 (429)	18.86 (479)	20.83 (529)	22.79 (579)	24.76 (629)	26.73 (679)
K	24.02 (610)	25.79 (655)	28.94 (735)	32.09 (815)	37.01 (940)	38.19 (970)	44.29 (1125)	50.59 (1285)	56.69 (1440)	62.99 (1600)	69.09 (1755)

For long travels with lowered mounting height

Long travel lengths from 32.8 ft.(10m) to max. 1,312.4 ft. (400m)

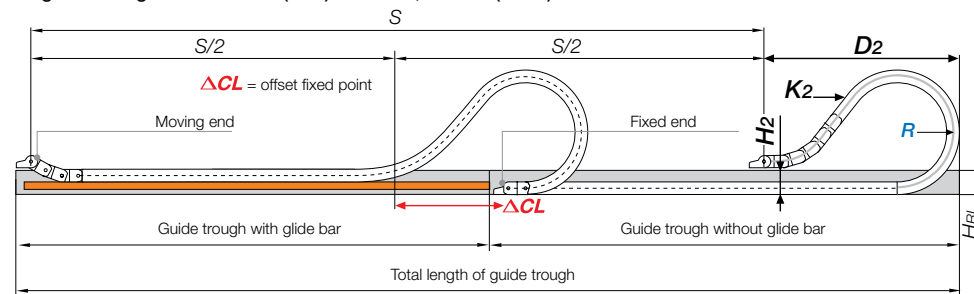

For center mount applications:
 Chain length: = $\frac{S}{2} + K_2$

Long Travels - Gliding



If the unsupported length is exceeded, the e-chain®/ Tube must glide on itself. This requires a guide trough.

Design, Chapter 1

R	*5.31 (135)	5.91 (150)	6.89 (175)	7.87 (200)	9.45 (240)	9.84 (250)	11.81 (300)	13.78 (350)	15.75 (400)	17.72 (450)	19.68 (500)
H_2	10.63 (270)	10.47 (266)	10.47 (266)	10.47 (266)	10.47 (266)	10.47 (266)	10.47 (266)	10.47 (266)	10.47 (266)	10.47 (266)	10.47 (266)
D_2	10.55 (268)	17.72 (450)	22.83 (580)	27.95 (710)	35.43 (900)	38.58 (980)	46.46 (1180)	56.69 (1440)	60.24 (1530)	66.93 (1700)	72.83 (1850)
K_2	24.02 (610)	32.24 (819)	42.99 (1092)	50.16 (1274)	60.91 (1547)	64.49 (1638)	78.82 (2002)	89.57 (2275)	100.31 (2548)	114.64 (2912)	128.98 (3276)
ΔCL	-	6.26 (159)	10.20 (259)	14.54 (359)	20.04 (509)	22.01 (559)	27.91 (709)	35.79 (909)	37.76 (959)	41.69 (1059)	45.63 (1159)

In case of travels between 32.8 and 39.4 ft (10 and 12 m) we recommend a longer unsupported length.

For support of the lower run, see Chapter 9 for the Support Tray tool kit

*135 mm not available for the R4-56 e-chain

Technical Data



Details of material properties

► Chapter 1

E4-56
 H4-56
 R4-56



Short Travels - Unsupported

Unsupported e-chains® feature positive camber over short travels. This must be accounted for when specifying the clearance height. Please refer to **Installation dimensions** for further details.

Legend

- S = Length of travel
- R = Bending radius
- H = Nominal clearance height
- D = Overlength e-chain® radius in final position
- $K = \pi \cdot R + \text{safety buffer}$
- H_F = Required clearance height
- H_{Ri} = Trough inner height
- H_2 = *Mounting height
- D_2 = Overlength - long travels, gliding
- K_2 = *Add-on

*If the mounting bracket location is set lower

PDF: igus.com/e-chain-pdfs
 Product information: igus.com/e-chains



Series E4-56 - e-chain® with crossbars every link

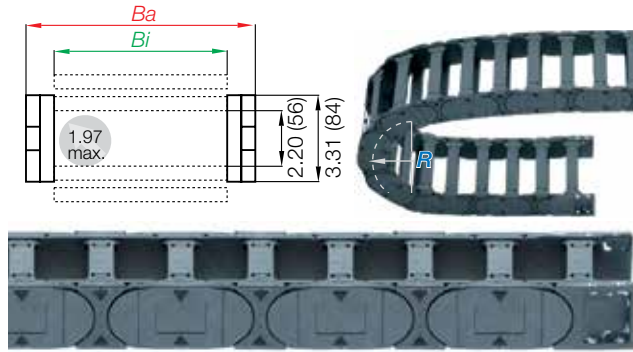

- Crossbars every link
- For use with rigid hydraulic hoses
- For particularly demanding applications
- Can be opened from both sides

Part Number Structure

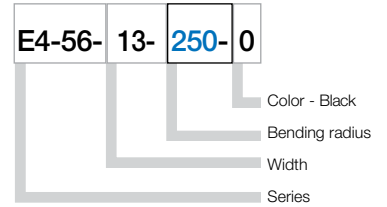

Series H4-56 - e-chain® with crossbars every other link

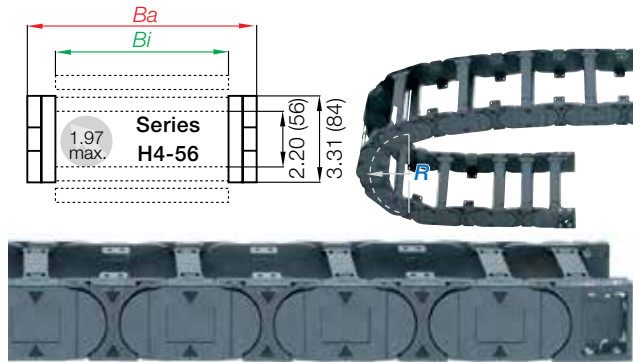

- Crossbars every other link
- Standard configuration
- For nearly every situation
- Can be opened from both sides
- Easy assembly
- Stable
- Cost-effective

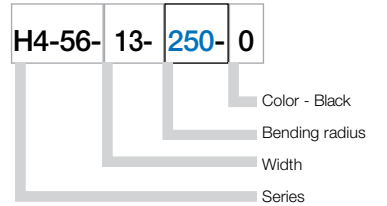

Series R4-56 - fully enclosed e-tube

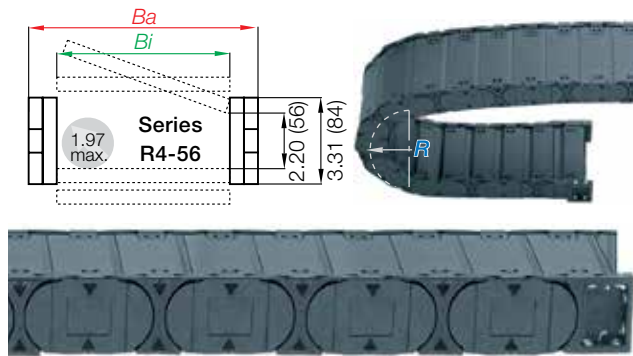

- Fully enclosed
- Excellent cable and hose protection against dirt
- Protection against hot chips
- Lids along inner radius are completely removable
- Lids along the outer radius are single-sided, snap open, hinged on one side as well as completely removable

Part Number Structure

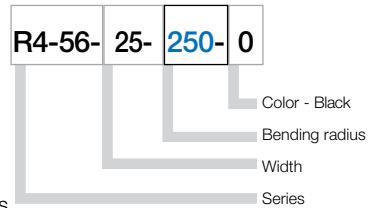

e-chain® as separate parts, links and side plates

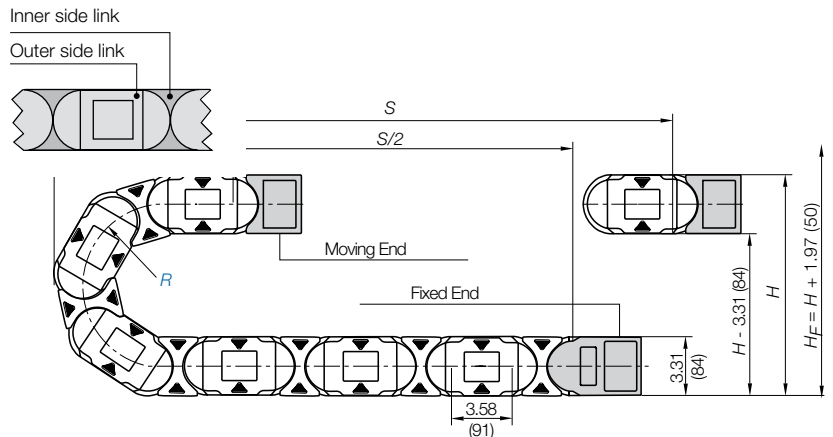
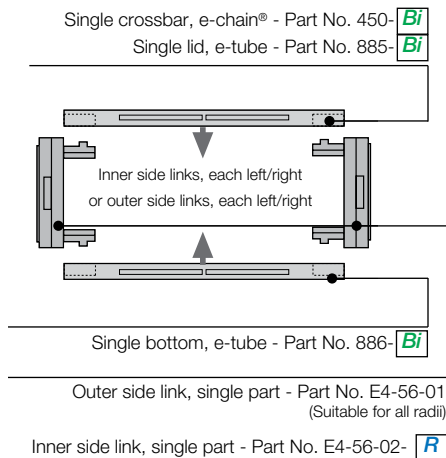

e-chain system® E4-1
Series E4-56/H4-56/R4-56
Product Range



E4-56
H4-56
R4-56

Part Number			Weight					
Crossbars	Crossbars	Tube	<i>Bi</i>	<i>Ba</i>	E4-56	H4-56	R4-56	
Every link	Every other	Version	in. (mm)	in. (mm)	lbs/ft (kg/m)	lbs/ft (kg/m)	lbs/ft (kg/m)	
E4-56-05-	H4-56-05-	<input type="checkbox"/> -0	1.97 (50)	3.31 (84)	≈ 2.22 (3.30)	≈ 2.12 (3.16)	-	
E4-56-055-	H4-56-055-	<input type="checkbox"/> -0	2.17 (55)	3.50 (89)	≈ 2.45 (3.65)	≈ 2.43 (3.62)	-	
E4-56-06-	H4-56-06-	<input type="checkbox"/> -0	2.56 (65)	3.90 (99)	≈ 2.28 (3.39)	≈ 2.15 (3.20)	-	
E4-56-07-	H4-56-07-	*R4-56-07-	2.95 (75)	4.29 (109)	≈ 2.33 (3.46)	≈ 2.18 (3.24)	≈ 2.63 (3.91)	
E4-56-08-	H4-56-08-	<input type="checkbox"/> -0	3.43 (87)	4.76 (121)	≈ 2.38 (3.54)	≈ 2.20 (3.28)	-	
E4-56-10-	H4-56-10-	R4-56-10-	3.94 (100)	5.28 (134)	≈ 2.44 (3.63)	≈ 2.23 (3.32)	≈ 2.82 (4.20)	
E4-56-11-	H4-56-11-	<input type="checkbox"/> -0	4.41 (112)	5.79 (147)	≈ 2.52 (3.75)	≈ 2.27 (3.38)	-	
E4-56-12-	H4-56-12-	R4-56-12-	4.92 (125)	6.26 (159)	≈ 2.57 (3.83)	≈ 2.30 (3.42)	≈ 3.06 (4.56)	
E4-56-13-	H4-56-13-	<input type="checkbox"/> -0	5.39 (137)	6.77 (172)	≈ 2.66 (3.96)	≈ 2.35 (3.49)	-	
E4-56-15-	H4-56-15-	R4-56-15-	5.91 (150)	7.24 (184)	≈ 2.69 (4.00)	≈ 2.36 (3.51)	≈ 3.32 (4.94)	
E4-56-16-	H4-56-16-	<input type="checkbox"/> -0	6.38 (162)	7.76 (197)	≈ 2.76 (4.11)	≈ 2.39 (3.56)	-	
E4-56-169-	H4-56-169-	<input type="checkbox"/> -0	6.65 (169)	8.03 (204)	≈ 3.02 (4.49)	≈ 2.71 (4.03)	-	
E4-56-17-	H4-56-17-	R4-56-17-	6.89 (175)	8.23 (209)	≈ 2.86 (4.25)	≈ 2.44 (3.63)	≈ 3.53 (5.25)	
E4-56-182-	H4-56-182-	<input type="checkbox"/> -0	7.16 (182)	8.54 (217)	≈ 3.08 (4.59)	≈ 2.74 (4.08)	-	
E4-56-18-	H4-56-18-	<input type="checkbox"/> -0	7.36 (187)	8.74 (222)	≈ 2.93 (4.36)	≈ 2.48 (3.69)	-	
E4-56-20-	H4-56-20-	R4-56-20-	7.87 (200)	9.21 (234)	≈ 2.96 (4.41)	≈ 2.49 (3.71)	≈ 3.74 (5.56)	
E4-56-207-	H4-56-207-	<input type="checkbox"/> -0	8.15 (207)	9.53 (242)	≈ 3.21 (4.77)	≈ 2.80 (4.17)	-	
E4-56-21-	H4-56-21-	<input type="checkbox"/> -0	8.35 (212)	9.72 (247)	≈ 3.01 (4.48)	≈ 2.52 (3.75)	-	
E4-56-22-	H4-56-22-	<input type="checkbox"/> -0	8.86 (225)	10.20 (259)	≈ 3.06 (4.55)	≈ 2.54 (3.78)	-	
E4-56-23-	H4-56-23-	<input type="checkbox"/> -0	9.33 (237)	10.71 (272)	≈ 3.13 (4.66)	≈ 2.58 (3.84)	-	
E4-56-25-	H4-56-25-	R4-56-25-	9.84 (250)	11.18 (284)	≈ 3.21 (4.77)	≈ 2.61 (3.89)	≈ 4.23 (6.29)	
E4-56-26-	H4-56-26-	<input type="checkbox"/> -0	10.31 (262)	11.69 (297)	≈ 3.27 (4.87)	≈ 2.65 (3.94)	-	
E4-56-27-	H4-56-27-	R4-56-27-	10.83 (275)	12.17 (309)	≈ 3.34 (4.97)	≈ 2.68 (3.99)	≈ 4.47 (6.65)	
E4-56-28-	H4-56-28-	<input type="checkbox"/> -0	11.30 (287)	12.68 (322)	≈ 3.38 (5.03)	≈ 2.70 (4.02)	-	
E4-56-30-	H4-56-30-	R4-56-30-	11.81 (300)	13.15 (334)	≈ 3.48 (5.18)	≈ 2.76 (4.10)	≈ 4.67 (6.95)	
E4-56-31-	H4-56-31-	<input type="checkbox"/> -0	12.28 (312)	13.66 (347)	≈ 3.50 (5.21)	≈ 2.76 (4.11)	-	
E4-56-32-	H4-56-32-	<input type="checkbox"/> -0	12.79 (325)	14.13 (359)	≈ 3.57 (5.32)	≈ 2.80 (4.17)	-	
E4-56-33-	H4-56-33-	<input type="checkbox"/> -0	13.27 (337)	14.65 (372)	≈ 3.66 (5.44)	≈ 2.84 (4.23)	-	
E4-56-35-	H4-56-35-	R4-56-35-	13.78 (350)	15.12 (384)	≈ 3.79 (5.64)	≈ 2.91 (4.33)	≈ 5.14 (7.65)	
E4-56-36-	H4-56-36-	<input type="checkbox"/> -0	14.25 (362)	15.63 (397)	≈ 3.73 (5.55)	≈ 2.88 (4.28)	-	
E4-56-37-	H4-56-37-	<input type="checkbox"/> -0	14.76 (375)	16.10 (409)	≈ 3.80 (5.65)	≈ 2.91 (4.33)	-	
E4-56-38-	H4-56-38-	<input type="checkbox"/> -0	15.24 (387)	16.61 (422)	≈ 3.87 (5.76)	≈ 2.95 (4.39)	-	
E4-56-40-	H4-56-40-	R4-56-40-	15.75 (400)	17.09 (434)	≈ 4.05 (6.03)	≈ 3.04 (4.52)	≈ 5.81 (8.65)	
E4-56-41-	H4-56-41-	<input type="checkbox"/> -0	16.22 (412)	17.60 (447)	≈ 4.00 (5.96)	≈ 3.01 (4.48)	-	
E4-56-42-	H4-56-42-	<input type="checkbox"/> -0	16.73 (425)	18.07 (459)	≈ 4.19 (6.23)	≈ 3.11 (4.63)	-	
E4-56-43-	H4-56-43-	<input type="checkbox"/> -0	17.20 (437)	18.58 (472)	≈ 4.09 (6.09)	≈ 3.06 (4.55)	-	
E4-56-45-	H4-56-45-	<input type="checkbox"/> -0	17.72 (450)	19.06 (484)	≈ 4.31 (6.42)	≈ 3.17 (4.72)	-	
E4-56-46-	H4-56-46-	R4-56-46-	18.19 (462)	19.57 (497)	≈ 4.28 (6.37)	≈ 3.15 (4.69)	≈ 6.13 (9.12)	
E4-56-47-	H4-56-47-	<input type="checkbox"/> -0	18.70 (475)	20.04 (509)	≈ 4.31 (6.41)	≈ 3.16 (4.71)	-	
E4-56-48-	H4-56-48-	<input type="checkbox"/> -0	19.17 (487)	20.55 (522)	≈ 4.48 (6.66)	≈ 3.25 (4.84)	-	
E4-56-50-	H4-56-50-	<input type="checkbox"/> -0	19.69 (500)	21.02 (534)	≈ 4.54 (6.76)	≈ 3.29 (4.89)	-	
E4-56-51-	H4-56-51-	<input type="checkbox"/> -0	20.16 (512)	21.54 (547)	≈ 4.48 (6.67)	≈ 3.25 (4.84)	-	
E4-56-52-	H4-56-52-	<input type="checkbox"/> -0	20.67 (525)	22.01 (559)	≈ 4.60 (6.84)	≈ 3.31 (4.93)	-	
E4-56-53-	H4-56-53-	<input type="checkbox"/> -0	21.14 (537)	22.52 (572)	≈ 4.66 (6.93)	≈ 3.34 (4.97)	-	
E4-56-55-	H4-56-55-	<input type="checkbox"/> -0	21.65 (550)	22.99 (584)	≈ 4.95 (7.36)	≈ 3.48 (5.18)	-	
E4-56-60-	H4-56-60-	<input type="checkbox"/> -0	23.62 (600)	24.96 (634)	≈ 5.09 (7.58)	≈ 3.56 (5.30)	-	

Choose from the radii below for all of the above sizes

Radius (mm) Example: E4-56-30--0

	135**	150	175	200	240	250	300	350	400	450	500
<i>R</i>	5.31 (135)	5.91 (150)	6.89 (175)	7.87 (200)	9.45 (240)	9.84 (250)	11.81 (300)	13.78 (350)	15.75 (400)	17.72 (450)	19.68 (500)
<i>H</i> ²⁵	13.94 (354)	15.12 (384)	17.09 (434)	19.06 (484)	22.20 (564)	22.99 (584)	26.93 (684)	30.87 (784)	34.80 (884)	38.74 (984)	42.68 (1084)
<i>D</i>	12.36 (314)	12.95 (329)	13.94 (354)	14.92 (379)	16.50 (419)	16.89 (429)	18.86 (479)	20.83 (529)	22.79 (579)	24.76 (629)	26.73 (679)
<i>K</i>	24.02 (610)	25.79 (655)	28.94 (735)	32.09 (815)	37.01 (940)	38.19 (970)	44.29 (1125)	50.59 (1285)	56.69 (1440)	62.99 (1600)	69.09 (1755)

** This radius is not available for the R4-56 Series

*Removable lid only, no hinged option

0 = Standard color black. For other colors see Chapter 1

For wider chains see page 6.69 For large diameter hoses see page 6.69

PDF: igus.com/e-chain-pdfs
Product information: igus.com/e-chains



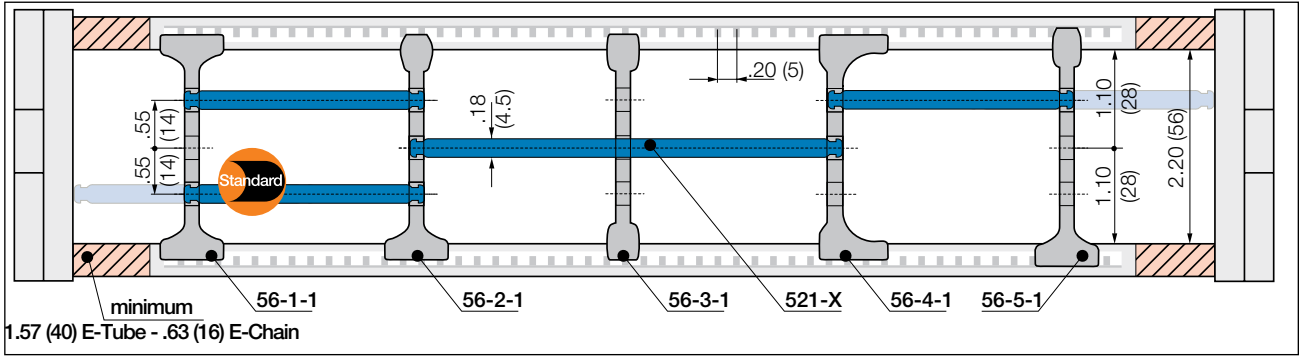

1.57 (40) E-Tube - .63 (16) E-Chain

Note Please maintain a lateral spacing of 1.57" (40 mm) for e-tube and .63" (16 mm) for e-chains® between the separators and the side links. In the standard configuration separators are assembled every 2nd e-chain® link

		Separator, wide base Unassembled Part No. 56-1 Assembled Part No. 56-1-1
		Separator, narrow head Unassembled Part No. 56-2 Assembled Part No. 56-2-1
		Separator, narrow base Unassembled Part No. 56-3 Assembled Part No. 56-3-1
		Separator, asymmetrical Unassembled Part No. 56-4 Assembled Part No. 56-4-1
		Separator, asymmetrical Unassembled Part No. 56-5 Assembled Part No. 56-5-1

- **Standard separator 56-1 for all applications**
Separator with wide base for maximum locking strength and safe standing in e-chains®.
- **Separator 56-2 For even faster installation**
is used when vertical and horizontal separation is required. Due to its slot, it allows basic vertical/horizontal shelving arrangements.
- **Separator 56-3 For many thin cables**
is used when vertical and horizontal separation is required. Due to its slot, it allows basic vertical/horizontal shelving arrangements.
- **Separator 56-4 For side mounted applications**
is used when vertical and horizontal separation is required. Due to its slot, it allows basic vertical/horizontal shelving arrangements.
- **Separator 56-5 Locks safely in .30" (7.5 mm) increments**
Notch separator for exact positioning in e-chains®, Recommended for side-mounted applications.

Lockable full-width shelves - for the standard interior separation

		Full width shelf, lockable Unassembled Part No. 520-X Assembled Part No. 521-X
--	--	---

- **Full width shelf, lockable**
Shelf locks safely into separators on both ends, fixed width possible. Separators can be moved freely over the shelf in horizontal direction. Can be arranged at 3 different heights.

Width X in. (mm)	Part No. Unassembled	Part No. Assembled	Width X in. (mm)	Part No. Unassembled	Part No. Assembled	Width X in. (mm)	Part No. Unassembled	Part No. Assembled
1.97 (050)	520-50	521-50	5.91 (150)	520-125	521-125	11.81 (300)	520-125	521-125
2.56 (065)	520-65	521-65	6.89 (175)	520-125	521-125	13.78 (350)	520-125	521-125
2.95 (075)	520-75	521-75	7.87 (200)	520-125	521-125	14.76 (375)	520-125	521-125
3.94 (100)	520-100	521-100	8.86 (225)	520-125	521-125	15.24 (387)	520-125	521-125
4.92 (125)	520-125	521-125	9.84 (250)	520-125	521-125	17.723 (450)	520-125	521-125

e-chain system® E4-1
 Series E4-56/H4-56/R4-56
 Interior Separation - New Generation



E4-56
 H4-56
 R4-56

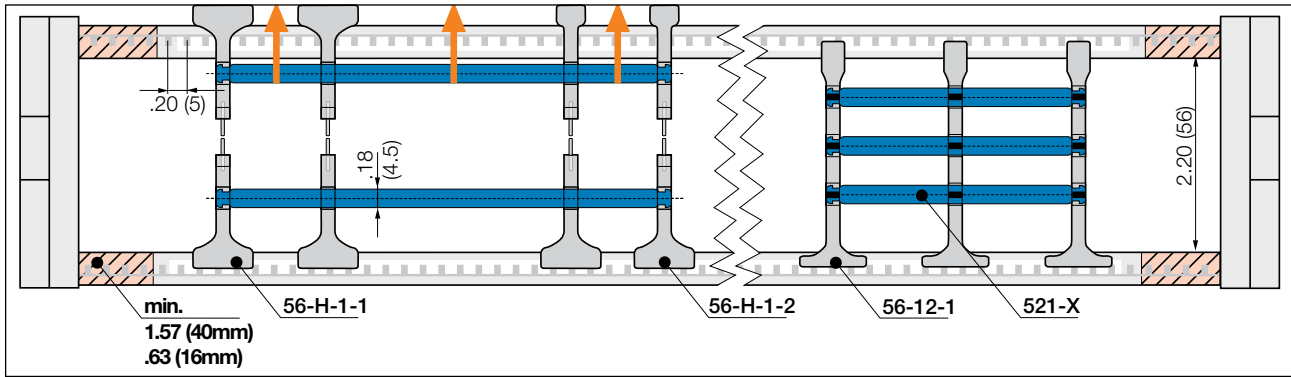

Note Please maintain a lateral spacing of 1.57" (40 mm) for e-tube and .63" (16 mm) for e-chains® between the separators and the side links. In the standard configuration separators are assembled every 2nd e-chain® link

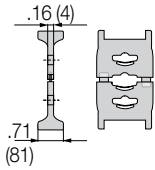

Separator, wide base

Unassembled **Part No. 56-H-1**
 Assembled **Part No. 56-H-1-1**

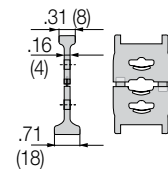
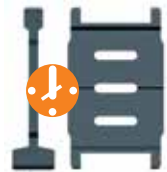

Separator, narrow head

Unassembled **Part No. 56-H-2**
 Assembled **Part No. 56-H-2-1**

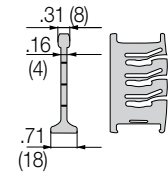

Lean separator

Unassembled **Part No. 56-12**
 Assembled **Part No. 56-12-1**

• **Split separators for all applications**

In order to fill e-chains® more easily and effectively, these separators can be split in the middle. This allows easier access to middle shelf partitions. Fast assembly and easy retrofit. 2 types available: with wide or narrow top.

• **Lean separators 56-12**

New design allows extremely fast fitting of shelves in several layers, which significantly reduces assembly time. Enables extremely fast replacement of individual cables in a very full e-chain®.

• **Lean separator design - several layers of cables fitted quickly, save up to 50%* assembly time**

(*Lean separator vs. standard separator - measured on a 4m long e-chain® fitted with 12 cables in the igus® harnessing factory)



PDF: igus.com/e-chain-pdfs
 Product information: igus.com/e-chains





Shelves and separators

e-chains® and e-tubes can be subdivided both vertically and horizontally using the various interior separation elements.

► Design, Chapter 1 for layout recommendations.

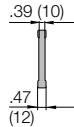
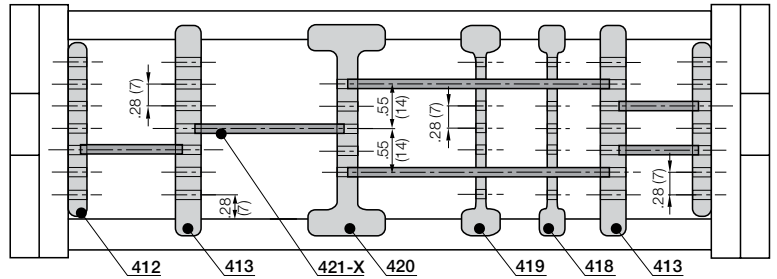

Split separator (chain only)

Unassembled	Part No. T563
Assembled	Part No. T563M

- **Split separator T563 for e-chains®**
This separator is ideal for subsequent shelving or the initial assembly of the e-chain. Fast assembly and disassembly using a hinge/push mechanism. Enhances flexibility

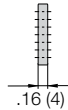

Side plate

Unassembled	Part No. 402
Assembled	Part No. 412

- **Side plates 402**
This component is used to form the basic pattern of a shelf system.

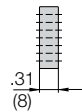

Vertical separator

Unassembled	Part No. 403
Assembled	Part No. 413

- **Vertical separator 403**
This component is used to form the basic pattern of a shelf system.

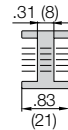

Locking vertical separator

Unassembled	Part No. 410
Assembled	Part No. 420

- **Locking vertical separator 410**
This separator is slotted and able to be combined with shelves. For e-chains® only

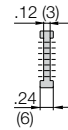
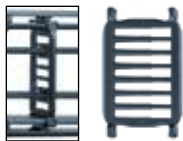

Slotted separators, closed

Unassembled	Part No. 408
Assembled	Part No. 418

- **Slotted separators 408**
These are used for very complex subdivisions. However, they cannot be retrofitted into an existing separation system without removing the shelves first.

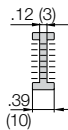

Slotted separators, open

Unassembled	Part No. 409
Assembled	Part No. 419

- **Slotted separator 409**
This separator can be retrofitted into an existing interior separation system without removing the shelves, as long as these shelves fit into any of the 3 middle slots

Shelves 420-XX

These components form the basic pattern of a shelf system. Shelves of various widths can be arranged at 7 different heights in .28" (7mm) increments

Width X in. (mm)	Usable Width in. (mm)	Part No. Unassembled	Part No. Assembled	Width X in. (mm)	Usable Width in. (mm)	Part No. Unassembled	Part No. Assembled
.71 (18)	.39 (10)	420-18	421-18	2.95 (75)	2.64 (67)	420-75	421-75
.91 (23)	.59 (15)	420-23	421-23	3.46 (88)	3.15 (80)	420-88	421-88
.98 (25)	.67 (17)	420-25	421-25	3.94 (100)	3.62 (92)	420-100	421-100
1.10 (28)	.79 (20)	420-28	421-28	4.92 (125)	4.61(117)	420-125	421-125
1.30 (33)	.98 (25)	420-33	421-33	5.91 (150)	5.59(142)	420-150	421-150
1.69 (43)	1.38 (35)	420-43	421-43	6.89 (175)	6.57(167)	420-175	421-175
1.97 (50)	1.65 (42)	420-50	421-50	7.36 (187)	7.05(179)	420-187	421-187
2.44 (62)	2.13 (54)	420-62	421-62	7.87 (200)	7.56(192)	420-200	421-200

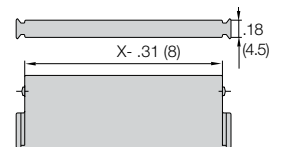

e-chain system® E4-1

Series E4-56/H4-56/R4-56

Interior Separation - Previous Generation



E4-56
H4-56
R4-56



Vertical separators and spacers

Vertical separators are used if a vertical subdivision of the e-chain® interior is required. In standard configuration, a separator is installed every second chain link.

NOTE: Observe a lateral spacing of at least 1.26 in. (32mm) for e-tubes and .63 in. (16mm) for e-chain®. There is no minimum spacing needed for side plates

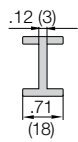
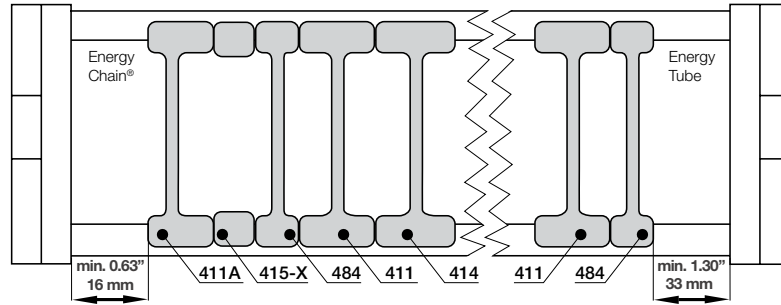

Vertical separator

Unassembled	Part No. 401
Assembled	Part No. 411

- **Standard separator 401 for e-chains® and e-tubes**
This separator offers safe stability due to its wide base design.

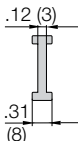

Vertical separator

Unassembled	Part No. 483
Assembled	Part No. 484

- **Vertical separator 483 for e-chains® and e-tubes**
This separator offers a narrow base for applications where a large number of small cables need to be individually separated.

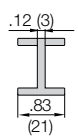

Locking separator (chain only)

Unassembled	Part No. 404
Assembled	Part No. 414

- **Locking separator 404 for e-chains®**
This separator features increased retention force for applications exposed to very high humidity and extreme loads. The extra retention force is achieved by asymmetric claws for the crossbar. Take care to ensure proper alignment.

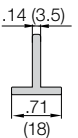

Locking separator (tube only)

Unassembled	Part No. 406
Assembled	Part No. 416

- **Locking separator 406 for e-tubes**
It features a single sided, secure fit, and can be placed on the lid or the bottom of the e-tube. The single side locking design helps to eliminate difficulties in assembling the opposite cover or crossbar

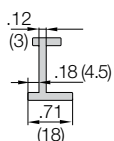

Asymmetrical separator (chain only)

Unassembled	Part No. 401A
Assembled	Part No. 411A

- **Asymmetrical separator 401A for e-chains®**
This separator features an .71" (18mm) base. It can be used in combinations between spacers of different widths and vertical separators in side mounted applications.



Spacer (chain only)

Unassembled	Part No. 405-XX
Assembled	Part No. 415-XX

XX = width of the spacer

- **NOTE ON SPACERS**
Vertical separators are adjustable, but can be fixed in position by means of a spacer. Spacers are most often necessary for side mounted applications.
The available inner height is reduced by .08" (2mm) **per spacer** (for example if one spacer is placed on either side of the separator, the overall inner height is reduced by .16" (4mm). To avoid this, place the spacers on the **outside** of the opening crossbar (**not for long travels**).

Spacers available in the following sizes:

Part No. Unassembled	Part No. Assembled	in.	(mm)	Part No. Unassembled	Part No. Assembled	in.	(mm)
405 -10	415 -10	.39"	(10)	405 -30	415 -30	1.18"	(30)
405 -15	415 -15	.59"	(15)	405 -40	415 -40	1.57"	(40)
405 -20	415 -20	.79"	(20)				

PDF: igus.com/e-chain-pdfs
Product information: igus.com/e-chains



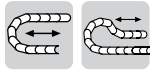

Option 1: pivoting

Standard

- Recommended for unsupported and gliding applications
- Attachment capability on all sides
- Bolted connection outside of chain cross-section
- Space restricted conditions
- Corrosion resistant

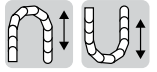

Option 2: locking

- Profile rail option
- Universal use
- Corrosion resistant
- Vertical hanging/standing travels
- Extreme accelerations

Part Number Structure

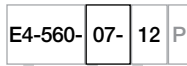

- With Profile Rail
- Complete Set
- Width
- E4-560 = Pivoting
- E4-561 = Locking

Due to the design of the E4-56 series chains, please note the following when ordering brackets:
Even number of links = full set, part number ending in -12
Odd number of links = 2 pieces, part number ending in -1

Moving end
E4-560...1

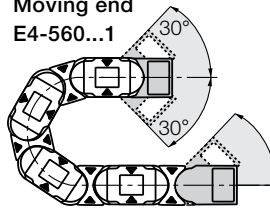

Fixed end
E4-560...2

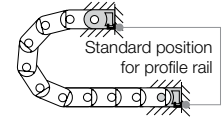

Moving end
E4-561...1

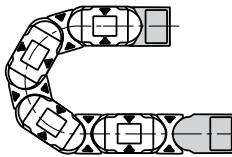

Fixed end
E4-561...2

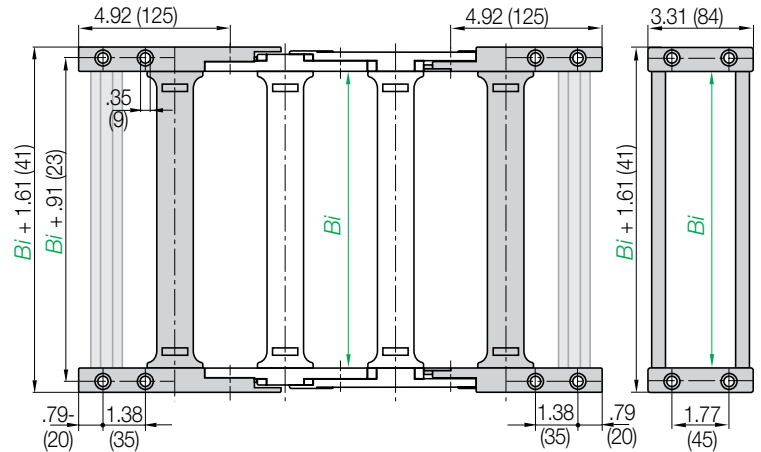
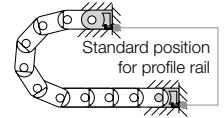

Part No. Full Set (pivoting)
Series E4-56 or H4-56
E4-560-Width-12

Part No. Full Set (pivoting)
with profile rail
Series E4-56 or H4-56
E4-560-Width-12P

Part number examples are shown for pivoting brackets for e-chain. For locking brackets change part number to 561

idth	Part No. Full Set chain		With Profile Rail	Bi in. (mm)
	Pivoting	Locking		
-05*	E4-560	E4-561	-05-12 P	1.97 (50)
-055	E4-560	E4-561	-055-12 P	2.17 (55)
-06	E4-560	E4-561	-06-12 P	2.56 (65)
-07	E4-560	E4-561	-07-12 P	2.95 (75)
-08	E4-560	E4-561	-08-12 P	3.43 (87)
-10	E4-560	E4-561	-10-12 P	3.94 (100)
-11	E4-560	E4-561	-11-12 P	4.41 (112)
-12	E4-560	E4-561	-12-12 P	4.92 (125)
-13	E4-560	E4-561	-13-12 P	5.39 (137)
-15	E4-560	E4-561	-15-12 P	5.91 (150)
-16	E4-560	E4-561	-16-12 P	6.38 (162)
-169	E4-560	E4-561	-169-12 P	6.65 (169)
-17	E4-560	E4-561	-17-12 P	6.89 (175)
-182	E4-560	E4-561	-182-12 P	7.17 (182)
-18	E4-560	E4-561	-18-12 P	7.36 (187)
-20	E4-560	E4-561	-20-12 P	7.87 (200)
-207	E4-560	E4-561	-207-12 P	8.15 (207)
-21	E4-560	E4-561	-21-12 P	8.35 (212)
-22	E4-560	E4-561	-22-12 P	8.86 (225)
-23	E4-560	E4-561	-23-12 P	9.33 (237)
-25	E4-560	E4-561	-25-12 P	9.84 (250)
-26	E4-560	E4-561	-26-12 P	10.31 (262)
-27	E4-560	E4-561	-27-12 P	10.83 (275)

Width	Part No. Full Set chain		With Profile Rail	Bi in. (mm)
	Pivoting	Locking		
-28	E4-560	E4-561	-28-12 P	11.30 (287)
-30	E4-560	E4-561	-30-12 P	11.81 (300)
-31	E4-560	E4-561	-31-12 P	12.28 (312)
-32	E4-560	E4-561	-32-12 P	12.79 (325)
-33	E4-560	E4-561	-33-12 P	13.27 (337)
-35	E4-560	E4-561	-35-12 P	13.78 (350)
-36	E4-560	E4-561	-36-12 P	14.25 (362)
-37	E4-560	E4-561	-37-12 P	14.76 (375)
-38	E4-560	E4-561	-38-12 P	15.24 (387)
-40	E4-560	E4-561	-40-12 P	15.75 (400)
-41	E4-560	E4-561	-41-12 P	16.22 (412)
-42	E4-560	E4-561	-42-12 P	16.73 (425)
-43	E4-560	E4-561	-43-12 P	17.20 (437)
-45	E4-560	E4-561	-45-12 P	17.72 (450)
-46	E4-560	E4-561	-46-12 P	18.19 (462)
-47	E4-560	E4-561	-47-12 P	18.70 (475)
-48	E4-560	E4-561	-48-12 P	19.17 (487)
-50	E4-560	E4-561	-50-12 P	19.69 (500)
-51	E4-560	E4-561	-51-12 P	20.16 (512)
-52	E4-560	E4-561	-52-12 P	20.67 (525)
-53	E4-560	E4-561	-53-12 P	21.14 (537)
-55	E4-560	E4-561	-55-12 P	21.65 (550)
-60	E4-560	E4-561	-60-12 P	23.62 (600)

e-chain system® E4-1

Series E4-56/H4-56/R4-56

Mounting Brackets



E4-56
H4-56
R4-56

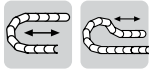

Option 1: pivoting



- Recommended for unsupported and gliding applications
- Attachment capability on all sides
- Bolted connection outside of chain cross-section
- Space restricted conditions
- Corrosion resistant

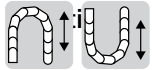

locking

- Profile rail option
- Universal use
- Corrosion resistant
- Vertical hanging/standing travels
- Extreme accelerations

Moving end
E4-560...1

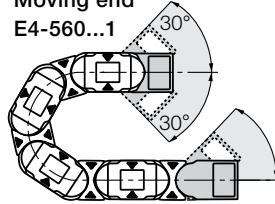

Fixed end
E4-560...2

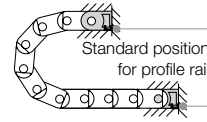

Moving end
E4-561...1

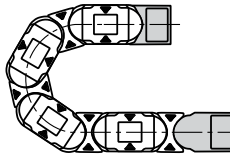

Fixed end
E4-561...2

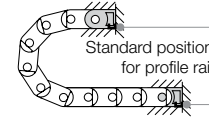

Part Number Structure

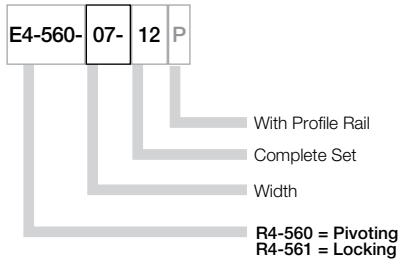

Due to the design of the E4-56 series chains, please note the following when ordering brackets:
Even number of links = full set, part number ending in -12
Odd number of links = 2 pieces, part number ending in -1

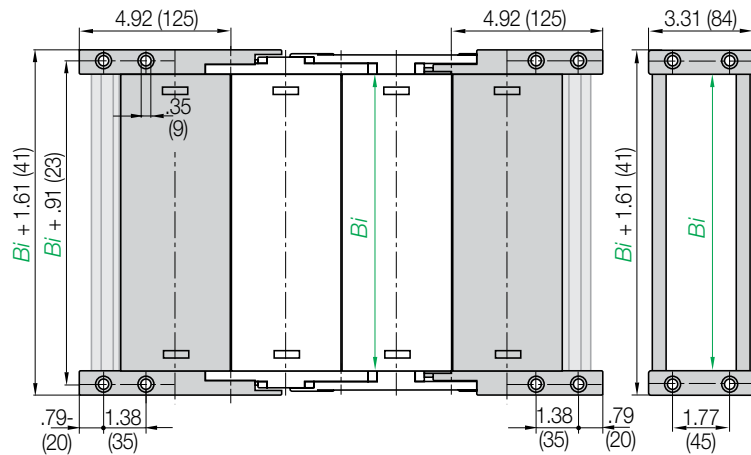

Part No. Full Set (pivoting)

Tube Series R4-56

R4-560-Width-12

Part No. Full Set (pivoting)

with Profile Rail

Tube Series R4-56

R4-560-Width-12P

Part number examples are shown for pivoting brackets for e-chain. For locking brackets change part number to 561

Width	Part No. Full Set tube		With Profile Rail	<i>Bi</i> in. (mm)	Part No. Full Set tube		With Profile Rail	<i>Bi</i> in. (mm)			
	Pivoting	Locking			Pivoting	Locking					
-07	R4-560	R4-561	-07-12		2.95 (75)	-25	ER4-560	R4-561	-25-12		9.84 (250)
-10	R4-560	R4-561	-10-12		3.94 (100)	-27	R4-560	R4-561	-27-12		10.83 (275)
-12	R4-560	R4-561	-12-12		4.92 (125)	-30	R4-560	R4-561	-30-12		11.81 (300)
-15	R4-560	R4-561	-15-12		5.91 (150)	-35	R4-560	R4-561	-35-12		13.78 (350)
-17	R4-560	R4-561	-17-12		6.89 (175)	-40	R4-560	R4-561	-40-12		15.75 (400)
-20	R4-560	R4-561	-20-12		7.87 (200)	-46	R4-560	ER4-561	-46-12		18.19 (462)

PDF: igus.com/e-chain-pdfs
Product information: igus.com/e-chains



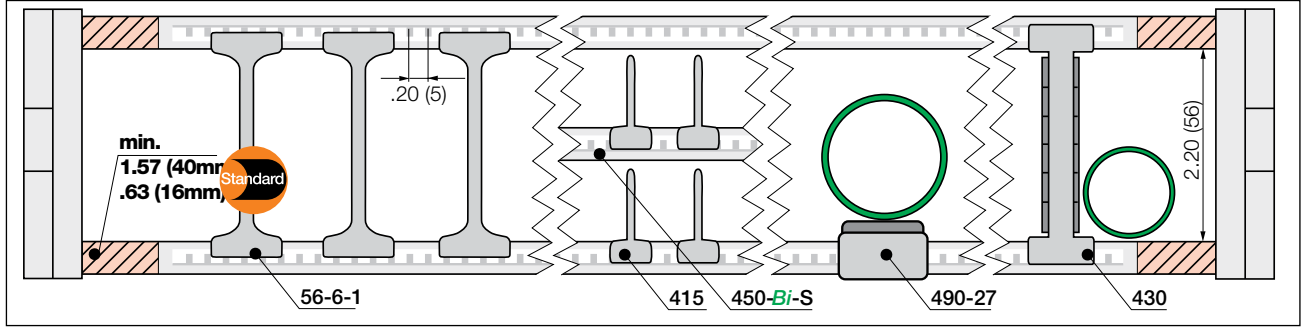

Note Please maintain a lateral spacing of 1.57" (40 mm) for e-tube and .63" (16 mm) for e-chains® between the separators and the side links. In the standard configuration separators are assembled every 2nd e-chain® link

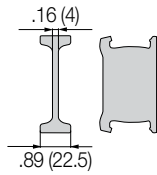

Notch locking separator

Unassembled	Part No. 56-6
Assembled	Part No. 56-6-1

● **Notch locking separator for increased holding force**

Notch locking separators offer higher crossbar opening forces for high humidity and/or large hydraulic hoses. They can be positioned precisely and then locked in position.

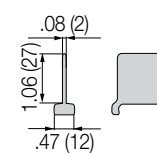

Partial height separator

Unassembled	Part No. 405
Assembled	Part No. 415

● **Partial height separator***

In conjunction with an additional opening crossbar, **part no. 450-Bi-S**, it provides the option to separate the upper and lower halves of the e-chain® independently of each other.

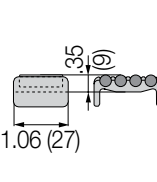

Rollclip* for e-chains®

Unassembled	Part No. 489-27
Assembled	Part No. 490-27

● **Rollclip***

Minimizes abrasion of sensitive hoses. Simply clamps onto the opening crossbar. The movable rollers compensate for relative movement between the e-chain® and hose.

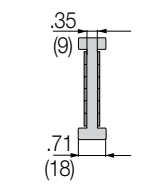

Roller separator for e-chains®

Unassembled	Part No. 429
Assembled	Part No. 430

● **Roller separator***

The roller separator is used in a similar way to the rollclip. It is used like a separator. For rigid cables and hoses.

*Only for e-chains®

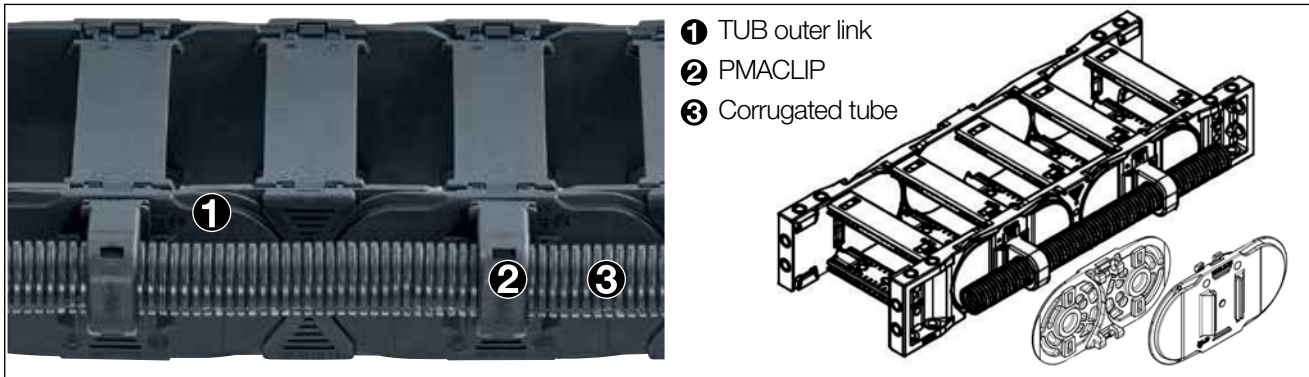

TUB | Safe guidance for corrugated tubes parallel to the e-chain®

- Additional, simple guidance for corrugated tubes on the outside of the e-chain®
- PMACLIP allows corrugated tubes with nominal widths .28 (07mm), .39 (10mm), .47 (12mm), .67 (17mm) to be easily clipped on
- Easy access to the corrugated tubes, fast replacement of the hoses
- Reduce assembly time and cost - easy to assemble, without any additional screws or tools
- The part number includes the e-chain® with TUB side sections; the PMACLIP support and the hose are ordered separately

Part No. TUB	Part No. TUB	Part No. TUB	For corrugated tube nominal diameter
Outer link right*	Outer link left*	Outer link at both ends*	Ø [mm]
E4-56-XXXTUBR-R-0	E4-56-XXXTUBL-L-R-0	E4-56-XXXTUB-R-0	.28 (07), .39 (10), .47 (12), .67 (17)

*View from the fixed end

Part number appended with width index **XXX Bi** and radius (**R**) e.g.

E4-56-100TUBR-150-0 = with TUB outer sections every 2nd right hand link

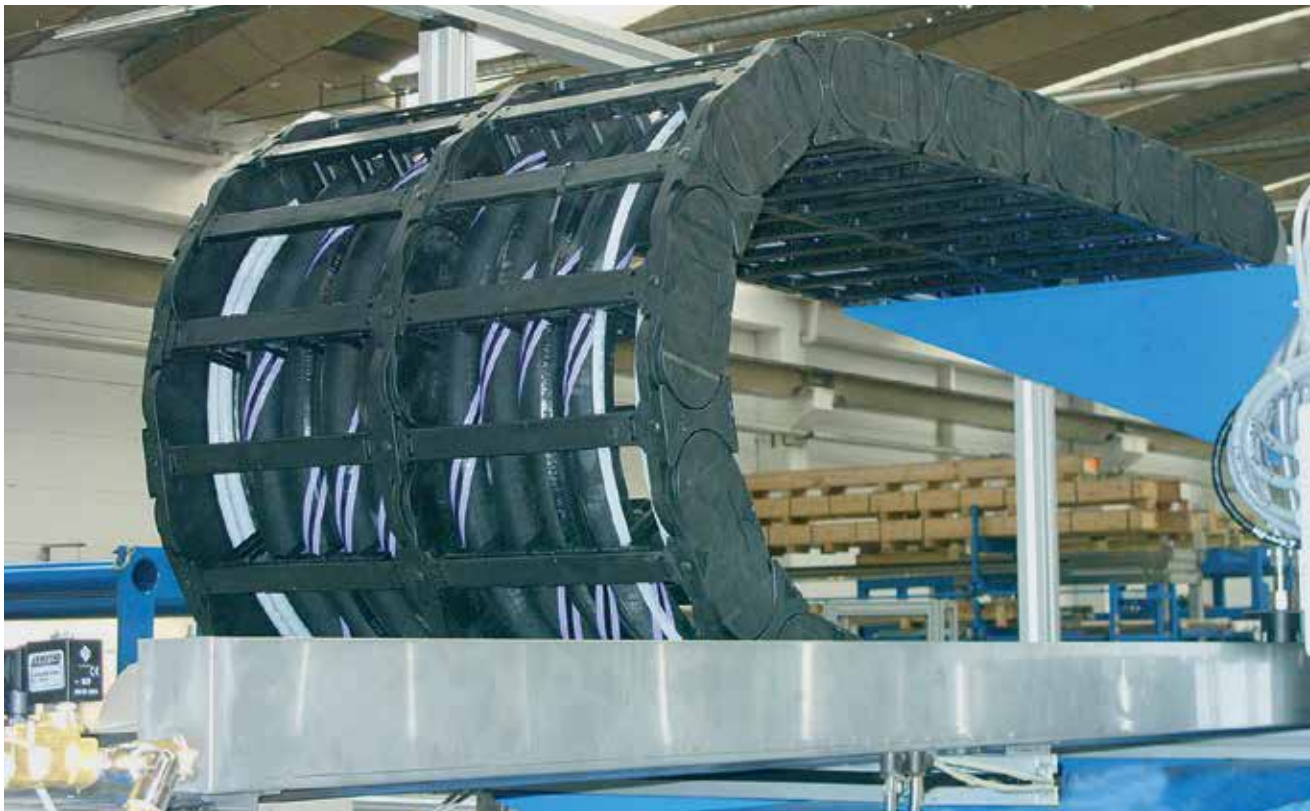

E4-1 as a noise-optimized version with extension links. Unsupported application with high fill weight. Assembled with rigid hydraulic hoses. The max. noise level can be reduced up to 9dB(A) using the optional rubber dampers





Extension links - for extremely wide e-chains® up to 9.84 ft (3m)

- For applications in which particularly high fill weights necessitate extremely wide e-chains®
- The extension link design allows virtually limitless side-by-side attachment of chains
- The unsupported length of a chain can be increased when additional loads are required
- Extension links can be used with e-chains®, e-tubes or a combination of both
- They are suitable for unsupported and gliding applications in a guide trough
- e-chains® with extension links are attached with KMA or steel mounting brackets.

Part number example for e-chain®

E4-56-10/20/10- 200 -0

E4-56-*Bi1/Bi2/Bi3*- R -0

We strongly recommend on-site consultation with an igus® technician for individual advice regarding mounting brackets, guide troughs and other design details.

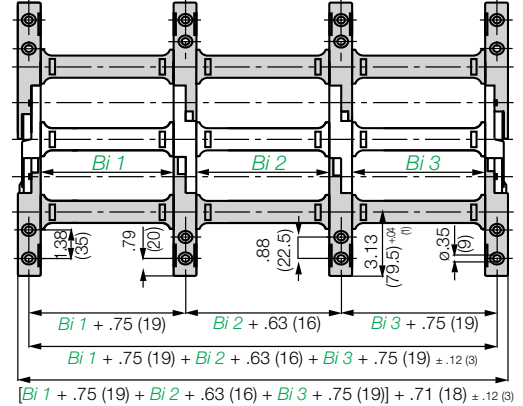

Consult igus® for your extender crossbar applications. We will be happy to assist you with your design layout.

Extender crossbars - For careful guiding of large diameter cables and hoses

- Intended for cables and hoses with a maximum outer diameter of 9.65 in. (245 mm).
- Can be attached along either the inner or outer radius, inner radius preferred
- Gliding operation with crossbars assembled along the outer radius in conjunction with a special guide trough
- Gliding operation not guaranteed with crossbars assembled along the inner radius
- The extender crossbar can either be attached to the side links directly or can be used in combination with two standard snap-open crossbars.

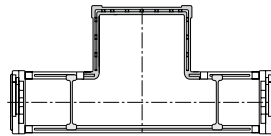

Square extender crossbar combined with standard snap-open crossbars.

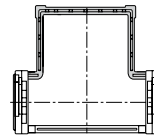

Attached directly to the side link.

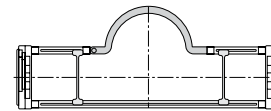

Round extender crossbar combined with standard snap-open crossbars.

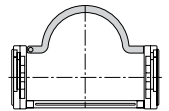

Attached directly to the side link.

Part No.	Max Ø Hose	Style	Installation Side Link	Combined with Snap-Open Crossbars
450-15-RHD115	4.52 (115)	Round	No	Yes
450-17-RD115	4.52 (115)	Round	Yes	No
450-25-D150	5.91 (150)	Square	Yes	No
450-30-D200	7.09 (180)	Square	Yes	No
450-35-D250	7.68 (195)	Square	Yes	No
450-40-D300	9.65 (245)	Square	Yes	No
450-20-HD150	5.91 (150)	Square	No	Yes
450-25-HD200	7.09 (180)	Square	No	Yes
450-30-HD250	7.68 (195)	Square	No	Yes

Chainfix clamps for the profile rail



For more information please refer to strain relief section of Chapter 10.

igus® Chainfix strain relief elements are available in either steel or stainless steel. They can be adjusted with a hexagon socket and are available in single, double and triple configurations.

Part No. Single Clamp		Part No. Double Clamp		Part No. Triple Clamp		Cable ø	
Steel	Stainless	Steel	Stainless	Steel	Stainless	in.	(mm)
CFX12-1	CFX12-1E	CFX12-2	CFX12-2E	CFX12-3	-	.24 - .47	(6 - 12)
CFX14-1	CFX14-1E	CFX14-2	CFX14-2E	CFX14-3	-	.47 - .55	(12 - 14)
CFX16-1	CFX16-1E	CFX16-2	CFX16-2E	CFX16-3	-	.55 - .63	(14 - 16)
CFX18-1	CFX18-1E	CFX18-2	CFX18-2E	CFX18-3	-	.63 - .71	(16 - 18)
CFX20-1	CFX20-1E	CFX20-2	CFX20-2E	CFX20-3	-	.71 - .79	(18 - 20)
CFX22-1	CFX22-1E	CFX22-2	CFX22-2E	CFX22-3	-	.79 - .87	(20 - 22)
CFX26-1	CFX26-1E	CFX26-2	CFX26-2E	-	-	.87 - 1.02	(22 - 26)
CFX30-1	CFX30-1E	CFX30-2	CFX30-2E	-	-	1.02 - 1.18	(26 - 30)
CFX34-1	CFX34-1E	CFX34-2	CFX34-2E	-	-	1.18 - 1.34	(30 - 34)
CFX38-1	CFX38-1E	-	-	-	-	1.34 - 1.50	(34 - 38)
CFX42-1	CFX42-1E	-	-	-	-	1.50 - 1.65	(38 - 42)

Tiewrap Plates

**Option 1:
Tiewrap plates as an individual part**

Available as an individual component, can be fixed onto a mounting bracket with the use of a profile rail.

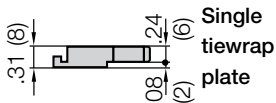
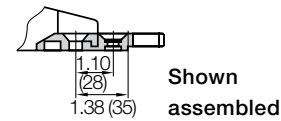

Tiewrap Plate	n Number of Teeth	C Overall Width in. (mm)	B Bore Width in. (mm)	Center Bore
3050-ZB	5	1.97 (50)	1.18 (30)	no
3075-ZB	7	2.95 (75)	2.16 (55)	no
3100-ZB	10	3.94 (100)	3.15 (80)	no
3115-ZB	11	4.53 (115)	3.74 (95)	no
3125-ZB	12	4.92 (125)	4.13 (105)	no
3150-ZB	15	5.91 (150)	5.12 (130)	no
3175-ZB	17	6.89 (175)	6.10 (155)	no
3200-ZB	20	7.87 (200)	7.09 (180)	yes
3225-ZB	22	8.86 (225)	8.07 (205)	yes
3250-ZB	25	9.84 (250)	9.06 (230)	yes

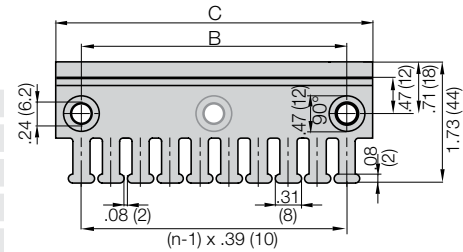

If used with KMA brackets with profile rail please add "KMA" to the end of the part number.

Example: 3050-ZBKMA

For more information please refer to strain relief section of Chapter 10

**Option 2:
Clip-on Tiewrap plates**

Available as a clip-on tiewrap plate without the use of bolts They are inserted and removed with a screwdriver used as a lever. Clip-on tiewrap plates are also available as an attachment to the opening crossbars.



Part No.	Number of Teeth	Width of Strain Relief in. (mm)
3050-ZC	5	1.97 (50)
3075-ZC	7	2.95 (75)

For more information please refer to strain relief section of Chapter 10.

**Option 3:
Clip-on Tiewrap plates for opening crossbars**

Clip-on tiewrap plates are also available as an attachment to opening crossbars. They can be positioned at any point along the e-chain®.



Part No.	Number of Teeth	Width of Strain Relief in. (mm)
4550-ZS	5	1.89 (48)
4575-ZS	7	2.91 (74)

For more information please refer to strain relief section of Chapter 10



Width of Crossbar
E4-56-05-200-0

	B_{Ri}	
-05	3.50 (89)	*
-06	4.09 (104)	94-50-225
-07	4.49 (114)	94-50-225
-08	5.04 (128)	94-50-250
-10	5.47 (139)	94-50-250
-11	5.98 (152)	94-50-275
-12	6.46 (164)	94-50-275
-13	6.97 (177)	94-50-300
-15	7.44 (189)	94-50-300
-16	7.95 (202)	94-50-325
-17	8.42 (214)	94-50-325
-18	8.94 (227)	94-50-350
-20	9.41 (239)	94-50-350
-21	9.92 (252)	94-50-375
-22	10.39 (264)	94-50-375
-23	10.91 (277)	94-50-400
-25	11.38 (289)	94-50-400
-26	11.89 (302)	94-50-425
-27	12.36 (314)	94-50-425
-28	12.87 (327)	94-50-450
-30	13.35 (339)	94-50-450
-31	13.86 (352)	94-50-475
-32	14.33 (364)	94-50-475
-33	14.84 (377)	94-50-500
-35	15.31 (389)	94-50-500
-36	15.82 (402)	94-50-525
-37	16.30 (414)	94-50-525
-38	16.81 (427)	94-50-550
-40	17.28 (439)	94-50-550
-41	17.79 (452)	94-50-575
-42	18.27 (464)	94-50-575
-43	18.78 (477)	94-50-600
-45	19.25 (489)	94-50-600
-46	19.76 (502)	94-50-625
-47	20.24 (514)	94-50-625
-48	20.75 (527)	94-50-650
-50	21.22 (539)	94-50-650
-51	21.73 (552)	94-50-675
-52	22.20 (564)	94-50-675
-53	22.72 (577)	94-50-700
-55	23.19 (589)	94-50-700
-60	25.16 (639)	94-50-750

Installation
Part No.

Guide troughs are used with applications where the upper run of the e-chain® glides on the lower run. If using igus® steel guide troughs, the following components are required.

- Full travel length of guide trough
Part No. 94-30
- 1/2 travel length glide bars
Part No. 93-01
- Installation sets as end connectors
Part No. 94-50-XX

.XX indicates the length of the profile rails on which the guide trough is mounted. The values and part numbers are specified in the table on the left. The standard length of the trough components and glide bars is 6.56 ft (2m). The required overall length of the guide trough directly correlates to the length of travel.

Example:

Length of travel 164 ft (50 m)
Center mounted

Required guide troughs:

164 ft (50 m) guide trough
82 ft (25 m) glide bars
= 25 sections of 6.56 ft (2 m) guide trough
Part No. 94-30
= 13 sections of 6.56 ft (2 m) glide bars

Part No. 93-01

Required number of installation sets:

= Number of guide trough components + 1
= 25 + 1 = 26
Part number of the installation sets
94-50-XXX

Example:

94-50-400 for 15.75 (400 mm) long profile rail

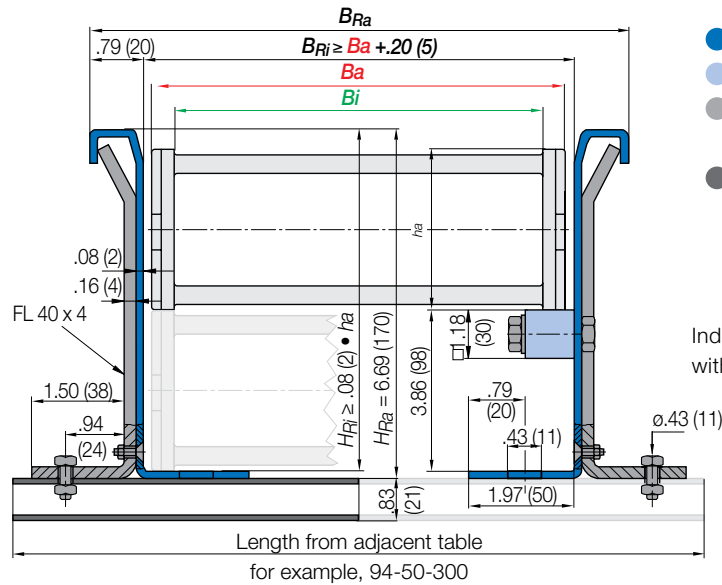

Individual attachment without profile rail

* Specialized guide trough available upon request

Standard length profile rail



Left: Guide trough with glide bars
Right: Guide troughs without glide bars



Installation sets as section connectors

PDF: igus.com/e-chain-pdfs
Product information: igus.com/e-chains



E4-80
H4-80
R4-80



e-chain system® E4-1

Series E4-80/H4-80/R4-80

Price Index



Series E4-80



Series H4-80



Series R4-80

Special Options Available



Low noise version available with special rubber pads



Cleanroom test upon request



ESD classification: Electrically conductive ESD/ATEX version upon request

Assembly Tips



Opening e-chains®: Remove crossbars and clips - Insert screwdriver into the slot, push down, release by lever action



Remove lids/bottoms (e-tubes) - Insert screwdriver into the slot, release by lever action

Other Installation Methods

Vertical, hanging ≤ 394 ft (120 m)

Vertical, standing ≤ 19.69 ft (6 m)

Side-mounted, un_supp. ≤ 9.84 ft (3 m)

Rotary requires further calculation

Usage Guidelines



- If quiet operation is required
- If very high speeds and/or accelerations are required
- Long travels
- High additional loads



- When an extremely low vibration e-chain®/e-tube is required
➤ **Series E6-80**
- When an economic one-sided snap-open e-chain®/e-tube is required
➤ **Series 15050/15150/R19850**

Features & Benefits

- 1 Wide, rounded plastic crossbars - cable friendly
- 2 Low-noise operation through integrated brake in the radial stop dog system
- 3 Hinged snap-open removable lids along the outer radius of the e-tube
- 4 Straight run through inner-/outer-link design
- 5 The tongue and groove design provides greater lateral stability
- 6 QuickLock Crossbar, 450-X-Q, available for faster assembly/disassembly
- 7 New Interior separation kit available
- 8 Crossbars are removable along both radii
- 9 15% more tensile strength (compared to the older E4 series), better unsupported length through improved stop dog system and vertical radial stops
- 10 Version NCST "without camber" simply by turning outer links without unnecessary rework

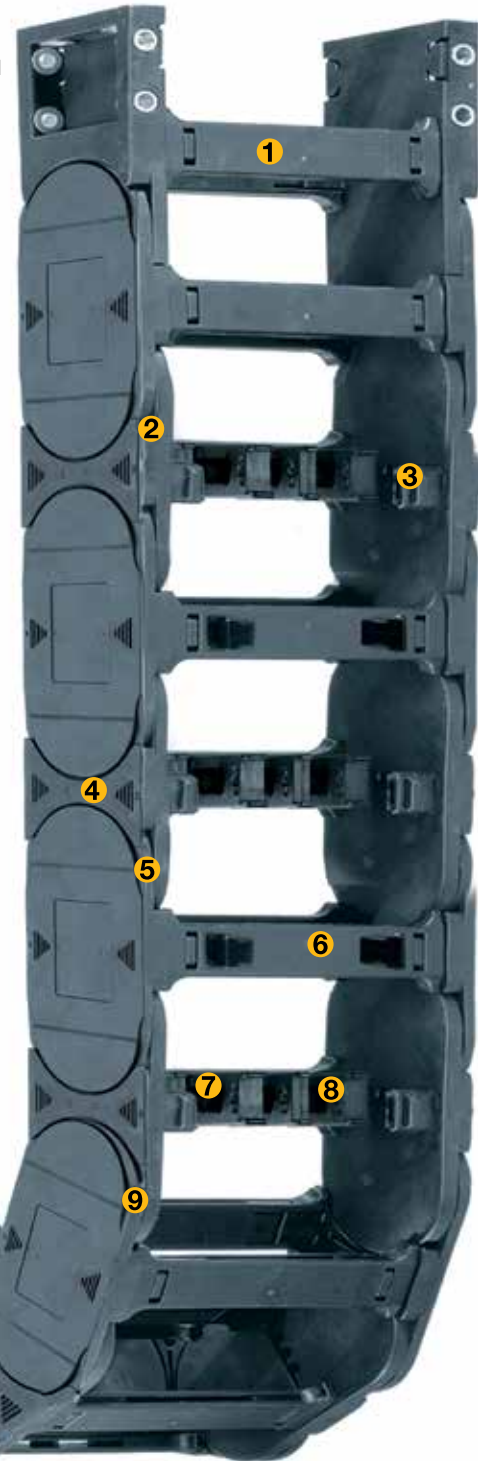

Also available without camber. Add NCST to the end of the part number.
Ex: E4-80-30-300NCST

Order Example: Complete e-chain®

Please indicate chain length or number of links. Example:

16.4 ft (5 m) **E4-80-30-300-0**



e-chain®

With 2 separators **80.1.1** assembled every 2nd link



Interior Separation

1 Set **E4-800-30-12P**



Mounting Bracket

e-chain system® E4-1

Series E4-80/H4-80/R4-80

Installation Dimensions

Short travel, unsupported length

- FL_B = unsupported with permitted sag
 - FL_G = unsupported with straight upper run
- Further information ► Design, Chapter 1

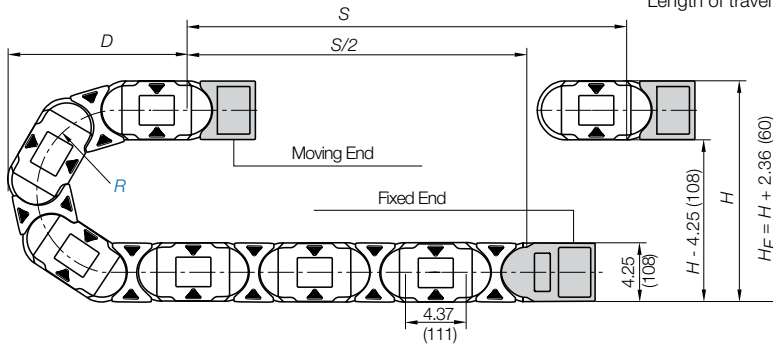
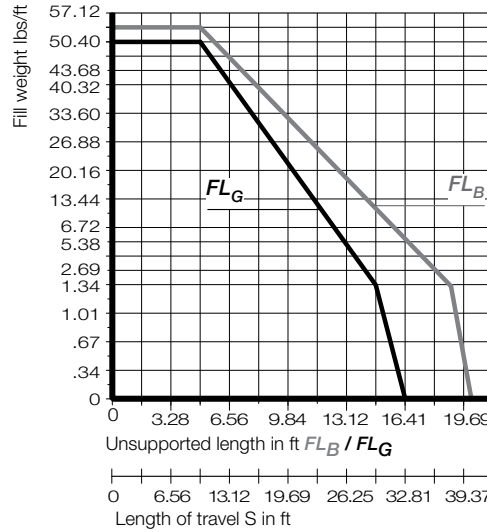
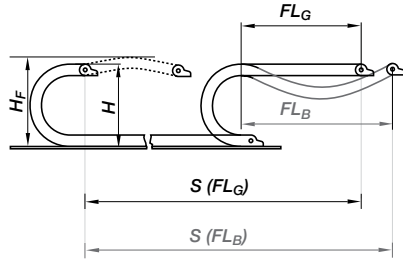

Pitch per link = 4.37" (111 mm)
 Links per ft (m) = 2.75 (9)
 For center mount applications:
 Chain length = $\frac{S}{2} + K$

The required clearance height: $H_F = H + 2.36$ in. (60 mm) (with 2.02 lbs/ft (3 kg/m) fill weight).
 Please consult igus® if space is particularly restricted.

R	5.91 (150)	7.87 (200)	9.84 (250)	11.81 (300)	13.78 (350)	15.75 (400)	19.68 (500)	21.65 (550)	23.62 (600)	39.37 (1000)
H_{+25}^0	16.06 (408)	20.00 (508)	23.94 (608)	27.87 (708)	31.81 (808)	35.75 (908)	43.62 (1108)	47.56 (1208)	51.50 (1308)	82.99 (2108)
D	14.61 (371)	16.57 (421)	18.54 (471)	20.51 (521)	22.48 (571)	24.45 (621)	28.38 (721)	30.35 (771)	32.32 (821)	48.07 (1221)
K	27.36 (695)	33.66 (855)	39.76 (1010)	45.87 (1165)	52.17 (1325)	58.27 (1480)	70.67 (1795)	76.77 (1950)	83.07 (2110)	132.48 (3365)

For long travels with lowered mounting height

Long travel lengths from 32.8 ft.(10m) to max. 1,312 ft. (400m)

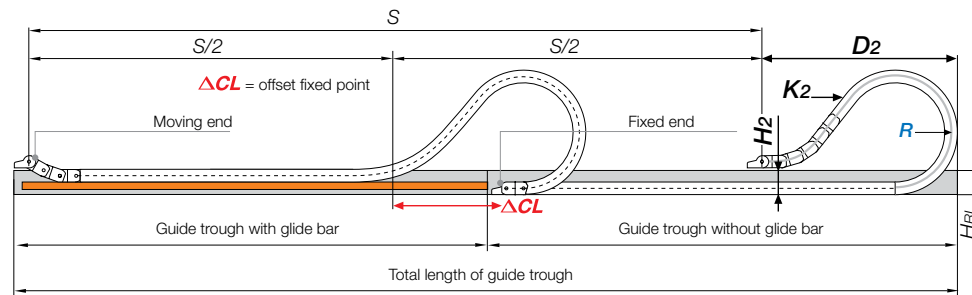

R	5.91 (150)	7.87 (200)	9.84 (250)	11.81 (300)	13.78 (350)	15.75 (400)	19.68 (500)	21.65 (550)	23.62 (600)	39.37 (1000)
H_2	9.53 (242)	9.53 (242)	9.53 (242)	9.53 (242)	9.53 (242)	9.53 (242)	9.53 (242)	-	-	-
D_{+25}	21.65 (550)	31.50 (800)	39.37 (1000)	47.24 (1200)	57.09 (1450)	62.99 (1600)	82.68 (2100)	-	-	-
K_2	35.04 (890)	52.36 (1330)	65.55 (1665)	78.74 (2000)	91.73 (2330)	104.72 (2660)	135.43 (3440)	-	-	-
ΔCL	7.44 (189)	15.61 (389)	21.22 (539)	27.13 (689)	35.00 (889)	38.94 (989)	54.69 (1389)	-	-	-

In case of travels between 13 and 32.8 ft (4 and 10 m) we recommend a longer unsupported length.

For support of the lower run, see Chapter 9 of the main catalog for the Support Tray tool kit



E4-80
H4-80
R4-80

Short Travels - Unsupported

Unsupported e-chains® feature positive camber over short travels. This must be accounted for when specifying the clearance height. Please refer to **Installation dimensions** for further details.

Legend

- S = Length of travel
 - R = Bending radius
 - H = Nominal clearance height
 - D = Overlength e-chain® radius in final position
 - $K = \pi \cdot R + \text{safety buffer}$
 - H_F = Required clearance height
 - H_{Fi} = Trough inner height
 - H_2 = *Mounting height
 - D_2 = Overlength - long travels, gliding
 - K_2 = *Add-on
- *If the mounting bracket location is set lower



PDF: igus.com/e-chain-pdfs
 Product information: igus.com/e-chains

Long Travels - Gliding



If the unsupported length is exceeded, the e-chain®/Tube must glide on itself. This requires a guide trough.

Design, Chapter 1

Technical Data

Speed / acceleration FL_G	max. 65.6 ft/s (20 m/s) / max. 656 ft/s ² (200 m/s ²)
Speed / acceleration FL_B	max. 9.84 ft/s (3 m/s) / max. 19.69 ft/s ² (6 m/s ²)
Gliding speed / acceleration (maximum)	max. 32.8 ft/s (10 m/s) / max. 164 ft/s ² (50 m/s ²)
Material - permitted temperature	igumid G / -40°F (-40°C) up to +248°F (+120°C)
Flammability Class, igumid G	VDE 0304 IIC UL94 HB



Details of material properties
 ► Chapter 1



Series E4-80 - e-chain® with crossbars every link

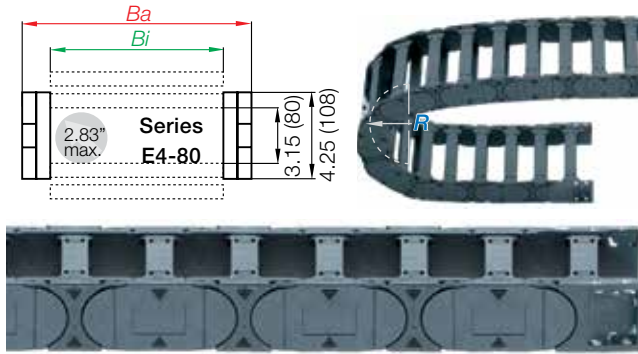

- Crossbars every link
- For use with rigid hydraulic hoses
- For particularly demanding applications
- Can be opened from both sides

Part Number Structure

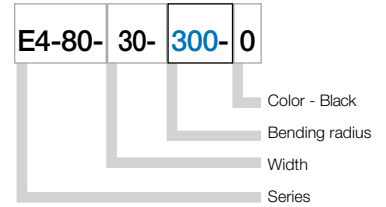

Series H4-80 - e-chain® with crossbars every other link

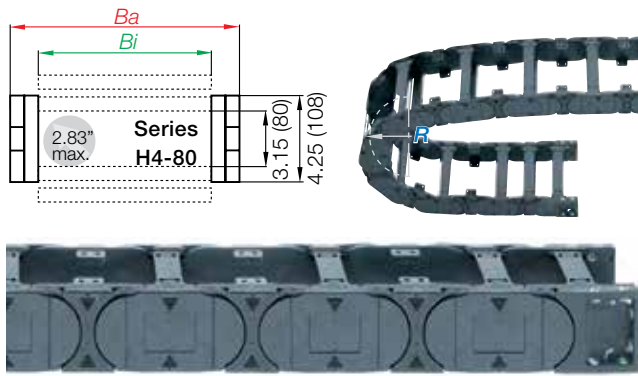

- Crossbars every other link - Standard configuration
- For nearly every situation
- Can be opened from both sides
- Easy assembly
- Stable
- Cost-effective

Part Number Structure

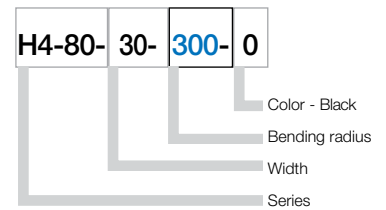

Series R4-80 - fully enclosed e-tube

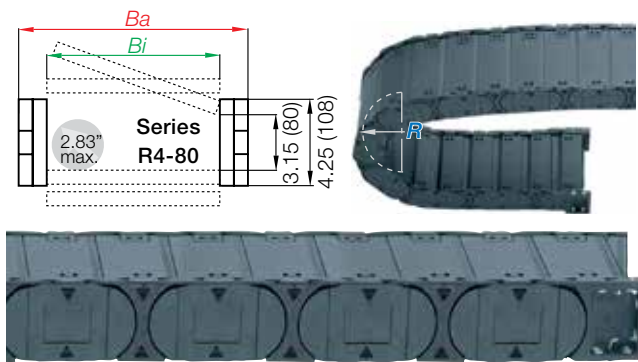

- Fully enclosed
- Excellent cable and hose protection against dirt
- Protection against hot chips
- Lids along inner radius are completely removable
- Lids along the outer radius are single-sided, snap open, hinged on one side as well as completely removable

Part Number Structure

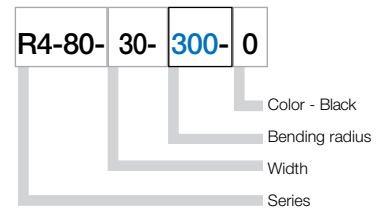

e-chain® as separate parts, links and side plates

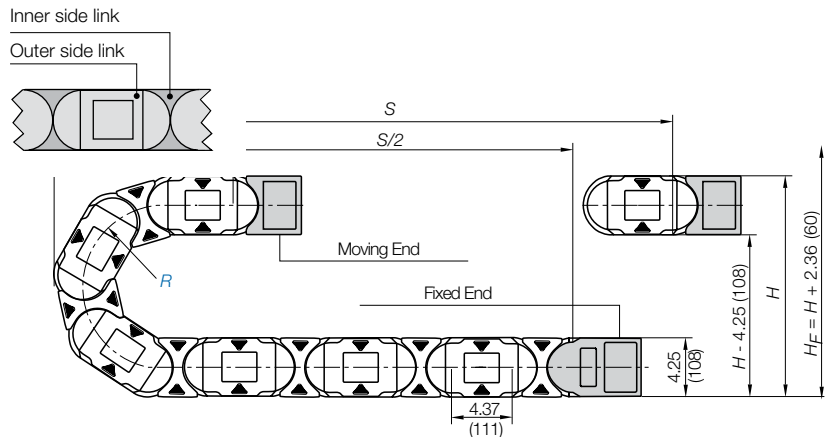
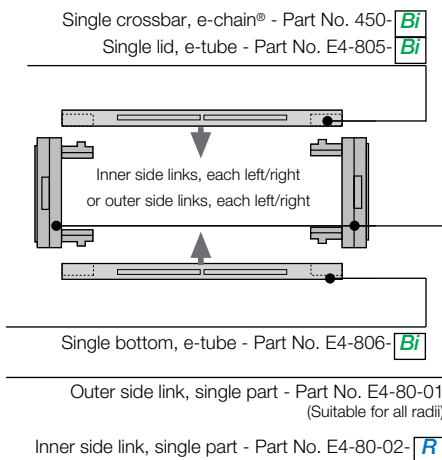

e-chain system® E4-1

Series E4-80/H4-80/R4-80



E4-80
H4-80
R4-80

Supplement part number with required radius. Example: E4-80-30-300-0

Pitch: 4.37 in. (91mm) per link links/ft (m) = 2.75 (9)

Part Number				Weight				
Crossbars	Crossbars	Tube		<i>Bi</i>	<i>Ba</i>	E4-80	H4-80	R4-80
Every link	Every other	Version		in. (mm)	in. (mm)	lbs/ft (kg/m)	lbs/ft (kg/m)	lbs/ft (kg/m)
E4-80-05-	H4-80-05-		<input type="checkbox"/> -0	1.97 (50)	3.94 (100)	≈ 3.59 (5.34)	≈ 3.51 (5.22)	-
E4-80-055-	H4-80-055-		<input type="checkbox"/> -0	2.17 (55)	4.13 (105)	≈ (5.77)	≈ (5.74)	-
E4-80-06-	H4-80-06-		<input type="checkbox"/> -0	2.56 (65)	4.53 (115)	≈ 3.64 (5.41)	≈ 3.53 (5.26)	-
E4-80-07-	H4-80-07-	R4-80-07-	<input type="checkbox"/> -0	2.95 (75)	4.92 (125)	≈ 3.68 (5.47)	≈ 3.55 (5.29)	-
E4-80-08-	H4-80-08-		<input type="checkbox"/> -0	3.43 (87)	5.39 (137)	≈ 3.74 (5.56)	≈ 3.57 (5.32)	-
E4-80-10-	H4-80-10-	R4-80-10-	<input type="checkbox"/> -0	3.94 (100)	5.91 (150)	≈ 3.77 (5.61)	≈ 3.60 (5.36)	≈ 4.50 (6.70)
E4-80-11-	H4-80-11-		<input type="checkbox"/> -0	4.41 (112)	6.42 (163)	≈ 3.84 (5.71)	≈ 3.63 (5.40)	-
E4-80-12-	H4-80-12-	R4-80-12-	<input type="checkbox"/> -0	4.92 (125)	6.89 (175)	≈ 3.88 (5.77)	≈ 3.66 (5.44)	-
E4-80-13-	H4-80-13-		<input type="checkbox"/> -0	5.39 (137)	7.40 (188)	≈ 3.95 (5.88)	≈ 3.69 (5.49)	-
E4-80-15-	H4-80-15-	R4-80-15-	<input type="checkbox"/> -0	5.91 (150)	7.87 (200)	≈ 3.97 (5.91)	≈ 3.70 (5.51)	≈ 6.86 (4.52)
E4-80-16-	H4-80-16-		<input type="checkbox"/> -0	6.38 (162)	8.39 (213)	≈ 4.03 (6.00)	≈ 3.73 (5.55)	-
E4-80-169	H4-80-169-		<input type="checkbox"/> -0	6.65 (169)	8.66 (220)	≈ 4.34 (6.46)	≈ 4.09 (6.08)	-
E4-80-17-	H4-80-17-	R4-80-17-	<input type="checkbox"/> -0	6.89 (175)	8.86 (225)	≈ 2.76 (6.11)	≈ 3.77 (5.61)	-
E4-80-182	H4-80-182-		<input type="checkbox"/> -0	7.17 (182)	9.17 (233)	≈ 4.39 (6.54)	≈ 4.11 (6.12)	-
E4-80-18-	H4-80-18-		<input type="checkbox"/> -0	7.36 (187)	9.37 (238)	≈ 4.17 (6.20)	≈ 3.80 (5.65)	-
E4-80-20-	H4-80-20-	R4-80-20-	<input type="checkbox"/> -0	7.87 (200)	9.84 (250)	≈ 4.20 (6.25)	≈ 3.82 (5.68)	≈ 6.86 (7.23)
E4-80-207-	H4-80-207-		<input type="checkbox"/> -0	8.15 (207)	10.16 (258)	≈ 4.49 (6.68)	≈ 4.17 (6.20)	-
E4-80-21-	H4-80-21-		<input type="checkbox"/> -0	8.35 (212)	10.35 (263)	≈ 4.23 (6.31)	≈ 3.84 (5.71)	-
E4-80-22-	H4-80-22-		<input type="checkbox"/> -0	8.86 (225)	10.83 (275)	≈ 4.27 (6.36)	≈ 3.85 (5.73)	-
E4-80-23-	H4-80-23-		<input type="checkbox"/> -0	9.33 (237)	11.34 (288)	≈ 4.33 (6.45)	≈ 3.88 (5.78)	-
E4-80-25-	H4-80-25-	R4-80-25-	<input type="checkbox"/> -0	9.84 (250)	11.81 (300)	≈ 4.39 (6.54)	≈ 3.91 (5.82)	≈ 5.42 (8.06)
E4-80-26-	H4-80-26-		<input type="checkbox"/> -0	10.31 (262)	12.32 (313)	≈ 4.45 (6.62)	≈ 3.94 (5.86)	-
E4-80-27-	H4-80-27-	R4-80-27-	<input type="checkbox"/> -0	10.83 (275)	12.80 (325)	≈ 4.50 (6.70)	≈ 3.96 (5.90)	-
E4-80-28-	H4-80-28-		<input type="checkbox"/> -0	11.30 (287)	13.31 (338)	≈ 4.54 (6.75)	≈ 3.98 (5.93)	-
E4-80-30-	H4-80-30-	R4-80-30-	<input type="checkbox"/> -0	11.81 (300)	13.78 (350)	≈ 4.62 (6.87)	≈ 4.03 (5.99)	≈ 5.87 (8.73)
E4-80-31-	H4-80-31-		<input type="checkbox"/> -0	12.28 (312)	14.29 (363)	≈ 4.64 (6.90)	≈ 4.03 (6.00)	-
E4-80-32-	H4-80-32-		<input type="checkbox"/> -0	12.79 (325)	14.76 (375)	≈ 4.70 (6.99)	≈ 4.07 (6.05)	-
E4-80-33-	H4-80-33-		<input type="checkbox"/> -0	13.27 (337)	15.28 (388)	≈ 4.76 (7.09)	≈ 4.10 (6.10)	-
E4-80-35-	H4-80-35-	R4-80-35-	<input type="checkbox"/> -0	13.78 (350)	15.75 (400)	≈ 4.87 (7.25)	≈ 4.15 (6.18)	≈ 6.36 (9.47)
E4-80-36-	H4-80-36-		<input type="checkbox"/> -0	14.25 (362)	16.26 (413)	≈ 4.82 (7.18)	≈ 2.53 (6.14)	-
E4-80-37-	H4-80-37-		<input type="checkbox"/> -0	14.76 (375)	16.73 (425)	≈ 4.88 (7.26)	≈ 4.15 (6.18)	-
E4-80-38-	H4-80-38-		<input type="checkbox"/> -0	15.24 (387)	17.24 (438)	≈ 4.94 (7.35)	≈ 4.19 (6.23)	-
E4-80-40-	H4-80-40-	R4-80-40-	<input type="checkbox"/> -0	15.75 (400)	17.72 (450)	≈ 5.09 (7.57)	≈ 4.26 (6.34)	≈ 6.86 (10.21)
E4-80-41-	H4-80-41-		<input type="checkbox"/> -0	16.22 (412)	18.23 (463)	≈ 5.05 (7.51)	≈ 4.24 (6.31)	-
E4-80-42-	H4-80-42-		<input type="checkbox"/> -0	16.73 (425)	18.70 (475)	≈ 5.21 (7.75)	≈ 4.32 (6.43)	-
E4-80-43-	H4-80-43-		<input type="checkbox"/> -0	17.20 (437)	19.21 (488)	≈ 5.12 (7.62)	≈ 4.27 (6.36)	-
E4-80-45-	H4-80-45-		<input type="checkbox"/> -0	17.72 (450)	19.69 (500)	≈ 5.30 (7.89)	≈ 4.37 (6.50)	-
E4-80-46-	H4-80-46-	R4-80-46-	<input type="checkbox"/> -0	18.19 (462)	20.20 (513)	≈ 5.27 (7.85)	≈ 4.35 (6.48)	≈ 7.36 (10.96)
E4-80-47-	H4-80-47-		<input type="checkbox"/> -0	18.70 (475)	20.67 (525)	≈ 5.29 (7.88)	≈ 4.36 (6.49)	-
E4-80-48-	H4-80-48-		<input type="checkbox"/> -0	19.17 (487)	21.19 (538)	≈ 5.44 (8.09)	≈ (4.43 6.60)	-
E4-80-50-	H4-80-50-		<input type="checkbox"/> -0	19.69 (500)	21.65 (550)	≈ 5.44 (8.09)	≈ 4.43 (6.60)	-
E4-80-51-	H4-80-51-		<input type="checkbox"/> -0	20.16 (512)	22.16 (563)	≈ 5.49 (8.17)	≈ 4.46 (6.63)	-
E4-80-52-	H4-80-52-		<input type="checkbox"/> -0	20.67 (525)	22.64 (575)	≈ 5.54 (8.24)	≈ 4.48 (6.67)	-
E4-80-53-	H4-80-53-		<input type="checkbox"/> -0	21.14 (537)	23.15 (588)	≈ 5.58 (8.31)	≈ 4.51 (6.71)	-
E4-80-55-	H4-80-55-		<input type="checkbox"/> -0	21.65 (550)	23.62 (600)	≈ 5.82 (8.66)	≈ 4.62 (6.88)	-
E4-80-60-	H4-80-60-		<input type="checkbox"/> -0	23.62 (600)	25.59 (650)	≈ 5.94 (8.84)	≈ 4.68 (6.97)	-

Choose from the radii below for all of the above sizes

Radius (mm) Example: E4-80-30-300-0

	150	200	250	300	350	400	500	550	600	1000
<i>R</i>	5.91 (150)	7.87 (200)	9.84 (250)	11.81 (300)	13.78 (350)	15.75 (400)	19.68 (500)	21.65 (550)	23.62 (600)	39.37 (1000)
H_{+25}^0	16.06 (408)	20.00 (508)	23.94 (608)	27.87 (708)	31.81 (808)	35.75 (908)	43.62 (1108)	47.56 (1208)	51.50 (1308)	82.99 (2108)
<i>D</i>	14.61 (371)	16.57 (421)	18.54 (471)	20.51 (521)	22.48 (571)	24.45 (621)	28.38 (721)	30.35 (771)	32.32 (821)	48.07 (1221)
<i>K</i>	27.36 (695)	33.66 (855)	39.76 (1010)	45.87 (1165)	52.17 (1325)	58.27 (1480)	70.67 (1795)	76.77 (1950)	83.07 (2110)	132.48 (3365)

0 = Standard color black. For other colors see Chapter 1

For wider chains see page 6.85 For large diameter hoses see page 6.85

PDF: igus.com/e-chain-pdfs
Product information: igus.com/e-chains



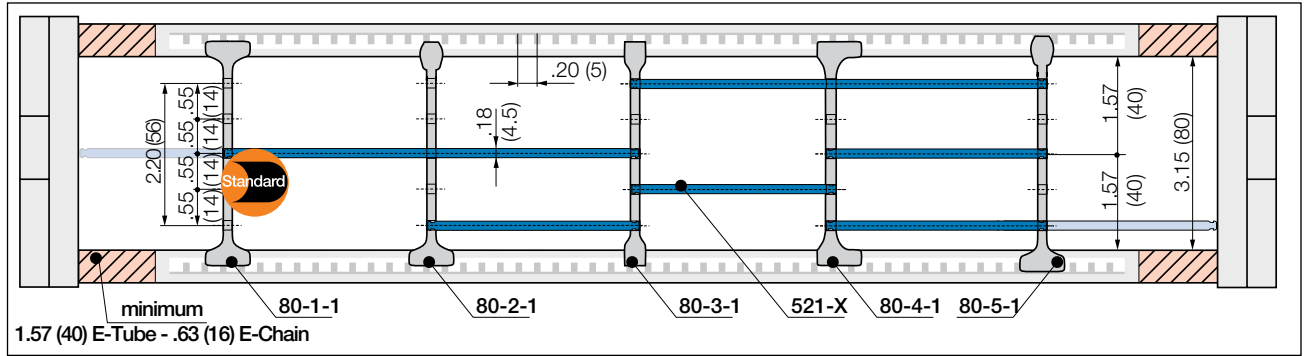

Note Please maintain a lateral spacing of 1.57" (40 mm) for e-tube and .63" (16 mm) for e-chains® between the separators and the side links. In the standard configuration separators are assembled every 2nd e-chain® link

Telephone 1-800-521-2747

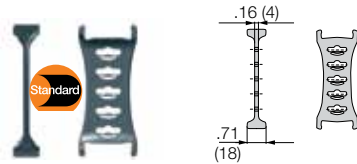

Separator, wide base

Unassembled **Part No. 80-1**

Assembled **Part No. 80-1-1**

- **Standard separator 80-1 for all applications**

Separator with wide base for maximum locking strength and safe standing in e-chains®.

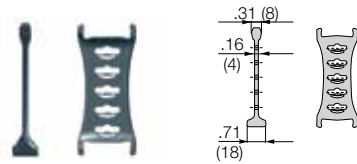

Separator, narrow head

Unassembled **Part No. 80-2**

Assembled **Part No. 80-2-1**

- **Separator 80-2**

For even faster installation

is used when vertical and horizontal separation is required. Due to its slot, it allows basic vertical/horizontal shelving arrangements.

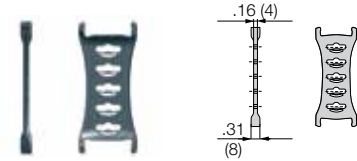

Separator, narrow base

Unassembled **Part No. 80-3**

Assembled **Part No. 80-3-1**

- **Separator 80-3**

For many thin cables

is used when vertical and horizontal separation is required. Due to its slot, it allows basic vertical/horizontal shelving arrangements.

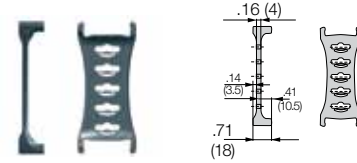

Separator, asymmetrical

Unassembled **Part No. 80-4**

Assembled **Part No. 80-4-1**

- **Separator 80-4**

For side mounted applications

is used when vertical and horizontal separation is required. Due to its slot, it allows basic vertical/horizontal shelving arrangements.

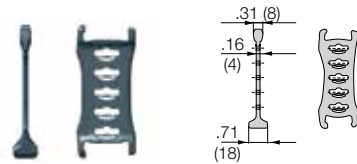

Separator, asymmetrical

Unassembled **Part No. 80-5**

Assembled **Part No. 80-5-1**

- **Separator 80-5**

Locks safely in .30" (7.5 mm) increments

Notch separator for exact positioning in e-chains®. Recommended for side-mounted applications.

Lockable full-width shelves - for the standard interior separation

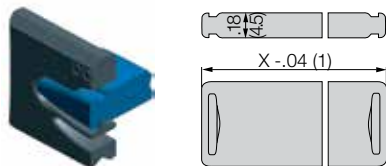

Full width shelf, lockable

Unassembled **Part No. 520-X**

Assembled **Part No. 521-X**

- **Full width shelf, lockable**

Shelf locks safely into separators on both ends, fixed width possible. Separators can be moved freely over the shelf in horizontal direction. Can be arranged at 5 different heights.

Internet: igus.com
email: sales@igus.com
QuickSpec: igus.com/quickspec

Width X in. (mm)	Part No. Unassembled	Part No. Assembled	Width X in. (mm)	Part No. Unassembled	Part No. Assembled	Width X in. (mm)	Part No. Unassembled	Part No. Assembled
1.97 (050)	520-50	521-50	5.91 (150)	520-150	521-150	11.81 (300)	520-300	521-300
2.56 (065)	520-65	521-65	6.89 (175)	520-175	521-175	13.78 (350)	520-350	521-350
2.95 (075)	520-75	521-75	7.87 (200)	520-200	521-200	14.76 (375)	520-375	521-375
3.94 (100)	520-100	521-100	8.86 (225)	520-225	521-225	15.24 (387)	520-387	521-387
4.92 (125)	520-125	521-125	9.84 (250)	520-250	521-250	17.723 (450)	520-450	521-450

e-chain system® E4-1
 Series E4-80/H4-80/R4-80
 Interior Separation - New Generation



E4-80
 H4-80
 R4-80

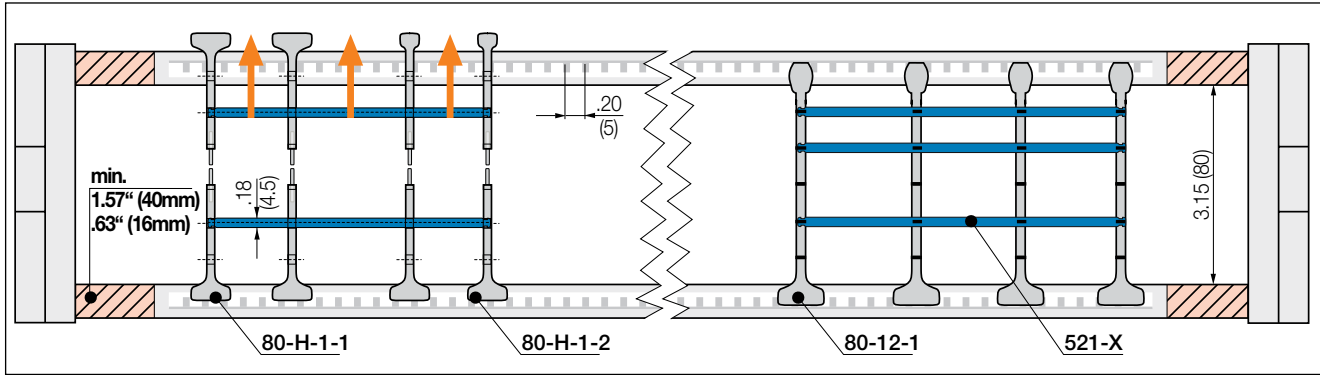

Note Please maintain a lateral spacing of 1.57" (40 mm) for e-tube and .63" (16 mm) for e-chains® between the separators and the side links. In the standard configuration separators are assembled every 2nd e-chain® link

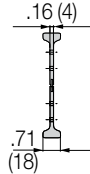
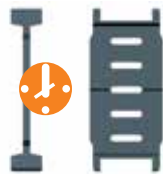

Separator, wide base

Unassembled **Part No. 80-H-1**
 Assembled **Part No. 80-H-1-1**

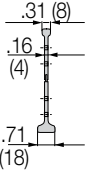
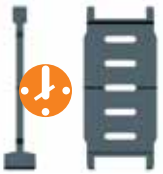

Separator, narrow head

Unassembled **Part No. 80-H-2**
 Assembled **Part No. 80-H-2-1**

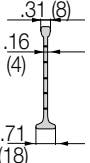

Lean separator

Unassembled **Part No. 80-12**
 Assembled **Part No. 80-12-1**

• **Split separators for all applications**

In order to fill e-chains® more easily and effectively, these separators can be split in the middle. This allows easier access to middle shelf partitions. Fast assembly and easy retrofit. 2 types available: with wide or narrow top.

• **Lean separators 80-12**

New design allows extremely fast fitting of shelves in several layers, which significantly reduces assembly time. Enables extremely fast replacement of individual cables in a very full e-chain®.

• **Lean separator design - several layers of cables fitted quickly, save up to 50%* assembly time**

(*Lean separator vs. standard separator - measured on a 4m long e-chain® fitted with 12 cables in the igus® harnessing factory)



PDF: igus.com/e-chain-pdfs
 Product information: igus.com/e-chains



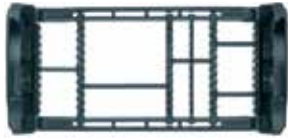

Shelves and separators

e-chains® and e-tubes can be subdivided both vertically and horizontally using the various interior separation elements.

► **Design, Chapter 1** for layout recommendations.

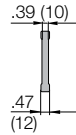
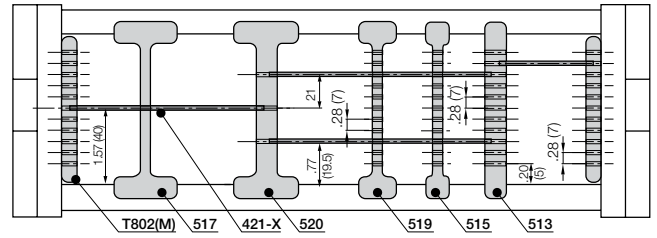

Side plate (for e-chains®)

Unassembled	Part No. T803
Assembled	Part No. T803M

- **Split separator T803**
This component is used to form the basic pattern of a shelf system.

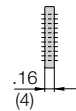

Side plate (for e-chains®)

Unassembled	Part No. T802
Assembled	Part No. T802M

- **Side plates 802**
This component is used to form the basic pattern of a shelf system.

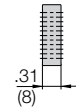

Vertical separator (for e-chains®)

Unassembled	Part No. 503
Assembled	Part No. 513

- **Vertical separator 503**
This component is used to form the basic pattern of a shelf system.

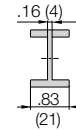

Locking vertical separator (for e-chains®)

Unassembled	Part No. 507
Assembled	Part No. 517

- **Locking vertical separator 507**
This separator features increased retention force for applications exposed to very high humidity and extreme loads. The extra retention force is achieved by asymmetric claws for the crossbar. Take care to ensure proper alignment.

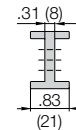

Locking vertical separator (for e-chains®)

Unassembled	Part No. 510
Assembled	Part No. 520

- **Locking vertical separator 510**
This separator is slotted and able to be combined with shelves. For e-chains® only.

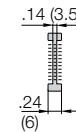
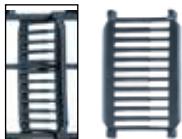

Slotted separators, closed (for e-chains®)

Unassembled	Part No. 505
Assembled	Part No. 515

- **Slotted separators 505**
These are used for very complex subdivisions. However, they cannot be retrofitted into an existing separation system without removing the shelves first.

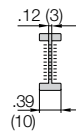

Slotted separators, open (for e-chains®)

Unassembled	Part No. 509
Assembled	Part No. 519

- **Slotted separator 509**
This separator can be retrofitted into an existing interior separation system without removing the shelves, as long as these shelves fit into any of the 7 middle slots

Shelves 420-XX

These components form the basic pattern of a shelf system. Shelves of various widths can be arranged at 11 different heights in .28" (7mm) increments

Width X in. (mm)	Usable Width in. (mm)	Part No. Unassembled	Part No. Assembled	Width X in. (mm)	Usable Width in. (mm)	Part No. Unassembled	Part No. Assembled
.71 (18)	.39 (10)	420-18	421-18	2.95 (75)	2.64 (67)	420-75	421-75
.91 (23)	.59 (15)	420-23	421-23	3.46 (88)	3.15 (80)	420-88	421-88
.98 (25)	.67 (17)	420-25	421-25	3.94 (100)	3.62 (92)	420-100	421-100
1.10 (28)	.79 (20)	420-28	421-28	4.92 (125)	4.61(117)	420-125	421-125
1.30 (33)	.98 (25)	420-33	421-33	5.91 (150)	5.59(142)	420-150	421-150
1.69 (43)	1.38 (35)	420-43	421-43	6.89 (175)	6.57(167)	420-175	421-175
1.97 (50)	1.65 (42)	420-50	421-50	7.36 (187)	7.05(179)	420-187	421-187
2.44 (62)	2.13 (54)	420-62	421-62	7.87 (200)	7.56(192)	420-200	421-200

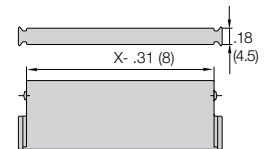

e-chain system® E4-1

Series E4-80/H4-80/R4-80

Interior Separation - Previous Generation



E4-80
H4-80
R4-80



Vertical separators and spacers

Vertical separators are used if a vertical subdivision of the e-chain® interior is required. By standard, vertical separators are assembled every other e-chain® link.

NOTE: Observe a lateral spacing of at least 1.30 in. (33mm) for e-tubes and .63 in. (16mm) for e-chain®. There is no minimum spacing needed for side plates

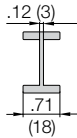
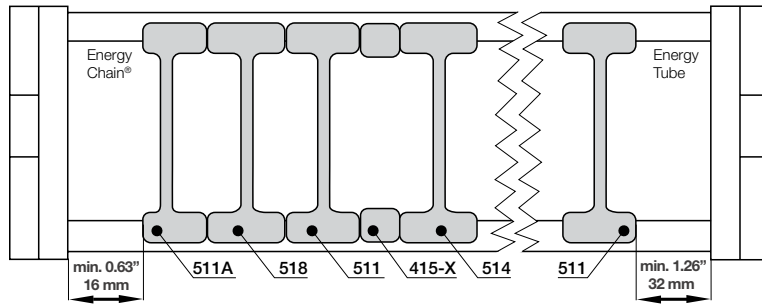

Vertical separator

Unassembled **Part No. 501**

Assembled **Part No. 511**

- **Standard separator 501 for e-chains® and e-tubes**
This separator offers safe stability due to its wide base design, also when used with thick cables or hoses.

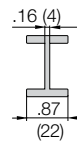

Locking separator (for e-chains®)

Unassembled **Part No. 504**

Assembled **Part No. 514**

- **Locking separator 504 for e-chains®**
This separator features increased retention force for applications exposed to very high humidity and extreme loads. If locking separators are used, the e-chain® is more difficult to open.

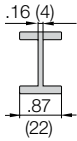

Locking separator (for e-tubes)

Unassembled **Part No. 508**

Assembled **Part No. 518**

- **Locking separator 508 for e-tubes**
This separator is used for applications that are exposed to extremely high humidity. The clamp at the side serves to uniformly align the separators. In order to avoid destroying the separators when opening the e-chain®, make sure all separators are identically aligned.

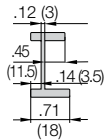

Asymmetrical separator (for e-chains®)

Unassembled **Part No. 501A**

Assembled **Part No. 511A**

- **Asymmetrical separator 501A for e-chains®**
This separator is NOT for e-tubes. It features an (18mm) base and can be used in combinations between spacers of different widths and vertical separators in side mounted applications.



Spacer (for e-chains®)

Unassembled **Part No. 405-XX**

Assembled **Part No. 415-XX**

XX = width of the spacer

- **NOTE ON SPACERS**
Vertical separators are adjustable, but can be fixed in position by means of a spacer. Spacers are most often necessary for side mounted applications. The available inner height is reduced by .08" (2mm) **per spacer** (for example if one spacer is placed on either side of the separator, the overall inner height is reduced by .16" (4mm)). To avoid this, place the spacers on the **outside** of the opening crossbar (**not for long travels**).

Spacers available in the following sizes:

Part No. Unassembled	Part No. Assembled	in.	(mm)	Part No. Unassembled	Part No. Assembled	in.	(mm)
405 -10	415 -10	.39"	(10)	405 -30	415 -30	1.18"	(30)
405 -15	415 -15	.59"	(15)	405 -40	415 -40	1.57"	(40)
405 -20	415 -20	.79"	(20)				



PDF: igus.com/e-chain-pdfs
Product information: igus.com/e-chains



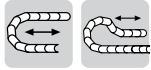

Option 1: pivoting

- Recommended for unsupported and gliding applications
- Attachment capability on all sides
- Bolted connection outside of chain cross-section
- Space restricted conditions
- Corrosion resistant

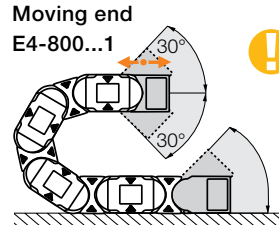

Standard

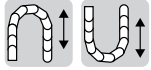
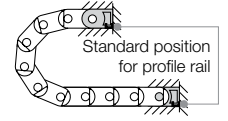

Option 2: locking

- Profile rail option
- Universal use
- Corrosion resistant
- Vertical hanging/standing travels
- Extreme accelerations

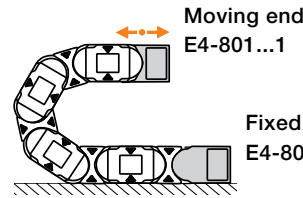

Fixed end
E4-801...2

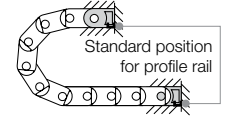

Part Number Structure

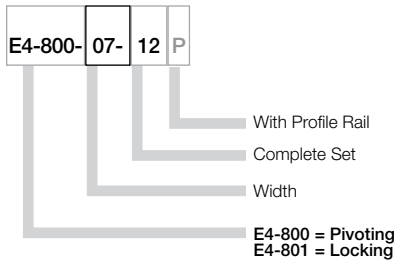

Due to the design of the E4-80 series chains, please note the following when ordering brackets:
Even number of links = full set, part number ending in -12
Odd number of links = 2 pieces, part number ending in -1

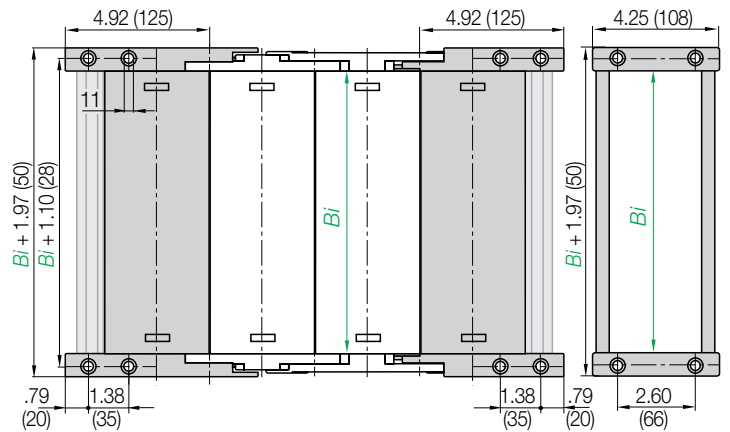

Part No. Full Set (pivoting)
Series E4-80 or H4-80
E4-800-Width-12

Part No. Full Set (pivoting) with profile rail
Series E4-80 or H4-80
E4-800-Width-12P

Part number examples are shown for pivoting brackets for e-chain. For locking brackets change part number to 801

Width	Part No. Full Set chain		With Profile Rail	Bi in. (mm)
	Pivoting	Locking		
-05*	E4-800	E4-801	-05-12 P	1.97 (50)
-055	E4-800	E4-801	-055-12 P	2.17 (55)
-06	E4-800	E4-801	-06-12 P	2.56 (65)
-07	E4-800	E4-801	-07-12 P	2.95 (75)
-08	E4-800	E4-801	-08-12 P	3.43 (87)
-10	E4-800	E4-801	-10-12 P	3.94 (100)
-11	E4-800	E4-801	-11-12 P	4.41 (112)
-12	E4-800	E4-801	-12-12 P	4.92 (125)
-13	E4-800	E4-801	-13-12 P	5.39 (137)
-15	E4-800	E4-801	-15-12 P	5.91 (150)
-16	E4-800	E4-801	-16-12 P	6.38 (162)
-169	E4-800	E4-801	-169-12 P	6.65 (169)
-17	E4-800	E4-801	-17-12 P	6.89 (175)
-182	E4-800	E4-801	-082-12 P	7.17 (182)
-18	E4-800	E4-801	-18-12 P	7.36 (187)
-20	E4-800	E4-801	-20-12 P	7.87 (200)
-207	E4-800	E4-801	-207-12 P	8.15 (207)
-21	E4-800	E4-801	-21-12 P	8.35 (212)
-22	E4-800	E4-801	-22-12 P	8.86 (225)
-23	E4-800	E4-801	-23-12 P	9.33 (237)
-25	E4-800	E4-801	-25-12 P	9.84 (250)
-26	E4-800	E4-801	-26-12 P	10.31 (262)
-27	E4-800	E4-801	-27-12 P	10.83 (275)

Width	Part No. Full Set chain		With Profile Rail	Bi in. (mm)
	Pivoting	Locking		
-28	E4-800	E4-801	-28-12 P	11.30 (287)
-30	E4-800	E4-801	-30-12 P	11.81 (300)
-31	E4-800	E4-801	-31-12 P	12.28 (312)
-32	E4-800	E4-801	-32-12 P	12.79 (325)
-33	E4-800	E4-801	-33-12 P	13.27 (337)
-35	E4-800	E4-801	-35-12 P	13.78 (350)
-36	E4-800	E4-801	-36-12 P	14.25 (362)
-37	E4-800	E4-801	-37-12 P	14.76 (375)
-38	E4-800	E4-801	-38-12 P	15.24 (387)
-40	E4-800	E4-801	-40-12 P	15.75 (400)
-41	E4-800	E4-801	-41-12 P	16.22 (412)
-42	E4-800	E4-801	-42-12 P	16.73 (425)
-43	E4-800	E4-801	-43-12 P	17.20 (437)
-45	E4-800	E4-801	-45-12 P	17.72 (450)
-46	E4-800	E4-801	-46-12 P	18.19 (462)
-47	E4-800	E4-801	-47-12 P	18.70 (475)
-48	E4-800	E4-801	-48-12 P	19.17 (487)
-50	E4-800	E4-801	-50-12 P	19.69 (500)
-51	E4-800	E4-801	-51-12 P	20.16 (512)
-52	E4-800	E4-801	-52-12 P	20.67 (525)
-53	E4-800	E4-801	-53-12 P	21.14 (537)
-55	E4-800	E4-801	-55-12 P	21.65 (550)
-60	E4-800	E4-801	-60-12 P	23.62 (600)

e-chain system® E4-1

Series E4-80/H4-80/R4-80

Mounting Brackets



E4-80
H4-80
R4-80

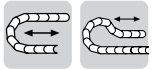

Option 1: pivoting

- Recommended for unsupported and gliding applications
- Attachment capability on all sides
- Bolted connection outside of chain cross-section
- Space restricted conditions
- Corrosion resistant

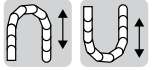
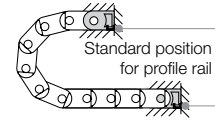
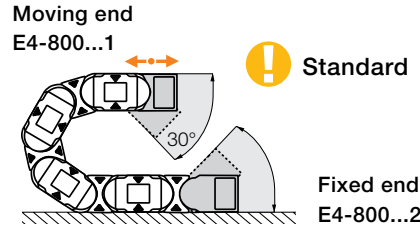

Option 2: locking

- Profile rail option
- Universal use
- Corrosion resistant
- Vertical hanging/standing travels
- Extreme accelerations

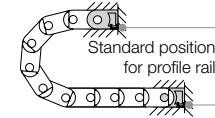
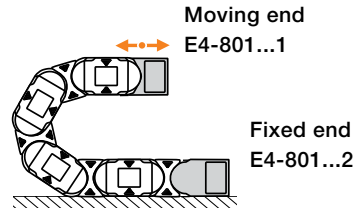

Part Number Structure

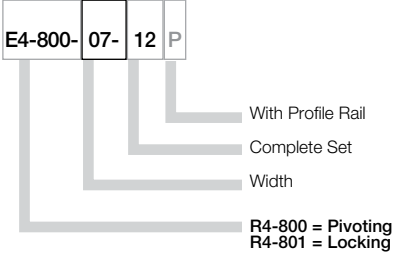

Due to the design of the E4-80 series chains, please note the following when ordering brackets:
Even number of links = full set, part number ending in -12
Odd number of links = 2 pieces, part number ending in -1

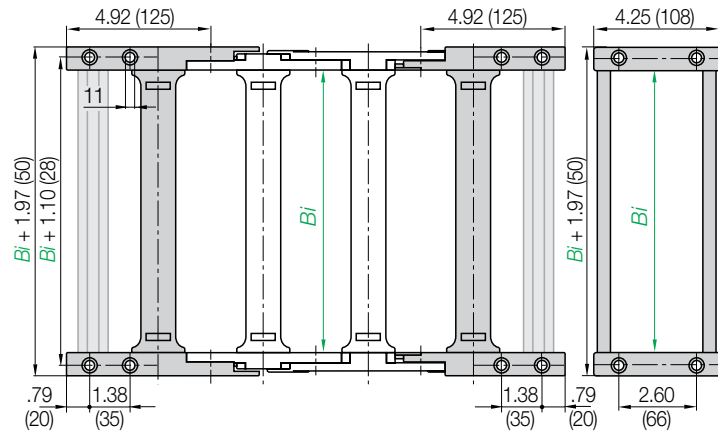

Part No. Full Set (pivoting)

Tube Series R4-80
R4-800-Width-12

Part No. Full Set (pivoting)

with Profile Rail
Tube Series R4-80
R4-800-Width-12P

Part number examples are shown for pivoting brackets for e-chain. For locking brackets change part number to 801

Width	Part No. Full Set tube		With Profile Rail	Bi in. (mm)	Width	Part No. Full Set tube		With Profile Rail	Bi in. (mm)		
	Pivoting	Locking				Pivoting	Locking				
-07	R4-800	R4-801	-07-12	P	2.95 (75)	-25	R4-800	R4-801	-25-12	P	9.84 (250)
-10	R4-800	R4-801	-10-12	P	3.94 (100)	-27	R4-800	R4-801	-27-12	P	10.83 (275)
-12	R4-800	R4-801	-12-12	P	4.92 (125)	-30	R4-800	R4-801	-30-12	P	11.81 (300)
-15	R4-800	R4-801	-15-12	P	5.91 (150)	-35	R4-800	R4-801	-35-12	P	13.78 (350)
-17	R4-800	R4-801	-17-12	P	6.89 (175)	-40	R4-800	R4-801	-40-12	P	15.75 (400)
-20	R4-800	R4-801	-20-12	P	7.87 (200)	-46	R4-800	R4-801	-46-12	P	18.19 (462)

PDF: igus.com/e-chain-pdfs
Product information: igus.com/e-chains



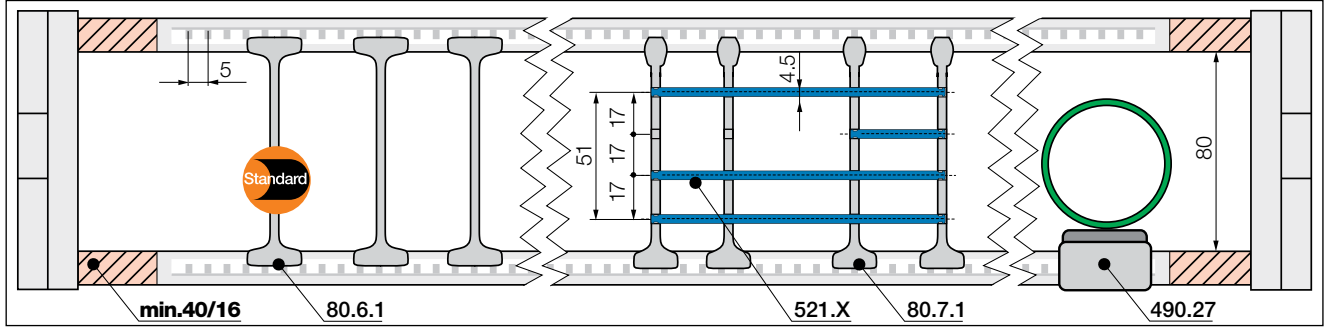

Note Please maintain a lateral spacing of 1.57" (40 mm) for e-tube and .63" (16 mm) for e-chains® between the separators and the side links. In the standard configuration separators are assembled every 2nd e-chain® link

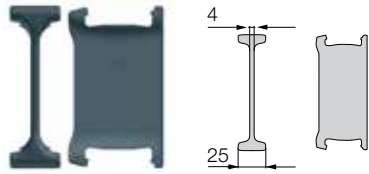

Notch locking separator

Unassembled	Part No. 80-6
Assembled	Part No. 80-6-1

● **Notch locking separator for increased holding force**

Notch locking separators offer higher crossbar opening forces for high humidity and/or large hydraulic hoses. They can be positioned precisely and then locked in position.

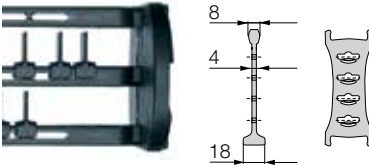

Partial height separator

Unassembled	Part No. 80-7
Assembled	Part No. 80-7-1

● **Partial height separator***

In conjunction with an additional opening crossbar, **part no. 450-Bi-S**, it provides the option to separate the upper and lower halves of the e-chain® independently of each other.

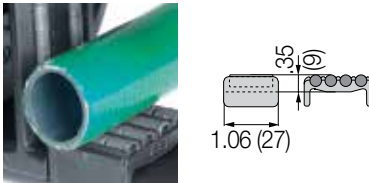

Rollclip* for e-chains®

Unassembled	Part No. 489-27
Assembled	Part No. 490-27

● **Rollclip***

Minimizes abrasion of sensitive hoses. Simply clamps onto the opening crossbar. The movable rollers compensate for relative movement between the e-chain® and hose.

*Only for e-chains®

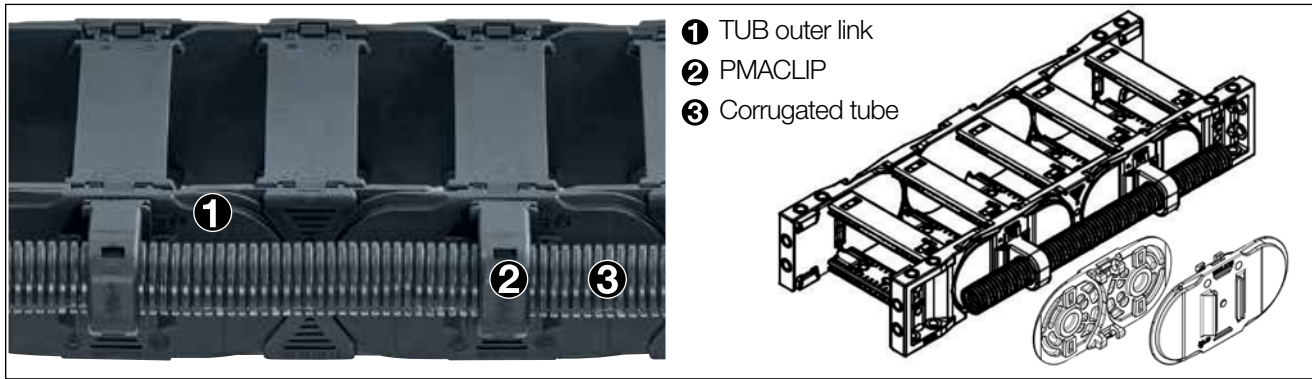

- ❶ TUB outer link
- ❷ PMACLIP
- ❸ Corrugated tube

TUB | Safe guidance for corrugated tubes parallel to the e-chain®

- Additional, simple guidance for corrugated tubes on the outside of the e-chain®
- PMACLIP allows corrugated tubes with nominal widths .28 (07mm), .39 (10mm), .47 (12mm), .67 (17mm) to be easily clipped on
- Easy access to the corrugated tubes, fast replacement of the hoses
- Reduce assembly time and cost - easy to assemble, without any additional screws or tools
- The part number includes the e-chain® with TUB side sections; the PMACLIP support and the hose are ordered separately

Part No. TUB	Part No. TUB	Part No. TUB	For corrugated tube nominal diameter
Outer link right*	Outer link left*	Outer link at both ends*	Ø [mm]
E4-80-XXXTUBR-R-0	E4-80-XXXTUBL-L-R-0	E4-80-XXXTUB-R-0	.28 (07), .39 (10), .47 (12), .67 (17)

*View from the fixed end

Part number appended with width index **XXX Bi** and radius (**R**) e.g.

E4-80-100TUBR-150-0 = with TUB outer sections every 2nd right hand link

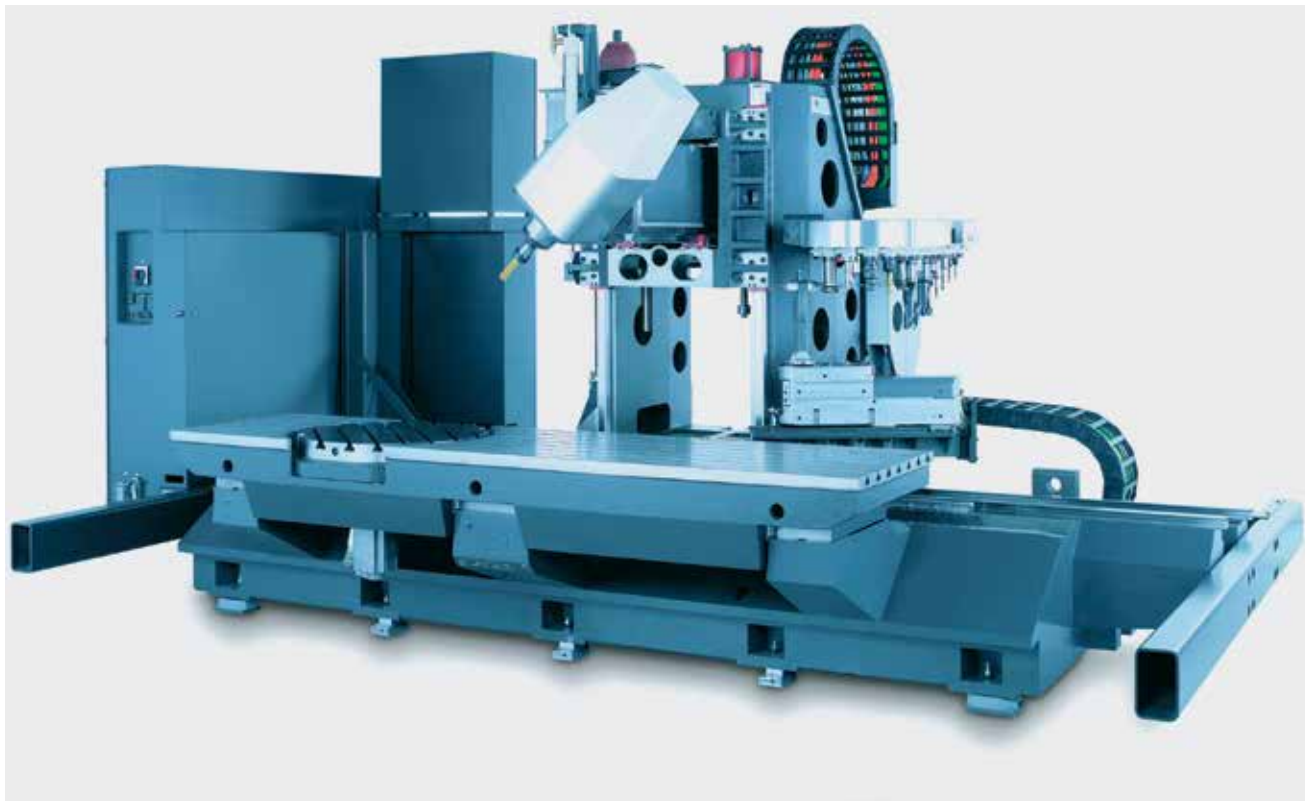

Due to the undercut design igus® E4-1 series feature high lateral stability. High lateral accelerations of up to 26.25ft/s² (8m/s²) can be managed on this milling machine for bicycles





Extension links - for extremely wide e-chains® up to 9.84 ft (3m)

- For applications in which particularly high fill weights necessitate extremely wide e-chains® (up to 118" (3000 mm))
- The extension link design allows virtually limitless side-by-side attachment of chains
- The unsupported length of a chain can be increased when additional loads are required
- Extension links can be used with e-chains®, e-tubes or a combination of both
- They are suitable for unsupported and gliding applications in a guide trough
- e-chains® with extension links are attached with KMA or steel mounting brackets.

Part number example for e-chain®
E4-80-10/20/10-200-0
E4-80-Bi1/Bi2/Bi3-R-0

We strongly recommend on-site consultation with an igus® technician for individual advice regarding mounting brackets, guide troughs and other design details.

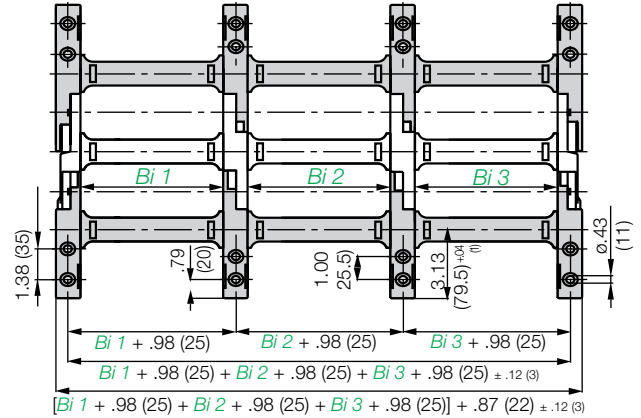

Consult igus® for your extender crossbar applications. We will be happy to assist you with your design layout.

Extender crossbars - For careful guiding of large diameter cables and hoses

- Intended for cables and hoses with a maximum outer diameter of 10.63 in. (270 mm).
- Can be attached along either the inner or outer radius, inner radius preferred
- Gliding operation with crossbars assembled along the outer radius in conjunction with a special guide trough
- Gliding operation not guaranteed with crossbars assembled along the inner radius
- The extender crossbar can either be attached to the side links directly or can be used in combination with two standard snap-open crossbars.

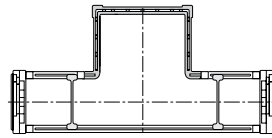

Square extender crossbar combined with standard snap-open crossbars.

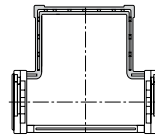

Attached directly to the side link.

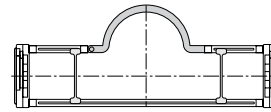

Round extender crossbar combined with standard snap-open crossbars.

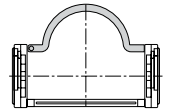

Attached directly to the side link.

Part No.	Max Ø Hose	Style	Installation Side Link	Combined with Snap-Open Crossbars
450-15-RHD115	4.52 (115)	Round	No	Yes
450-17-RD115	4.52 (115)	Round	Yes	No
450-25-D150	5.91 (150)	Square	Yes	No
450-30-D200	7.87 (200)	Square	Yes	No
450-35-D250	8.66 (220)	Square	Yes	No
450-40-D300	10.63 (270)	Square	Yes	No
450-20-HD150	5.91 (150)	Square	No	Yes
450-25-HD200	7.87 (200)	Square	No	Yes
450-30-HD250	8.66 (220)	Square	No	Yes

e-chain system® E4-1

Series E4-80/H4-80/R4-80

Strain Relief



E4-80
H4-80
R4-80

Chainfix clamps for the profile rail

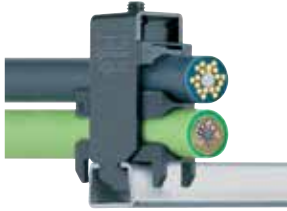

igus® Chainfix strain relief elements are available in either steel or stainless steel. They can be adjusted with a hexagon socket and are available in single, double and triple configurations.

Part No. Single Clamp		Part No. Double Clamp		Part No. Triple Clamp		Cable ø	
Steel	Stainless	Steel	Stainless	Steel	Stainless	in.	(mm)
CFX12-1	CFX12-1E	CFX12-2	CFX12-2E	CFX12-3	–	.24 - .47	(6 - 12)
CFX14-1	CFX14-1E	CFX14-2	CFX14-2E	CFX14-3	–	.47 - .55	(12 - 14)
CFX16-1	CFX16-1E	CFX16-2	CFX16-2E	CFX16-3	–	.55 - .63	(14 - 16)
CFX18-1	CFX18-1E	CFX18-2	CFX18-2E	CFX18-3	–	.63 - .71	(16 - 18)
CFX20-1	CFX20-1E	CFX20-2	CFX20-2E	CFX20-3	–	.71 - .79	(18 - 20)
CFX22-1	CFX22-1E	CFX22-2	CFX22-2E	CFX22-3	–	.79 - .87	(20 - 22)
CFX26-1	CFX26-1E	CFX26-2	CFX26-2E	–	–	.87 - 1.02	(22 - 26)
CFX30-1	CFX30-1E	CFX30-2	CFX30-2E	–	–	1.02 - 1.18	(26 - 30)
CFX34-1	CFX34-1E	CFX34-2	CFX34-2E	–	–	1.18 - 1.34	(30 - 34)
CFX38-1	CFX38-1E	–	–	–	–	1.34 - 1.50	(34 - 38)
CFX42-1	CFX42-1E	–	–	–	–	1.50 - 1.65	(38 - 42)

For more information please refer to strain relief section of Chapter 10.

Tiewrap Plates

Option 1: Tiewrap plates as an individual part

Available as an individual component, can be fixed onto a mounting bracket with the use of a profile rail.

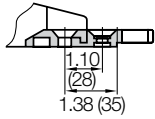

Shown assembled

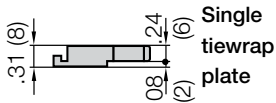

Single Tiewrap plate

Tiewrap Plate	n Number of Teeth	C Overall Width in. (mm)	B Bore Width in. (mm)	Center Bore
3050-ZB	5	1.97 (50)	1.18 (30)	no
3075-ZB	7	2.95 (75)	2.16 (55)	no
3100-ZB	10	3.94 (100)	3.15 (80)	no
3115-ZB	11	4.53 (115)	3.74 (95)	no
3125-ZB	12	4.92 (125)	4.13 (105)	no
3150-ZB	15	5.91 (150)	5.12 (130)	no
3175-ZB	17	6.89 (175)	6.10 (155)	no
3200-ZB	20	7.87 (200)	7.09 (180)	yes
3225-ZB	22	8.86 (225)	8.07 (205)	yes
3250-ZB	25	9.84 (250)	9.06 (230)	yes

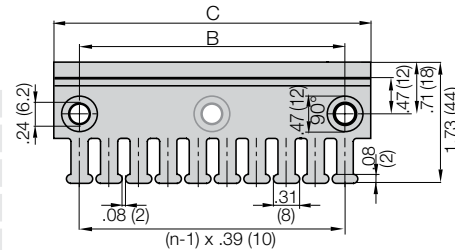

If used with KMA brackets with profile rail please add "KMA" to the end of the part number.

Example: 3050-ZBKMA

For more information please refer to strain relief section of Chapter 10

Option 2: Clip-on Tiewrap plates

Available as a clip-on tiewrap plate without the use of bolts. They are inserted and removed with a screwdriver used as a lever. Clip-on tiewrap plates are also available as an attachment to the opening crossbars.



Part No.	Number of Teeth	Width of Strain Relief in. (mm)
3050-ZC	5	1.97 (50)
3075-ZC	7	2.95 (75)

For more information please refer to strain relief section of Chapter 10.

Option 3: Clip-on Tiewrap plates for opening crossbars

Clip-on tiewrap plates are also available as an attachment to opening crossbars. They can be positioned at any point along the e-chain®.



Part No.	Number of Teeth	Width of Strain Relief in. (mm)
4550-ZS	5	1.89 (48)
4575-ZS	7	2.91 (74)

For more information please refer to strain relief section of Chapter 10

PDF: igus.com/e-chain-pdfs
Product information: igus.com/e-chains



Width of Crossbar
E4-80-05-200-0

	B_{Ri}	Installation Part No.
-05	4.13 (105)	96-50-225
-06	4.72 (120)	96-50-250
-07	5.12 (130)	96-50-250
-08	5.59 (142)	96-50-275
-10	6.10 (155)	96-50-275
-11	6.61 (168)	96-50-300
-12	7.09 (180)	96-50-300
-13	7.60 (193)	96-50-325
-15	8.07 (205)	96-50-325
-16	8.58 (218)	96-50-350
-17	9.06 (230)	96-50-350
-18	9.57 (243)	96-50-375
-20	10.04 (255)	96-50-375
-21	10.55 (268)	96-50-400
-22	11.02 (280)	96-50-400
-23	11.54 (293)	96-50-425
-25	12.01 (305)	96-50-425
-26	12.52 (318)	96-50-450
-27	12.99 (330)	96-50-450
-28	13.50 (343)	96-50-475
-30	13.98 (355)	96-50-475
-31	14.49 (368)	96-50-500
-32	14.96 (380)	96-50-500
-33	15.47 (393)	96-50-525
-35	15.94 (405)	96-50-525
-36	16.46 (418)	96-50-550
-37	16.93 (430)	96-50-550
-38	17.44 (443)	96-50-575
-40	17.91 (455)	96-50-575
-41	18.43 (468)	96-50-600
-42	18.90 (480)	96-50-600
-43	19.41 (493)	96-50-625
-45	19.88 (505)	96-50-625
-46	20.39 (518)	96-50-650
-47	20.87 (530)	96-50-650
-48	21.38 (543)	96-50-675
-50	21.85 (555)	96-50-675
-51	22.36 (568)	96-50-700
-52	22.83 (580)	96-50-700
-53	23.35 (593)	96-50-725
-55	23.82 (605)	96-50-725
-60	25.79 (655)	96-50-775

Guide troughs are used with applications where the upper run of the e-chain® glides on the lower run. If using igus® steel guide troughs, the following components are required:

- Full travel length of guide trough
Part No. 99-30
- 1/2 travel length glide bars
Part No. 93-01
- Installation sets as end connectors
Part No. 96-50-XX

-XX indicates the length of the profile rails on which the guide trough is mounted. The values and part numbers are specified in the table on the right. The standard length of the trough components and glide bars is 6.56 ft (2 m). The overall length of the guide trough directly correlates to the length of travel.

Example:

Length of travel 164 ft (50 m)
Center-mounted

Required guide troughs:

164 ft (50 m) guide trough, 82 ft. (25 m) glide bar
= 25 sections of 6.56 ft (2 m) guide trough

Part No. 99-30

= 13 sections of 6.56 ft (2 m) glide bar

Part No. 93-01

Required number of installation set:

= Number of guide trough components + 1
= 25 + 1 = 26

Part No. of the installation sets **96-50-XXX**

Example: 96-50-400 for 15.75 (400 mm) long profile rail



Left: Guide trough with glide bars
Right: Guide troughs without glide bars



Installation sets as section connectors

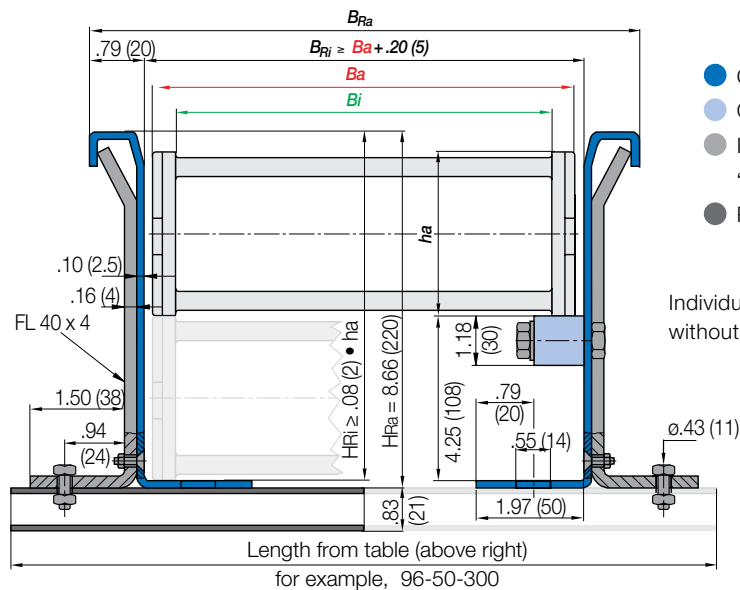

- Guide trough
- Glide bars
- Installation set "Basic"
- Profile rail

Individual attachment without profile rail

* Specialized guide trough available upon request

Standard length profile rail

For further technical information on guide troughs
► Chapter 9



E4-112
R4-112



e-chain system® E4-1 Series E4-112/R4-112



Price Index



Series E4-112



Series R4-112

Special Options Available



Low noise version available with special rubber pads



Cleanroom test upon request



ESD classification:
Electrically conductive ESD/
ATEX version upon request

Assembly Tips



Opening e-chains®: Remove crossbars and clips - Insert screwdriver into the slot, push down, release by lever action



Remove lids/bottoms (e-tubes) - Insert screwdriver into the slot, release by lever action

Other Installation Methods

Vertical, hanging ≤ 394 ft (120 m)

Vertical, standing ≤ 19.69 ft (6 m)

Side-mounted, un_supp. ≤ 9.84 ft (3 m)

Rotary requires further calculation

Usage Guidelines



- If a robust e-chain/Energy is required
- If inner widths up to 23.62" (600 mm) are required
- For unsupported lengths up to 21.3 ft. (6.5 m) and fill weights up to 57.12 lbs/ft. (85 kg/m)
- For long travels



- When an e-chain is needed for rough applications with greater inner height
 - Series 800
- When a lighter e-chain® is needed
 - Series 1640

Features & Benefits

- 1 Steel mounting brackets
- 2 Hinged, snap-open removable lids along the outer radius
- 3 Noise dampening pads, optional = -10dB(A)
- 4 Gliding surfaces, long travels
- 5 Chip protection with e-tube
- 6 Undercut for more stability
- 7 Notch crossbar with backside scaling
- 8 Straight run due to the inner/outer link design
- 9 Low noise operation due to integrated "brake"



Also available without camber.
Add NCST to the end of the part number.
Ex: E4-112-30-300NCST

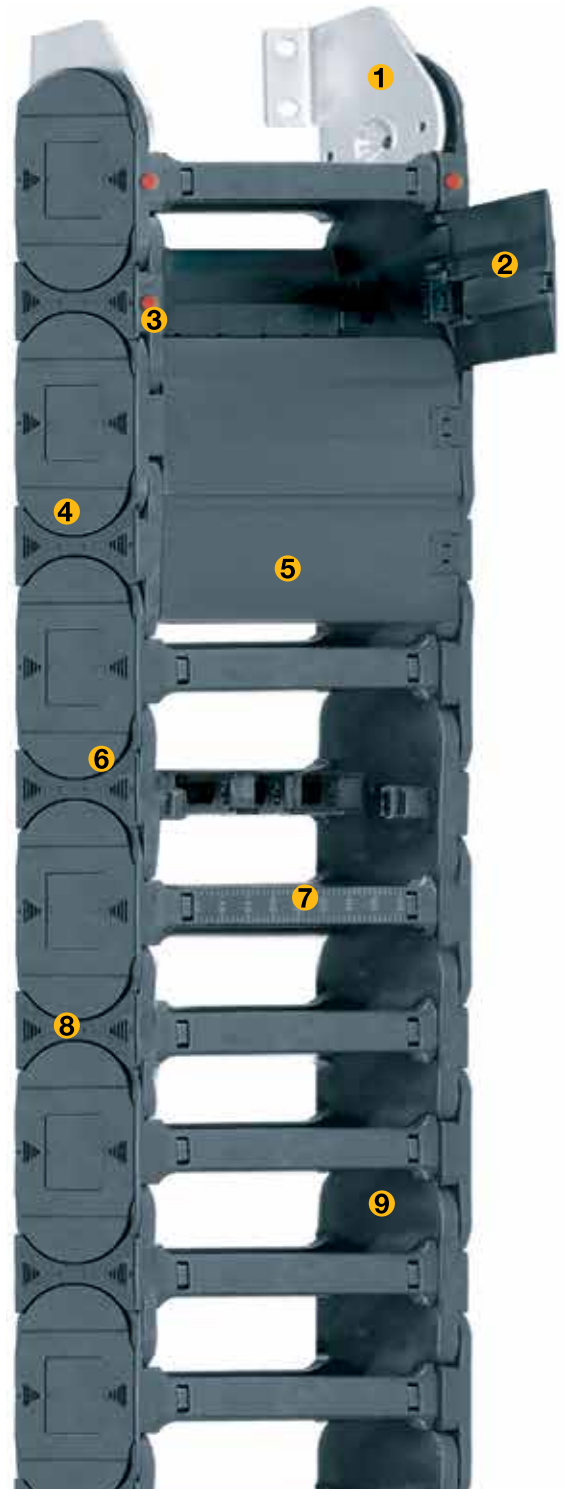

Order Example: Complete e-chain®

Please indicate chain length or number of links. Example:

16.4 ft (5 m) **E4-112-30-300-0**



e-chain®

With 2 separators **112.1.1** assembled every 2nd link



Interior Separation

1 Set **E4.11210.112VS**



Mounting Bracket

e-chain system® E4-1

Series E4-112/R4-112

Installation Dimensions

Short travel, unsupported length

- FL_B = unsupported with permitted sag
 - FL_G = unsupported with straight upper run
- Further information ► Design, Chapter 1

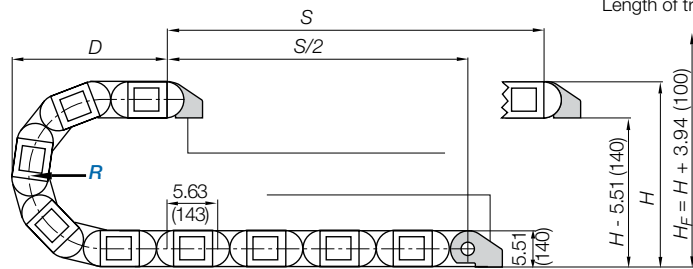
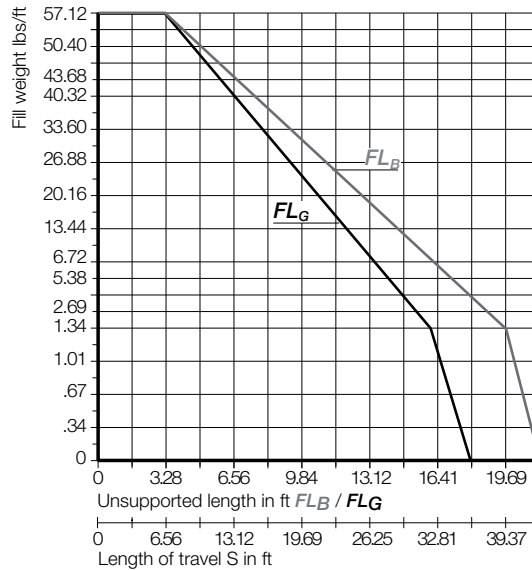
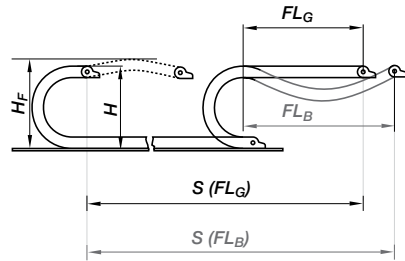

Pitch per link: = 5.63" (143 mm)
 Links per ft (m): = 2.13 (7)
 For center mount applications:
 Chain length = $\frac{S}{2} + K$

The required clearance height: $H_F = H + 3.94$ in. (100 mm) with 3.36 lbs/ft (5 kg/m) fill weight.
 Please consult igus® if space is particularly restricted.

R	7.87 (200*)	9.84 (250)	11.81 (300)	13.78 (350)	15.75 (400)	9.84 (450)	19.68 (500)	21.65 (550)	23.62 (600)	29.53 (750)	39.37 (1000)
H	21.46 (545)	25.39 (645)	29.33 (745)	33.27 (845)	37.20 (945)	41.14 (1045)	45.08 (1145)	49.02 (1245)	52.95 (1345)	64.76 (1645)	84.45 (2145)
D	16.34 (415)	18.31 (465)	20.27 (515)	22.24 (565)	24.21 (615)	26.18 (665)	28.15 (715)	30.12 (765)	32.09 (815)	37.99 (965)	47.83 (1215)
K	36.02 (915)	42.32 (1075)	48.43 (1230)	54.72 (1390)	60.83 (1545)	66.93 (1700)	75.86 (1860)	79.33 (2015)	85.63 (2175)	104.13 (2645)	135.04 (3430)

* Radius not available for e-tubes

For long travels with lowered mounting height

Long travel lengths from 45.9 ft. (14m) to max. 1,476 ft. (450m)

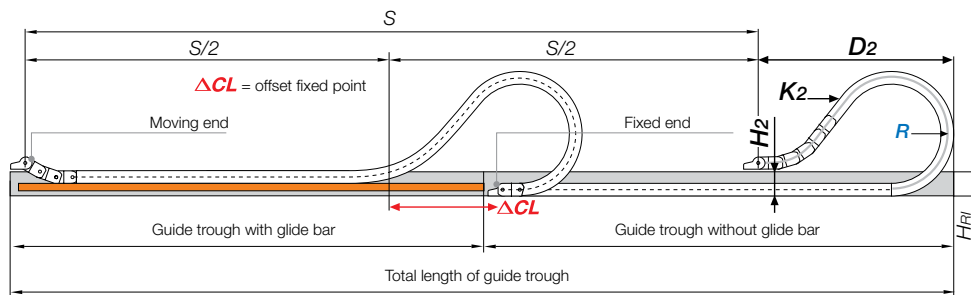

For center mount applications:

Chain length = $\frac{S}{2} + K_2$

Long Travels - Gliding



If the unsupported length is exceeded, the e-chain®/ Tube must glide on itself. This requires a guide trough.

Design, Chapter 1

R	7.87 (200**)	9.84 (250)	11.81 (300)	13.78 (350)	15.75 (400)	9.84 (450)	19.68 (500)	21.65 (550)	23.62 (600)	29.53 (750)	39.37 (1000)
H ₂	12.80 (325)	12.80 (325)	12.80 (325)	12.80 (325)	12.80 (325)	12.80 (325)	12.80 (325)	12.80 (325)	12.80 (325)	-	-
D ₂	35.43 (900)	39.37 (1000)	43.31 (1100)	49.21 (1250)	57.09 (1450)	62.99 (1600)	66.93 (1700)	74.80 (1900)	80.71 (2050)	-	-
K ₂	61.93 (1573)	67.56 (1716)	73.19 (1859)	90.08 (2288)	101.34 (2574)	112.60 (2860)	123.86 (3146)	135.12 (3432)	152.01 (3861)	-	-
ΔCL	17.72 (450)	19.68 (500)	21.65 (550)	25.59 (650)	31.50 (800)	35.43 (900)	37.40 (950)	43.31 (1100)	47.24 (1200)	-	-

In case of travels between 13 and 32.8 ft (4 and 10 m) we recommend a longer unsupported length. **200 radius is not available for the e-tubes

Speed / acceleration FL_G	max. 65.6 ft/s (20 m/s) / max. 656 ft/s ² (200 m/s ²)
Speed / acceleration FL_B	max. 9.84 ft/s (3 m/s) / max. 19.69 ft/s ² (6 m/s ²)
Gliding speed / acceleration (maximum)	max. 32.8 ft/s (10 m/s) / max. 164 ft/s ² (50 m/s ²)
Material - permitted temperature	igumid G / -40°F (-40°C) up to +248°F (+120°C)
Flammability Class, igumid G	VDE 0304 IIC UL94 HB

Technical Data



Details of material properties

► Chapter 1



E4-112
R4-112



Short Travels - Unsupported

Unsupported e-chains® feature positive camber over short travels. This must be accounted for when specifying the clearance height. Please refer to **Installation dimensions** for further details.

Legend

- S = Length of travel
 - R = Bending radius
 - H = Nominal clearance height
 - D = Overlength e-chain® radius in final position
 - $K = \pi \cdot R + \text{safety buffer}$
 - H_F = Required clearance height
 - H_{RI} = Trough inner height
 - H_2 = *Mounting height
 - D_2 = Overlength - long travels, gliding
 - K_2 = *Add-on
- *If the mounting bracket location is set lower

PDF: igus.com/e-chain-pdfs
 Product information: igus.com/e-chains

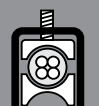

Series E4-112 - e-chain® with crossbars every link

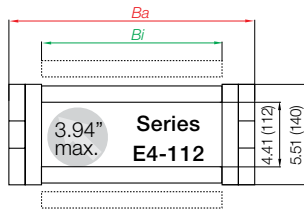

- Crossbars every link
- For use with rigid hydraulic hoses
- For particularly demanding applications
- Can be opened from both sides

Part Number Structure

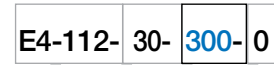

Series R4-112 - fully enclosed e-tube

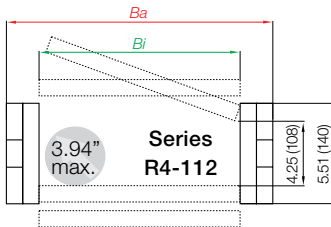

- Fully enclosed
- Excellent cable and hose protection against dirt
- Protection against hot chips
- Lids along the outer radius are single-sided, snap open, hinged on one side as well as completely removable

Part Number Structure



e-chain® as separate parts, links and side plates

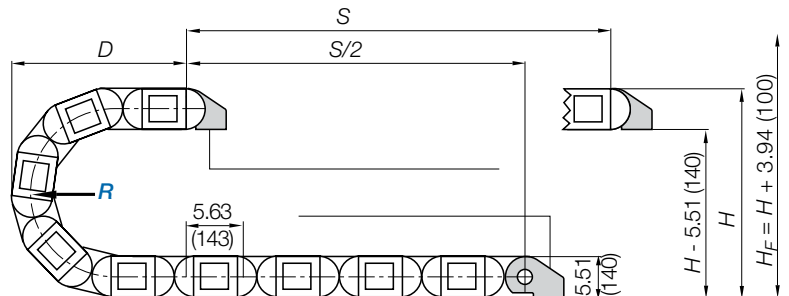
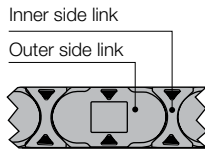
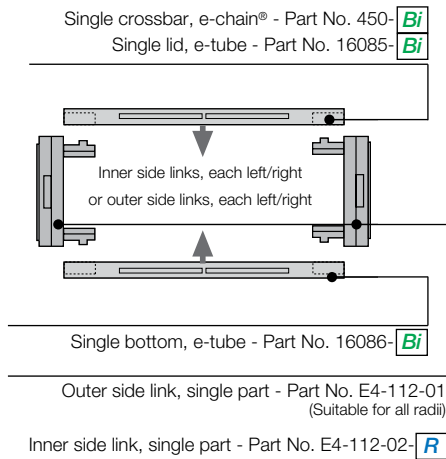

e-chain system® E4-1

Series E4-112/R4-112



E4-112
R4-112

Supplement part number with required radius. Example: E4-112-30-300-0

Pitch: 5.63 in. (143mm) per link links/ft (m) = 2.13 (7)

Part Number			Weight			
Crossbars Every link	Tube Version		<i>Bi</i> in. (mm)	<i>Ba</i> in. (mm)	E4-112 lbs/ft (kg/m)	R4-112 lbs/ft (kg/m)
E4-112-05-		<input type="checkbox"/> -0	1.97 (50)	4.02 (102)	≈ 4.63 (6.89)	-
E4-112-055-		<input type="checkbox"/> -0	2.17 (55)	4.21 (107)	≈ 5.25 (7.81)	-
E4-112-06-		<input type="checkbox"/> -0	2.56 (65)	4.61 (117)	≈ 4.67 (6.95)	-
E4-112-07-		<input type="checkbox"/> -0	2.95 (75)	5.00 (127)	≈ 4.70 (6.99)	-
E4-112-08-		<input type="checkbox"/> -0	3.43 (87)	5.47 (139)	≈ 4.74 (7.05)	-
E4-112-10-		<input type="checkbox"/> -0	3.94 (100)	5.98 (152)	≈ 4.77 (7.10)	-
E4-112-11-		<input type="checkbox"/> -0	4.41 (112)	6.46 (164)	≈ 4.82 (7.18)	-
E4-112-12-		<input type="checkbox"/> -0	4.92 (125)	6.97 (177)	≈ 4.86 (7.23)	-
E4-112-13-		<input type="checkbox"/> -0	5.39 (137)	7.44 (189)	≈ 4.91 (7.31)	-
E4-112-15-		<input type="checkbox"/> -0	5.91 (150)	7.95 (202)	≈ 4.93 (7.34)	-
E4-112-16-		<input type="checkbox"/> -0	6.38 (162)	8.43 (214)	≈ 4.98 (7.41)	-
E4-112-169-		<input type="checkbox"/> -0	6.65 (169)	4.21 (222)	≈ 5.61 (8.35)	-
E4-112-17-		<input type="checkbox"/> -0	6.89 (175)	8.94 (227)	≈ 5.03 (7.49)	-
E4-112-182-		<input type="checkbox"/> -0	7.17 (182)	9.25 (235)	≈ 5.65 (8.41)	-
E4-112-18-		<input type="checkbox"/> -0	7.36 (187)	9.41 (239)	≈ 5.08 (7.56)	-
E4-112-20-	R4-112-20-	<input type="checkbox"/> -0	7.87 (200)	9.92 (252)	≈ 5.10 (7.60)	≈ 6.22 (9.26)
E4-112-207-		<input type="checkbox"/> -0	8.15 (207)	8.11 (206)	≈ 5.72 (8.52)	-
E4-112-21-		<input type="checkbox"/> -0	8.35 (212)	10.39 (264)	≈ 5.13 (7.64)	-
E4-112-22-		<input type="checkbox"/> -0	8.86 (225)	10.91 (277)	≈ 5.17 (7.69)	-
E4-112-23-		<input type="checkbox"/> -0	9.33 (237)	11.38 (289)	≈ 5.21 (7.76)	-
E4-112-25-	R4-112-25-	<input type="checkbox"/> -0	9.84 (250)	11.89 (302)	≈ 5.26 (7.83)	≈ 6.66 (9.91)
E4-112-26-		<input type="checkbox"/> -0	10.31 (262)	12.36 (314)	≈ 5.30 (7.89)	-
E4-112-27-		<input type="checkbox"/> -0	10.83 (275)	12.87 (327)	≈ 5.34 (7.95)	-
E4-112-28-		<input type="checkbox"/> -0	11.30 (287)	13.35 (339)	≈ 5.37 (7.99)	-
E4-112-30-	R4-112-30-	<input type="checkbox"/> -0	11.81 (300)	13.86 (352)	≈ 5.44 (8.09)	≈ 7.08 (10.53)
E4-112-31-		<input type="checkbox"/> -0	12.28 (312)	14.33 (364)	≈ 5.45 (8.11)	-
E4-112-32-		<input type="checkbox"/> -0	12.79 (325)	14.84 (377)	≈ 5.50 (8.18)	-
E4-112-33-		<input type="checkbox"/> -0	13.27 (337)	15.31 (389)	≈ 5.54 (8.25)	-
E4-112-35-	R4-112-35-	<input type="checkbox"/> -0	13.78 (350)	15.83 (402)	≈ 5.63 (8.38)	≈ 7.51 (11.18)
E4-112-36-		<input type="checkbox"/> -0	14.25 (362)	16.30 (414)	≈ 5.59 (8.32)	-
E4-112-37-		<input type="checkbox"/> -0	14.76 (375)	16.81 (427)	≈ 5.63 (8.38)	-
E4-112-38-		<input type="checkbox"/> -0	15.24 (387)	17.28 (439)	≈ 5.68 (8.46)	-
E4-112-40-	R4-112-40-	<input type="checkbox"/> -0	15.75 (400)	17.80 (452)	≈ 5.80 (8.63)	≈ 7.94 (11.82)
E4-112-41-		<input type="checkbox"/> -0	16.22 (412)	18.27 (464)	≈ 5.77 (8.58)	-
E4-112-42-		<input type="checkbox"/> -0	16.73 (425)	18.78 (477)	≈ 5.89 (8.77)	-
E4-112-43-		<input type="checkbox"/> -0	17.20 (437)	19.25 (489)	≈ 5.83 (8.67)	-
E4-112-45-		<input type="checkbox"/> -0	17.72 (450)	19.76 (502)	≈ 5.97 (8.88)	-
E4-112-46-		<input type="checkbox"/> -0	18.19 (462)	20.24 (514)	≈ 5.95 (8.85)	-
E4-112-47-		<input type="checkbox"/> -0	18.70 (475)	20.75 (527)	≈ 5.96 (8.87)	-
E4-112-48-		<input type="checkbox"/> -0	19.17 (487)	21.22 (539)	≈ 6.07 (9.03)	-
E4-112-50-	R4-112-40-	<input type="checkbox"/> -0	19.69 (500)	21.73 (552)	≈ 6.07 (9.03)	≈ 8.54 (12.71)
E4-112-51-		<input type="checkbox"/> -0	20.16 (512)	22.20 (564)	≈ 6.11 (9.09)	-
E4-112-52-		<input type="checkbox"/> -0	20.67 (525)	22.72 (577)	≈ 6.15 (9.15)	-
E4-112-53-		<input type="checkbox"/> -0	21.14 (537)	23.19 (589)	≈ 6.18 (9.20)	-
E4-112-55-		<input type="checkbox"/> -0	21.65 (550)	23.70 (602)	≈ 6.36 (9.47)	-
E4-112-60-		<input type="checkbox"/> -0	23.62 (600)	25.67 (652)	≈ 6.46 (9.62)	-

Choose from the radii below for all of the above sizes

Radius (mm) Example: E4-112-30-300-0

	200**	250	300	350	400	450	500	550	600	750	1000
<i>R</i>	7.87 (200)	9.84 (250)	11.81 (300)	13.78 (350)	15.75 (400)	19.84 (450)	19.68 (500)	21.65 (550)	23.62 (600)	29.53 (750)	39.37 (1000)
<i>H</i>	21.46 (545)	25.39 (645)	29.33 (745)	33.27 (845)	37.20 (945)	41.14 (1045)	45.08 (1145)	49.02 (1245)	52.95 (1345)	64.76 (1645)	84.45 (2145)
<i>D</i>	16.34 (415)	18.31 (465)	20.27 (515)	22.24 (565)	24.21 (615)	26.18 (665)	28.15 (715)	30.12 (765)	32.09 (815)	37.99 (965)	47.83 (1215)
<i>K</i>	36.02 (915)	42.32 (1075)	48.43 (1230)	54.72 (1390)	60.83 (1545)	66.93 (1700)	75.86 (1860)	79.33 (2015)	85.63 (2175)	104.13 (2645)	135.04 (3430)

0=Standard color black. For other colors see Chapter 1

**200 radius is not available for the e-tubes

PDF: igus.com/e-chain-pdfs
Product information: igus.com/e-chains



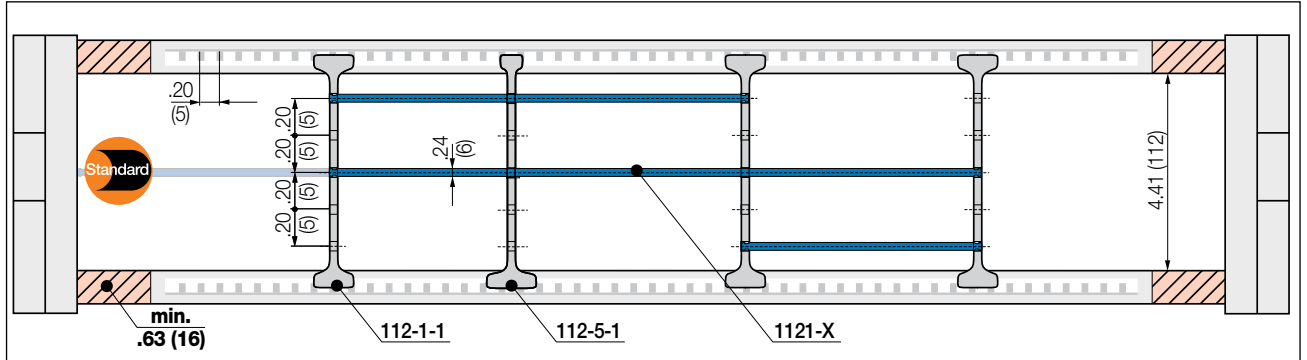

Note Please maintain a lateral spacing of .63" (16 mm) for e-chains® between the separators and the side links. In the standard configuration separators are assembled every 2nd e-chain® link

Telephone 1-800-521-2747

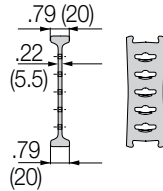

Standard Separator, wide base

Unassembled **Part No. 112-1**
Assembled **Part No. 112-1-1**

- **Standard separator for any application**
Separator with a wide base for maximum holding force in the e-chain®

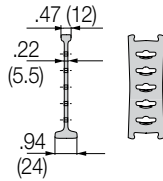

Notched Separator for notched crossbar

Unassembled **Part No. 112-5**
Assembled **Part No. 112-5-1**

- **Locks securely in preset increments**
Notch separator for exact positioning in e-chains®. Recommended for side-mounted applications

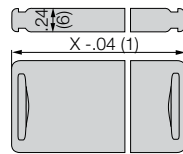

Full-width shelf, lockable

Unassembled **Part No. 1120-X**
Assembled **Part No. 1121-X**

- **Horizontal separation**
Full-width shelf locks securely into separators at both ends, giving a fixed width. Can be used as full-width or partial shelf.

Shelves

Width = X [mm]



Width = X [mm]	X			X			X		
	in. (mm)	unassembled	assembled	in. (mm)	unassembled	assembled	in. (mm)	unassembled	assembled
1.97 (050)	1120-050	1121-050	5.91 (150)	1120-150	1121-150	11.81 (300)	1120-300	1121-300	
2.56 (065)	1120-065	1121-065	6.89 (175)	1120-175	1121-175	13.78 (350)	1120-350	1121-350	
2.95 (075)	1120-075	1121-075	7.87 (200)	1120-200	1121-200	14.76 (375)	1120-375	1121-375	
3.94 (100)	1120-100	1121-100	8.86 (225)	1120-225	1121-225	15.24 (387)	1120-387	1121-387	
4.92 (125)	1120-125	1121-125	9.84 (250)	1120-250	1121-250	17.72 (450)	1120-450	1121-450	

e-chain system® E4-1
 Series R4-112
 Interior Separation - Only for e-tubes



E4-112
 R4-112

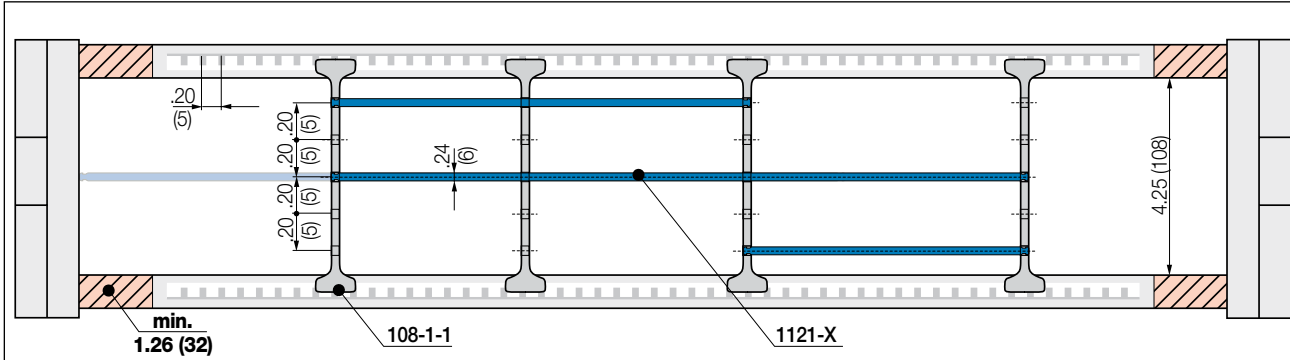

Note Please maintain a lateral spacing of 1.26" (32 mm) for e-tube between the separators and the side links. In the standard configuration separators are assembled every 2nd e-chain® link

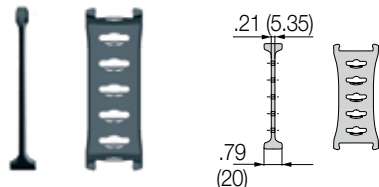

**Notched Separator
 for notched crossbar**

Unassembled	Part No. 108-1
Assembled	Part No. 108-1-1

- **Standard separator for any application**
 For a vertical subdivision. Offers safe stability due to its wide base design, also when used with thick cables or hoses

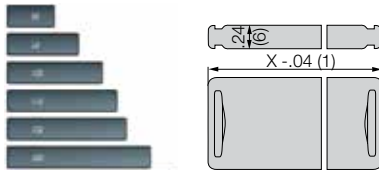

Full-width shelf, lockable

Unassembled	Part No. 1120-X
Assembled	Part No. 1121-X

- **Horizontal separation**
 Full-width shelf locks securely into separators at both ends, giving a fixed width. Can be used as full-width or partial shelf.

Shelves

Width = X [mm]



X in. (mm)	unassembled	assembled	X in. (mm)	unassembled	assembled	X in. (mm)	unassembled	assembled
1.97 (050)	1120-050	1121-050	5.91 (150)	1120-150	1121-150	11.81 (300)	1120-300	1121-300
2.56 (065)	1120-065	1121-065	6.89 (175)	1120-175	1121-175	13.78 (350)	1120-350	1121-350
2.95 (075)	1120-075	1121-075	7.87 (200)	1120-200	1121-200	14.76 (375)	1120-375	1121-375
3.94 (100)	1120-100	1121-100	8.86 (225)	1120-225	1121-225	15.24 (387)	1120-387	1121-387
4.92 (125)	1120-125	1121-125	9.84 (250)	1120-250	1121-250	17.72 (450)	1120-450	1121-450



Compact design, custom configuration: two nested E4-112 e-chains® each around 39.4 ft. (12m) long carry very heavy fill weights

PDF: igus.com/e-chain-pdfs
 Product information: igus.com/e-chains



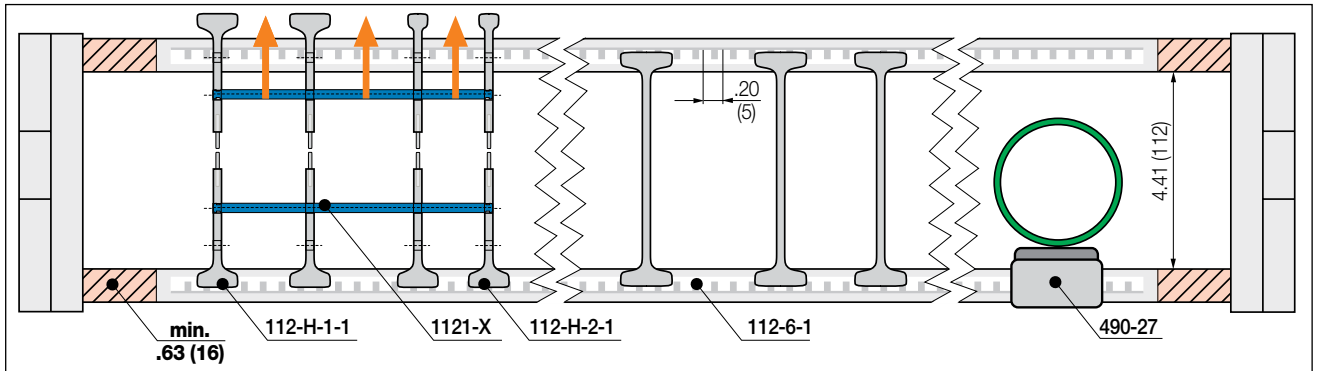

Note Please maintain a lateral spacing of 1.57" (40 mm) for e-tube and .63" (16 mm) for e-chains® between the separators and the side links. In the standard configuration separators are assembled every 2nd e-chain® link

Telephone 1-800-521-2747

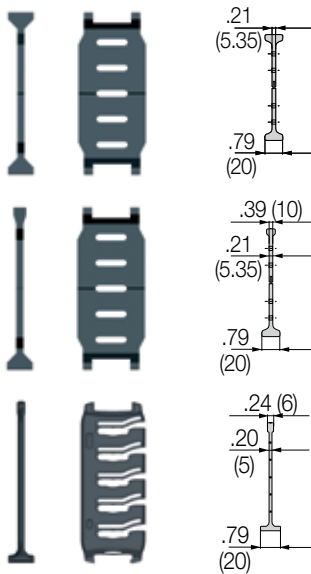

Separator, wide base

Unassembled Part No. 112-H-1
Assembled Part No. 112-H-1-1

Separator, narrow head

Unassembled Part No. 112-H-2
Assembled Part No. 112-H-2-1

Lean separator

Unassembled Part No. 112-12
Assembled Part No. 112-12-1



● **Split separators for all applications**

In order to fill e-chains® more easily and effectively, these separators can be split in the middle. This allows easier access to middle shelf partitions. Fast assembly and easy retrofit. 2 types available: with wide or narrow top.

● **Lean separators 112-12**

New design allows extremely fast fitting of shelves in several layers, which significantly reduces assembly time. Enables extremely fast replacement of individual cables in a very full e-chain®.

● **Lean separator design - several layers of cables fitted quickly, save up to 50%* assembly time**

(*Lean separator vs. standard separator - measured on a 4m long e-chain® fitted with 12 cables in the igus® harnessing factory)

More interior separation options

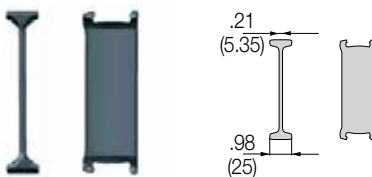

Notch locking separator

Unassembled Part No. 112-6
Assembled Part No. 112-6-1

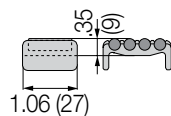

Rollclip* for e-chains®

Unassembled Part No. 489-27
Assembled Part No. 490-27

● **Notch locking separator for increased holding force**

Notch locking separators offer higher crossbar opening forces for high humidity and/or large hydraulic hoses. They can be positioned precisely and then locked in position.

● **Rollclip***

Minimizes abrasion of sensitive hoses. Simply clamps onto the opening crossbar. The movable rollers compensate for relative movement between the e-chain® and hose.

*Only for e-chains®

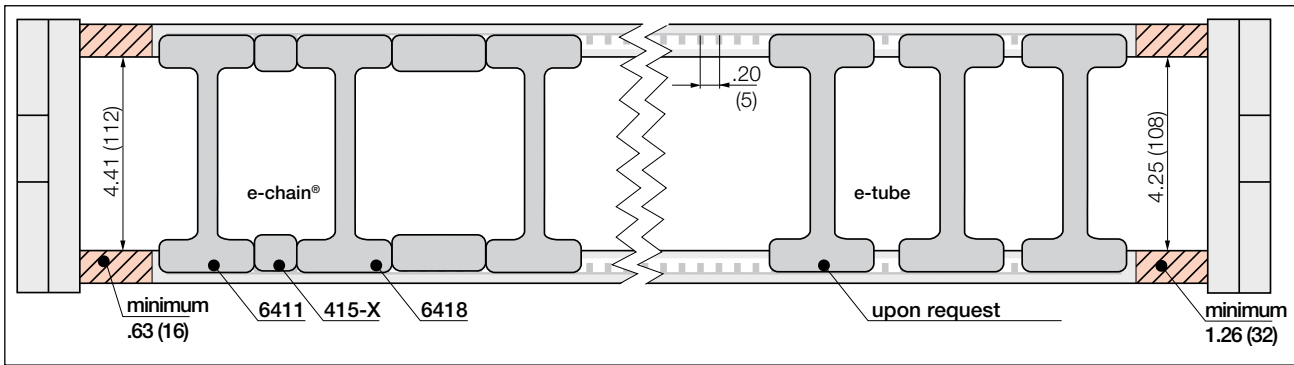

Note Please maintain a lateral spacing of 1.26" (32 mm) for e-tube and .63" (16 mm) for e-chains® between the separators and the side links. In the standard configuration separators are assembled every 2nd e-chain® link

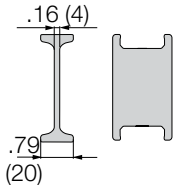

Separator (chain only)

Unassembled	Part No. 6401
Assembled	Part No. 6411

- **Standard separator 6401 for e-chains®**
 For a vertical subdivision. Offers safe stability due to its wide base design, also when used with thick cables or hoses (Separator for e-tubes 1608 upon request)

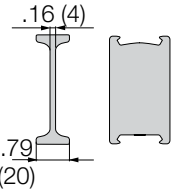

Separator, locking (chain only)

Unassembled	Part No. 6408
Assembled	Part No. 6418

- **Separator 6408 for e-chains®**
 For applications exposed to very high humidity (>85%). Locks with extra retention force. Tip: one locking separator per e-chain® link for better mounting.

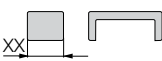

Spacer (chain only)

Unassembled	Part No. 405-XX
Assembled	Part No. 415-XX

- **NOTE ON SPACERS for e-chains®**
 Vertical separators are adjustable, but can be fixed in position by means of a spacer. Spacers are most often necessary for side mounted applications. The available inner height is reduced by .08" (2mm) **per spacer** (for example if one spacer is placed on either side of the separator, the overall inner height is reduced by .16" (4mm)). To avoid this, place the spacers on the **outside** of the opening crossbar (**not for long travels**).

XX = width of the spacer

Spacers available in the following sizes:

Part No. Unassembled	Part No. Assembled	Width	
		in.	(mm)
405 -10	415 -10	.39"	(10)
405 -15	415 -15	.59"	(15)
405 -20	415 -20	.79"	(20)
405 -30	415 -30	1.18"	(30)
405 -40	415 -40	1.57"	(40)



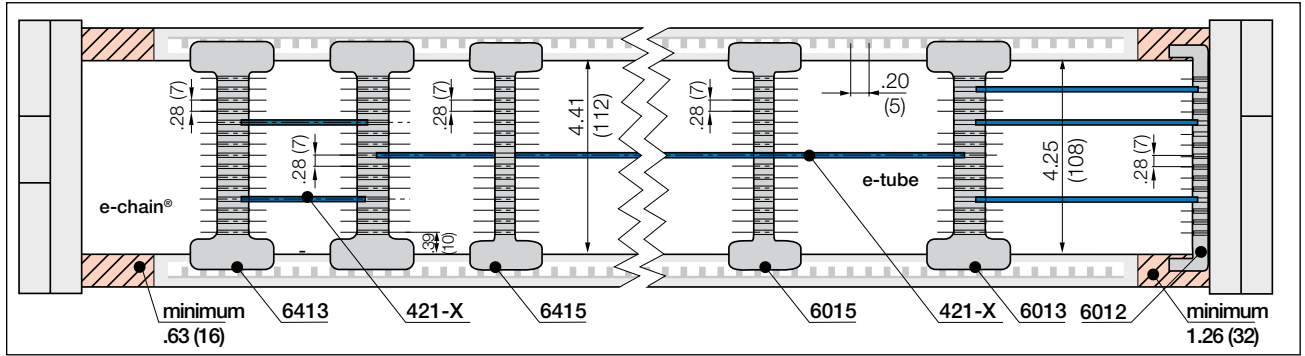

Note Please maintain a lateral spacing of 1.26" (32 mm) for e-tube and .63" (16 mm) for e-chains® between the separators and the side links. In the standard configuration separators are assembled every 2nd e-chain® link

Telephone 1-800-521-2747

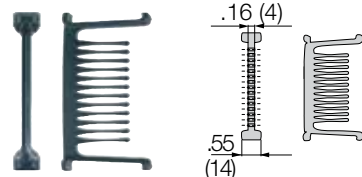

Slotted separator, open (e-chains®)
Unassembled Part No. 6405
Assembled Part No. 6415

- **Open, slotted separator 6405**
For e-chains® (unilateral open)
This separator can be retrofitted into an existing interior separation system without removing the shelves. The top and bottom botches cannot be occupied by shelves

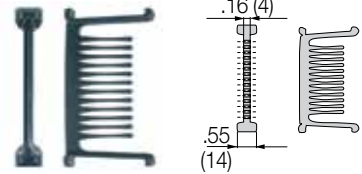

Slotted separator, open (e-tubes)
Unassembled Part No. 6005
Assembled Part No. 6015

- **Open, slotted separator 6005**
For e-tubes (unilateral open)
This separator can be retrofitted into an existing interior separation system without removing the shelves. The top and bottom botches cannot be occupied by shelves

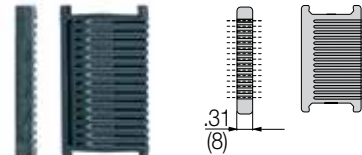

Vertical separator (e-chains®)
Unassembled Part No. 6403
Assembled Part No. 6413

- **Vertical separator 6403**
For e-chains®
This component is used to form the basic pattern of a shelf system. The shelf 420-X can be installed at 15 different heights in .28" (7 mm) increments

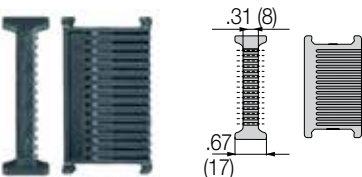

Vertical separator, locking (e-tubes)
Unassembled Part No. 6003
Assembled Part No. 6013

- **Locking vertical separator 6003**
For e-tubes
This component is used to form the basic pattern of a shelf system.

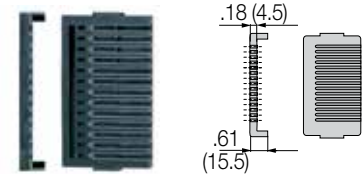

Side plate
Unassembled Part No. 6002
Assembled Part No. 6012

- **Side plate 6002**
For e-chains® / Tubes
This component is used to form the basic pattern of a shelf system. Allows modular shelving close to the side links.

Full-width shelves - for the standard interior separation

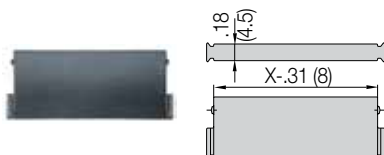

Full width shelf
Unassembled Part No. 420-X
Assembled Part No. 421-X

- **Full width shelf 420-X**
These components form the basic pattern of a shelf system. Shelves of various widths can be arranged at 7 different heights in .28" (7mm) increments

Width X	Part No.	Part No.	Width X	Part No.	Part No.	Width X	Part No.	Part No.
in. (mm)	Unassembled	Assembled	in. (mm)	Unassembled	Assembled	in. (mm)	Unassembled	Assembled
.71 (18)	420-18	421-18	1.97 (50)	420-50	421-50	5.91 (150)	420-150	421-150
.91 (23)	420-23	421-23	2.44 (62)	420-62	421-62	6.89 (175)	420-175	421-175
.98 (25)	420-25	421-25	2.95 (75)	420-75	421-75	7.36 (187)	420-187	421-187
1.10 (28)	420-28	421-28	3.46 (88)	420-88	421-88	7.87 (200)	420-200	421-200
1.30 (33)	420-33	421-33	3.94 (100)	420-100	421-100			
1.69 (43)	420-43	421-43	4.92 (125)	420-125	421-125			

e-chain system® E4-1 Series E4-112/R4-112 Mounting Bracket - Steel



E4-112
R4-112

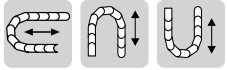

Option 2: Locking

- For vertical hanging and vertical standing applications
- One part for all chain widths
- Electrically conductive

Option 1: pivoting

- For unsupported and gliding applications
- One part for all chain widths
- Electrically conductive

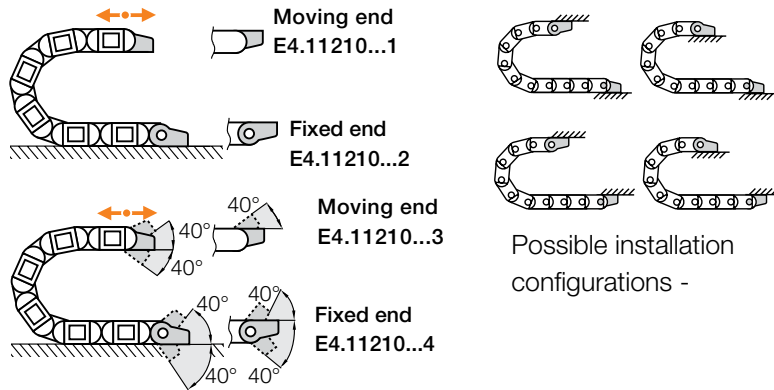

Possible installation configurations -

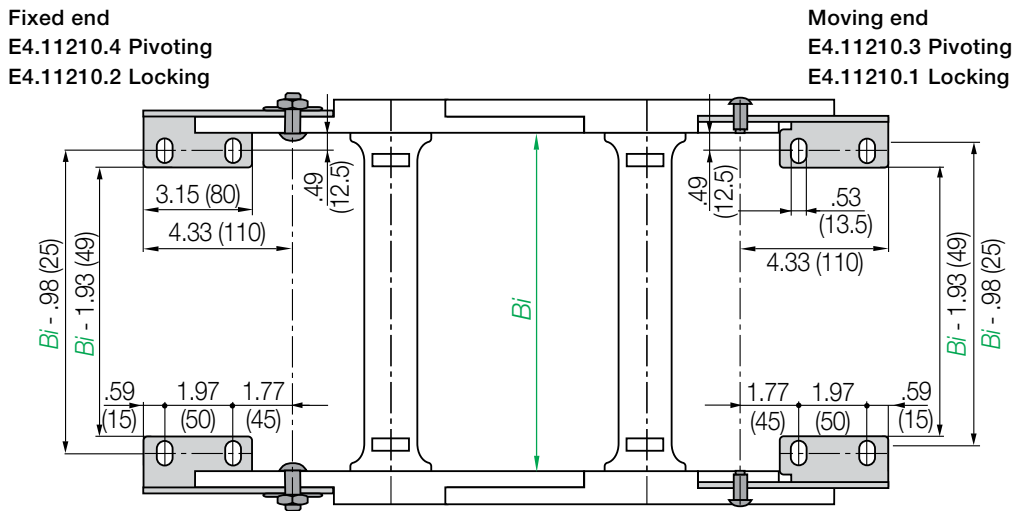

Part No. full set	Description
steel locking	mounting bracket
E4.11210.112VS	Full set (both ends), For a chain with an odd number of links
E4.11210.212VS	Full set (both ends), For a chain with an even number of links
steel pivoting	mounting bracket
E4.11210.134VS	Full set (both ends), For a chain with an odd number of links
E4.11210.234VS	Full set (both ends), For a chain with an even number of links

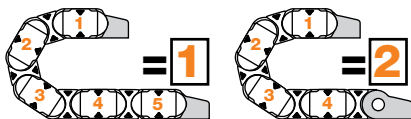

Note: Depending on the chain length, the e-chain® may end with either an outer or an inner side link. For the best appearance, make sure the e-chain® ends with outer side links whenever possible. (with odd number of links)

PDF: igus.com/e-chain-pdfs
Product information: igus.com/e-chains



Strain relief such as clamps, tiwrap plates, nuggets and plug-in clips are available from stock.
The complete chainfix range with ordering options ► Chapter 10



Part number example for e-chain®

E4-112-10/20/10-200-0

E4-112-*Bi1/Bi2/Bi3*-R-0



Extension links - for extremely wide e-chains® up to 9.84 ft (3m)

- For applications in which particularly high fill weights necessitate extremely wide e-chains®
- The extension link design allows virtually limitless side-by-side attachment of chains
- The unsupported length of a chain can be increased when additional loads are required
- Extension links can be used with e-chains®, e-tubes or a combination of both
- They are suitable for unsupported and gliding applications in a guide trough
- e-chains® with extension links are attached with steel mounting brackets.

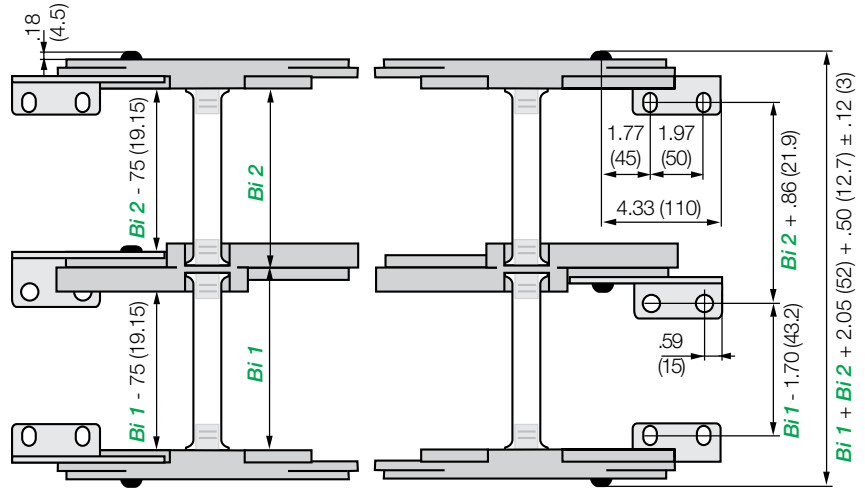

We **strongly recommend** on-site consultation with an igus® technician for individual advice regarding mounting brackets, guide troughs and other design details.

Extender crossbars - For careful guiding of large diameter cables and hoses

- Intended for cables and hoses with a maximum outer diameter of 11.81 in. (300 mm).
- Can be attached along either the inner or outer radius, inner radius preferred
- Gliding operation with crossbars assembled along the outer radius in conjunction with a special guide trough
- Gliding operation not guaranteed with crossbars assembled along the inner radius
- The extender crossbar can either be attached to the side links directly or can be used in combination with two standard snap-open crossbars.



Consult igus® for your extender crossbar applications. We will be happy to assist you with your design layout.

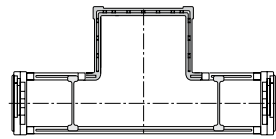

Square extender crossbar combined with standard snap-open crossbars.

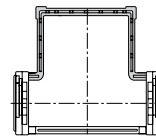

Attached directly to the side link.

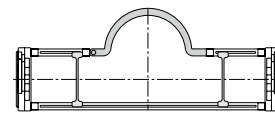

Round extender crossbar combined with standard snap-open crossbars.

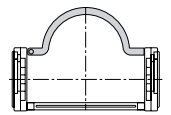

Attached directly to the side link.

Part No.	Max Ø Hose	Style	Installation Side Link	Combined with Snap-Open Crossbars
450-15-RHD115	4.53 (115)	Round	No	Yes
450-17-RD115	4.53 (115)	Round	Yes	No
450-25-D150	5.91 (150)	Square	Yes	No
450-30-D200	7.87 (200)	Square	Yes	No
450-35-D250	8.66 (220)	Square	Yes	No
450-40-D300	10.63 (270)	Square	Yes	No
450-20-HD150	5.91 (150)	Square	No	Yes
450-25-HD200	7.87 (200)	Square	No	Yes
450-30-HD250	8.66 (220)	Square	No	Yes

Chainfix clamps for the profile rail

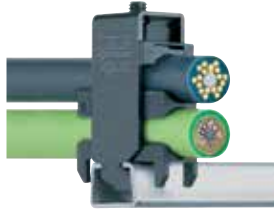

For more information please refer to strain relief section of Chapter 10.

igus® Chainfix strain relief elements are available in either steel or stainless steel. They can be adjusted with a hexagon socket and are available in single, double and triple configurations.

Part No. Single Clamp		Part No. Double Clamp		Part No. Triple Clamp		Cable ø	
Steel	Stainless	Steel	Stainless	Steel	Stainless	in.	(mm)
CFX12-1	CFX12-1E	CFX12-2	CFX12-2E	CFX12-3	–	.24 - .47	(6 - 12)
CFX14-1	CFX14-1E	CFX14-2	CFX14-2E	CFX14-3	–	.47 - .55	(12 - 14)
CFX16-1	CFX16-1E	CFX16-2	CFX16-2E	CFX16-3	–	.55 - .63	(14 - 16)
CFX18-1	CFX18-1E	CFX18-2	CFX18-2E	CFX18-3	–	.63 - .71	(16 - 18)
CFX20-1	CFX20-1E	CFX20-2	CFX20-2E	CFX20-3	–	.71 - .79	(18 - 20)
CFX22-1	CFX22-1E	CFX22-2	CFX22-2E	CFX22-3	–	.79 - .87	(20 - 22)
CFX26-1	CFX26-1E	CFX26-2	CFX26-2E	–	–	.87 - 1.02	(22 - 26)
CFX30-1	CFX30-1E	CFX30-2	CFX30-2E	–	–	1.02 - 1.18	(26 - 30)
CFX34-1	CFX34-1E	CFX34-2	CFX34-2E	–	–	1.18 - 1.34	(30 - 34)
CFX38-1	CFX38-1E	–	–	–	–	1.34 - 1.50	(34 - 38)
CFX42-1	CFX42-1E	–	–	–	–	1.50 - 1.65	(38 - 42)

Tiewrap Plates

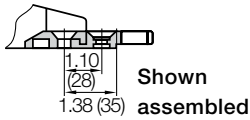

Shown assembled

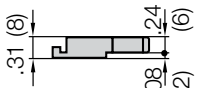

Single tiewrap plate

**Option 1:
Tiewrap plates as an individual part**

Available as an individual component, can be fixed onto a mounting bracket with the use of a profile rail.

Tiewrap Plate	n Number of Teeth	C Overall Width in. (mm)	B Bore Width in. (mm)	Center Bore
3050-ZB	5	1.97 (50)	1.18 (30)	no
3075-ZB	7	2.95 (75)	2.16 (55)	no
3100-ZB	10	3.94 (100)	3.15 (80)	no
3115-ZB	11	4.53 (115)	3.74 (95)	no
3125-ZB	12	4.92 (125)	4.13 (105)	no
3150-ZB	15	5.91 (150)	5.12 (130)	no
3175-ZB	17	6.89 (175)	6.10 (155)	no
3200-ZB	20	7.87 (200)	7.09 (180)	yes
3225-ZB	22	8.86 (225)	8.07 (205)	yes
3250-ZB	25	9.84 (250)	9.06 (230)	yes

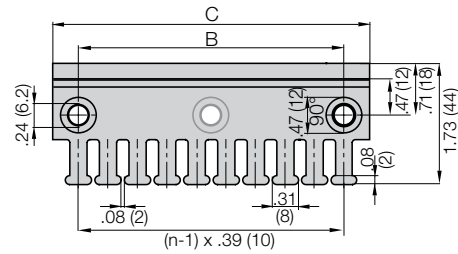

If used with KMA brackets with profile rail please add "KMA" to the end of the part number.

Example: 3050-ZBKMA

For more information please refer to strain relief section of Chapter 10.

**Option 2:
Clip-on Tiewrap plates**

Available as a clip-on tiewrap plate without the use of bolts They are inserted and removed with a screwdriver used as a lever. Clip-on tiewrap plates are also available as an attachment to the opening crossbars.



Part No.	Number of Teeth	Width of Strain Relief in. (mm)
3050-ZC	5	1.97 (50)
3075-ZC	7	2.95 (75)

For more information please refer to strain relief section of Chapter 10.

**Option 3:
Clip-on Tiewrap plates for opening crossbars**

Clip-on tiewrap plates are also available as an attachment to opening crossbars. They can be positioned at any point along the e-chain®.

Part No.	Number of Teeth	Width of Strain Relief in. (mm)
4550-ZS	5	1.89 (48)
4575-ZS	7	2.91 (74)

For more information please refer to strain relief section of Chapter 10.

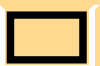

Width of Crossbar
E4-112-12-300-0

	B_{Ri}	Installation Part No.
-05	4.21 (107)	97-50-225
-06	4.80 (122)	97-50-225
-07	5.20 (132)	97-50-250
-10	6.18 (157)	97-50-275
-11	6.65 (169)	97-50-275
-12	7.17 (182)	97-50-300
-13	76.38 (194)	97-50-300
-15	8.15 (207)	97-50-325
-16	8.62 (219)	97-50-325
-17	9.13 (232)	97-50-350
-18	9.61 (244)	97-50-350
-20	10.12 (257)	97-50-375
-21	10.59 (269)	97-50-375
-22	11.10 (282)	97-50-400
-23	11.57 (294)	97-50-400
-25	12.09 (307)	97-50-425
-26	12.56 (319)	97-50-425
-27	13.07 (332)	97-50-450
-28	13.54 (344)	97-50-450
-30	14.06 (357)	97-50-475
-31	14.53 (369)	97-50-475
-32	15.04 (382)	97-50-500
-33	15.51 (394)	97-50-500
-35	16.02 (407)	97-50-525
-36	16.50 (419)	97-50-525
-37	17.01 (432)	97-50-550
-38	17.48 (444)	97-50-550
-40	17.99 (457)	97-50-575
-41	18.46 (469)	97-50-575
-42	18.98 (482)	97-50-600
-43	19.45 (494)	97-50-600
-45	19.96 (507)	97-50-625
-46	20.43 (519)	97-50-625
-47	20.94 (532)	97-50-650
-48	21.42 (544)	97-50-650
-50	21.93 (557)	97-50-675
-51	22.40 (569)	97-50-675
-52	22.91 (582)	97-50-700
-53	23.39 (594)	97-50-700
-55	23.90 (607)	97-50-725
-60	25.87 (657)	97-50-775

Guide troughs are used with applications where the upper run of the e-chain® glides on the lower run. If using igus® steel guide troughs, the following components are required:

- Full travel length of guide trough
Part No. 97-30
- 1/2 travel length glide bars
Part No. 93-01
- Installation sets as end connectors
Part No. 97-50-XX

-XX indicates the length of the profile rails on which the guide trough is mounted. The values and part numbers are specified in the table on the left. The standard length of the trough components and glide bars is 6.56 ft (2 m). The overall length of the guide trough directly correlates to the length of travel.

Example:

Length of travel 164 ft (50 m)
Center-mounted

Required guide troughs:

164 ft (50 m) guide trough, 82 ft. (25 m) glide bar
= 25 sections of 6.56 ft (2 m) guide trough

Part No. 97-30

= 13 sections of 6.56 ft (2 m) glide bar

Part No. 93-01

Required number of installation set:

= Number of guide trough components + 1
= 25 + 1 = 26

Part No. of the installation sets **97-50-XXX**

Example:

97-50-400 for 15.75 (400 mm) long profile rail



Left: Guide trough with glide bars
Right: Guide troughs without glide bars

Installation sets as section connectors

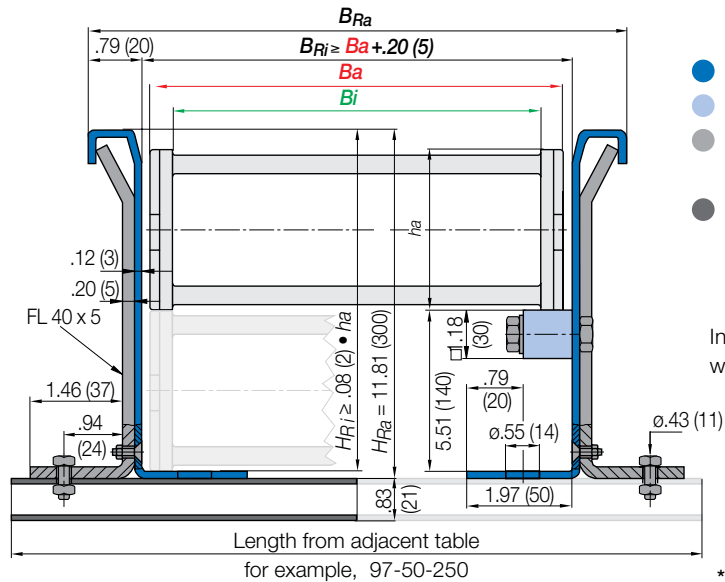

- Guide trough
- Glide bars
- Installation set "Basic"
- Profile rail

Individual attachment without profile rail

* Specialized guide trough available upon request

Standard length profile rail

PDF: igus.com/e-chain-pdfs
Product information: igus.com/e-chains



Price Index

Series E4-162

Special Options Available

Low noise version available with special rubber pads



Cleanroom test upon request



ESD classification:
Electrically conductive ESD/
ATEX version upon request

Assembly Tips



Opening e-chains®: Remove crossbars and clips - Insert screwdriver into the slot, push down, release by lever action



Also available without cambar.
Add NCST to the end of the part number.
Ex: E4-162-30-300NCST

Features & Benefits

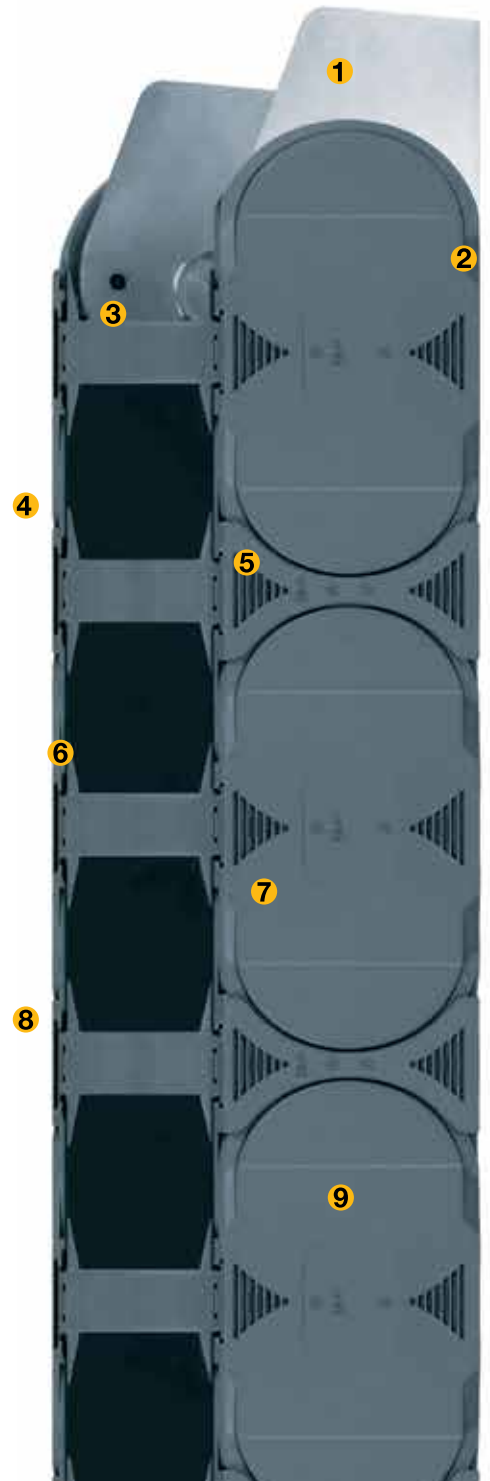
- 1 Steel mounting brackets
- 2 Hinged, snap-open removable lids along the outer radius
- 3 Noise dampening pads, optional = -10dB(A)
- 4 Gliding surfaces, long travels
- 5 Chip protection with e-tube
- 6 Undercut for more stability
- 7 Notch crossbar with backside scaling
- 8 Straight run due to the inner/outer link design
- 9 Low noise operation due to integrated "brake"

Other Installation Methods

Vertical, hanging ≤ 394 ft (120 m)

Vertical, standing ≤ 19.69 ft (6 m)

Side-mounted, un_supp. upon request

Rotary requires further calculation

Usage Guidelines

- If a robust e-chain/Energy is required
- If inner widths up to 23.62" (600 mm) are required
- For unsupported lengths up to 21.3 ft. (6.5 m) and fill weights up to 60.48 lbs/ft. (90 kg/m)
- For long travels



- When an e-chain is needed for rough applications with greater inner height
 - Series 800
- When a lighter e-chain® is needed
 - Series 1640

Order Example: Complete e-chain®

Please indicate chain length or number of links. Example:

16.4 ft (5 m) **E4-162-30-300-0**



e-chain®

With 2 separators **162.1.1** assembled every 2nd link



Interior Separation

1 Set **E4-16210-12**



Mounting Bracket

e-chain system® E4-1

Series E4-162

Installation Dimensions

Short travel, unsupported length

- FL_B = unsupported with permitted sag
 - FL_G = unsupported with straight upper run
- Further information ► Design, Chapter 1

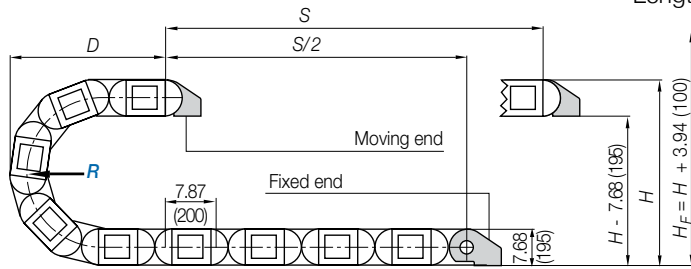
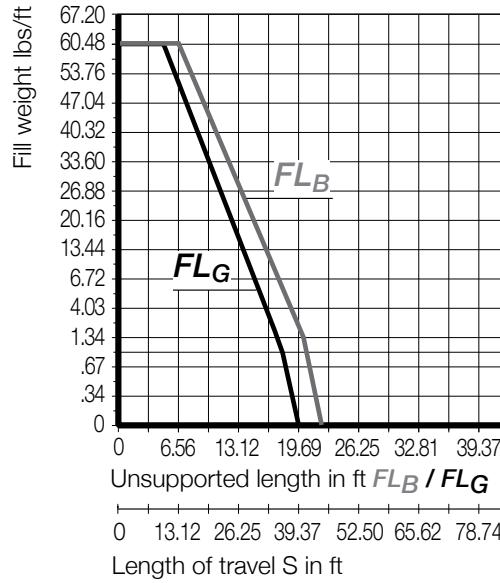
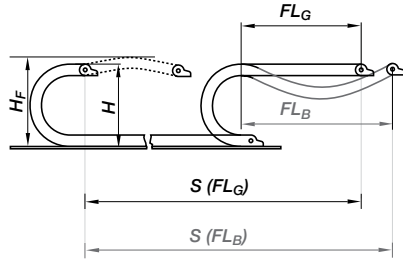

Pitch per link = 7.87" (200 mm)
 Links per ft (m) = 1.52 (5)
 For center mount applications:
 Chain length = $\frac{S}{2} + K$

The required clearance height: $H_F = H + 3.94$ in. (100 mm) with 3.36 lbs/ft (5 kg/m) fill weight.
 Please consult igus® if space is particularly restricted.

R	9.84 (250)	11.81 (300)	13.78 (350)	15.75 (400)	9.84 (450)	19.68 (500)	21.65 (550)	23.62 (600)	29.53 (750)	39.37 (1000)
H	27.56 (700)	31.50 (800)	35.43 (900)	39.37 (1000)	43.31 (1100)	47.24 (1200)	51.18 (1300)	55.12 (1400)	66.93 (1700)	86.61 (2200)
D	25.51 (648)	27.48 (698)	29.45 (748)	31.42 (798)	33.39 (848)	35.35 (898)	37.32 (948)	39.29 (998)	45.20 (1148)	55.04 (1398)
K	46.85 (1190)	52.95 (1345)	59.06 (1500)	65.35 (1660)	71.46 (1815)	77.76 (1975)	83.86 (2130)	89.96 (2285)	108.66 (2760)	139.57 (3545)

For long travels with lowered mounting height

Long travel lengths from 45.9 ft.(14m) to max. 1,476 ft. (450m)

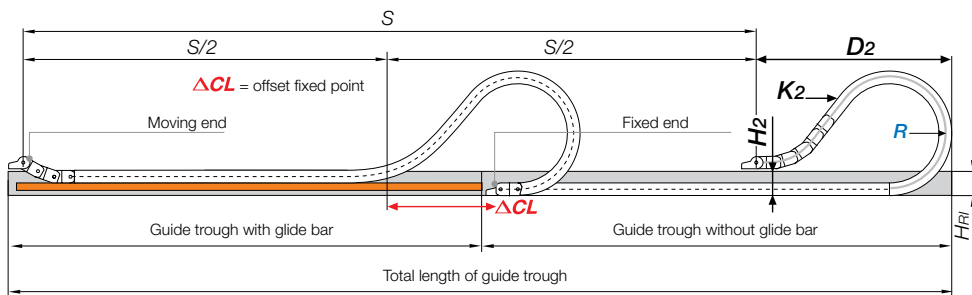

For center mount applications:
 Chain length = $\frac{S}{2} + K_2$

Long Travels - Gliding



If the unsupported length is exceeded, the e-chain®/ Tube must glide on itself. This requires a guide trough.

Design, Chapter 1

R	9.84 (250)	11.81 (300)	13.78 (350)	15.75 (400)	9.84 (450)	19.68 (500)	21.65 (550)	23.62 (600)	29.53 (750)	39.37 (1000)
H ₂	*	22.83 (580)	22.83 (580)	22.83 (580)	22.83 (580)	22.83 (580)	22.83 (580)	22.83 (580)	**	**
D ₂	*	37.40 (950)	41.34 (1050)	53.15 (1350)	62.99 (1600)	76.77 (1950)	80.71 (2050)	94.49 (2400)	**	**
K ₂	*	62.99 (1600)	70.87 (1800)	94.49 (2400)	110.24 (2800)	125.98 (3200)	133.86 (3400)	149.61 (3800)	**	**
ΔCL	*	11.81 (300)	13.78 (350)	23.62 (600)	31.50 (800)	43.31 (1100)	45.28 (1150)	57.09 (1450)	**	**

In case of travels between 39.4 and 45.9 ft (12 and 14 m) we recommend a longer unsupported length.

Speed / acceleration FL_G	max. 65.6 ft/s (20 m/s) / max. 656 ft/s ² (200 m/s ²)
Speed / acceleration FL_B	max. 9.84 ft/s (3 m/s) / max. 19.69 ft/s ² (6 m/s ²)
Gliding speed / acceleration (maximum)	max. 32.8 ft/s (10 m/s) / max. 164 ft/s ² (50 m/s ²)
Material - permitted temperature	igumid G / -40°F (-40°C) up to +248°F (+120°C)
Flammability Class, igumid G	VDE 0304 IIC UL94 HB

Technical Data



Details of material properties

► Chapter 1



E4-162



Short Travels - Unsupported

Unsupported e-chains® feature positive camber over short travels. This must be accounted for when specifying the clearance height. Please refer to **Installation dimensions** for further details.

Legend

- S = Length of travel
 - R = Bending radius
 - H = Nominal clearance height
 - D = Overlength e-chain® radius in final position
 - $K = \pi \cdot R + \text{ safety buffer}$
 - H_F = Required clearance height
 - H_{RI} = Trough inner height
 - H₂ = *Mounting height
 - D₂ = Overlength - long travels, gliding
 - K₂ = *Add-on
- *If the mounting bracket location is set lower

PDF: igus.com/e-chain-pdfs
 Product information: igus.com/e-chains



6.104

Series E4-112 - e-chain® with crossbars every link

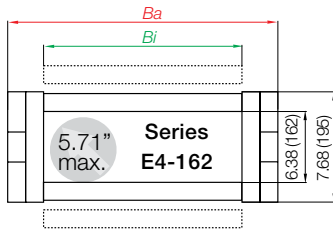

- Crossbars every link
- For use with rigid hydraulic hoses
- For particularly demanding applications
- Can be opened from both sides

Part Number Structure

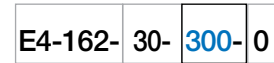

- Color - Black
- Bending radius
- Width
- Series



e-chain® as separate parts, links and side plates

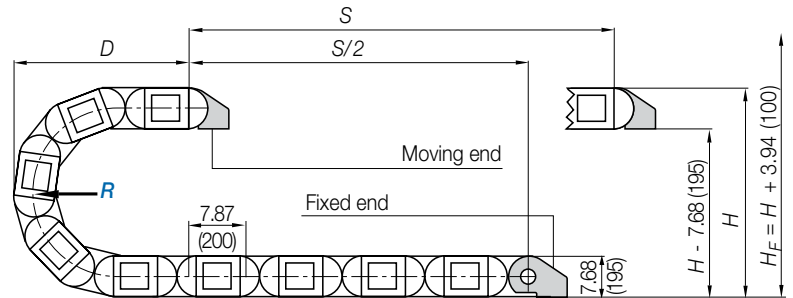
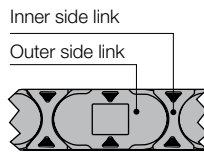
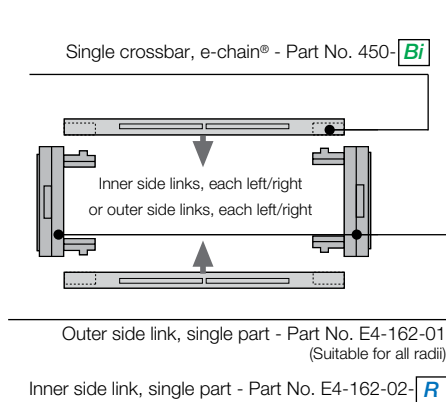

Telephone 1-800-521-2747

Supplement part number with required radius. Example: E4-162-30-300-0
Pitch: 7.87 in. (200mm) per link links/ft (m) = 1.52 (5)

Part Number	Crossbars Every link	Bi in. (mm)	Ba in. (mm)	Weight E4-112 lbs/ft (kg/m)
E4-162-20-		7.87 (200)	10.08 (256)	≈ 7.02 (10.45)
E4-162-25-		9.84 (250)	12.05 (306)	≈ 7.22 (10.74)
E4-162-30-		11.81 (300)	14.02 (356)	≈ 7.38 (10.99)
E4-162-32-		12.79 (325)	15.00 (381)	≈ 7.41 (11.02)
E4-162-35-		13.78 (350)	15.98 (406)	≈ 7.53 (11.21)
E4-162-40-		15.75 (400)	17.95 (456)	≈ 7.73 (11.51)
E4-162-45-		17.72 (450)	19.92 (506)	≈ 7.82 (11.65)
E4-162-50-		19.69 (500)	21.89 (556)	≈ 7.95 (11.83)
E4-162-55-		21.65 (550)	23.86 (606)	≈ 8.14 (12.11)
E4-162-60-		23.62 (600)	25.83 (656)	≈ 8.37 (12.45)

Choose from the radii below for all of the above sizes

Radius (mm) Example: E4-162-30-300-0

	250	300	350	400	450	500	550	600	750	1000
R	9.84 (250)	11.81 (300)	13.78 (350)	15.75 (400)	19.68 (500)	21.65 (550)	23.62 (600)	29.53 (750)	39.37 (1000)	
H	27.56 (700)	31.50 (800)	35.43 (900)	39.37 (1000)	43.31 (1100)	47.24 (1200)	51.18 (1300)	55.12 (1400)	66.93 (1700)	86.61 (2200)
D	25.51 (648)	27.48 (698)	29.45 (748)	31.42 (798)	33.39 (848)	35.35 (898)	37.32 (948)	39.29 (998)	45.20 (1148)	55.04 (1398)
K	46.85 (1190)	52.95 (1345)	59.06 (1500)	65.35 (1660)	71.46 (1815)	77.76 (1975)	83.86 (2130)	89.96 (2285)	108.66 (2760)	139.57 (3545)

0=Standard color black. For other colors see Chapter 1

Internet: igus.com
email: sales@igus.com
QuickSpec: igus.com/quickspec

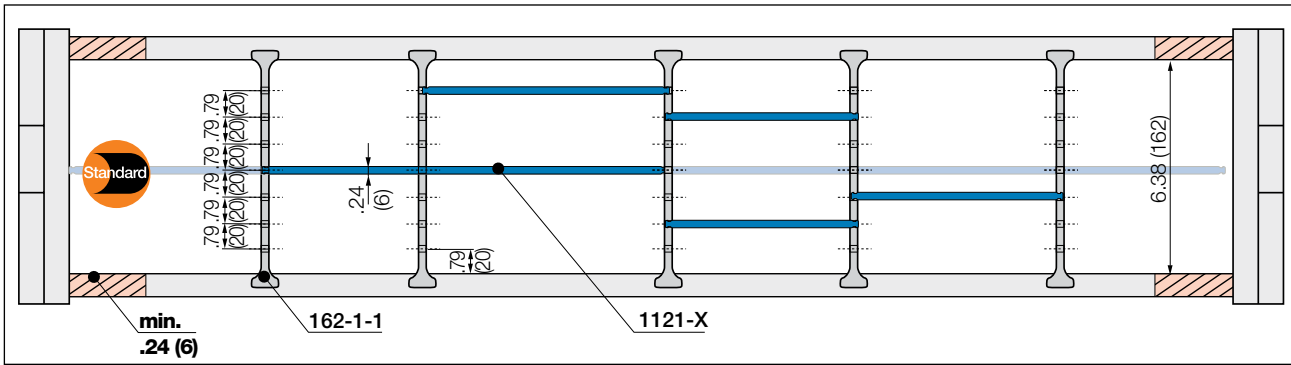

Note Please maintain a lateral spacing of .24" (6 mm) for e-chains® between the separators and the side links. In the standard configuration separators are assembled every 2nd e-chain® link

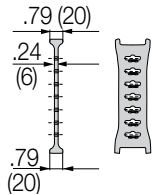

Standard Separator, wide base

Unassembled	Part No. 162-1
Assembled	Part No. 162-1-1

- **Standard separator for any application**
 Separator with a wide base for maximum holding force in the e-chain®

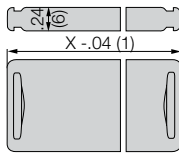

Full-width shelf, lockable

Unassembled	Part No. 1120-X
Assembled	Part No. 1121-X

- **Horizontal separation**
 Full-width shelf locks securely into separators at both ends, giving a fixed width. Can be used as full-width or partial shelf.

Shelves

Width = X [mm]



X in. (mm)	unassembled	assembled	X in. (mm)	unassembled	assembled	X in. (mm)	unassembled	assembled
1.97 (050)	1120-050	1121-050	5.91 (150)	1120-150	1121-150	11.81 (300)	1120-300	1121-300
2.56 (065)	1120-065	1121-065	6.89 (175)	1120-175	1121-175	13.78 (350)	1120-350	1121-350
2.95 (075)	1120-075	1121-075	7.87 (200)	1120-200	1121-200	14.76 (375)	1120-375	1121-375
3.94 (100)	1120-100	1121-100	8.86 (225)	1120-225	1121-225	15.24 (387)	1120-387	1121-387
4.92 (125)	1120-125	1121-125	9.84 (250)	1120-250	1121-250	17.72 (450)	1120-450	1121-450



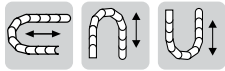

Option 1: pivoting

- For unsupported and gliding applications
- One part for all chain widths
- Electrically conductive

Option 2: Locking

- For vertical hanging and vertical standing applications
- One part for all chain widths
- Electrically conductive

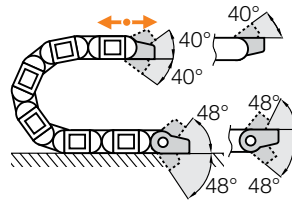

Moving end
 E4-16210...3

Fixed end
 E4-16210...4

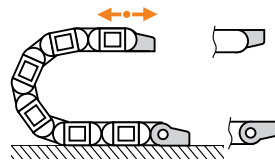
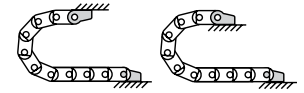

Moving end
 E4-16210...1

Fixed end
 E4-16210...2

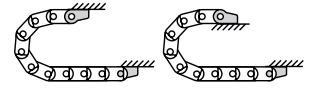

Possible installation configurations -

Fixed end
 E4-11210-4 Pivoting
 E4-11210-2 Locking

Moving end
 E4-11210-3 Pivoting
 E4-11210-1 Locking

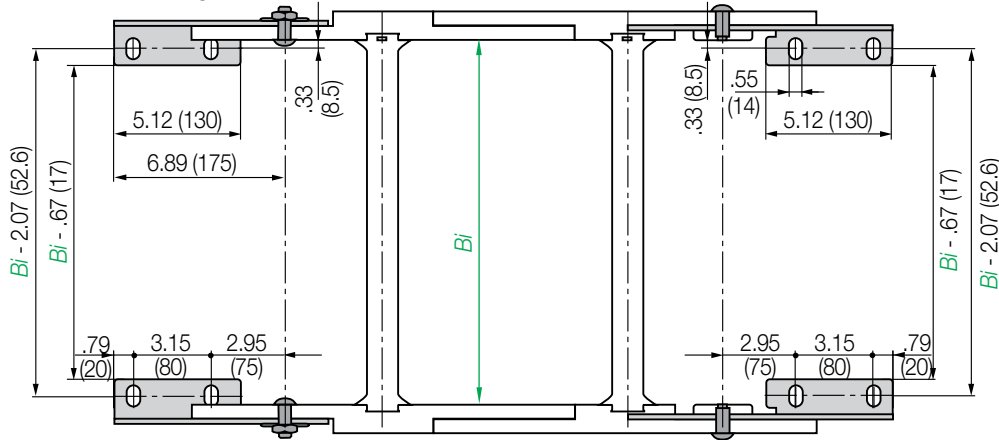

Part No. full set	Description
steel pivoting	mounting bracket

E4-16210-□-34-VS-E Full set (both ends), ending with outer side link, **screwed** - standard

E4-16210-□-34-VS-E Full set (both ends) - beginning with outer side link (moving end) - ending with inner side link (fixed end), **screwed** - standard

Stainless steel version available. Please add index **-E** (Material: stainless steel 1.4301)

Part No. full set	Description
steel locking	mounting bracket

E4-16210-□-12-VS-E Full set (both ends), ending with outer side link, **screwed** - standard

E4-16210-□-12-VS-E Full set (both ends) - beginning with outer side link (moving end) - ending with inner side link (fixed end), **screwed** - standard

Stainless steel version available. Please add index **-E** (Material: stainless steel 1.4301)

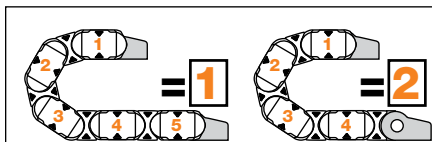

Note: Depending on the chain length, the e-chain® may end with □ either an outer or an □ inner side link. For the best appearance, make sure the e-chain® ends with □ outer side links whenever possible. (with odd number of links)



Strain relief such as clamps, tiewrap plates, nuggets and plug-in clips are available from stock.

The complete chainfix range with ordering options ► Chapter 10

PDF: igus.com/e-chain-pdfs
Product information: igus.com/e-chains



600
601
R608



e-chain system® E4/100 Series 600/601/R608

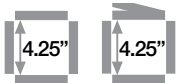

Price Index

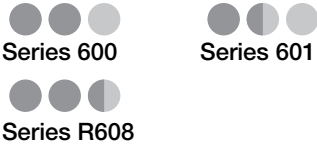

Special Features / Options



This E4 Series is a low-noise version



Cleanroom test upon request



ESD classification:
Electrically conductive ESD/
ATEX version upon request

Assembly Tips



Opening e-chains®: Remove crossbars and clips - Insert screwdriver into the slot, push down, release by lever action



Remove lids/bottoms (e-tubes) - Insert screwdriver into the slot, release by lever action

Other Installation Methods

Vertical, hanging ≤ 394 ft (120 m)

Vertical, standing ≤ 19.69 ft (6 m)

Side-mounted, un_supp. ≤ 19.69 ft (6 m)

Rotary requires further calculation

Usage Guidelines



- When quiet operation is required
- When very high speeds and/or accelerations are required
- For long travels
- For high fill weights



- When a simpler, low-cost solution is required
➤ **Series 1640**
- If an increased inner height is required
➤ **Series 640**

Features & Benefits

- 1 Hinged snap-open removable lids along the outer radius
- 2 Optimized glide pads with lateral wear allowance
- 3 Closed and open styles can be combined
- 4 Wide, rounded crossbars
- 5 Dirt-repellent exterior
- 6 Numerous interior separation possibilities
- 7 Stop dog with brake for noise reduction
- 8 Crossbars on e-chains® are removable along both radii
- 9 e-chains® also available with reverse bending radius "RBR"



Order Example: Complete e-chain®

Please indicate chain length or number of links. Example:

19.69 ft (6 m) **600-30-300-0**

e-chain®

With 2 separators **6011** assembled every 2nd link

Interior Separation

1 Set **6000-12**

Mounting Bracket

e-chain system® E4/100

Series 600/601/R608

Installation Dimensions

Short travel, unsupported length

- FL_B = unsupported with permitted sag
 - FL_G = unsupported with straight upper run
- Further information ► Design, Chapter 1

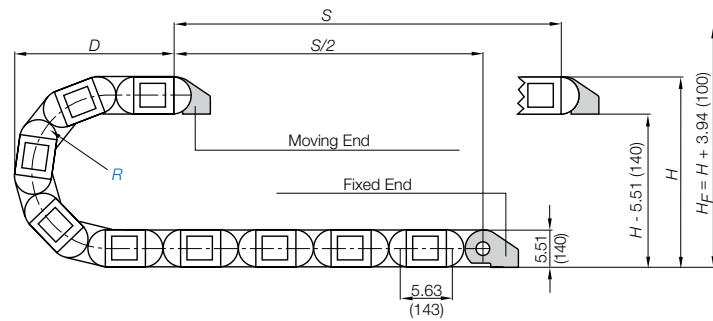
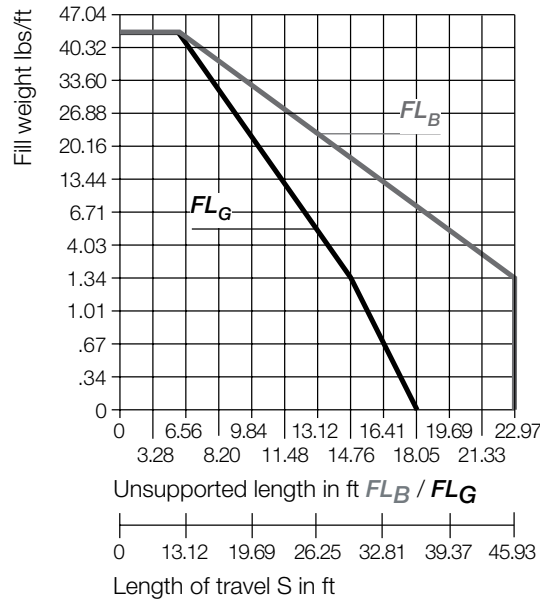
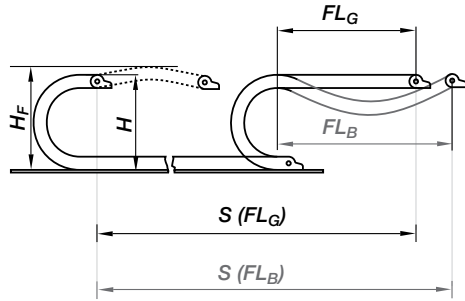

Pitch per link: = 5.63" (143 mm)
 Links per ft (m): = 2.13 (7)
 For center mount applications:
 Chain length = $\frac{S}{2} + K$

The required clearance height: $H_F = H + 3.94$ in. (100 mm) (with 3.36 lbs/ft (5 kg/m) fill weight. Please consult igus® if space is particularly restricted.

R	7.87 (200)	9.84 (250)	11.81 (300)	13.78 (350)	15.75 (400)	17.72 (450)	19.69 (500)	21.65 (550)	23.62 (600)	29.53 (750)	39.37 (1000)
H	21.46 (545)	25.39 (645)	29.33 (745)	33.27 (845)	37.20 (945)	41.14 (1045)	45.08 (1145)	49.02 (1245)	52.95 (1345)	64.76 (1645)	84.45 (2145)
D	16.34 (415)	18.31 (465)	20.27 (515)	22.24 (565)	24.21 (615)	26.18 (665)	28.15 (715)	30.12 (765)	32.09 (815)	37.99 (965)	47.83 (1215)
K	36.22 (920)	42.52 (1080)	48.82 (1240)	55.12 (1400)	61.42 (1560)	67.72 (1720)	73.62 (1870)	79.53 (2020)	85.63 (2175)	104.72 (2660)	135.24 (3435)

For long travels with lowered mounting height

Long travel lengths from 32.8 ft. (10 m) to max. 1,476 ft. (450 m)

For center mount applications:

Chain length: = $\frac{S}{2} + K_2$

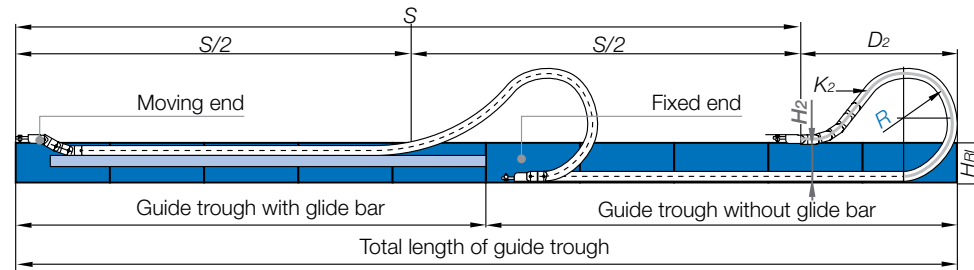

R	7.87 (200)	9.84 (250)	11.81 (300)	13.78 (350)	15.75 (400)	17.72 (450)	19.69 (500)	21.65 (550)	23.62 (600)	29.53 (750)	39.37 (1000)
H_2	12.80 (325)	12.80 (325)	12.80 (325)	12.80 (325)	12.80 (325)	12.80 (325)	12.80 (325)	12.80 (325)	12.80 (325)	12.80 (325)	-
D_{2+20}	35.43 (900)	39.37 (1000)	43.31 (1100)	49.21 (1250)	57.09 (1450)	62.99 (1600)	66.93 (1700)	74.80 (1900)	80.71 (2050)	112.20 (2850)	-
K_2	61.93 (1573)	67.56 (1716)	73.19 (1859)	90.08 (2288)	101.33 (2574)	112.60 (2860)	123.86 (3146)	135.12 (3432)	152.01 (3861)	197.05 (5005)	-

Speed / acceleration FL_G	max. 65.6 ft/s (20 m/s) / max. 656 ft/s ² (200 m/s ²)
Speed / acceleration FL_B	max. 9.84 ft/s (3 m/s) / max. 19.69 ft/s ² (6 m/s ²)
Gliding speed / acceleration (maximum)	max. 32.8 ft/s (10 m/s) / max. 164 ft/s ² (50 m/s ²)
Material - permitted temperature	igumid G / -40°F (-40°C) up to +248°F (+120°C)
Flammability Class, igumid G	VDE 0304 IIC UL94 HB



600
601
R608

Short Travels - Unsupported



Unsupported e-chains® feature positive camber over short travels. This must be accounted for when specifying the clearance height. Please refer to **Installation dimensions** for further details.

Legend

- S = Length of travel
 - R = Bending radius
 - H = Nominal clearance height
 - D = Overlength e-chain® radius in final position
 - $K = \pi \cdot R + \text{safety buffer}$
 - H_F = Required clearance height
 - H_{in} = Trough inner height
 - H_2 = *Mounting height
 - D_2 = Overlength - long travels, gliding
 - K_2 = *Add-on
- *If the mounting bracket location is set lower



PDF: igus.com/e-chain-pdfs
 Product information: igus.com/e-chains



Long Travels - Gliding



If the unsupported length is exceeded, the e-chain®/ Tube must glide on itself. This requires a guide trough.

Design, Chapter 1

Technical Data



Details of material properties

► Chapter 1



Series 600 - e-chain® with crossbars every link

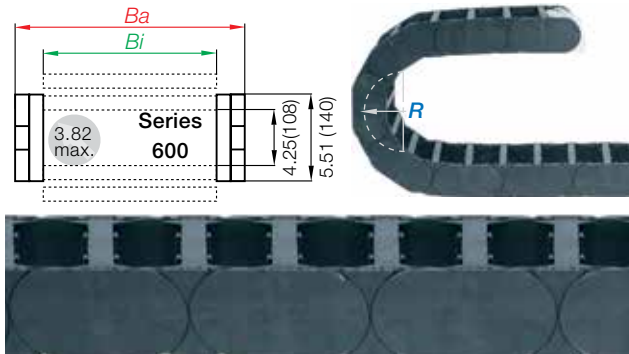

- Crossbars every link
- For use with rigid hydraulic hoses
- For particularly demanding applications
- Can be opened from both sides

Part Number Structure

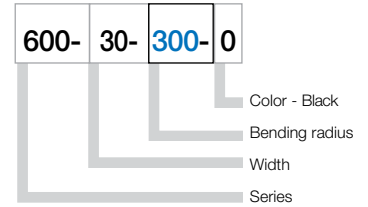

Series 601 - e-chain® with crossbars every other link

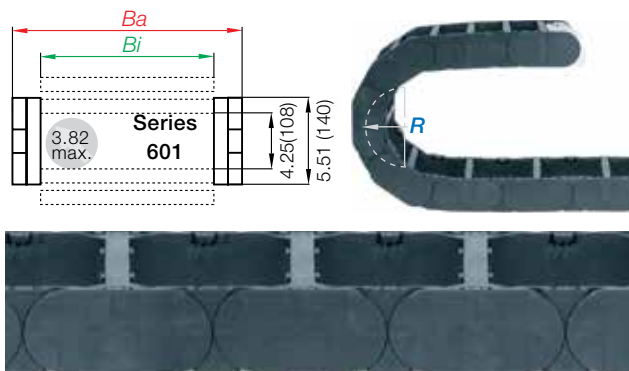

- Crossbars every other link - Standard configuration
- For nearly every situation
- Can be opened from both sides
- Easy assembly
- Stable
- Cost-effective

Part Number Structure

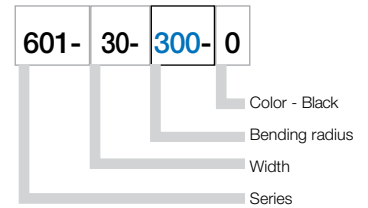

Series R608 - fully enclosed e-tube

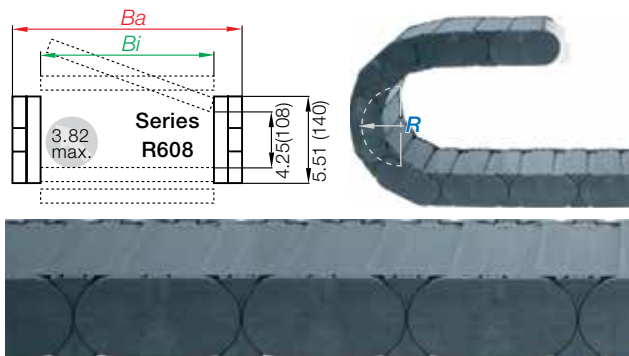

- Fully enclosed
- Excellent cable and hose protection against dirt
- Protection against hot chips
- Lids along inner radius are completely removable
- Lids along the outer radius are single-sided, snap open, hinged on one side as well as completely removable

Part Number Structure

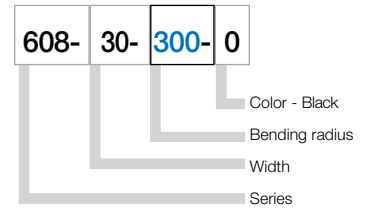

e-chain® as separate parts, links and side plates

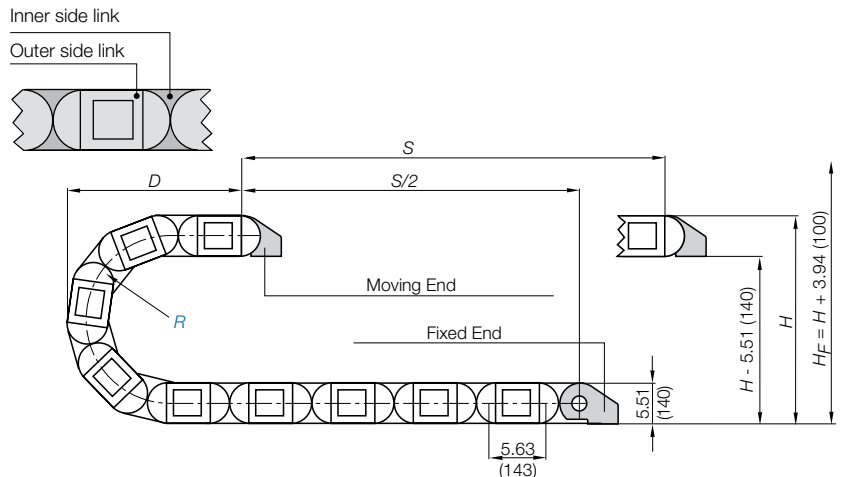
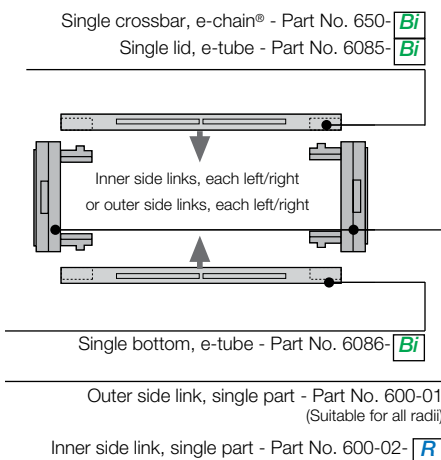

e-chain system® E4/100

Series 600/601/R608



600
601
R608

Supplement part number with required radius. Example: 600-30-300-0
Pitch: 5.63 in. (143 mm) per link links/ft(m) = 2.13 (7)

Part Number.				<i>Bi</i>	<i>Ba</i>	600	601	R608	
Crossbars Every link	Crossbars Every other	Tube Version		in. (mm)	in. (mm)	lbs/ft (kg/m)	lbs/ft (kg/m)	lbs/ft (kg/m)	
600-20-	601-20-	608-20-	<input type="checkbox"/>	-0	7.87 (200)	9.92 (252)	≈ 3.00 (4.46)	≈ 2.63 (3.91)	*
600-25-	601-25-	608-25-	<input type="checkbox"/>	-0	9.84 (250)	11.89 (302)	≈ 3.26 (4.85)	≈ 2.76 (4.10)	*
600-30-	601-30-	608-30-	<input type="checkbox"/>	-0	11.81 (300)	13.86 (352)	≈ 3.55 (5.29)	≈ 2.90 (4.32)	*
600-32-	601-32-		<input type="checkbox"/>	-0	12.60 (320)	14.65 (372)	≈ 3.62 (5.38)	≈ 2.94 (4.37)	-
600-35-	601-35-	608-35-	<input type="checkbox"/>	-0	13.78 (350)	15.83 (402)	≈ 3.84 (5.71)	≈ 3.04 (4.53)	*
600-40-	601-40-	608-40-	<input type="checkbox"/>	-0	15.75 (400)	17.80 (452)	≈ 4.05 (6.02)	≈ 3.15 (4.69)	*
600-45-	601-45-		<input type="checkbox"/>	-0	17.72 (450)	19.76 (502)	≈ 4.34 (6.46)	≈ 3.30 (4.91)	-
600-50-	601-50-		<input type="checkbox"/>	-0	19.69 (500)	21.73 (552)	≈ 4.53 (6.74)	≈ 3.39 (5.05)	-
600-55-	601-55-		<input type="checkbox"/>	-0	21.65 (550)	23.70 (602)	≈ 5.01 (7.45)	≈ 3.63 (5.40)	-
600-60-	601-60-		<input type="checkbox"/>	-0	23.62 (600)	25.67 (652)	≈ 5.14 (7.65)	≈ 3.70 (5.50)	-

Choose from the radii below for all of the above sizes
Radius (mm) Example: 600-30-300-0

	200**	250	300	350	400	450	500	550	600	750	1000
<i>R</i>	7.87 (200)	9.84 (250)	11.81 (300)	13.78 (350)	15.75 (400)	17.72 (450)	19.69 (500)	21.65 (550)	23.62 (600)	29.53 (750)	39.37 (1000)
<i>H</i>	21.46 (545)	25.39 (645)	29.33 (745)	33.27 (845)	37.20 (945)	41.14 (1045)	45.08 (1145)	49.02 (1245)	52.95 (1345)	64.76 (1645)	84.45 (2145)
<i>D</i>	16.34 (415)	18.31 (465)	20.27 (515)	22.24 (565)	24.21 (615)	26.18 (665)	28.15 (715)	30.12 (765)	32.09 (815)	37.99 (965)	47.83 (1215)
<i>K</i>	36.22 (920)	42.52 (1080)	48.82 (1240)	55.12 (1400)	61.42 (1560)	67.72 (1720)	73.62 (1870)	79.53 (2020)	85.63 (2175)	104.72 (2660)	135.24 (3435)

** This radius is not available for the R608 Series
*Upon request

0=Standard color black. For other colors see Chapter 1

PDF: igus.com/e-chain-pdfs
Product information: igus.com/e-chains





Option 1: Vertical separators and spacers

Vertical separators are used if a vertical subdivision of the e-chain® interior is required. By standard, vertical separators are assembled every other e-chain® link.

NOTE: Observe a lateral spacing of at least 1.26 in. (32mm) for e-tubes and .63 in. (16mm) for e-chain®. There is no minimum spacing needed for side plates

Exception: Minimum spacing

Locking separator 6008 = .91" (23 mm)

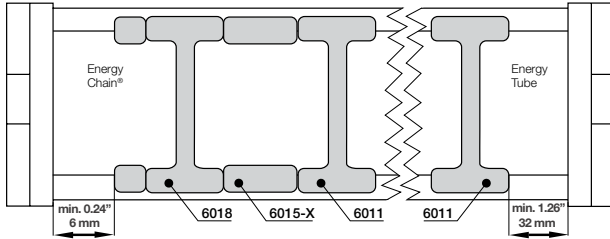

Vertical separator
6001

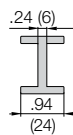

Vertical separator

Unassembled **Part No. 6001**

Assembled **Part No. 6011**

- **Standard separator 6001 for e-chains® and e-tubes**

This separator offers safe stability due to its wide base design, also when used with thick cables or hoses.



Locking separator
6008

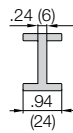

Locking separator (chain only)

Unassembled **Part No. 6008**

Assembled **Part No. 6018**

- **Locking separator 6008 for e-chains®**

This separator features increased retention force for applications exposed to very high humidity and extreme loads. The extra retention force is achieved by asymmetric claws for the crossbar. Take care to ensure proper alignment.



Spacers
6005-XX



Spacers available in the following sizes:

Part No.	Part No.		
Unassembled	Assembled	in.	(mm)
6005 -10	6015 -10	.39"	(10)
6005 -15	6015 -15	.59"	(15)
6005 -20	6015 -20	.79"	(20)

- **NOTE ON SPACERS**

Vertical separators are adjustable, but can be fixed in position by means of a spacer. Spacers are most often necessary for side mounted applications. The available inner height is reduced by .08" (2mm) **per spacer** (for example if one spacer is placed on either side of the separator, the overall inner height is reduced by .16" (4mm). To avoid this, place the spacers on the **outside** of the opening crossbar (**not for long travels**).

e-chain system® E4/100

Series 600/601/R608

Interior Separation



600
601
R608

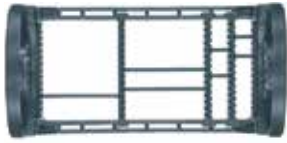

Option 2: Shelves

e-chains® and e-tubes can be subdivided both vertically and horizontally using the various interior separation elements.

► **Design, Chapter 1** for layout recommendations.

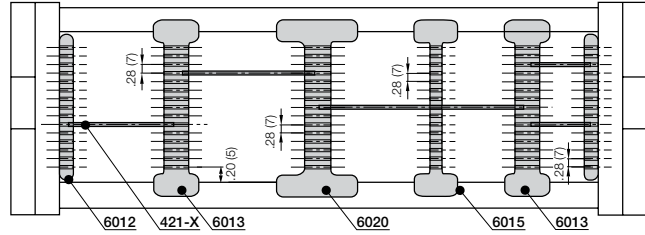

- **Side plates 6002**

This component is used to form the basic pattern of a shelf system.

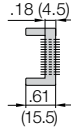

Side plate

Unassembled	Part No. 6002
Assembled	Part No. 6012

Side plate
6002



- **Vertical separator 6003**

This component is used to form the basic pattern of a shelf system.

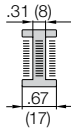

Vertical separator

Unassembled	Part No. 6003
Assembled	Part No. 6013

Vertical separator
6003



- **Locking vertical separator 6010**

This separator is slotted and able to be combined with shelves

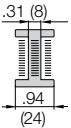

Locking vertical separator

Unassembled	Part No. 6010
Assembled	Part No. 6020

Locking vertical separator
6010



- **Slotted separators 6004**

These are used for very complex subdivisions. However, they cannot be retrofitted into an existing separation system without removing the shelves first.

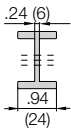

Slotted separators, closed

Unassembled	Part No. 6004
Assembled	Part No. 6014

Closed slotted separator
6004



- **Slotted separator 6005**

This separator can be retrofitted into an existing interior separation system without removing the shelves, as long as these shelves fit into any of the 11 middle slots

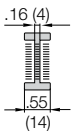

Slotted separators, open

Unassembled	Part No. 6005
Assembled	Part No. 6015

Open slotted separator
6005



Shelves 420-XX

These components form the basic pattern of a shelf system. Shelves of various widths can be arranged at 7 different heights in .28" (7mm) increments

Width X in. (mm)	Usable Width in. (mm)	Part No. Unassembled	Part No. Assembled	Width X in. (mm)	Usable Width in. (mm)	Part No. Unassembled	Part No. Assembled
.71 (18)	.39 (10)	420-18	421-18	2.95 (75)	2.64 (67)	420-75	421-75
.91 (23)	.59 (15)	420-23	421-23	3.46 (88)	3.15 (80)	420-88	421-88
.98 (25)	.67 (17)	420-25	421-25	3.94 (100)	3.62 (92)	420-100	421-100
1.10 (28)	.79 (20)	420-28	421-28	4.92 (125)	4.61(117)	420-125	421-125
1.30 (33)	.98 (25)	420-33	421-33	5.91 (150)	5.59(142)	420-150	421-150
1.69 (43)	1.38 (35)	420-43	421-43	6.89 (175)	6.57(167)	420-175	421-175
1.97 (50)	1.65 (42)	420-50	421-50	7.36 (187)	7.05(179)	420-187	421-187
2.44 (62)	2.13 (54)	420-62	421-62	7.87 (200)	7.56(192)	420-200	421-200

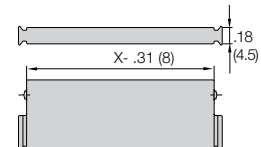

PDF: igus.com/e-chain-pdfs
Product information: igus.com/e-chains



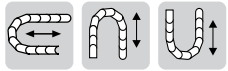

Option 1: pivoting

- For pivoting connections
- One part for all chain widths
- Electrically conductive

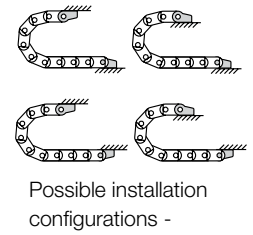
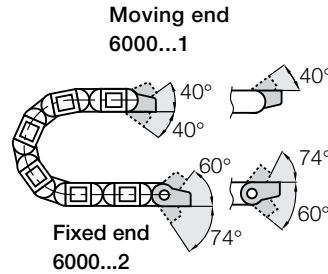

Part No. Mounting Brackets Full Set

4 parts, 2 with pin, 2 with bore
Series 600/601/R608
6000-12

Part No. Mounting Bracket Moving End

2 parts, 1 left & 1 right with bore
Series 600/601/R608
6000-1

Part No. Mounting Bracket Fixed End

2 parts, 1 left & 1 right with pin
Series 600/601/R608
6000-2

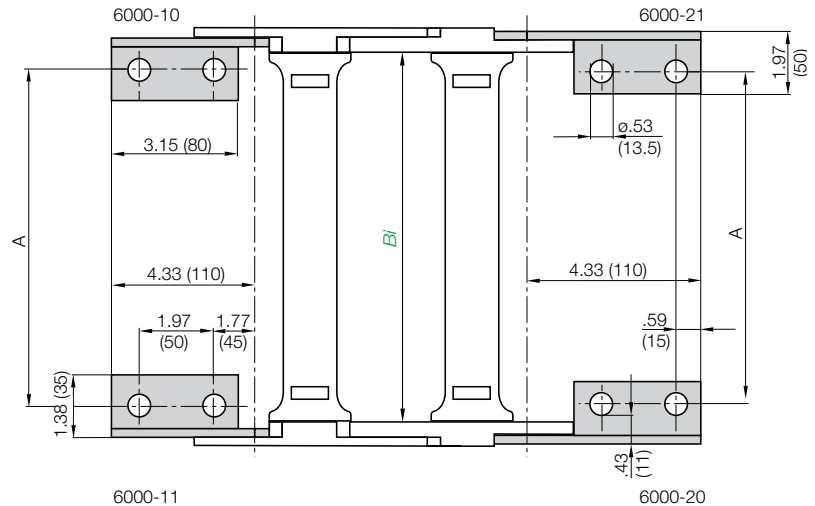

Bracket Mounting Dimensions

Width of Chain <i>B_i</i>	Part Number	Mounting Brackets*			A in. (mm)
		Full Set	Moving End Only	Fixed End Only	
7.87 (200)	6000	-12	-1	-2	6.69 (170)
9.84 (250)	6000	-12	-1	-2	8.66 (220)
11.81 (300)	6000	-12	-1	-2	10.63 (270)
12.60 (320)	6000	-12	-1	-2	14.42 (290)
13.78 (350)	6000	-12	-1	-2	12.60 (320)
15.75 (400)	6000	-12	-1	-2	14.57 (370)
17.72 (450)	6000	-12	-1	-2	16.54 (420)
19.69 (500)	6000	-12	-1	-2	18.50 (470)
21.65 (550)	6000	-12	-1	-2	20.47 (520)
23.62 (600)	6000	-12	-1	-2	22.48 (570)

***Ordering information**

Due to the design of the E4/100 series chains, please note the following when ordering brackets:

Even number of links = full set, part number ending in -12
Odd number of links = 2 pieces, part number ending in -2

Tiewrap Plates

Option 1: Tiewrap plates as an individual part

Available as an individual component, can be fixed onto a mounting bracket with the use of a profile rail.

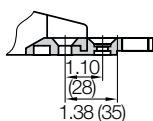

Shown assembled

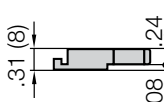

Single tiewrap plate

Tiewrap Plate	n Number of Teeth	C Overall Width in. (mm)	B Bore Width in. (mm)	Center Bore
3050-ZB	5	1.97 (50)	1.18 (30)	no
3075-ZB	7	2.95 (75)	2.16 (55)	no
3100-ZB	10	3.94 (100)	3.15 (80)	no
3115-ZB	11	4.53 (115)	3.74 (95)	no
3125-ZB	12	4.92 (125)	4.13 (105)	no
3150-ZB	15	5.91 (150)	5.12 (130)	no
3175-ZB	17	6.89 (175)	6.10 (155)	no
3200-ZB	20	7.87 (200)	7.09 (180)	yes
3225-ZB	22	8.86 (225)	8.07 (205)	yes
3250-ZB	25	9.84 (250)	9.06 (230)	yes

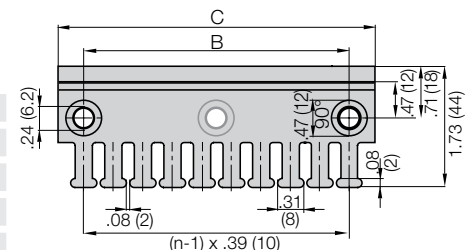

For more information please refer to strain relief section of Chapter 10

e-chain system® E4/100

Series 600/601/R608

Guide Trough



600
601
R608

Guide troughs are used with applications where the upper run of the e-chain® glides on the lower run. If using igus® steel guide troughs, the following components are required:

- Full travel length of guide trough
Part No. 97-30
- 1/2 travel length glide bars
Part No. 93-01
- Installation sets as end connectors
Part No. 97-50-XX

-XX indicates the length of the profile rails on which the guide trough is mounted. The values and part numbers are specified in the table below. The standard length of the trough components and glide bars is 6.56 ft (2 m). The overall length of the guide trough directly correlates to the length of travel.

Example:
Length of travel 164 ft (50 m)
Center-mounted

Required guide troughs:
164 ft (50 m) guide trough, 82 ft. (25 m) glide bar
= 25 sections of 6.56 ft (2 m) guide trough

Part No. 97-30
= 13 sections of 6.56 ft (2 m) glide bar

Part No. 93-01
Required number of installation set:
= Number of guide trough components + 1
= 25 + 1 = 26
Part No. of the installation sets **97-50-XXX**
Example:
97-50-400 for 15.75 (400 mm) long profile rail



Left: Guide trough with glide bars
Right: Guide troughs without glide bars



Installation sets as section connectors

Width of Crossbar
600-05-200-0

	B_{Ri}	Installation Part No.
-20	10.12 (257)	97-50-375
-25	12.09 (307)	97-50-425
-30	14.06 (357)	97-50-475
-32	14.84 (377)	97-50-500
-35	16.02 (407)	97-50-525
-40	17.99 (457)	97-50-575
-45	19.96 (507)	97-50-625
-50	21.93 (557)	97-50-675
-55	23.90 (607)	97-50-725
-60	25.87 (657)	97-50-775

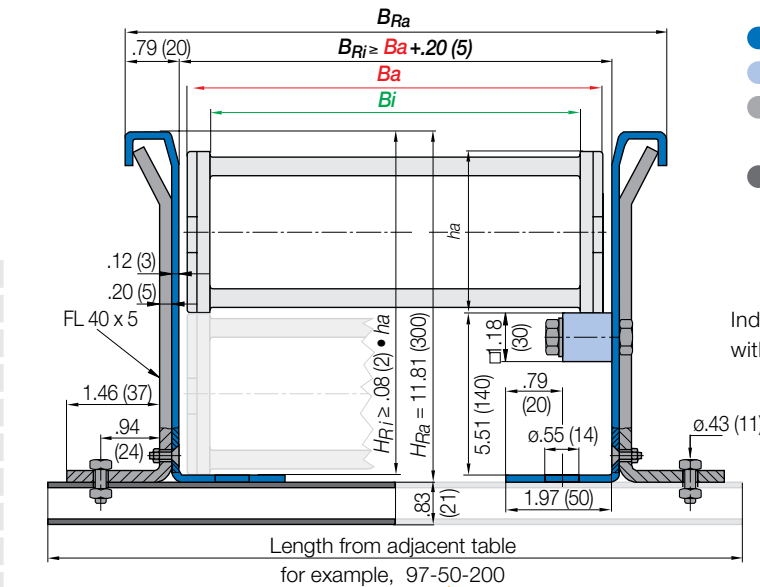

- Guide trough
- Glide bars
- Installation set "Basic"
- Profile rail

Individual attachment without profile rail

Standard length profile rail

* Specialized guide trough available upon request

PDF: igus.com/e-chain-pdfs
Product information: igus.com/e-chains



Price Index

Series 800

Special Features / Options

ESD classification:
Electrically conductive ESD/
ATEX version upon request

Assembly Tips

Opening e-chains®: Remove crossbars and clips - Insert screwdriver into the slot, push down, release by lever action

Other Installation Methods

Vertical, hanging: consult igus®

Vertical, standing ≤ 19.69 ft (6 m)

Side-mounted, unsupp. ≤ 19.69 ft (6 m)

Rotary requires further calculation

Usage Guidelines

- If a particularly large and rigid e-chain® is required
- For very high speeds and/or accelerations
- For long travels
- For high additional loads

Features & Benefits

- 1 Dirt-repellent exterior
- 2 Optimized glide pads with lateral wear allowance
- 3 Wide, rounded crossbars
- 4 Crossbars on e-chains® are removable along both radii
- 5 Each chain link consists of four opening crossbars which increases its rigidity and allows for a greater unsupported length
- 6 Undercut for more stability
- 7 e-chains also available with reverse bending radius "RBR"

Order Example: Complete e-chain®

Please indicate chain length or number of links. Example:

16.4 ft (5 m) **800-30-350-0**

e-chain®

With 2 separators **8011** assembled every 2nd link

Interior Separation

1 Set **8000-12**

Mounting Bracket

e-chain system® E4-1 Series 800 Installation Dimensions

Short travel, unsupported length

- FL_B = unsupported with permitted sag
 - FL_G = unsupported with straight upper run
- Further information ► Design, Chapter 1

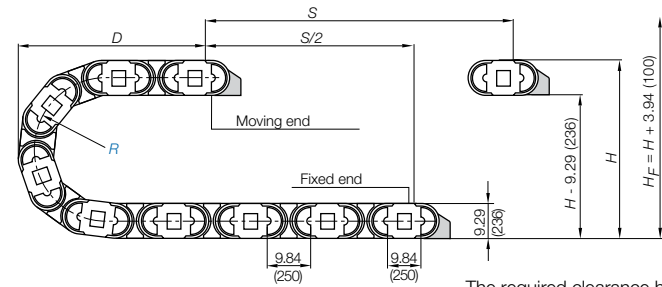
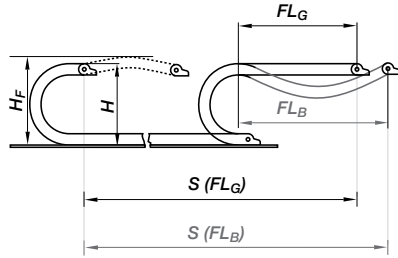

The required clearance height: $H_F = H + 3.94$ in. (100 mm) (with 3.36 lbs/ft (5 kg/m) fill weight. Please consult igus® if space is particularly restricted.

R	12.80 (325)	13.78 (350)	15.75 (400)	17.72 (450)	19.69 (500)	23.62 (600)	29.53 (750)	39.37 (1000)
H^*	34.88 (886)	36.85 (936)	40.79 (1036)	44.72 (1136)	48.66 (1236)	56.53 (1436)	68.35 (1736)	88.03 (2236)
D	32.20 (818)	33.19 (843)	35.16 (893)	37.13 (943)	39.09 (993)	43.03 (1093)	48.94 (1243)	58.78 (1493)
K	60.04 (1525)	62.99 (1600)	69.29 (1760)	75.39 (1915)	81.69 (2075)	93.90 (2385)	112.60 (2860)	143.50 (3645)

For long travels with lowered mounting height

Please consult igus® when choosing to use a lowered mounting height with this series

Long travel lengths from 49.2 ft. (15 m) to max. 1,476 ft. (450 m)

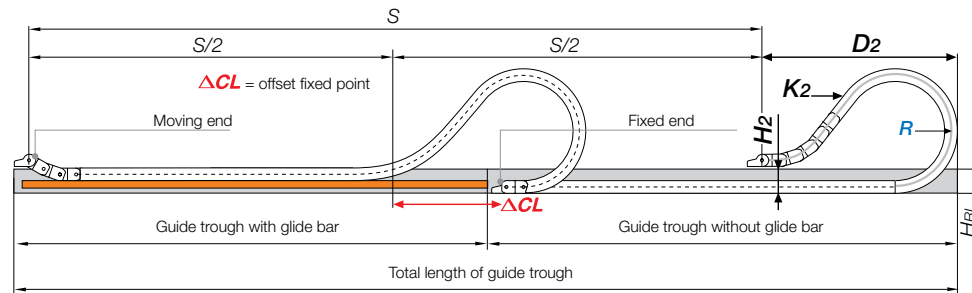

R	12.80 (325)	13.78 (350)	15.75 (400)	17.72 (450)	19.69 (500)	23.62 (600)	29.53 (750)	39.37 (1000)
H_2	22.83 (580)	22.83 (580)	22.83 (580)	22.83 (580)	22.83 (580)	22.83 (580)	22.83 (580)	22.83 (580)
D_2	40.55 (1030)	42.52 (1080)	54.33 (1380)	63.39 (1610)	78.74 (2000)	97.64 (2480)	*	*
K_2	78.74 (2000)	78.74 (2000)	98.43 (2500)	118.11 (3000)	127.95 (3250)	157.48 (4000)	*	*
ΔCL	9.84 (250)	11.81 (300)	21.65 (550)	29.53 (750)	41.34 (1050)	55.12 (1400)	*	*

In case of travels between 39.4 and 32.8 ft (12 and 15 m) we recommend a longer unsupported length. **200 radius is not available for the e-tubes

Speed / acceleration FL_G	max. 65.6 ft/s (20 m/s) / max. 656 ft/s ² (200 m/s ²)
Speed / acceleration FL_B	max. 9.84 ft/s (3 m/s) / max. 19.69 ft/s ² (6 m/s ²)
Gliding speed / acceleration (maximum)	max. 32.8 ft/s (10 m/s) / max. 164 ft/s ² (50 m/s ²)
Material - permitted temperature	igumid G / -40°F (-40°C) up to +248°F (+120°C)
Flammability Class, igumid G	VDE 0304 IIC UL94 HB

Short Travels - Unsupported



Unsupported e-chains® feature positive camber over short travels. This must be accounted for when specifying the clearance height. Please refer to **Installation dimensions** for further details.

Legend

- S = Length of travel
- R = Bending radius
- H = Nominal clearance height
- D = Overlength e-chain® radius in final position
- $K = \pi \cdot R + \text{safety buffer}$
- H_F = Required clearance height
- H_{ri} = Trough inner height
- H_2 = *Mounting height
- D_2 = Overlength - long travels, gliding
- K_2 = *Add-on

*If the mounting bracket location is set lower

Long Travels - Gliding



If the unsupported length is exceeded, the e-chain®/Tube must glide on itself. This requires a guide trough.

Design, Chapter 1

For center mount applications:
Chain length: $= \frac{S}{2} + K_2$

Technical Data



Details of material properties

► Chapter 1

7.87"



Series 800 - e-chain® with crossbars every link

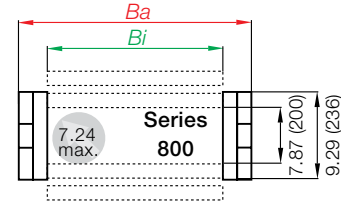

- Crossbars every link
- For use with rigid hydraulic hoses
- For particularly demanding applications
- Can be opened from both sides

Part Number Structure

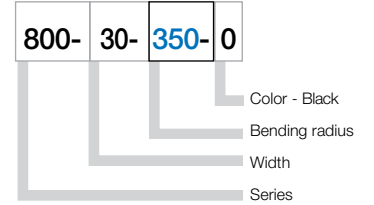

Telephone 1-800-521-2747

Supplement part number with required radius. Example: 800-30-**350**-0
Pitch: 9.84 in. (250 mm) per link links/ft(m) = 1.22 (4)

Part Number.				<i>Bi</i>	<i>Ba</i>	800
Crossbars	Every link			in. (mm)	in. (mm)	lbs/ft (kg/m)
800-20-	<input type="checkbox"/>	-0		7.87 (200)	10.24 (260)	≈ 10.14 (15.09)
800-25-	<input type="checkbox"/>	-0		9.84 (250)	12.20 (310)	≈ 10.42 (15.50)
800-30-	<input type="checkbox"/>	-0		11.81 (300)	14.17 (360)	≈ 10.68 (15.89)
800-32-	<input type="checkbox"/>	-0		12.80 (325)	15.16 (385)	≈ 10.79 (16.05)
800-35-	<input type="checkbox"/>	-0		13.78 (350)	16.14 (410)	≈ 10.90 (16.22)
800-40-	<input type="checkbox"/>	-0		15.75 (400)	18.11 (460)	≈ 11.25 (16.74)
800-45-	<input type="checkbox"/>	-0		17.72 (450)	20.08 (510)	≈ 11.34 (16.88)
800-50-	<input type="checkbox"/>	-0		19.69 (500)	22.04 (560)	≈ 11.58 (17.23)
800-55-	<input type="checkbox"/>	-0		21.65 (550)	24.02 (610)	≈ 11.85 (17.63)
800-60-	<input type="checkbox"/>	-0		23.62 (600)	25.98 (660)	≈ 12.22 (18.19)

Choose from the radii below for all of the above sizes

	Radius (mm)							
	325	350	400	450	500	600	750	1000
<i>R</i>	12.80 (325)	13.78 (350)	15.75 (400)	17.72 (450)	19.69 (500)	23.62 (600)	29.53 (750)	39.37 (1000)
<i>H*</i>	34.88 (886)	36.85 (936)	40.79 (1036)	44.72 (1136)	48.66 (1236)	56.53 (1436)	60.47 (1536)	88.03 (2236)
<i>D</i>	32.20 (818)	33.19 (843)	35.16 (893)	37.13 (943)	39.09 (993)	43.03 (1093)	48.94 (1243)	58.78 (1493)
<i>K</i>	60.04 (1525)	62.99 (1600)	69.29 (1760)	75.39 (1915)	81.69 (2075)	93.90 (2385)	112.60 (2860)	143.50 (3645)

e-chain® as separate parts, links and side plates

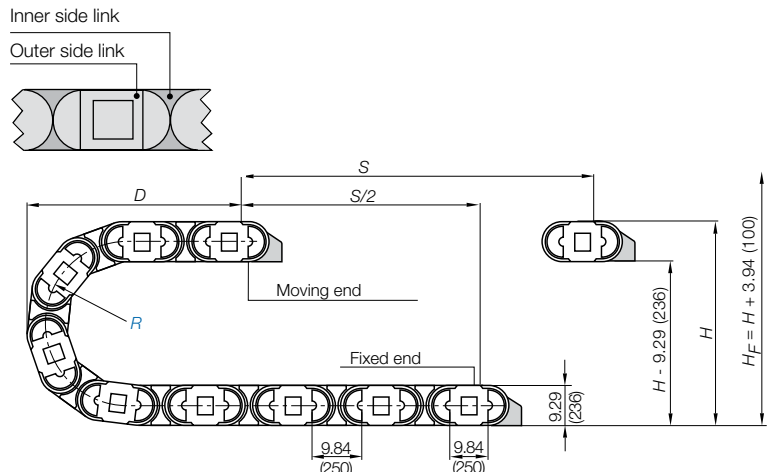
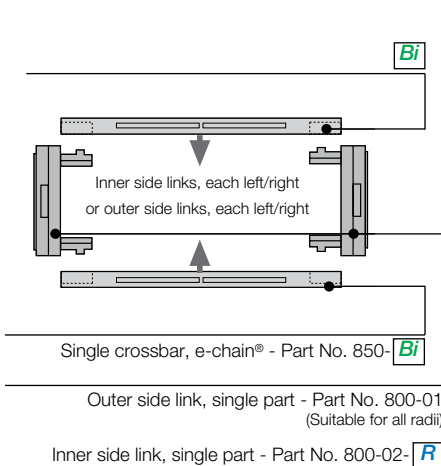

Internet: igus.com
email: sales@igus.com
QuickSpec: igus.com/quickspec



Option 1: Vertical separators and spacers

Vertical separators are used if a vertical subdivision of the e-chain® interior is required. By standard, vertical separators are assembled every other e-chain® link.

NOTE: Observe a lateral spacing of at least 1.26 in. (32mm) for e-tubes and .63 in. (16mm) for e-chain®. There is no minimum spacing needed for side plates

Exception: Minimum spacing

Locking separator 6008 = .91" (23 mm)

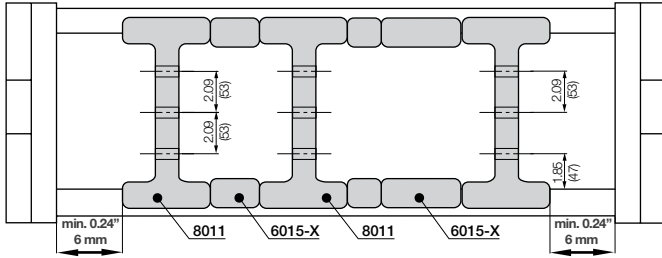

Vertical separator 8001

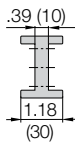

Vertical separator

Unassembled	Part No. 8001
Assembled	Part No. 8011

- **Standard separator 8001 for e-chains®**
This separator offers safe stability due to its wide base design, also when used with thick cables or hoses.



Spacers 6005-XX



Spacer (chain only)

Unassembled	Part No. 6005
Assembled	Part No. 6015

- **NOTE ON SPACERS**
Vertical separators are adjustable, but can be fixed in position by means of a spacer. Spacers are most often necessary for side mounted applications. The available inner height is reduced by .08" (2mm) **per spacer** (for example if one spacer is placed on either side of the separator, the overall inner height is reduced by .16" (4mm)). To avoid this, place the spacers on the **outside** of the opening crossbar (**not for long travels**).

Spacers available in the following sizes:

Part No. Unassembled	Part No. Assembled	in.	(mm)
6005 -10	6015 -10	.39"	(10)
6005 -15	6015 -15	.59"	(15)
6005 -20	6015 -20	.79"	(20)

Modular E4 shelving system safeguards large cables - Series 800

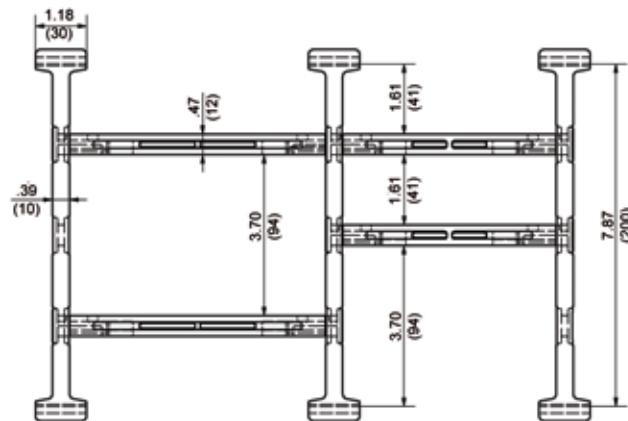

- Easy assembly
- Robust, also for large cable diameters
- Modular
- Widths from 50 to 600 mm
- For use with **vertical separator 8001** and **crossbar 450-XX**

Modular Shelving

Single sided snap in tab

Unassembled	Part No. 8001H1	Part No. 8001H2	Part No. 8011H2
Assembled	Part No. 8011H1		



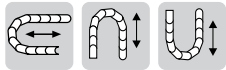

Option 1: pivoting

- For pivoting connections
- One part for all chain widths
- Electrically conductive

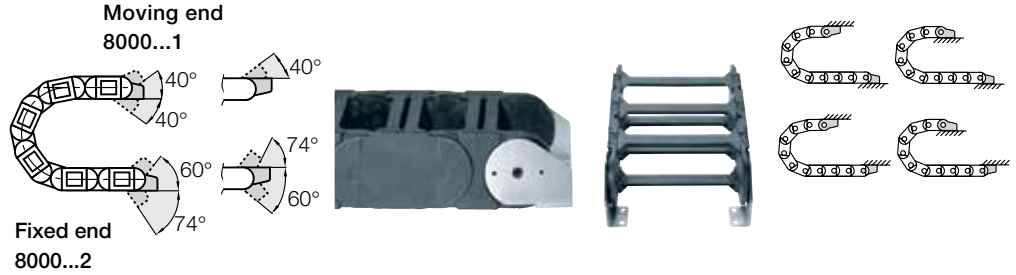

Part No. Mounting Brackets Full Set

4 parts, 2 with pin, 2 with bore
Series 800
8000-12

Part No. Mounting Bracket Moving End

2 parts, 1 left & 1 right with bore
Series 800
8000-1

Part No. Mounting Bracket Fixed End

2 parts, 1 left & 1 right with pin
Series 800
8000-2

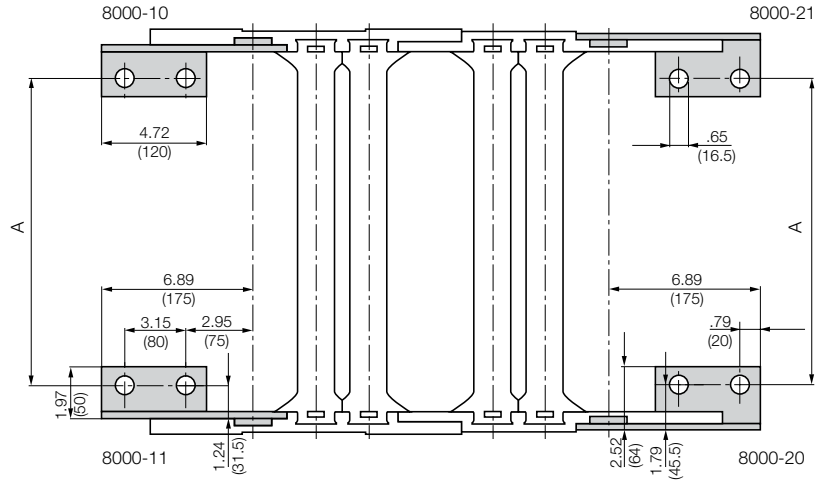

Bracket Mounting Dimensions

Mounting Brackets

Width of Chain <i>Bi</i>	Part Number	Full Set	Moving End Only	Fixed End Only	A in. (mm)
7.87 (200)	8000	-12	-1	-2	5.91 (150)
9.84 (250)	8000	-12	-1	-2	7.87 (200)
11.81 (300)	8000	-12	-1	-2	9.84 (250)
12.80 (325)	8000	-12	-1	-2	10.83 (275)
13.78 (350)	8000	-12	-1	-2	11.81 (300)
15.75 (400)	8000	-12	-1	-2	13.78 (350)
17.72 (450)	8000	-12	-1	-2	15.75 (400)
19.69 (500)	8000	-12	-1	-2	17.72 (450)
21.65 (550)	8000	-12	-1	-2	19.69 (500)
23.62 (600)	8000	-12	-1	-2	21.65 (550)

Due to the design of the E4/100 series chains, please note the following when ordering brackets:

Even number of links = full set, part number ending in -12
Odd number of links = 2 pieces, part number ending in -1

e-chain system® E4-1

Series 800

Guide Trough

Guide troughs are used with applications where the upper run of the e-chain® glides on the lower run. If using igus® steel guide troughs, the following components are required:

- Full travel length of guide trough
Part No. 90-30
- 1/2 travel length glide bars
Part No. 90-31
- Installation sets as end connectors
Part No. 90-50-XX

-XX indicates the length of the profile rails on which the guide trough is mounted. The values and part numbers are specified in the table on the right. Standard length of the trough components and glide bars is 6.56 ft (2m).

The required overall length of the guide trough directly correlates to the length of travel.

Example:
Length of travel 164 ft (50m)
Center mounted

Required guide troughs:
164 ft (50 m) guide trough
82 ft (25 m) glide bars
= 25 sections of (2 m) guide trough without glide bars **Part No. 90-30**
= 13 section of (2 m) guide troughs with glide bars **Part No. 90-31**
Required number of installation sets:
= Number of guide trough components + 1
= 25 + 1 = 26
Part number of the installation sets **90-50-XXX**
Example:
90-50-400 for (400 m) long profile rail



Left: Guide trough with glide bars
Right: Guide troughs without glide bars

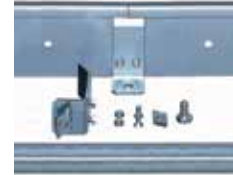

Installation sets as section connectors

Width of Crossbar
640-12-200-0

	B_{Ri}	Installation Part No.
-20	10.43 (265)	90-50-450
-25	12.40 (315)	90-50-500
-30	14.37 (365)	90-50-550
-32	15.35 (390)	90-50-575
-35	16.33 (415)	90-50-600
-40	18.31 (465)	90-50-650
-45	20.28 (515)	90-50-700
-50	22.24 (565)	90-50-750
-55	24.21 (615)	90-50-800
-60	26.18 (665)	90-50-850

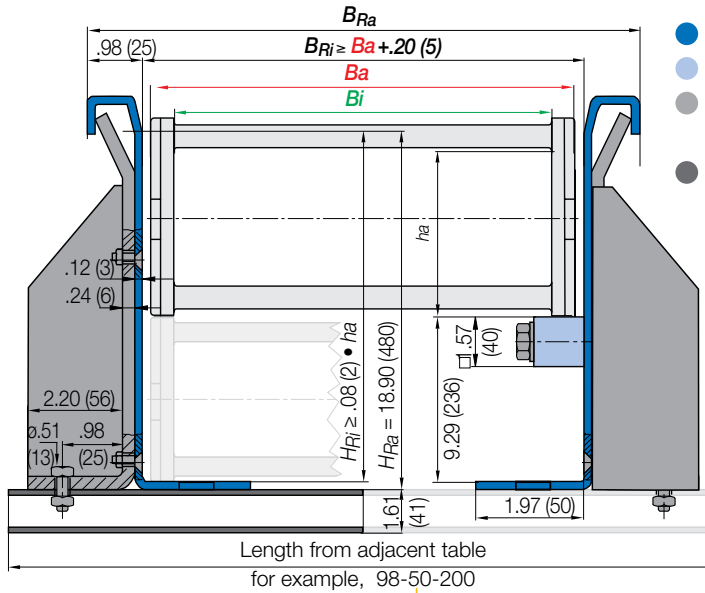

- Guide trough
- Glide bars
- Installation set "Basic"
- Profile rail

Standard length profile rail

Individual attachment without profile rail

* Specialized guide trough available upon request



Price Index



Series 840

Special Options Available



ESD classification:
Electrically conductive ESD/
ATEX version upon request

Assembly Tips



Opening e-chains®: Remove crossbars and clips - Insert screwdriver into the slot, push down, release by lever action

Other Installation Methods

Vertical, hanging: consult igus®

Vertical, standing ≤ 19.69 ft (6 m)

Side-mounted, un_supp. ≤ 19.69 ft (6 m)

Rotary requires further calculation

Usage Guidelines



- If a particularly big and stable e-chain® is required
- At very high speeds and/or accelerations
- For long travels
- For high additional loads
- Large cable/hose diameters



- If a more stable e-chain® with identical inner height is required
➤ Series 800

Features & Benefits

- 1 Dirt-repellent exterior
- 2 Optimized glide pads with lateral wear allowance
- 3 Tongue and groove for more stability
- 4 e-chain® available with reverse bending radii
- 5 Wide, rounded plastic crossbars - cable friendly
- 6 Stop dog with "brake" for noise reduction
- 7 Crossbars are removable along both radii
- 8 Each chain link is made more rigid due to four opening cross-bars, and consequently provides a great unsupported length

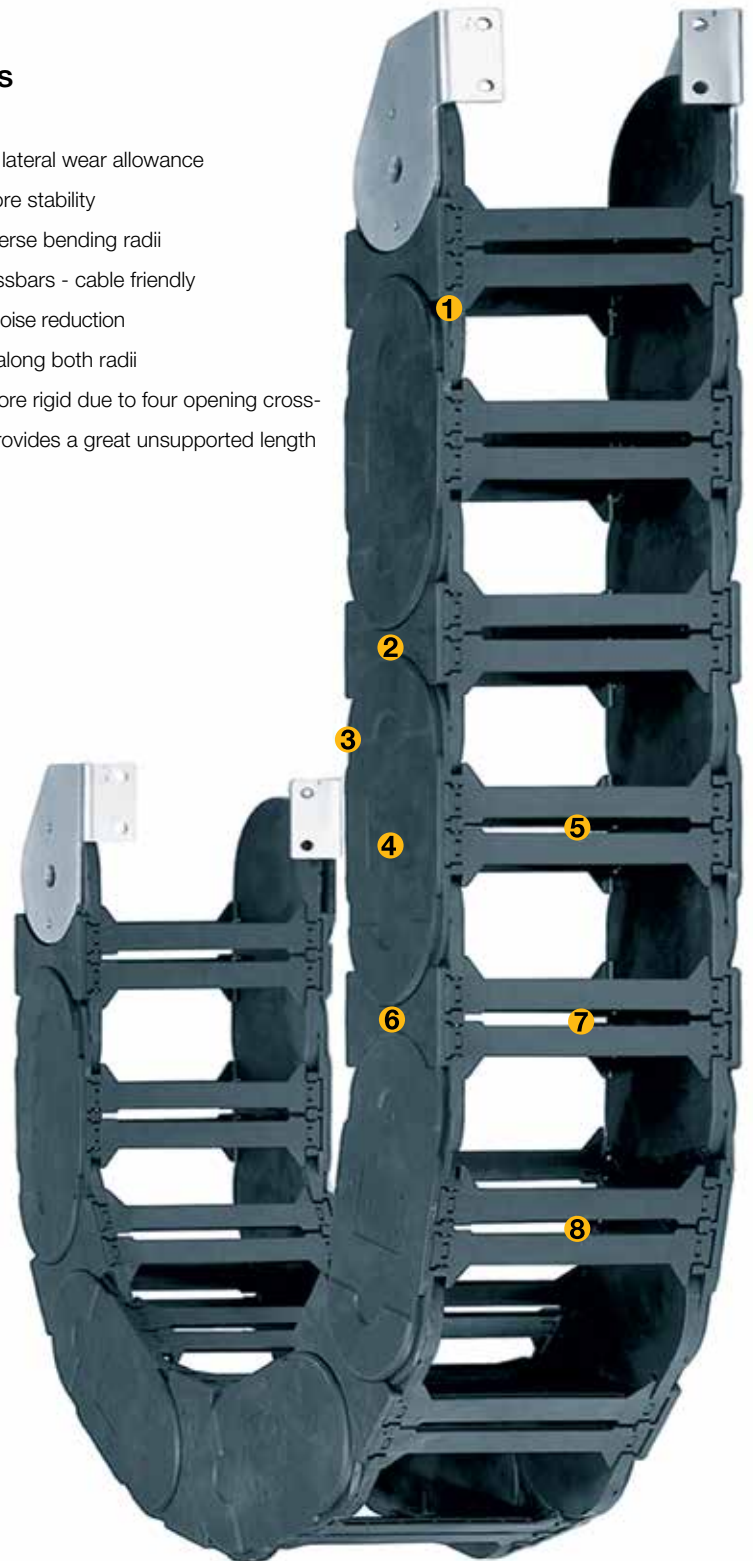

Order Example: Complete e-chain®

Please indicate chain length or number of links. Example:

23 ft (7 m) **840-30-350-0**

e-chain®

With 2 separators **8411** assembled every 2nd link

Interior Separation

1 Set **8000-12**

Mounting Bracket

e-chain system® E4-1 Series 840 Installation Dimensions

Short travel, unsupported length

- FL_B = unsupported with permitted sag
 - FL_G = unsupported with straight upper run
- Further information ► Design, Chapter 1

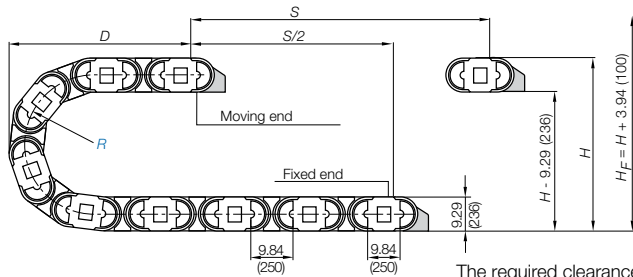
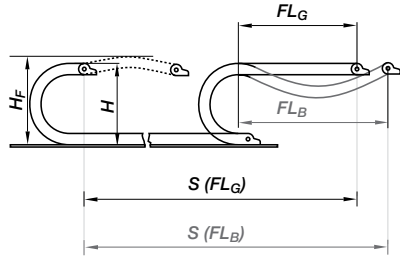

The required clearance height: $H_f = H + 3.94$ in. (100 mm) (with 3.36 lbs/ft (5 kg/m) fill weight. Please consult igus® if space is particularly restricted.

R	12.80 (325)	13.78 (350)	15.75 (400)	17.72 (450)	19.69 (500)	23.62 (600)	29.53 (750)	39.37 (1000)
H^*	34.88 (886)	36.85 (936)	40.79 (1036)	44.72 (1136)	48.66 (1236)	56.53 (1436)	68.35 (1736)	88.03 (2236)
D	32.20 (818)	33.19 (843)	35.16 (893)	37.13 (943)	39.09 (993)	43.03 (1093)	48.94 (1243)	58.78 (1493)
K	60.04 (1525)	62.99 (1600)	69.29 (1760)	75.39 (1915)	81.69 (2075)	93.90 (2385)	112.60 (2860)	143.50 (3645)

For long travels with lowered mounting height

Please consult igus® when choosing to use a lowered mounting height with this series

Long travel lengths from 32.8 ft. (10 m) to max. 1,476 ft. (450 m)

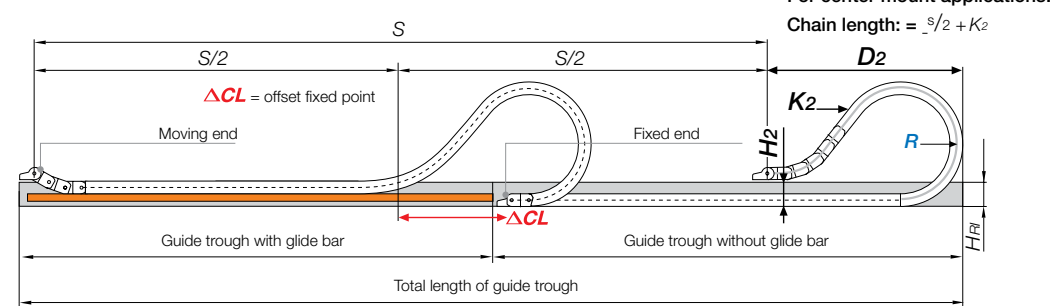

R	12.80 (325)	13.78 (350)	15.75 (400)	17.72 (450)	19.69 (500)	23.62 (600)	29.53 (750)	39.37 (1000)
H_2	22.83 (580)	22.83 (580)	22.83 (580)	22.83 (580)	22.83 (580)	22.83 (580)	22.83 (580)	22.83 (580)
D_2	40.55 (1030)	42.52 (1080)	54.33 (1380)	63.39 (1610)	78.74 (2000)	97.64 (2480)	*	*
K_2	78.74 (2000)	78.74 (2000)	98.43 (2500)	118.11 (3000)	127.95 (3250)	157.48 (4000)	*	*
ΔCL	9.84 (250)	11.81 (300)	21.65 (550)	29.53 (750)	41.34 (1050)	55.12 (1400)	*	*

In case of travels between 39.4 and 32.8 ft (12 and 15 m) we recommend a longer unsupported length. **200 radius is not available for the e-tubes

Speed / acceleration FL_G	max. 65.6 ft/s (20 m/s) / max. 656 ft/s ² (200 m/s ²)
Speed / acceleration FL_B	max. 9.84 ft/s (3 m/s) / max. 19.69 ft/s ² (6 m/s ²)
Gliding speed / acceleration (maximum)	max. 32.8 ft/s (10 m/s) / max. 164 ft/s ² (50 m/s ²)
Material - permitted temperature	igumid G / -40°F (-40°C) up to +248°F (+120°C)
Flammability Class, igumid G	VDE 0304 IIC UL94 HB

Short Travels - Unsupported

Unsupported e-chains® feature positive camber over short travels. This must be accounted for when specifying the clearance height. Please refer to **Installation dimensions** for further details.

Legend

- S = Length of travel
 - R = Bending radius
 - H = Nominal clearance height
 - D = Overlength e-chain® radius in final position
 - $K = \pi \cdot R + \text{safety buffer}$
 - H_f = Required clearance height
 - H_{f1} = Trough inner height
 - H_2 = *Mounting height
 - D_2 = Overlength - long travels, gliding
 - K_2 = *Add-on
- *If the mounting bracket location is set lower



Long Travels - Gliding



If the unsupported length is exceeded, the e-chain®/ Tube must glide on itself. This requires a guide trough.

Design, Chapter 1

Technical Data



Details of material properties

► Chapter 1



Series 840 - e-chain® with crossbars every link

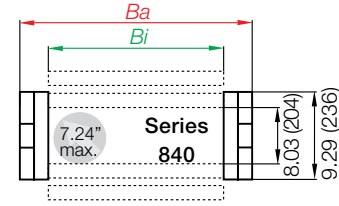

- Crossbars every link
- For use with rigid hydraulic hoses
- For particularly demanding applications
- Can be opened from both sides

Part Number Structure

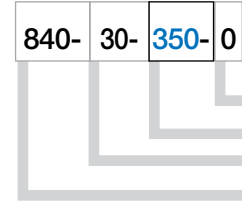

Telephone 1-800-521-2747

e-chain® as separate parts, links and side plates

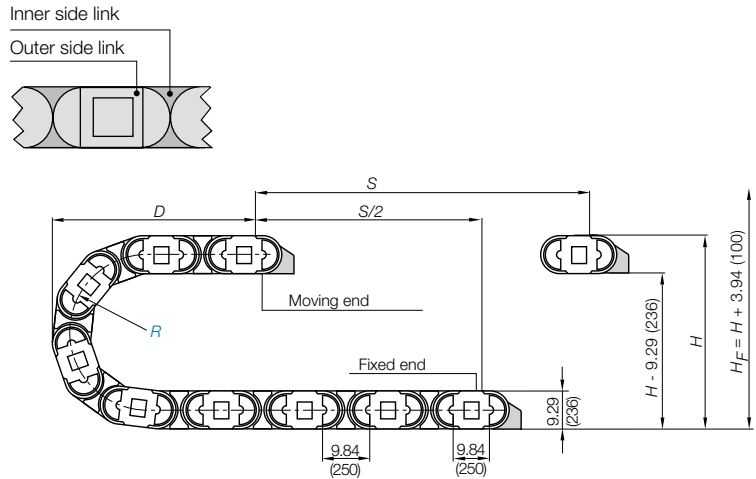
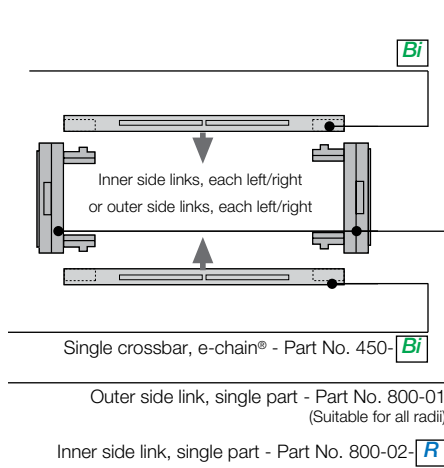

Internet: igus.com
email: sales@igus.com
QuickSpec: igus.com/quickspec

e-chain system® E4-1

Series 840

Product Range



Supplement part number with required radius. Example: 840-30-350-0
 Pitch: 9.84 in. (250 mm) per link links/ft (m) = 1.22 (4)

Part Number.		<i>Bi</i>	<i>Ba</i>	840
Crossbars		in. (mm)	in. (mm)	lbs/ft (kg/m)
Every link				
840-13-	<input type="checkbox"/> -0	3.94 (100)	6.30 (160)	≈ 9.30 (13.84)
840-15-	<input type="checkbox"/> -0	4.45 (113)	6.81 (173)	≈ 9.32 (13.87)
840-16-	<input type="checkbox"/> -0	4.92 (125)	7.28 (185)	≈ 9.37 (13.95)
840-17-	<input type="checkbox"/> -0	5.43 (138)	7.80 (198)	≈ 9.43 (14.04)
840-18-	<input type="checkbox"/> -0	5.91 (150)	8.27 (210)	≈ 9.49 (14.13)
840-20-	<input type="checkbox"/> -0	6.42 (163)	8.78 (223)	≈ 9.52 (14.17)
840-21-	<input type="checkbox"/> -0	6.89 (175)	9.25 (235)	≈ 9.56 (14.22)
840-22-	<input type="checkbox"/> -0	7.40 (188)	9.76 (248)	≈ 9.59 (14.27)
840-23-	<input type="checkbox"/> -0	7.87 (200)	10.24 (260)	≈ 9.64 (14.35)
840-25-	<input type="checkbox"/> -0	8.38 (213)	10.75 (273)	≈ 9.70 (14.43)
840-26-	<input type="checkbox"/> -0	8.86 (225)	11.22 (285)	≈ 9.74 (14.49)
840-27-	<input type="checkbox"/> -0	9.37 (238)	11.73 (298)	≈ 9.79 (14.57)
840-28-	<input type="checkbox"/> -0	9.84 (250)	12.20 (310)	≈ 9.82 (14.61)
840-30-	<input type="checkbox"/> -0	10.35 (263)	12.72 (323)	≈ 9.89 (14.72)
840-31-	<input type="checkbox"/> -0	10.83 (275)	13.19 (335)	≈ 9.91 (14.75)
840-32-	<input type="checkbox"/> -0	11.34 (288)	13.70 (348)	≈ 9.96 (14.82)
840-33-	<input type="checkbox"/> -0	11.81 (300)	14.17 (360)	≈ 10.02 (14.91)
840-35-	<input type="checkbox"/> -0	12.32 (313)	14.69 (373)	≈ 10.12 (15.06)
840-36-	<input type="checkbox"/> -0	12.80 (325)	15.16 (385)	≈ 10.14 (15.09)
840-37-	<input type="checkbox"/> -0	13.31 (338)	15.67 (398)	≈ 10.15 (15.11)
840-38-	<input type="checkbox"/> -0	13.78 (350)	16.14 (410)	≈ 10.18 (15.15)
840-40-	<input type="checkbox"/> -0	14.29 (363)	16.65 (423)	≈ 10.31 (15.34)
840-41-	<input type="checkbox"/> -0	14.76 (375)	17.13 (435)	≈ 10.34 (15.39)
840-42-	<input type="checkbox"/> -0	15.28 (388)	17.64 (448)	≈ 10.42 (15.50)
840-43-	<input type="checkbox"/> -0	15.75 (400)	18.11 (460)	≈ 10.46 (15.57)
840-45-	<input type="checkbox"/> -0	16.26 (413)	18.62 (473)	≈ 10.50 (15.63)
840-46-	<input type="checkbox"/> -0	16.73 (425)	19.09 (485)	≈ 10.54 (15.69)
840-47-	<input type="checkbox"/> -0	17.24 (438)	19.61 (498)	≈ 10.56 (15.72)
840-48-	<input type="checkbox"/> -0	17.72 (450)	20.08 (510)	≈ 10.62 (15.80)
840-50-	<input type="checkbox"/> -0	18.23 (463)	20.59 (523)	≈ 10.66 (15.87)
840-51-	<input type="checkbox"/> -0	18.70 (475)	21.06 (535)	≈ 10.69 (15.91)
840-52-	<input type="checkbox"/> -0	19.21 (488)	21.57 (548)	≈ 10.70 (15.93)
840-53-	<input type="checkbox"/> -0	19.69 (500)	22.05 (560)	≈ 10.75 (16.00)
840-55-	<input type="checkbox"/> -0	20.20 (513)	22.56 (573)	≈ 10.96 (16.31)
840-60-	<input type="checkbox"/> -0	22.17 (563)	24.53 (623)	≈ (11.07 16.47)

Choose from the radii below for all of the above sizes

Radius (mm) Example: 840-30-350-0

	325	350	400	450	500	600	750	1000
<i>R</i>	12.80 (325)	13.78 (350)	15.75 (400)	17.72 (450)	19.69 (500)	23.62 (600)	29.53 (750)	39.37 (1000)
<i>H*</i>	34.88 (886)	36.85 (936)	40.79 (1036)	44.72 (1136)	48.66 (1236)	56.53 (1436)	68.34 (1736)	88.03 (2236)
<i>D</i>	32.20 (818)	33.19 (843)	35.16 (893)	37.13 (943)	39.09 (993)	43.03 (1093)	48.94 (1243)	58.78 (1493)
<i>K</i>	60.04 (1525)	62.99 (1600)	69.29 (1760)	75.39 (1915)	81.69 (2075)	93.90 (2385)	112.60 (2860)	143.50 (3645)

0 = Standard color black. For other colors see Chapter 1

PDF: igus.com/e-chain-pdfs
 Product information: igus.com/e-chains





Vertical separators and spacers

Vertical separators are used if a vertical subdivision of the e-chain® interior is required. By standard, vertical separators are assembled every other e-chain® link.

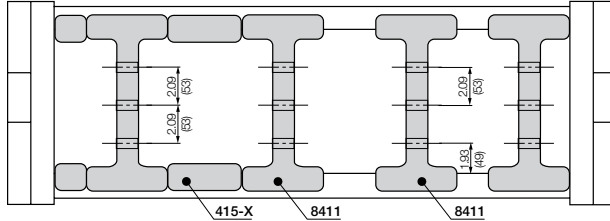

Vertical separator
8401

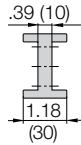

Vertical separator

Unassembled	Part No. 8401
Assembled	Part No. 8411



Spacers
405-XX



Spacer (chain only)

Unassembled	Part No. 405.XX
Assembled	Part No. 415.XX

Spacers available in the following sizes:

Part No. Unassembled	Part No. Assembled	in.	(mm)
405 -10	415 -10	.39"	(10)
405 -15	415 -15	.59"	(15)
405 -20	415 -20	.79"	(20)
405 -30	415 -30	1.18"	(30)
405 -40	415 -40	1.57"	(40)

- **Standard separator 8401 for e-chains®**
This separator offers safe stability due to its wide base design, also when used with thick cables or hoses.

- **NOTE ON SPACERS**
Vertical separators are adjustable, but can be fixed in position by means of a spacer. Spacers are most often necessary for side mounted applications. The available inner height is reduced by .08" (2mm) **per spacer** (for example if one spacer is placed on either side of the separator, the overall inner height is reduced by .16" (4mm). To avoid this, place the spacers on the **outside** of the opening crossbar (**not for long travels**).

e-chain system® E4-1

Series 840

Mounting Brackets

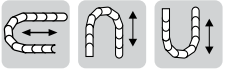

Option 1: pivoting

- For pivoting connections
- One part for all chain widths
- Electrically conductive

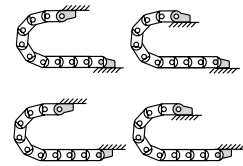
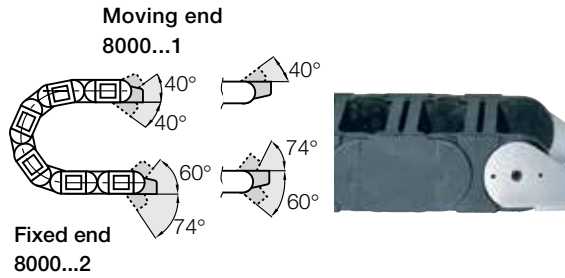

Possible installation configurations -

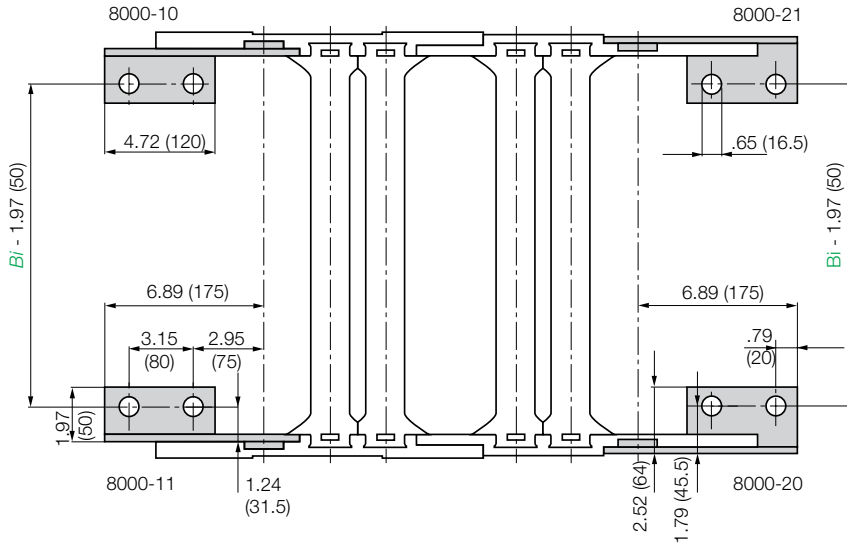

Part No.	Mounting bracket
8000-12	Full set
8000-1	moving end
8000-2	fixed end

Due to the design of the E4/100 series chains, please note the following when ordering brackets:

- Even number of links = full set, part number ending in -12
- Odd number of links = 2 pieces, part number ending in -2



Width of Crossbar
840-20-200-0

	B_{Ri}	Installation Part No.
-13	6.49 (165)	90-50-350
-15	7.01 (178)	90-50-350
-16	7.48 (190)	90-50-375
-17	7.99 (203)	90-50-375
-18	8.46 (215)	90-50-400
-20	8.98 (228)	90-50-400
-21	9.45 (240)	90-50-425
-22	9.96 (253)	90-50-425
-23	10.43 (265)	90-50-450
-25	10.94 (278)	90-50-450
-26	11.42 (290)	90-50-475
-27	11.93 (303)	90-50-475
-28	12.40 (315)	90-50-500
-30	12.91 (328)	90-50-500
-31	13.39 (340)	90-50-525
-32	13.90 (353)	90-50-525
-33	14.37 (365)	90-50-550
-35	14.88 (378)	90-50-550
-36	15.35 (390)	90-50-575
-37	15.87 (403)	90-50-575
-38	16.34 (415)	90-50-600
-40	16.85 (428)	90-50-600
-41	17.32 (440)	90-50-625
-42	17.83 (453)	90-50-625
-43	18.31 (465)	90-50-650
-45	18.82 (478)	90-50-650
-46	19.29 (490)	90-50-675
-47	19.80 (503)	90-50-675
-48	20.20 (513)	90-50-700
-50	20.79 (528)	90-50-700
-51	21.26 (540)	90-50-725
-52	21.77 (553)	90-50-725
-53	22.24 (565)	90-50-750
-55	22.76 (578)	90-50-750
-60	26.18 (665)	90-50-800

Guide troughs are used with applications where the upper run of the e-chain® glides on the lower run. If using igus® steel guide troughs, the following components are required:

- Full travel length of guide trough
Part No. 90-30
- 1/2 travel length glide bars
Part No. 90-31
- Installation sets as end connectors
Part No. 90-50-XX

-XX indicates the length of the profile rails on which the guide trough is mounted. The values and part numbers are specified in the table on the right. Standard length of the trough components and glide bars is 6.56 ft (2m). The required overall length of the guide trough directly correlates to the length of travel.

Example:
 Length of travel 164 ft (50m)
 Center mounted

Required guide troughs:
 164 ft (50 m) guide trough
 82 ft (25 m) glide bars
 = 25 sections of (2 m) guide trough without glide bars **Part No. 90-30**
 = 13 section of (2 m) guide troughs with glide bars **Part No. 90-31**

Required number of installation sets:
 = Number of guide trough components + 1
 = 25 + 1 = 26
 Part number of the installation sets **90-50-XXX**

Example:
 90-50-400 for (400 m) long profile rail



Left: Guide trough with glide bars
 Right: Guide troughs without glide bars



Installation sets as section connectors

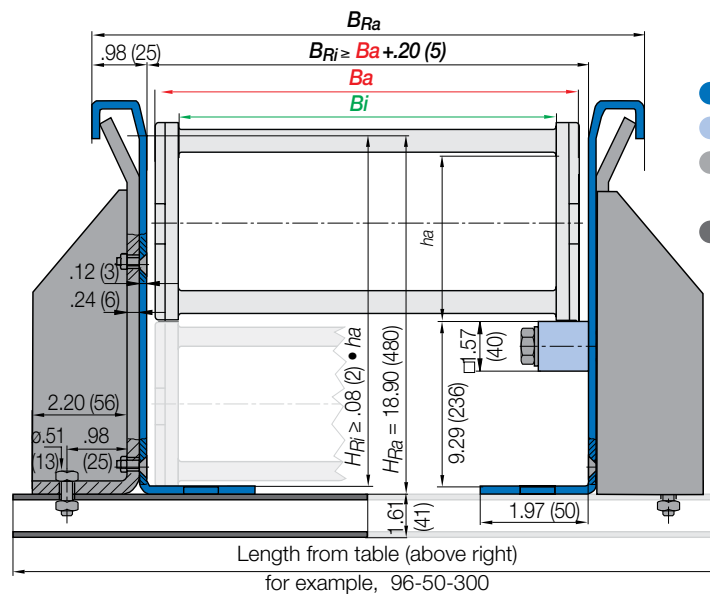

- Guide trough
- Glide bars
- Installation set "Basic"
- Profile rail

Length from table (above right)
 for example, 96-50-300

Individual attachment without profile rail

* Specialized guide trough available upon request

For further technical information on guide troughs
 ➤ Chapter 9

Standard length profile rail

Price Index

Series E4-350

Special Options Available

Very high fill weights
possible > 100 kg/m



Very huge interior,
inner height 13.78" (350 mm),
inner width up to 39.37" (1000 mm)

Features & Benefits

- 1 Electrically insulating
- 2 The world's largest* all-plastic e-chain® (*issue 10/2008, available from 2009)
- 3 Maintenance-free - no grease or oil needed to lubricate the joints
- 4 Designed to carry thick, heavy and stiff cables and hoses
- 5 Ideal for rough use on oil platforms, in steel plants, or in heavy duty machinery
- 6 Steel mounting brackets, also available in stainless steel upon request
- 7 Solid crossbars made from high-tech polymer
- 8 Tongue and groove design provides greater lateral stability
- 9 Modular design saves assembly time
- 10 Interior separation available
- 11 Highly resistant to wear, corrosion and sea water
- 12 Plastic material reduces noise

Usage Guidelines

- If a maintenance-free offshore e-chain® is required
- If no use of oil and grease is needed
- If electrical insulation is necessary
- If resistance to corrosion and sea water is required
- If 100% plastics is the first choice for your application

Order Example: Complete e-chain®

Please indicate chain length or number of links. Example:

16.4 ft (5 m) **E4-350-200-500-0****e-chain®**With 2 separators **351-1F** assembled every 2nd link**Interior Separation**1 Set **E4-350100-1-12****Mounting Bracket**

e-chain system® E4-1

Series E4-350

Installation Dimensions



E4-350

Short travel, unsupported length

- FL_B = unsupported with permitted sag
- FL_G = unsupported with straight upper run

Further information

► Design, Chapter 1

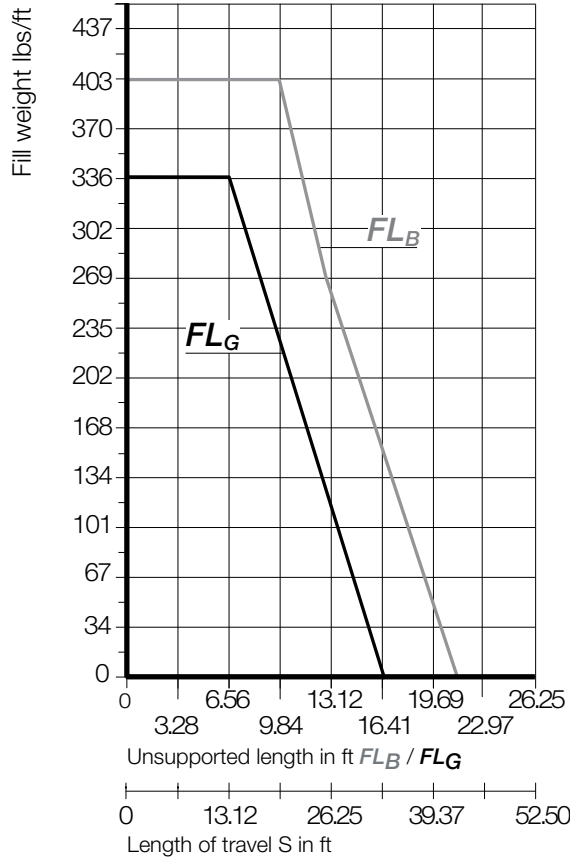
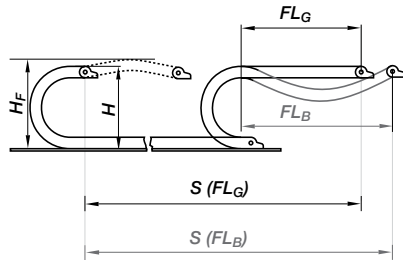

Short Travels - Unsupported



Unsupported e-chains® feature positive camber over short travels. This must be accounted for when specifying the clearance height. Please refer to **Installation dimensions** for further details.

Legend

- S = Length of travel
- R = Bending radius
- H = Nominal clearance height
- D = Overlength e-chain® radius in final position
- $K = \pi \cdot R + \text{safety buffer}$
- H_f = Required clearance height

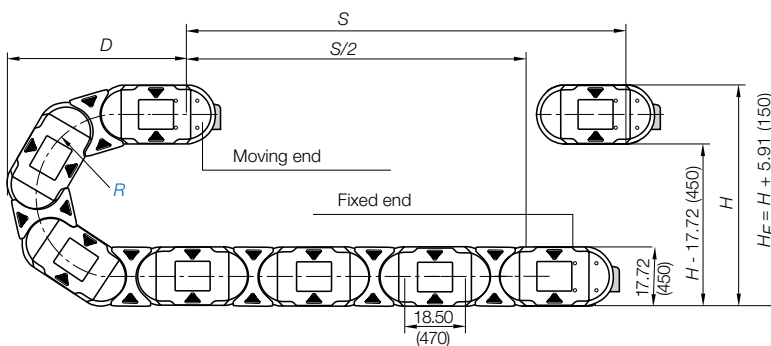

Pitch per link = 18.50" (470 mm)
 Links per ft (m) = .64 (2)
 For center mount applications:
 Chain length = $\frac{S}{2} + K$

The required clearance height: $H_f = H + 5.91$ in. (150 mm)

R	19.69 (500)	29.53 (750)	39.37 (1000)
H^*	57.09 (1450)	76.77 (1950)	96.46 (2450)
D	56.30 (1430)	66.14 (1680)	75.98 (1930)
K	99.02 (2515)	129.92 (3300)	160.83 (4085)

Material - permitted temperature
 Flammability Class, igumid G

igumid G / -40°F (-40°C) up to +248°F (+120° C)
 VDE 0304 IIC UL94 HB

Technical Data



Details of material properties

► Chapter 1

PDF: igus.com/e-chain-pdfs
 Product information: igus.com/e-chains

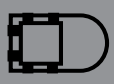

Series E4-350 - e-chain® with crossbars every link

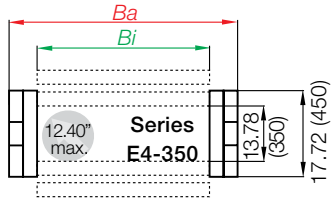

- Crossbars every link
- For rigid hydraulic hoses
- For particularly demanding applications
- Can be opened from both sides

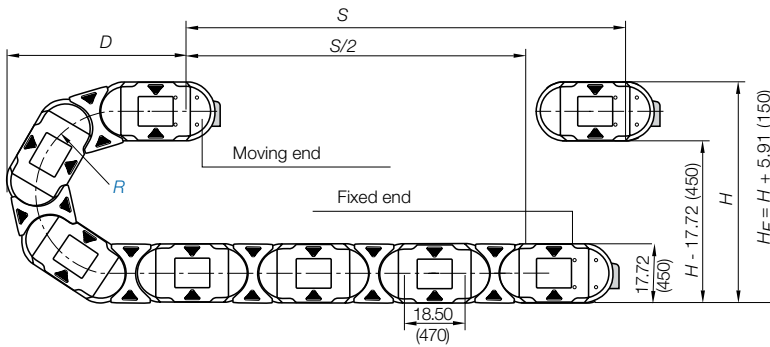

Part Number Structure

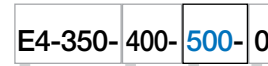

- Color - Black
- Bending radius
- Width
- Series

Supplement part number with required radius. Example: E4-350-200-**500**-0
Pitch: 18.50 in. (470 mm) per link links/ft(m) = .64 (2)

Part Number.

Crossbars		<i>Bi</i>	<i>Ba</i>	E4-350(61.9)
Every link		in. (mm)	in. (mm)	lbs/ft (kg/m)
E4-350-400 -	<input type="text"/> -0	15.75 (400)	21.26 (540)	41.59 (61.9)
E4-350-500 -	<input type="text"/> -0	19.69 (500)	25.20 (640)	44.15 (65.7)
E4-350-600-	<input type="text"/> -0	23.62 (600)	29.13 (740)	46.77 (69.6)
E4-350-700 -	<input type="text"/> -0	27.56 (700)	33.07 (840)	49.32 (73.4)
E4-350-800 -	<input type="text"/> -0	31.50 (800)	37.01 (940)	51.88 (77.2)

Choose from the radii below for all of the above sizes

Radius (mm) Example: E4-350-400-**500**-0

	500	750	1000
<i>R</i>	19.69 (500)	29.53 (750)	39.37 (1000)
<i>H*</i>	57.09 (1450)	76.77 (1950)	96.46 (2450)
<i>D</i>	56.30 (1430)	66.14 (1680)	75.98 (1930)
<i>K</i>	99.02 (2515)	129.92 (3300)	160.83 (4085)

0 = Standard color black. For other colors see Chapter 1

e-chain system® E4-1
Series E4-350
Interior Separation

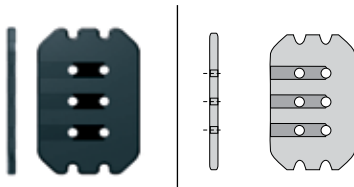
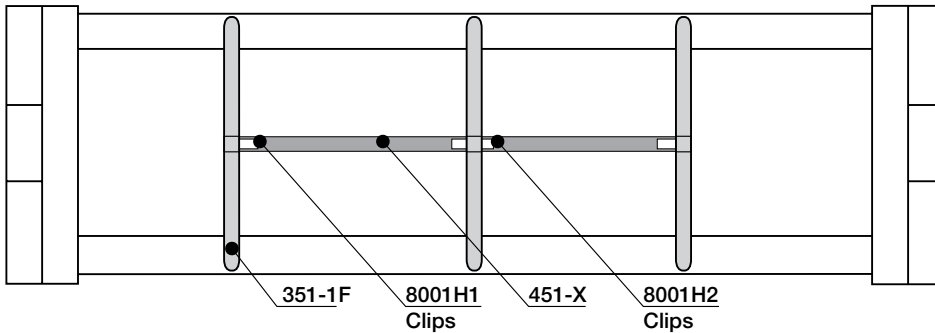

Separator for vertical subdivision
For a vertical subdivision in 3 positions

unassembled	350.1F
assembled	351.1F

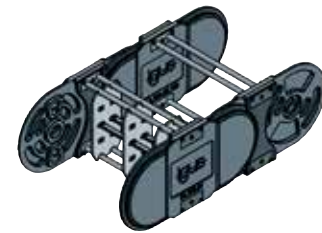

Heavy duty interior separation for cable-safe guidance



Shelf for horizontal subdivision
For horizontal separation with clip separators for vertical subdivision. Horizontal shelves of various widths can be arranged at 3 different positions

unassembled	450-X
assembled	451-X

Width X in. (mm)	Part No. unassembled	Part No. assembled	Width X in. (mm)	Part No. unassembled	Part No. assembled
1.97 (50)	450-50	451-50	12.28 (312)	450-312	451-312
2.56 (65)	450-65	451-65	12.80 (325)	450-325	451-325
2.95 (75)	450-75	451-75	13.27 (337)	450-337	451-337
3.43 (87)	450-87	451-87	13.78 (350)	450-350	451-350
3.94 (100)	450-100	451-100	14.25 (362)	450-362	451-362
4.41 (112)	450-112	451-112	14.76 (375)	450-375	451-375
4.92 (125)	450-125	451-125	15.24 (387)	450-387	451-387
5.39 (137)	450-137	451-137	15.75 (400)	450-400	451-400
5.91 (150)	450-150	451-150	16.22 (412)	450-412	451-412
6.38 (162)	450-162	451-162	16.73 (425)	450-425	451-425
6.89 (175)	450-175	451-175	17.20 (437)	450-437	451-437
7.36 (187)	450-187	451-187	17.72 (450)	450-450	451-450
7.87 (200)	450-200	451-200	18.19 (462)	450-462	451-462
8.34 (212)	450-212	451-212	18.70 (475)	450-475	451-475
8.85 (225)	450-225	451-225	19.17 (487)	450-487	451-487
9.33 (237)	450-237	451-237	19.69 (500)	450-500	451-500
9.84 (250)	450-250	451-250	20.16 (512)	450-512	451-512
10.31 (262)	450-262	451-262	20.67 (525)	450-525	451-525
10.83 (275)	450-275	451-275	21.14 (537)	450-537	451-537
11.30 (287)	450-287	451-287	21.65 (550)	450-550	451-550
11.81 (300)	450-300	451-300	23.62 (600)	450-600	451-600

PDF: igus.com/e-chain-pdfs
Product information: igus.com/e-chains



Moving end

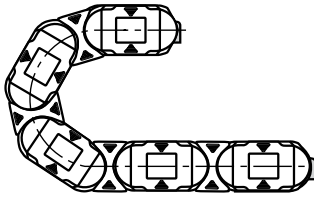

Fixed end



E4-350100-1
Moving end

E4-350100-1
Fixed end

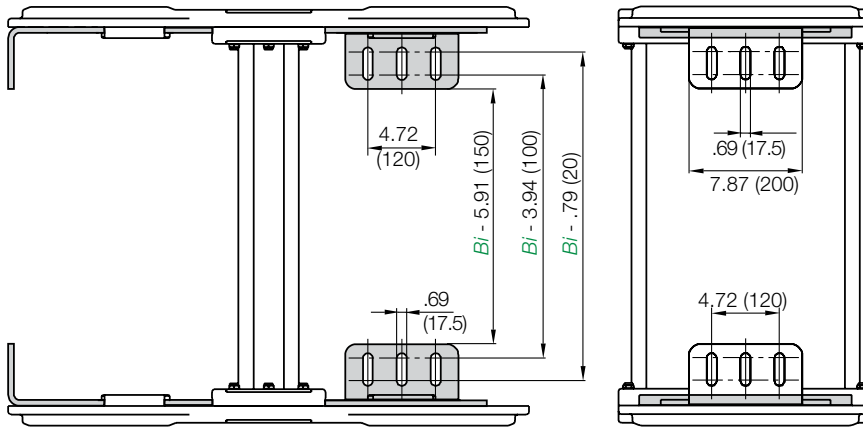

Steel mounting brackets

E4-350100-1-12-SS	Full set (both sides) for e-chain®, ending with outer side link (4 pieces)
E4-350100-1-SS	Mounting bracket set (one side) for outer side link (2 pieces)

Stainless steel version available please add suffix **-SS**
(Material: stainless steel 1.4301)

Note: By ordering steel mounting brackets in combination with an e-chain® / e-tube, they will be delivered assembled!

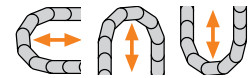

- For pivoting connections
- Secure connection
- One part (two-piece) for all e-chain® widths
- Electrically conductive



Robust steel mounting bracket for secure mounting and connection

e-chain system® E4-1
Series E4-350



E4-350

igus®
e-chain system®

Telephone 1-800-521-2747

Internet: igus.com
email: sales@igus.com
QuickSpec: igus.com/quickspec





igus[®]
E4-1 light

E4-1 light

High dynamics, light and cost- effective

All around e-chains® and e-tubes for high dynamics. The E4-1 light series was developed to combine the advantages of the E2/000 and the E4-1 series. The stability of the E4-1 system and the ease of accessibility of the E2/000. The stability and price of the E4-1 light falls between these systems and makes it the perfect alternative for your application.

- Weight reduction and high stability at the same time
- 30% lighter and lower-priced than E4-1
- Crossbars, lid and shelves pivotable on either side
- Very tightly fitting lids and bottoms, virtually no gaps and openings
- Snap-open along the inner and outer radius
- Ideal ratio of internal and external dimensions due to thinner outer links and optimized crossbar design
- Inner diameter completely accessible for easy filling

Typical industries and applications

- Machine tools
- General mechanical engineering



Low noise operation due to integrated “brakes”



ESD classification: Electrically conductive
ESD/ATEX version upon request



High torsional rigidity





New snap-open mechanism, Series E4-1 and R4-1 Light, choice of snap-open on left or right



Denseness test at the igus® lab: High chip protection in the test. Stop-dogs completely free of chips



Lightweight, stable E4-1 light e-chains® now available as a closed e-tube. Very tight closing, rounded lids

e-chain system® E4-1 light Selection Guide



Crossbars every link

Crossbars on both sides pivotable, snap-open along the inner and outer radius

Series	Inner height <i>hi</i> in. (mm)	Inner width <i>Bi</i> in. (mm)	Outer width <i>Ba</i> in. (mm)	Outer height <i>ha</i> in. (mm)	Bending radius <i>R</i> in. (mm)
E4-31L	1.22 (31)	1.57-6.89 (40-175)	2.13-7.44 (54-189)	1.65 (42)	2.16-9.84 (55-250)
E4-38L	1.50 (38)	1.97-11.81 (50-300)	2.60-12.44 (66-316)	2.13 (54)	2.48-11.81 (63-300)
E4-48L	1.89 (48)	1.97-11.81 (50-300)	2.76-12.60 (70-320)	2.52 (64)	2.95-13.78 (75-350)
E4-64L	2.52 (64)	3.43-7.87 (87-200)	4.45-7.91 (113-201)	3.31 (84)	3.94-15.75 (100-400)



e-tubes

Fully enclosed, lids on both sides pivotable, snap-open along the inner and outer radius

Series	Inner height <i>hi</i> in. (mm)	Inner width <i>Bi</i> in. (mm)	Outer width <i>Ba</i> in. (mm)	Outer height <i>ha</i> in. (mm)	Bending radius <i>R</i> in. (mm)
R4-31L	1.22 (31)	1.97-3.94 (50-100)	2.52-4.49 (64-114)	1.65 (42)	2.95-9.84 (075-250)
R4-38L	1.50 (38)	1.97-9.84 (50-250)	2.60-10.47 (66-266)	2.13 (54)	4.92-11.81 (125-300)
R4-48L	1.89 (48)	2.95-9.84 (50-250)	2.76-10.63 (70-270)	2.52 (64)	4.92-13.78 (125-350)

E4-1 light e-chains® - options and accessories



pivoting and locking KMA connection elements possible



Extender crossbars increase the inner height by 1.91" (48.5 mm)



Guide troughs available in steel or aluminum versions



New, particularly cable-friendly interior separation program available

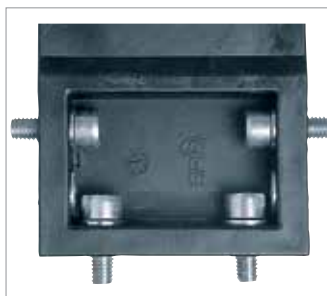

KMA mounting brackets with attachment options on all sides

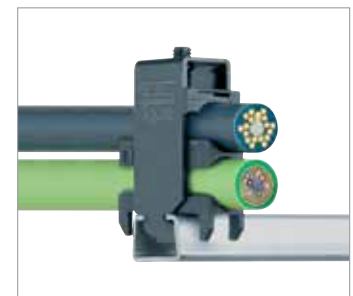

Wide variety of strain relief options available

e-chain system® E4-1 light Assembly instructions

E4-1 light e-chains® - Assembly



1 Line up the two inner side links, side by side



2 Attach an outer side link between and push side links together

E4-1 light e-chains® - Assembly



3 Snap the crossbars into place

E4-1 light e-chains® - Opening



4 To open, place screwdriver on the inside of the fastening mechanism and pry to the outside.



Available from stock. Orders ship as early as today.*

*On average 90% of orders ship the same day..

Price Index



Special Options Available

- Low noise version available with special rubber pads
- Cleanroom test upon request
- ESD classification: Electrically conductive ESD/ATEX version upon request

Assembly Tips



Opening To open, insert the screwdriver into the locking mechanism and pry it open outwards

Other Installation Methods

- Vertical, hanging ≤ 131 ft (40 m)
- Vertical, standing ≤ 8.20 ft (2.5 m)
- Side-mounted, un supp. ≤ 1.99 ft (0.6 m)
- Rotary requires further calculation

Usage Guidelines

- If a lightweight, cost-effective e-chain® for high dynamics is required
- If very tight fitting lids and bottoms are required
- If short assembly times are required
- If optimized interior-exterior dimensions ratio is needed

- When the e-chain® needs to be extremely quiet (32dB(A)) with very low vibration
 - Series E6-1, Chapter 7
- When the e-chain® is to be used in cleanrooms (cleanroom ISO class 1)
 - Series E6-1, Chapter 7
 - If even higher strength is required
 - Series E4-1, Chapter 6

Features & Benefits

- 1 KMA mounting brackets with attachment points on all sides
- 2 Easy filling: inner diameter completely accessible
- 3 High stability due to undercut design
- 4 Efficient: less weight, enhanced dynamics
- 5 Notch crossbar with visual scale
- 6 Short assembly time: pivotable crossbars, snap-open along the inner and outer radius
- 7 Numerous interior separation possibilities
- 8 Straight run due to inner/outer link design
- 9 Chip protection: very tightly fitting lids and bottoms
- 10 Version NCST “without camber” simply by turning outer links without unnecessary rework

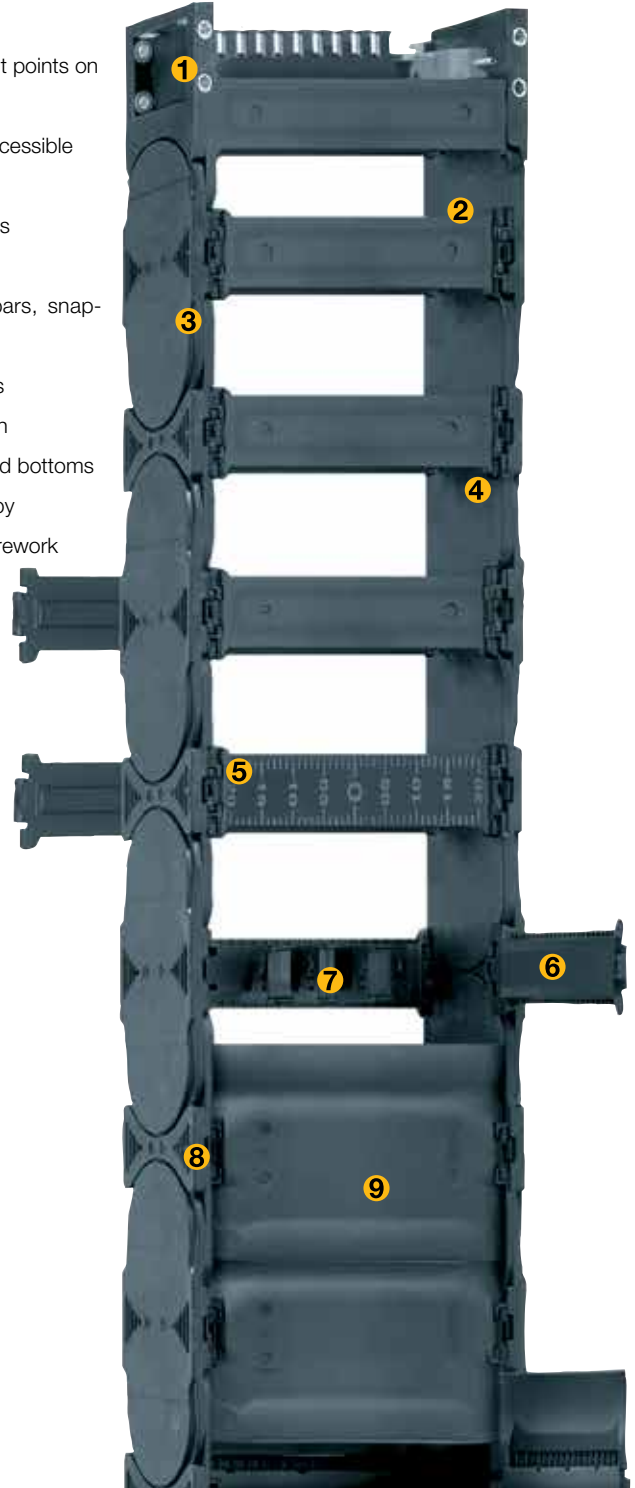

Also available without camber. Add NCST to the end of the part number.
Ex: E4-31L-100-200NCST

Order Example: Complete e-chain®

Please indicate chain length or number of links. Example:

13.12 ft (4 m) **E4-31L-100-200-0**

e-chain®

With 2 separators **31-1-1** assembled every 2nd link

Interior Separation

1 Set **E4-310-100-12P**

Mounting Bracket

e-chain system® E4-1 light Series E4-31L/R4-31L Installation Dimensions



E4-31L
R4-31L

Short travel, unsupported length

- FL_B = unsupported with permitted sag
 - FL_G = unsupported with straight upper run
- Further information ► Design, Chapter 1

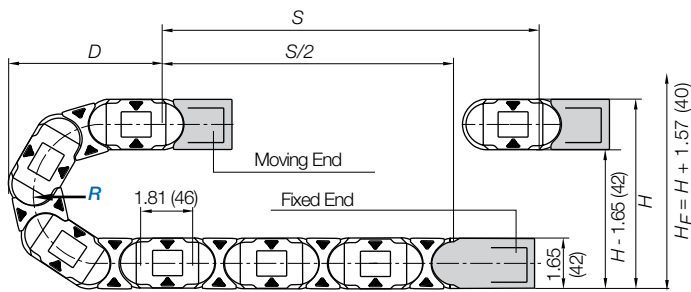
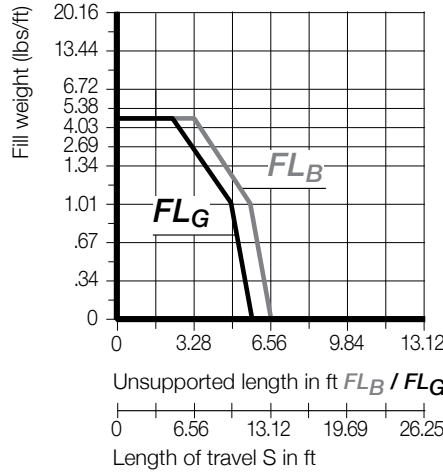
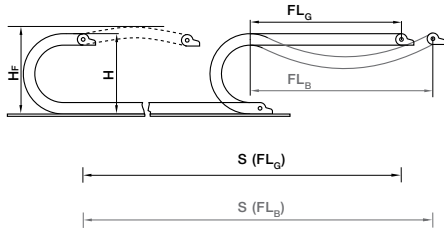

Pitch per link: = 1.81" (46 mm)
Links per ft (m): = 6.6 (22)
For center mount applications:
Chain length = $S/2 + K$

The required clearance height: $H_F = H + 1.57$ in. (40 mm) (with .67 lbs/ft (1.0 kg/m) fill weight. Please consult igus® if space is particularly restricted.

R	2.16 (055")	2.48 (063')	2.95 (075)	3.94 (100)	4.92 (125)	5.91 (150)	6.89 (175)	7.87 (200)	9.84 (250)
H	5.98 (152)	6.61 (168)	7.56 (192)	9.52 (242)	11.50 (292)	13.46 (342)	15.43 (392)	17.40 (442)	21.34 (542)
D	5.71 (145)	6.02 (153)	6.50 (165)	7.48 (190)	8.46 (215)	9.45 (240)	10.43 (265)	11.42 (290)	13.39 (340)
K	10.43 (265)	11.42 (290)	12.99 (330)	16.14 (410)	19.09 (485)	22.24 (565)	25.39 (645)	28.54 (725)	34.65 (880)

1) Radius not available for e-tubes

For support of the lower run, see Chapter 9 of the main catalog for the Support Tray tool kit

Short Travels - Unsupported



Unsupported e-chains® feature positive camber over short travels. This must be accounted for when specifying the clearance height. Please refer to for further details.

Legend

- S = Length of travel
- R = Bending radius
- H = Nominal clearance height
- D = Overlength e-chain® radius in final position
- $K = \pi \cdot R + \text{safety buffer}$
- H_F = Required clearance height
- H_{RI} = Trough inner height
- H_2 = *Mounting height
- D_2 = Overlength - long travels, gliding
- K_2 = *Add-on
- *If the mounting bracket location is set lower

PDF: igus.com/e-chain-pdfs
Product information: igus.com/e-chains



Speed / acceleration FL_G	max. 65.6 ft/s (20 m/s) / max. 656 ft/s ² (200 m/s ²)
Speed / acceleration FL_B	max. 9.84 ft/s (3 m/s) / max. 19.69 ft/s ² (6 m/s ²)
Gliding speed / acceleration (maximum)	max. 16.4 ft/s (5 m/s) / max. 82 ft/s ² (25 m/s ²)
Material - permitted temperature	igumid G / -40°F (-40°C) up to +248°F (+120° C)
Flammability Class, igumid G	VDE 0304 IIC UL94 HB

Technical Data



Details of material properties

► Chapter 1

6.144

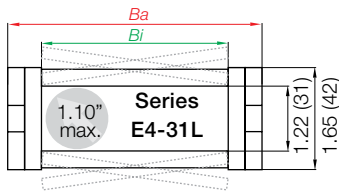

Series E4-31L - e-chain® with crossbars every link

- Crossbars every link
- For use with rigid hydraulic hoses
- For particularly demanding applications
- Can be opened from both sides



Part Number Structure

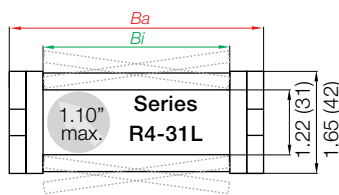
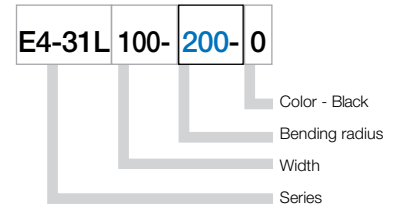

Series R4-31L - fully enclosed e-tube

- Fully enclosed
- Excellent cable and hose protection against dirt
- Protection against hot chips
- Lids along inner radius are completely removable
- Lids along the outer radius are single-sided, snap open, hinged on one side as well as completely removable



Part Number Structure

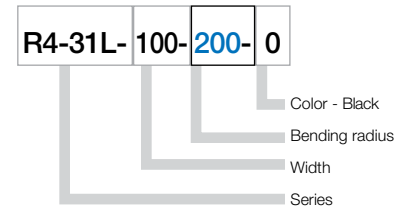

e-chain® as separate parts, links and side plates

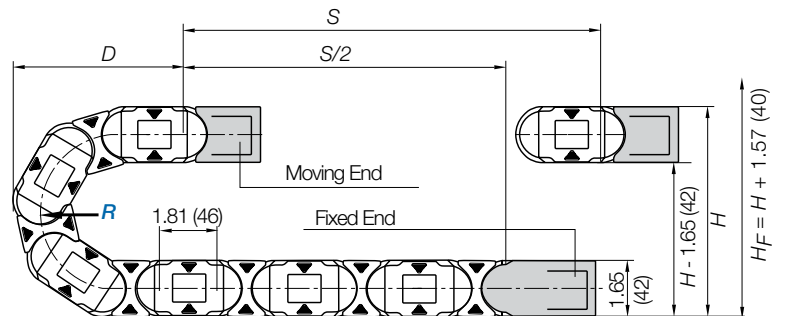
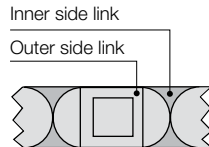
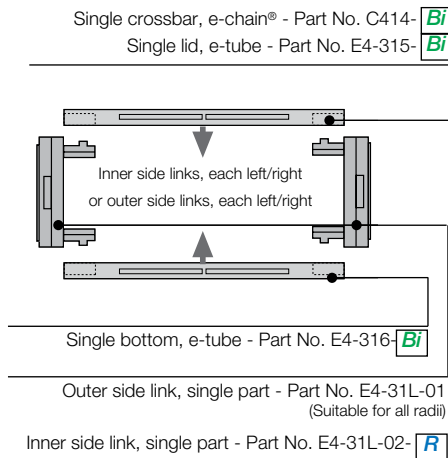

e-chain system® E4-1 light

Series E4-31L/R4-31L

Product Range



E4-31L
R4-31L

Supplement part number with required radius. Example: E4-31L-100--0
Pitch: 1.81 in. (46 mm) per link links/ft (m) = 6.6 (22)

Part Number			Weight			
Crossbars	Tube		<i>Bi</i>	<i>Ba</i>	E4-31L	R4-31L
Every link	Version		in. (mm)	in. (mm)	lbs/ft (kg/m)	lbs/ft (kg/m)
E4-31L-040-		<input type="text" value=""/> -0	1.97 (40)	2.13 (54)	≈ 0.47 (0.70)	–
E4-31L-050-	R4-31L-050-	<input type="text" value=""/> -0	1.97 (50)	2.52 (64)	≈ 0.54 (0.74)	≈ 0.58(0.87)
E4-31L-062-		<input type="text" value=""/> -0	2.44 (62)	2.99 (76)	≈ 0.51 (0.76)	–
E4-31L-075-		<input type="text" value=""/> -0	2.95 (75)	3.50 (89)	≈ 0.52 (0.78)	≈ 0.68(1.01)
E4-31L-087-		<input type="text" value=""/> -0	3.94 (87)	3.98 (101)	≈ 0.56 (0.83)	–
E4-31L-100-	R4-31L-100-	<input type="text" value=""/> -0	3.94 (100)	4.49 (114)	≈ 0.59 (0.88)	≈ 0.74(1.10)
E4-31L-112-		<input type="text" value=""/> -0	4.41 (112)	4.96 (126)	≈ 0.62 (0.93)	–
E4-31L-125-		<input type="text" value=""/> -0	4.92 (125)	5.47 (139)	≈ 0.64 (0.96)	≈ 0.86 (1.28)
E4-31L-150-		<input type="text" value=""/> -0	5.91 (150)	6.46 (164)	≈ 0.67 (1.00)	≈ 0.94 (1.40)
E4-31L-162-		<input type="text" value=""/> -0	6.38 (162)	6.93 (176)	≈ 0.70 (1.04)	–
E4-31L-175-		<input type="text" value=""/> -0	6.89 (175)	7.44 (189)	≈ 0.75 (1.13)	≈ 1.04 (1.55)

Choose from the radii below for all of the above sizes

Radius (mm) Example: E4-31L-100--0

	055 ¹⁾	063 ¹⁾	075	125	150	175	200	250	300
<i>R</i>	2.16 (055 ¹⁾)	2.48 (063 ¹⁾)	2.95 (075)	3.94 (100)	4.92 (125)	5.91 (150)	6.89 (175)	7.87 (200)	9.84 (250)
<i>H</i>	5.98 (152)	6.61 (168)	7.56 (192)	9.52 (242)	11.50 (292)	13.46 (342)	15.43 (392)	17.40 (442)	21.34 (542)
<i>D</i>	5.71 (145)	6.02 (153)	6.50 (165)	7.48 (190)	8.46 (215)	9.45 (240)	10.43 (265)	11.42 (290)	13.39 (340)
<i>K</i>	10.43 (265)	11.42 (290)	12.99 (330)	16.14 (410)	19.09 (485)	22.24 (565)	25.39 (645)	28.54 (725)	34.65 (880)

1) Radius not available for e-tubes

For other colors see Chapter 1

PDF: igus.com/e-chain-pdfs
Product information: igus.com/e-chains



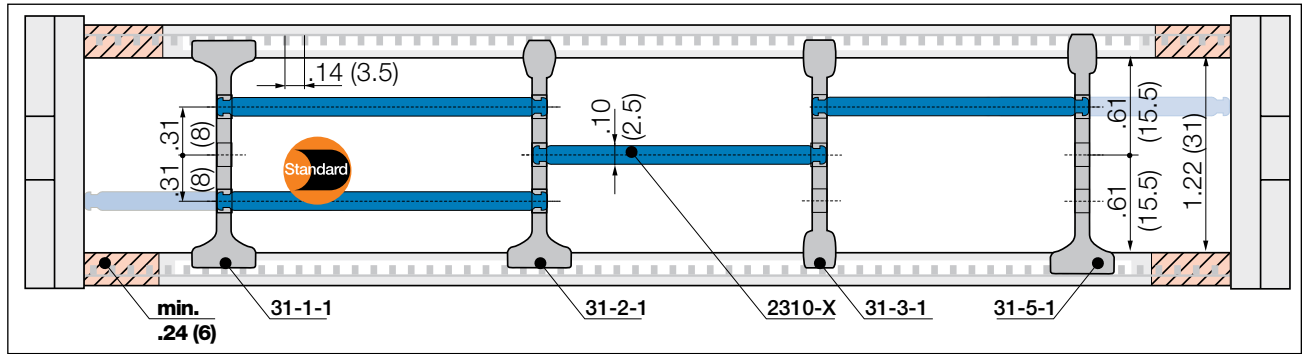

Note e-tube: Please maintain a lateral spacing of .24" (6 mm) between the separators and the side links. In the standard configuration separators are assembled every 2nd e-chain® link

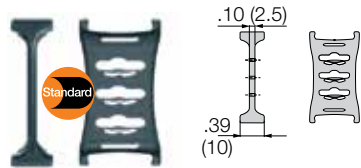

Separator, wide base

Unassembled	Part No. 31-1
Assembled	Part No. 31-1-1

- **Standard separator 31-1 for all applications**

Separator with wide base for maximum locking strength and safe standing in e-chains® and e-tubes.

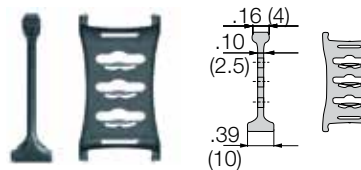

Separator, narrow head

Unassembled	Part No. 31-2
Assembled	Part No. 31-2-1

- **Separator 31-2**

For even faster installation

Firm hold to one side with a wide base, narrow on opposed side for easy cable assembly (slight grip).

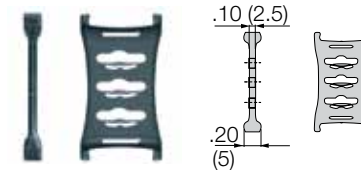

Separator, narrow base

Unassembled	Part No. 31-3
Assembled	Part No. 31-3-1

- **Separator 31-3**

For many thin cables

Separator with a narrow base for a large number of thin cables side by side. Saves space in e-chains®.



Notch separator for notch crossbar

Unassembled	Part No. 31-5
Assembled	Part No. 31-5-1

- **Separator 31-5**

Locks safely in preset increments

Notch separator for exact positioning in e-chains®. Recommended for side-mounted applications.

Lockable full-width shelves - for the standard interior separation

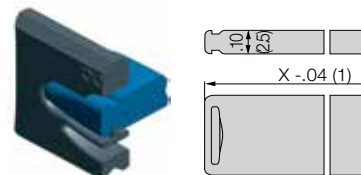

Full width shelf, lockable

Unassembled	Part No. 2300-X
Assembled	Part No. 2310-X

- **Full width shelf, lockable**

Shelf locks safely into separators on both ends, fixed width possible. Can be used as full width or partial shelf

Width X in. (mm)	Part No. Unassembled	Part No. Assembled	Width X in. (mm)	Part No. Unassembled	Part No. Assembled	Width X in. (mm)	Part No. Unassembled	Part No. Assembled
(015)	2300-015	2310-015	(060)	2300-060	2310-060	(087)	2300-087	2310-87
(025)	2300-025	2310-025	(062)	2300-062	2310-062	(090)	2300-090	2310-90
(030)	2300-030	2310-030	(065)	2300-065	2310-065	(100)	2300-100	2310-100
(038)	2300-038	2310-038	(070)	2300-070	2310-070	(103)	2300-103	2310-103
(040)	2300-040	2310-040	(075)	2300-075	2310-075	(110)	2300-110	2310-110
(050)	2300-050	2310-050	(077)	2300-077	2310-077	(120)	2300-120	2310-120
(057)	2300-057	2310-057	(080)	2300-080	2310-080	(125)	2300-125	2310-125

e-chain system® E4-1 light
Series E4-31L/R4-31L
Interior Separation



E4-31L
R4-31L

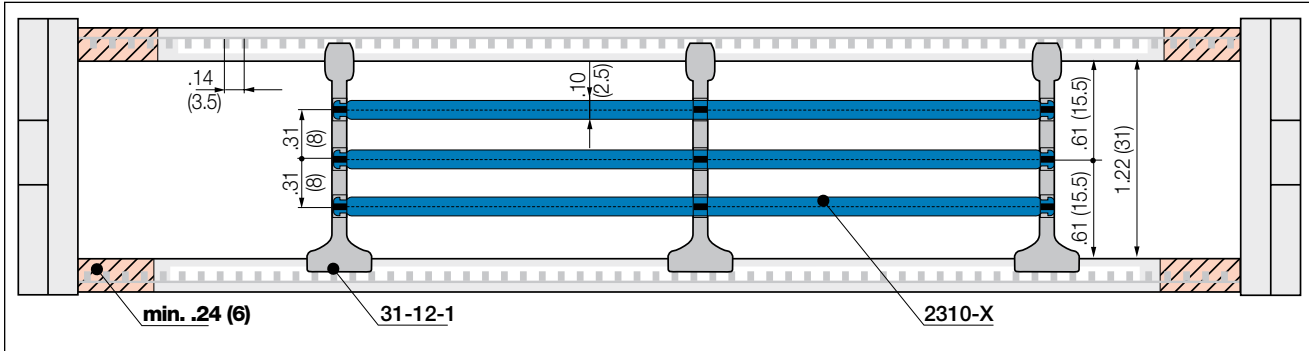

 Note e-tube: Please maintain a lateral spacing of .24" (6 mm) between the separators and the side links. In the standard configuration separators are assembled every 2nd e-chain® link

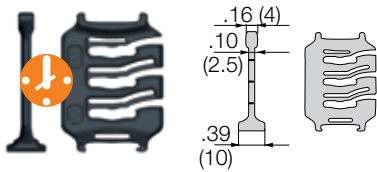

Lean Separator

Unassembled	Part No. 31-12
Assembled	Part No. 31-12-1

• **Lean separators 31-12**

New design allows extremely fast fitting of shelves in several layers, which significantly reduces assembly time. Enables extremely fast replacement of individual cables in a very full e-chain®.



• **Lean separator design - several layers of cables fitted quickly, save up to 50%* assembly time**

(*Lean separator vs. standard separator - measured on a 4m long e-chain® fitted with 12 cables in the igus® harnessing factory)

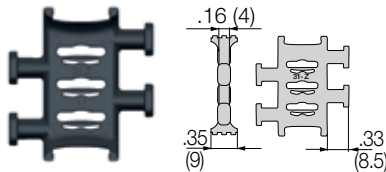

Separator with integrated strain relief

Unassembled	Part No. 31-Z
Assembled	Part No. 31-Z-1

• **Separator 31-Z with integrated strain relief**

Can be integrated into the mounting bracket or placed at any point in the e-chain®. Combines strain relief and interior separation, for restricted space conditions. Strain relief separator is easy to assemble without any tools

PDF: igus.com/e-chain-pdfs
Product information: igus.com/e-chains



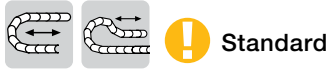

Option 1: pivoting

- Recommended for unsupported and gliding applications
- Attachment capability on all sides
- Bolted connection outside of chain cross-section
- Space restricted conditions
- Corrosion resistant

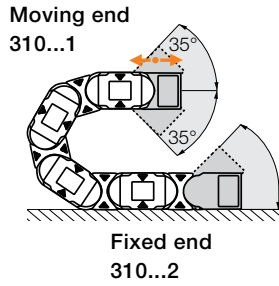

Pivoting angle depends on radius

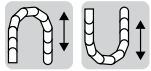
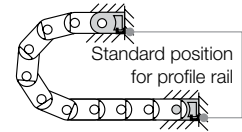

Option 2: locking

- Profile rail option
- Universal use
- Corrosion resistant
- Vertical hanging/standing travels
- Extreme accelerations

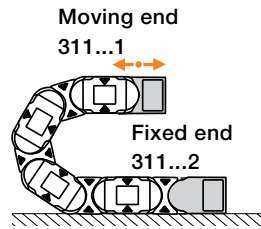

Pivoting angle depends on radius

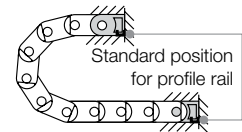

Part Number Structure

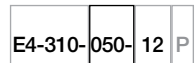

- With Profile Rail
- Complete Set
- Width
- E4-310 = Pivoting for chain
- E4-311 = Locking for chain

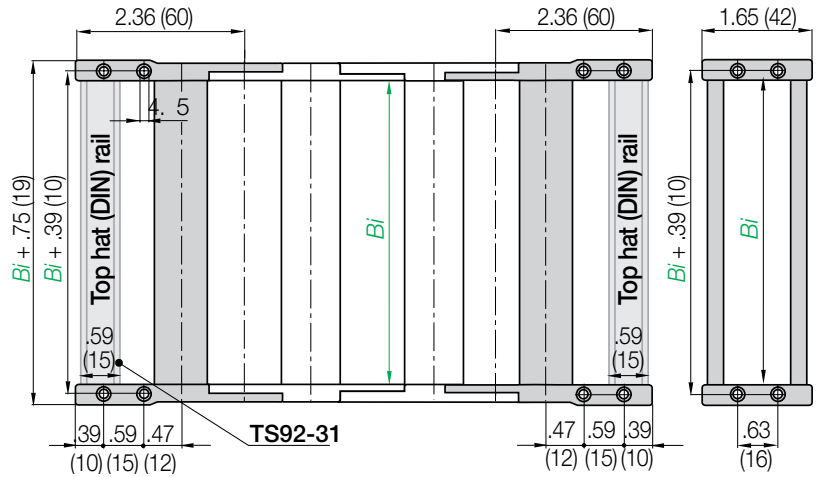

Due to the design of the E4-31L series chains, please note the following when ordering brackets:
Even number of links = full set, part number ending in -12; Odd number of links = 2 pieces, part number ending in -1

Part number examples are shown for pivoting brackets for e-chain.
For locking brackets change part number to 311

Part No. Full Set (pivoting)
Series E4-31L
E4-310-Width-12

Part No. Full Set (pivoting)
with profile rail
Series E4-31L
E4-310-Width-12P

Width	Part No. Full Set chain		With Profile Rail	Bi in. (mm)	Width	Part No. Full Set chain		With Profile Rail	Bi in. (mm)
	Pivoting	Locking				Pivoting	Locking		
-040	E4-310	E4-311	-040-12	P 1.57 (40)	-112	E4-310	E4-311	-112-12	P 4.41 (112.5)
-050	E4-310	E4-311	-050-12	P 1.97 (50)	-125	E4-310	E4-311	-125-12	P 4.92 (125)
-062	E4-310	E4-311	-062-12	P 2.68 (62.5)	-150	E4-310	E4-311	-150-12	P 5.91 (150)
-075	E4-310	E4-311	-075-12	P 2.95 (75)	-162	E4-310	E4-311	-162-12	P 6.38 (162.5)
-087	E4-310	E4-311	-087-12	P 3.43 (87.5)	-175	E4-310	E4-311	-175-12	P 6.61 (175)
-100	E4-310	E4-311	-100-12	P 3.94 (100)					

e-chain system® E4-1 light Series R4-31L Mounting Brackets - KMA



E4-31L
R4-31L

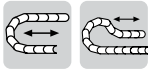

Standard

Option 1: pivoting

- Recommended for unsupported and gliding applications
- Attachment capability on all sides
- Bolted connection outside of chain cross-section
- Space restricted conditions
- Corrosion resistant

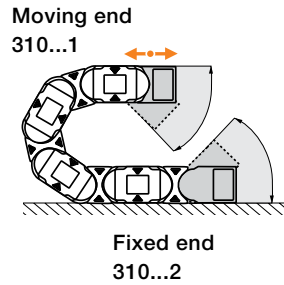

Pivoting angle depends on radius

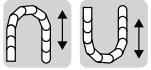
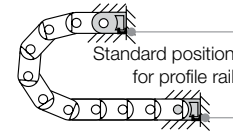

Option 2: locking

- Profile rail option
- Universal use
- Corrosion resistant
- Vertical hanging/standing travels
- Extreme accelerations

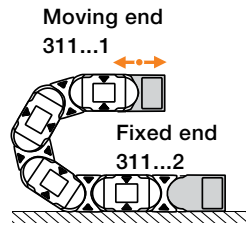

Pivoting angle depends on radius

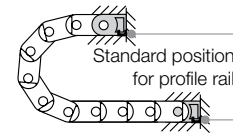

Part Number Structure

R4-310-050-12 P

- With Profile Rail
- Complete Set
- Width
- R4-310 = Pivoting for tube
- R4-311 = Locking for tube

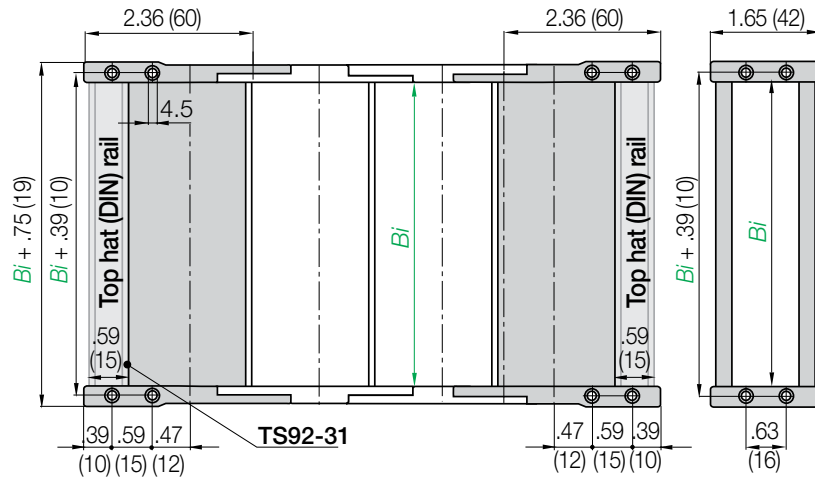

Due to the design of the R4-31L series chains, please note the following when ordering brackets:
Even number of links = full set, part number ending in -12; Odd number of links = 2 pieces, part number ending in -1

Part number examples are shown for pivoting brackets for e-chain.
For locking brackets change part number to 311

Part No. Full Set (pivoting)
Tube Series R4-31L
R4-310-Width-12

Part No. Full Set (pivoting)
with Profile Rail
Tube Series R4-31L
R4-310-Width-12P

Width	Part No. Full Set e-tube		With Profile Rail	Bi in. (mm)
	Pivoting	Locking		
-050	R4-310	R4-311	-050-12 P	1.97 (50)
-100	R4-310	R4-311	-100-12 P	3.94 (100)

PDF: igus.com/e-chain-pdfs
Product information: igus.com/e-chains



Chainfix clamps for the profile rail



igus® Chainfix strain relief elements are available in either steel or stainless steel. They can be adjusted with a hexagon socket and are available in single, double and triple configurations.

Part No. Single Clamp		Part No. Double Clamp		Part No. Triple Clamp		Cable ø	
Steel	Stainless	Steel	Stainless	Steel	Stainless	in.	(mm)
CFX12-1	CFX12-1E	CFX12-2	CFX12-2E	CFX12-3	-	.24 - .47	(06 - 12)
CFX14-1	CFX14-1E	CFX14-2	CFX14-2E	CFX14-3	-	.47 - .55	(12 - 14)
CFX16-1	CFX16-1E	CFX16-2	CFX16-2E	CFX16-3	-	.55 - .63	(14 - 16)
CFX18-1	CFX18-1E	CFX18-2	CFX18-2E	CFX18-3	-	.63 - .71	(16 - 18)
CFX20-1	CFX20-1E	CFX20-2	CFX20-2E	CFX20-3	-	.71 - .79	(18 - 20)
CFX22-1	CFX22-1E	CFX22-2	CFX22-2E	CFX22-3	-	.79 - .87	(20 - 22)
CFX26-1	CFX26-1E	CFX26-2	CFX26-2E	-	-	.87 - 1.02	(22 - 26)
CFX30-1	CFX30-1E	CFX30-2	CFX30-2E	-	-	1.02 - 1.18	(26 - 30)
CFX34-1	CFX34-1E	CFX34-2	CFX34-2E	-	-	1.18 - 1.34	(30 - 34)
CFX38-1	CFX38-1E	-	-	-	-	1.34 - 1.50	(34 - 38)
CFX42-1	CFX42-1E	-	-	-	-	1.50 - 1.65	(38 - 42)

For more information please refer to strain relief section of Chapter 10

Strain relief with tiewrap teeth



Part No.	For series	Inner height <i>hi</i> in. (mm)	For use in
CFV-31-N15	E4-31L/R4-31L	1.22 (31)	Top-hat (DIN) rail 15 (TS92.31)

PDF: igus.com/e-chain-pdfs
Product information: igus.com/e-chains



E4-38L
R4-38L



e-chain system® E4-1 light Series E4-38L/R4-38L

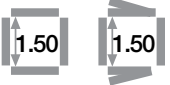

Price Index



Special Options Available

- Low noise version available with special rubber pads
- Cleanroom test upon request
- ESD classification: Electrically conductive ESD/ATEX version upon request

Assembly Tips



Opening To open, insert the screwdriver into the locking mechanism and pry it open outwards

Other Installation Methods

- Vertical, hanging ≤ 164 ft (50 m)
- Vertical, standing ≤ 9.84 ft (3 m)
- Side-mounted, un supp. ≤ 3.28 ft (1 m)
- Rotary requires further calculation

Usage Guidelines

- If a lightweight, cost-effective e-chain® for high dynamics is required
 - If very tight fitting lids and bottoms are required
 - If short assembly times are required
 - If optimized interior-exterior dimensions ratio is needed
- When the e-chain® needs to be extremely quiet (32dB(A)) with very low vibration
 - **Series E6-1, Chapter 7**
 - When the e-chain® is to be used in cleanrooms (cleanroom ISO class 1)
 - **Series E6-1, Chapter 7**
 - If even higher strength is required
 - **Series E4-1, Chapter 6**

Features & Benefits

- 1** KMA mounting brackets with attachment points on all sides
- 2** Easy filling: inner diameter completely accessible
- 3** High stability due to undercut design
- 4** Efficient: less weight, enhanced dynamics
- 5** Notch crossbar with visual scale
- 6** Short assembly time: pivotable crossbars, snap-open along the inner and outer radius
- 7** Numerous interior separation possibilities
- 8** Straight run due to inner/outer link design
- 9** Chip protection: very tightly fitting lids and bottoms
- 10** Version NCST “without camber” simply by turning outer links without unnecessary rework

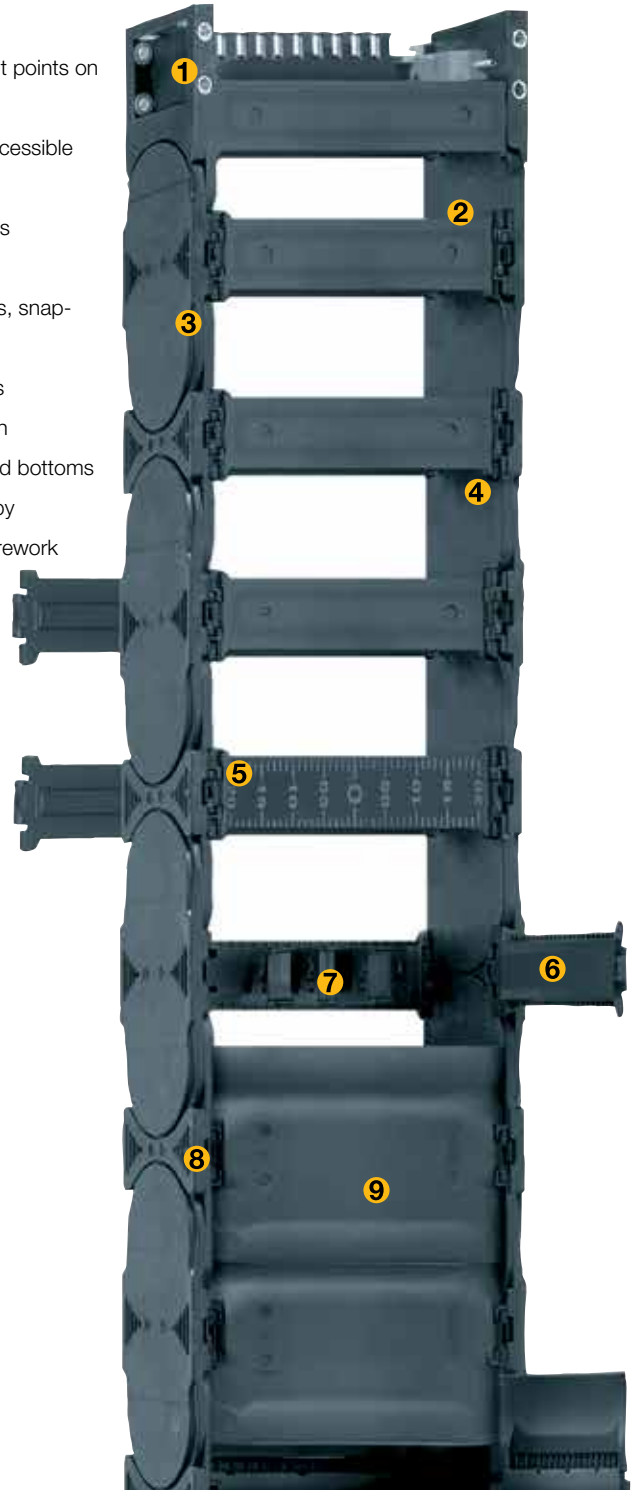

Also available without camber. Add NCST to the end of the part number.
Ex: E4-38L-100-200NCST

Order Example: Complete e-chain®

Please indicate chain length or number of links. Example:

13.12 ft (4 m) **E4-38L-100-200-0**

e-chain®

With 2 separators **38-1-1** assembled every 2nd link

Interior Separation

1 Set **E4-380-100-12P**

Mounting Bracket

e-chain system® E4-1 light Series E4-38L/R4-38L Installation Dimensions



E4-38L
R4-38L

Short travel, unsupported length

- FL_B = unsupported with permitted sag
 - FL_G = unsupported with straight upper run
- Further information ► Design, Chapter 1

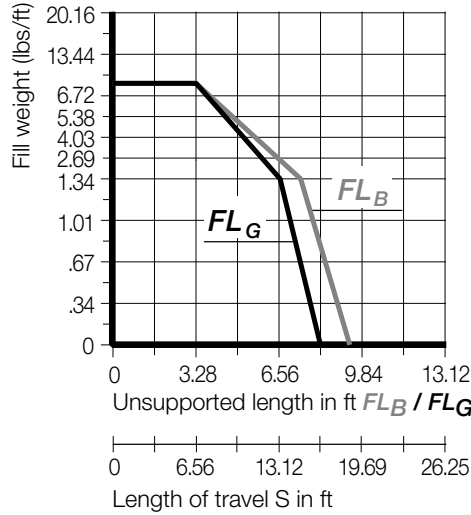
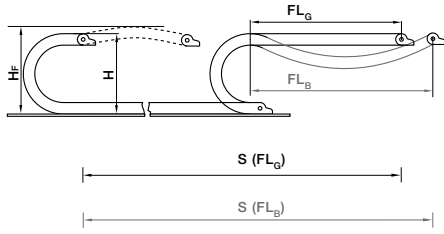

Short Travels - Unsupported

Unsupported e-chains® feature positive camber over short travels. This must be accounted for when specifying the clearance height. Please refer to for further details.

Legend

- S = Length of travel
 - R = Bending radius
 - H = Nominal clearance height
 - D = Overlength e-chain® radius in final position
 - $K = \pi \cdot R + \text{safety buffer}$
 - H_F = Required clearance height
 - H_{R1} = Trough inner height
 - H₂ = *Mounting height
 - D₂ = Overlength - long travels, gliding
 - K₂ = *Add-on
- *If the mounting bracket location is set lower

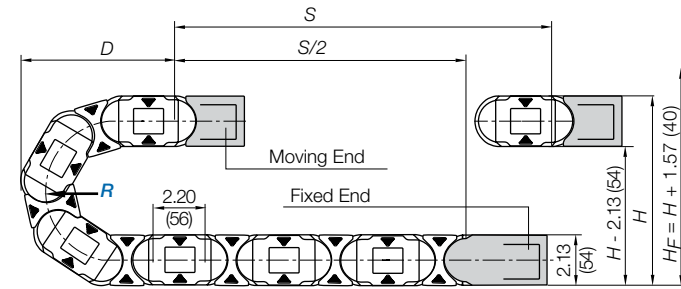

Pitch per link: = 2.20" (56 mm)
Links per ft (m): = 5.49 (18)
For center mount applications:
Chain length = $S/2 + K$

The required clearance height: $H_F = H + 1.57$ in. (40 mm) (with 1.34 lbs/ft (2.0 kg/m) fill weight. Please consult igus® if space is particularly restricted.

R	2.48 (063**)	2.95 (075**)	3.94 (100**)	4.92 (125)	5.91 (150)	6.89 (175)	7.87 (200)	9.84 (250)	11.81 (300)
H	7.09 (180)	8.03 (204)	10.00 (254)	11.97 (304)	13.94 (354)	15.91 (404)	17.87 (454)	21.81 (554)	25.75 (654)
D	6.85 (174)	7.32 (186)	8.31 (211)	9.29 (236)	10.28 (261)	11.26 (286)	12.24 (311)	14.21 (361)	16.18 (411)
K	12.20 (310)	13.78 (350)	16.93 (430)	19.88 (505)	23.03 (585)	26.18 (665)	29.33 (745)	35.43 (900)	41.54 (1055)

For long travels with lowered mounting height

Long travel lengths from 32.8 ft.(10m) to max. 262 ft. (80m)

For center mount applications:
Chain length: = $S/2 + K_2$

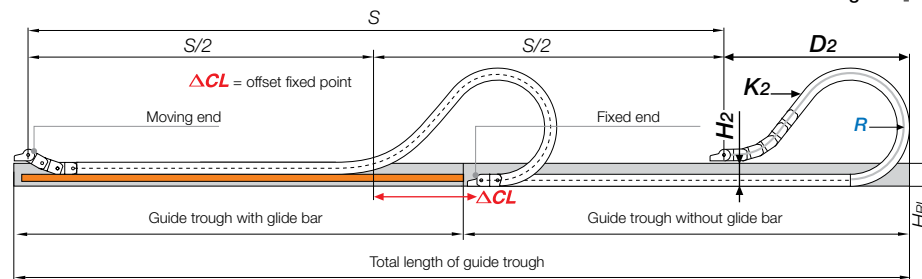

Long Travels - Gliding

If the unsupported length is exceeded, the e-chain® Tube must glide on itself. This requires a guide trough. Design, Chapter 1

R	2.48 (063**)	2.95 (075**)	3.94 (100**)	4.92 (125)	5.91 (150)	6.89 (175)	7.87 (200)	8.66 (220)	9.84 (250)	11.81 (300)
H ₂	—	—	3.78 (96)	3.78 (96)	3.78 (96)	3.78 (96)	3.78 (96)	3.78 (96)	—	—
D ₂	—	—	14.57 (370)	18.50 (470)	19.69 (500)	25.79 (655)	30.31 (770)	35.43 (900)	—	—
K ₂	—	—	24.25 (616)	30.87 (784)	35.27 (896)	44.10 (1120)	50.71 (1288)	57.32 (1456)	—	—
ΔCL	—	—	6.30 (160)	8.27 (210)	9.45 (240)	14.57 (370)	18.11 (460)	21.26 (540)	—	—

In case of travels between 16.4 and 32.8 ft (5 and 10 m) we recommend a longer unsupported length.
**Radius not available for e-tubes 2) Radius not suitable for long travel applications. Please consult igus®

For support of the lower run, see Chapter 9 of the main catalog for the Support Tray tool kit

Technical Data

Speed / acceleration FL_G	max. 65.6 ft/s (20 m/s) / max. 656 ft/s ² (200 m/s ²)
Speed / acceleration FL_B	max. 9.84 ft/s (3 m/s) / max. 19.69 ft/s ² (6 m/s ²)
Gliding speed / acceleration (maximum)	max. 16.4 ft/s (5 m/s) / max. 82 ft/s ² (25 m/s ²)
Material - permitted temperature	igumid G / -40°F (-40°C) up to +248°F (+120° C)
Flammability Class, igumid G	VDE 0304 IIC UL94 HB



Details of material properties
► Chapter 1



PDF: igus.com/e-chain-pdfs
Product information: igus.com/e-chains



Series E4-38L - e-chain® with crossbars every link

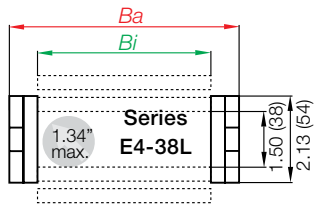

- Crossbars every link
- For use with rigid hydraulic hoses
- For particularly demanding applications
- Can be opened from both sides



Part Number Structure

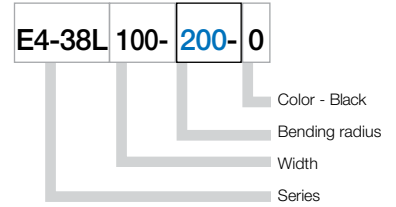

Series R4-38L - fully enclosed e-tube

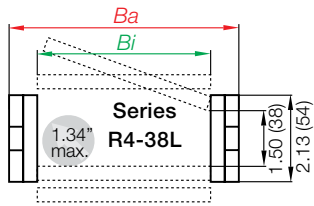

- Fully enclosed
- Excellent cable and hose protection against dirt
- Protection against hot chips
- Lids along inner radius are completely removable
- Lids along the outer radius are single-sided, snap open, hinged on one side as well as completely removable



Part Number Structure

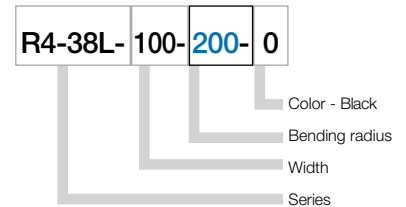

e-chain® as separate parts, links and side plates

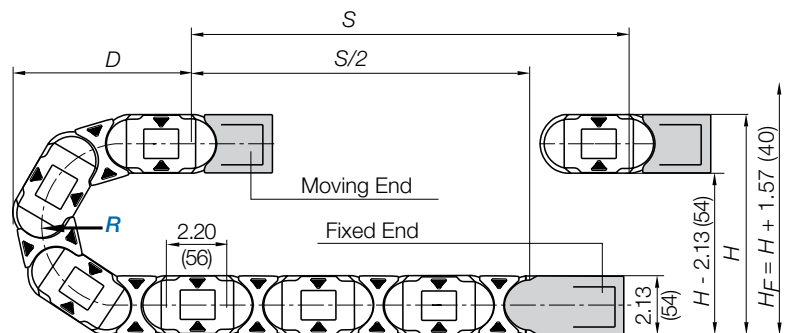
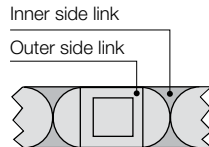
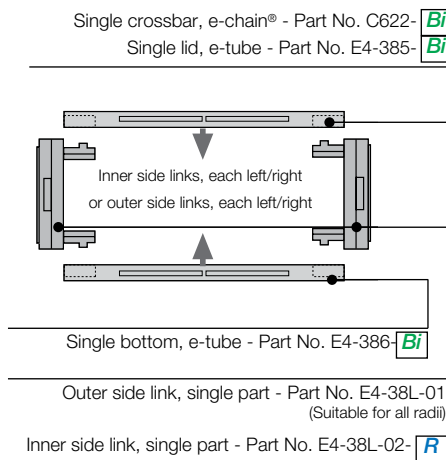

Hot chips up to +1,562°F

- e-tubes to withstand +1,562°F hot chips, as a special option
- No hot chip melting or embedding into the chain
- igus® igumid HT material

More information ► www.igus.com/HT

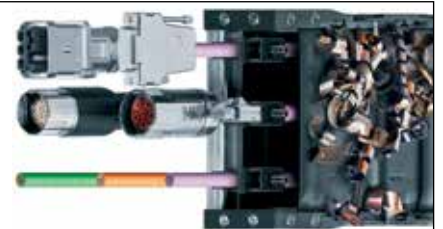

e-chain system® E4-1 light

Series E4-38L/R4-38L

Product Range



E4-38L
R4-38L

Supplement part number with required radius. Example: E4-38L-100-200-0
Pitch: 2.20 in. (56 mm) per link links/ft (m) = 5.49 (18)

Part Number				Weight			
Crossbars	Tube			<i>Bi</i>	<i>Ba</i>	E4-38L	R4-38L
Every link	Version			in. (mm)	in. (mm)	lbs/ft (kg/m)	lbs/ft (kg/m)
E4-38L-050-	R4-38L-050-	<input type="checkbox"/>	-0	1.97 (50)	2.60 (66)	≈ 0.76 (1.13)	≈ 0.81 (1.20)
E4-38L-062-		<input type="checkbox"/>	-0	2.46 (62.5)	3.09 (78.5)	≈ 0.80 (1.19)	–
E4-38L-075-	R4-38L-075-	<input type="checkbox"/>	-0	2.95 (75)	3.58 (91)	≈ 0.85 (1.26)	≈ 0.93 (1.38)
E4-38L-087-		<input type="checkbox"/>	-0	3.44 (87.5)	4.07 (103.5)	≈ 0.87 (1.30)	–
E4-38L-100-	R4-38L-100-	<input type="checkbox"/>	-0	3.94 (100)	4.57 (116)	≈ 0.92 (1.37)	≈ 1.08 (1.60)
E4-38L-105-		<input type="checkbox"/>	-0	4.13 (105)	4.92 (125)	≈ 0.93 (1.39)	–
E4-38L-112-		<input type="checkbox"/>	-0	4.43 (112.5)	5.06 (128.5)	≈ 0.97 (1.44)	–
E4-38L-125-	R4-38L-125-	<input type="checkbox"/>	-0	4.92 (125)	5.55 (141)	≈ 1.01 (1.50)	≈ 1.18 (1.75)
E4-38L-137-		<input type="checkbox"/>	-0	5.41 (137.5)	6.04 (153.5)	≈ 1.04 (1.55)	–
E4-38L-150-	R4-38L-150-	<input type="checkbox"/>	-0	5.91 (150)	6.54 (166)	≈ 1.11 (1.65)	≈ 1.29 (1.92)
E4-38L-162-		<input type="checkbox"/>	-0	6.40 (162.5)	7.03 (178.5)	≈ 1.14 (1.69)	–
E4-38L-175-	R4-38L-175-	<input type="checkbox"/>	-0	6.89 (175)	7.52 (191)	≈ 1.17 (1.74)	≈ 1.41 (2.10)
E4-38L-187-		<input type="checkbox"/>	-0	7.36 (187)	7.99 (203)	≈ 1.21 (1.80)	–
E4-38L-200-	R4-38L-200-	<input type="checkbox"/>	-0	7.87 (200)	8.50 (216)	≈ 1.25 (1.86)	≈ 1.54 (2.29)
E4-38L-212-		<input type="checkbox"/>	-0	8.35 (212)	8.98 (228)	≈ 1.28 (1.90)	–
E4-38L-225-		<input type="checkbox"/>	-0	8.86 (225)	9.49 (241)	≈ 1.32 (1.97)	–
E4-38L-237-		<input type="checkbox"/>	-0	9.33 (237)	9.96 (253)	≈ 1.38 (2.05)	–
E4-38L-250-	R4-38L-250-	<input type="checkbox"/>	-0	9.84 (250)	10.47 (266)	≈ 1.42 (2.11)	≈ 1.78 (2.65)
E4-38L-262-		<input type="checkbox"/>	-0	10.31 (262)	10.94 (278)	≈ 1.44 (2.15)	–
E4-38L-300-		<input type="checkbox"/>	-0	11.81 (300)	12.44 (316)	≈ 1.59 (2.36)	≈ 2.02 (3.00)

Choose from the radii below for all of the above sizes

Radius (mm) Example: E4-38L-100-200-0

	063**	075**	100**	125	150	175	200	250	300
<i>R</i>	2.48 (063*)	2.95 (075)	3.94 (100)	4.92 (125)	5.91 (150)	6.89 (175)	7.87 (200)	9.84 (250)	11.81 (300)
<i>H</i>	7.09 (180)	8.03 (204)	10.00 (254)	11.97 (304)	13.94 (354)	15.91 (404)	17.87 (454)	21.81 (554)	25.75 (654)
<i>D</i>	6.85 (174)	7.32 (186)	8.31 (211)	9.29 (236)	10.28 (261)	11.26 (286)	12.24 (311)	14.21 (361)	16.18 (411)
<i>K</i>	12.20 (310)	13.78 (350)	16.93 (430)	19.88 (505)	23.03 (585)	26.18 (665)	29.33 (745)	35.43 (900)	41.54 (1055)

** This radius is not available for the R4-32 Series

For large diameter hoses see page 6.161

*Removable lid only, no hinged option

0 = Standard color black.

For other colors see Chapter 1

PDF: igus.com/e-chain-pdfs
Product information: igus.com/e-chains



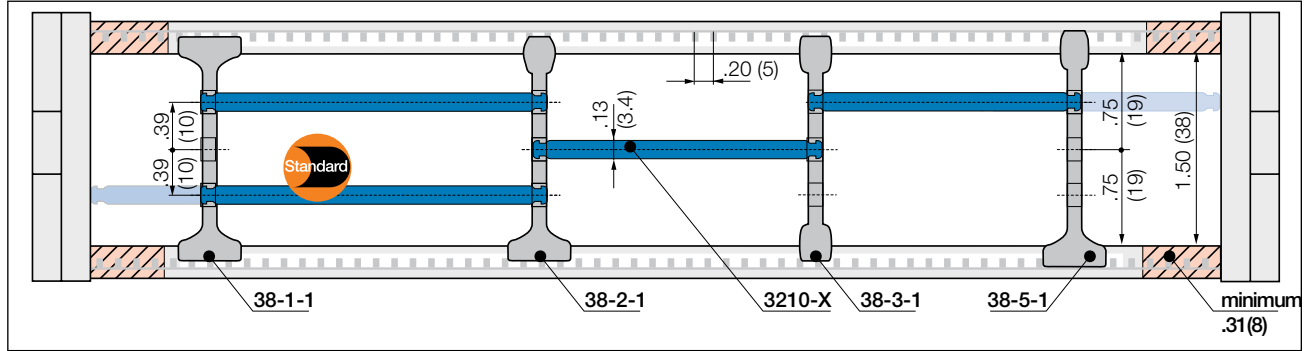

Note e-tube: Please maintain a lateral spacing of .31" (8 mm) between the separators and the side links. In the standard configuration separators are assembled every 2nd e-chain® link

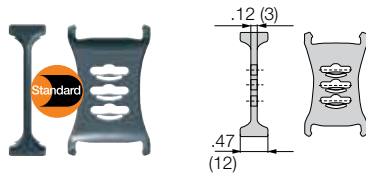

Separator, wide base

Unassembled Part No. 38-1

Assembled Part No. 38-1-1

- **Standard separator 38-1 for all applications**

Separator with wide base for maximum locking strength and safe standing in e-chains® and e-tubes.

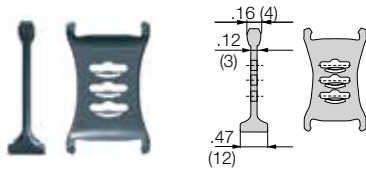

Separator, narrow head

Unassembled Part No. 38-2

Assembled Part No. 38-2-1

- **Separator 38-2 For even faster installation**

Firm hold to one side with a wide base, narrow on opposed side for easy cable assembly (slight grip).

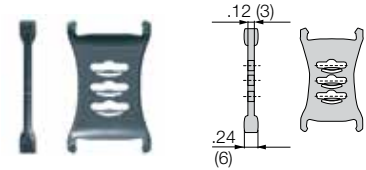

Separator, narrow base

Unassembled Part No. 38-3

Assembled Part No. 38-3-1

- **Separator 38-3 For many thin cables**

Separator with a narrow base for a large number of thin cables side by side. Saves space in e-chains®.

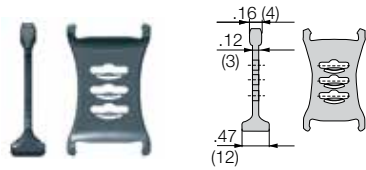

Notch separator for notch crossbar

Unassembled Part No. 38-5

Assembled Part No. 38-5-1

- **Separator 38-5 Locks safely in .20" (5 mm) increments**

Notch separator for exact positioning in e-chains®. Recommended for side-mounted applications.

Lockable full-width shelves - for the standard interior separation

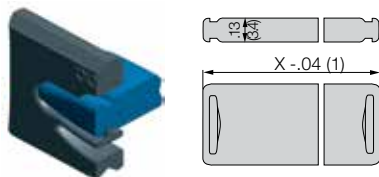

Full width shelf, lockable

Unassembled Part No. 3200-X

Assembled Part No. 3210-X

- **Full width shelf, lockable**

Shelf locks safely into separators on both ends, fixed width possible. Separators can be moved freely over the shelf in horizontal direction. Can be used at 3 different heights.

Width X in. (mm)	Part No. Unassembled	Part No. Assembled	Width X in. (mm)	Part No. Unassembled	Part No. Assembled	Width X in. (mm)	Part No. Unassembled	Part No. Assembled
1.97 (050)	3200-50	3210-50	4.92 (125)	3200-125	3210-125	8.86 (225)	3200-225	3210-225
2.95 (075)	3200-75	3210-75	5.91 (150)	3200-150	3210-150	9.84 (250)	3200-250	3210-250
3.94 (100)	3200-100	3210-100	6.89 (175)	3200-175	3210-175			
4.53 (115)	3200-115	3210-115	7.87 (200)	3200-200	3210-200			

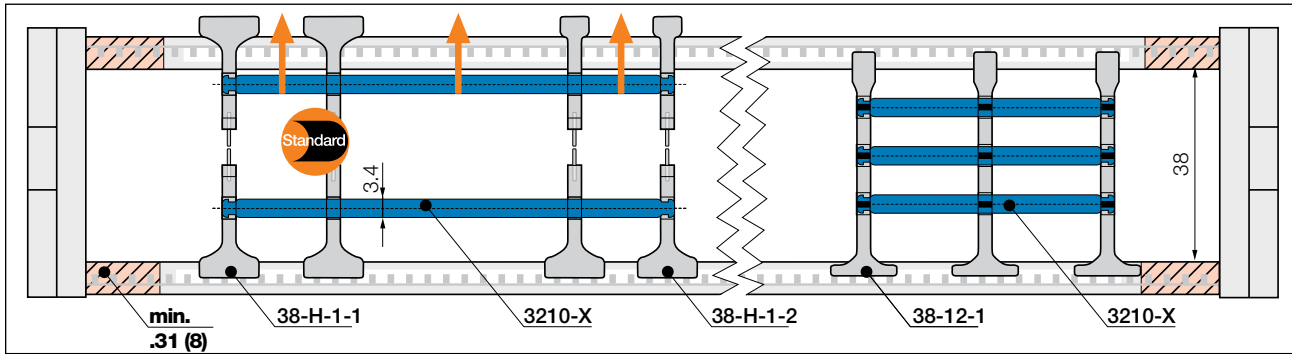

Note e-tube: Please maintain a lateral spacing of .24" (6 mm) between the separators and the side links. In the standard configuration separators are assembled every 2nd e-chain® link

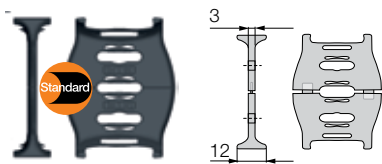

Separator, wide base

Unassembled **Part No. 38-H-1**
 Assembled **Part No. 38-H-1-1**

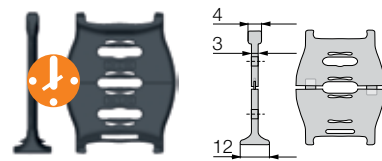

Lean Separator

Unassembled **Part No. 38-H-2**
 Assembled **Part No. 38-H-2-1**

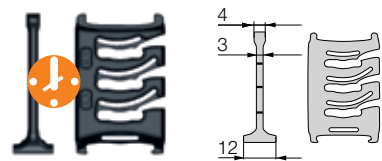

Lean Separator

Unassembled **Part No. 38-12**
 Assembled **Part No. 38-12-1**



• **Split separators for all applications**

In order to fill e-chains® more easily and effectively, these separators can be split in the middle. This allows easier access to middle shelf partitions. Fast assembly and easy retrofit. 2 types available: with wide or narrow top.

• **Lean separators 38-12**

New design allows extremely fast fitting of shelves in several layers, which significantly reduces assembly time. Enables extremely fast replacement of individual cables in a very full e-chain®.

• **Lean separator design - several layers of cables fitted quickly, save up to 50%* assembly time**

(*Lean separator vs. standard separator - measured on a 4m long e-chain® fitted with 12 cables in the igus® harnessing factory)



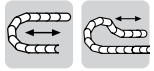

Standard

Option 1: pivoting

- Recommended for unsupported and gliding applications
- Attachment capability on all sides
- Bolted connection outside of chain cross-section
- Space restricted conditions
- Corrosion resistant

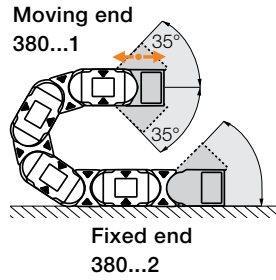

Pivoting angle depends on radius

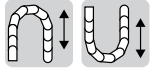
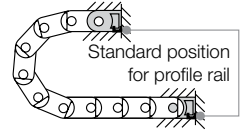

Option 2: locking

- Profile rail option
- Universal use
- Corrosion resistant
- Vertical hanging/standing travels
- Extreme accelerations

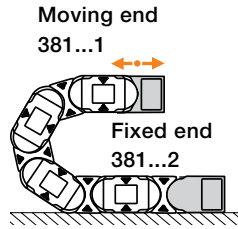

Pivoting angle depends on radius

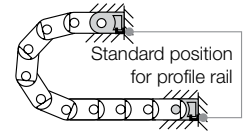

Part Number Structure

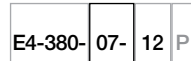

- With Profile Rail
- Complete Set
- Width
- E4-380 = Pivoting for chain
- E4-381 = Locking for chain

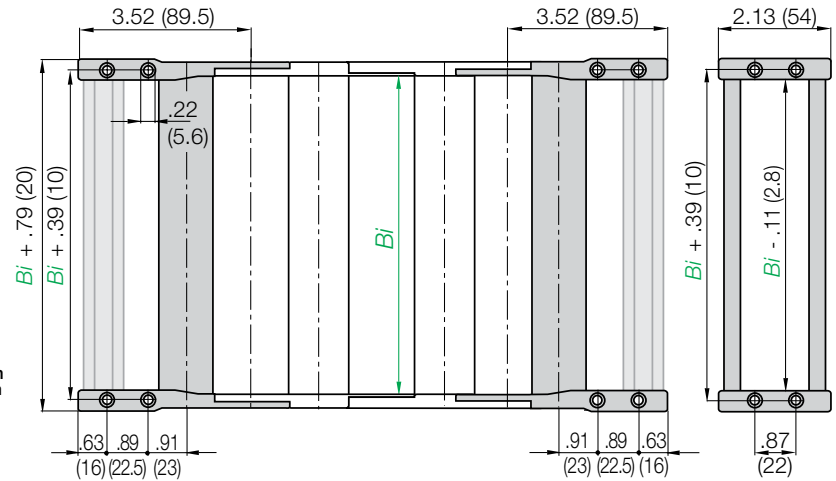

Due to the design of the E4-38L series chains, please note the following when ordering brackets:
Even number of links = full set, part number ending in -12; Odd number of links = 2 pieces, part number ending in -1

Part number examples are shown for pivoting brackets for e-chain.
For locking brackets change part number to 381

Part No. Full Set (pivoting)
Series E4-38L
E4-380-Width-12

Part No. Full Set (pivoting)
with profile rail
Series E4-38L
E4-380-Width-12P

Width	Part No. Full Set chain		With Profile Rail	Bi in. (mm)	Width	Part No. Full Set chain		With Profile Rail	Bi in. (mm)
	Pivoting	Locking				Pivoting	Locking		
-050	E4-380	E4-381	-050-12	P 1.97 (50)	-150	E4-380	E4-381	-150-12	P 5.91 (150)
-062	E4-380	E4-381	-062-12	P 2.68 (62.5)	-162	E4-380	E4-381	-162-12	P 6.38 (162.5)
-075	E4-380	E4-381	-075-12	P 2.95 (75)	-175	E4-380	E4-381	-175-12	P 6.61 (175)
-087	E4-380	E4-381	-087-12	P 3.43 (87.5)	-200	E4-380	E4-381	-200-12	P 7.87 (200)
-100	E4-380	E4-381	-100-12	P 3.94 (100)	-225	E4-380	E4-381	-225-12	P
-105	E4-380	E4-381	-105-12	P 4.25 (105)	-237	E4-380	E4-381	-237-12	P
-112	E4-380	E4-381	-112-12	P 4.41 (112.5)	-250	E4-380	E4-381	-250-12	P 9.84 (250)
-125	E4-380	E4-381	-125-12	P 4.92 (125)	-262	E4-380	E4-381	-262-12	P
-137	E4-380	E4-381	-137-12	P 5.39 (137.5)	-300	E4-380	E4-381	-300-12	P

e-chain system® E4-1 light Series R4-38L Mounting Brackets - KMA



E4-38L
R4-38L

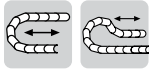

Standard

Option 1: pivoting

- Recommended for unsupported and gliding applications
- Attachment capability on all sides
- Bolted connection outside of chain cross-section
- Space restricted conditions
- Corrosion resistant

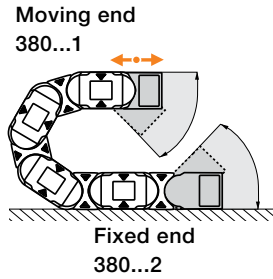

Pivoting angle depends on radius

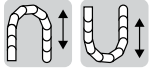
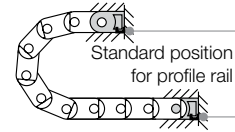

Option 2: locking

- Profile rail option
- Universal use
- Corrosion resistant
- Vertical hanging/standing travels
- Extreme accelerations

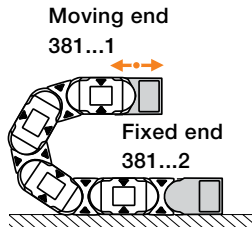

Pivoting angle depends on radius

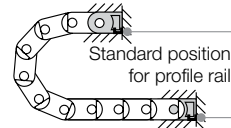

Part Number Structure

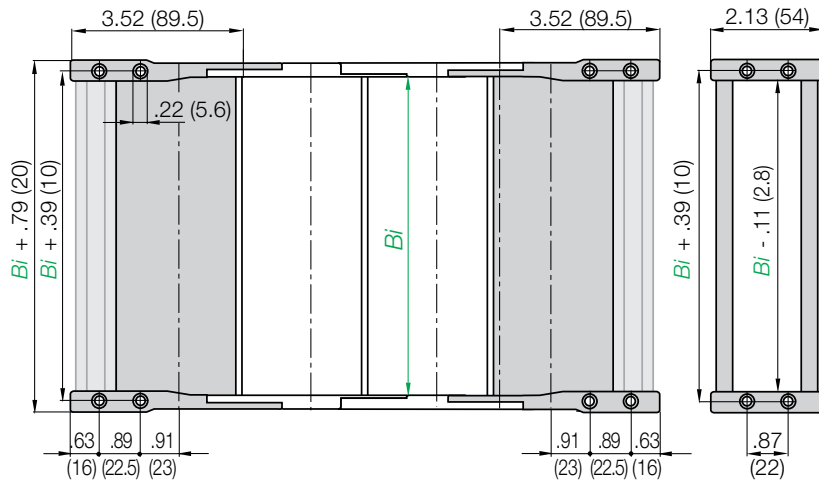
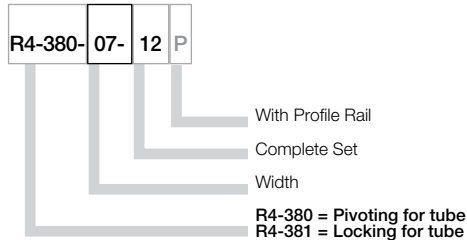

Due to the design of the R4-38L series chains, please note the following when ordering brackets:
Even number of links = full set, part number ending in -12; Odd number of links = 2 pieces, part number ending in -1

Part number examples are shown for pivoting brackets for e-chain.
For locking brackets change part number to 381

Part No. Full Set (pivoting)
Tube Series R4-38L
R4-380-Width-12

Part No. Full Set (pivoting)
with Profile Rail
Tube Series R4-38L
R4-380-Width-12P

Width	Part No. Full Set tube		With Profile Rail	Bi in. (mm)	Width	Part No. Full Set tube		With Profile Rail	Bi in. (mm)
	Pivoting	Locking				Pivoting	Locking		
-050	R4-380	R4-381	-050-12	1.97 (50)	-150	R4-380	R4-381	-150-12	5.91 (150)
-075	R4-380	R4-381	-075-12	2.95 (75)	-175	R4-380	R4-381	-175-12	6.61 (175)
-100	R4-380	R4-381	-100-12	3.94 (100)	-200	R4-380	R4-381	-200-12	7.87 (200)
-125	R4-380	R4-381	-125-12	4.92 (125)	-250	R4-380	R4-381	-250-12	9.84 (250)

PDF: igus.com/e-chain-pdfs
Product information: igus.com/e-chains



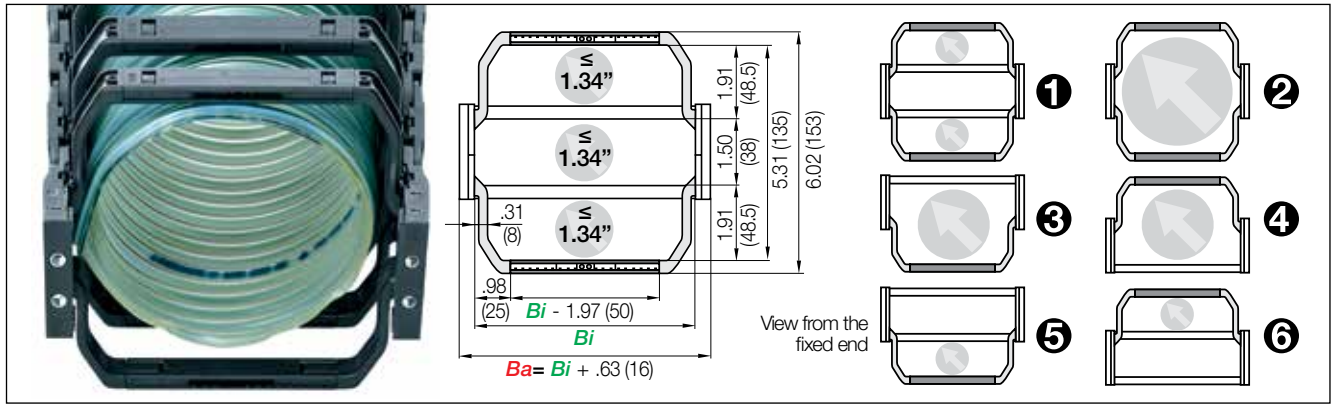

Extender crossbars with flexible width | Safe guiding for large hoses

- For guiding and protecting large hoses
- With mounting for noise dampers
- Cable-friendly design, high crossbar holding force
- The openable extender crossbars can be fitted in different ways and combinations
- Optionally openable along the inner or outer radius

Versions e-chain® with extender crossbar

	Hose $\varnothing \leq$ in. (mm)	Part No. e-chain® with extender crossbar
1 Extender crossbar and standard crossbar alternating along the inner and outer radius ¹⁾	1.34 (34)	E4-38L-XXXHB48-R-0
2 Extender crossbar on both sides along the inner and outer radius ²⁾	4.80 (122)	E4-38L-XXXB48-R-0
3 Extender crossbar along the outer radius ³⁾	3.07 (78)	E4-38L-XXXBE48-R-0
4 Extender crossbar along the inner radius ²⁾	3.07 (78)	E4-38L-XXXBZ48-R-0
5 Extender crossbar and standard crossbar alternating along the outer radius ³⁾	1.34 (34)	E4-38L-XXXHBE48-R-0
6 Extender crossbar and standard crossbar alternating along inner radius ¹⁾	1.34 (34)	E4-38L-XXXHBZ48-R-0

1) Minimum bend radius: **R 125** 2) Minimum bend radius: **R 150** 3) Minimum bend radius: **R 063** *Width available upon request. Delivery time upon request

Bi [mm] Available inner widths

| 100 | 125 | 137 | 150 | 162 | 175 | 187 | 200 | 212 | 225 | 237 | 250 |

Complete Part No. with the width index **XXX Bi** and the radius (**R**). Example

E4-38L-100B48-150-0 = extender crossbar on both sides along inner and outer radius



The E4.1L can be fitted with openable extender crossbars, which increase the size of the interior of the e-chain®. Crossbars can be fitted in various ways: from one or both sides, alternating with standard crossbars and or any combination

Aluminum support tray

- Corrosion-resistant and seawater-resistant aluminium rails with adjustable width
- Noise-reducing glide strip integrated as standard
- Easy installation and connection of the e-chain®
- Open design - dirt and debris fall through

More information ► Chapter 9



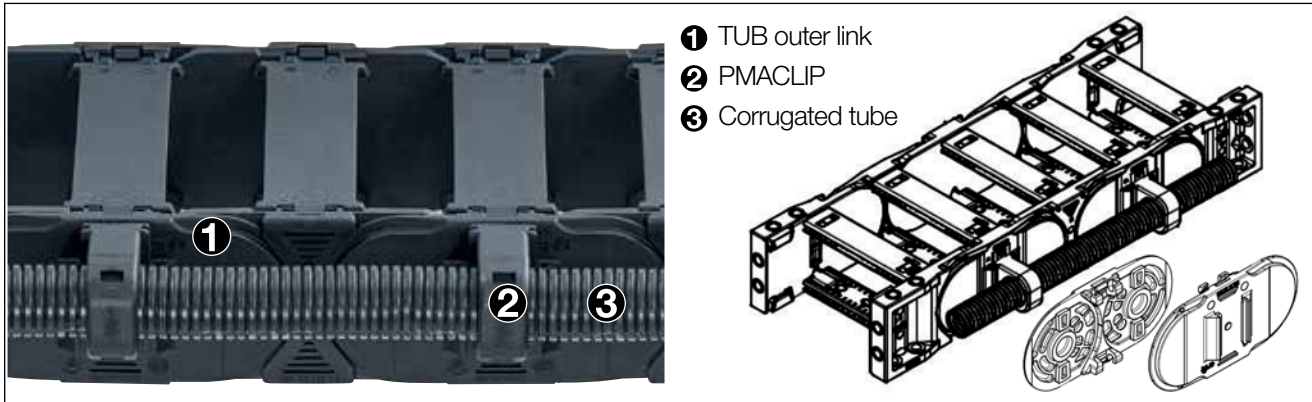

TUB | Safe guidance for corrugated tubes parallel to the e-chain®

- Additional, simple guidance for corrugated tubes on the outside of the e-chain®
- PMACLIP allows corrugated tubes with nominal widths .28 (07mm), .39 (10mm), .47 (12mm), .67 (17mm) to be easily clipped on
- Easy access to the corrugated tubes, fast replacement of the hoses
- Reduce assembly time and cost - easy to assemble, without any additional screws or tools
- The part number includes the e-chain® with TUB side sections; the PMACLIP support and the hose are ordered separately

Part No. TUB	Part No. TUB	Part No. TUB	For corrugated tube nominal diameter
Outer link right*	Outer link left*	Outer link at both ends*	Ø in. (mm)
E4-38L- XXX TUB R -R-0	E4-38L- XXX TUB L -R-0	E4-38L- XXX TUB- R -0	.28 (07), .39 (10), .47 (12), .67 (17)

*View from the fixed end

Part number appended with width index **XXX Bi** and radius (**R**) e.g.

E4-38L-100TUB**R**-150-0 = with TUB outer sections every 2nd right hand link

PDF: igus.com/e-chain-pdfs
 Product information: igus.com/e-chains



Chainfix clamps for the profile rail

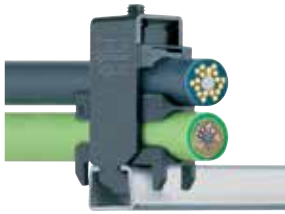

igus® Chainfix strain relief elements are available in either steel or stainless steel. They can be adjusted with a hexagon socket and are available in single, double and triple configurations.

Part No. Single Clamp		Part No. Double Clamp		Part No. Triple Clamp		Cable ø	
Steel	Stainless	Steel	Stainless	Steel	Stainless	in.	(mm)
CFX12-1	CFX12-1E	CFX12-2	CFX12-2E	CFX12-3	-	.24 - .47	(06 - 12)
CFX14-1	CFX14-1E	CFX14-2	CFX14-2E	CFX14-3	-	.47 - .55	(12 - 14)
CFX16-1	CFX16-1E	CFX16-2	CFX16-2E	CFX16-3	-	.55 - .63	(14 - 16)
CFX18-1	CFX18-1E	CFX18-2	CFX18-2E	CFX18-3	-	.63 - .71	(16 - 18)
CFX20-1	CFX20-1E	CFX20-2	CFX20-2E	CFX20-3	-	.71 - .79	(18 - 20)
CFX22-1	CFX22-1E	CFX22-2	CFX22-2E	CFX22-3	-	.79 - .87	(20 - 22)
CFX26-1	CFX26-1E	CFX26-2	CFX26-2E	-	-	.87 - 1.02	(22 - 26)
CFX30-1	CFX30-1E	CFX30-2	CFX30-2E	-	-	1.02 - 1.18	(26 - 30)
CFX34-1	CFX34-1E	CFX34-2	CFX34-2E	-	-	1.18 - 1.34	(30 - 34)
CFX38-1	CFX38-1E	-	-	-	-	1.34 - 1.50	(34 - 38)
CFX42-1	CFX42-1E	-	-	-	-	1.50 - 1.65	(38 - 42)

For more information please refer to strain relief section of Chapter 10

Tiewrap Plates

**Option 1:
Tiewrap plates as an individual part**

Available as an individual component, can be fixed onto a mounting bracket with the use of a profile rail.

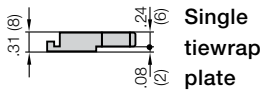
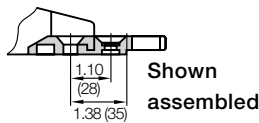

Tiewrap Plate	n Number of Teeth	C Overall Width in. (mm)	B Bore Width in. (mm)	Center Bore
3050-ZB	5	1.97 (50)	1.18 (30)	no
3075-ZB	7	2.95 (75)	2.16 (55)	no
3100-ZB	10	3.94 (100)	3.15 (80)	no
3115-ZB	11	4.53 (115)	3.74 (95)	no
3125-ZB	12	4.92 (125)	4.13 (105)	no
3150-ZB	15	5.91 (150)	5.12 (130)	no
3175-ZB	17	6.89 (175)	6.10 (155)	no
3200-ZB	20	7.87 (200)	7.09 (180)	yes
3225-ZB	22	8.86 (225)	8.07 (205)	yes
3250-ZB	25	9.84 (250)	9.06 (230)	yes

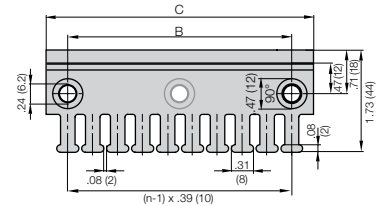

If used with KMA brackets with profile rail please add "KMA" to the end of the part number.

For more information please refer to strain relief section of Chapter 10

**Option 2:
Clip-on Tiewrap plates**

Available as a clip-on tiewrap plate without the use of bolts. They are inserted and removed with a screwdriver used as a lever. Clip-on tiewrap plates are also available as an attachment to the opening crossbars.

Part No.	Number of Teeth	Width of Strain Relief in. (mm)
3050-ZC	5	1.97 (50)
3075-ZC	7	2.95 (75)

For more information please refer to strain relief section of Chapter 10

Strain relief with tiewrap teeth

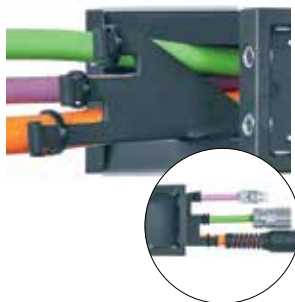

Part No.	For series	Inner height <i>hi</i> in. (mm)	For use in
CFV-42-C	E4-64L	2.52 (64)	Top-hat (DIN) rail 15 (TS92.31)

e-chain system® E4-1 light

Series E4-38L/R4-38L

Guide Trough



E4-38L
R4-38L

Guide troughs are used with applications where the upper run of the e-chain® glides on the lower run. If using igus® steel guide troughs, the following components are required:

- Full travel length of guide trough
Part Number 98-30
- 1/2 travel length of glide bars
Part number 92-01
- Installation sets as end connectors
Part Number 93-50-XX

Width of Crossbar
E4-38-050-200-0

	B_{Ri}	Installation Part No.
-050	2.80 (71)	93-50-200
-062	3.27 (83)	93-50-200
-075	3.78 (96)	93-50-225
-087	4.25 (108)	93-50-225
-100	4.76 (121)	93-50-250
-105	4.96 (126)	93-50-250
-112	5.24 (133)	93-50-250
-125	5.75 (146)	93-50-275
-137	6.22 (158)	93-50-275
-150	6.73 (171)	93-50-300
-162	7.21 (183)	93-50-300
-175	7.72 (196)	93-50-325
-187	8.19 (208)	93-50-325
-200	8.70 (221)	93-50-350
-212	9.17 (233)	93-50-350
-225	9.69 (246)	93-50-375
-237	10.16 (258)	93-50-375
-250	10.67 (271)	93-50-400
-262	11.14 (283)	93-50-400
-300	12.64 (321)	93-50-450

-XX indicates the length of the profile rail on which the guide trough is mounted. The values and part numbers are specified in the table on the left. The standard length of the trough components and glide bars is 6.56 ft (2 m.) The required overall length of the guide trough directly correlates to the length of travel.

Example:

Length of travel 164 ft (50 m)
Center mounted

Required guide troughs:

164 ft (50 m) guide trough
82 ft (25 m) glide bar
= 25 sections of 6.56 ft (2 m) guide trough

Part No. 98-30

= 13 sections of 6.56 ft (2 m) glide bar

Part No. 92-01

Required number of installation sets:

= Number of guide trough components + 1
= 25 + 1 = 26

Part number of the installation sets

93-50-XXX

Example: 93-50-400 for 15.75" (400 mm) long profile rail.



Left: Guide trough with glide bars
Right: Guide troughs without glide bars



Installation sets as section connectors

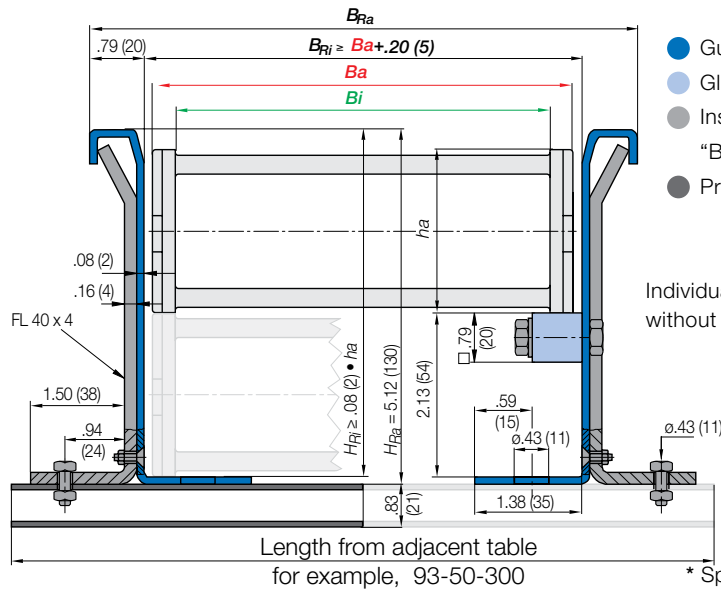

- Guide trough
- Glide bars
- Installation set "Basic"
- Profile rail

Individual attachment without profile rail

* Specialized guide trough available upon request

Standard length profile rail

PDF: igus.com/e-chain-pdfs
Product information: igus.com/e-chains



Price Index



Special Options Available

- Low noise version available with special rubber pads
- Cleanroom test upon request
- ESD classification: Electrically conductive ESD/ATEX version upon request

Assembly Tips



Opening To open, insert the screwdriver into the locking mechanism and pry it open outwards

Other Installation Methods

- Vertical, hanging ≤ 262 ft (80 m)
- Vertical, standing ≤ 9.84 ft (3 m)
- Side-mounted, unsupp. ≤ 3.94 ft (1.2 m)
- Rotary requires further calculation

Usage Guidelines

- If a lightweight, cost-effective e-chain® for high dynamics is required
- If very tight fitting lids and bottoms are required
- If short assembly times are required
- If optimized interior-exterior dimensions ratio is needed
- When the e-chain® needs to be extremely quiet (32dB(A)) with very low vibration
 - Series E6-1, Chapter 7
- When the e-chain® is to be used in cleanrooms (cleanroom ISO class 1)
 - Series E6-1, Chapter 7
 - If even higher strength is required
 - Series E4-1, Chapter 6

Features & Benefits

- 1 KMA mounting brackets with attachment points on all sides
- 2 Easy filling: inner diameter completely accessible
- 3 High stability due to undercut design
- 4 Efficient: less weight, enhanced dynamics
- 5 Notch crossbar with visual scale
- 6 Short assembly time: pivotable crossbars, snap-open along the inner and outer radius
- 7 Numerous interior separation possibilities
- 8 Straight run due to inner/outer link design
- 9 Chip protection: very tightly fitting lids and bottoms
- 10 Version NCST "without camber" simply by turning outer links without unnecessary rework

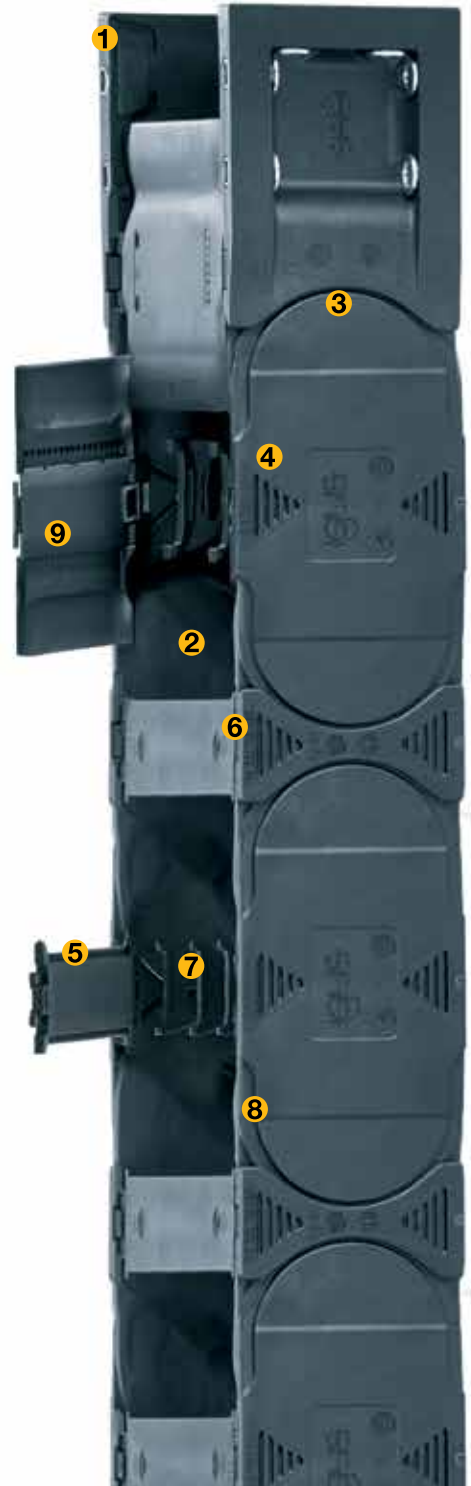

Also available without camber. Add NCST to the end of the part number.
Ex: E4-38L-100-300NCST

Order Example: Complete e-chain®

Please indicate chain length or number of links. Example:

13.12 ft (4 m) E4-48L-100-200-0		e-chain®
With 2 separators 48-1-1 assembled every 2nd link		Interior Separation
1 Set E4-480-100-12P		Mounting Bracket

e-chain system® E4-1 light Series E4-48L/R4-48L Installation Dimensions



E4-48L
R4-48L

Short travel, unsupported length

- FL_B = unsupported with permitted sag
 - FL_G = unsupported with straight upper run
- Further information ► Design, Chapter 1

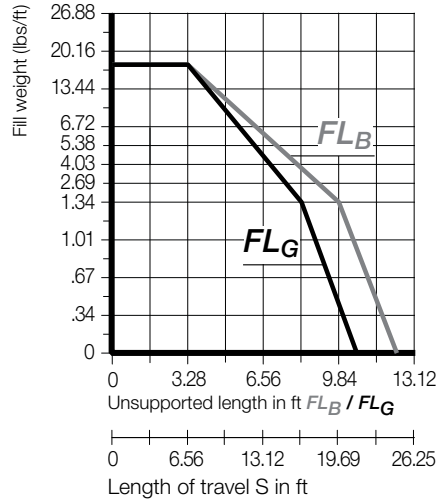
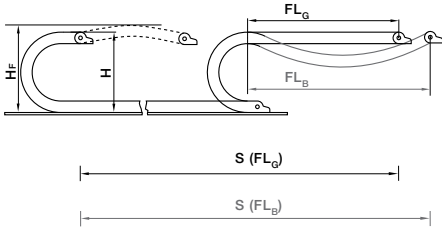

Short Travels - Unsupported

Unsupported e-chains® feature positive camber over short travels. This must be accounted for when specifying the clearance height. Please refer to for further details.

Legend

- S = Length of travel
- R = Bending radius
- H = Nominal clearance height
- D = Overlength e-chain® radius in final position
- $K = \pi \cdot R + \text{safety buffer}$
- Hf = Required clearance height
- Hri = Trough inner height
- H2 = *Mounting height
- D2 = Overlength - long travels, gliding
- K2 = *Add-on
- *If the mounting bracket location is set lower

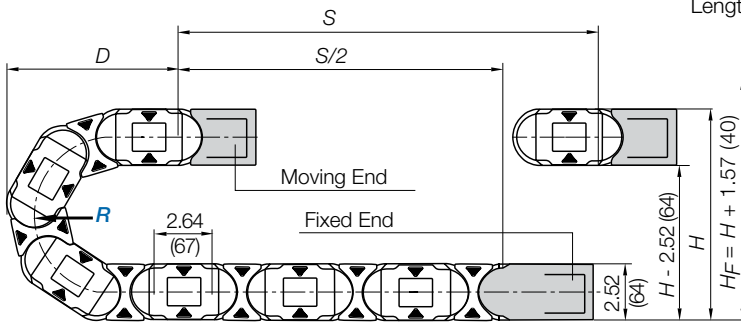

Pitch per link: = 2.64" (67 mm)
Links per ft (m): = 4.54 (15)
For center mount applications:
Chain length = $S/2 + K$

The required clearance height: $H_f = H + 1.57$ in. (40 mm) (with 1.68 lbs/ft (2.5 kg/m) fill weight. Please consult igus® if space is particularly restricted.

R	2.95 (075*)	3.94 (100*)	4.92 (125)	5.91 (150)	6.69 (175)	7.87 (200)	9.84 (250)	11.81 (300)	13.78 (350)
H	8.43 (214)	10.39 (264)	12.36 (314)	14.33 (364)	16.30 (414)	18.27 (464)	22.20 (564)	26.14 (664)	30.08 (764)
D	8.19 (208)	9.17 (233)	10.16 (258)	11.14 (283)	12.13 (308)	13.11 (333)	15.08 (383)	17.05 (433)	19.02 (483)
K	14.57 (370)	17.72 (450)	20.87 (530)	24.02 (610)	26.97 (685)	30.12 (765)	36.22 (920)	42.52 (1080)	48.62 (1235)

For long travels with lowered mounting height

Long travel lengths from 32.8 ft.(10m) to max. 262 ft. (80m)

For center mount applications:

Chain length: = $S/2 + K_2$

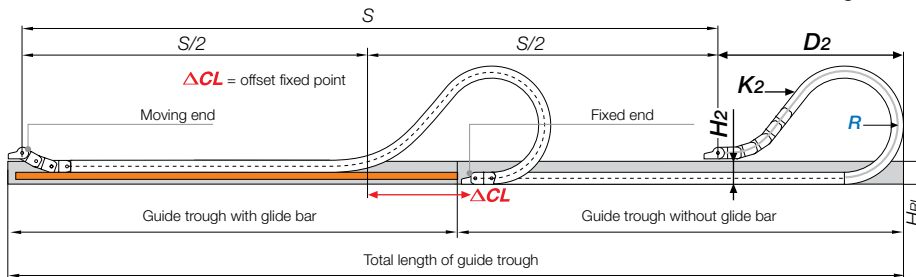

Long Travels - Gliding



If the unsupported length is exceeded, the e-chain®/ Tube must glide on itself. This requires a guide trough.

Design, Chapter 1

R	2.95 (075**)	3.94 (100**)	4.92 (125)	5.91 (150)	6.69 (175)	7.87 (200)	9.84 (250)	11.81 (300)	13.78 (350)
H2	—	—	4.17 (106)	4.17 (106)	4.17 (106)	4.17 (106)	4.17 (106)	—	—
D2	—	—	18.70 (475)	22.44 (570)	26.38 (670)	30.71 (780)	40.55 (1030)	—	—
K2	—	—	31.65 (804)	36.93 (938)	44.84 (1139)	52.76 (1340)	65.94 (1675)	—	—
ΔCL	—	—	9.06 (230)	11.81 (300)	14.96 (380)	18.11 (460)	25.98 (660)	—	—

In case of travels between 16.4 and 32.8 ft (5 and 10 m) we recommend a longer unsupported length.

**Radius not available for e-tubes 2) Radius not suitable for long travel applications. Please consult igus®



For support of the lower run, see Chapter 9 of the main catalog for the Support Tray tool kit

Speed / acceleration FL_G	max. 65.6 ft/s (20 m/s) / max. 656 ft/s ² (200 m/s ²)
Speed / acceleration FL_B	max. 9.84 ft/s (3 m/s) / max. 19.69 ft/s ² (6 m/s ²)
Gliding speed / acceleration (maximum)	max. 16.4 ft/s (5 m/s) / max. 82 ft/s ² (25 m/s ²)
Material - permitted temperature	igumid G / -40°F (-40°C) up to +248°F (+120°C)
Flammability Class, igumid G	VDE 0304 IIC UL94 HB

Technical Data



Details of material properties

► Chapter 1

PDF: igus.com/e-chain-pdfs
Product information: igus.com/e-chains



Series E4-48L - e-chain® with crossbars every link

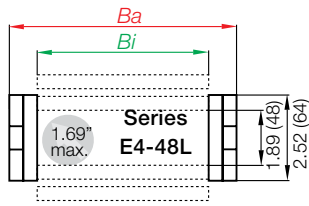

- Crossbars every link
- For use with rigid hydraulic hoses
- For particularly demanding applications
- Can be opened from both sides



Part Number Structure

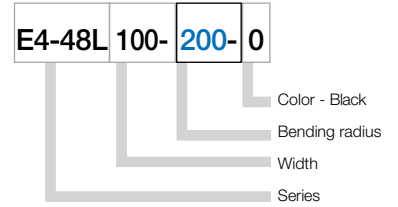

Series R4-48L - fully enclosed e-tube

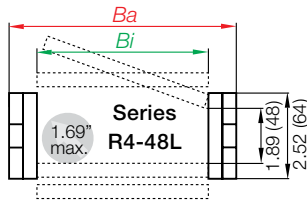

- Fully enclosed
- Excellent cable and hose protection against dirt
- Protection against hot chips
- Lids along inner radius are completely removable
- Lids along the outer radius are single-sided, snap open, hinged on one side as well as completely removable



Part Number Structure

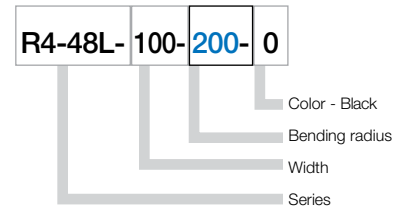

e-chain® as separate parts, links and side plates

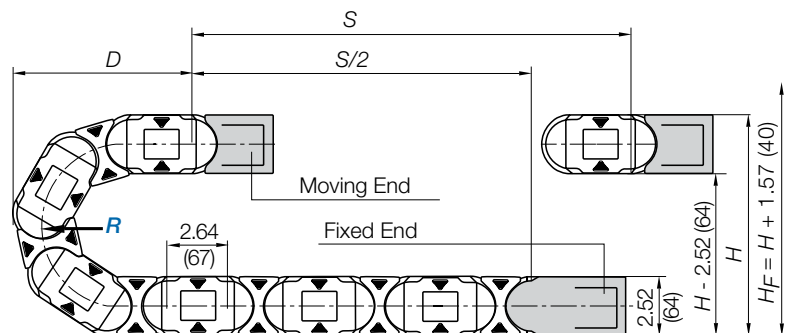
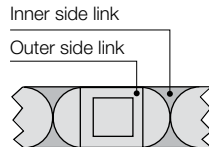
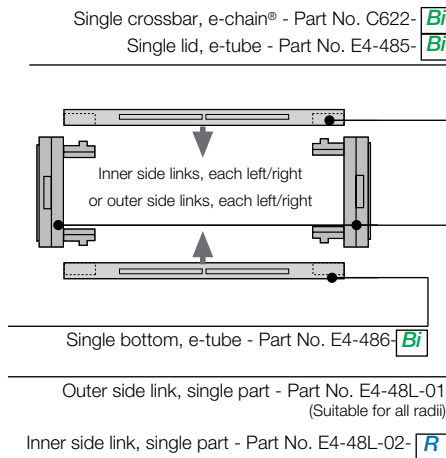

e-chain system® E4-1 light

Series E4-48L/R4-48L

Product Range



E4-48L
R4-48L

Supplement part number with required radius. Example: E4-48L-100--0
Pitch: 2.64 in. (67 mm) per link links/ft (m) = 4.54 (15)

Part Number				Weight			
Crossbars	Tube			<i>Bi</i>	<i>Ba</i>	E4-48L	R4-48L
Every link	Version			in. (mm)	in. (mm)	lbs/ft (kg/m)	lbs/ft (kg/m)
E4-48L-050-	R4-48L-050-	<input type="text" value=""/>	-0	1.97 (50)	2.76 (70)	≈ 1.02 (1.53)	≈ 1.10 (1.64)
E4-48L-062-	R4-48L-062-	<input type="text" value=""/>	-0	2.46 (62.5)	3.25 (82.5)	≈ 1.06 (1.58)	≈ 1.16 (1.73)
E4-48L-075-	R4-48L-075-	<input type="text" value=""/>	-0	2.95 (75)	3.74 (95)	≈ 1.10 (1.64)	≈ 1.22 (1.82)
E4-48L-087-		<input type="text" value=""/>	-0	3.44 (87.5)	4.23 (107.5)	≈ 1.20 (1.67)	-
E4-48L-100-	R4-48L-100-	<input type="text" value=""/>	-0	3.94 (100)	4.72 (120)	≈ 1.16 (1.73)	≈ 1.35 (2.01)
E4-48L-105-		<input type="text" value=""/>	-0	4.13 (105)	4.92 (125)	≈ 1.17 (1.74)	-
E4-48L-112-		<input type="text" value=""/>	-0	4.41 (112)	5.20 (132)	≈ 1.20 (1.79)	-
E4-48L-125-	R4-48L-125-	<input type="text" value=""/>	-0	4.92 (125)	5.71 (145)	≈ 1.24 (1.84)	≈ 1.46 (2.18)
E4-48L-137-		<input type="text" value=""/>	-0	5.39 (137)	6.18 (157)	≈ 1.26 (1.88)	-
E4-48L-150-	R4-48L-150-	<input type="text" value=""/>	-0	5.91 (150)	6.69 (170)	≈ 1.32 (1.97)	≈ 1.59 (2.36)
E4-48L-162-		<input type="text" value=""/>	-0	6.38 (162)	7.17 (182)	≈ 1.34 (2.00)	-
E4-48L-175-	R4-48L-175-	<input type="text" value=""/>	-0	6.89 (175)	7.68 (195)	≈ 1.37 (2.04)	≈ 1.73 (2.58)
E4-48L-200-	R4-48L-200-	<input type="text" value=""/>	-0	7.87 (200)	8.66 (220)	≈ 1.44 (2.14)	≈ 1.81 (2.70)
E4-48L-225-		<input type="text" value=""/>	-0	8.86 (225)	9.65 (245)	≈ 1.50 (2.24)	-
E4-48L-237-		<input type="text" value=""/>	-0	9.33 (237)	10.12 (257)	≈ 1.55 (2.30)	-
E4-48L-250-	R4-48L-250-	<input type="text" value=""/>	-0	9.84 (250)	10.63 (270)	≈ 1.58 (2.35)	≈ 2.07 (3.08)
E4-48L-262-		<input type="text" value=""/>	-0	10.31 (262)	11.10 (282)	≈ 1.61 (2.39)	-
E4-48L-300-		<input type="text" value=""/>	-0	11.81 (300)	12.60 (320)	≈ 1.73 (2.56)	-

Choose from the radii below for all of the above sizes

Radius (mm) Example: E4-48L-100--0

	075**	100**	125	150	175	200	250	300	350
R	2.95 (075)	3.94 (100)	4.92 (125)	5.91 (150)	6.89 (175)	7.87 (200)	9.84 (250)	11.81 (300)	13.78 (350)
H	8.43 (214)	10.39 (264)	12.36 (314)	14.33 (364)	16.30 (414)	18.27 (464)	22.20 (564)	26.14 (664)	30.08 (764)
D	8.19 (208)	9.17 (233)	10.16 (258)	11.14 (283)	12.13 (308)	13.11 (333)	15.08 (383)	17.05 (433)	19.02 (483)
K	14.57 (370)	17.72 (450)	20.87 (530)	24.02 (610)	26.97 (685)	30.12 (765)	36.22 (920)	42.52 (1080)	48.62 (1235)

** This radius is not available for the R4-32 Series

*Removable lid only, no hinged option

0 = Standard color black.

For other colors see Chapter 1

For large diameter hoses see page 6.174

PDF: igus.com/e-chain-pdfs
Product information: igus.com/e-chains



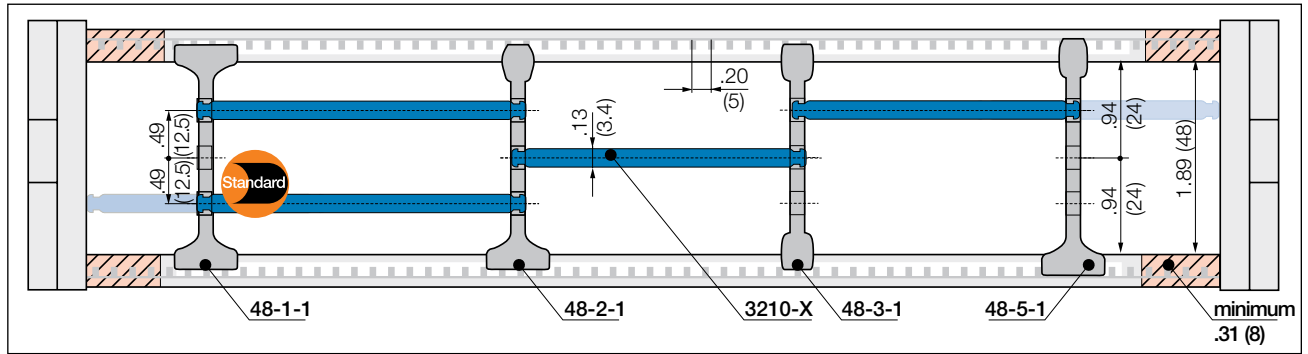

Note e-tube: Please maintain a lateral spacing of .31" (8 mm) between the separators and the side links. In the standard configuration separators are assembled every 2nd e-chain® link

		Separator, wide base	Unassembled Part No. 48-1	Assembled Part No. 48-1-1
		Separator, narrow head	Unassembled Part No. 48-2	Assembled Part No. 48-2-1
		Separator, narrow base	Unassembled Part No. 48-3	Assembled Part No. 42-3-1
		Separator, asymmetrical	Unassembled Part No. 48-5	Assembled Part No. 48-5-1

- Standard separator 48-1 for all applications**
 Separator with wide base for maximum locking strength and safe standing in e-chains® and e-tubes.
- Separator 48-2 For even faster installation**
 is used when vertical and horizontal separation is required. Due to its slot, it allows basic vertical/horizontal shelving arrangements.
- Separator 48-3 For many thin cables**
 is used when vertical and horizontal separation is required. Due to its slot, it allows basic vertical/horizontal shelving arrangements.
- Separator 48-5 Locks safely in .30" (7.5 mm) increments**
 Notch separator for exact positioning in e-chains®. Recommended for side-mounted applications.

Lockable full-width shelves - for the standard interior separation

		Full width shelf, lockable	Unassembled Part No. 3200-X	Assembled Part No. 3210-X
--	--	-----------------------------------	------------------------------------	----------------------------------

- Full width shelf, lockable**
 Shelf locks safely into separators on both ends, fixed width possible. Separators can be moved freely over the shelf in horizontal direction. Can be used at 3 different heights.

Width X in. (mm)	Part No. Unassembled	Part No. Assembled	Width X in. (mm)	Part No. Unassembled	Part No. Assembled	Width X in. (mm)	Part No. Unassembled	Part No. Assembled
1.97 (050)	3200-50	3210-50	4.92 (125)	3200-125	3210-125	8.86 (225)	3200-225	3210-225
2.95 (075)	3200-75	3210-75	5.91 (150)	3200-150	3210-150	9.84 (250)	3200-250	3210-250
3.94 (100)	3200-100	3210-100	6.89 (175)	3200-175	3210-175			
4.53 (115)	3200-115	3210-115	7.87 (200)	3200-200	3210-200			

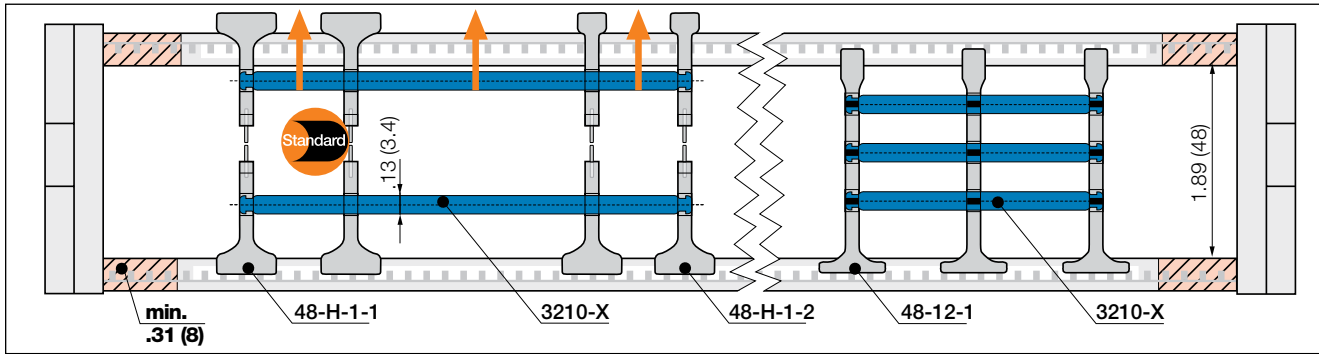

Note e-tube: Please maintain a lateral spacing of .24" (6 mm) between the separators and the side links. In the standard configuration separators are assembled every 2nd e-chain® link

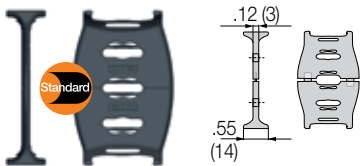

Separator, wide base/top

Unassembled	Part No. 48-H-1
Assembled	Part No. 48-H-1-1

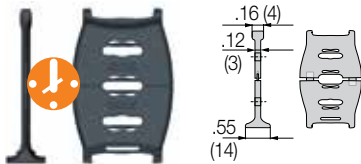

Split separator, narrow top

Unassembled	Part No. 48-H-2
Assembled	Part No. 48-H-2-1

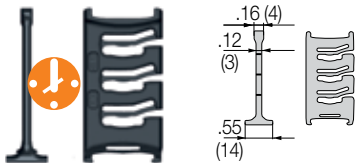

Lean Separator

Unassembled	Part No. 48-12
Assembled	Part No. 48-12-1



• **Split separators for all applications**

In order to fill e-chains® more easily and effectively, these separators can be split in the middle. This allows easier access to middle shelf partitions. Fast assembly and easy retrofit. 2 types available: with wide or narrow top.

• **Lean separators 48-12**

New design allows extremely fast fitting of shelves in several layers, which significantly reduces assembly time. Enables extremely fast replacement of individual cables in a very full e-chain®.

• **Lean separator design - several layers of cables fitted quickly, save up to 50%* assembly time**

(*Lean separator vs. standard separator - measured on a 4m long e-chain® fitted with 12 cables in the igus® harnessing factory)

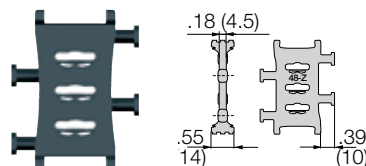

Separator, integrated strain relief

Unassembled	Part No. 48-Z
Assembled	Part No. 48-Z-1

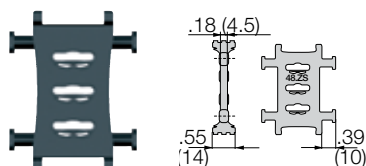

Separator, integrated strain relief

Unassembled	Part No. 48-ZS
Assembled	Part No. 48-ZS-1

• **Separator 48-Z with integrated strain relief**

Can be integrated into the mounting bracket or placed at any point in the e-chain®. Combines strain relief and interior separation, for restricted space conditions. Strain relief separator is easy to assemble without any tools



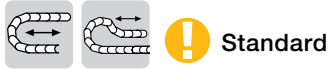

Option 1: pivoting

- Recommended for unsupported and gliding applications
- Attachment capability on all sides
- Bolted connection outside of chain cross-section
- Space restricted conditions
- Corrosion resistant

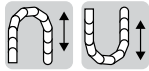
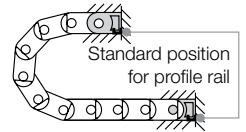
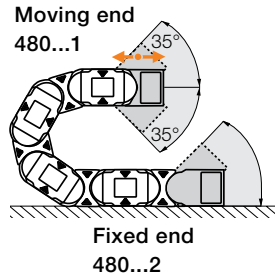

Option 2: locking

- Profile rail option
- Universal use
- Corrosion resistant
- Vertical hanging/standing travels
- Extreme accelerations

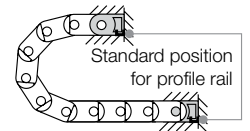
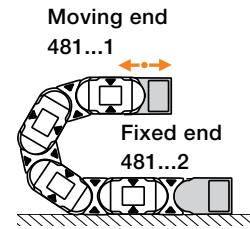

Part Number Structure

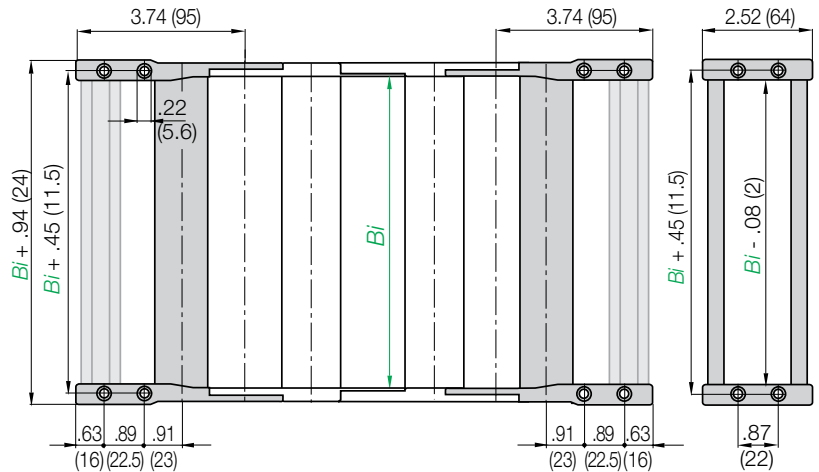
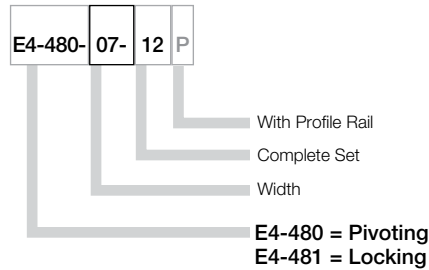

Due to the design of the E4-48L series chains, please note the following when ordering brackets:
Even number of links = full set, part number ending in -12; Odd number of links = 2 pieces, part number ending in -1

Part number examples are shown for pivoting brackets for e-chain.
For locking brackets change part number to 481

Part No. Full Set (pivoting) Series E4-48L
E4-480-Width-12

Part No. Full Set (pivoting) with profile rail Series E4-48L
E4-480-Width-12P

Width	Part No. Full Set chain		With Profile Rail	Bi in. (mm)	Width	Part No. Full Set chain		With Profile Rail	Bi in. (mm)
	Pivoting	Locking				Pivoting	Locking		
-050	E4-480	E4-481	-050-12	P 1.97 (50)	-150	E4-480	E4-481	-150-12	P 5.91 (150)
-062	E4-480	E4-481	-062-12	P 2.68 (62.5)	-162	E4-480	E4-481	-162-12	P 6.38 (162)
-075	E4-480	E4-481	-075-12	P 2.95 (75)	-175	E4-480	E4-481	-175-12	P 6.61 (175)
-087	E4-480	E4-481	-087-12	P 3.43 (87.5)	-200	E4-480	E4-481	-200-12	P 7.87 (200)
-100	E4-480	E4-481	-100-12	P 3.94 (100)	-225	E4-480	E4-481	-225-12	P 8.86 (225)
-105	E4-480	E4-481	-105-12	P 4.25 (105)	-237	E4-480	E4-481	-237-12	P 9.33 (237)
-112	E4-480	E4-481	-112-12	P 4.41 (112)	-250	E4-480	E4-481	-250-12	P 9.84 (250)
-125	E4-480	E4-481	-125-12	P 4.92 (125)	-262	E4-480	E4-481	-262-12	P 10.31 (262)
-137	E4-480	E4-481	-137-12	P 5.39 (137)					

e-chain system® E4-1 light Series E4-48L/R4-48L Mounting Brackets - KMA



E4-48L
R4-48L

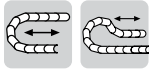

Standard

Option 1: pivoting

- Recommended for unsupported and gliding applications
- Attachment capability on all sides
- Bolted connection outside of chain cross-section
- Space restricted conditions
- Corrosion resistant

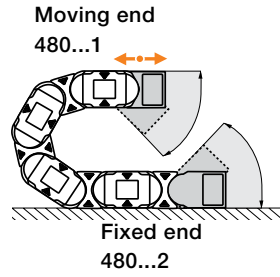

Pivoting angle depends on radius

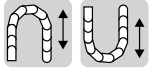
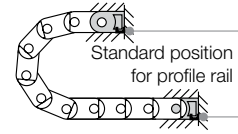

Option 2: locking

- Profile rail option
- Universal use
- Corrosion resistant
- Vertical hanging/standing travels
- Extreme accelerations

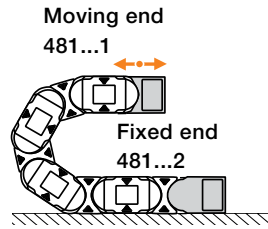

Pivoting angle depends on radius

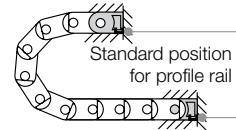

Part Number Structure

R4-480-07-12 P

With Profile Rail
Complete Set
Width

R4-480 = Pivoting
R4-481 = Locking

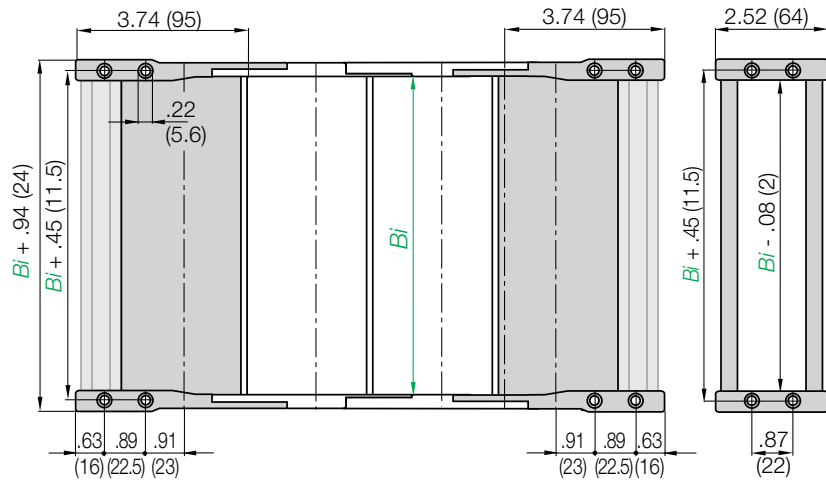

Due to the design of the R4-48L series chains, please note the following when ordering brackets:

Even number of links = full set, part number ending in -12; Odd number of links = 2 pieces, part number ending in -1

Part number examples are shown for pivoting brackets for e-chain.

For locking brackets change part number to 481

Part No. Full Set (pivoting)

Tube Series R4-48L

R4-480-Width-12

Part No. Full Set (pivoting)

with Profile Rail

Tube Series R4-48L

R4-480-Width-12P

Width	Part No. Full Set tube		With Profile Rail	Bi in. (mm)	Width	Part No. Full Set tube		With Profile Rail	Bi in. (mm)		
	Pivoting	Locking				Pivoting	Locking				
-050	R4-480	R4-481	-050-12	P	1.97 (50)	-150	R4-480	R4-481	-150-12	P	5.91 (150)
-062	R4-480	R4-481	-062-12	P	2.68 (62.5)	-175	R4-480	R4-481	-175-12	P	6.61 (175)
-075	R4-480	R4-481	-075-12	P	2.95 (75)	-200	R4-480	R4-481	-200-12	P	7.87 (200)
-100	R4-480	R4-481	-100-12	P	3.94 (100)	-250	R4-480	R4-481	-250-12	P	9.84 (250)
-125	R4-480	R4-481	-125-12	P	4.92 (125)						

PDF: igus.com/e-chain-pdfs
Product information: igus.com/e-chains



E4-48L
R4-48L



e-chain system® E4-1 light
Series E4-48L
Accessories

igus® energy chain
System®

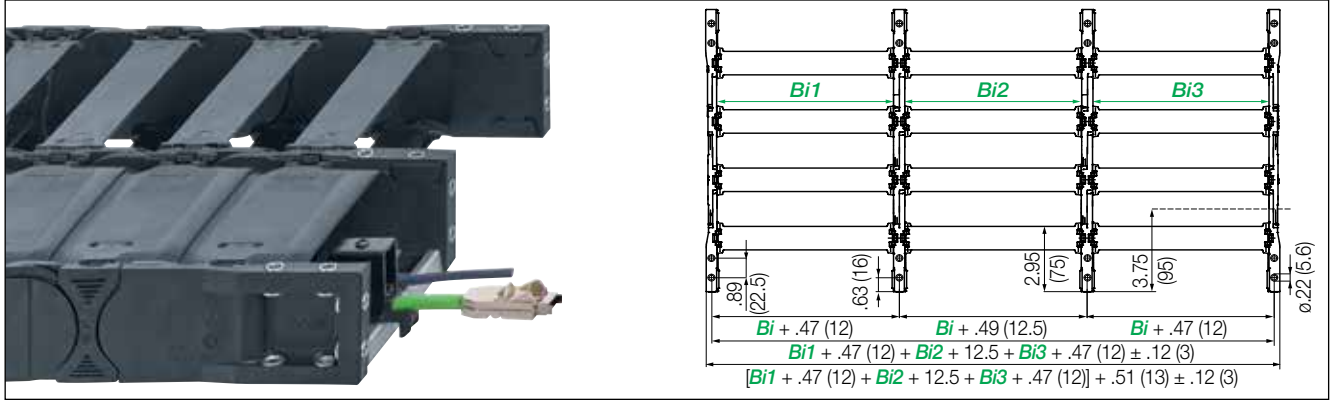

Telephone 1-800-521-2747

Extension links | For extremely wide e-chains® up to 6.56 ft. (2.0m) with 50% more fill weight

- Extension link e-chains® for 50% higher fill weight extension link up to widths of 6.56 ft. (2.0m) and more
- For heavy fill weights or e-chains® with many heavy cables next to each other
- e-chains® and e-tubes can be combined

Part No.	Part No.	Part No.
Extension link e-chain®	Extension link e-tube	Extension link as an individual part
E4-48L- <i>Bi1/Bi2/Bi3-R-0</i>	R4-48L- <i>Bi1/Bi2/Bi3-R-0</i>	E4-48ML- <i>R-</i>

Complete Part No. with the width index *Bi1/Bi2/Bi3/etc.* and the radius (*R*). Example: E4-48L-175/175/175-150-0

Increase of the fill weight per extension link

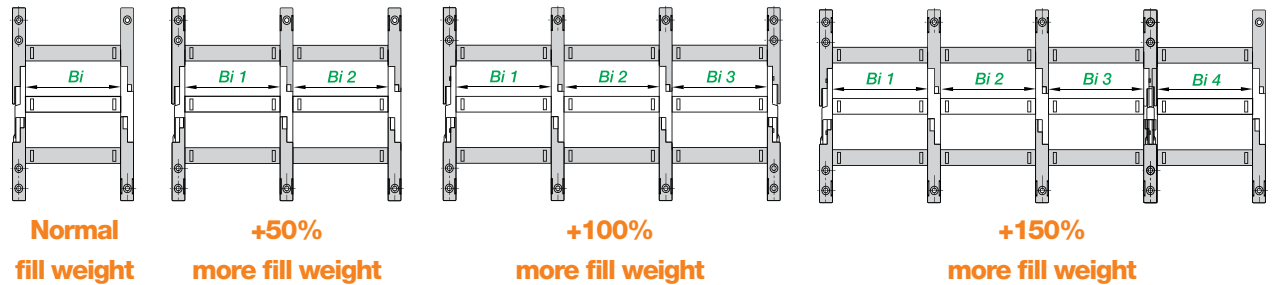

Internet: igus.com
email: sales@igus.com
QuickSpec: igus.com/quickspec

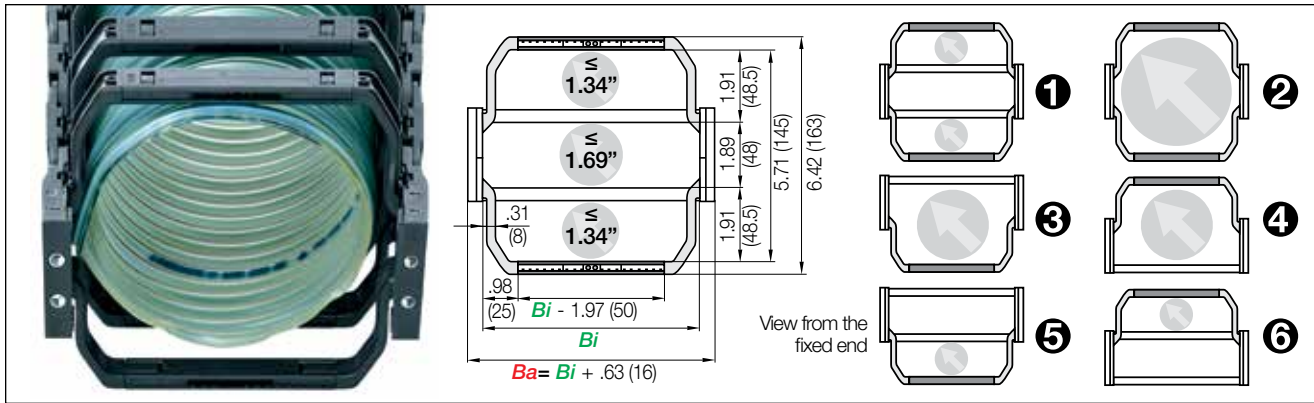

Extender crossbars with flexible width | Safe guiding for large hoses

- For guiding and protecting large hoses
- With mounting for noise dampers
- Cable-friendly design, high crossbar holding force
- The openable extender crossbars can be fitted in different ways and combinations
- Optionally openable along the inner or outer radius

Versions e-chain®

with extender crossbar

	Hose Ø ≤ in. (mm)	Part No. e-chain® with extender crossbar
➊ Extender crossbar and standard crossbar alternating along the inner and outer radius ¹⁾	1.34 (34)	E4-48L-XXXHB48-R-0
➋ Extender crossbar on both sides along the inner and outer radius ²⁾	5.12 (130)	E4-48L-XXXB48-R-0
➌ Extender crossbar along the outer radius ³⁾	3.35 (85)	E4-48L-XXXBE48-R-0
➍ Extender crossbar along the inner radius ²⁾	3.35 (85)	E4-48L-XXXBZ48-R-0
➎ Extender crossbar and standard crossbar alternating along the outer radius ³⁾	1.34 (34)	E4-48L-XXXHBE48-R-0
➏ Extender crossbar and standard crossbar alternating along inner radius ¹⁾	1.34 (34)	E4-48L-XXXHBZ48-R-0

1) Minimum bend radius: **R 125**

2) Minimum bend radius: **R 150**

3) Minimum bend radius: **R 075** *Width available upon request. Delivery time upon request

Bi [mm] Available inner widths

| 100 | 125 | 137 | 150 | 162 | 175 | 187 | 200 | 212 | 225 | 237 | 250 |

Complete Part No. with the width index **XXX Bi** and the radius (**R**). Example

E4-48L-100B48-150-0 = extender crossbar on both sides along inner and outer radius



The E4.1L can be fitted with openable extender crossbars, which increase the size of the interior of the e-chain®. Crossbars can be fitted in various ways: from one or both sides, alternating with standard crossbars and or any combination



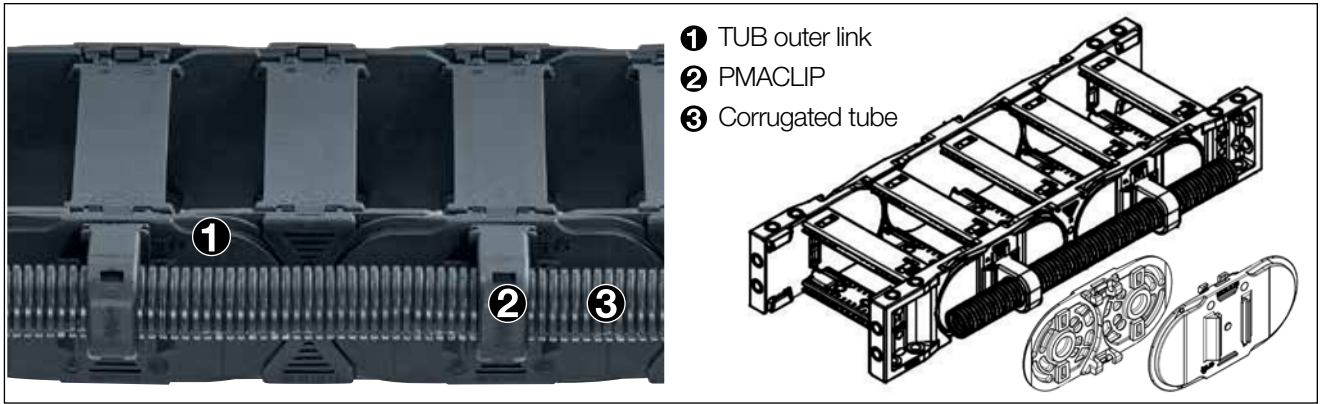

TUB | Safe guidance for corrugated tubes parallel to the e-chain®

- Additional, simple guidance for corrugated tubes on the outside of the e-chain®
- PMACLIP allows corrugated tubes with nominal widths .28 (07mm), .39 (10mm), .47 (12mm), .67 (17mm) to be easily clipped on
- Easy access to the corrugated tubes, fast replacement of the hoses
- Reduce assembly time and cost - easy to assemble, without any additional screws or tools
- The part number includes the e-chain® with TUB side sections; the PMACLIP support and the hose are ordered separately

Part No. TUB	Part No. TUB	Part No. TUB	For corrugated tube nominal diameter
Outer link right*	Outer link left*	Outer link at both ends*	Ø [mm]
E4-48L-XXXTUBR-R-0	E4-48L-XXXTUBL-R-0	E4-48L-XXXTUB-R-0	.28 (07), .39 (10), .47 (12), .67 (17)

*View from the fixed end

Part number appended with width index **XXX Bi** and radius (**R**) e.g.

E4-48L-100TUBR-150-0 = with TUB outer sections every 2nd right hand link

Steel support tray for saupport on the lower ruun

- Simple one-piece support trays for the lower run
- To your requirements and specifications
- 4 options available

More information ► Chapter 9



Hot chips up to +1,562°F

- e-tubes to withstand +1,562°F hot chips, as a special option
- No hot chip melting or embedding into the chain
- igus® igumid HT material

More information ► www.igus.com/HT

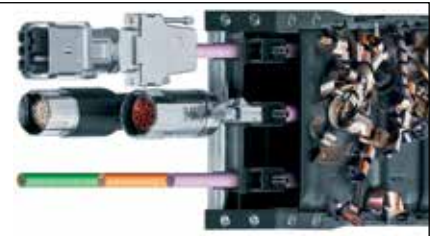

Honeycomb strain relief - CFU - Assembled in seconds

- Simply insert cables and hoses into the honeycomb and close
- Strain relief of different cables in one slot
- Easy to make changes to the filling
- Can be used in glidling applications

More information ► Chapter 10



e-chain system® E4-1 light

Series E4-48L/R4-48L

Strain Relief



E4-48L
R4-48L

Chainfix clamps for the profile rail

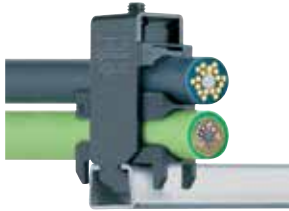

igus® Chainfix strain relief elements are available in either steel or stainless steel. They can be adjusted with a hexagon socket and are available in single, double and triple configurations.

Part No. Single Clamp		Part No. Double Clamp		Part No. Triple Clamp		Cable ø	
Steel	Stainless	Steel	Stainless	Steel	Stainless	in.	(mm)
CFX12-1	CFX12-1E	CFX12-2	CFX12-2E	CFX12-3	–	.24 - .47	(06 - 12)
CFX14-1	CFX14-1E	CFX14-2	CFX14-2E	CFX14-3	–	.47 - .55	(12 - 14)
CFX16-1	CFX16-1E	CFX16-2	CFX16-2E	CFX16-3	–	.55 - .63	(14 - 16)
CFX18-1	CFX18-1E	CFX18-2	CFX18-2E	CFX18-3	–	.63 - .71	(16 - 18)
CFX20-1	CFX20-1E	CFX20-2	CFX20-2E	CFX20-3	–	.71 - .79	(18 - 20)
CFX22-1	CFX22-1E	CFX22-2	CFX22-2E	CFX22-3	–	.79 - .87	(20 - 22)
CFX26-1	CFX26-1E	CFX26-2	CFX26-2E	–	–	.87 - 1.02	(22 - 26)
CFX30-1	CFX30-1E	CFX30-2	CFX30-2E	–	–	1.02 - 1.18	(26 - 30)
CFX34-1	CFX34-1E	CFX34-2	CFX34-2E	–	–	1.18 - 1.34	(30 - 34)
CFX38-1	CFX38-1E	–	–	–	–	1.34 - 1.50	(34 - 38)
CFX42-1	CFX42-1E	–	–	–	–	1.50 - 1.65	(38 - 42)

For more information please refer to strain relief section of Chapter 10

Tiewrap Plates

Option 1: Tiewrap plates as an individual part

Available as an individual component, can be fixed onto a mounting bracket with the use of a profile rail.

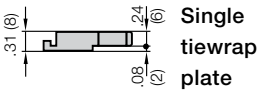
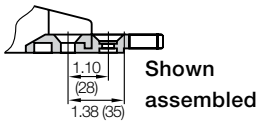

Tiewrap Plate	n Number of Teeth	C Overall Width in. (mm)	B Bore Width in. (mm)	Center Bore
3050-ZB	5	1.97 (50)	1.18 (30)	no
3075-ZB	7	2.95 (75)	2.16 (55)	no
3100-ZB	10	3.94 (100)	3.15 (80)	no
3115-ZB	11	4.53 (115)	3.74 (95)	no
3125-ZB	12	4.92 (125)	4.13 (105)	no
3150-ZB	15	5.91 (150)	5.12 (130)	no
3175-ZB	17	6.89 (175)	6.10 (155)	no
3200-ZB	20	7.87 (200)	7.09 (180)	yes
3225-ZB	22	8.86 (225)	8.07 (205)	yes
3250-ZB	25	9.84 (250)	9.06 (230)	yes

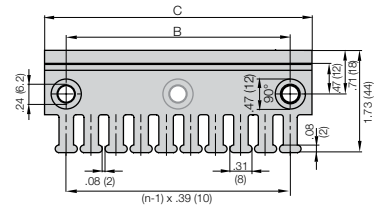

If used with KMA brackets with profile rail please add "KMA" to the end of the part number.

For more information please refer to strain relief section of Chapter 10

Option 2: Clip-on Tiewrap plates

Available as a clip-on tiewrap plate without the use of bolts They are inserted and removed with a screwdriver used as a lever. Clip-on tiewrap plates are also available as an attachment to the opening crossbars.



Part No.	Number of Teeth	Width of Strain Relief in. (mm)
3050-ZC	5	1.97 (50)
3075-ZC	7	2.95 (75)

For more information please refer to strain relief section of Chapter 10

Strain relief with tiewrap teeth

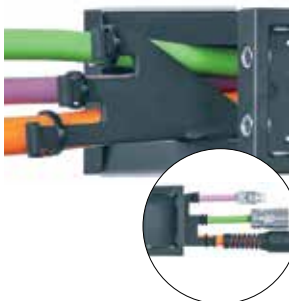

Part No.	For series	Inner height <i>hi</i> in. (mm)	For use in
CFV-42-C	E4-64L	2.52 (64)	Top-hat (DIN) rail 15 (TS92.31)

PDF: igus.com/e-chain-pdfs
Product information: igus.com/e-chains



Guide troughs are used with applications where the upper run of the e-chain® glides on the lower run. If using igus® steel guide troughs, the following components are required:

- Full travel length of guide trough
Part No. 93-30
- 1/2 travel length of glide bars
Part No. 93-01
- Installation sets as end connectors
Part No. 93-50-XX

-XX indicates the length of the profile rail on which the guide trough is mounted. The values and part numbers are specified in the table below. The standard length of the trough components and glide bars is 6.56 ft (2 m). The required overall length of the guide trough directly correlates to the length of travel

Example:

Length of travel 164 ft (50 m)
Center mounted

Required guide troughs:

164 ft (50 m) guide trough,
82 ft (25 m) glide bar
= 25 sections of 6.56 ft (2 m) guide trough

Part No. 93-30

= 13 sections of 6.56 ft (2 m) glide bar

Part No. 93-01

Required number of installation sets:

= Number of guide trough components + 1
= 25 + 1 = 26

Part No. of the installation sets **93-50-XXX**

Example: 93-50-400 for 15.75 (400 mm) long profile rail



Left: Guide trough with glide bars
Right: Guide troughs without glide bars



Installation sets as section connectors

Width of Crossbar
E4-48L-100-200-0

	B_{Ri}	Installation Part No.
-050	2.95 (75)	93-50-200
-062	3.43 (87)	93-50-200
-075	3.94 (100)	93-50-225
-087	4.41 (112)	93-50-225
-100	4.92 (125)	93-50-250
-105	5.11 (130)	93-50-250
-112	5.39 (137)	93-50-250
-125	5.91 (150)	93-50-275
-137	6.38 (162)	93-50-275
-150	6.89 (175)	93-50-300
-162	7.36 (187)	93-50-300
-175	7.87 (200)	93-50-325
-200	8.86 (225)	93-50-350
-225	9.84 (250)	93-50-375
-237	10.31 (262)	93-50-375
-250	10.83 (275)	93-50-400
-262	11.30 (287)	93-50-400
-300	12.80 (325)	93-50-450

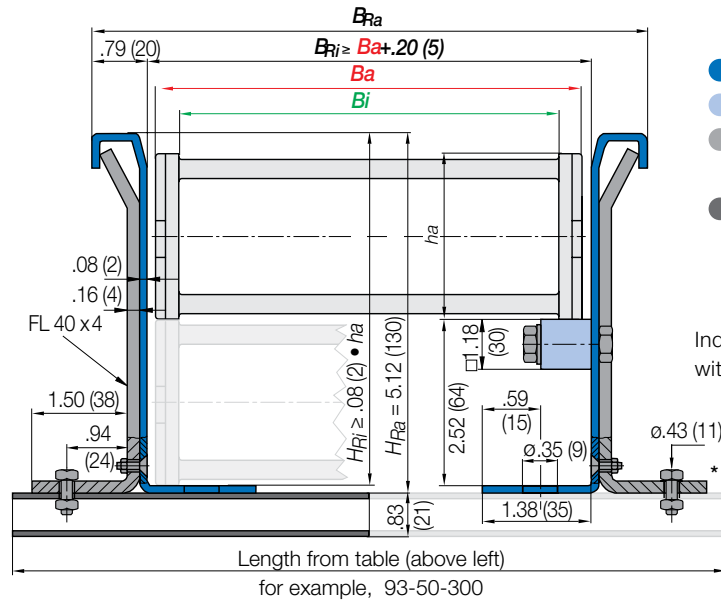

- Guide trough
- Glide bars
- Installation set "Basic"
- Profile rail

Individual attachment without profile rail

* Specialized guide trough available upon request

Standard length profile rail

e-chain system® E4-1 light
Series E4-48L/R4-48L



E4-48L
R4-48L

igus®
e-chain system®

Telephone 1-800-521-2747

Internet: igus.com
email: sales@igus.com
QuickSpec: igus.com/quickspec

6.178

Price Index



Series E4-64L

Series R4-64L

Special Options Available



Low noise version available with special rubber pads



Cleanroom test upon request



ESD classification:
Electrically conductive ESD/
ATEX version upon request

Assembly Tips



Opening To open, insert the screwdriver into the locking mechanism and pry it open outwards

Other Installation Methods

Vertical, hanging ≤ 262.5 ft (80 m)

Vertical, standing ≤ 26.25 ft (8 m)

Side-mounted, un_supp. ≤ 6.56 ft (2.0 m)

Rotary requires further calculation

Usage Guidelines



- If a lightweight, cost-effective e-chain® for high dynamics is required
- If short assembly times are required
- If optimized interior-exterior dimensions ratio is needed



- When the e-chain® needs to be extremely quiet (32dB(A)) with very low vibration
 - **Series E6-1, Chapter 7**
- When the e-chain® is to be used in cleanrooms (cleanroom ISO class 1)
 - **Series E6-1, Chapter 7**
- If even higher strength is required
 - **Series E4-1, Chapter 6**

Features & Benefits

- 1 KMA mounting brackets with attachment points on all sides
- 2 Easy filling: inner diameter completely accessible
- 3 High stability due to undercut design
- 4 Efficient: less weight, enhanced dynamics
- 5 Notch crossbar with visual scale
- 6 Short assembly time: pivotable crossbars, snap-open along the inner and outer radius
- 7 Interior separation possible
- 8 Straight run due to inner/outer link design
- 9 Version NCST "without camber" simply by turning outer links without unnecessary rework

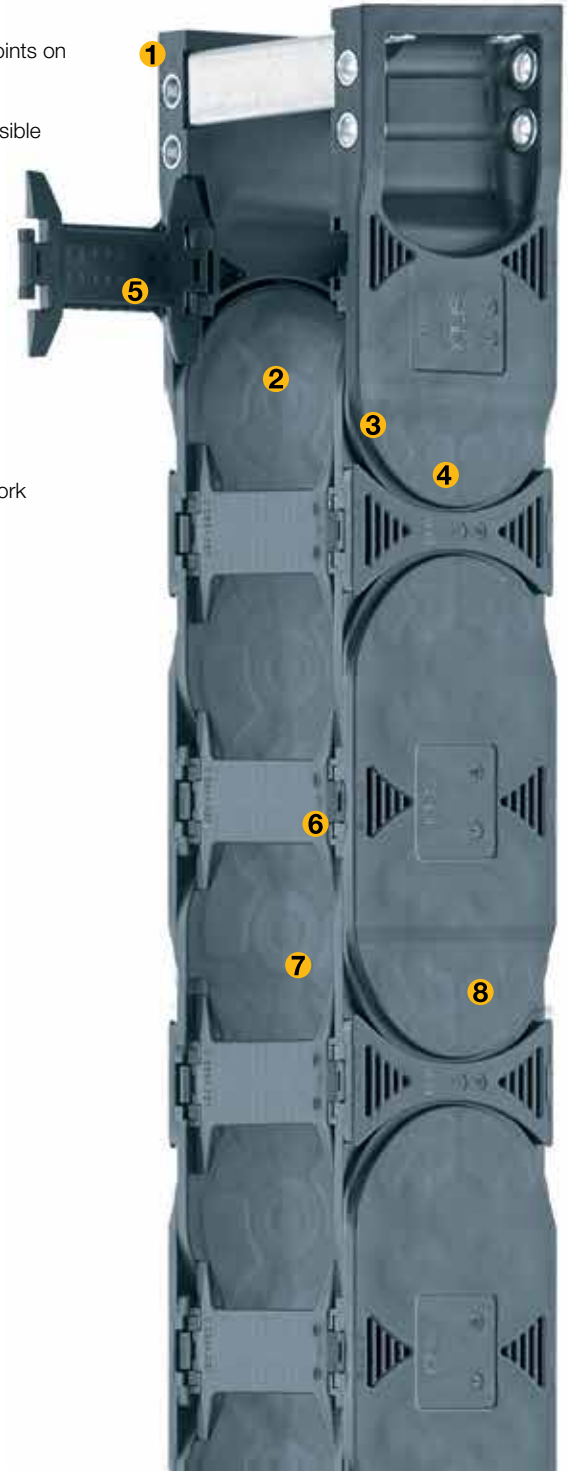

Also available without camber. Add NCST to the end of the part number.
Ex: E4-64L-100-200NCST

Order Example: Complete e-chain®

Please indicate chain length or number of links. Example:

13.12 ft (4 m) **E4-64L-100-200-0**



e-chain®

With 2 separators **64-2-1** assembled every 2nd link



Interior Separation

1 Set **E4-640-100-12P**



Mounting Bracket

e-chain system® E4-1 light Series E4-64L Installation Dimensions



E4-64L

Short travel, unsupported length

- FL_B = unsupported with permitted sag
 - FL_G = unsupported with straight upper run
- Further information ► Design, Chapter 1

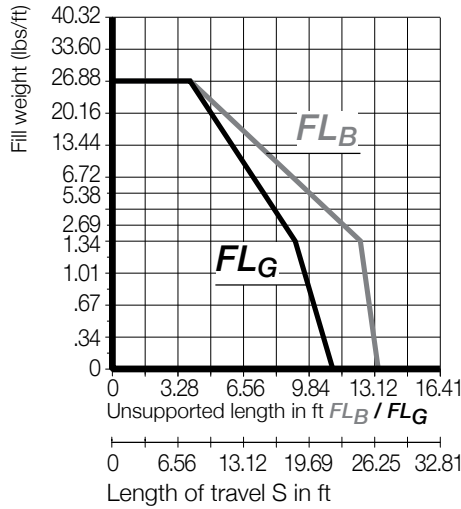
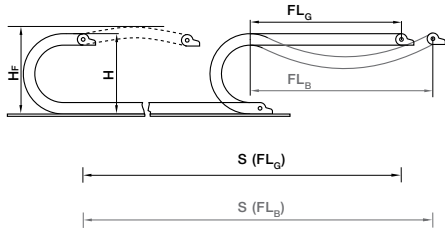

Short Travels - Unsupported

Unsupported e-chains® feature positive camber over short travels. This must be accounted for when specifying the clearance height. Please refer to for further details.

Legend

- S = Length of travel
- R = Bending radius
- H = Nominal clearance height
- D = Overlength e-chain® radius in final position
- $K = \pi \cdot R + \text{safety buffer}$
- H_f = Required clearance height
- H_{ri} = Trough inner height
- H₂ = *Mounting height
- D₂ = Overlength - long travels, gliding
- K₂ = *Add-on
- *If the mounting bracket location is set lower

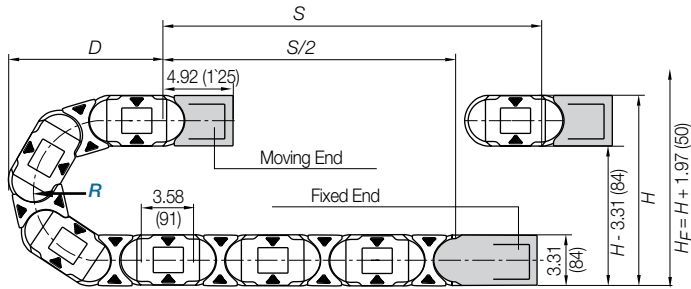

- Pitch per link = 3.58" (91 mm)
- Links per (m) = (11)
- For center mount applications:
Chain length = $S/2 + K$

The required clearance height: $H_f = H + 1.97$ in. (50 mm) (with .67 lbs/ft (1.0 kg/m) fill weight. Please consult igus® if space is particularly restricted.

R	3.94 (100)	4.92 (125)	5.91 (150)	6.89 (175)	7.87 (200)	9.84 (250)	11.81 (300)	13.78 (350)	15.75 (400)
H	11.18 (284)	13.15 (334)	15.12 (384)	17.09 (434)	19.06 (484)	22.99 (584)	26.93 (684)	30.87 (784)	34.80 (884)
D	10.98 (279)	11.97 (304)	12.95 (329)	13.94 (354)	14.92 (379)	16.89 (429)	18.86 (479)	20.83 (529)	22.80 (579)
K	19.69 (500)	22.64 (575)	25.79 (655)	28.94 (735)	32.09 (815)	38.19 (970)	44.29 (1125)	50.59 (1285)	56.69 (1440)

Gliding applications | For long travels, upon request

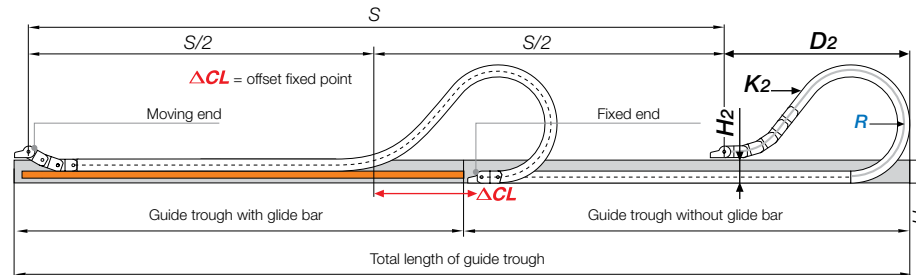

For center mount applications:
Chain length = $S/2 + K_2$

Note: We recommend the project planning of such a system to be carried out by igus®. In case of travels between 16.4 and 32.8 ft. (5 and 10m) we recommend an e-chain® with a longer unsupported length.

R	3.94 (100)	4.92 (125)	5.91 (150)	6.89 (175)	7.87 (200)	9.84 (250)	11.81 (300)	13.78 (350)	15.75 (400)
H ₂	—	7.09 (180)	7.09 (180)	7.09 (180)	7.09 (180)	7.09 (180)	—	—	—
D ₂	—	19.88 (505)	22.83 (580)	27.76 (705)	32.68 (830)	42.52 (1080)	—	—	—
K ₂	—	32.24 (819)	35.83 (910)	46.57 (1183)	53.74 (1365)	68.07 (1729)	—	—	—
ΔCL	—	**	**	**	**	**	—	—	—

**Values upon request

Speed / acceleration FL_G	max. 65.6 ft/s (20 m/s) / max. 656 ft/s ² (200 m/s ²)
Speed / acceleration FL_B	max. 9.84 ft/s (3 m/s) / max. 19.69 ft/s ² (6 m/s ²)
Gliding speed / acceleration (maximum)	max. 16.4 ft/s (5 m/s) / max. 82 ft/s ² (25 m/s ²)
Material - permitted temperature	igumid G / -40°F (-40°C) up to +248°F (+120° C)
Flammability Class, igumid G	VDE 0304 IIC UL94 HB

Technical Data



Details of material properties

► Chapter 1



PDF: igus.com/e-chain-pdfs
Product information: igus.com/e-chains



Series E4-64L - e-chain® with crossbars every link

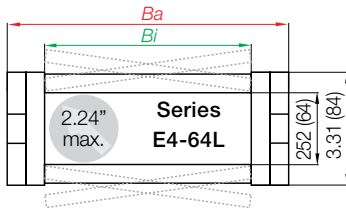

- Crossbars every link
- For use with rigid hydraulic hoses
- For particularly demanding applications
- Can be opened from both sides

Part Number Structure



- Color - Black
- Bending radius
- Width
- Series



e-chain® as separate parts, links and side plates

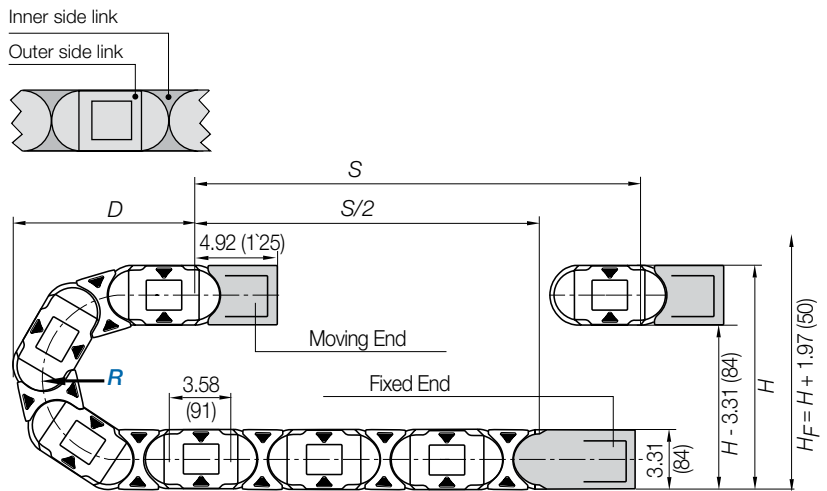
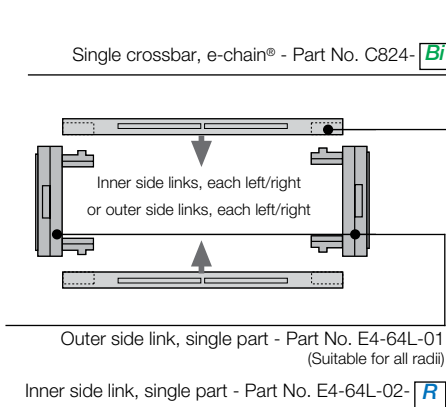

Supplement part number with required radius. Example: E4-64L-100-200-0
Pitch: 3.58 in. (91 mm) per link links/ft (m) = (11)

Part Number	Bi	Ba	Weight E4-64L
Crossbars	in. (mm)	in. (mm)	lbs/ft (kg/m)
E4-64L-087-□-0	3.94 (87)	3.98 (101)	≈ 0.56 (0.83)
E4-64L-100-□-0	3.94 (100)	4.49 (114)	≈ 0.59 (0.88)
E4-64L-150-□-0	5.91 (150)	6.46 (164)	≈ 0.67 (1.00)
E4-64L-175-□-0	6.89 (175)	7.44 (189)	≈ 0.75 (1.13)
E4-64L-200-□-0	9.84 (200)	8.43 (214)	≈ 0.79 (1.17)

Choose from the radii below for all of the above sizes

Radius (mm) Example: E4-64L-100-200-0

	100	125	150	175	200	250	300	350	400
R	3.94 (100)	4.92 (125)	5.91 (150)	6.89 (175)	7.87 (200)	9.84 (250)	11.81 (300)	13.78 (350)	15.75 (400)
H	11.18 (284)	13.15 (334)	15.12 (384)	17.09 (434)	19.06 (484)	22.99 (584)	26.93 (684)	30.87 (784)	34.80 (884)
D	10.98 (279)	11.97 (304)	12.95 (329)	13.94 (354)	14.92 (379)	16.89 (429)	18.86 (479)	20.83 (529)	22.80 (579)
K	19.69 (500)	22.64 (575)	25.79 (655)	28.94 (735)	32.09 (815)	38.19 (970)	44.29 (1125)	50.59 (1285)	56.69 (1440)

For other colors see Chapter 1

e-chain system® E4-1 light
Series E4-64L/R4-64L
Interior Separation



E4-64L

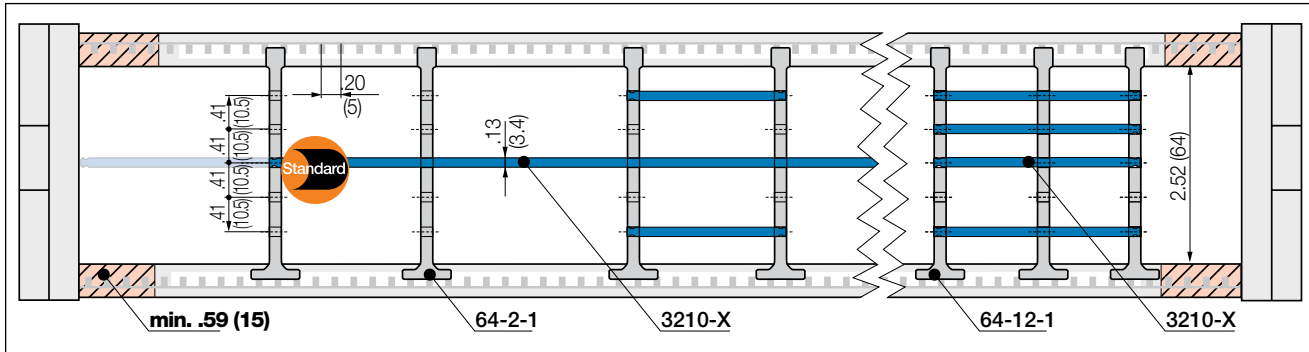

Note: Please maintain a lateral spacing of .24" (6 mm) between the separators and the side links. In the standard configuration separators are assembled every 2nd e-chain® link

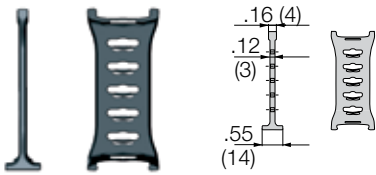

Separator, narrow top

Unassembled	Part No. 64-2
Assembled	Part No. 64-2-1

• **Separator 64-2**

For even faster installation

Firm hold to one side with a wide base, narrow on opposed side for easy cable assembly (slight grip).

Lockable full-width shelves - for the standard interior separation

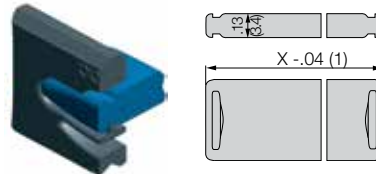

Full width shelf, lockable

Unassembled	Part No. 3200-X
Assembled	Part No. 3210-X

• **Full width shelf, lockable**

Shelf locks safely into separators on both ends, fixed width possible. Separators can be moved freely over the shelf in horizontal direction. Can be used at 3 different heights.

Width X in. (mm)	Part No. Unassembled	Part No. Assembled	Width X in. (mm)	Part No. Unassembled	Part No. Assembled	Width X in. (mm)	Part No. Unassembled	Part No. Assembled
1.97 (050)	3200-50	3210-50	4.92 (125)	3200-125	3210-125	8.86 (225)	3200-225	3210-225
2.95 (075)	3200-75	3210-75	5.91 (150)	3200-150	3210-150	9.84 (250)	3200-250	3210-250
3.94 (100)	3200-100	3210-100	6.89 (175)	3200-175	3210-175			
4.53 (115)	3200-115	3210-115	7.87 (200)	3200-200	3210-200			

Interior separation | To allow faster filling

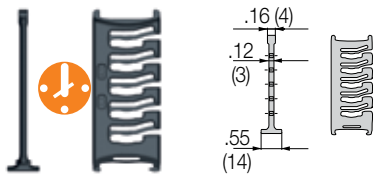

Lean Separator

Unassembled	Part No. 64-2
Assembled	Part No. 64-2-1

• **Lean separators**

New design allows extremely fast fitting of shelves in several layers, which significantly reduces assembly time. Enables extremely fast replacement of individual cables in a very full e-chain®.



• **Lean separator design - several layers of cables fitted quickly, save up to 50%* assembly time**

(*Lean separator vs. standard separator - measured on a 13.12 ft. (4m) long e-chain® fitted with 12 cables in the igus® harnessing factory)

PDF: igus.com/e-chain-pdfs
Product information: igus.com/e-chains



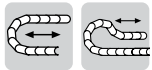

Standard

Option 1: pivoting

- Recommended for unsupported and gliding applications
- Attachment capability on all sides
- Bolted connection outside of chain cross-section
- Space restricted conditions
- Corrosion resistant

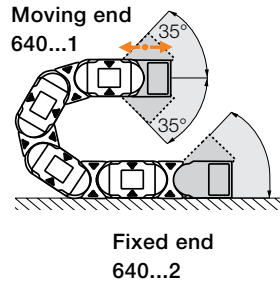

Pivoting angle depends on radius

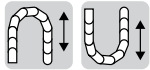
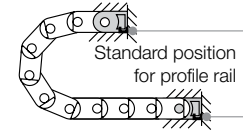

Option 2: locking

- Profile rail option
- Universal use
- Corrosion resistant
- Vertical hanging/standing travels
- Extreme accelerations

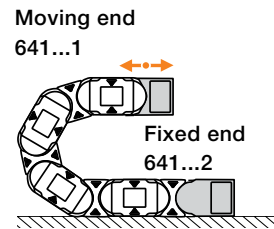

Pivoting angle depends on radius

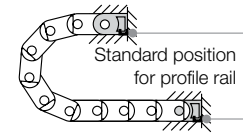

Part Number Structure

E4-640-050-12 P

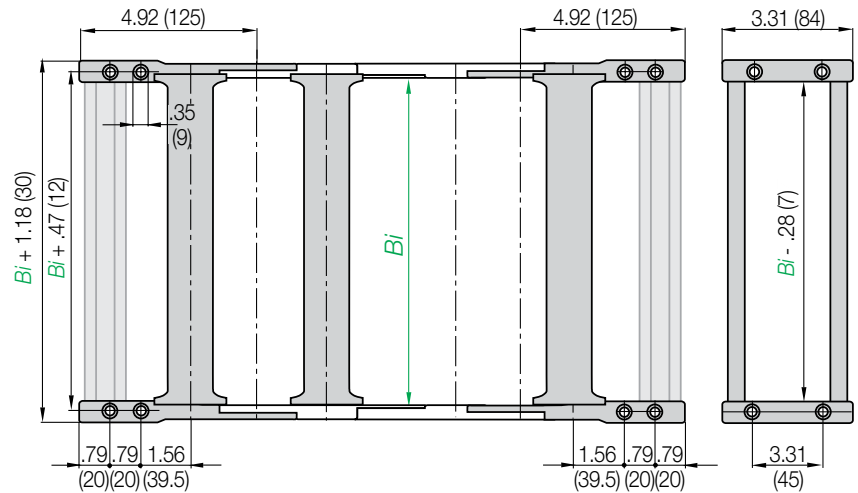
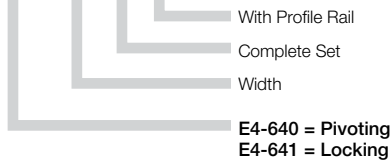

Due to the design of the E4-64L series chains, please note the following when ordering brackets:
Even number of links = full set, part number ending in -12; Odd number of links = 2 pieces, part number ending in -1

Part number examples are shown for pivoting brackets for e-chain.
For locking brackets change part number to 641

Part No. Full Set (pivoting)
Series E4-64L
E4-640-Width-12

Part No. Full Set (pivoting)
with profile rail
Series E4-64L
E4-640-Width-12P

Width	Part No. Full Set chain		With Profile Rail	B_i in. (mm)	Width	Part No. Full Set chain		With Profile Rail	B_i in. (mm)
	Pivoting	Locking				Pivoting	Locking		
-040	E4-640	E4-641	-040-12	P 1.57 (40)	-125	E4-640	E4-641	-125-12	P 4.92 (125)
-050	E4-640	E4-641	-050-12	P 1.97 (50)	-137	E4-640	E4-641	-137-12	P 5.39 (137.5)
-062	E4-640	E4-641	-062-12	P 2.68 (62.5)	-150	E4-640	E4-641	-150-12	P 5.91 (150)
-075	E4-640	E4-641	-075-12	P 2.95 (75)	-162	E4-640	E4-641	-162-12	P 6.38 (162.5)
-087	E4-640	E4-641	-087-12	P 3.43 (87.5)	-175	E4-640	E4-641	-175-12	P 6.61 (175)
-100	E4-640	E4-641	-100-12	P 3.94 (100)	-187	E4-640	E4-641	-187-12	P 7.36 (187)
-112	E4-640	E4-641	-112-12	P 4.41 (112.5)	-200	E4-640/	E4-641	-200-12	P 7.87 (200)

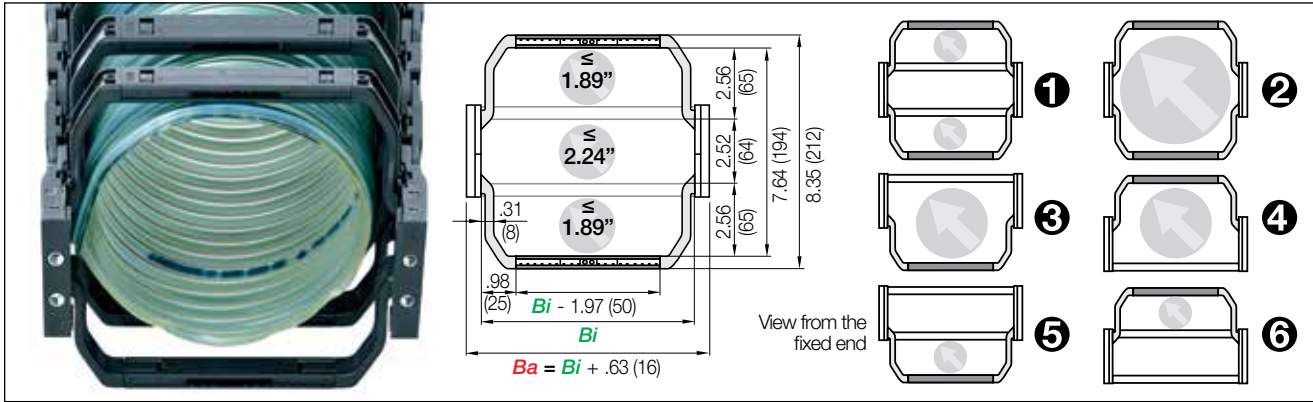

Extender crossbars with flexible width | Safe guiding for large hoses

- For guiding and protecting large hoses
- With mounting for noise dampers
- Cable-friendly design, high crossbar holding force
- The openable extender crossbars can be fitted in different ways and combinations
- Optionally openable along the inner or outer radius

Versions e-chain®

with extender crossbar

	Hose Ø ≤ in. (mm)	Part No. e-chain® with extender crossbar
① Extender crossbar and standard crossbar alternating along the inner and outer radius ¹⁾	1.89 (48)	E4-64L-XXXHB65-R-0
② Extender crossbar on both sides along the inner and outer radius ²⁾	6.69 (170)	E4-64L-XXXB65-R-0
③ Extender crossbar along the outer radius ³⁾	3.35 (115)	E4-64L-XXXBE65-R-0
④ Extender crossbar along the inner radius ²⁾	3.35 (115)	E4-48L-XXXBZ65-R-0
⑤ Extender crossbar and standard crossbar alternating along the outer radius ³⁾	1.89 (48)	E4-48L-XXXHBE65-R-0
⑥ Extender crossbar and standard crossbar alternating along inner radius ¹⁾	1.89 (48)	E4-48L-XXXHBZ65-R-0

1) Minimum bend radius: **R 125**

2) Minimum bend radius: **R 150**

3) Minimum bend radius: **R 100** *Width available upon request. Delivery time upon request

Bi [mm] Available inner widths

| 100 | 125 | 137 | 150 | 162 | 175 | 187 | 200 | 212 | 225 | 237 | 250 |

Complete Part No. with the width index **XXX Bi** and the radius (**R**). Example

E4-64L-100B65-150-0 = extender crossbar on both sides along inner and outer radius



The E4.1L can be fitted with openable extender crossbars, which increase the size of the interior of the e-chain®. Crossbars can be fitted in various ways: from one or both sides, alternating with standard crossbars and or any combination

Steel support tray for support on the lower run

- Simple one-piece support trays for the lower run
- To your requirements and specifications
- 4 options available

More information ► Chapter 9

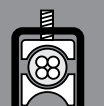

Chainfix clamps for the profile rail

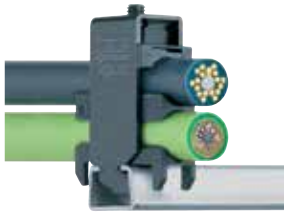

igus® Chainfix strain relief elements are available in either steel or stainless steel. They can be adjusted with a hexagon socket and are available in single, double and triple configurations.

Part No. Single Clamp		Part No. Double Clamp		Part No. Triple Clamp		Cable ø	
Steel	Stainless	Steel	Stainless	Steel	Stainless	in.	(mm)
CFX12-1	CFX12-1E	CFX12-2	CFX12-2E	CFX12-3	-	.24 - .47	(06 - 12)
CFX14-1	CFX14-1E	CFX14-2	CFX14-2E	CFX14-3	-	.47 - .55	(12 - 14)
CFX16-1	CFX16-1E	CFX16-2	CFX16-2E	CFX16-3	-	.55 - .63	(14 - 16)
CFX18-1	CFX18-1E	CFX18-2	CFX18-2E	CFX18-3	-	.63 - .71	(16 - 18)
CFX20-1	CFX20-1E	CFX20-2	CFX20-2E	CFX20-3	-	.71 - .79	(18 - 20)
CFX22-1	CFX22-1E	CFX22-2	CFX22-2E	CFX22-3	-	.79 - .87	(20 - 22)
CFX26-1	CFX26-1E	CFX26-2	CFX26-2E	-	-	.87 - 1.02	(22 - 26)
CFX30-1	CFX30-1E	CFX30-2	CFX30-2E	-	-	1.02 - 1.18	(26 - 30)
CFX34-1	CFX34-1E	CFX34-2	CFX34-2E	-	-	1.18 - 1.34	(30 - 34)
CFX38-1	CFX38-1E	-	-	-	-	1.34 - 1.50	(34 - 38)
CFX42-1	CFX42-1E	-	-	-	-	1.50 - 1.65	(38 - 42)

For more information please refer to strain relief section of Chapter 10

Tiewrap Plates

Option 1:

Tiewrap plates as an individual part

Available as an individual component, can be fixed onto a mounting bracket with the use of a profile rail.

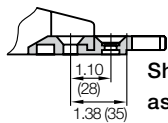

Shown assembled

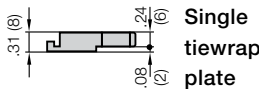

Single tiewrap plate

Tiewrap Plate	n Number of Teeth	C Overall Width in. (mm)	B Bore Width in. (mm)	Center Bore
3050-ZB	5	1.97 (50)	1.18 (30)	no
3075-ZB	7	2.95 (75)	2.16 (55)	no
3100-ZB	10	3.94 (100)	3.15 (80)	no
3115-ZB	11	4.53 (115)	3.74 (95)	no
3125-ZB	12	4.92 (125)	4.13 (105)	no
3150-ZB	15	5.91 (150)	5.12 (130)	no
3175-ZB	17	6.89 (175)	6.10 (155)	no
3200-ZB	20	7.87 (200)	7.09 (180)	yes
3225-ZB	22	8.86 (225)	8.07 (205)	yes
3250-ZB	25	9.84 (250)	9.06 (230)	yes

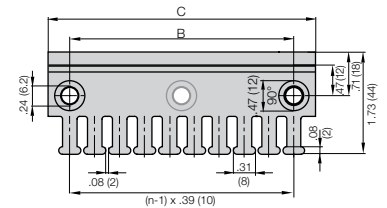

If used with KMA brackets with profile rail please add "KMA" to the end of the part number.

For more information please refer to strain relief section of Chapter 10

Option 2:

Clip-on Tiewrap plates

Available as a clip-on tiewrap plate without the use of bolts. They are inserted and removed with a screwdriver used as a lever. Clip-on tiewrap plates are also available as an attachment to the opening crossbars.

Part No.	Number of Teeth	Width of Strain Relief in. (mm)
3050-ZC	5	1.97 (50)
3075-ZC	7	2.95 (75)

For more information please refer to strain relief section of Chapter 10

Strain relief with tiewrap teeth



Part No.	For series	Inner height <i>hi</i> in. (mm)	For use in
CFV-80-C	E4-64L	2.52 (64)	Top-hat (DIN) rail 15 (TS92.31)

e-chain system® E4-1 light Series E4-64L Guide Trough



E4-64L

Guide troughs are used with applications where the upper run of the e-chain® glides on the lower run. If using igus® steel guide troughs, the following components are required.

- Full travel length of guide trough
Part No. 94-30
- 1/2 travel length glide bars
Part No. 93-01
- Installation sets as end connectors
Part No. 94-50-XX

.XX indicates the length of the profile rails on which the guide trough is mounted. The values and part numbers are specified in the table on the left. The standard length of the trough components and glide bars is 6.56 ft (2m). The required overall length of the guide trough directly correlates to the length of travel.

Example:

Length of travel 164 ft (50 m)
Center mounted
-

Required guide troughs:

164 ft (50 m) guide trough
82 ft (25 m) glide bars
= 25 sections of 6.56 ft (2 m) guide trough

Part No. 94-30

= 13 sections of 6.56 ft (2 m) glide bars

Part No. 93-01

Required number of installation sets:

= Number of guide trough components + 1
= 25 + 1 = 26

Part number of the installation sets

94-50-XXX

Example:

94-50-400 for 15.75 (400 mm) long profile rail



Left: Guide trough with glide bars
Right: Guide troughs without glide bars



Installation sets as section connectors

Width of Crossbar
E4-56-05-200-0

	B_{Pi}	Installation Part No.
-087	4.65 (118)	94-50-250
-100	5.16 (131)	94-50-250
-150	7.13 (181)	94-50-300
-200	9.09 (231)	94-50-350

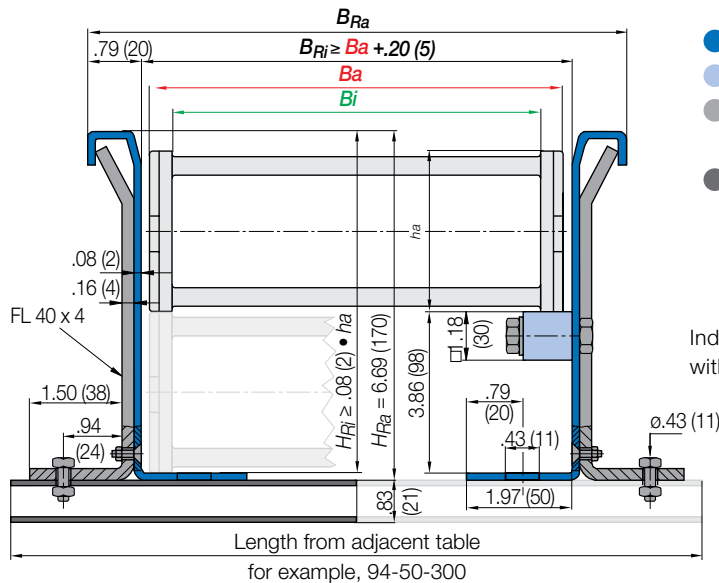

- Guide trough
- Glide bars
- Installation set "Basic"
- Profile rail

Individual attachment without profile rail

* Specialized guide trough available upon request

Standard length profile rail

PDF: igus.com/e-chain-pdfs
Product information: igus.com/e-chains

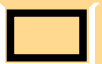





hooks.

claws.

igus[®]
E4/light

6.188

E4/light - stable, lightweight and cost-effective

System E4/Light – E4 ‘light’ features smaller side links (all sizes and styles) and thinner crossbars (specifically styles 14240 and 14340) when compared to igus®’ standard E4 cable carriers. It’s cost-effective, lightweight and still offers a large interior space for multiple cables and hoses. E4 light works especially for unsupported, short travel applications and is also ideal in hanging and short-standing designs.

Typical industries and applications

- Machine tools
- Material handling
- Stone cutting machines
- Woodworking machines
- General machinery
- Vehicles
- Construction machinery
- Limited long travel applications



ATEX/ESD: Excellent performance with the special material igumid ESD (upon request) “Rear grip” achieves long-term electrical conductivity



Side-mounted - unsupported



High torsional rigidity



System E4/4 approved
with long travels





E4/light e-chains® and e-tubes are ideal in Machine Tools



E4/light in an unsupported application



With the space-saving igus® E4 polymer e-chains® the overall dimension for the installation for this crane system was considerably reduced

e-chain system® E4 light Selection Guide

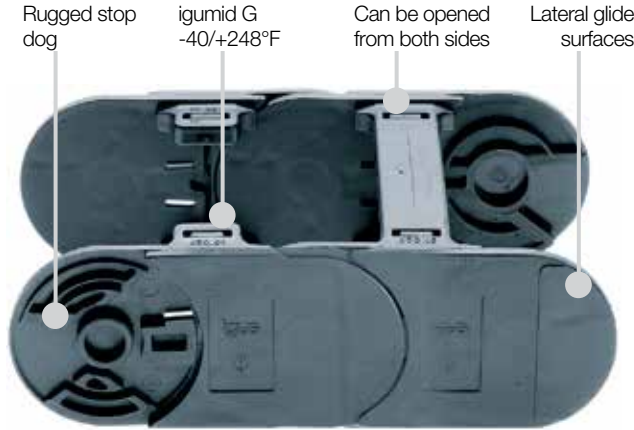

E4/light version with the approved E4/4 Series undercut design

- Lightweight
- Optimized ratio of interior and exterior dimension
- Cost-effective
- Numerous interior separation possibilities
- Wide range of modular accessories
- Narrow outer links
- Maximum stability in the igus® range
- Maximum travel: 492 - 820 ft (150 - 250 m)
- You can find more technical data about the material, chemical resistance, temperatures ► **Design, Chapter 1**

Crossbars every link for particularly demanding applications



Series	Inner height <i>hi</i> in. (mm)	Inner width <i>Bi</i> in. (mm)	Outer width <i>Ba</i> in. (mm)	Outer height <i>ha</i> in. (mm)	Bending radius <i>R</i> in. (mm)
14040	2.20 (56)	1.97-23.62 (50-600)	2.99-24.65 (76-626)	3.31 (84)	5.31-19.69 (135-500)
14240	2.44 (62)	1.97-15.75 (50-400)	2.99-16.77 (76-426)	3.31 (84)	5.31-19.69 (135-500)
14550	2.76 (70)	1.97-23.62 (50-600)	3.03-24.69 (77-627)	3.86 (98)	5.91-23.62 (150-600)
15050	3.15 (80)	1.97-23.62 (50-600)	3.15-24.80 (80-630)	4.25 (108)	5.91-19.69 (150-500)
15250	3.39 (86)	1.97-23.62 (50-400)	3.15-16.93 (80-430)	4.25 (108)	5.91-23.62 (150-600)
1640	4.41 (112)	1.97-23.62 (50-600)	3.31-24.96 (84-634)	5.51 (140)	7.87-23.62 (200-600)

Crossbars every 2nd link for almost all applications



Series	Inner height <i>hi</i> in. (mm)	Inner width <i>Bi</i> in. (mm)	Outer width <i>Ba</i> in. (mm)	Outer height <i>ha</i> in. (mm)	Bending radius <i>R</i> in. (mm)
14140	2.20 (56)	1.97-23.62 (50-600)	2.99-24.65 (76-626)	3.31 (84)	5.31-19.69 (135-500)
14340	2.44 (62)	1.97-15.75 (50-400)	2.99-16.77 (76-426)	3.31 (84)	5.31-19.69 (135-500)
14650	2.76 (70)	1.97-23.62 (50-600)	3.03-24.69 (77-627)	3.86 (98)	5.91-23.62 (150-600)
15150	3.15 (80)	1.97-23.62 (50-600)	3.15-24.80 (80-630)	4.25 (108)	5.91-19.69 (150-500)
15350	3.39 (86)	1.97-23.62 (50-400)	3.15-16.93 (80-430)	4.25 (108)	5.91-23.62 (150-600)

e-tubes fully enclosed, excellent cable protection

Available for certain widths and radii



Series	Inner height <i>hi</i> in. (mm)	Inner width <i>Bi</i> in. (mm)	Outer width <i>Ba</i> in. (mm)	Outer height <i>ha</i> in. (mm)	Bending radius <i>R</i> in. (mm)
R18840	2.20 (56)	2.95-18.19 (75-462)	3.98-19.25 (101-489)	3.31 (84)	5.91-19.69 (150-500)
R19050	2.76 (70)	2.95-18.19 (75-462)	4.01-19.25 (102-489)	3.86 (98)	7.87-23.62 (200-600)
R19850	3.15 (80)	2.95-18.19 (75-462)	4.13-19.41 (105-493)	4.25 (108)	7.87-19.69 (200-500)
R1608	4.25 (108)	7.87-19.69 (200-500)	9.21-17.09 (234-434)	5.51 (140)	9.84-23.62 (250-600)

e-chain system® E4 light

Assembly instructions

e-chains® and e-tubes - Assembling



1 Position at one side ...



2 ... and snap in



3 Position opposite side.
Press together and snap in

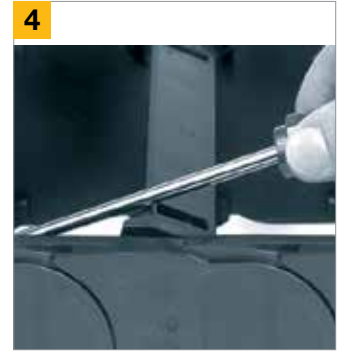

4 Assemble crossbars - push down and snap in using a screwdriver

Assembling continued



5 Assemble clips (for e-chains with crossbars every other link) - push down and snap in using a screwdriver



6 Assemble e-tube lids and bottoms - Attach to the connector at an angle and snap in place

e-chains® - Opening



1 Remove crossbars - Insert screwdriver into the slot, using a lever action, apply pressure to the screwdriver to remove the crossbar.



2 Remove clips - Insert screwdriver into the slot, using a lever action, apply pressure to the screwdriver to remove the clip

e-tube - Opening



1 Remove lids/bottoms - Insert screwdriver into the slot, using a lever action apply pressure to the screwdriver to release

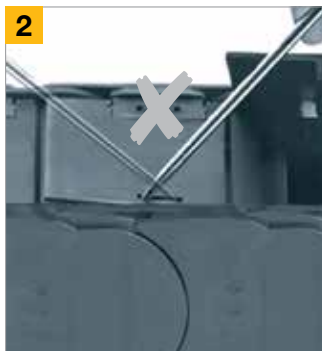

2 Release only **one side** to open the lid

e-chains® and e-tubes - Separating



1 Remove crossbars, clips, lids and bottoms at the outer links



2 Insert screwdriver into the slot between the side links. Using a lever action, release the side links

 Available from stock. Orders ship as early as today.*

*On average 90% of orders ship the same day..

14040
14140
R18840



e-chain system® E4 light Series 14040/14140/R18840

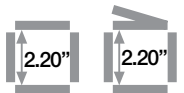

Price Index

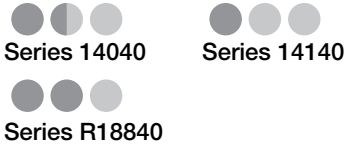

Special Features / Options

ESD classification:
Electrically conductive ESD/
ATEX version upon request

High torsional rigidity

Side-mounted - unsupported

Assembly Tips



Opening e-chains®: Remove crossbars and clips - Insert screwdriver into the slot, push down, release by lever action



Remove lids/bottoms (e-tubes) - Insert screwdriver into the slot, release by lever action

Other Installation Methods

Vertical, hanging ≤ 262 ft (80 m)

Vertical, standing ≤ 19.69 ft (6 m)

Side-mounted, un supp. ≤ 6.56 ft (2 m)

Rotary requires further calculation

Usage Guidelines



- If a simpler low-cost solution is required
- For maximum inner width with minimal outer width
- If the Series 400 is too large



- If a quieter version is required
➤ Series E6-52
- If side-mounted chain/tube with a long unsupported travel is required
➤ Series E4-56/H4-56/R4-56
- If increased unsupported lengths and longer travels are required
➤ Series E4-56/H4-56/R4-56

Features & Benefits

- 1 KMA mounting brackets with attachment points on all sides
- 2 Locking or pivoting mounting brackets available
- 3 Hinged snap-open removable lids along outer radius of e-tube
- 4 Lateral glide surfaces for side-mounted operation
- 5 Strain relief elements can be integrated with the mounting bracket
- 6 Closed and open styles can be combined
- 7 Removable lids along inner radius
- 8 High side-mount stability due to undercut
- 9 Crossbars on e-chains® are removable along both radii
- 10 Wide, rounded plastic crossbars - cable friendly
- 11 e-chain® also available with reverse bending radii

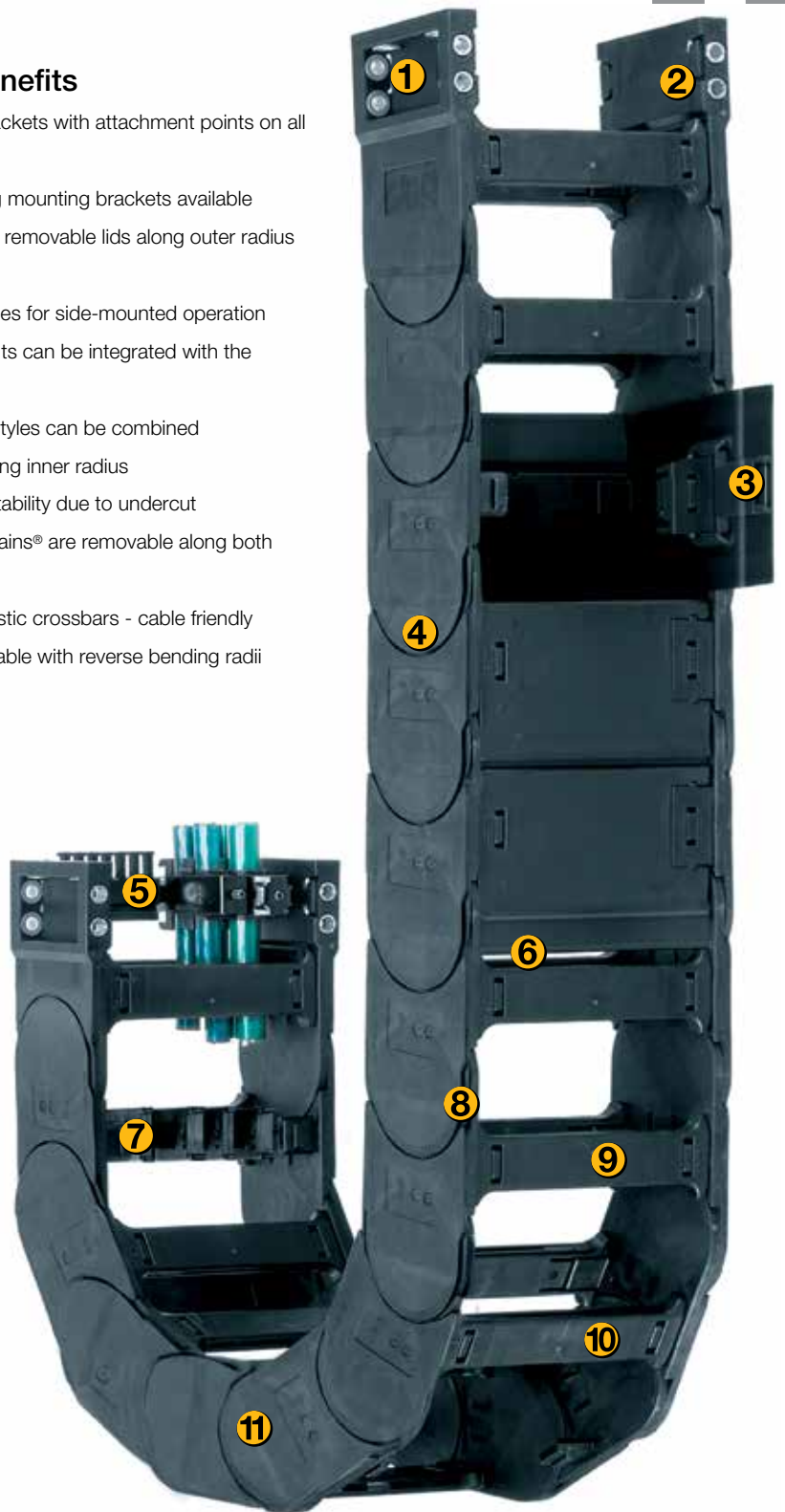

Order Example: Complete e-chain®

Please indicate chain length or number of links. Example:

16.4 ft (5 m) 14040-30-300-0

e-chain®

With 2 separators 56.1.1 assembled every 2nd link

Interior Separation

1 Set 141400-30-12P

Mounting Bracket

e-chain system® E4 light Series 14040/14140/R18840 Installation Dimensions

Short travel, unsupported length

- FL_B = unsupported with permitted sag
 - FL_G = unsupported with straight upper run
- Further information ► Design, Chapter 1

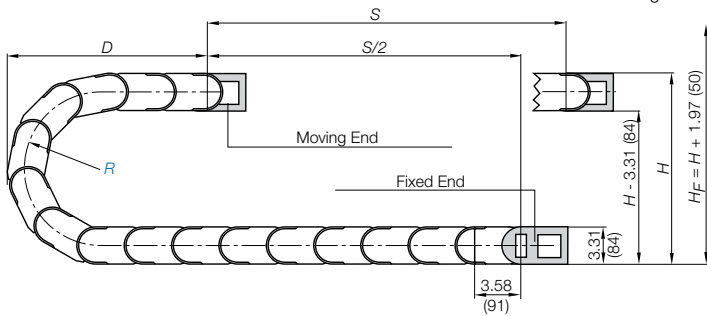
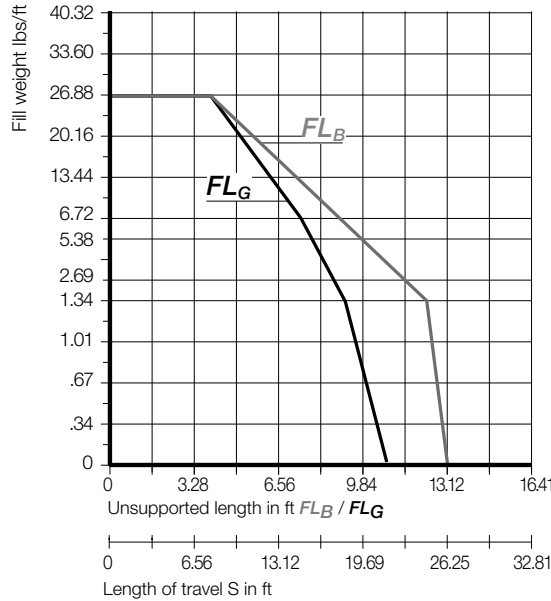
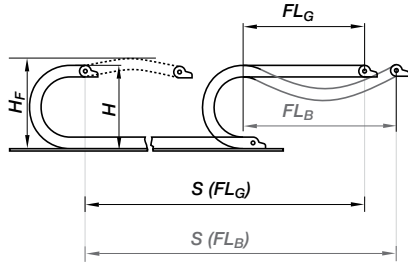

Pitch per link: = 3.58" (91 mm)
Links per ft (m): = 3.35 (11)
For center mount applications:
Chain length = $\frac{S}{2} + K$

The required clearance height: $H_F = H + 1.97$ in. (50 mm) (with 1.34 lbs/ft (2 kg/m) fill weight). Please consult igus® if space is particularly restricted.

R^{+25}	5.31 (135)	5.91 (150)	6.89 (175)	7.87 (200)	9.84 (250)	11.81 (300)	15.75 (400)	19.68 (500)
H	14.17 (360)	15.16 (385)	17.13 (435)	19.09 (485)	23.03 (585)	26.97 (685)	34.84 (885)	42.72 (1085)
D	10.63 (270)	11.22 (285)	12.20 (310)	13.19 (335)	15.16 (385)	17.13 (435)	21.06 (535)	25.00 (635)
K	25.59 (650)	29.53 (750)	32.48 (825)	35.43 (900)	41.34 (1050)	48.23 (1225)	57.09 (1450)	69.88 (1775)

For long travels with lowered mounting height

Long travel lengths from 32.8 ft.(10m) to max. 492 ft. (150m)

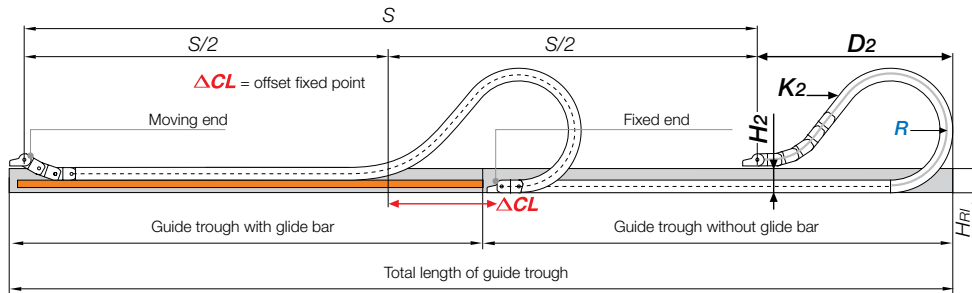

For center mount applications:

Chain length: = $\frac{S}{2} + K_2$

R	5.31 (135)	5.91 (150)	6.89 (175)	7.87 (200)	9.84 (250)	11.81 (300)	15.75 (400)	19.68 (500)
H ₂	10.47 (266)	10.47 (266)	10.47 (266)	10.47 (266)	10.47 (266)	10.47 (266)	10.47 (266)	10.47 (266)
D ₂ ⁺²⁵	15.35 (390)	17.72 (450)	20.87 (530)	27.95 (710)	36.22 (920)	44.09 (1120)	60.24 (1530)	72.05 (1830)
K ₂	28.66 (728)	32.24 (819)	39.41 (1001)	50.16 (1274)	64.49 (1638)	75.23 (1911)	100.31 (2548)	125.39 (3185)
ΔCL	4.88 (124)	6.26 (159)	8.22 (209)	14.13 (359)	20.04 (509)	25.94 (659)	37.76 (959)	45.63 (1159)

Speed / acceleration FL_G	max. 65.6 ft/s (20 m/s) / max. 656 ft/s ² (200 m/s ²)
Speed / acceleration FL_B	max. 9.84 ft/s (3 m/s) / max. 19.69 ft/s ² (6 m/s ²)
Gliding speed / acceleration (maximum)	max. 32.8 ft/s (10 m/s) / max. 164 ft/s ² (50 m/s ²)
Material - permitted temperature	igumid G / -40°F (-40°C) up to +248°F (+120°C)
Flammability Class, igumid G	VDE 0304 IIC UL94 HB



14040
14140
R18840

Short Travels - Unsupported



Unsupported e-chains® feature positive camber over short travels. This must be accounted for when specifying the clearance height. Please refer to **Installation dimensions** for further details.

Legend

- S = Length of travel
- R = Bending radius
- H = Nominal clearance height
- D = Overlength e-chain® radius in final position
- $K = \pi \cdot R + \text{safety buffer}$
- H_F = Required clearance height
- H_{R1} = Trough inner height
- H₂ = *Mounting height
- D₂ = Overlength - long travels, gliding
- K₂ = *Add-on
- *If the mounting bracket location is set lower



PDF: igus.com/e-chain-pdfs
Product information: igus.com/e-chains



Long Travels - Gliding



If the unsupported length is exceeded, the e-chain®/ Tube must glide on itself. This requires a guide trough.

Design, Chapter 1



For support of the lower run, see **Chapter 9** of the main catalog for the **Support Tray tool kit**

Technical Data



Details of material properties ► **Chapter 1**



Series 14040 - e-chain® with crossbars every link

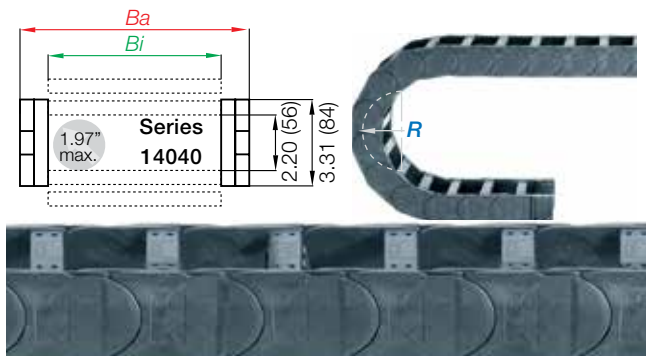

- Crossbars every link
- For use with rigid hydraulic hoses
- For particularly demanding applications
- Can be opened from both sides

Part Number Structure

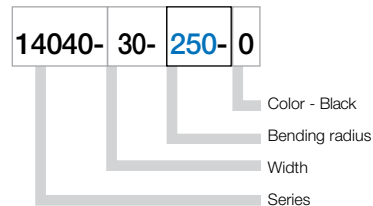

Series 14140 - e-chain® with crossbars every other link

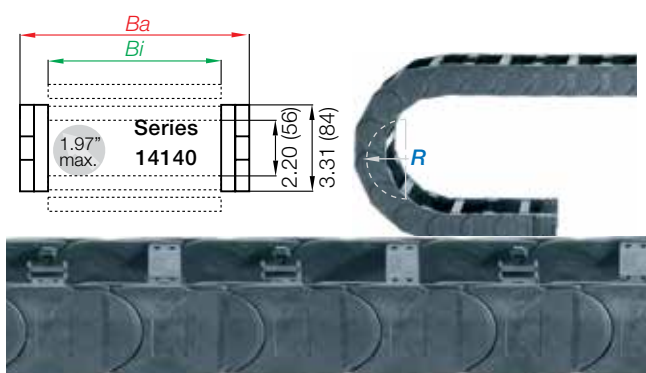

- Crossbars every other link - Standard configuration
- For nearly every situation
- Can be opened from both sides
- Easy assembly
- Stable
- Cost-effective

Part Number Structure

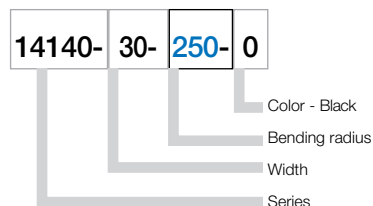

Series R18840 - fully enclosed e-tube

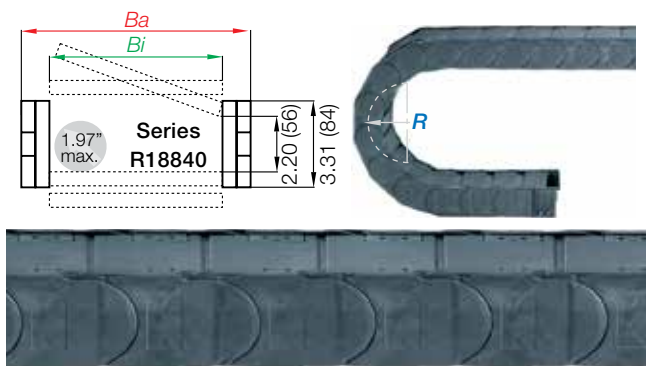

- Fully enclosed
- Excellent cable and hose protection against dirt
- Protection against hot chips
- Lids along inner radius are completely removable
- Lids along the outer radius are single-sided, snap open, hinged on one side as well as completely removable

Part Number Structure

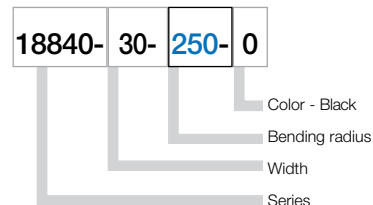

e-chain® as separate parts, links and side plates

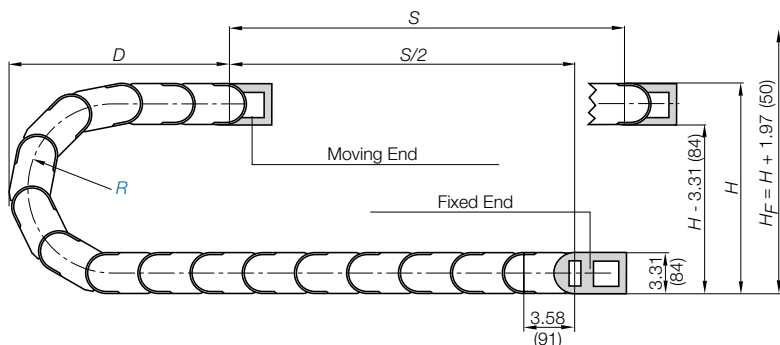
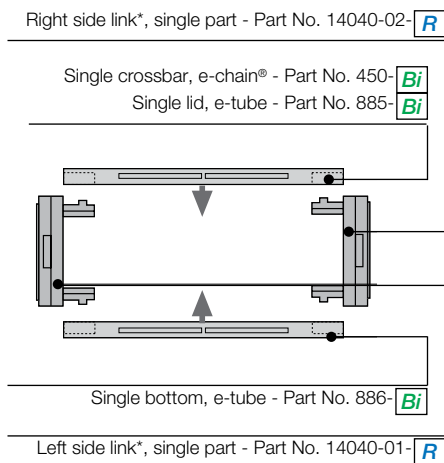

*View from the fixed point of the e-chain®/e-tube

e-chain system® E4 light

Series 14040/14140/R18840

Supplement part number with required radius. Example: 14040-30-300-0

Pitch: 3.58 in. (91mm) per link links/ft (m) = 3.35 (11)



14040
14140
R18840

PDF: igus.com/e-chain-pdfs
Product information: igus.com/e-chains

Part Number.			<i>Bi</i>	<i>Ba</i>	14040	14140	R18840
Crossbars Every link	Crossbars Every other	Tube Version	in. (mm)	in. (mm)	lbs/ft (kg/m)	lbs/ft (kg/m)	lbs/ft (kg/m)
14040-05-	14140-05-	<input type="checkbox"/> -0	1.97 (50)	2.99 (76)	≈ 1.79 (2.66)	≈ 1.67 (2.48)	-
14040-06-	14140-06-	<input type="checkbox"/> -0	2.56 (65)	3.58 (91)	≈ 1.66 (2.47)	≈ 1.69 (2.51)	-
14040-07-	14140-07-	18840-07- <input type="checkbox"/> -0*	2.95 (75)	3.98 (101)	≈ 1.85 (2.75)	≈ 1.51 (2.25)	≈ 2.15 (3.20)
14040-08-	14140-08-	<input type="checkbox"/> -0	3.43 (87)	4.45 (113)	≈ 1.91 (2.84)	≈ 1.61 (2.44)	-
14040-10-	14140-10-	18840-10- <input type="checkbox"/> -0	3.94 (100)	4.96 (126)	≈ 1.97 (2.93)	≈ 1.75 (2.61)	≈ 2.35 (3.49)
14040-11-	14140-11-	<input type="checkbox"/> -0	4.41 (112)	5.47 (139)	≈ 2.06 (3.06)	≈ 1.79 (2.67)	-
14040-12-	14140-12-	18840-12- <input type="checkbox"/> -0	4.92 (125)	5.94 (151)	≈ 2.10 (3.12)	≈ 1.82 (2.71)	≈ 2.59 (3.85)
14040-13-	14140-13-	<input type="checkbox"/> -0	5.39 (137)	6.46 (164)	≈ 2.19 (3.26)	≈ 1.86 (2.77)	-
14040-15-	14140-15-	18840-15- <input type="checkbox"/> -0	5.91 (150)	6.93 (176)	≈ 2.23 (3.32)	≈ 1.89 (2.81)	≈ 2.88 (4.28)
14040-16-	14140-16-	<input type="checkbox"/> -0	6.38 (162)	7.44 (189)	≈ 2.30 (3.43)	≈ 1.92 (2.86)	-
14040-17-	14140-17-	18840-17- <input type="checkbox"/> -0	6.89 (175)	7.91 (201)	≈ 2.38 (3.54)	≈ 1.96 (2.92)	≈ 3.05 (4.54)
14040-18-	14140-18-	<input type="checkbox"/> -0	7.36 (187)	8.43 (214)	≈ 2.45 (3.65)	≈ 2.00 (2.97)	-
14040-20-	14140-20-	18840-20- <input type="checkbox"/> -0	7.87 (200)	8.90 (226)	≈ 2.47 (3.67)	≈ 2.00 (2.98)	≈ 3.26 (4.85)
14040-21-	14140-21-	<input type="checkbox"/> -0	8.35 (212)	9.41 (239)	≈ 2.54 (3.78)	≈ 2.04 (3.04)	-
14040-22-	14140-22-	<input type="checkbox"/> -0	8.86 (225)	9.88 (251)	≈ 2.59 (3.85)	≈ 2.06 (3.07)	-
14040-23-	14140-23-	<input type="checkbox"/> -0	9.33 (237)	10.39 (264)	≈ 2.67 (3.98)	≈ 2.11 (3.14)	-
14040-25-	14140-25-	18840-25- <input type="checkbox"/> -0	9.84 (250)	10.87 (276)	≈ 2.73 (4.07)	≈ 2.14 (3.18)	≈ 3.75 (5.58)
14040-26-	14140-26-	<input type="checkbox"/> -0	10.31 (262)	11.38 (289)	≈ 2.80 (4.16)	≈ 2.16 (3.22)	-
14040-27-	14140-27-	18840-27- <input type="checkbox"/> -0	10.83 (275)	11.85 (301)	≈ 2.87 (4.27)	≈ 2.20 (3.28)	≈ 3.93 (5.85)
14040-28-	14140-28-	<input type="checkbox"/> -0	11.30 (287)	12.36 (314)	≈ 2.88 (4.29)	≈ 2.21 (3.29)	-
14040-30-	14140-30-	18840-30- <input type="checkbox"/> -0	11.81 (300)	12.83 (326)	≈ 3.03 (4.51)	≈ 2.28 (3.40)	≈ 4.19 (6.24)
14040-31-	14140-31-	<input type="checkbox"/> -0	12.28 (312)	13.35 (339)	≈ 3.07 (4.57)	≈ 2.30 (3.42)	-
14040-32-	14140-32-	<input type="checkbox"/> -0	12.79 (325)	13.82 (351)	≈ 3.09 (4.60)	≈ 2.31 (3.44)	-
14040-33-	14140-33-	<input type="checkbox"/> -0	13.27 (337)	14.33 (364)	≈ 3.21 (4.77)	≈ 2.37 (3.53)	-
14040-35-	14140-35-	18840-35- <input type="checkbox"/> -0	13.78 (350)	14.80 (376)	≈ 3.31 (4.93)	≈ 2.43 (3.61)	≈ 4.70 (6.99)
14040-36-	14140-36-	<input type="checkbox"/> -0	14.25 (362)	15.31 (389)	≈ 3.32 (4.94)	≈ 2.43 (3.61)	-
14040-37-	14140-37-	<input type="checkbox"/> -0	14.76 (375)	15.79 (401)	≈ 3.33 (4.95)	≈ 2.43 (3.62)	-
14040-38-	14140-38-	<input type="checkbox"/> -0	15.24 (387)	16.30 (414)	≈ 3.39 (5.04)	≈ 2.46 (3.66)	-
14040-40-	14140-40-	18840-40- <input type="checkbox"/> -0	15.75 (400)	16.77 (426)	≈ 3.52 (5.24)	≈ 2.53 (3.76)	≈ 5.34 (7.94)
14040-41-	14140-41-	<input type="checkbox"/> -0	16.22 (412)	17.28 (439)	≈ 3.62 (5.39)	≈ 2.58 (3.84)	-
14040-42-	14140-42-	<input type="checkbox"/> -0	16.73 (425)	17.76 (451)	≈ 3.72 (5.54)	≈ 2.63 (3.92)	-
14040-43-	14140-43-	<input type="checkbox"/> -0	17.20 (437)	18.27 (464)	≈ 3.77 (5.61)	≈ 2.65 (3.95)	-
14040-45-	14140-45-	<input type="checkbox"/> -0	17.72 (450)	18.74 (476)	≈ 3.82 (5.68)	≈ 2.67 (3.98)	-
14040-46-	14140-46-	18840-46- <input type="checkbox"/> -0	18.19 (462)	19.25 (489)	≈ 3.83 (5.70)	≈ 2.68 (3.99)	≈ 5.64 (8.40)
14040-47-	14140-47-	<input type="checkbox"/> -0	18.70 (475)	19.72 (501)	≈ 3.92 (5.83)	≈ 2.73 (4.06)	-
14040-48-	14140-48-	<input type="checkbox"/> -0	19.17 (487)	20.24 (514)	≈ 3.94 (5.86)	≈ 2.74 (4.08)	-
14040-50-	14140-50-	<input type="checkbox"/> -0	19.69 (500)	20.71 (526)	≈ 4.00 (5.96)	≈ 2.78 (4.13)	-
14040-51-	14140-51-	<input type="checkbox"/> -0	20.16 (512)	21.22 (539)	≈ 4.02 (5.98)	≈ 2.78 (4.14)	-
14040-52-	14140-52-	<input type="checkbox"/> -0	20.67 (525)	21.69 (551)	≈ 4.05 (6.03)	≈ 2.80 (4.16)	-
14040-53-	14140-53-	<input type="checkbox"/> -0	21.14 (537)	22.20 (564)	≈ 4.15 (6.18)	≈ 2.85 (4.24)	-
14040-55-	14140-55-	<input type="checkbox"/> -0	21.65 (550)	22.68 (576)	≈ 4.48 (6.67)	≈ 3.01 (4.48)	-
14040-60-	14140-60-	<input type="checkbox"/> -0	23.62 (600)	24.65 (626)	≈ 4.69 (6.98)	≈ 3.08 (4.58)	-

Choose from the radii below for all of the above sizes

Radius (mm) Example: 14040-30-300-0

	135**	150	175	200	250	300	400	500
<i>R</i>	5.31 (135)	5.91 (150)	6.89 (175)	7.87 (200)	9.84 (250)	11.81 (300)	15.75 (400)	19.68 (500)
<i>H</i> ₂₅	14.17 (360)	15.16 (385)	17.13 (435)	19.09 (485)	23.03 (585)	26.97 (685)	34.84 (885)	42.72 (1085)
<i>D</i>	10.63 (270)	11.22 (285)	12.20 (310)	13.19 (335)	15.16 (385)	17.13 (435)	21.06 (535)	25.00 (635)
<i>K</i>	25.59 (650)	29.53 (750)	32.48 (825)	35.43 (900)	41.34 (1050)	48.23 (1225)	57.09 (1450)	69.88 (1775)

** This radius is not available for the R18840 Series

*Removable lid only, no hinged option

0=Standard color black. For other colors see Chapter 1

For wider chains see page 6.200 For large diameter hoses see page 6.200



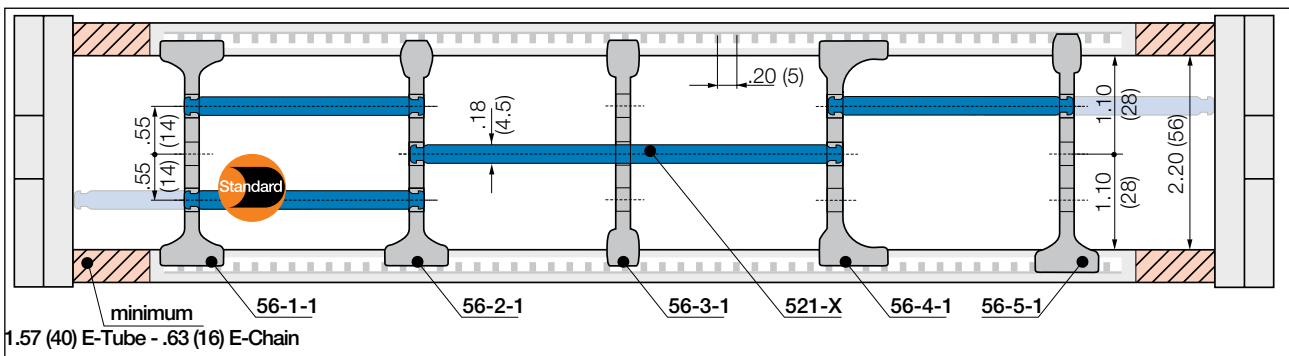

Note Please maintain a lateral spacing of 1.57" (40 mm) for e-tube and .63" (16 mm) for e-chains® between the separators and the side links. In the standard configuration separators are assembled every 2nd e-chain® link

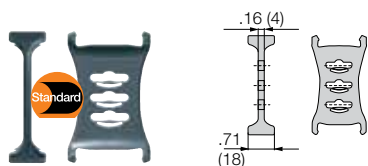

Separator, wide base

Unassembled	Part No. 56-1
Assembled	Part No. 56-1-1

- **Standard separator 56-1 for all applications**
Separator with wide base for maximum locking strength and safe standing in e-chains®.

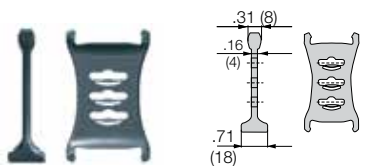

Separator, narrow head

Unassembled	Part No. 56-2
Assembled	Part No. 56-2-1

- **Separator 56-2 For even faster installation**
is used when vertical and horizontal separation is required. Due to its slot, it allows basic vertical/horizontal shelving arrangements.

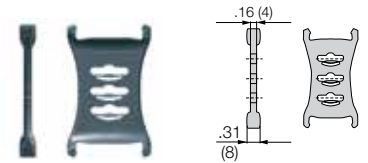

Separator, narrow base

Unassembled	Part No. 56-3
Assembled	Part No. 56-3-1

- **Separator 56-3 For many thin cables**
is used when vertical and horizontal separation is required. Due to its slot, it allows basic vertical/horizontal shelving arrangements.

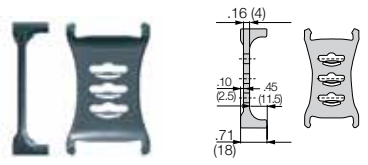

Separator, asymmetrical

Unassembled	Part No. 56-4
Assembled	Part No. 56-4-1

- **Separator 56-4 For side mounted applications**
is used when vertical and horizontal separation is required. Due to its slot, it allows basic vertical/horizontal shelving arrangements.

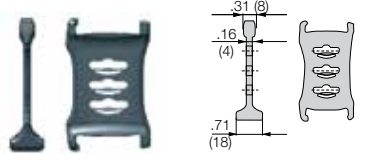

Separator, asymmetrical

Unassembled	Part No. 56-5
Assembled	Part No. 56-5-1

- **Separator 56-5 Locks safely in .30" (7.5 mm) increments**
Notch separator for exact positioning in e-chains®, Recommended for side-mounted applications.

Lockable full-width shelves - for the standard interior separation

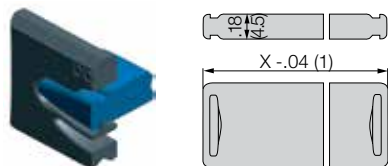

Full width shelf, lockable

Unassembled	Part No. 520-X
Assembled	Part No. 521-X

- **Full width shelf, lockable**
Shelf locks safely into separators on both ends, fixed width possible. Separators can be moved freely over the shelf in horizontal direction. Can be arranged at 3 different heights.

Width X in. (mm)	Part No. Unassembled	Part No. Assembled	Width X in. (mm)	Part No. Unassembled	Part No. Assembled	Width X in. (mm)	Part No. Unassembled	Part No. Assembled
1.97 (050)	520-50	521-50	5.91 (150)	520-150	521-150	11.81 (300)	520-300	521-300
2.56 (065)	520-65	521-65	6.89 (175)	520-175	521-175	13.78 (350)	520-350	521-350
2.95 (075)	520-75	521-75	7.87 (200)	520-200	521-200	14.76 (375)	520-375	521-375
3.94 (100)	520-100	521-100	8.86 (225)	520-225	521-225	15.24 (387)	520-387	521-387
4.92 (125)	520-125	521-125	9.84 (250)	520-250	521-250	17.72 (450)	520-450	521-450

e-chain system® E4 light
 Series 14040/14140/R18840
 Interior Separation - Previous Generation



14040
 14140
 R18840



Option 1: Vertical separators and spacers

Vertical separators are used if a vertical subdivision of the e-chain® interior is required. By standard, vertical separators are assembled every other e-chain® link.

NOTE: Observe a lateral spacing of at least 1.30 in. (33mm) for e-tubes and .63 in. (16mm) for e-chain®. There is no minimum spacing needed for side plates

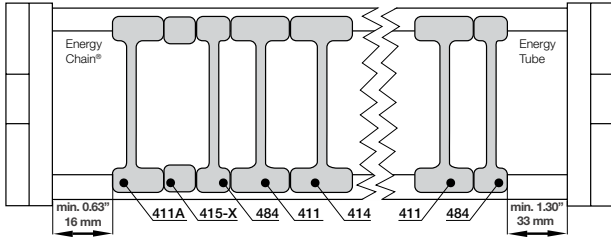

STANDARD
 Vertical separator
 401



Vertical separator

Unassembled **Part No. 401**
 Assembled **Part No. 411**

• **Standard separator 401 for e-chains® and e-tubes**

This separator offers safe stability due to its wide base design, also when used with thick cables or hoses.



Vertical separator
 483

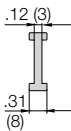

Vertical separator

Unassembled **Part No. 483**
 Assembled **Part No. 484**

• **Vertical separator 483 for e-chains® and e-tubes**

This separator offers a narrow base for applications where a large number of small cables need to be individually separated.



Locking separator
 404

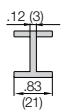

Locking separator (chain only)

Unassembled **Part No. 404**
 Assembled **Part No. 414**

• **Locking separator 404 for e-chains®**

This separator features increased retention force for applications exposed to very high humidity and extreme loads. The extra retention force is achieved by asymmetric claws for the crossbar. Take care to ensure proper alignment.



Locking separator
 406

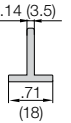

Locking separator (tube only)

Unassembled **Part No. 406**
 Assembled **Part No. 416**

• **Locking separator 406 for e-tubes**

It features a single sided, secure fit, and can be placed on the lid or the bottom of the e-tube. The single side locking design helps to eliminate difficulties in assembling the opposite cover or crossbar



Asymmetric separator
 401A

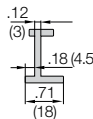

Asymmetrical separator (chain only)

Unassembled **Part No. 401A**
 Assembled **Part No. 411A**

• **Asymmetrical separator 401A for e-chains®**

This separator features an (18mm) base. It can be used in combinations between spacers of different widths and vertical separators in side mounted applications.



Spacers
 405-XX



Spacer (chain only)

Unassembled **Part No. 405-XX**
 Assembled **Part No. 415-XX**
 XX = width of the spacer

• **NOTE ON SPACERS**

Vertical separators are adjustable, but can be fixed in position by means of a spacer. Spacers are most often necessary for side mounted applications.

The available inner height is reduced by .08" (2mm) **per spacer** (for example if one spacer is placed on either side of the separator, the overall inner height is reduced by .16" (4mm). To avoid this, place the spacers on the **outside** of the opening crossbar (**not for long travels**).

Spacers available in the following sizes:

Part No. Unassembled	Part No. Assembled	in.	(mm)
405 -10	415 -10	.39"	(10)
405 -15	415 -15	.59"	(15)
405 -20	415 -20	.79"	(20)
405 -30	415 -30	1.18"	(30)
405 -40	415 -40	1.57"	(40)

PDF: igus.com/e-chain-pdfs
 Product information: igus.com/e-chains



14040
14140
R18840



e-chain system® E4 light Series 14040/14140/R18840 Interior Separation - Previous Generation

igus®
e-chain system®

Telephone 1-800-521-2747

Internet: igus.com
email: sales@igus.com
QuickSpec: igus.com/quickspec



Shelves and separators
e-chains® and e-tubes can be subdivided both vertically and horizontally using the various interior separation elements.

► **Design, Chapter 1** for layout recommendations.

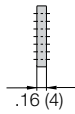
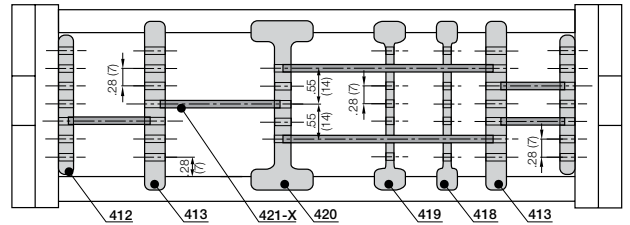

Side plate

Unassembled	Part No. 402
Assembled	Part No. 412

● **Side plates 402**

This component is used to form the basic pattern of a shelf system.

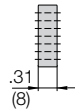

Vertical separator

Unassembled	Part No. 403
Assembled	Part No. 413

● **Vertical separator 403**

This component is used to form the basic pattern of a shelf system.

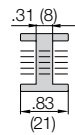

Locking vertical separator

Unassembled	Part No. 410
Assembled	Part No. 420

● **Locking vertical separator 410**

This separator is slotted and able to be combined with shelves. For e-chains® only

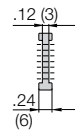
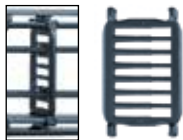

Slotted separators, closed

Unassembled	Part No. 408
Assembled	Part No. 418

● **Slotted separators 408**

These are used for very complex subdivisions. However, they cannot be retrofitted into an existing separation system without removing the shelves first.

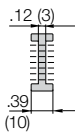

Slotted separators, open

Unassembled	Part No. 409
Assembled	Part No. 419

● **Slotted separator 409**

This separator can be retrofitted into an existing interior separation system without removing the shelves, as long as these shelves fit into any of the 3 middle slots

Shelves 420-XX

These components form the basic pattern of a shelf system. Shelves of various widths can be arranged at 7 different heights in .28" (7mm) increments

Width X in. (mm)	Usable Width in. (mm)	Part No. Unassembled	Part No. Assembled	Width X in. (mm)	Usable Width in. (mm)	Part No. Unassembled	Part No. Assembled
.71 (18)	.39 (10)	420-18	421-18	2.95 (75)	2.64 (67)	420-75	421-75
.91 (23)	.59 (15)	420-23	421-23	3.46 (88)	3.15 (80)	420-88	421-88
.98 (25)	.67 (17)	420-25	421-25	3.94 (100)	3.62 (92)	420-100	421-100
1.10 (28)	.79 (20)	420-28	421-28	4.92 (125)	4.61(117)	420-125	421-125
1.30 (33)	.98 (25)	420-33	421-33	5.91 (150)	5.59(142)	420-150	421-150
1.69 (43)	1.38 (35)	420-43	421-43	6.89 (175)	6.57(167)	420-175	421-175
1.97 (50)	1.65 (42)	420-50	421-50	7.36 (187)	7.05(179)	420-187	421-187
2.44 (62)	2.13 (54)	420-62	421-62	7.87 (200)	7.56(192)	420-200	421-200

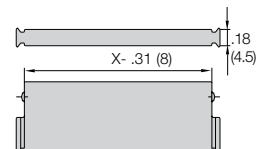



Part number example for e-chain®

14040-10/20/10-200-0
14040-*Bi1/Bi2/Bi3*-R-0

We strongly recommend on-site consultation with an igus® technician for individual advice regarding mounting brackets, guide troughs and other design details.

Extension links - for extremely wide e-chains® up to 9.84 ft (3m)

- For applications in which particularly high fill weights necessitate extremely wide e-chains®
- The extension link design allows virtually limitless side-by-side attachment of chains
- The unsupported length of a chain can be increased when additional loads are required
- Extension links can be used with e-chains®, e-tubes or a combination of both
- They are suitable for unsupported and gliding applications in a guide trough
- e-chains® with extension links are attached with KMA or steel mounting brackets.

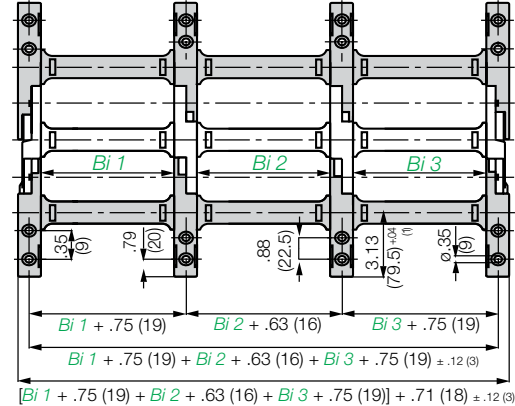

Consult igus® for your extender crossbar applications. We will be happy to assist you with your design layout.

Extender crossbars - For careful guiding of large diameter cables and hoses

- Intended for cables and hoses with a maximum outer diameter of 9.64 in. (245 mm).
- Can be attached along either the inner or outer radius, inner radius preferred
- Gliding operation with crossbars assembled along the outer radius in conjunction with a special guide trough
- Gliding operation not guaranteed with crossbars assembled along the inner radius
- The extender crossbar can either be attached to the side links directly or can be used in combination with two standard snap-open crossbars.

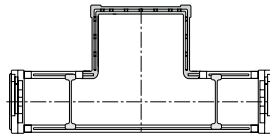

Square extender crossbar combined with standard snap-open crossbars.

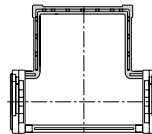

Attached directly to the side link.

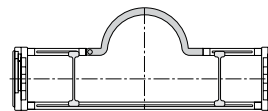

Round extender crossbar combined with standard snap-open crossbars.

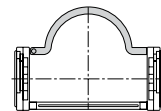

Attached directly to the side link.

Part No.	Max Ø Hose	Style	Installation Side Link	Combined with Snap-Open Crossbars
450-15-RHD115	4.52 (115)	Round	No	Yes
450-17-RD115	4.52 (115)	Round	Yes	No
450-25-D150	5.91 (150)	Square	Yes	No
450-30-D200	7.09 (180)	Square	Yes	No
450-35-D250	7.68 (195)	Square	Yes	No
450-40-D300	9.65 (245)	Square	Yes	No
450-20-HD150	5.91 (150)	Square	No	Yes
450-25-HD200	7.09 (180)	Square	No	Yes
450-30-HD250	7.68 (195)	Square	No	Yes



E4 clip on cable binder

- For side mounted applications
- Serves as a clip-on, lateral guide for hoses and cables on e-chains®
- The loops can be adjusted as needed

- Compatible with many E4 e-chains®
- Economical
- One clip and one locking band are needed for each chain link



Part No.	Form
450-B12	Locking clip, comprised of a locking element
450-B12-200	Locking band, comprised of a locking element and band; 12 x 1.5 x 200 mm



14040
14140
R18840



e-chain system® E4 light Series 14040/14140/R18840 Mounting Brackets

igus®
e-chain system®

Telephone 1-800-521-2747

Internet: igus.com
email: sales@igus.com
QuickSpec: igus.com/quickspec

6.201



Option 1: KMA pivoting

- Profile rail option
- Universal use
- Corrosion resistant
- Short and long travels
- Space-restricted conditions

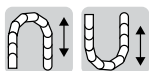

Option 2: KMA locking

- Profile rail option
- Universal use
- Corrosion resistant
- Extreme accelerations
- Vertical hanging/standing travels

Part Number Structure

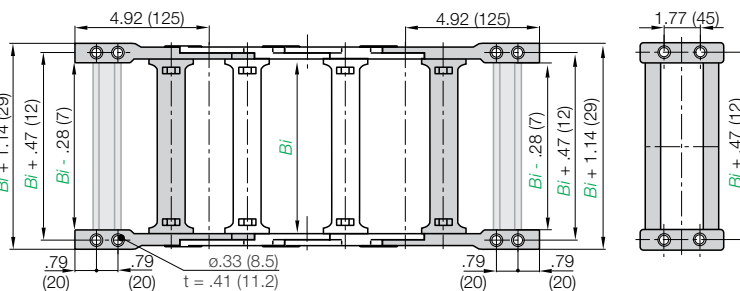
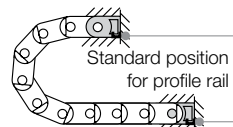
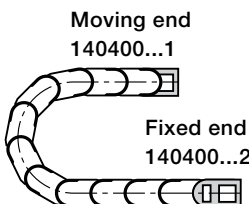
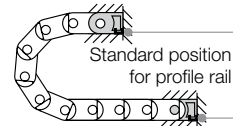
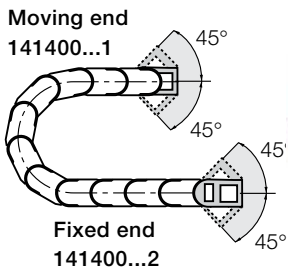
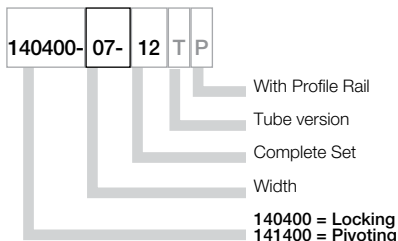

Full set, for both ends:

140400-05-12 Full set, each part with pin/bore

Single-part order:

140400-05-1 Mounting bracket with bore

140400-05-2 Mounting bracket with pin

Part number examples are shown for pivoting brackets. For locking brackets change part number to 140400

Part No. Full Set (pivoting)

Series 14040 or 14140:

141400-Width-12

Part No. Full Set (pivoting)

with profile rail

Series 14040 or 14140

141400-Width-12P

Part No. Full Set (pivoting)

Tube Series R18840

141400-Width-12T

Part No. Full Set (pivoting)

with Profile Rail

Tube Series R18840

141400-Width-12TP

Width	Part No. Full Set		Tube Option	With Profile Rail	Bi in. (mm)	Width	Part No. Full Set		Tube Option	With Profile Rail	Bi in. (mm)
	Locking	Pivoting					Locking	Pivoting			
-05	140400	141400	-05-12	P	1.97 (50)	-31	140400	141400	-31-12	P	12.28 (312)
-06	140400	141400	-06-12	P	2.56 (65)	-32	140400	141400	-32-12	P	12.79 (325)
-07	140400	141400	-07-12	T	2.95 (75)	-33	140400	141400	-33-12	P	13.27 (337)
-08	140400	141400	-08-12	P	3.43 (87)	-35	140400	141400	-35-12	T	13.78 (350)
-10	140400	141400	-10-12	T	3.94 (100)	-36	140400	141400	-36-12	P	14.25 (362)
-11	140400	141400	-11-12	P	4.41 (112)	-37	140400	141400	-37-12	P	14.76 (375)
-12	140400	141400	-12-12	T	4.92 (125)	-38	140400	141400	-38-12	P	15.24 (387)
-13	140400	141400	-13-12	P	5.39 (137)	-40*	140400	141400	-40-12	T	15.75 (400)
-15	140400	141400	-15-12	T	5.91 (150)	-41	140400	141400	-41-12	P	16.22 (412)
-16	140400	141400	-16-12	P	6.38 (162)	-42	140400	141400	-42-12	P	16.73 (425)
-17	140400	141400	-17-12	T	6.89 (175)	-43	140400	141400	-43-12	P	17.20 (437)
-18	140400	141400	-18-12	P	7.36 (187)	-45	140400	141400	-45-12	P	17.72 (450)
-20	140400	141400	-20-12	T	7.87 (200)	-46	140400	141400	-46-12	T	18.19 (462)
-21	140400	141400	-21-12	P	8.35 (212)	-47	140400	141400	-47-12	P	18.70 (475)
-22	140400	141400	-22-12	P	8.86 (225)	-48	140400	141400	-48-12	P	19.17 (487)
-23	140400	141400	-23-12	P	9.33 (237)	-50	140400	141400	-50-12	P	19.69 (500)
-25	140400	141400	-25-12	T	9.84 (250)	-51	140400	141400	-51-12	P	20.16 (512)
-26	140400	141400	-26-12	P	10.31 (262)	-52	140400	141400	-52-12	P	20.67 (525)
-27	140400	141400	-27-12	T	10.83 (275)	-53	140400	141400	-53-12	P	21.14 (537)
-28	140400	141400	-28-12	P	11.30 (287)	-55	140400	141400	-55-12	P	21.65 (550)
-30	140400	141400	-30-12	T	11.81 (300)	-60	140400	141400	-60-12	P	23.62 (600)

e-chain system® E4 light

Series 14040/14140/R18840

Strain Relief



14040
14140
R18840

Chainfix clamps for the profile rail



igus® Chainfix strain relief elements are available in either steel or stainless steel. They can be adjusted with a hexagon socket and are available in single, double and triple configurations.

Part No. Single Clamp		Part No. Double Clamp		Part No. Triple Clamp		Cable ø	
Steel	Stainless	Steel	Stainless	Steel	Stainless	in.	(mm)
CFX12-1	CFX12-1E	CFX12-2	CFX12-2E	CFX12-3	-	.24 - .47	(6 - 12)
CFX14-1	CFX14-1E	CFX14-2	CFX14-2E	CFX14-3	-	.47 - .55	(12 - 14)
CFX16-1	CFX16-1E	CFX16-2	CFX16-2E	CFX16-3	-	.55 - .63	(14 - 16)
CFX18-1	CFX18-1E	CFX18-2	CFX18-2E	CFX18-3	-	.63 - .71	(16 - 18)
CFX20-1	CFX20-1E	CFX20-2	CFX20-2E	CFX20-3	-	.71 - .79	(18 - 20)
CFX22-1	CFX22-1E	CFX22-2	CFX22-2E	CFX22-3	-	.79 - .87	(20 - 22)
CFX26-1	CFX26-1E	CFX26-2	CFX26-2E	-	-	.87 - 1.02	(22 - 26)
CFX30-1	CFX30-1E	CFX30-2	CFX30-2E	-	-	1.02 - 1.18	(26 - 30)
CFX34-1	CFX34-1E	CFX34-2	CFX34-2E	-	-	1.18 - 1.34	(30 - 34)
CFX38-1	CFX38-1E	-	-	-	-	1.34 - 1.50	(34 - 38)
CFX42-1	CFX42-1E	-	-	-	-	1.50 - 1.65	(38 - 42)

For more information please refer to strain relief section of Chapter 10

Tiewrap Plates

Option 1:

Tiewrap plates as an individual part

Available as an individual component, can be fixed onto a mounting bracket with the use of a profile rail.

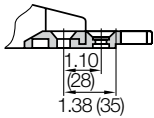

Shown assembled

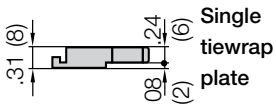

Single tiewrap plate

Tiewrap Plate	n Number of Teeth	C Overall Width in. (mm)	B Bore Width in. (mm)	Center Bore
3050-ZB	5	1.97 (50)	1.18 (30)	no
3075-ZB	7	2.95 (75)	2.16 (55)	no
3100-ZB	10	3.94 (100)	3.15 (80)	no
3115-ZB	11	4.53 (115)	3.74 (95)	no
3125-ZB	12	4.92 (125)	4.13 (105)	no
3150-ZB	15	5.91 (150)	5.12 (130)	no
3175-ZB	17	6.89 (175)	6.10 (155)	no
3200-ZB	20	7.87 (200)	7.09 (180)	yes
3225-ZB	22	8.86 (225)	8.07 (205)	yes
3250-ZB	25	9.84 (250)	9.06 (230)	yes

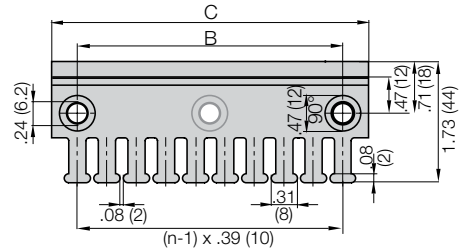

If used with KMA brackets with profile rail please add "KMA" to the end of the part number.

Example: 3050-ZBKMA

For more information please refer to strain relief section of Chapter 10

Option 2:

Clip-on Tiewrap plates

Available as a clip-on tiewrap plate without the use of bolts They are inserted and removed with a screwdriver used as a lever. Clip-on tiewrap plates are also available as an attachment to the opening crossbars.



Part No.	Number of Teeth	Width of Strain Relief in. (mm)
3050-ZC	5	1.97 (50)
3075-ZC	7	2.95 (75)

For more information please refer to strain relief section of Chapter 10

Option 3:

Clip-on Tiewrap plates for opening crossbars

Clip-on tiewrap plates are also available as an attachment to opening crossbars. They can be positioned at any point along the e-chain®.



Part No.	Number of Teeth	Width of Strain Relief in. (mm)
4550-ZS	5	1.89 (48)
4575-ZS	7	2.91 (74)

For more information please refer to strain relief section of Chapter 10

PDF: igus.com/e-chain-pdfs
Product information: igus.com/e-chains



Width of Crossbar
14040-05-200-0

	B_{Ri}		Installation Part No.
-05	3.19 (81)	*	
-06	3.78 (96)	*	
-07	4.17 (106)		94-50-225
-10	5.16 (131)		94-50-250
-11	5.63 (143)		94-50-275
-12	6.14 (156)		94-50-275
-13	6.61 (168)		94-50-300
-15	7.13 (181)		94-50-300
-16	7.60 (193)		94-50-325
-17	8.11 (206)		94-50-325
-18	8.58 (218)		94-50-350
-20	9.09 (231)		94-50-350
-21	9.57 (243)		94-50-375
-22	10.08 (256)		94-50-375
-23	10.55 (268)		94-50-400
-25	11.06 (281)		94-50-400
-26	11.54 (293)		94-50-425
-27	12.05 (306)		94-50-425
-28	12.52 (318)		94-50-450
-30	13.03 (331)		94-50-450
-31	13.50 (343)		94-50-475
-32	14.02 (356)		94-50-475
-33	14.49 (368)		94-50-500
-35	15.00 (381)		94-50-500
-36	15.47 (393)		94-50-525
-37	15.98 (406)		94-50-525
-38	16.46 (418)		94-50-550
-40	16.97 (431)		94-50-550
-41	17.44 (443)		94-50-575
-42	17.95 (456)		94-50-575
-43	18.43 (468)		94-50-600
-45	18.94 (481)		94-50-600
-46	19.41 (493)		94-50-625
-47	19.92 (506)		94-50-625
-48	20.59 (518)		94-50-650
-50	20.91 (531)		94-50-650
-51	21.38 (543)		94-50-675
-52	21.89 (556)		94-50-675
-53	22.36 (568)		94-50-700
-55	22.87 (581)		94-50-700
-60	24.84 (631)		94-50-750

Guide troughs are used with applications where the upper run of the e-chain® glides on the lower run. If using igus® steel guide troughs, the following components are required:

- Full travel length of guide trough
Part No. 94-30
- 1/2 travel length glide bars
Part No. 93-01
- Installation sets as end connectors
Part No. 94-50-XX

.XX indicates the length of the profile rails on which the guide trough is mounted. The values and part numbers are specified in the table on the left. The standard length of the trough components and glide bars is 6.56 ft (2 m). The required overall length of the guide trough directly correlates to the length of travel.

Example:

Length of travel 164 ft (50 m)
Center mounted

- Required guide troughs**
164 ft (50 m) guide trough
82 ft (25 m) glide bars
= 25 sections of 6.56 ft (2 m) guide trough
Part No. 94-30
= 13 sections of 6.56 ft (2 m) glide bars
Part No. 93-01

Required number of installation sets:

= Number of guide trough components + 1
= 25 + 1 = 26

Part number of the installation sets

94-50-XXX

Example:

94-50-400 for 15.75 (400 mm) long profile rail



Installation sets as section connectors



Left: Guide trough with glide bars
Right: Guide troughs without glide bars

* Specialized guide trough available upon request

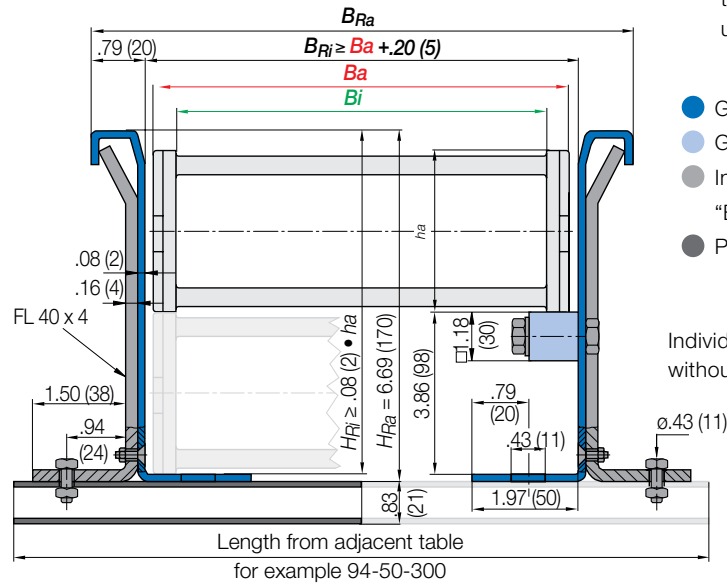

- Guide trough
- Glide bars
- Installation set "Basic"
- Profile rail

Individual attachment without profile rail

Standard length profile rail

e-chain system® E4 light
Series 14040/14140/R18840



14040
14140
R18840

PDF: igus.com/e-chain-pdfs
Product information: igus.com/e-chains



14240
14340



e-chain system® E4 light Series 14240/14340



Price Index

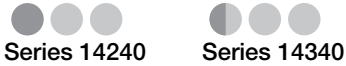

Special Features / Options

ESD classification:
Electrically conductive ESD/
ATEX version upon request

High torsional rigidity

Side-mounted - unsupported

Assembly Tips



Opening e-chains®: Remove crossbars and clips - Insert screwdriver into the slot, push down, release by lever action

Other Installation Methods

- Vertical, hanging ≤ 262 ft (80 m)
- Vertical, standing ≤ 19.69 ft (6 m)
- Side-mounted, un supp. ≤ 6.56 ft (2 m)
- Rotary requires further calculation

Usage Guidelines

- If a simpler low-cost solution is required
- If optimized interior space is required
- If the Series 400 is too large
- If a quieter version is required
 - Series E6-62
- If side-mounted chain/tube with a long unsupported travel is required
 - Series E4-56/H4-56/R4-56
- If increased unsupported lengths and longer travels are required
 - Series E4-56/H4-56/R4-56
- If high fill weights and/or stiff cables and hoses are used
 - Series 14040
- If chip protection is necessary
 - Series 18840

Features & Benefits

- 1 KMA mounting brackets with attachment points on all sides
- 2 Locking or pivoting mounting brackets available
- 3 Optimum ratio of inner height to outer width
- 4 Lateral glide surfaces for side-mounted operation
- 5 Numerous interior separation possibilities
- 6 Integrated strain relief possible
- 7 Wide, rounded plastic crossbars - cable friendly
- 8 Tongue and groove design provides greater lateral stability
- 9 Crossbars on e-chains® are removable along both radii
- 10 e-chain® also available with reverse bending radii

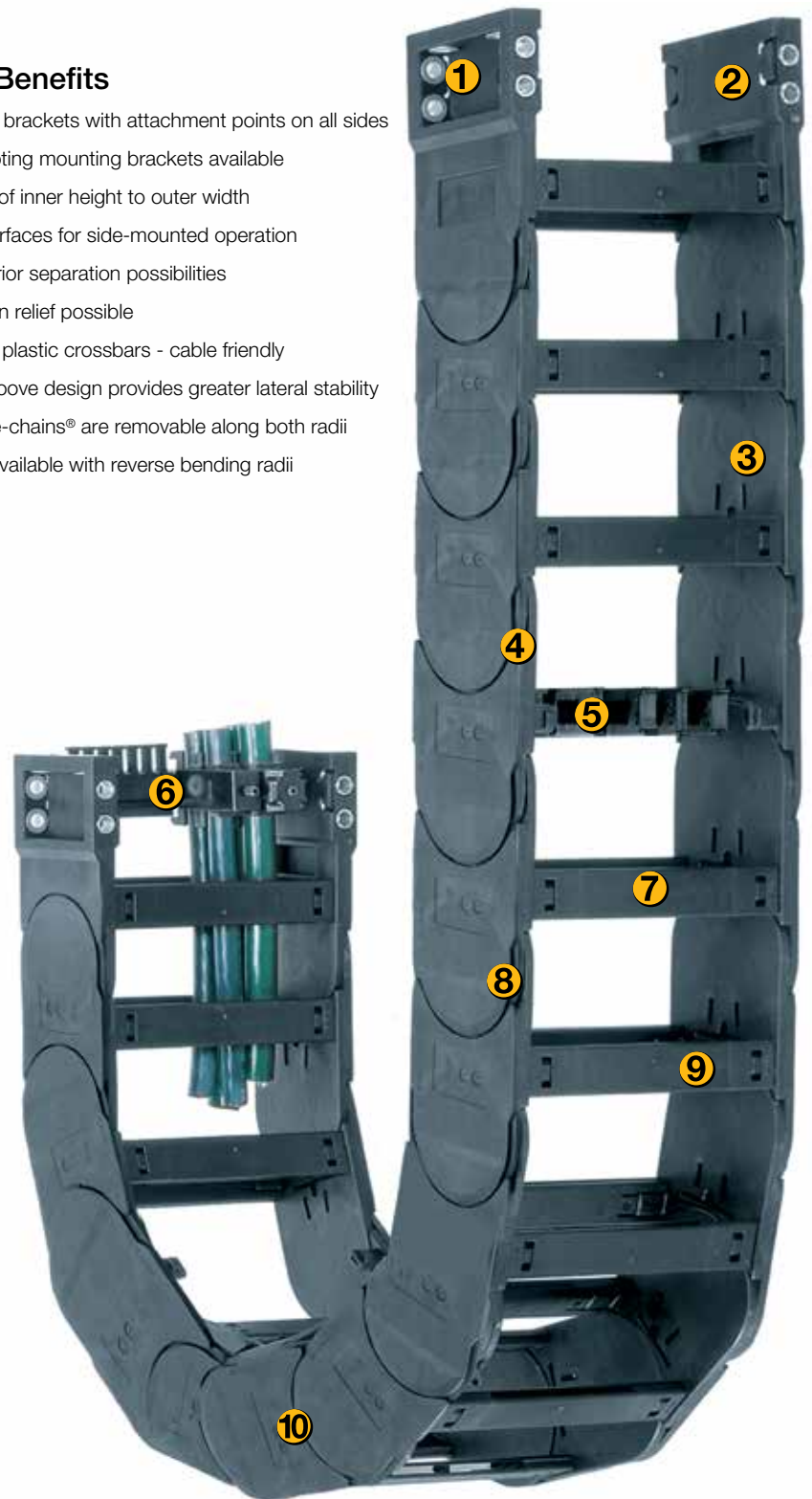

Order Example: Complete e-chain®

Please indicate chain length or number of links. Example:

19.69 ft (6 m) **14240-30-300-0**

e-chain®

With 2 separators **62.1.1** assembled every 2nd link

Interior Separation

1 Set **142400-30-12P**

Mounting Bracket

e-chain system® E4 light

Series 14240/14340

Installation Dimensions

Short travel, unsupported length

- FL_B = unsupported with permitted sag
 - FL_G = unsupported with straight upper run
- Further information ► Design, Chapter 1

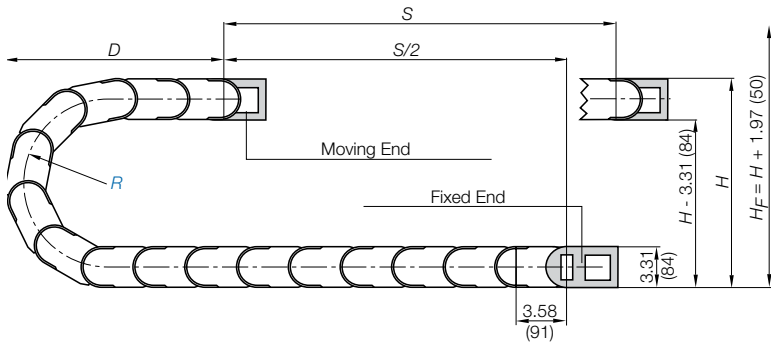
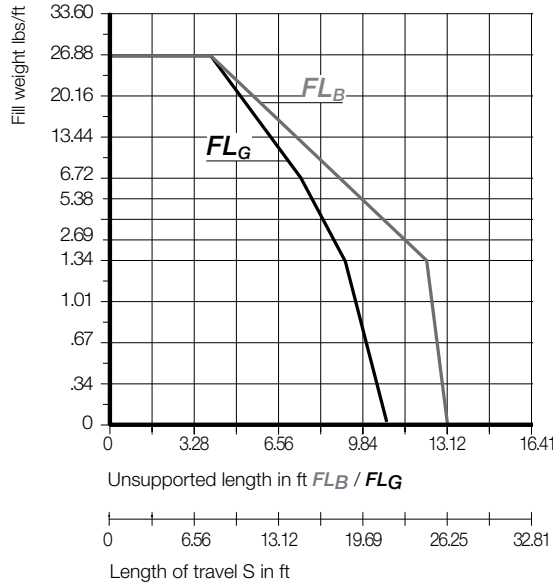
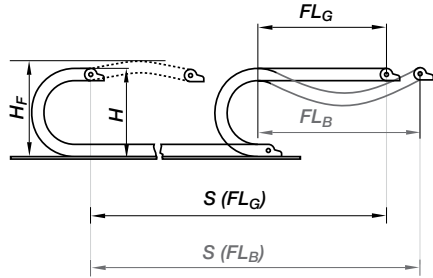

Pitch per link = 3.58" (91 mm)
 Links per ft (m) = 3.35 (11)
 For center mount applications:
 Chain length = $\frac{S}{2} + K$

The required clearance height: $H_F = H + 1.97$ in. (50 mm) (with 1.34 lbs/ft (2 kg/m) fill weight. Please consult igus® if space is particularly restricted.

R	5.31 (135)	5.91 (150)	6.89 (175)	7.87 (200)	9.84 (250)	11.81 (300)	15.75 (400)	19.68 (500)
H_{25}	14.17 (360)	15.16 (385)	17.13 (435)	19.09 (485)	23.03 (585)	26.97 (685)	34.84 (885)	42.72 (1085)
D	10.63 (270)	11.22 (285)	12.20 (310)	13.19 (335)	15.16 (385)	17.13 (435)	21.06 (535)	25.00 (635)
K	25.59 (650)	29.53 (750)	32.48 (825)	35.43 (900)	41.34 (1050)	48.23 (1225)	57.09 (1450)	69.88 (1775)

For long travels with lowered mounting height

Long travel lengths from 32.8 ft.(10m) to max. 492 ft. (150m)

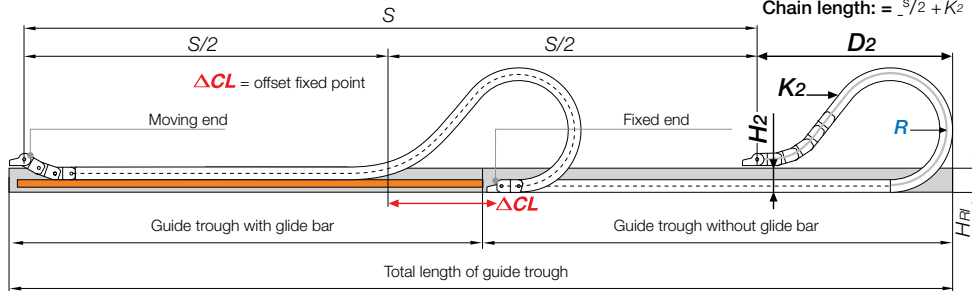

For center mount applications:
 Chain length = $\frac{S}{2} + K_2$

R	5.31 (135)	5.91 (150)	6.89 (175)	7.87 (200)	9.84 (250)	11.81 (300)	15.75 (400)	19.68 (500)
H_2	10.47 (266)	10.47 (266)	10.47 (266)	10.47 (266)	10.47 (266)	10.47 (266)	10.47 (266)	10.47 (266)
D_{25}	15.35 (390)	17.72 (450)	20.87 (530)	27.95 (710)	36.22 (920)	44.09 (1120)	60.24 (1530)	72.05 (1830)
K_2	28.66 (728)	32.24 (819)	39.41 (1001)	50.16 (1274)	64.49 (1638)	75.23 (1911)	100.31 (2548)	125.39 (3185)
ΔCL	4.88 (124)	6.26 (159)	8.22 (209)	14.13 (359)	20.04 (509)	25.94 (659)	37.76 (959)	45.63 (1159)

Speed / acceleration FL_G	max. 65.6 ft/s (20 m/s) / max. 656 ft/s ² (200 m/s ²)
Speed / acceleration FL_B	max. 9.84 ft/s (3 m/s) / max. 19.69 ft/s ² (6 m/s ²)
Gliding speed / acceleration (maximum)	max. 32.8 ft/s (10 m/s) / max. 164 ft/s ² (50 m/s ²)
Material - permitted temperature	igumid G / -40°F (-40°C) up to +248°F (+120°C)
Flammability Class, igumid G	VDE 0304 IIC UL94 HB



14240
14340

Short Travels - Unsupported



Unsupported e-chains® feature positive camber over short travels. This must be accounted for when specifying the clearance height. Please refer to **Installation dimensions** for further details.

Legend

- S = Length of travel
 - R = Bending radius
 - H = Nominal clearance height
 - D = Overlength e-chain® radius in final position
 - $K = \pi \cdot R + \text{safety buffer}$
 - H_F = Required clearance height
 - H_{in} = Trough inner height
 - H_2 = *Mounting height
 - D_2 = Overlength - long travels, gliding
 - K_2 = *Add-on
- *If the mounting bracket location is set lower



PDF: igus.com/e-chain-pdfs
 Product information: igus.com/e-chains

Long Travels - Gliding



If the unsupported length is exceeded, the e-chain®/ Tube must glide on itself. This requires a guide trough. **Design, Chapter 1**



For support of the lower run, see **Chapter 9** of the main catalog for the **Support Tray tool kit**

Technical Data



Details of material properties

► Chapter 1



Series 14240 - e-chain® with crossbars every link

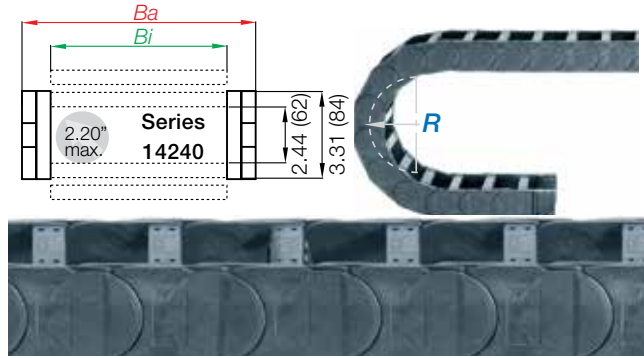

- Crossbars every link
- For use with rigid hydraulic hoses
- For particularly demanding applications
- Can be opened from both sides

Part Number Structure

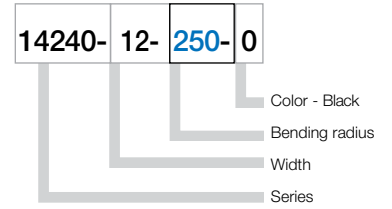

Series 14340 - e-chain® with crossbars every other link

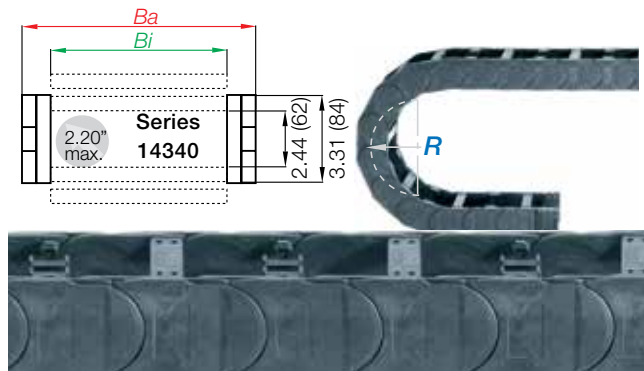

- Crossbars every other link - Standard configuration
- For nearly every situation
- Can be opened from both sides
- Easy assembly
- Stable
- Cost-effective

Part Number Structure

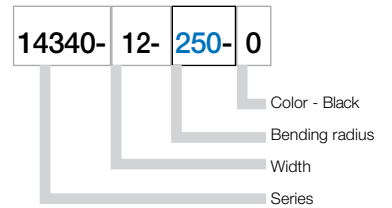

e-chain® as separate parts, links and side plates

Right side link*, single part - Part No. 14240-02-R

Single crossbar, e-chain® - Part No. 385-Bi

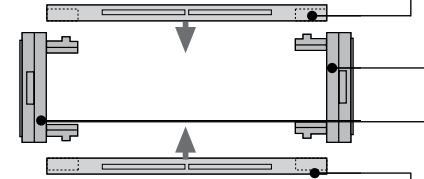

Single crossbar, e-chain® - Part No. 385-Bi

Left side link*, single part - Part No. 14240-01-R

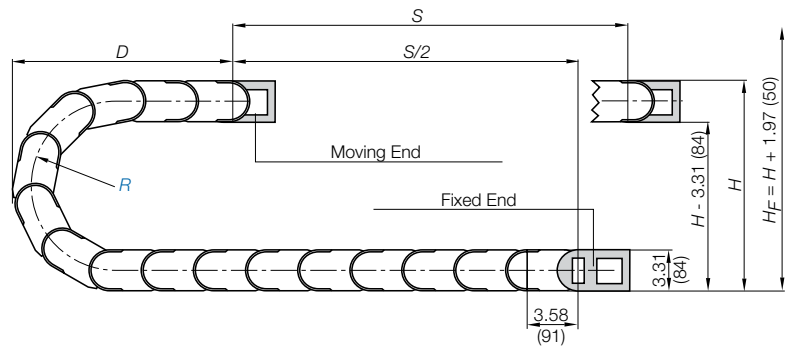

*View from the fixed point of the e-chain®/e-tube

e-chain system® E4 light

Series 14240/14340

Supplement part number with required radius. Example: 14040-30-300-0

Pitch: 3.58 in. (91mm) per link links/ft (m) = 3.35 (11)



14240
14340

Part Number.				<i>Bi</i>	<i>Ba</i>	14240	14340
Crossbars	Crossbars			in. (mm)	in. (mm)	lbs/ft (kg/m)	lbs/ft (kg/m)
Every link	Every other						
14240-05-	14340-05-	<input type="checkbox"/>	-0	1.97 (50)	2.99 (76)	≈1.59 (2.37)	≈ 1.56 (2.32)
14240-06-	14340-06-	<input type="checkbox"/>	-0	2.68 (68)	3.70 (94)	≈ 1.61 (2.40)	≈ 1.57 (2.33)
14240-07-	14340-07-	<input type="checkbox"/>	-0	2.95 (75)	3.98 (101)	≈ 1.63 (2.42)	≈ 1.57 (2.34)
14240-087-	14340-087-	<input type="checkbox"/>	-0	3.43 (87)	4.49 (114)	≈ 1.66 (2.47)	≈ 1.59 (2.36)
14240-10-	14340-10-	<input type="checkbox"/>	-0	3.94 (100)	4.96 (126)	≈ 1.69 (2.52)	≈ 1.61 (2.39)
14240-11-	14340-11-	<input type="checkbox"/>	-0	4.25 (108)	5.28 (134)	≈ 1.71 (2.55)	≈ 1.61 (2.40)
14240-112-	14340-112-	<input type="checkbox"/>	-0	4.41 (112)	5.47 (139)	≈ 1.71 (2.55)	≈ 1.62 (2.41)
14240-12-	14340-12-	<input type="checkbox"/>	-0	4.92 (125)	5.94 (151)	≈ 1.76 (2.62)	≈ 1.64 (2.44)
14240-137-	14340-137-	<input type="checkbox"/>	-0	5.39 (137)	6.46 (164)	≈ 1.79 (2.66)	≈ 1.65 (2.46)
14240-15-	14340-15-	<input type="checkbox"/>	-0	5.91 (150)	6.93 (176)	≈ 1.83 (2.72)	≈ 1.67 (2.49)
14240-162-	14340-162-	<input type="checkbox"/>	-0	6.38 (162)	7.44 (189)	≈ 1.83 (2.73)	≈ 1.67 (2.49)
14240-17-	14340-17-	<input type="checkbox"/>	-0	6.61 (168)	7.64 (194)	≈ 1.88 (2.79)	≈ 1.69 (2.52)
14240-18-	14340-18-	<input type="checkbox"/>	-0	6.89 (175)	7.91 (201)	≈ 1.90 (2.82)	≈ 1.70 (2.53)
14240-187-	14340-187-	<input type="checkbox"/>	-0	7.36 (187)	8.43 (214)	≈ 1.91 (2.84)	≈ 1.71 (2.55)
14240-20-	14340-20-	<input type="checkbox"/>	-0	7.87 (200)	8.90 (226)	≈ 1.94 (2.89)	≈ 1.73 (2.58)
14240-212-	14340-212-	<input type="checkbox"/>	-0	8.35 (212)	9.41 (239)	≈ 1.98 (2.95)	≈ 1.75 (2.60)
14240-23-	14340-23-	<input type="checkbox"/>	-0	8.86 (225)	9.88 (251)	≈ 2.02 (3.01)	≈ 1.77 (2.63)
14240-237-	14340-237-	<input type="checkbox"/>	-0	9.33 (237)	10.39 (264)	≈ 2.04 (3.04)	≈ 1.78 (2.65)
14240-25-	14340-25-	<input type="checkbox"/>	-0	9.84 (250)	10.87 (276)	≈ 2.08 (3.10)	≈ 1.80 (2.68)
14240-262-	14340-262-	<input type="checkbox"/>	-0	10.31 (262)	11.38 (289)	≈ 2.09 (3.11)	≈ 1.81 (2.69)
14240-28-	14340-28-	<input type="checkbox"/>	-0	10.83 (275)	11.85 (301)	≈ 2.14 (3.19)	≈ 1.83 (2.72)
14240-29-	14340-29-	<input type="checkbox"/>	-0	11.30 (287)	12.36 (314)	≈ 2.15 (3.20)	≈ 1.83 (2.73)
14240-30-	14340-30-	<input type="checkbox"/>	-0	11.81 (300)	12.83 (326)	≈ 2.22 (3.30)	≈ 1.87 (2.78)
14240-312-	14340-312-	<input type="checkbox"/>	-0	12.28 (312)	13.35 (339)	≈ 2.22 (3.31)	≈ 1.88 (2.79)
14240-325-	14340-325-	<input type="checkbox"/>	-0	12.79 (325)	13.82 (351)	≈ 2.26 (3.37)	≈ 1.89 (2.81)
14240-337-	14340-337-	<input type="checkbox"/>	-0	13.27 (337)	14.33 (364)	≈ 2.28 (3.40)	≈ 1.90 (2.83)
14240-350-	14340-350-	<input type="checkbox"/>	-0	13.78 (350)	14.80 (376)	≈ 2.39 (3.56)	≈ 1.96 (2.91)
14240-362-	14340-362-	<input type="checkbox"/>	-0	14.25 (362)	15.31 (389)	≈ 2.43 (3.61)	≈ 1.97 (2.93)
14240-375-	14340-375-	<input type="checkbox"/>	-0	14.76 (375)	15.79 (401)	≈ 2.45 (3.64)	≈ 1.98 (2.95)
14240-387-	14340-387-	<input type="checkbox"/>	-0	15.24 (387)	16.30 (414)	≈ 2.48 (3.69)	≈ 2.00 (2.97)
14240-400-	14340-400-	<input type="checkbox"/>	-0	15.75 (400)	16.77 (426)	≈ 2.51 (3.73)	≈ 2.00 (2.99)

Choose from the radii below for all of the above sizes

Radius (mm) Example: 14240-30-300-0

	135	150	175	200	250	300	400	500
R	5.31 (135)	5.91 (150)	6.89 (175)	7.87 (200)	9.84 (250)	11.81 (300)	15.75 (400)	19.68 (500)
H $\frac{3}{16}$	14.17 (360)	15.16 (385)	17.13 (435)	19.09 (485)	23.03 (585)	26.97 (685)	34.84 (885)	42.72 (1085)
D	10.63 (270)	11.22 (285)	12.20 (310)	13.19 (335)	15.16 (385)	17.13 (435)	21.06 (535)	25.00 (635)
K	25.59 (650)	29.53 (750)	32.48 (825)	35.43 (900)	41.34 (1050)	48.23 (1225)	57.09 (1450)	69.88 (1775)

*Removable lid only, no hinged option

0=Standard color black. For other colors see Chapter 1

For large diameter hoses see page 6.212

PDF: igus.com/e-chain-pdfs
Product information: igus.com/e-chains



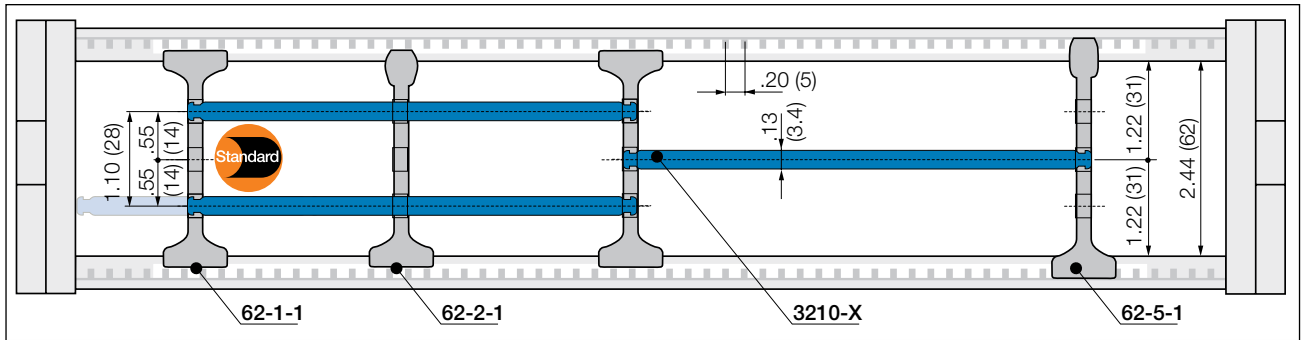

In the standard configuration separators are assembled every 2nd e-chain® link

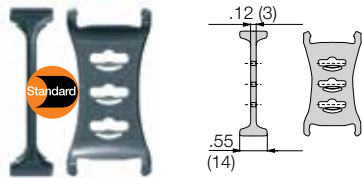

Separator, wide base

Unassembled **Part No. 62-1**
Assembled **Part No. 62-1-1**

● **Standard separator 62-1 for all applications**

Separator with wide base for maximum locking strength and safe standing in e-chains®.

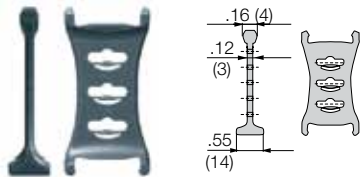

Separator for QuickLock crossbar

Unassembled **Part No. 62-2**
Assembled **Part No. 62-2-1**

● **Separator 62-2 For even faster installation**

Separator for igus® QuickLock crossbar 385-X-Q. Firm hold to one side with a wide base, narrow on opposed side for easy cable assembly (slight grip)

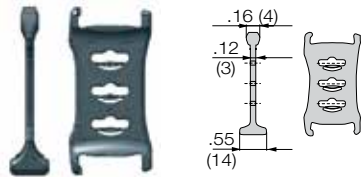

Notch separator for notch crossbar

Unassembled **Part No. 62-5**
Assembled **Part No. 62-5-1**

● **Separator 62-5**

Locks safely in .20" (5 mm) increments
Notch separator for exact positioning in e-chains®. Recommended for side mounted applications.

Lockable full-width shelves - for the standard interior separation

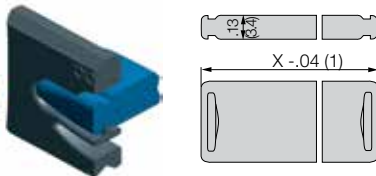

Full width shelf, lockable

Unassembled **Part No. 3200-X**
Assembled **Part No. 3210-X**

● **Full width shelf, lockable**

Shelf locks into separators on both ends, fixed width possible. Separators can be moved freely over the shelf in horizontal direction. Can be arranged at 3 different heights.

Width X in. (mm)	Part No. Unassembled	Part No. Assembled	Width X in. (mm)	Part No. Unassembled	Part No. Assembled
1.97 (050)	3200-50	3210-50	5.91 (150)	3200-150	3210-150
2.95 (075)	3200-75	3210-75	6.89 (175)	3200-175	3210-175
3.94 (100)	3200-100	3210-100	7.87 (200)	3200-200	3210-200
4.53 (115)	3200-115	3210-115	8.86 (225)	3200-225	3210-225
4.92 (125)	3200-125	3210-125	9.84 (250)	3200-250	3210-250

e-chain system® E4 light

Series 14240/14340

Interior Separation - Previous Generation



14240
14340

Option 1: Vertical separators and spacers

Vertical separators are used if a vertical subdivision of the e-chain® interior is required. By standard, vertical separators are assembled every other e-chain® link.

NOTE: Observe a lateral spacing of at least 1.30 in. (33mm) for e-tubes and .63 in. (16mm) for e-chain®. There is no minimum spacing needed for side plates

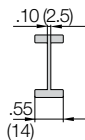
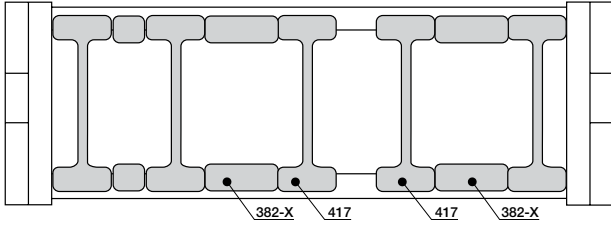

Vertical separator

Unassembled	Part No. 407
Assembled	Part No. 417

- **Standard separator 407 for e-chains® and e-tubes**
This separator offers safe stability due to its wide base design, also when used with thick cables or hoses.



Spacer (chain only)

Unassembled	Part No. 381-XX
Assembled	Part No. 382-XX

XX = width of the spacer

- **NOTE ON SPACERS**
Vertical separators are adjustable, but can be fixed in position by means of a spacer. Spacers are most often necessary for side mounted applications.
The available inner height is reduced by .08" (2mm) **per spacer** (for example if one spacer is placed on either side of the separator, the overall inner height is reduced by .16" (4mm). To avoid this, place the spacers on the **outside** of the opening crossbar (**not for long travels**).

Spacers available in the following sizes:

Part No. Unassembled	Part No. Assembled	in.	(mm)
381-10	382-10	.39"	(10)
381-15	382-15	.59"	(15)
381-20	382-20	.79"	(20)

PDF: igus.com/e-chain-pdfs
Product information: igus.com/e-chains



Option 2: Shelves

e-chains® and e-tubes can be subdivided both vertically and horizontally using the various interior separation elements.

► **Design, Chapter 1** for layout recommendations.

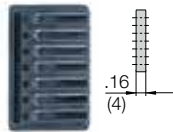
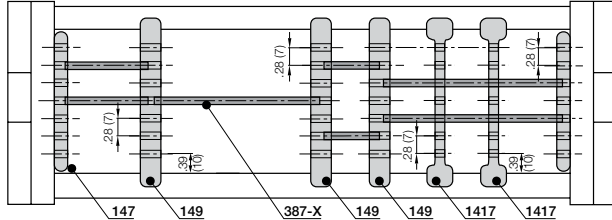

Side plate
Unassembled **Part No. 146**
Assembled **Part No. 147**

- **Side plates 146**
This component is used to form the basic pattern of a shelf system.

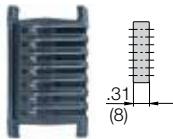

Vertical separator
Unassembled **Part No. 148**
Assembled **Part No. 149**

- **Vertical separator 148**
This component is used to form the basic pattern of a shelf system.

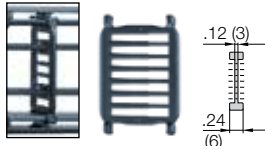

Slotted separators, closed
Unassembled **Part No. 1407**
Assembled **Part No. 1417**

- **Slotted separators 1407**
These are used for very complex subdivisions. However, they cannot be retrofitted into an existing separation system without removing the shelves first.

Shelves 420-XX

These components form the basic pattern of a shelf system.

Shelves of various widths can be arranged at 7 different heights in .28" (7mm) increments

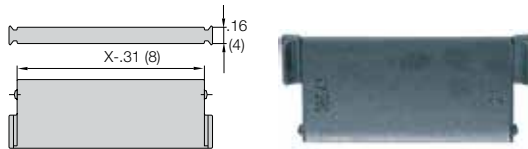

Width X in. (mm)	Usable Width in. (mm)	Part No. Unassembled	Part No. Assembled	Width X in. (mm)	Usable Width in. (mm)	Part No. Unassembled	Part No. Assembled
.71 (18)	.39 (10)	386-18	387-18	2.95 (75)	2.64 (67)	386-75	387-75
.91 (23)	.59 (15)	386-23	387-23	3.43 (87)	3.11 (79)	386-87	387-87
.98 (25)	.67 (17)	386-25	387-25	3.94 (100)	3.62 (92)	386-100	387-100
1.10 (28)	.79 (20)	386-28	387-28	4.25 (108)	3.94 (100)	386-108	387-108
1.30 (33)	.98 (25)	386-33	387-33	4.92 (125)	4.61 (117)	386-125	387-125
1.69 (43)	1.38 (35)	386-43	387-43	5.91 (150)	5.59 (142)	386-150	387-150
1.97 (50)	1.65 (42)	386-50	387-50	6.89 (175)	6.57 (167)	386-175	387-175
2.13 (54)	1.81 (46)	386-54	387-54	7.87 (200)	7.56 (192)	386-200	387-200
2.44 (62)	2.13 (54)	386-62	387-62	8.19 (208)	7.87 (200)	386-208	387-208



Consult igus® for your extender crossbar applications. We will be happy to assist you with your design layout.

Extender crossbars - For careful guiding of large diameter cables and hoses

- Intended for cables and hoses with a maximum outer diameter of 4.53 in. (115 mm).
- Gliding operation with crossbars assembled along the outer radius in conjunction with a special guide trough
- Gliding operation not guaranteed with crossbars assembled along the inner radius
- The extender crossbar can either be attached to the side links directly or can be used in combination with two standard snap-open crossbars.

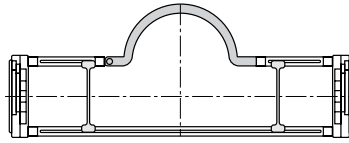

Round extender crossbar combined with standard snap-open crossbars.

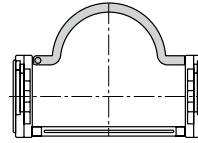

Attached directly to the side link.

Part No.	Max Ø Hose in. (mm)	Style	Installation Side Link	Combined with Snap-Open Crossbars
385-15-RHD115	4.53 (115)	Round	No	Yes
385-18-RD115	4.53 (115)	Round	Yes	No

Hinged crossbars

- Typically, e-chain® crossbars are completely removable. In cases where it is preferable that the opening crossbars remain on the e-chain®, a hinged design has been developed.
- Please consult igus® for design assistance

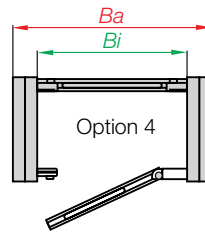
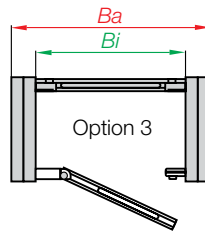
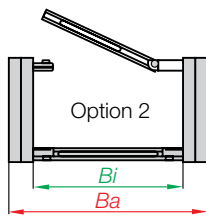
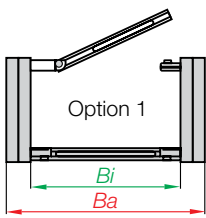

14240
14340



e-chain system® E4 light Series 14240/14340 Mounting Brackets - KMA

igus®
e-chain system®

Telephone 1-800-521-2747

Internet: igus.com
email: sales@igus.com
QuickSpec: igus.com/quickspec



Option 1: KMA pivoting

- Profile rail option
- Universal use
- Corrosion resistant
- Short and long travels
- Space-restricted conditions

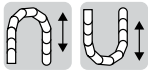
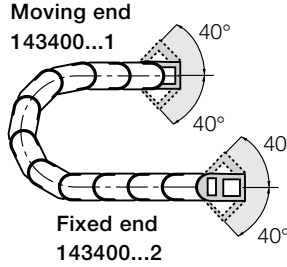

Option 2: KMA locking

- Profile rail option
- Universal use
- Corrosion resistant
- Extreme accelerations
- Vertical hanging/standing travels

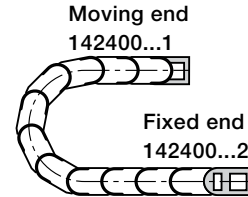

Part Number Structure

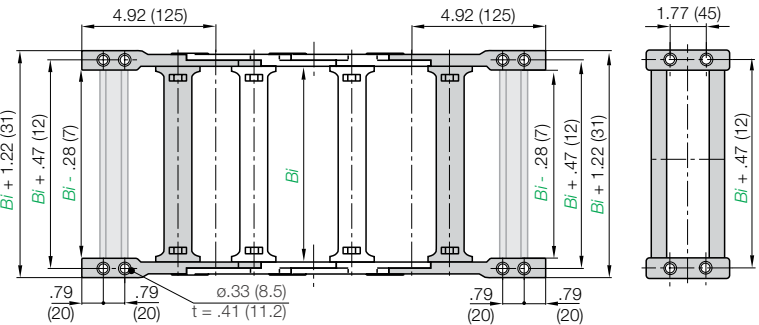
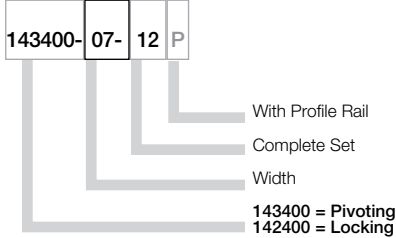

Full set, for both ends:

143400-05-12 Full set, each part with pin/bore

Single-part order:

143400-05-1 Mounting bracket with bore
143400-05-2 Mounting bracket with pin

Part number examples are shown for pivoting brackets. For locking brackets change part number to 142400

Part No. Full Set (pivoting)
Series 14240 or 14340:
143400-Width-12

Part No. Full Set (pivoting)
with profile rail
Series 14240 or 14340
143400-Width-12P

Width	Part No. Full Set		With Profile Rail	Bi in. (mm)	Width	Part No. Full Set		With Profile Rail	Bi in. (mm)
	Pivoting	Locking				Pivoting	Locking		
-05	143400	142400	-05-12 P	1.97 (50)	-23	143400	142400	-23-12 P	8.86 (225)
-06	143400	142400	-06-12 P	2.68 (68)	-237	143400	142400	-237-12 P	9.33 (237)
-07	143400	142400	-07-12 P	2.95 (75)	-25	143400	142400	-25-12 P	9.84 (250)
-087	143400	142400	-087-12 P	3.43 (87)	-262	143400	142400	-262-12 P	10.31 (262)
-10	143400	142400	-10-12 P	3.94 (100)	-28	143400	142400	-28-12 P	10.83 (275)
-11	143400	142400	-11-12 P	4.25 (108)	-29	143400	142400	-29-12 P	11.30 (287)
-112	143400	142400	-112-12 P	4.41 (112)	-30	143400	142400	-30-12 P	11.81 (300)
-12	143400	142400	-12-12 P	4.92 (125)	-312	143400	142400	-312-12 P	12.28 (312)
-137	143400	142400	-137-12 P	5.39 (137)	-325	143400	142400	-325-12 P	12.79 (325)
-15	143400	142400	-15-12 P	5.91 (150)	-337	143400	142400	-337-12 P	13.27 (337)
-162	143400	142400	-162-12 P	6.38 (162)	-350	143400	142400	-350-12 P	13.78 (350)
-17	143400	142400	-17-12 P	6.61 (168)	-362	143400	142400	-362-12 P	14.25 (362)
-18	143400	142400	-18-12 P	6.89 (175)	-375	143400	142400	-375-12 P	14.76 (375)
-187	143400	142400	-187-12 P	7.36 (187)	-387	143400	142400	-387-12 P	15.24 (387)
-20	143400	142400	-20-12 P	7.87 (200)	-400	143400	142400	-400-12 P	15.75 (400)
-212	143400	142400	-212-12 P	8.35 (212)					

Chainfix clamps for the profile rail

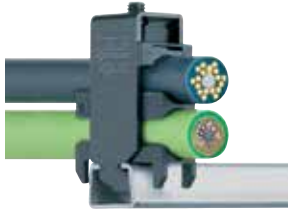

igus® Chainfix strain relief elements are available in either steel or stainless steel. They can be adjusted with a hexagon socket and are available in single, double and triple configurations.

Part No. Single Clamp		Part No. Double Clamp		Part No. Triple Clamp		Cable ø	
Steel	Stainless	Steel	Stainless	Steel	Stainless	in.	(mm)
CFX12-1	CFX12-1E	CFX12-2	CFX12-2E	CFX12-3	-	.24 - .47	(6 - 12)
CFX14-1	CFX14-1E	CFX14-2	CFX14-2E	CFX14-3	-	.47 - .55	(12 - 14)
CFX16-1	CFX16-1E	CFX16-2	CFX16-2E	CFX16-3	-	.55 - .63	(14 - 16)
CFX18-1	CFX18-1E	CFX18-2	CFX18-2E	CFX18-3	-	.63 - .71	(16 - 18)
CFX20-1	CFX20-1E	CFX20-2	CFX20-2E	CFX20-3	-	.71 - .79	(18 - 20)
CFX22-1	CFX22-1E	CFX22-2	CFX22-2E	CFX22-3	-	.79 - .87	(20 - 22)
CFX26-1	CFX26-1E	CFX26-2	CFX26-2E	-	-	.87 - 1.02	(22 - 26)
CFX30-1	CFX30-1E	CFX30-2	CFX30-2E	-	-	1.02 - 1.18	(26 - 30)
CFX34-1	CFX34-1E	CFX34-2	CFX34-2E	-	-	1.18 - 1.34	(30 - 34)
CFX38-1	CFX38-1E	-	-	-	-	1.34 - 1.50	(34 - 38)
CFX42-1	CFX42-1E	-	-	-	-	1.50 - 1.65	(38 - 42)

For more information please refer to strain relief section of Chapter 10

Tiewrap Plates

Option 1:

Tiewrap plates as an individual part

Available as an individual component, can be fixed onto a mounting bracket with the use of a profile rail.

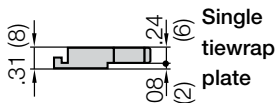
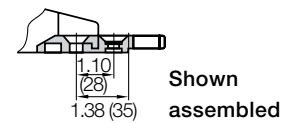

Tiewrap Plate	n Number of Teeth	C Overall Width in. (mm)	B Bore Width in. (mm)	Center Bore
3050-ZB	5	1.97 (50)	1.18 (30)	no
3075-ZB	7	2.95 (75)	2.16 (55)	no
3100-ZB	10	3.94 (100)	3.15 (80)	no
3115-ZB	11	4.53 (115)	3.74 (95)	no
3125-ZB	12	4.92 (125)	4.13 (105)	no
3150-ZB	15	5.91 (150)	5.12 (130)	no
3175-ZB	17	6.89 (175)	6.10 (155)	no
3200-ZB	20	7.87 (200)	7.09 (180)	yes
3225-ZB	22	8.86 (225)	8.07 (205)	yes
3250-ZB	25	9.84 (250)	9.06 (230)	yes

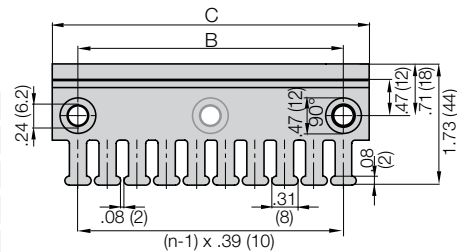

If used with KMA brackets with profile rail please add "KMA" to the end of the part number.

Example: 3050-ZBKMA

For more information please refer to strain relief section of Chapter 10



Option 2:

Clip-on Tiewrap plates

Available as a clip-on tiewrap plate without the use of bolts They are inserted and removed with a screwdriver used as a lever. Clip-on tiewrap plates are also available as an attachment to the opening crossbars.

Part No.	Number of Teeth	Width of Strain Relief in. (mm)
3050-ZC	5	1.97 (50)
3075-ZC	7	2.95 (75)

For more information please refer to strain relief section of Chapter 10



Option 3:

Clip-on Tiewrap plates for opening crossbars

Clip-on tiewrap plates are also available as an attachment to opening crossbars. They can be positioned at any point along the e-chain®.

Part No.	Number of Teeth	Width of Strain Relief in. (mm)
3850-ZS	5	1.89 (48)

For more information please refer to strain relief section of Chapter 10



Width of Crossbar
14240-05-200-0

	B_{Ri}	Installation Part No.
-05	3.19 (81)	*
-06	3.90 (99)	*
-07	4.17 (106)	94-50-225
-087	4.65 (118)	94-50-250
-10	5.16 (131)	94-50-250
-11	5.47 (139)	94-50-250
-112	5.63 (143)	94-50-275
-12	6.14 (156)	94-50-275
-137	6.61 (168)	94-50-300
-15	7.12 (181)	94-50-300
-162	7.60 (193)	94-50-325
-17	7.83 (199)	94-50-325
-18	8.11 (206)	94-50-325
-187	8.58 (218)	94-50-350
-20	9.09 (231)	94-50-350
-212	9.57 (243)	94-50-375
-23	10.08 (256)	94-50-375
-237	10.55 (268)	94-50-400
-25	11.06 (281)	94-50-400
-262	11.54 (293)	94-50-425
-28	12.05 (306)	94-50-425
-29	12.52 (318)	94-50-450
-30	13.03 (331)	94-50-450
-312	13.50 (343)	94-50-475
-325	14.02 (356)	94-50-475
-337	14.49 (368)	94-50-500
-350	15.00 (381)	94-50-500
-362	15.47 (393)	94-50-525
-375	15.98 (406)	94-50-525
-387	16.46 (418)	94-50-550
-400	16.97 (431)	94-50-550

Guide troughs are used with applications where the upper run of the e-chain® glides on the lower run. If using igus® steel guide troughs, the following components are required:

- Full travel length of guide trough
Part No. 94-30
- 1/2 travel length glide bars
Part No. 93-01
- Installation sets as end connectors
Part No. 94-50-XX

.XX indicates the length of the profile rails on which the guide trough is mounted. The values and part numbers are specified in the table on the left. The standard length of the trough components and glide bars is 6.56 ft (2 m). The required overall length of the guide trough directly correlates to the length of travel.

Example:

Length of travel 164 ft (50 m)
Center mounted

Required guide troughs

164 ft (50 m) guide trough
82 ft (25 m) glide bars
= 25 sections of 6.56 ft (2 m) guide trough

Part No. 94-30

= 13 sections of 6.56 ft (2 m) glide bars

Part No. 93-01

Required number of installation sets:

= Number of guide trough components + 1
= 25 + 1 = 26

Part number of the installation sets

94-50-XXX

Example:

94-50-400 for 15.75 (400 mm) long profile rail



Left: Guide trough with glide bars
Right: Guide troughs without glide bars



Installation sets as section connectors

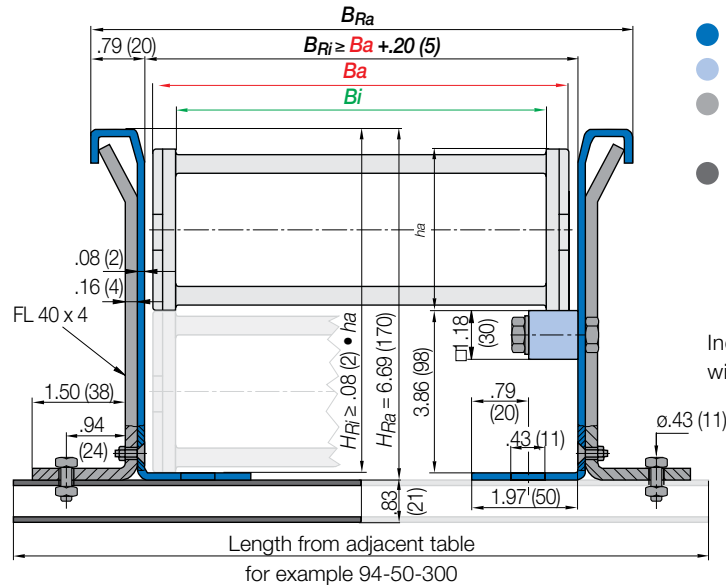

- Guide trough
- Glide bars
- Installation set "Basic"
- Profile rail

Individual attachment without profile rail

* Specialized guide trough available upon request

Standard length profile rail

PDF: igus.com/e-chain-pdfs
Product information: igus.com/e-chains



14550
14650
R19050



e-chain system® E4 light Series 14550/14650/R19050

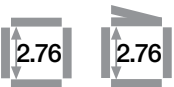

Price Index

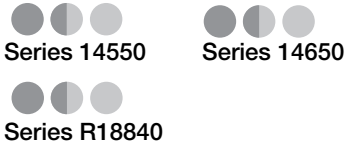

Special Features / Options

ESD classification:
Electrically conductive ESD/
ATEX version upon request

High torsional rigidity

Side-mounted - unsupported

Assembly Tips



Opening e-chains®: Remove crossbars and clips - Insert screwdriver into the slot, push down, release by lever action



Remove lids/bottoms (e-tubes) - Insert screwdriver into the slot, release by lever action

Other Installation Methods

Vertical, hanging ≤ 262 ft (80 m)

Vertical, standing ≤ 19.69 ft (6 m)

Side-mounted, un supp. ≤ 6.56 ft (2 m)

Rotary requires further calculation

Usage Guidelines



- If weight and price reduction is needed
- If an e-chain®/e-tube with an inner height of 2.76" (70 mm) is required



- If an extremely low-noise version is required
➤ Series E6-80L
- If side-mounted chain/tube with a longer unsupported travel is required
➤ Series E4-800
- If increased unsupported lengths and longer travels are required
➤ Series E4-80

Features & Benefits

- 1 KMA mounting brackets with attachment points on all sides
- 2 Noise dampening pads, optional = -10dB(A)
- 3 Hinged snap-open removable lids along outer radius of e-tube
- 4 Lateral glide surfaces for side-mounted operation
- 5 25% faster assembly with QuickLock Crossbar
- 6 High stability due to undercut design
- 7 Notch crossbar with visual scale
- 8 No camber: no rework due to special design



Order Example: Complete e-chain®

Please indicate chain length or number of links. Example:

16.4 ft (5 m) 14550-30-300-0

e-chain®

With 2 separators 70-1-1 assembled every 2nd link

Interior Separation

1 Set 145500-30-12P

Mounting Bracket

e-chain system® E4 light Series 14550/14650/R19050 Installation Dimensions



14550
14650
R19050

Short travel, unsupported length

- FL_B = unsupported with permitted sag
 - FL_G = unsupported with straight upper run
- Further information ► Design, Chapter 1

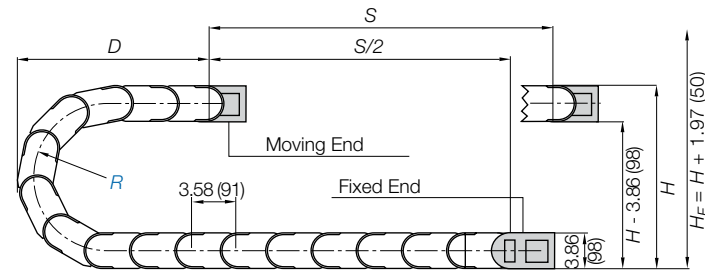
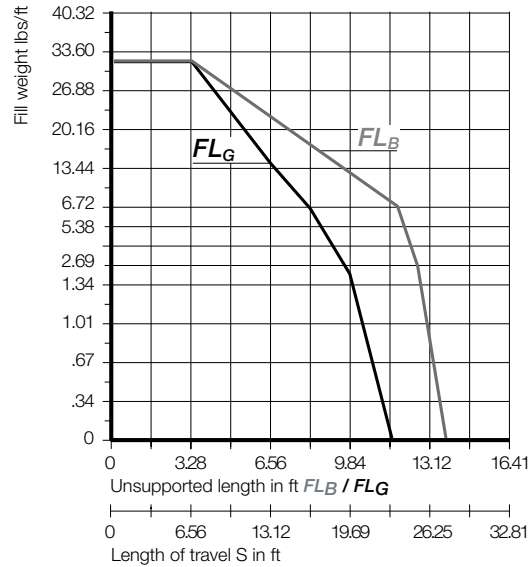
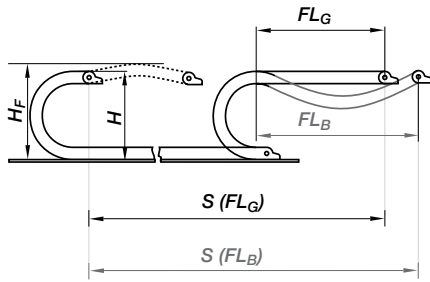

Pitch per link = 3.58" (91 mm)
Links per ft (m) = 3.35 (11)
For center mount applications:
Chain length = $\frac{S}{2} + K$

The required clearance height: $H_F = H + 1.97$ in. (50 mm) (with 1.68 lbs/ft (2.5 kg/m) fill weight. Please consult igus® if space is particularly restricted.

	5.91 (150*)	6.89 (175*)	7.87 (200)	9.84 (250)	11.81 (300)	13.78 (350)	15.75 (400)	17.72 (450)	19.68 (500)	23.62 (600)
R	5.91 (150*)	6.89 (175*)	7.87 (200)	9.84 (250)	11.81 (300)	13.78 (350)	15.75 (400)	17.72 (450)	19.68 (500)	23.62 (600)
H	15.67 (398)	17.64 (448)	19.61 (498)	23.54 (598)	27.48 (698)	31.42 (798)	35.35 (898)	39.29 (998)	43.23(1098)	51.10 (1298)
D	13.23 (336)	14.21 (361)	15.19 (386)	17.17 (436)	19.13 (486)	21.10 (536)	23.07 (586)	25.04 (636)	27.01 (686)	30.94 (786)
K	25.79 (655)	28.94 (735)	32.09 (815)	38.19 (970)	44.29 (1125)	50.59 (1285)	56.29 (1440)	62.99 (1600)	69.09 (1755)	81.50 (2070)

For long travels with lowered mounting height

Long travel lengths from 32.8 ft.(10m) to max. 492 ft. (150m)

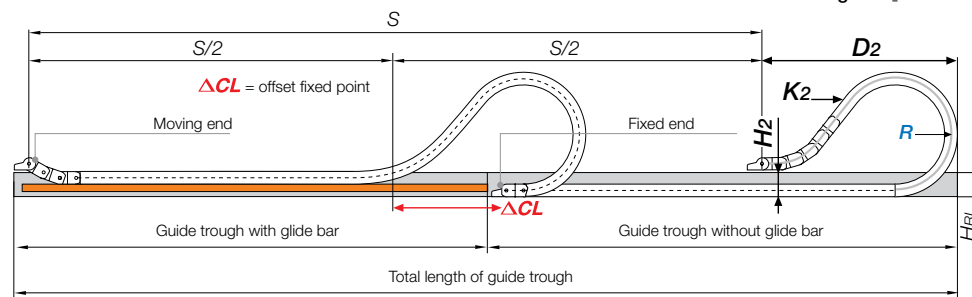

For center mount applications:

Chain length = $\frac{S}{2} + K_2$

Long Travels - Gliding



If the unsupported length is exceeded, the e-chain®/ Tube must glide on itself. This requires a guide trough.

Design, Chapter 1

	5.91 (150*)	6.89 (175*)	7.87 (200)	9.84 (250)	11.81 (300)	13.78 (350)	15.75 (400)	17.72 (450)	19.68 (500)	23.62 (600) ²⁾
R	5.91 (150*)	6.89 (175*)	7.87 (200)	9.84 (250)	11.81 (300)	13.78 (350)	15.75 (400)	17.72 (450)	19.68 (500)	23.62 (600) ²⁾
H ₂	10.47 (266)	10.47 (266)	10.47 (266)	10.47 (266)	10.47 (266)	10.47 (266)	10.47 (266)	10.47 (266)	10.47 (266)	-
D ₂ +25	17.72 (450)	20.87 (530)	27.95 (710)	36.22 (920)	44.09 (1120)	52.76 (1340)	60.24 (1530)	41.25 (1048)	72.05 (1830)	-
K ₂	32.24 (819)	39.41 (1001)	50.16 (1274)	64.49 (1638)	75.24 (1911)	85.98 (2184)	100.31 (2548)	111.06 (2821)	125.39 (3185)	-
ΔCL	4.88 (124)	6.26 (159)	8.22 (209)	14.13 (359)	20.04 (509)	25.94 (659)	32.64 (829)	37.76 (959)	45.63 (1159)	-

*Radius not available for e-tubes ²⁾ R600 not suitable for long travels. Please consult igus®



For support of the lower run, see Chapter 9 of the main catalog for the Support Tray tool kit

Speed / acceleration FL_G	max. 65.6 ft/s (20 m/s) / max. 656 ft/s ² (200 m/s ²)
Speed / acceleration FL_B	max. 9.84 ft/s (3 m/s) / max. 19.69 ft/s ² (6 m/s ²)
Gliding speed / acceleration (maximum)	max. 32.8 ft/s (10 m/s) / max. 164 ft/s ² (50 m/s ²)
Material - permitted temperature	igumid G / -40°F (-40°C) up to +248°F (+120° C)
Flammability Class, igumid G	VDE 0304 IIC UL94 HB

Technical Data



Details of material properties ► Chapter 1

PDF: igus.com/e-chain-pdfs
Product information: igus.com/e-chains

2.76



6.218

Series 14550 - e-chain® with crossbars every link

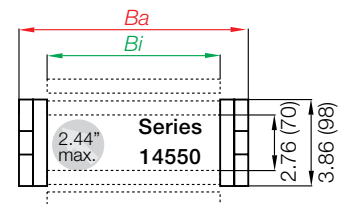

- Crossbars every link
- For use with rigid hydraulic hoses
- For particularly demanding applications
- Can be opened from both sides

Part Number Structure

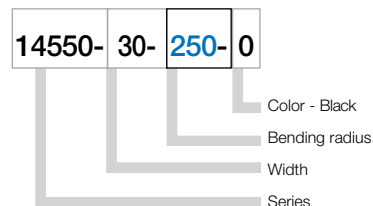

Series 14650 - e-chain® with crossbars every other link

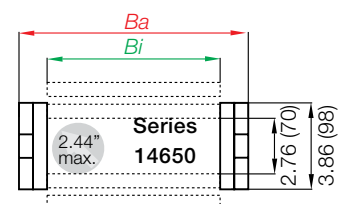

- Crossbars every other link - Standard configuration
- For nearly every situation
- Can be opened from both sides
- Easy assembly
- Stable
- Cost-effective

Part Number Structure

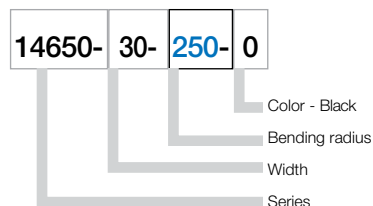

Series R19050 - fully enclosed e-tube

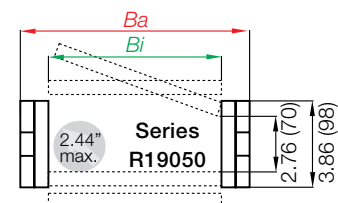

- Fully enclosed
- Excellent cable and hose protection against dirt
- Protection against hot chips
- Lids along inner radius are completely removable
- Lids along the outer radius are single-sided, snap open, hinged on one side as well as completely removable

Part Number Structure

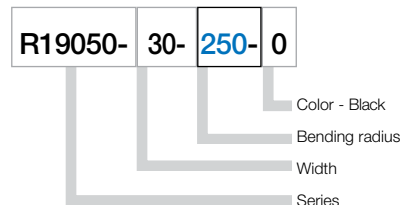

e-chain® as separate parts, links and side plates

Right side link*, single part - Part No. 14550-02-R

Single crossbar, e-chain® - Part No. 450-Bi

Single lid, e-tube - Part No. 885-Bi

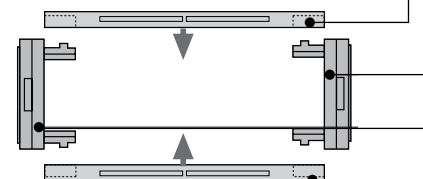

Single bottom, e-tube - Part No. 886-Bi

Left side link*, single part - Part No. 14550-01-R

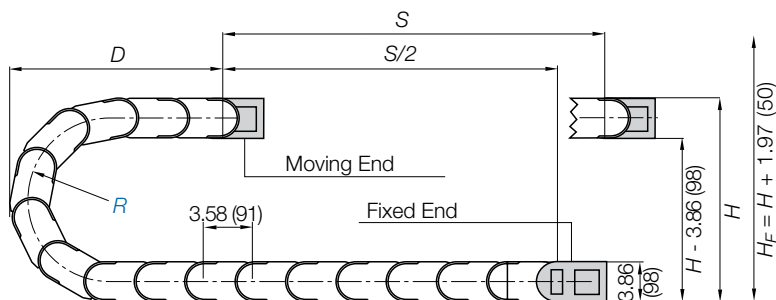

*View from the fixed point of the e-chain®/e-tube

e-chain system® E4 light

Series 14550/14650/R19050

Supplement part number with required radius. Example: 14550-30-300-0

Pitch: 3.58 in. (91mm) per link links/ft (m) = 3.35 (11)



14550
14650
R19050

Part Number			<i>Bi</i>	<i>Ba</i>	14550	14650	R19050
Crossbars Every link	Crossbars Every other	Tube Version	in. (mm)	in. (mm)	lbs/ft (kg/m)	lbs/ft (kg/m)	lbs/ft (kg/m)
14550-05-	14650-05-	<input type="checkbox"/> -0	1.97 (50)	3.03 (77)	≈ 2.41 (3.28)	≈ 2.49 (3.27)	-
14550-06-	14650-06-	<input type="checkbox"/> -0	2.56 (65)	3.62 (92)	≈ 2.26 (3.37)	≈ 2.22 (3.31)	-
14550-07-	14650-07-	19050-07- <input type="checkbox"/> -0	2.95 (75)	4.02 (102)	≈ 2.31 (3.44)	≈ 2.25 (3.35)	≈ 2.69 (4.00)
14550-08-	14650-08-	<input type="checkbox"/> -0	3.43 (87)	4.49 (114)	≈ 2.37 (3.52)	≈ 2.27 (3.38)	-
14550-10-	14650-10-	19050-10- <input type="checkbox"/> -0	3.94 (100)	5.00 (127)	≈ 2.43 (3.61)	≈ 2.30 (3.43)	≈ 2.91 (4.33)
14550-11-	14650-11-	<input type="checkbox"/> -0	4.41 (112)	5.47 (139)	≈ 2.51 (3.73)	≈ 2.35 (3.49)	-
14550-12-	14650-12-	19050-12- <input type="checkbox"/> -0	4.92 (125)	5.98 (152)	≈ 2.56 (3.81)	≈ 2.37 (3.53)	≈ 3.16 (4.70)
14550-13-	14650-13-	<input type="checkbox"/> -0	5.39 (137)	6.46 (164)	≈ 2.65 (3.94)	≈ 2.42 (3.60)	-
14550-15-	14650-15-	19050-15- <input type="checkbox"/> -0	5.91 (150)	6.97 (177)	≈ 2.67 (3.98)	≈ 2.43 (3.62)	≈ 3.39 (5.04)
14550-16-	14650-16-	<input type="checkbox"/> -0	6.38 (162)	7.44 (189)	≈ 2.75 (4.09)	≈ 2.47 (3.67)	-
14550-17-	14650-17-	19050-17- <input type="checkbox"/> -0	6.89 (175)	7.95 (202)	≈ 2.84 (4.23)	≈ 2.51 (3.74)	≈ 3.64 (5.41)
14550-18-	14650-18-	<input type="checkbox"/> -0	7.36 (187)	8.43 (214)	≈ 2.92 (4.34)	≈ 2.55 (3.80)	-
14550-20-	14650-20-	19050-20- <input type="checkbox"/> -0	7.87 (200)	8.94 (227)	≈ 2.95 (4.39)	≈ 2.57 (3.82)	≈ 3.79 (5.64)
14550-21-	14650-21-	<input type="checkbox"/> -0	8.35 (212)	9.41 (239)	≈ 3.00 (4.46)	≈ 2.59 (3.86)	-
14550-22-	14650-22-	<input type="checkbox"/> -0	8.86 (225)	9.92 (252)	≈ 3.04 (4.53)	≈ 2.61 (3.89)	-
14550-23-	14650-23-	<input type="checkbox"/> -0	9.33 (237)	10.39 (264)	≈ 3.12 (4.64)	≈ 2.84 (3.95)	-
14550-25-	14650-25-	19050-25- <input type="checkbox"/> -0	9.84 (250)	10.91 (277)	≈ 3.20 (4.76)	≈ 2.69 (4.00)	≈ 4.25 (6.32)
14550-26-	14650-26-	<input type="checkbox"/> -0	10.31 (262)	11.38 (289)	≈ 3.26 (4.85)	≈ 2.72 (4.05)	-
14550-27-	14650-27-	19050-27- <input type="checkbox"/> -0	10.83 (275)	11.89 (302)	≈ 3.33 (4.95)	≈ 2.76 (4.10)	≈ 4.47 (6.65)
14550-28-	14650-28-	<input type="checkbox"/> -0	11.30 (287)	12.36 (314)	≈ 3.37 (5.01)	≈ 2.78 (4.13)	-
14550-30-	14650-30-	19050-30- <input type="checkbox"/> -0	11.81 (300)	12.87 (327)	≈ 3.47 (5.16)	≈ 2.83 (4.21)	≈ 4.70 (6.99)
14550-31-	14650-31-	<input type="checkbox"/> -0	12.28 (312)	13.35 (339)	≈ 3.49 (5.20)	≈ 2.84 (4.23)	-
14550-32-	14650-32-	<input type="checkbox"/> -0	12.79 (325)	13.86 (352)	≈ 3.56 (5.30)	≈ 2.88 (4.28)	-
14550-33-	14650-33-	<input type="checkbox"/> -0	13.27 (337)	14.33 (364)	≈ 3.64 (5.42)	≈ 2.92 (4.34)	-
14550-35-	14650-35-	19050-35- <input type="checkbox"/> -0	13.78 (350)	14.84 (377)	≈ 3.78 (5.62)	≈ 2.98 (4.44)	≈ 5.16 (7.68)
14550-36-	14650-36-	<input type="checkbox"/> -0	14.25 (362)	15.31 (389)	≈ 3.72 (5.53)	≈ 2.95 (4.39)	-
14550-37-	14650-37-	<input type="checkbox"/> -0	14.76 (375)	15.83 (402)	≈ 3.78 (5.63)	≈ 2.98 (4.44)	-
14550-38-	14650-38-	<input type="checkbox"/> -0	15.24 (387)	16.30 (414)	≈ 3.86 (5.74)	≈ 3.02 (4.50)	-
14550-40-	14650-40-	19050-40- <input type="checkbox"/> -0	15.75 (400)	16.81 (427)	≈ 4.04 (6.01)	≈ 3.11 (4.63)	≈ 5.62 (8.36)
14550-41-	14650-41-	<input type="checkbox"/> -0	16.22 (412)	17.28 (439)	≈ 3.99 (5.94)	≈ 3.09 (4.60)	-
14550-42-	14650-42-	<input type="checkbox"/> -0	16.73 (425)	17.79 (452)	≈ 4.19 (6.23)	≈ 3.19 (4.74)	-
14550-43-	14650-43-	<input type="checkbox"/> -0	17.20 (437)	18.27 (464)	≈ 4.08 (6.07)	≈ 3.13 (4.66)	-
14550-45-	14650-45-	<input type="checkbox"/> -0	17.72 (450)	18.78 (477)	≈ 4.30 (6.40)	≈ 3.25 (4.83)	-
14550-46-	14650-46-	19050-46- <input type="checkbox"/> -0	18.19 (462)	19.25 (489)	≈ 4.27 (6.35)	≈ 3.23 (4.80)	≈ 6.19 (9.21)
14550-47-	14650-47-	<input type="checkbox"/> -0	18.70 (475)	19.76 (502)	≈ 4.29 (6.39)	≈ 3.24 (4.82)	-
14550-48-	14650-48-	<input type="checkbox"/> -0	19.17 (487)	20.24 (514)	≈ 4.46 (6.64)	≈ 3.33 (4.95)	-
14550-50-	14650-50-	<input type="checkbox"/> -0	19.69 (500)	20.75 (527)	≈ 4.53 (6.74)	≈ 3.36 (5.00)	-
14550-51-	14650-51-	<input type="checkbox"/> -0	20.16 (512)	21.22 (539)	≈ 4.47 (6.65)	≈ 3.33 (4.95)	-
14550-52-	14650-52-	<input type="checkbox"/> -0	20.67 (525)	21.73 (552)	≈ 4.58 (6.82)	≈ 3.39 (5.04)	-
14550-53-	14650-53-	<input type="checkbox"/> -0	21.14 (537)	22.20 (564)	≈ 4.65 (6.92)	≈ 3.42 (5.09)	-
14550-55-	14650-55-	<input type="checkbox"/> -0	21.65 (550)	22.72 (577)	≈ 4.93 (7.34)	≈ 3.56 (5.30)	-
14550-60-	14650-60-	<input type="checkbox"/> -0	23.62 (600)	24.69 (627)	≈ 5.09 (7.57)	≈ 3.64 (5.41)	-

Choose from the radii below for all of the above sizes

Radius (mm) Example: 14550-30-300-0

	150*	175*	200	250	300	350	400	450	500	600
<i>R</i>	5.91 (150)	6.89 (175)	7.87 (200)	9.84 (250)	11.81 (300)	13.78 (350)	15.75 (400)	17.72 (450)	19.68 (500)	23.62 (600)
<i>H</i>	15.67 (398)	17.64 (448)	19.61 (498)	23.54 (598)	27.48 (698)	31.42 (798)	35.35 (898)	39.29 (998)	43.23(1098)	51.10 (1298)
<i>D</i>	13.23 (336)	14.21 (361)	15.19 (386)	17.17 (436)	19.13 (486)	21.10 (536)	23.07 (586)	25.04 (636)	27.01 (686)	30.94 (786)
<i>K</i>	25.79 (655)	28.94 (735)	32.09 (815)	38.19 (970)	44.29 (1125)	50.59 (1285)	56.29 (1440)	62.99 (1600)	69.09 (1755)	81.50 (2070)

* This radius is not available for the Tube Series

¹⁾ Values upon request

²⁾ Note: for using *R 600* for long travels (gliding) please consult igus® first.

0=Standard color black. For other colors see Chapter 1

For large diameter hoses see page 6.22

PDF: igus.com/e-chain-pdfs
Product information: igus.com/e-chains



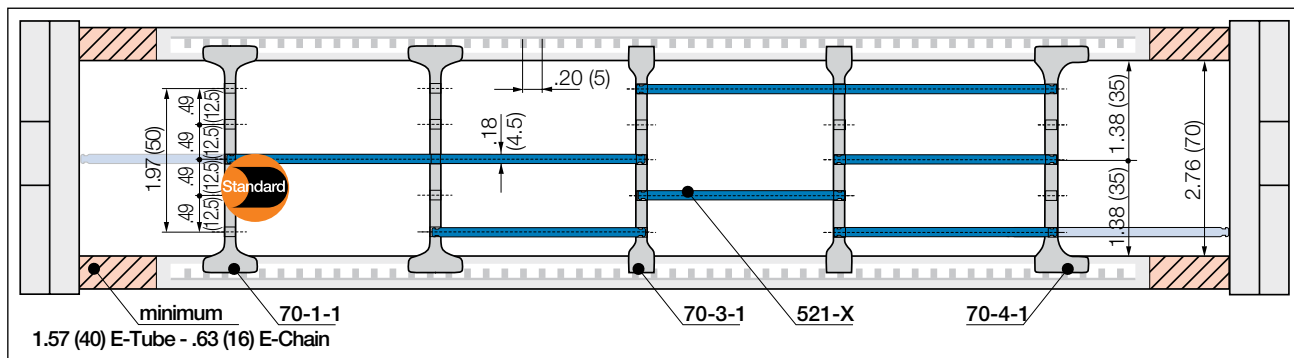

Note Please maintain a lateral spacing of 1.57" (40 mm) for e-tube and .63" (16 mm) for e-chains® between the separators and the side links. In the standard configuration separators are assembled every 2nd e-chain® link

Telephone 1-800-521-2747

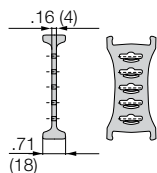

Separator, wide base

Unassembled Part No. 70-1
Assembled Part No. 70-1-1

- **Standard separator 70-1 for all applications**

Separator with wide base for maximum locking strength and safe standing in e-chains®.

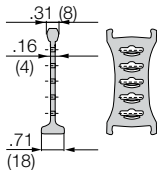

Separator, narrow head

Unassembled Part No. 70-2
Assembled Part No. 70-2-1

- **Separator 70-2**

For even faster installation
Separator for igus® QuickLock crossbar 385-X-Q. Firm hold to one side with a wide base, narrow on opposed side for easy cable assembly (slight grip)

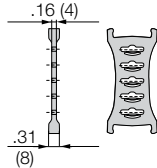

Separator, narrow base

Unassembled Part No. 70-3
Assembled Part No. 70-3-1

- **Separator 70-3**

For many thin cables
Separator with a narrow base for many thin cables side by side. Saves space in e-chains® and e-tubes.

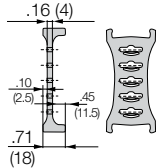

Separator, asymmetrical

Unassembled Part No. 70-4
Assembled Part No. 70-4-1

- **Separator 70-4**

For side mounted applications
Asymmetrical separator, for defined distance. No additional spacers necessary for e-chains® and e-tubes.

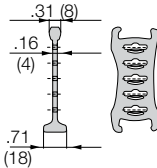

Separator, asymmetrical

Unassembled Part No. 70-5
Assembled Part No. 70-5-1

- **Separator 70-5**

Locks safely in .20" (5 mm) increments
Notch separator for exact positioning in e-chains®. Recommended for side-mounted applications.

Lockable full-width shelves - for the standard interior separation

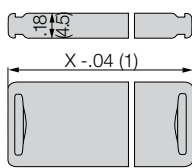

Full width shelf, lockable

Unassembled Part No. 520-X
Assembled Part No. 521-X

- **Full width shelf, lockable**

Shelf locks safely into separators on both ends, fixed width possible. Separators can be moved freely over the shelf in horizontal direction. Can be arranged at 5 different heights.

Internet: igus.com
email: sales@igus.com
QuickSpec: igus.com/quickspec

Width X in. (mm)	Part No. Unassembled	Part No. Assembled	Width X in. (mm)	Part No. Unassembled	Part No. Assembled	Width X in. (mm)	Part No. Unassembled	Part No. Assembled
1.97 (050)	520-50	521-50	5.91 (150)	520-150	521-150	11.81 (300)	520-300	521-300
2.56 (065)	520-65	521-65	6.89 (175)	520-175	521-175	13.78 (350)	520-350	521-350
2.95 (075)	520-75	521-75	7.87 (200)	520-200	521-200	14.76 (375)	520-375	521-375
3.94 (100)	520-100	521-100	8.86 (225)	520-225	521-225	15.24 (387)	520-387	521-387
4.92 (125)	520-125	521-125	9.84 (250)	520-250	521-250	17.723 (450)	520-450	521-450



Consult igus® for your extender crossbar applications. We will be happy to assist you with your design layout.

Extender crossbars - For careful guiding of large diameter cables and hoses

- Intended for cables and hoses with a maximum outer diameter of 9.64 in. (245 mm).
- Can be attached along either the inner or outer radius, inner radius preferred
- Gliding operation with crossbars assembled along the outer radius in conjunction with a special guide trough
- Gliding operation not guaranteed with crossbars assembled along the inner radius
- The extender crossbar can either be attached to the side links directly or can be used in combination with two standard snap-open crossbars.

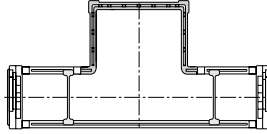

Square extender crossbar combined with standard snap-open crossbars.

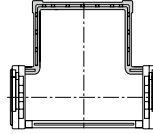

Attached directly to the side link.

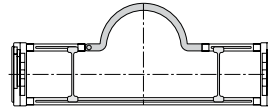

Round extender crossbar combined with standard snap-open crossbars.

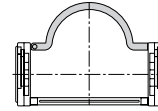

Attached directly to the side link.

Part No.	Max Ø Hose	Style	Installation Side Link	Combined with Snap-Open Crossbars
450-15-RHD115	4.52 (115)	Round	No	Yes
450-17-RD115	4.52 (115)	Round	Yes	No
450-25-D150	5.91 (150)	Square	Yes	No
450-30-D200	7.09 (180)	Square	Yes	No
450-35-D250	7.68 (195)	Square	Yes	No
450-40-D300	9.65 (245)	Square	Yes	No
450-20-HD150	5.91 (150)	Square	No	Yes
450-25-HD200	7.09 (180)	Square	No	Yes
450-30-HD250	7.68 (195)	Square	No	Yes

PDF: igus.com/e-chain-pdfs
 Product information: igus.com/e-chains



e-chain system® E4 light

Series 14550/14650/R19050

Strain Relief



14550
14650
R19050

Chainfix clamps for the profile rail

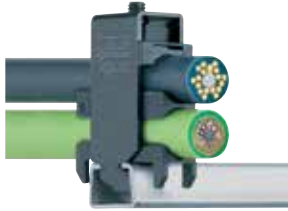

igus® Chainfix strain relief elements are available in either steel or stainless steel. They can be adjusted with a hexagon socket and are available in single, double and triple configurations.

Part No. Single Clamp		Part No. Double Clamp		Part No. Triple Clamp		Cable ø	
Steel	Stainless	Steel	Stainless	Steel	Stainless	in.	(mm)
CFX12-1	CFX12-1E	CFX12-2	CFX12-2E	CFX12-3	-	.24 - .47	(6 - 12)
CFX14-1	CFX14-1E	CFX14-2	CFX14-2E	CFX14-3	-	.47 - .55	(12 - 14)
CFX16-1	CFX16-1E	CFX16-2	CFX16-2E	CFX16-3	-	.55 - .63	(14 - 16)
CFX18-1	CFX18-1E	CFX18-2	CFX18-2E	CFX18-3	-	.63 - .71	(16 - 18)
CFX20-1	CFX20-1E	CFX20-2	CFX20-2E	CFX20-3	-	.71 - .79	(18 - 20)
CFX22-1	CFX22-1E	CFX22-2	CFX22-2E	CFX22-3	-	.79 - .87	(20 - 22)
CFX26-1	CFX26-1E	CFX26-2	CFX26-2E	-	-	.87 - 1.02	(22 - 26)
CFX30-1	CFX30-1E	CFX30-2	CFX30-2E	-	-	1.02 - 1.18	(26 - 30)
CFX34-1	CFX34-1E	CFX34-2	CFX34-2E	-	-	1.18 - 1.34	(30 - 34)
CFX38-1	CFX38-1E	-	-	-	-	1.34 - 1.50	(34 - 38)
CFX42-1	CFX42-1E	-	-	-	-	1.50 - 1.65	(38 - 42)

For more information please refer to strain relief section of Chapter 10

Tiewrap Plates

Option 1:

Tiewrap plates as an individual part

Available as an individual component, can be fixed onto a mounting bracket with the use of a profile rail.

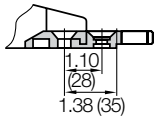

Shown assembled

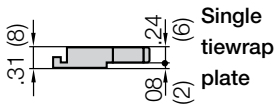

Single tiewrap plate

Tiewrap Plate	n Number of Teeth	C Overall Width in. (mm)	B Bore Width in. (mm)	Center Bore
3050-ZB	5	1.97 (50)	1.18 (30)	no
3075-ZB	7	2.95 (75)	2.16 (55)	no
3100-ZB	10	3.94 (100)	3.15 (80)	no
3115-ZB	11	4.53 (115)	3.74 (95)	no
3125-ZB	12	4.92 (125)	4.13 (105)	no
3150-ZB	15	5.91 (150)	5.12 (130)	no
3175-ZB	17	6.89 (175)	6.10 (155)	no
3200-ZB	20	7.87 (200)	7.09 (180)	yes
3225-ZB	22	8.86 (225)	8.07 (205)	yes
3250-ZB	25	9.84 (250)	9.06 (230)	yes

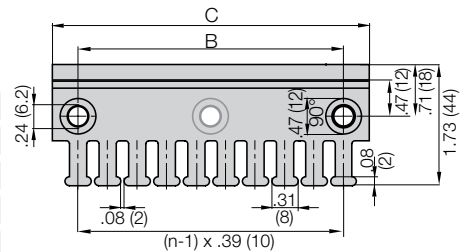

If used with KMA brackets with profile rail please add "KMA" to the end of the part number.

Example: 3050-ZBKMA

For more information please refer to strain relief section of Chapter 10

Option 2:

Clip-on Tiewrap plates

Available as a clip-on tiewrap plate without the use of bolts They are inserted and removed with a screwdriver used as a lever. Clip-on tiewrap plates are also available as an attachment to the opening crossbars.



Part No.	Number of Teeth	Width of Strain Relief in. (mm)
3050-ZC	5	1.97 (50)
3075-ZC	7	2.95 (75)

For more information please refer to strain relief section of Chapter 10

Option 3:

Clip-on Tiewrap plates for opening crossbars

Clip-on tiewrap plates are also available as an attachment to opening crossbars. They can be positioned at any point along the e-chain®.



Part No.	Number of Teeth	Width of Strain Relief in. (mm)
4550-ZS	5	1.89 (48)
4575-ZS	7	2.91 (74)

For more information please refer to strain relief section of Chapter 10

PDF: igus.com/e-chain-pdfs
Product information: igus.com/e-chains

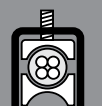

Width of Crossbar
14550-10-200-0

	B_{Ri}	Installation Part No.
-05	3.23 (82)	*
-06	3.82 (97)	*
-07	4.21 (107)	94-50-225
-08	4.69 (119)	94-50-250
-10	5.20 (132)	94-50-250
-11	5.67 (144)	94-50-275
-12	6.18 (157)	94-50-275
-13	6.65 (169)	94-50-300
-15	7.17 (182)	94-50-300
-16	7.64 (194)	94-50-325
-17	8.15 (207)	94-50-325
-18	8.62 (219)	94-50-350
-20	9.13 (232)	94-50-350
-21	9.61 (244)	94-50-375
-22	10.12 (257)	94-50-375
-23	10.59 (269)	94-50-400
-25	11.10 (282)	94-50-400
-26	11.57 (294)	94-50-425
-27	12.09 (307)	94-50-425
-28	12.56 (319)	94-50-450
-30	13.07 (332)	94-50-450
-31	13.54 (344)	94-50-475
-32	14.06 (357)	94-50-475
-33	14.53 (369)	94-50-500
-35	15.04 (382)	94-50-500
-36	15.51 (394)	94-50-525
-37	16.02 (407)	94-50-525
-38	16.50 (419)	94-50-550
-40	17.01 (432)	94-50-550
-41	17.48 (444)	94-50-575
-42	17.99 (457)	94-50-575
-43	18.46 (469)	94-50-600
-45	18.98 (482)	94-50-600
-46	19.45 (494)	94-50-625
-47	19.96 (507)	94-50-625
-48	20.43 (519)	94-50-650
-50	20.94 (532)	94-50-650
-51	21.42 (544)	94-50-675
-52	21.93 (557)	94-50-675
-53	22.40 (569)	94-50-700
-55	22.91 (582)	94-50-700
-60	24.88 (632)	94-50-750

Guide troughs are used with applications where the upper run of the e-chain® glides on the lower run. If using igus® steel guide troughs, the following components are required:

- Full travel length of guide trough
Part No. 94-14550-30
- 1/2 travel length glide bars
Part No. 93-01
- Installation sets as end connectors
Part No. 94-50-XX

.XX indicates the length of the profile rails on which the guide trough is mounted. The values and part numbers are specified in the table on the left. The standard length of the trough components and glide bars is 6.56 ft (2 m). The required overall length of the guide trough directly correlates to the length of travel.

Example:

Length of travel 164 ft (50 m)
Center mounted

Required guide troughs

164 ft (50 m) guide trough
82 ft (25 m) glide bars
= 25 sections of 6.56 ft (2 m) guide trough

Part No. 94-30

= 13 sections of 6.56 ft (2 m) glide bars

Part No. 93-01

Required number of installation sets:

= Number of guide trough components + 1
= 25 + 1 = 26

Part number of the installation sets

94-50-XXX

Example:

94-50-400 for 15.75 (400 mm) long profile rail



Left: Guide trough with glide bars
Right: Guide troughs without glide bars



Installation sets as section connectors

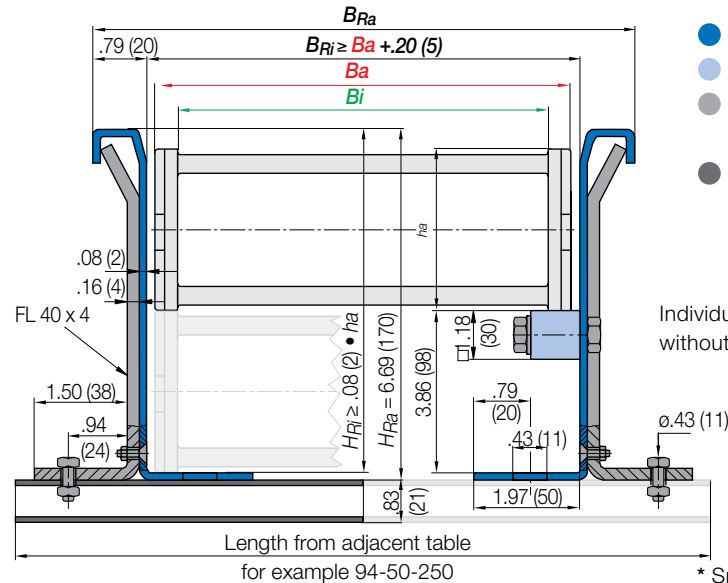

- Guide trough
- Glide bars
- Installation set "Basic"
- Profile rail

Individual attachment without profile rail

* Specialized guide trough available upon request

Standard length profile rail

PDF: igus.com/e-chain-pdfs
Product information: igus.com/e-chains



15050
15150
R19850



e-chain system® E4 light Series 15050/15150/R19850

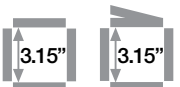

Price Index

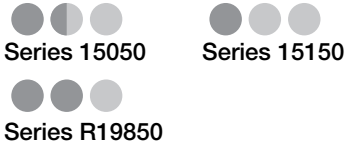

Special Features / Options

ESD classification:
Electrically conductive ESD/
ATEX version upon request

High torsional rigidity

Side-mounted - unsupported

Assembly Tips



Opening e-chains®: Remove crossbars and clips - Insert screwdriver into the slot, push down, release by lever action



Remove lids/bottoms (e-tubes) - Insert screwdriver into the slot, release by lever action

Other Installation Methods

Vertical, hanging ≤ 328 ft (100 m)

Vertical, standing ≤ 19.69 ft (6 m)

Side-mounted, un_supp. ≤ 6.56 ft (2 m)

Rotary requires further calculation

Usage Guidelines



- If a simpler low-cost solution is required
- For maximum inner width with minimal outer width
- If the Series 5050 is too large



- If side-mounted chain/tube with a long unsupported travel is required
➤ Series E4-80/H4-80/R4-80

Features & Benefits

- 1 KMA mounting brackets with attachment points on all sides
- 2 Crossbars on e-chains® are removable along both radii
- 3 Hinged snap-open removable lids along outer radius of e-tube
- 4 Lateral glide surfaces for side-mounted operation
- 5 Integrated strain relief possible
- 6 Closed and open styles can be combined
- 7 High torsional rigidity
- 8 Numerous interior separation possibilities
- 9 Tongue and groove design provides greater lateral stability
- 10 Wide, rounded plastic crossbars - cable friendly

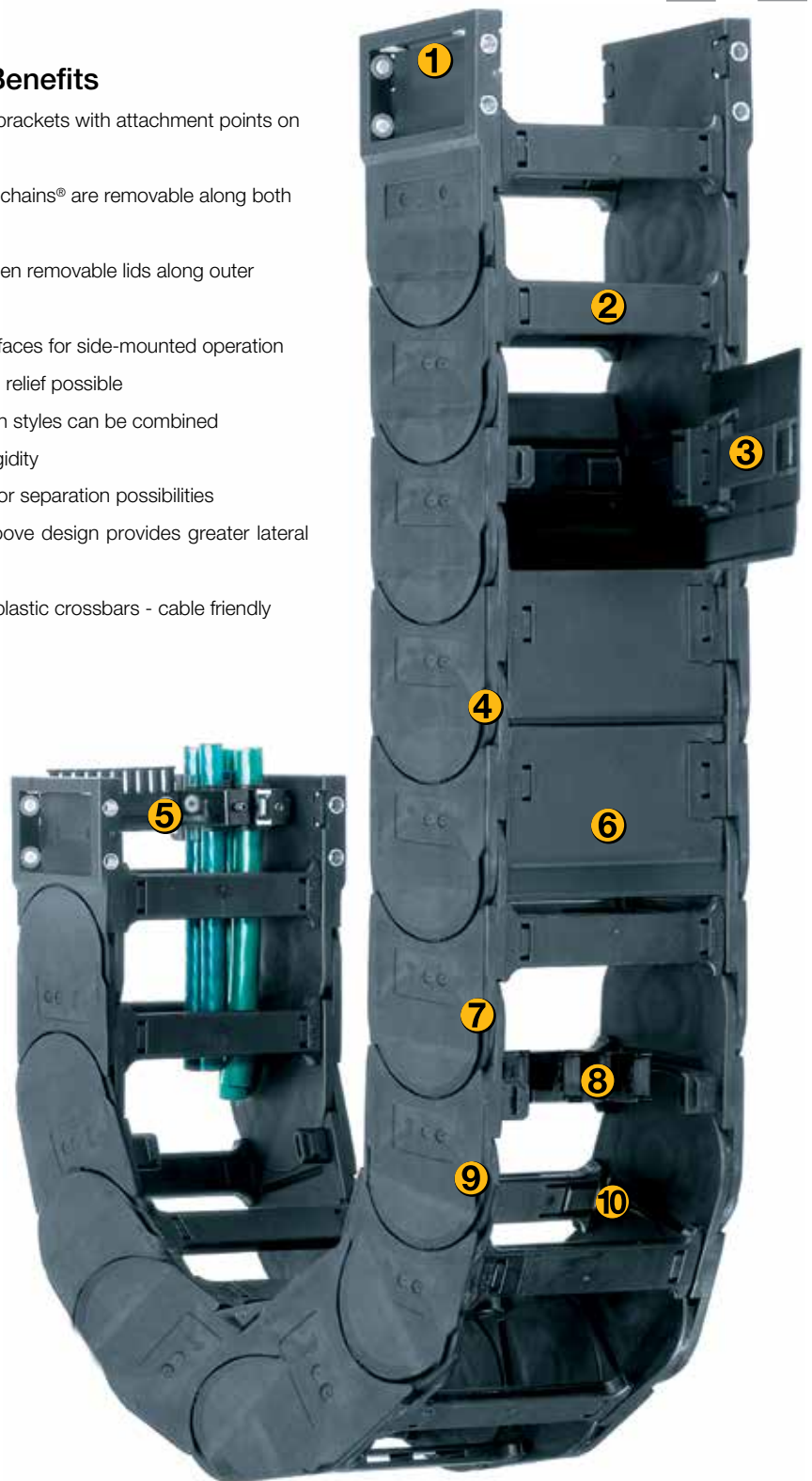

Order Example: Complete e-chain®

Please indicate chain length or number of links. Example:

16.4 ft (5 m) 15050-30-300-0



e-chain®

With 2 separators 80.1.1 assembled every 2nd link



Interior Separation

1 Set 150500-30-12P



Mounting Bracket

e-chain system® E4 light Series 15050/15150/R19850 Installation Dimensions

Short travel, unsupported length

- FL_B = unsupported with permitted sag
 - FL_G = unsupported with straight upper run
- Further information ► Design, Chapter 1

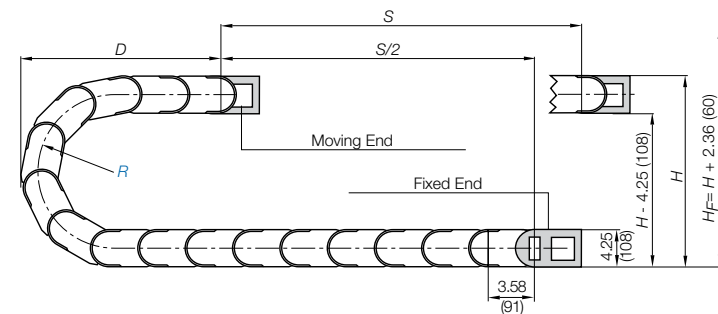
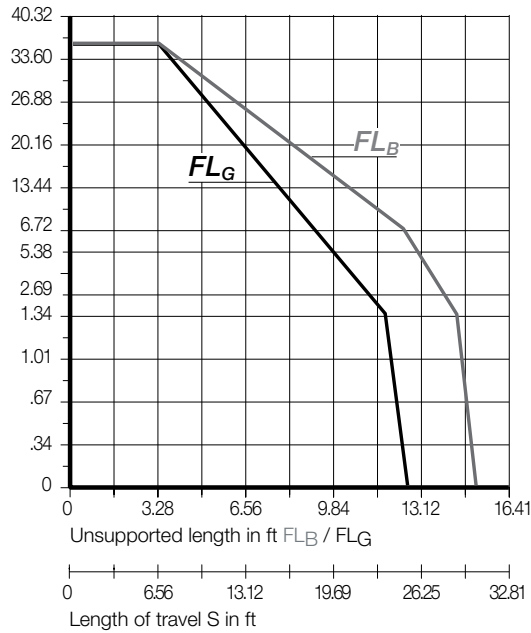
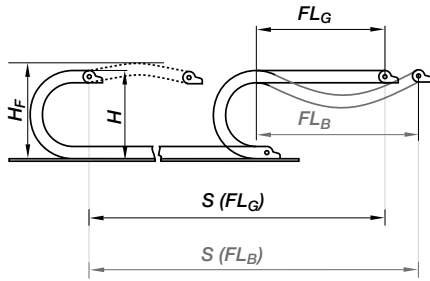

Pitch per link: = 3.58" (91 mm)
Links per ft (m): = 3.35 (11)
For center mount applications:
Chain length = $\frac{S}{2} + K$

The required clearance height: $H_F = H + 2.36$ in. (60 mm) (with 2.02 lbs/ft (3 kg/m) fill weight. Please consult igus® if space is particularly restricted.

R	5.91 (150)	7.87 (200)	9.84 (250)	11.81 (300)	13.78 (350)	15.75 (400)	19.68 (500)	23.62 (600)
H_{2s}	16.06 (408)	20.00 (508)	23.94 (608)	27.87 (708)	31.81 (808)	35.75 (908)	43.62 (1108)	51.50 (1308)
D	13.43 (341)	15.39 (391)	17.36 (441)	19.33 (491)	21.30 (541)	23.27 (591)	27.20 (691)	31.14 (791)
K	25.79 (655)	32.09 (815)	38.19 (970)	44.29 (1125)	50.59 (1285)	56.69 (1440)	69.09 (1755)	81.50 (2070)

For long travels with lowered mounting height

Long travel lengths from 32.8 ft.(10m) to max. 820 ft. (250m)

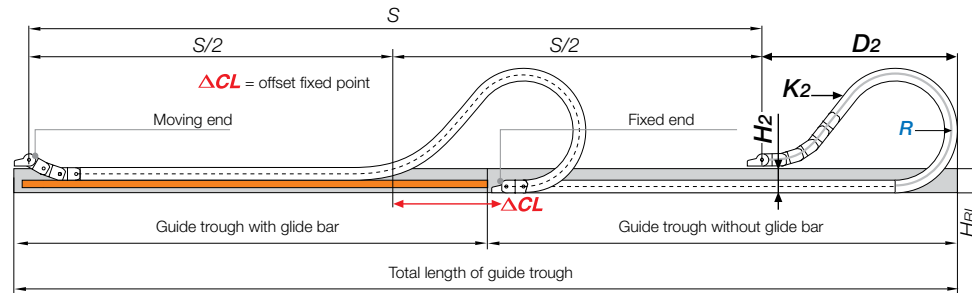

R	5.91 (150*)	7.87 (200)	9.84 (250)	11.81 (300)	13.78 (350)	15.75 (400)	19.68 (500)	23.62 (600 ¹⁾)
H_2	9.53 (242)	9.53 (242)	9.53 (242)	9.53 (242)	9.53 (242)	9.53 (242)	9.53 (242)	*
D_2^{+25}	21.65 (550)	31.50 (800)	37.40 (950)	47.24 (1200)	61.02 (1550)	66.93 (1700)	85.63 (2175)	*
K_2	35.83 (910)	50.16 (1274)	64.49 (1638)	78.82 (2002)	96.73 (2457)	107.48 (2730)	136.14 (3458)	*
ΔCL	8.23 (209)	16.10 (409)	20.04 (509)	27.91 (709)	39.72 (1009)	43.66 (1109)	58.42 (1484)	*

¹⁾ R 600 not suitable for long travel applications. Please consult igus®

Speed / acceleration FL_G	max. 65.6 ft/s (20 m/s) / max. 656 ft/s ² (200 m/s ²)
Speed / acceleration FL_B	max. 9.84 ft/s (3 m/s) / max. 19.69 ft/s ² (6 m/s ²)
Gliding speed / acceleration (maximum)	max. 32.8 ft/s (10 m/s) / max. 164 ft/s ² (50 m/s ²)
Material - permitted temperature	igumid G / -40°F (-40°C) up to +248°F (+120°C)
Flammability Class, igumid G	VDE 0304 IIC UL94 HB



15050
15150
R19850

Short Travels - Unsupported



Unsupported e-chains® feature positive camber over short travels. This must be accounted for when specifying the clearance height. Please refer to **Installation dimensions** for further details.

Legend

- S = Length of travel
 - R = Bending radius
 - H = Nominal clearance height
 - D = Overlength e-chain® radius in final position
 - $K = \pi \cdot R + \text{safety buffer}$
 - H_F = Required clearance height
 - H_{RI} = Trough inner height
 - H_2 = *Mounting height
 - D_2 = Overlength - long travels, gliding
 - K_2 = *Add-on
- *If the mounting bracket location is set lower



PDF: igus.com/e-chain-pdfs
Product information: igus.com/e-chains

Long Travels - Gliding



If the unsupported length is exceeded, the e-chain®/ Tube must glide on itself. This requires a guide trough.

Design, Chapter 1



For support of the lower run, see **Chapter 9** of the main catalog for the **Support Tray** tool kit

Technical Data



Details of material properties ► **Chapter 1**



Series 15050 - e-chain® with crossbars every link

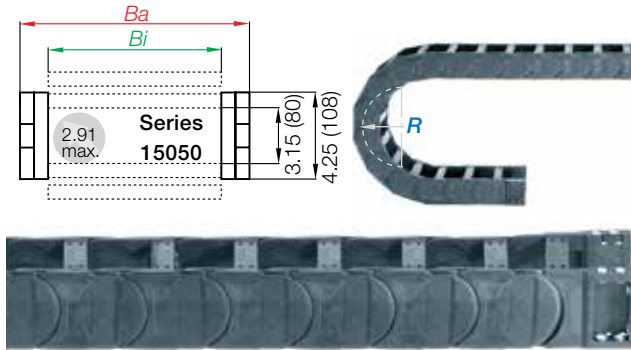

- Crossbars every link
- For use with rigid hydraulic hoses
- For particularly demanding applications
- Can be opened from both sides

Part Number Structure

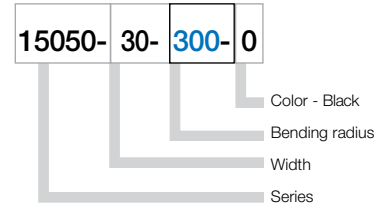

Series 15150 - e-chain® with crossbars every other link

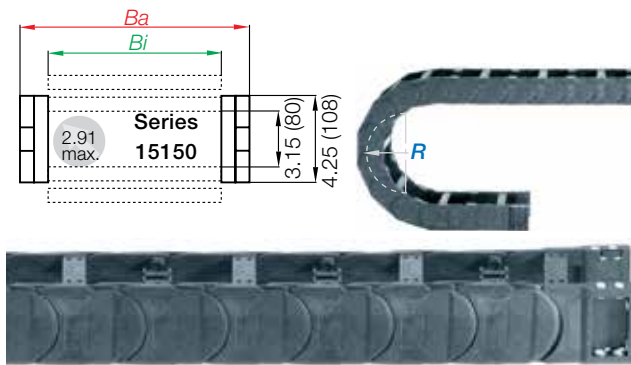

- Crossbars every other link - Standard configuration
- For nearly every situation
- Can be opened from both sides
- Easy assembly
- Stable
- Cost-effective

Part Number Structure

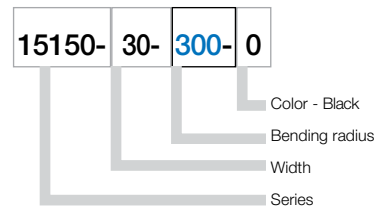

Series R19850 - fully enclosed e-tube

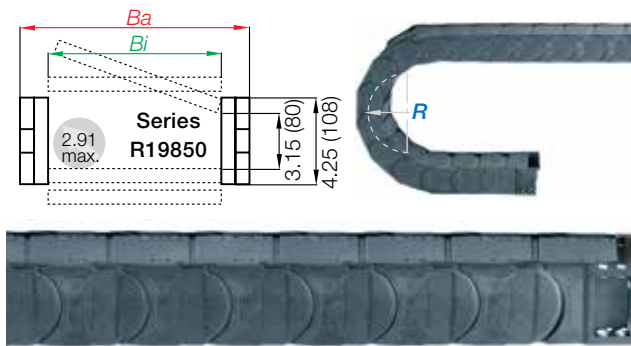

- Fully enclosed
- Excellent cable and hose protection against dirt
- Protection against hot chips
- Lids along inner radius are completely removable
- Lids along the outer radius are single-sided, snap open, hinged on one side as well as completely removable

Part Number Structure

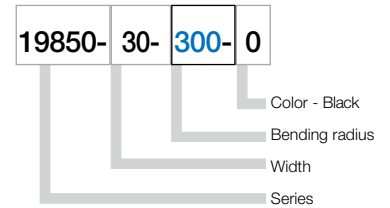

e-chain® as separate parts, links and side plates

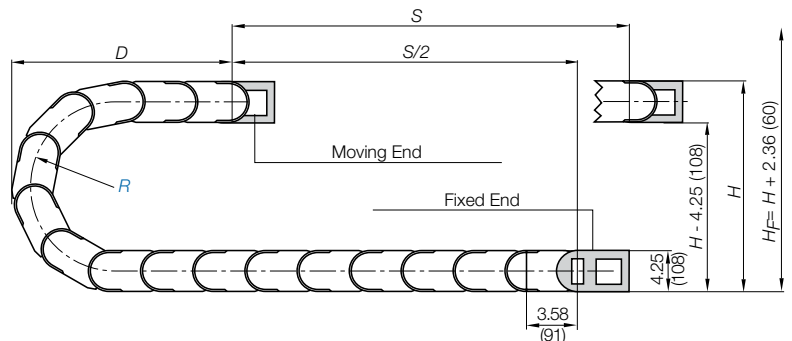
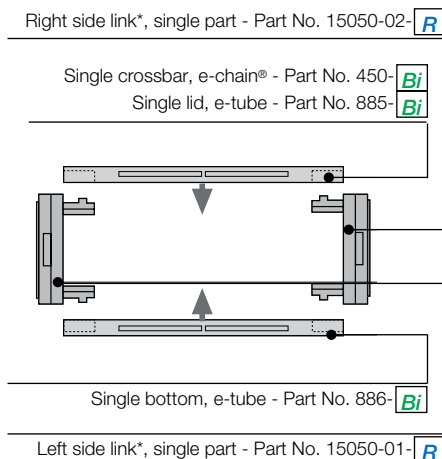

*View from the fixed point of the e-chain®/e-tube

e-chain system® E4 light

Series 15050/15150/R19850

Supplement part number with required radius. Example: 15050-30-300-0

Pitch: 3.58 in. (91mm) per link links/ft (m) = 3.35 (11)



15050
15150
R19850

PDF: igus.com/e-chain-pdfs
Product information: igus.com/e-chains

Part Number.			<i>Bi</i>	<i>Ba</i>	15050	15150	R19850
Crossbars Every link	Crossbars Every other	Tube Version	in. (mm)	in. (mm)	lbs/ft (kg/m)	lbs/ft (kg/m)	lbs/ft (kg/m)
15050-05-	15150-05-	<input type="checkbox"/> -0	1.97 (50)	3.15 (80)	≈2.59 (3.85)	≈ 2.58 (3.84)	-
15050-06-	15150-06-	<input type="checkbox"/> -0	2.56 (65)	3.74 (95)	≈2.65 (3.95)	≈ 2.61 (3.88)	-
15050-07-	15150-07-	19850-07- <input type="checkbox"/> -0*	2.95 (75)	4.13 (105)	≈2.69 (4.00)	≈ 2.63 (3.92)	≈ 3.00 (4.46)
15050-08-	15150-08-	<input type="checkbox"/> -0	3.43 (87)	4.61 (117)	≈ 2.72 (4.05)	≈ 2.66 (3.96)	-
15050-10-	15150-10-	19850-10- <input type="checkbox"/> -0	3.94 (100)	5.12 (130)	≈ 2.81 (4.18)	≈ 2.69 (4.00)	≈ 3.18 (4.74)
15050-11-	15150-11-	<input type="checkbox"/> -0	4.41 (112)	5.63 (143)	≈ 2.90 (4.31)	≈ 2.73 (4.07)	-
15050-12-	15150-12-	19850-12- <input type="checkbox"/> -0	4.92 (125)	6.10 (155)	≈ 2.94 (4.38)	≈ 2.76 (4.10)	≈ 3.43 (5.10)
15050-13-	15150-13-	<input type="checkbox"/> -0	5.39 (137)	6.61 (168)	≈ 3.03 (4.51)	≈ 2.80 (4.17)	-
15050-15-	15150-15-	19850-15- <input type="checkbox"/> -0	5.91 (150)	7.09 (180)	≈ 3.08 (4.58)	≈ 2.82 (4.20)	≈ 3.72 (5.53)
15050-16-	15150-16-	<input type="checkbox"/> -0	6.38 (162)	7.60 (193)	≈ 3.15 (4.69)	≈ 2.86 (4.26)	-
15050-17-	15150-17-	19850-17- <input type="checkbox"/> -0	6.89 (175)	8.07 (205)	≈ 3.23 (4.80)	≈ 2.90 (4.31)	≈ 3.95 (5.80)
15050-18-	15150-18-	<input type="checkbox"/> -0	7.36 (187)	8.58 (218)	≈ 3.30 (4.91)	≈ 2.94 (4.37)	-
15050-20-	15150-20-	19850-20- <input type="checkbox"/> -0	7.87 (200)	9.06 (230)	≈ 3.31 (4.93)	≈ 2.94 (4.38)	≈ 4.11 (6.11)
15050-21-	15150-21-	<input type="checkbox"/> -0	8.35 (212)	9.57 (243)	≈ 3.39 (5.04)	≈ 2.98 (4.43)	-
15050-22-	15150-22-	<input type="checkbox"/> -0	8.86 (225)	10.04 (255)	≈ 3.43 (5.10)	≈ 3.00 (4.47)	-
15050-23-	15150-23-	<input type="checkbox"/> -0	9.33 (237)	10.55 (268)	≈ 3.52 (5.24)	≈ 3.04 (4.53)	-
15050-25-	15150-25-	19850-25- <input type="checkbox"/> -0	9.84 (250)	11.02 (280)	≈ 3.57 (5.32)	≈ 3.08 (4.58)	≈ 4.59 (6.83)
15050-26-	15150-26-	<input type="checkbox"/> -0	10.31 (262)	11.54 (293)	≈ 3.64 (5.41)	≈ 3.10 (4.62)	-
15050-27-	15150-27-	19850-27- <input type="checkbox"/> -0	10.83 (275)	12.01 (305)	≈ 3.71 (5.52)	≈ 3.14 (4.68)	≈ 4.87 (7.26)
15050-28-	15150-28-	<input type="checkbox"/> -0	11.30 (287)	12.52 (318)	≈ 3.72 (5.54)	≈ 3.15 (4.69)	-
15050-30-	15150-30-	19850-30- <input type="checkbox"/> -0	11.81 (300)	12.99 (330)	≈ 3.87 (5.76)	≈ 3.23 (4.80)	≈ 5.03 (7.49)
15050-31-	15150-31-	<input type="checkbox"/> -0	12.28 (312)	13.50 (343)	≈ 3.90 (5.80)	≈ 3.24 (4.82)	-
15050-32-	15150-32-	<input type="checkbox"/> -0	12.79 (325)	13.98 (355)	≈ 3.93 (5.85)	≈ 3.25 (4.84)	-
15050-33-	15150-33-	<input type="checkbox"/> -0	13.27 (337)	14.49 (368)	≈ 4.05 (6.03)	≈ 3.31 (4.93)	-
15050-35-	15150-35-	19850-35- <input type="checkbox"/> -0	13.78 (350)	14.96 (380)	≈ 4.15 (6.18)	≈ 3.37 (5.01)	≈ 5.54 (8.24)
15050-36-	15150-36-	<input type="checkbox"/> -0	14.25 (362)	15.47 (393)	≈ 4.16 (6.19)	≈ 3.37 (5.02)	-
15050-37-	15150-37-	<input type="checkbox"/> -0	14.76 (375)	15.94 (405)	≈ 4.17 (6.20)	≈ 3.37 (5.02)	-
15050-38-	15150-38-	<input type="checkbox"/> -0	15.24 (387)	16.46 (418)	≈ 4.23 (6.29)	≈ 3.40 (5.06)	-
15050-40-	15150-40-	19850-40- <input type="checkbox"/> -0	15.75 (400)	16.93 (430)	≈ 4.36 (6.49)	≈ 3.47 (5.16)	≈ 6.18 (9.20)
15050-41-	15150-41-	<input type="checkbox"/> -0	16.22 (412)	17.44 (443)	≈ 4.46 (6.64)	≈ 3.52 (5.24)	-
15050-42-	15150-42-	<input type="checkbox"/> -0	16.73 (425)	17.91 (455)	≈ 4.57 (6.80)	≈ 3.57 (5.31)	-
15050-43-	15150-43-	<input type="checkbox"/> -0	17.20 (437)	18.43 (468)	≈ 4.61 (6.86)	≈ 3.60 (5.35)	-
15050-45-	15150-45-	<input type="checkbox"/> -0	17.72 (450)	18.90 (480)	≈ 4.66 (6.93)	≈ 3.62 (5.38)	-
15050-46-	15150-46-	19850-46- <input type="checkbox"/> -0	18.19 (462)	19.41 (493)	≈ 4.67 (6.95)	≈ 3.62 (5.39)	≈ 6.49 (9.66)
15050-47-	15150-47-	<input type="checkbox"/> -0	18.70 (475)	19.88 (505)	≈ 4.76 (7.08)	≈ 3.67 (5.46)	-
15050-48-	15150-48-	<input type="checkbox"/> -0	19.17 (487)	20.39 (518)	≈ 4.81 (7.16)	≈ 3.69 (5.49)	-
15050-50-	15150-50-	<input type="checkbox"/> -0	19.69 (500)	20.87 (530)	≈ 4.85 (7.22)	≈ 3.71 (5.52)	-
15050-51-	15150-51-	<input type="checkbox"/> -0	20.16 (512)	21.38 (543)	≈ 4.87 (7.24)	≈ 3.72 (5.53)	-
15050-52-	15150-52-	<input type="checkbox"/> -0	20.67 (525)	21.85 (555)	≈ 4.89 (7.28)	≈ 3.74 (5.56)	-
15050-53-	15150-53-	<input type="checkbox"/> -0	21.14 (537)	22.36 (568)	≈ 5.00 (7.44)	≈ 3.78 (5.63)	-
15050-55-	15150-55-	<input type="checkbox"/> -0	21.65 (550)	22.83 (580)	≈ 5.32 (7.92)	≈ 3.94 (5.87)	-
15050-60-	15150-60-	<input type="checkbox"/> -0	23.62 (600)	24.80 (630)	≈ 5.46 (8.12)	≈ 4.01 (5.97)	-

Choose from the radii below for all of the above sizes

Radius (mm) Example: 15050-30-300-0

	150**	200	250	300	350	400	500
<i>R</i>	5.91 (150)	7.87 (200)	9.84 (250)	11.81 (300)	13.78 (350)	15.75 (400)	19.68 (500)
<i>H</i> ₂₅	16.14 (410)	20.08 (510)	24.02 (610)	27.95 (710)	31.89 (810)	35.83 (910)	43.70 (1110)
<i>D</i>	11.81 (300)	13.78 (350)	15.75 (400)	17.72 (450)	19.69 (500)	21.65 (550)	25.59 (650)
<i>K</i>	29.53 (750)	35.43 (900)	41.34 (1050)	48.23 (1225)	54.13 (1375)	57.09 (1450)	65.94 (1675)

** This radius is not available for the R19850 Series

* Removable lid only, no hinged option

0=Standard color black. For other colors see Chapter 1

For wider chains see page 6.234 For large diameter hoses see page 6.234



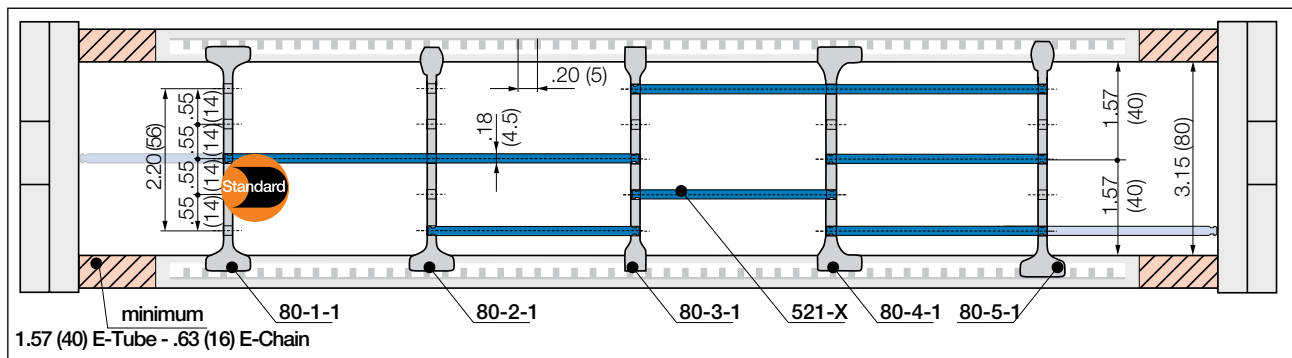

Note Please maintain a lateral spacing of 1.57" (40 mm) for e-tube and .63" (16 mm) for e-chains® between the separators and the side links. In the standard configuration separators are assembled every 2nd e-chain® link

Telephone 1-800-521-2747

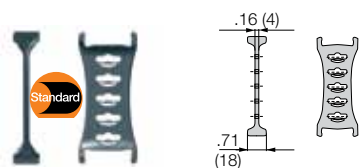

Separator, wide base

Unassembled	Part No. 80-1
Assembled	Part No. 80-1-1

- **Standard separator 80-1 for all applications**
Separator with wide base for maximum locking strength and safe standing in e-chains®.

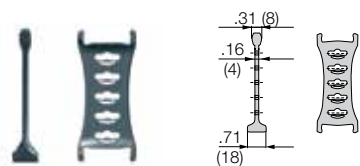

Separator, narrow head

Unassembled	Part No. 80-2
Assembled	Part No. 80-2-1

- **Separator 80-2 For even faster installation**
is used when vertical and horizontal separation is required. Due to its slot, it allows basic vertical/horizontal shelving arrangements.

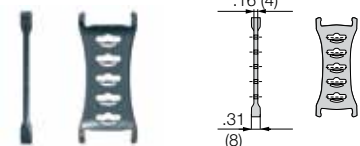

Separator, narrow base

Unassembled	Part No. 80-3
Assembled	Part No. 80-3-1

- **Separator 80-3 For many thin cables**
is used when vertical and horizontal separation is required. Due to its slot, it allows basic vertical/horizontal shelving arrangements.

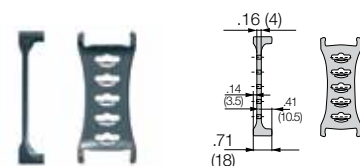

Separator, asymmetrical

Unassembled	Part No. 80-4
Assembled	Part No. 80-4-1

- **Separator 80-4 For side mounted applications**
is used when vertical and horizontal separation is required. Due to its slot, it allows basic vertical/horizontal shelving arrangements.

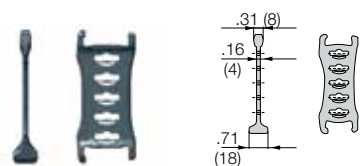

Separator, asymmetrical

Unassembled	Part No. 80-5
Assembled	Part No. 80-5-1

- **Separator 80-5 Locks safely in .30" (7.5 mm) increments**
Notch separator for exact positioning in e-chains®, Recommended for side-mounted applications.

Lockable full-width shelves - for the standard interior separation

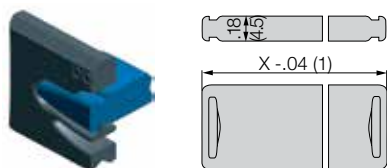

Full width shelf, lockable

Unassembled	Part No. 520-X
Assembled	Part No. 521-X

- **Full width shelf, lockable**
Shelf locks safely into separators on both ends, fixed width possible. Separators can be moved freely over the shelf in horizontal direction. Can be arranged at 5 different heights.

Width X in. (mm)	Part No. Unassembled	Part No. Assembled	Width X in. (mm)	Part No. Unassembled	Part No. Assembled	Width X in. (mm)	Part No. Unassembled	Part No. Assembled
1.97 (050)	520-50	521-50	5.91 (150)	520-150	521-150	11.81 (300)	520-300	521-300
2.56 (065)	520-65	521-65	6.89 (175)	520-175	521-175	13.78 (350)	520-350	521-350
2.95 (075)	520-75	521-75	7.87 (200)	520-200	521-200	14.76 (375)	520-375	521-375
3.94 (100)	520-100	521-100	8.86 (225)	520-225	521-225	15.24 (387)	520-387	521-387
4.92 (125)	520-125	521-125	9.84 (250)	520-250	521-250	17.723 (450)	520-450	521-450

e-chain system® E4 light

Series 15050/15150/R19850

Interior Separation - Previous Generation



15050
15150
R19850



Option 1: Vertical separators and spacers

Vertical separators are used if a vertical subdivision of the e-chain® interior is required. By standard, vertical separators are assembled every other e-chain® link.

NOTE: Observe a lateral spacing of at least 1.30 in. (33mm) for e-tubes and .63 in. (16mm) for e-chain®. There is no minimum spacing needed for side plates

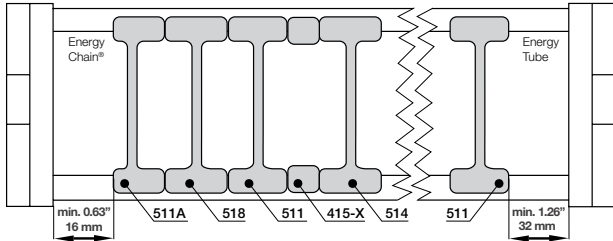

STANDARD
Vertical separator
501

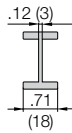

Vertical separator

Unassembled	Part No. 501
Assembled	Part No. 511

- **Standard separator 501 for e-chains® and e-tubes**
This separator offers safe stability due to its wide base design, also when used with thick cables or hoses.



Locking separator
504

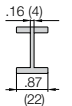

Locking separator (chain only)

Unassembled	Part No. 504
Assembled	Part No. 514

- **Locking separator 504 for e-chains®**
This separator features increased retention force for applications exposed to very high humidity and extreme loads. If locking separators are used, the e-chain® is more difficult to open.



Locking separator
508

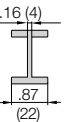

Locking separator (chain only)

Unassembled	Part No. 508
Assembled	Part No. 518

- **Locking separator 508 for e-chains®**
This separator is used for applications that are exposed to extremely high humidity. The clamp at the side serves to uniformly align the separators. In order to avoid destroying the separators when opening the e-chain®, make sure all separators are identically aligned.



Asymmetric separator
501A

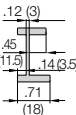

Asymmetrical separator (chain only)

Unassembled	Part No. 501A
Assembled	Part No. 511A

- **Asymmetrical separator 501A for e-chains®**
This separator features an (18mm) base. It can be used in combinations between spacers of different widths and vertical separators in side mounted applications.



Spacers
405-XX



Spacer (chain only)

Unassembled	Part No. 405-XX
Assembled	Part No. 415-XX

XX = width of the spacer

- **NOTE ON SPACERS**
Vertical separators are adjustable, but can be fixed in position by means of a spacer. Spacers are most often necessary for side mounted applications. The available inner height is reduced by .08" (2mm) per spacer (for example if one spacer is placed on either side of the separator, the overall inner height is reduced by .16" (4mm). To avoid this, place the spacers on the **outside** of the opening crossbar (not for long travels).

Spacers available in the following sizes:

Part No. Unassembled	Part No. Assembled	in.	(mm)
405 -10	415 -10	.39"	(10)
405 -15	415 -15	.59"	(15)
405 -20	415 -20	.79"	(20)
405 -30	415 -30	1.18"	(30)
405 -40	415 -40	1.57"	(40)



PDF: igus.com/e-chain-pdfs
Product information: igus.com/e-chains



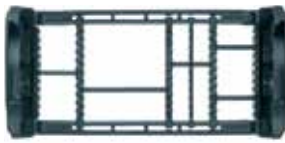

Option 2: Shelves

e-chains® and e-tubes can be subdivided both vertically and horizontally using the various interior separation elements.

► **Design, Chapter 1** for layout recommendations.

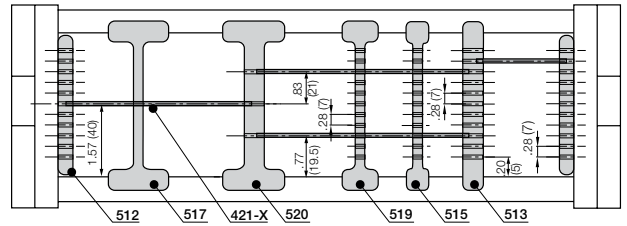

• **Side plates 502**

This component is used to form the basic pattern of a shelf system.

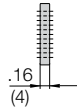

Side plate

Unassembled	Part No. 502
Assembled	Part No. 512

Side plate 502



• **Vertical separator 503**

This component is used to form the basic pattern of a shelf system.

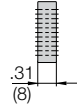

Vertical separator

Unassembled	Part No. 503
Assembled	Part No. 513

Vertical separator 503



• **Locking vertical separator 507**

This separator features increased retention force for applications exposed to very high humidity and extreme loads. The extra retention force is achieved by asymmetric claws for the crossbar. Take care to ensure proper alignment.

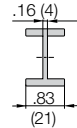

Locking vertical separator

Unassembled	Part No. 507
Assembled	Part No. 517

Locking vertical separator 507



• **Locking vertical separator 510**

This separator is slotted and able to be combined with shelves. For e-chains® only.

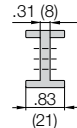

Locking vertical separator

Unassembled	Part No. 510
Assembled	Part No. 520

Locking vertical separator 510



• **Slotted separators 505**

These are used for very complex subdivisions. However, they cannot be retrofitted into an existing separation system without removing the shelves first.

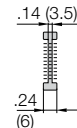

Slotted separators, closed

Unassembled	Part No. 505
Assembled	Part No. 515

Closed slotted separator 505



• **Slotted separator 509**

This separator can be retrofitted into an existing interior separation system without removing the shelves, as long as these shelves fit into any of the 7 middle slots

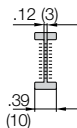

Slotted separators, open

Unassembled	Part No. 509
Assembled	Part No. 519

Open slotted separator 509



Shelves 420-XX

These components form the basic pattern of a shelf system. Shelves of various widths can be arranged at 7 different heights in .28" (7mm) increments

Width X in. (mm)	Usable Width in. (mm)	Part No. Unassembled	Part No. Assembled	Width X in. (mm)	Usable Width in. (mm)	Part No. Unassembled	Part No. Assembled
.71 (18)	.39 (10)	420-18	421-18	2.95 (75)	2.64 (67)	420-75	421-75
.91 (23)	.59 (15)	420-23	421-23	3.46 (88)	3.15 (80)	420-88	421-88
.98 (25)	.67 (17)	420-25	421-25	3.94 (100)	3.62 (92)	420-100	421-100
1.10 (28)	.79 (20)	420-28	421-28	4.92 (125)	4.61(117)	420-125	421-125
1.30 (33)	.98 (25)	420-33	421-33	5.91 (150)	5.59(142)	420-150	421-150
1.69 (43)	1.38 (35)	420-43	421-43	6.89 (175)	6.57(167)	420-175	421-175
1.97 (50)	1.65 (42)	420-50	421-50	7.36 (187)	7.05(179)	420-187	421-187
2.44 (62)	2.13 (54)	420-62	421-62	7.87 (200)	7.56(192)	420-200	421-200

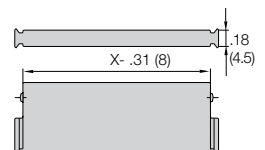

Rollclip - minimizes abrasion of particularly sensitive hoses or cables in an e-chain®. The integrated rollers compensate for relative movement between the chain and the hose or cable. This reduces the abrasion of the hoses or cables

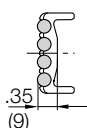

Rollclip

Unassembled	Part No. 489-27
Assembled	Part No. 490-27

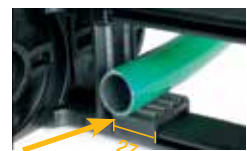



Extension links - for extremely wide e-chains® up to 9.84 ft (3m)

- For applications in which particularly high fill weights necessitate extremely wide e-chains®
- The extension link design allows virtually limitless side-by-side attachment of chains
- The unsupported length of a chain can be increased when additional loads are required
- Extension links can be used with e-chains®, e-tubes or a combination of both
- They are suitable for unsupported and gliding applications in a guide trough
- e-chains® with extension links are attached with KMA or steel mounting brackets.

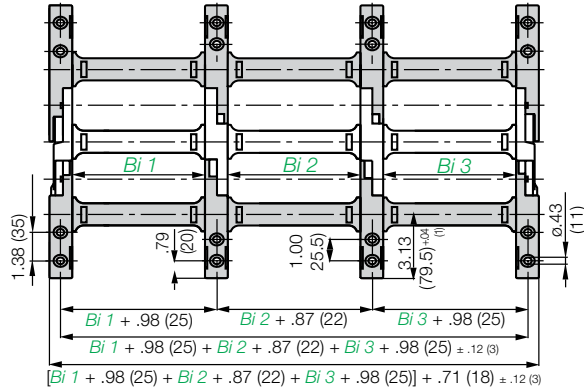

Part number example for e-chain®

15050-10/20/10-200-0

15050-*Bi1/Bi2/Bi3*-R-0

We **strongly recommend** on-site consultation with an igus® technician for individual advice regarding mounting brackets, guide troughs and other design details.



Consult igus® for your extender crossbar applications. We will be happy to assist you with your design layout.

Extender crossbars - For careful guiding of large diameter cables and hoses

- Intended for cables and hoses with a maximum outer diameter of 10.63 in. (270 mm).
- Can be attached along either the inner or outer radius, inner radius preferred
- Gliding operation with crossbars assembled along the outer radius in conjunction with a special guide trough
- Gliding operation not guaranteed with crossbars assembled along the inner radius
- The extender crossbar can either be attached to the side links directly or can be used in combination with two standard snap-open crossbars.

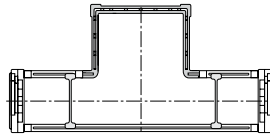

Square extender crossbar combined with standard snap-open crossbars.

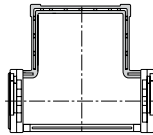

Attached directly to the side link.

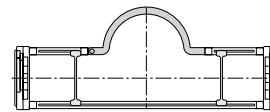

Round extender crossbar combined with standard snap-open crossbars.

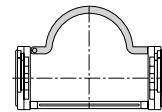

Attached directly to the side link.

Part No.	Max Ø Hose	Style	Installation Side Link	Combined with Snap-Open Crossbars
450-15-RHD115	4.52 (115)	Round	No	Yes
450-17-RD115	4.52 (115)	Round	Yes	No
450-25-D150	5.91 (150)	Square	Yes	No
450-30-D200	7.09 (180)	Square	Yes	No
450-35-D250	7.68 (195)	Square	Yes	No
450-40-D300	9.65 (245)	Square	Yes	No
450-20-HD150	5.91 (150)	Square	No	Yes
450-25-HD200	7.09 (180)	Square	No	Yes
450-30-HD250	7.68 (195)	Square	No	Yes

E4 clip on cable binder

- For side mounted applications
- Serves as a clip-on, lateral guide for hoses and cables on e-chains®
- The loops can be adjusted as needed

- Compatible with many E4 e-chains®
- Economical
- One clip and one locking band are needed for each chain link



Part No.	Form
450-B12	Locking clip, comprised of a locking element
450-B12-200	Locking band, comprised of a locking element and band; 12 x 1.5 x 200 mm



e-chain system® E4 light

Series 15050/15150/R19850

Mounting Brackets - Steel



15050
15150
R19850

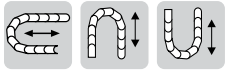

Option 1: pivoting

- For pivoting connections
- One part for all chain widths
- Electrically conductive

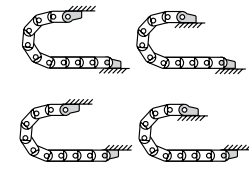
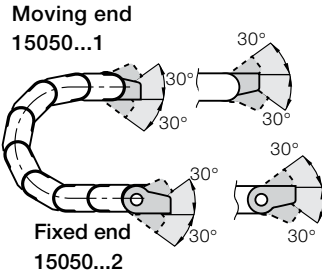

Possible installation configurations -

Part No. Mounting Brackets Full Set

4 parts, 2 with pin, 2 with bore
Series 15050, 15150 or R19850:
15050-12

Part No. Mounting Bracket Moving End

2 parts, 1 left & 1 right with bore
Series 15050, 15150 or R19850:
15050-1

Part No. Mounting Bracket Fixed End

2 parts, 1 left & 1 right with pin
Series 15050, 15150 or R19850:
15050-2

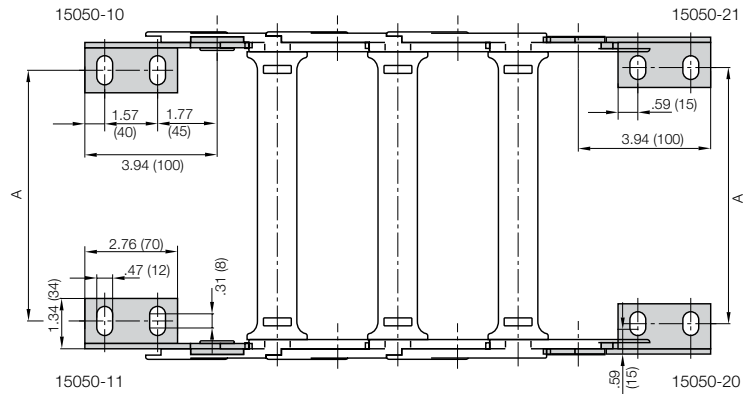

Bracket Mounting Dimensions

Width of Chain <i>Bi</i>	Part Number	Mounting Brackets			Mounting Dimension A in. (mm)	Width of Chain <i>Bi</i>	Part Number	Mounting Brackets			Mounting Dimension A in. (mm)
		Full Set	Moving End Only	Fixed End Only				Full Set	Moving End Only	Fixed End Only	
1.97 (50)	15050	-12	-1	-2	1.02 (26)	12.79 (325)	15050	-12	-1	-2	11.85 (301)
2.56 (65)	15050	-12	-1	-2	1.61 (41)	13.27 (337)	15050	-12	-1	-2	12.32 (313)
2.95 (75)	15050	-12	-1	-2	2.01 (51)	13.78 (350)	15050	-12	-1	-2	12.83 (326)
3.94 (100)	15050	-12	-1	-2	2.99 (76)	14.25 (362)	15050	-12	-1	-2	15.28 (388)
4.41 (112)	15050	-12	-1	-2	3.46 (88)	14.76 (375)	15050	-12	-1	-2	13.82 (351)
4.92 (125)	15050	-12	-1	-2	3.98 (101)	15.24 (387)	15050	-12	-1	-2	14.29 (363)
5.39 (137)	15050	-12	-1	-2	4.45 (113)	15.75 (400)	15050	-12	-1	-2	14.80 (376)
5.91 (150)	15050	-12	-1	-2	4.96 (126)	16.22 (412)	15050	-12	-1	-2	15.28 (388)
6.38 (162)	15050	-12	-1	-2	5.43 (138)	16.73 (425)	15050	-12	-1	-2	15.79 (401)
6.89 (175)	15050	-12	-1	-2	5.94 (151)	17.20 (437)	15050	-12	-1	-2	16.26 (413)
7.36 (187)	15050	-12	-1	-2	6.42 (163)	17.72 (450)	15050	-12	-1	-2	16.77 (426)
7.87 (200)	15050	-12	-1	-2	6.93 (176)	18.19 (462)	15050	-12	-1	-2	17.24 (438)
8.35 (212)	15050	-12	-1	-2	7.40 (188)	18.70 (475)	15050	-12	-1	-2	17.76 (451)
8.86 (225)	15050	-12	-1	-2	7.91 (201)	19.17 (487)	15050	-12	-1	-2	18.23 (463)
9.33 (237)	15050	-12	-1	-2	8.39 (213)	19.69 (500)	15050	-12	-1	-2	18.74 (476)
9.84 (250)	15050	-12	-1	-2	8.90 (226)	20.16 (512)	15050	-12	-1	-2	19.21 (488)
10.31 (262)	15050	-12	-1	-2	9.37 (238)	20.67 (525)	15050	-12	-1	-2	19.72 (501)
10.83 (275)	15050	-12	-1	-2	9.88 (251)	21.14 (537)	15050	-12	-1	-2	20.20 (513)
11.30 (287)	15050	-12	-1	-2	10.35 (263)	21.65 (550)	15050	-12	-1	-2	20.71 (526)
11.81 (300)	15050	-12	-1	-2	10.87 (276)	23.62 (600)	15050	-12	-1	-2	22.68 (576)
12.28 (312)	15050	-12	-1	-2	11.34 (288)						

PDF: igus.com/e-chain-pdfs
Product information: igus.com/e-chains

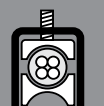

Chainfix clamps for the profile rail



igus® Chainfix strain relief elements are available in either steel or stainless steel. They can be adjusted with a hexagon socket and are available in single, double and triple configurations.

Part No. Single Clamp		Part No. Double Clamp		Part No. Triple Clamp		Cable ø	
Steel	Stainless	Steel	Stainless	Steel	Stainless	in.	(mm)
CFX12-1	CFX12-1E	CFX12-2	CFX12-2E	CFX12-3	-	.24 - .47	(6 - 12)
CFX14-1	CFX14-1E	CFX14-2	CFX14-2E	CFX14-3	-	.47 - .55	(12 - 14)
CFX16-1	CFX16-1E	CFX16-2	CFX16-2E	CFX16-3	-	.55 - .63	(14 - 16)
CFX18-1	CFX18-1E	CFX18-2	CFX18-2E	CFX18-3	-	.63 - .71	(16 - 18)
CFX20-1	CFX20-1E	CFX20-2	CFX20-2E	CFX20-3	-	.71 - .79	(18 - 20)
CFX22-1	CFX22-1E	CFX22-2	CFX22-2E	CFX22-3	-	.79 - .87	(20 - 22)
CFX26-1	CFX26-1E	CFX26-2	CFX26-2E	-	-	.87 - 1.02	(22 - 26)
CFX30-1	CFX30-1E	CFX30-2	CFX30-2E	-	-	1.02 - 1.18	(26 - 30)
CFX34-1	CFX34-1E	CFX34-2	CFX34-2E	-	-	1.18 - 1.34	(30 - 34)
CFX38-1	CFX38-1E	-	-	-	-	1.34 - 1.50	(34 - 38)
CFX42-1	CFX42-1E	-	-	-	-	1.50 - 1.65	(38 - 42)

For more information please refer to strain relief section of Chapter 10

Tiewrap Plates

Option 1:

Tiewrap plates as an individual part

Available as an individual component, can be fixed onto a mounting bracket with the use of a profile rail.

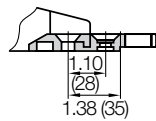

Shown assembled

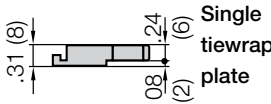

Single tiewrap plate

Tiewrap Plate	n Number of Teeth	C Overall Width in. (mm)	B Bore Width in. (mm)	Center Bore
3050-ZB	5	1.97 (50)	1.18 (30)	no
3075-ZB	7	2.95 (75)	2.16 (55)	no
3100-ZB	10	3.94 (100)	3.15 (80)	no
3115-ZB	11	4.53 (115)	3.74 (95)	no
3125-ZB	12	4.92 (125)	4.13 (105)	no
3150-ZB	15	5.91 (150)	5.12 (130)	no
3175-ZB	17	6.89 (175)	6.10 (155)	no
3200-ZB	20	7.87 (200)	7.09 (180)	yes
3225-ZB	22	8.86 (225)	8.07 (205)	yes
3250-ZB	25	9.84 (250)	9.06 (230)	yes

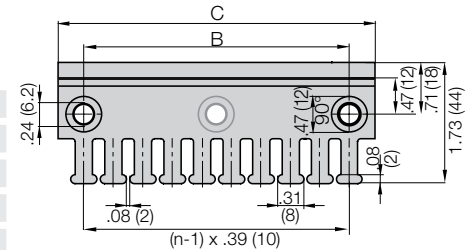

If used with KMA brackets with profile rail please add "KMA" to the end of the part number.

Example: 3050-ZBKMA

For more information please refer to strain relief section of Chapter 10

Option 2:

Clip-on Tiewrap plates

Available as a clip-on tiewrap plate without the use of bolts They are inserted and removed with a screwdriver used as a lever. Clip-on tiewrap plates are also available as an attachment to the opening crossbars.



Part No.	Number of Teeth	Width of Strain Relief in. (mm)
3050-ZC	5	1.97 (50)
3075-ZC	7	2.95 (75)

For more information please refer to strain relief section of Chapter 10

Option 3:

Clip-on Tiewrap plates for opening crossbars

Clip-on tiewrap plates are also available as an attachment to opening crossbars. They can be positioned at any point along the e-chain®.



Part No.	Number of Teeth	Width of Strain Relief in. (mm)
4550-ZS	5	1.89 (48)
4575-ZS	7	2.91 (74)

For more information please refer to strain relief section of Chapter 10

e-chain system® E4 light

Series 15050/15150/R19850

Guide Trough



15050
15150
R19850

Width of Crossbar
15050-05-200-0

	B_{Ri}	
-05	3.35 (85)	*
-07	4.33 (110)	96-50-225
-10	5.31 (135)	96-50-250
-11	5.83 (148)	96-50-275
-12	6.30 (160)	96-50-275
-13	6.81 (173)	96-50-300
-15	7.28 (185)	96-50-300
-16	7.80 (198)	96-50-325
-17	8.27 (210)	96-50-325
-18	8.78 (223)	96-50-350
-20	9.25 (235)	96-50-350
-21	9.76 (248)	96-50-375
-22	10.24 (260)	96-50-375
-23	10.75 (273)	96-50-400
-25	11.22 (285)	96-50-400
-26	11.73 (298)	96-50-425
-27	12.20 (310)	96-50-425
-28	12.72 (323)	96-50-450
-30	13.19 (335)	96-50-450
-31	13.70 (348)	96-50-475
-32	14.17 (360)	96-50-475
-33	14.69 (373)	96-50-500
-35	15.16 (385)	96-50-500
-36	15.67 (398)	96-50-525
-37	16.14 (410)	96-50-525
-38	16.65 (423)	96-50-550
-40	17.13 (435)	96-50-550
-41	17.63 (448)	96-50-575
-42	18.11 (460)	96-50-575
-43	18.62 (473)	96-50-600
-45	19.09 (485)	96-50-600
-46	19.61 (498)	96-50-625
-47	20.08 (510)	96-50-625
-48	20.59 (523)	96-50-650
-50	21.06 (535)	96-50-650
-51	21.57 (548)	96-50-675
-52	22.04 (560)	96-50-675
-53	22.56 (573)	96-50-700
-55	23.03 (585)	96-50-700
-60	25.00 (635)	96-50-750

Guide troughs are used with applications where the upper run of the e-chain® glides on the lower run. If using igus® steel guide troughs, the following components are required:

- Full travel length of guide trough
Part No. 99-30
- 1/2 travel length glide bars
Part No. 93-01
- Installation sets as end connectors
Part No. 96-50-XX

-XX indicates the length of the profile rails on which the guide trough is mounted. The values and part numbers are specified in the table on the left. The standard length of the trough components and glide bars is 6.56 ft (2 m). The overall length of the guide trough directly correlates to the length of travel.

Example:

Length of travel 164 ft (50 m)
Center-mounted

Required guide troughs:

164 ft (50 m) guide trough, 82 ft. (25 m) glide bar
= 25 sections of 6.56 ft (2 m) guide trough

Part No. 99-30

= 13 sections of 6.56 ft (2 m) glide bar

Part No. 93-01

Required number of installation set:

= Number of guide trough components + 1
= 25 + 1 = 26

Part No. of the installation sets **96-50-XXX**

Example:

96-50-400 for 15.75 (400 mm) long profile rail



Left: Guide trough with glide bars
Right: Guide troughs without glide bars



Installation sets as section connectors

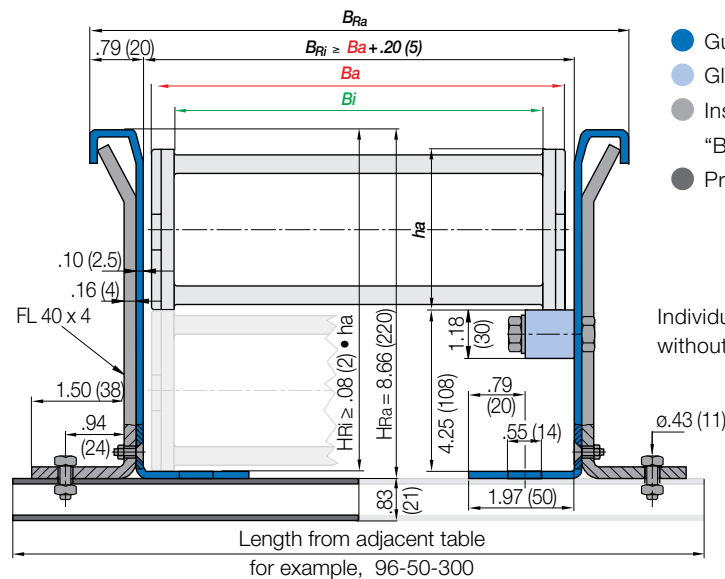

- Guide trough
- Glide bars
- Installation set "Basic"
- Profile rail

Individual attachment without profile rail

* Specialized guide trough available upon request

Standard length profile rail

PDF: igus.com/e-chain-pdfs
Product information: igus.com/e-chains



15050
15150
R19850



e-chain system® E4 light
Series 15050/15150/R19850
Application Example

igus®
e-chain system®

Telephone 1-800-521-2747

Internet: igus.com
email: sales@igus.com
QuickSpec: igus.com/quickspec



Spray-painting robot with System E4 e-chain® used in an ATEX version made of igamid ESD. High accelerations of up to 19.69 f/s^2 (6 m/s^2) and high braking rates with a weight of the robot of approximately one ton



PDF: igus.com/e-chain-pdfs
Product information: igus.com/e-chains



15250
15350



e-chain system® E4 light Series 15250/15350

3.39

Price Index



Special Features / Options

ESD classification:
Electrically conductive ESD/
ATEX version upon request

High torsional rigidity

Side-mounted - unsupported

Assembly Tips



Opening e-chains®: Remove crossbars and clips - Insert screwdriver into the slot, push down, release by lever action



Remove lids/bottoms (e-tubes) - Insert screwdriver into the slot, release by lever action

Other Installation Methods

- Vertical, hanging ≤ 262 ft (80 m)
- Vertical, standing ≤ 19.69 ft (6 m)
- Side-mounted, un supp. ≤ 6.56 ft (2 m)
- Rotary requires further calculation

Usage Guidelines

- If weight and price reduction is needed
- If an e-chain®/e-tube with an inner height of 3.39" (86 mm) is required

- If an extremely low-noise and low-vibration version is required
➤ **Series E6-80L**
- If side-mounted chain with a longer unsupported travel is required
➤ **Series E4-80**
- If increased unsupported lengths and longer travels are required
➤ **Series E4-80**
- If high fill weights and/or stiff cables and hoses are used
➤ **Series E4-80**
- If chip protection is necessary
➤ **Series R4-80**

6.241

Features & Benefits

- 1** KMA mounting brackets with attachment points on all sides
- 2** Noise dampening pads, optional = -10dB(A)
- 3** Lateral glide surfaces for side-mounted operation
- 4** 25% faster assembly with QuickLock Crossbar
- 5** High stability due to undercut design
- 6** Notch crossbar with visual scale
- 7** No camber: no rework due to special design

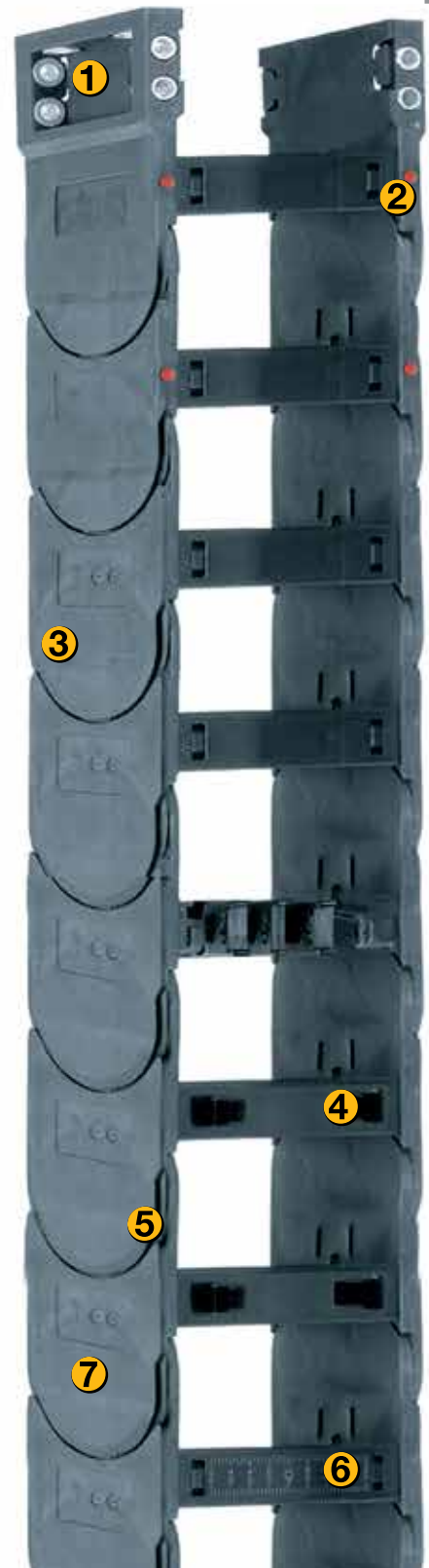

Order Example: Complete e-chain®

Please indicate chain length or number of links. Example:

16.4 ft (5 m) **15250-12-250-0**

e-chain®

With 2 separators **86-1-1** assembled every 2nd link

Interior Separation

1 Set **152500-12-12P**

Mounting Bracket

e-chain system® E4 light

Series 15250/15350

Installation Dimensions

Short travel, unsupported length

- FL_B = unsupported with permitted sag
 - FL_G = unsupported with straight upper run
- Further information ► Design, Chapter 1

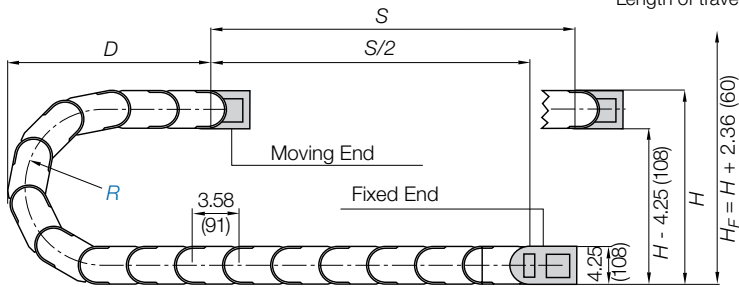
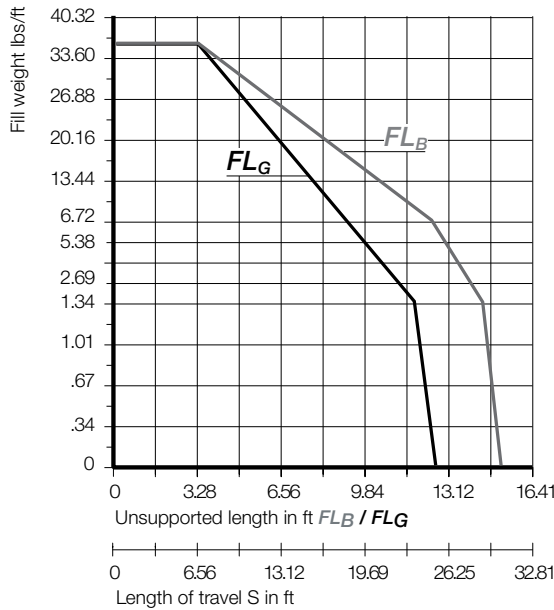
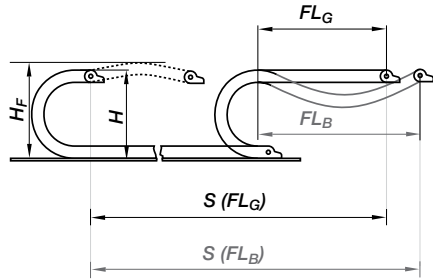

Pitch per link = 3.58" (91 mm)
 Links per ft (m) = 3.35 (11)
 For center mount applications:
 Chain length = $\frac{S}{2} + K$

The required clearance height: $H_F = H + 2.36$ in. (60 mm) (with 2.02 lbs/ft (3 kg/m) fill weight. Please consult igus® if space is particularly restricted.

R	5.91 (150)	7.87 (200)	9.84 (250)	11.81 (300)	13.78 (350)	15.75 (400)	19.68 (500)	23.62 (600)
H_{25}	16.06 (408)	20.00 (508)	23.94 (608)	27.87 (708)	31.81 (808)	35.75 (908)	43.62 (1108)	51.50 (1308)
D	13.43 (341)	15.39 (391)	17.36 (441)	19.33 (491)	21.30 (541)	23.27 (591)	27.20 (691)	31.14 (791)
K	25.79 (655)	32.09 (815)	38.19 (970)	44.29 (1125)	50.59 (1285)	56.69 (1440)	69.09 (1755)	81.50 (2070)

For long travels with lowered mounting height

Long travel lengths from 32.8 ft.(10m) to max. 820 ft. (250m)

For center mount applications:
 Chain length = $\frac{S}{2} + K_2$

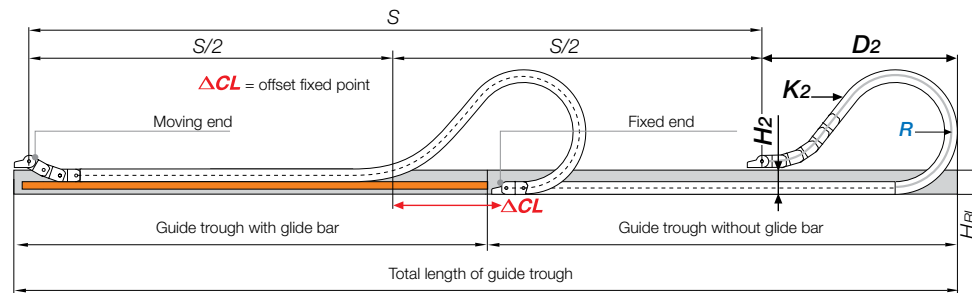

R	5.91 (150*)	7.87 (200)	9.84 (250)	11.81 (300)	13.78 (350)	15.75 (400)	19.68 (500)	23.62 (600*)
H_2	9.53 (242)	9.53 (242)	9.53 (242)	9.53 (242)	9.53 (242)	9.53 (242)	9.53 (242)	*
D_2^{+25}	21.65 (550)	31.50 (800)	37.40 (950)	47.24 (1200)	61.02 (1550)	66.93 (1700)	85.63 (2175)	*
K_2	35.83 (910)	50.16 (1274)	64.49 (1638)	78.82 (2002)	96.73 (2457)	107.48 (2730)	136.14 (3458)	*
ΔCL	8.23 (209)	16.10 (409)	20.04 (509)	27.91 (709)	39.72 (1009)	43.66 (1109)	58.42 (1484)	*

Speed / acceleration FL_G	max. 65.6 ft/s (20 m/s) / max. 656 ft/s ² (200 m/s ²)
Speed / acceleration FL_B	max. 9.84 ft/s (3 m/s) / max. 19.69 ft/s ² (6 m/s ²)
Gliding speed / acceleration (maximum)	max. 32.8 ft/s (10 m/s) / max. 164 ft/s ² (50 m/s ²)
Material - permitted temperature	igumid G / -40°F (-40°C) up to +248°F (+120°C)
Flammability Class, igumid G	VDE 0304 IIC UL94 HB



15250
15350

Short Travels - Unsupported



Unsupported e-chains® feature positive camber over short travels. This must be accounted for when specifying the clearance height. Please refer to **Installation dimensions** for further details.

Legend

- S = Length of travel
 - R = Bending radius
 - H = Nominal clearance height
 - D = Overlength e-chain® radius in final position
 - $K = \pi \cdot R + \text{safety buffer}$
 - H_F = Required clearance height
 - H_{in} = Trough inner height
 - H_2 = *Mounting height
 - D_2 = Overlength - long travels, gliding
 - K_2 = *Add-on
- *If the mounting bracket location is set lower



PDF: igus.com/e-chain-pdfs
 Product information: igus.com/e-chains



Long Travels - Gliding



If the unsupported length is exceeded, the e-chain®/ Tube must glide on itself. This requires a guide trough.

Design, Chapter 1



For support of the lower run, see **Chapter 9** of the main catalog for the **Support Tray tool kit**

Technical Data



Details of material properties ► **Chapter 1**



6.242

Series 15250 - e-chain® with crossbars every link

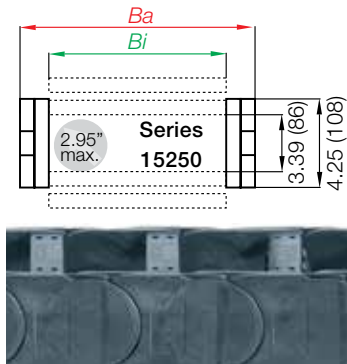

- Crossbars every link
- For use with rigid hydraulic hoses
- For particularly demanding applications
- Can be opened from both sides

Part Number Structure

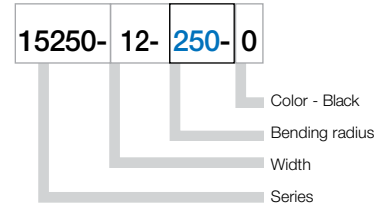

Series 15350 - e-chain® with crossbars every other link

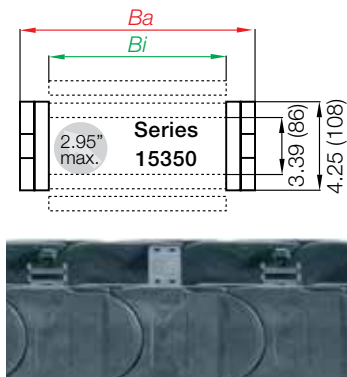

- Crossbars every other link - Standard configuration
- For nearly every situation
- Can be opened from both sides
- Easy assembly
- Stable
- Cost-effective

Part Number Structure

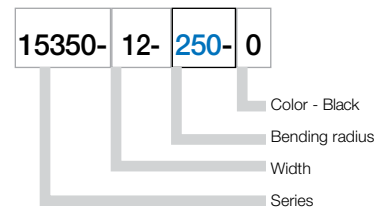

e-chain® as separate parts, links and side plates

Right side link*, single part - Part No. 15250-02-R

Single crossbar, e-chain® - Part No. 385-Bi

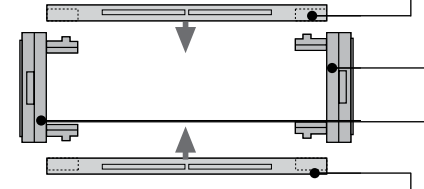

Single crossbar, e-chain® - Part No. 385-Bi

Left side link*, single part - Part No. 15250-01-R

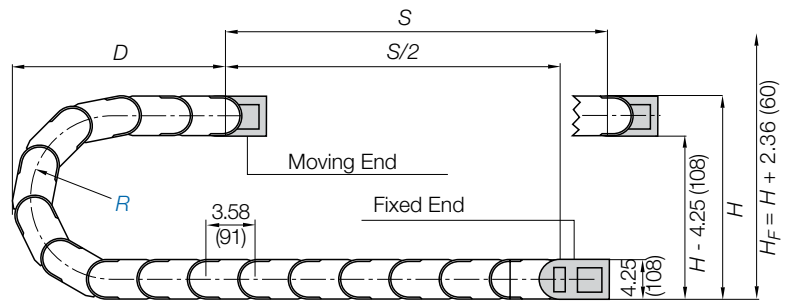

*View from the fixed point of the e-chain®/e-tube

e-chain system® E4 light

Series 15250/15350

Supplement part number with required radius. Example: 15250-30-300-0

Pitch: 3.58 in. (91mm) per link links/ft (m) = 3.35 (11)



15250
15350

Part Number.				<i>Bi</i>	<i>Ba</i>	15250	15350
Crossbars	Crossbars			in. (mm)	in. (mm)	lbs/ft (kg/m)	lbs/ft (kg/m)
Every link	Every other						
15250-05-	15350-05-	<input type="checkbox"/>	-0	1.97 (50)	3.15 (80)	≈ 2.45 (3.64)	≈ 2.39 (3.56)
15250-06-	15350-06-	<input type="checkbox"/>	-0	2.68 (68)	3.86 (98)	≈ 2.50 (3.72)	≈ 2.42 (3.60)
15250-07-	15350-07-	<input type="checkbox"/>	-0	2.95 (75)	4.13 (105)	≈ 2.51 (3.74)	≈ 2.43 (3.61)
15250-087-	15350-087-	<input type="checkbox"/>	-0	3.43 (87)	4.61 (117)	≈ 2.55 (3.79)	≈ 2.44 (3.63)
15250-097-	15350-097-	<input type="checkbox"/>	-0	3.82 (97)	5.00 (127)	≈ 2.57 (3.83)	≈ 2.45 (3.65)
15250-10-	15350-10-	<input type="checkbox"/>	-0	3.94 (100)	5.12 (130)	≈ 2.59 (3.85)	≈ 2.46 (3.66)
15250-11-	15350-11-	<input type="checkbox"/>	-0	4.25 (108)	5.43 (138)	≈ 2.60 (3.87)	≈ 2.47 (3.67)
15250-112-	15350-112-	<input type="checkbox"/>	-0	4.41 (112)	5.63 (143)	≈ 2.61 (3.88)	≈ 2.47 (3.68)
15250-12-	15350-12-	<input type="checkbox"/>	-0	4.92 (125)	6.10 (155)	≈ 2.65 (3.95)	≈ 2.49 (3.71)
15250-137-	15350-137-	<input type="checkbox"/>	-0	5.39 (137)	6.57 (167)	≈ 2.67 (3.98)	≈ 2.51 (3.73)
15250-15-	15350-15-	<input type="checkbox"/>	-0	5.91 (150)	7.09 (180)	≈ 2.71 (4.04)	≈ 2.52 (3.75)
15250-162-	15350-162-	<input type="checkbox"/>	-0	6.38 (162)	7.60 (193)	≈ 2.73 (4.06)	≈ 2.53 (3.76)
15250-17-	15350-17-	<input type="checkbox"/>	-0	6.61 (168)	7.80 (198)	≈ 2.76 (4.11)	≈ 2.55 (3.79)
15250-18-	15350-18-	<input type="checkbox"/>	-0	6.89 (175)	8.07 (205)	≈ 2.77 (4.12)	≈ 2.55 (3.80)
15250-187-	15350-187-	<input type="checkbox"/>	-0	7.36 (187)	8.58 (218)	≈ 2.79 (4.15)	≈ 2.56 (3.81)
15250-20-	15350-20-	<input type="checkbox"/>	-0	7.87 (200)	9.05 (230)	≈ 2.84 (4.23)	≈ 2.59 (3.85)
15250-212-	15350-212-	<input type="checkbox"/>	-0	8.35 (212)	9.56 (243)	≈ 2.86 (4.26)	≈ 2.59 (3.86)
15250-23-	15350-23-	<input type="checkbox"/>	-0	8.86 (225)	10.04 (255)	≈ 2.90 (4.32)	≈ 2.61 (3.89)
15250-237-	15350-237-	<input type="checkbox"/>	-0	9.33 (237)	10.55 (268)	≈ 2.92 (4.34)	≈ 2.62 (3.90)
15250-25-	15350-25-	<input type="checkbox"/>	-0	9.84 (250)	11.02 (280)	≈ 2.97 (4.42)	≈ 2.65 (3.94)
15250-262-	15350-262-	<input type="checkbox"/>	-0	10.31 (262)	11.54 (293)	≈ 3.00 (4.47)	≈ 2.67 (3.97)
15250-28-	15350-28-	<input type="checkbox"/>	-0	10.83 (275)	12.01 (305)	≈ 3.03 (4.51)	≈ 2.68 (3.99)
15250-29-	15350-29-	<input type="checkbox"/>	-0	11.30 (287)	12.52 (318)	≈ 3.04 (4.53)	≈ 2.69 (4.00)
15250-30-	15350-30-	<input type="checkbox"/>	-0	11.81 (300)	12.99 (330)	≈ 3.10 (4.61)	≈ 2.71 (4.04)
15250-312-	15350-312-	<input type="checkbox"/>	-0	12.28 (312)	13.50 (343)	≈ 3.11 (4.63)	≈ 2.72 (4.05)
15250-325-	15350-325-	<input type="checkbox"/>	-0	12.79 (325)	13.98 (355)	≈ 3.15 (4.69)	≈ 2.73 (4.06)
15250-337-	15350-337-	<input type="checkbox"/>	-0	13.27 (337)	14.49 (368)	≈ 3.18 (4.73)	≈ 2.76 (4.10)
15250-350-	15350-350-	<input type="checkbox"/>	-0	13.78 (350)	14.96 (380)	≈ 3.27 (4.87)	≈ 2.80 (4.17)
15250-362-	15350-362-	<input type="checkbox"/>	-0	14.25 (362)	15.47 (393)	≈ 3.31 (4.92)	≈ 2.82 (4.20)
15250-375-	15350-375-	<input type="checkbox"/>	-0	14.76 (375)	15.94 (405)	≈ 3.34 (4.97)	≈ 2.84 (4.22)
15250-387-	15350-387-	<input type="checkbox"/>	-0	15.24 (387)	16.46 (418)	≈ 3.37 (5.01)	≈ 2.85 (4.24)
15250-400-	15350-400-	<input type="checkbox"/>	-0	15.75 (400)	16.93 (430)	≈ 3.39 (5.05)	≈ 2.86 (4.26)

Choose from the radii below for all of the above sizes

Radius (mm) Example: 15250-30-300-0

	150	200	250	300	350	400	500	600
<i>R</i>	5.91 (150)	7.87 (200)	9.84 (250)	11.81 (300)	13.78 (350)	15.75 (400)	19.68 (500)	23.62 (600)
$H_{25}^{\frac{1}{2}}$	16.06 (408)	20.00 (508)	23.94 (608)	27.87 (708)	31.81 (808)	35.75 (908)	43.62 (1108)	51.50 (1308)
<i>D</i>	13.43 (341)	15.39 (391)	17.36 (441)	19.33 (491)	21.30 (541)	23.27 (591)	27.20 (691)	31.14 (791)
<i>K</i>	25.79 (655)	32.09 (815)	38.19 (970)	44.29 (1125)	50.59 (1285)	56.69 (1440)	69.09 (1755)	81.50 (2070)

0=Standard color black. For other colors see Chapter 1
For large diameter hoses see page 6.246

PDF: igus.com/e-chain-pdfs
Product information: igus.com/e-chains



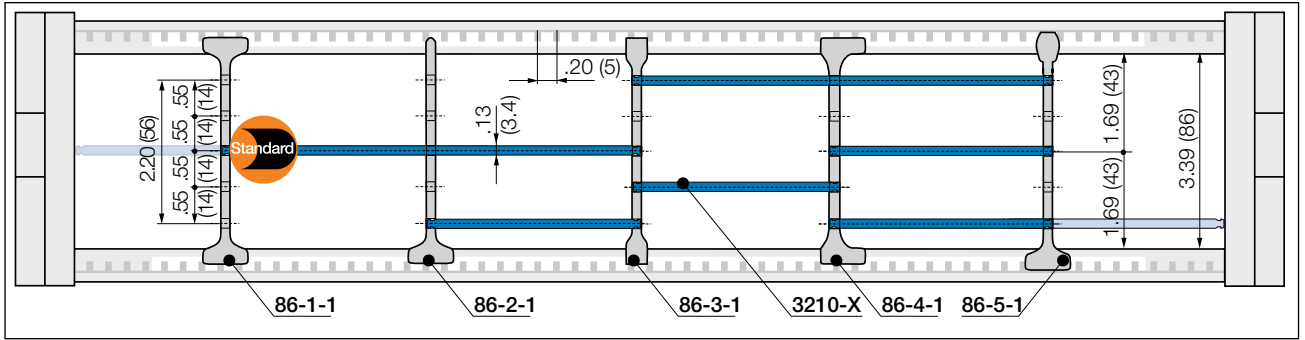

In the standard configuration separators are assembled every 2nd e-chain® link

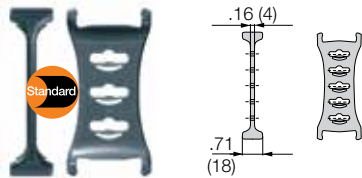

Separator, wide base

Unassembled **Part No. 86-1**

Assembled **Part No. 86-1-1**

- **Standard separator 86-1 for all applications**

Separator with wide base for maximum locking strength and safe standing in e-chains®.

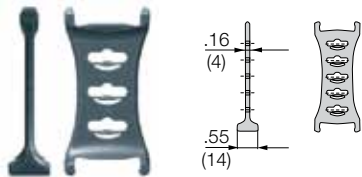

Separator for QuickLock crossbar

Unassembled **Part No. 86-2**

Assembled **Part No. 86-2-1**

- **Separator 86-2 For even faster installation**

Separator for igus® QuickLock crossbar 385-X-Q. Firm hold to one side with a wide base, narrow on opposed side for easy cable assembly (slight grip)

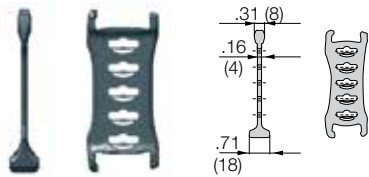

Notch separator for notch crossbar

Unassembled **Part No. 86-5**

Assembled **Part No. 86-5-1**

- **Separator 86-5 Locks safely in .20" (5 mm) increments**
Notch separator for exact positioning in e-chains®. Recommended for side mounted applications.

Lockable full-width shelves - for the standard interior separation

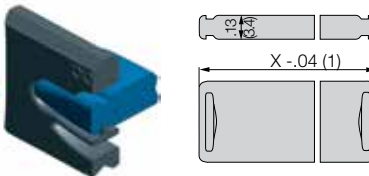

Full width shelf, lockable

Unassembled **Part No. 3200-X**

Assembled **Part No. 3210-X**

- **Full width shelf, lockable**
Shelf locks into separators on both ends, fixed width possible. Separators can be moved freely over the shelf in horizontal direction. Can be arranged at 3 different heights.

Width X in. (mm)	Part No. Unassembled	Part No. Assembled	Width X in. (mm)	Part No. Unassembled	Part No. Assembled
1.97 (050)	3200-50	3210-50	5.91 (150)	3200-150	3210-150
2.95 (075)	3200-75	3210-75	6.89 (175)	3200-175	3210-175
3.94 (100)	3200-100	3210-100	7.87 (200)	3200-200	3210-200
4.53 (115)	3200-115	3210-115	8.86 (225)	3200-225	3210-225
4.92 (125)	3200-125	3210-125	9.84 (250)	3200-250	3210-250



Consult igus® for your extender crossbar applications. We will be happy to assist you with your design layout.

Extender crossbars - For careful guiding of large diameter cables and hoses

- Intended for cables and hoses with a maximum outer diameter of 4.53 in. (115 mm).
- Gliding operation with crossbars assembled along the outer radius in conjunction with a special guide trough
- Gliding operation not guaranteed with crossbars assembled along the inner radius
- The extender crossbar can either be attached to the side links directly or can be used in combination with two standard snap-open crossbars.

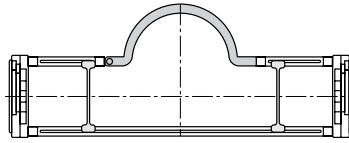

Round extender crossbar combined with standard snap-open crossbars.

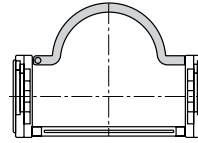

Attached directly to the side link.

Part No.	Max Ø Hose in. (mm)	Style	Installation Side Link	Combined with Snap-Open Crossbars
385-15-RHD115	4.53 (115)	Round	No	Yes
385-18-RD115	4.53 (115)	Round	Yes	No

Hinged crossbars

- Typically, e-chain® crossbars are completely removable. In cases where it is preferable that the opening crossbars remain on the e-chain®, a hinged design has been developed.
- Please consult igus® for design assistance

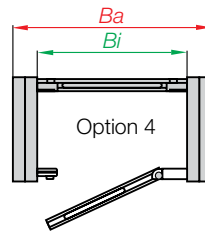
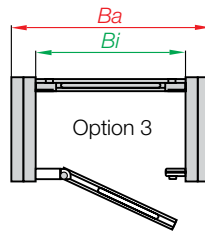
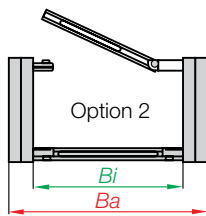
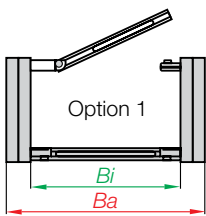

15250
15350



e-chain system® E4 light Series 15250/15350 Mounting Brackets - KMA

igus®
e-chain system®

Telephone 1-800-521-2747

Internet: igus.com
email: sales@igus.com
QuickSpec: igus.com/quickspec



Option 1: KMA pivoting

- Profile rail option
- Universal use
- Corrosion resistant
- Short and long travels
- Space-restricted conditions

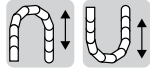

Option 2: KMA locking

- Profile rail option
- Universal use
- Corrosion resistant
- Extreme accelerations
- Vertical hanging/standing travels

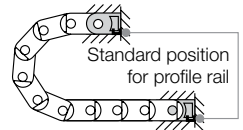
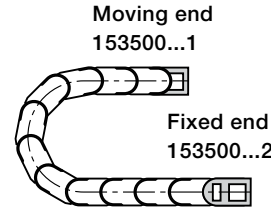
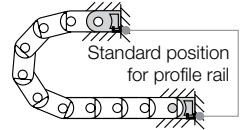
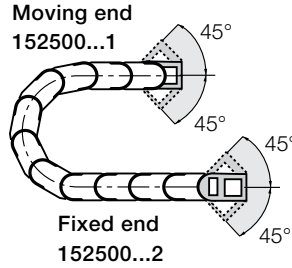

Part Number Structure

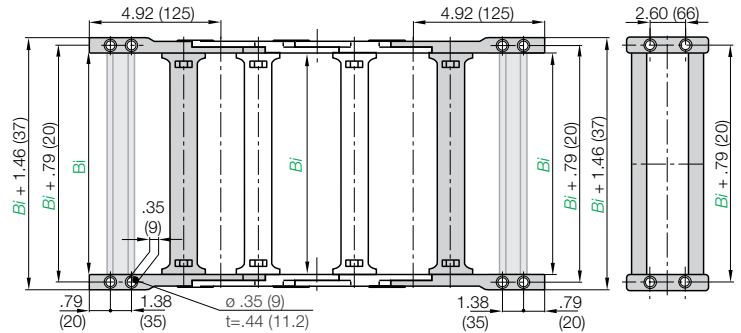
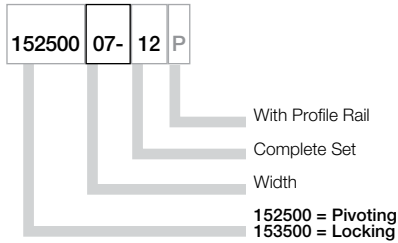

Full set, for both ends:

152500-05-12 Full set, each part with pin/bore

Single-part order:

152500-05-1 Mounting bracket with bore
152500-05-2 Mounting bracket with pin

Bracket Mounting Dimensions

Width	Part No. Full Set		With Profile Rail	Bi in. (mm)	Width	Part No. Full Set		With Profile Rail	Bi in. (mm)	
	Pivoting	Locking				Pivoting	Locking			
-05	152500	153500	-05-12	P	1.97 (50)	-212	152500 153500	-212-12	P	8.35 (212)
-06	152500	153500	-06-12	P	2.56 (65)	-23	152500 153500	-23-12	P	8.86 (225)
-07	152500	153500	-07-12	P	2.95 (75)	-237	152500 153500	-237-12	P	9.33 (237)
-087	152500	153500	-087-12	P	3.43 (87)	-25	152500 153500	-25-12	P	9.84 (250)
-09	152500	153500	-09-12	P	3.82 (97)	-262	152500 153500	-262-12	P	10.31 (262)
-10	152500	153500	-10-12	P	3.94 (100)	-28	152500 153500	-28-12	P	10.83 (275)
-11	152500	153500	-11-12	P	4.25 (108)	-29	152500 153500	-29-12	P	11.30 (287)
-112	152500	153500	-112-12	P	4.41 (112)	-30	152500 153500	-30-12	P	11.81 (300)
-12	152500	153500	-12-12	P	4.92 (125)	-312	152500 153500	-312-12	P	12.28 (312)
-137	152500	153500	-137-12	P	5.39 (137)	-325	152500 153500	-325-12	P	12.79 (325)
-15	152500	153500	-15-12	P	5.91 (150)	-337	152500 153500	-337-12	P	13.27 (337)
-162	152500	153500	-162-12	P	6.38 (162)	-350	152500 153500	-350-12	P	13.78 (350)
-17	152500	153500	-17-12	P	6.61 (168)	-362	152500 153500	-362-12	P	14.25 (362)
-18	152500	153500	-18-12	P	6.89 (175)	-375	152500 153500	-375-12	P	14.76 (375)
-187	152500	153500	-187-12	P	7.36 (187)	-387	152500 153500	-387-12	P	15.24 (387)
-20	152500	153500	-20-12	P	7.87 (200)	-400	152500 153500	-400-12	P	15.75 (400)

e-chain system® E4 light

Series 15250/15350

Strain Relief



15250
15350

Chainfix clamps for the profile rail



igus® Chainfix strain relief elements are available in either steel or stainless steel. They can be adjusted with a hexagon socket and are available in single, double and triple configurations.

Part No. Single Clamp		Part No. Double Clamp		Part No. Triple Clamp		Cable ø	
Steel	Stainless	Steel	Stainless	Steel	Stainless	in.	(mm)
CFX12-1	CFX12-1E	CFX12-2	CFX12-2E	CFX12-3	-	.24 - .47	(6 - 12)
CFX14-1	CFX14-1E	CFX14-2	CFX14-2E	CFX14-3	-	.47 - .55	(12 - 14)
CFX16-1	CFX16-1E	CFX16-2	CFX16-2E	CFX16-3	-	.55 - .63	(14 - 16)
CFX18-1	CFX18-1E	CFX18-2	CFX18-2E	CFX18-3	-	.63 - .71	(16 - 18)
CFX20-1	CFX20-1E	CFX20-2	CFX20-2E	CFX20-3	-	.71 - .79	(18 - 20)
CFX22-1	CFX22-1E	CFX22-2	CFX22-2E	CFX22-3	-	.79 - .87	(20 - 22)
CFX26-1	CFX26-1E	CFX26-2	CFX26-2E	-	-	.87 - 1.02	(22 - 26)
CFX30-1	CFX30-1E	CFX30-2	CFX30-2E	-	-	1.02 - 1.18	(26 - 30)
CFX34-1	CFX34-1E	CFX34-2	CFX34-2E	-	-	1.18 - 1.34	(30 - 34)
CFX38-1	CFX38-1E	-	-	-	-	1.34 - 1.50	(34 - 38)
CFX42-1	CFX42-1E	-	-	-	-	1.50 - 1.65	(38 - 42)

For more information please refer to strain relief section of Chapter 10

Tiewrap Plates

Option 1:

Tiewrap plates as an individual part

Available as an individual component, can be fixed onto a mounting bracket with the use of a profile rail.

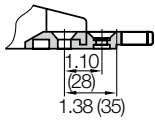

Shown assembled

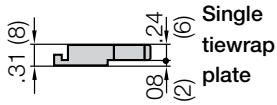

Single tiewrap plate

Tiewrap Plate	n Number of Teeth	C Overall Width in. (mm)	B Bore Width in. (mm)	Center Bore
3050-ZB	5	1.97 (50)	1.18 (30)	no
3075-ZB	7	2.95 (75)	2.16 (55)	no
3100-ZB	10	3.94 (100)	3.15 (80)	no
3115-ZB	11	4.53 (115)	3.74 (95)	no
3125-ZB	12	4.92 (125)	4.13 (105)	no
3150-ZB	15	5.91 (150)	5.12 (130)	no
3175-ZB	17	6.89 (175)	6.10 (155)	no
3200-ZB	20	7.87 (200)	7.09 (180)	yes
3225-ZB	22	8.86 (225)	8.07 (205)	yes
3250-ZB	25	9.84 (250)	9.06 (230)	yes

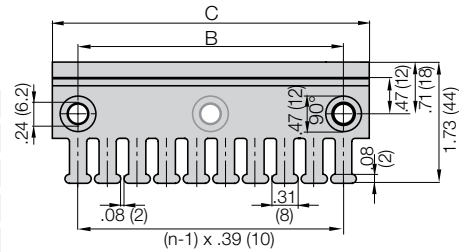

If used with KMA brackets with profile rail please add "KMA" to the end of the part number.

Example: 3050-ZBKMA

For more information please refer to strain relief section of Chapter 10

Option 2:

Clip-on Tiewrap plates

Available as a clip-on tiewrap plate without the use of bolts They are inserted and removed with a screwdriver used as a lever. Clip-on tiewrap plates are also available as an attachment to the opening crossbars.



Part No.	Number of Teeth	Width of Strain Relief in. (mm)
3050-ZC	5	1.97 (50)
3075-ZC	7	2.95 (75)

For more information please refer to strain relief section of Chapter 10

Option 3:

Clip-on Tiewrap plates for opening crossbars

Clip-on tiewrap plates are also available as an attachment to opening crossbars. They can be positioned at any point along the e-chain®.



Part No.	Number of Teeth	Width of Strain Relief in. (mm)
3850-ZS	5	1.89 (48)

For more information please refer to strain relief section of Chapter 10

PDF: igus.com/e-chain-pdfs
Product information: igus.com/e-chains



Width of Crossbar
15250-20-300-0

	B_{Ri}	Installation Part No.
-05	3.35 (85) *	
-06	4.06 (103)	96-50-225
-07	4.33 (110)	96-50-225
-087	4.80 (122)	96-50-250
-09	5.20 (132)	96-50-250
-10	5.31 (135)	96-50-250
-11	5.63 (143)	96-50-275
-112	5.83 (148)	96-50-275
-12	6.30 (160)	96-50-275
-13	6.77 (172)	96-50-300
-15	7.28 (185)	96-50-300
-16	7.80 (198)	96-50-325
-17	7.99 (203)	96-50-325
-17	8.27 (210)	96-50-325
-18	8.78 (223)	96-50-350
-20	9.25 (235)	96-50-350
-21	9.76 (248)	96-50-375
-22	10.24 (260)	96-50-375
-23	10.75 (273)	96-50-400
-25	11.22 (285)	96-50-400
-26	11.73 (298)	96-50-425
-27	12.20 (310)	96-50-425
-28	12.72 (323)	96-50-450
-30	13.19 (335)	96-50-450
-31	13.70 (348)	96-50-475
-32	14.17 (360)	96-50-475
-33	14.69 (373)	96-50-500
-35	15.16 (385)	96-50-500
-36	15.67 (398)	96-50-525
-37	16.14 (410)	96-50-525
-38	16.65 (423)	96-50-550
-40	17.13 (435)	96-50-550

* Specialized guide trough available upon request

Guide troughs are used with applications where the upper run of the e-chain® glides on the lower run. If using igus® steel guide troughs, the following components are required:

- Full travel length of guide trough
Part No. 99-30
- 1/2 travel length glide bars
Part No. 93-01
- Installation sets as end connectors
Part No. 96-50-XX

-XX indicates the length of the profile rails on which the guide trough is mounted. The values and part numbers are specified in the table on the left. The standard length of the trough components and glide bars is 6.56 ft (2 m). The overall length of the guide trough directly correlates to the length of travel.

Example:

Length of travel 164 ft (50 m)
Center-mounted

Required guide troughs:

164 ft (50 m) guide trough, 82 ft. (25 m) glide bar
= 25 sections of 6.56 ft (2 m) guide trough

Part No. 99-30

= 13 sections of 6.56 ft (2 m) glide bar

Part No. 93-01

Required number of installation set:

= Number of guide trough components + 1
= 25 + 1 = 26

Part No. of the installation sets **96-50-XXX**

Example:

96-50-400 for 15.75 (400 mm) long profile rail



Left: Guide trough with glide bars
Right: Guide troughs without glide bars



Installation sets as section connectors

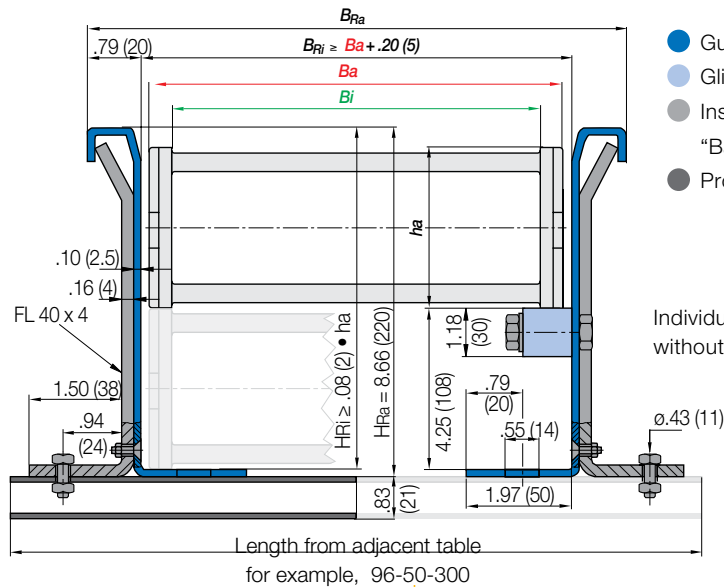

- Guide trough
- Glide bars
- Installation set "Basic"
- Profile rail

Individual attachment without profile rail

Standard length profile rail

e-chain system® E4 light
Series 15250/15350
Application Example

igus®

15250
15350



System E4/light e-chain® - can be filled with cables with diameters up to 3.94" (100 mm)

PDF: igus.com/e-chain-pdfs
Product information: igus.com/e-chains



1640
R1608



e-chain system® E4 light Series 1640/R1608

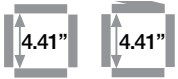

Price Index



Series 1640



Series R1608

Special Features / Options



ESD classification:
Electrically conductive ESD/
ATEX version upon request



High torsional rigidity



Side-mounted - unsupported

Assembly Tips



Opening e-chains®: Remove crossbars and clips - Insert screwdriver into the slot, push down, release by lever action



Remove lids/bottoms (e-tubes) - Insert screwdriver into the slot, release by lever action

Other Installation Methods

Vertical, hanging ≤ consult igus®

Vertical, standing ≤ 16.4 ft (5 m)

Side-mounted, un supp. ≤ 6.56 ft (2 m)

Rotary requires further calculation

Usage Guidelines



- If a simpler, low-cost solution is required
- If optimized interior space is required
- If the Series 400 is too large



- If maximum stability is required
➤ Series 600/R608

Features & Benefits

- 1 Numerous interior separation possibilities
- 2 Hinged snap-open removable lids along outer radius of e-tube
- 3 Lateral glide surfaces for side-mounted operation
- 4 Closed and open styles can be combined
- 5 Removable lids along inner radius
- 6 Wide, rounded plastic crossbars - cable friendly
- 7 Dirt repellent exterior
- 8 e-chain® also available with reverse bending radii

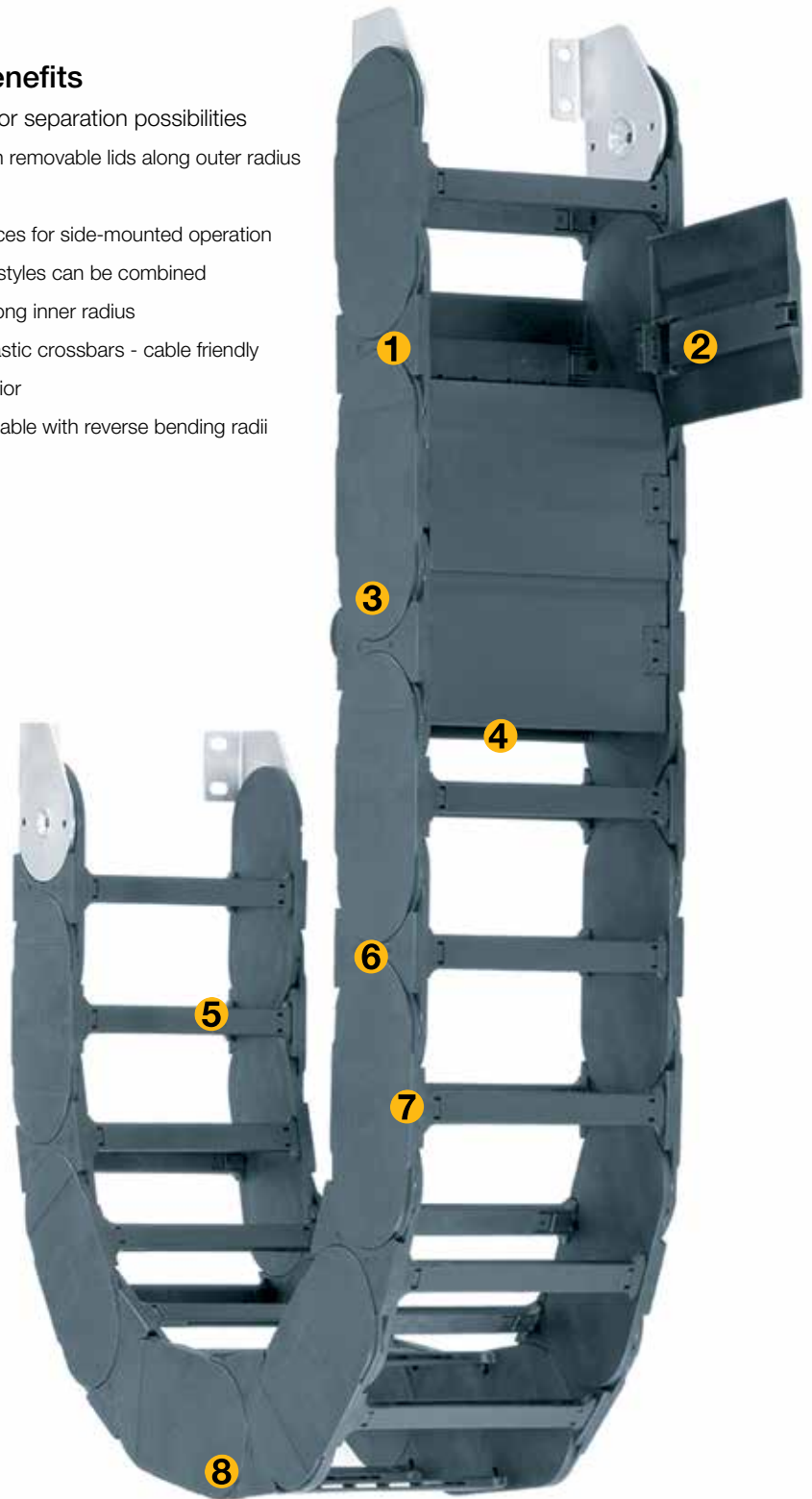

Order Example: Complete e-chain®

Please indicate chain length or number of links. Example:

6.56 ft (2 m) 1640-30-300-0



e-chain®

With 2 separators 6411 assembled every 2nd link



Interior Separation

1 Set 16000-12



Mounting Bracket

e-chain system® E4 light Series 1640/R1608 Installation Dimensions



1640
R1608

Short travel, unsupported length

- FL_B = unsupported with permitted sag
 - FL_G = unsupported with straight upper run
- Further information ► Design, Chapter 1

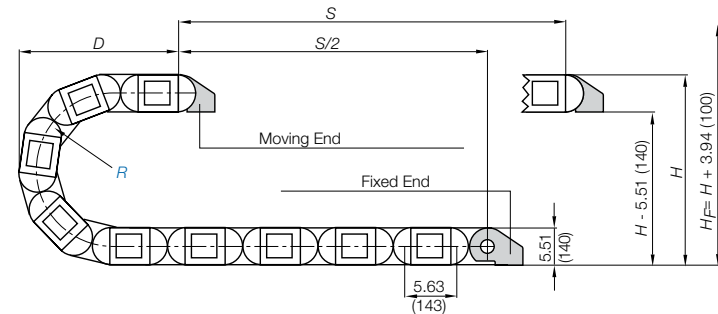
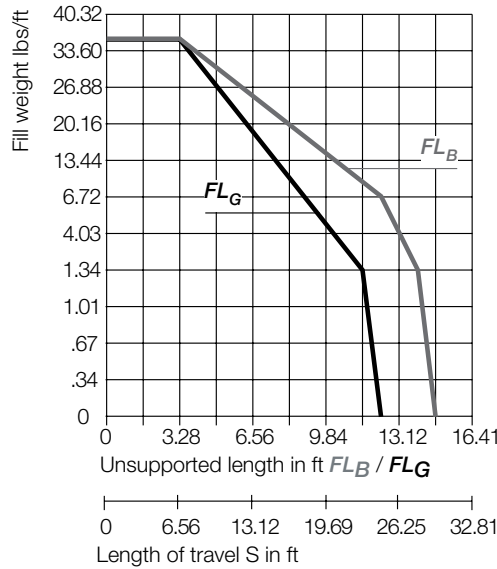
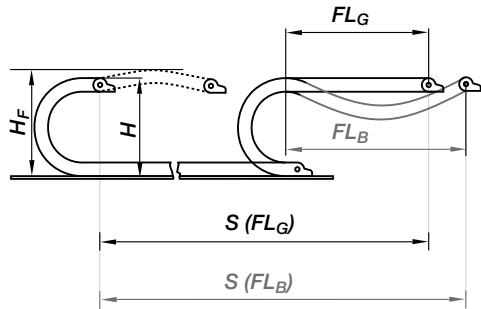

Pitch per link = 5.63" (143 mm)
Links per ft (m) = 2.13 (7)
For center mount applications:
Chain length = $\frac{S}{2} + K$

The required clearance height: $H_F = H + 3.94$ in. (100 mm) with 3.36 lbs/ft (5 kg/m) fill weight. Please consult igus® if space is particularly restricted.

R	7.87 (200)	9.84 (250)	11.81 (300)	13.78 (350)	15.75 (400)	17.72 (450)	19.69 (500)	21.65 (550)	23.62 (600)
H	21.46 (545)	25.39 (645)	29.41 (747)	33.27 (845)	37.20 (945)	41.14 (1045)	45.08 (1145)	49.02 (1245)	52.95 (1345)
D	16.34 (415)	18.31 (465)	20.27 (515)	22.24 (565)	24.21 (615)	26.18 (665)	28.15 (715)	30.12 (765)	32.09 (815)
K	36.22 (920)	42.52 (1080)	48.82 (1240)	55.12 (1400)	61.42 (1560)	67.72 (1720)	73.62 (1870)	79.53 (2020)	85.63 (2175)

For long travels with lowered mounting height

Long travel lengths from 32.8 ft. (10 m) to max. 1,312 ft. (400 m)

For center mount applications:

$$\text{Chain length} = \frac{S}{2} + K_2$$

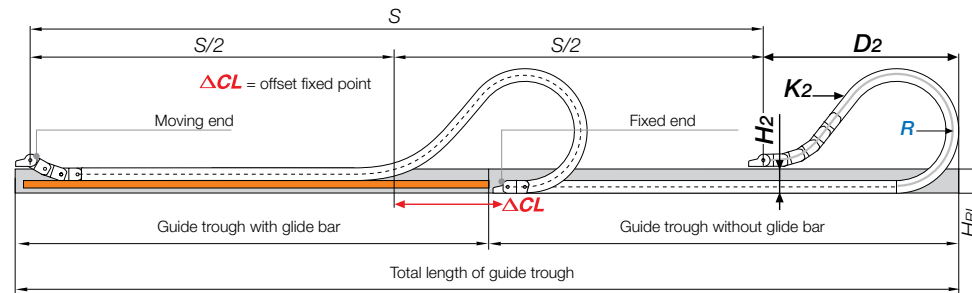

R	7.87 (200)	9.84 (250)	11.81 (300)	13.78 (350)	15.75 (400)	17.72 (450)	19.69 (500)	21.65 (550)	23.62 (600)
H ₂	12.80 (325)	12.80 (325)	12.80 (325)	12.80 (325)	12.80 (325)	12.80 (325)	12.80 (325)	12.80 (325)	12.80 (325)
D ₂ ⁺²⁵	35.43 (900)	39.37 (1000)	43.31 (1100)	49.21 (1200)	57.09 (1450)	62.99 (1600)	66.93 (1700)	74.80 (1900)	80.71 (2050)
K ₂	61.93 (1573)	67.56 (1716)	73.19 (1859)	90.08 (2288)	101.33 (2574)	112.60 (2860)	123.86 (3146)	135.12 (3432)	152.01 (3861)
ΔCL	17.72 (450)	19.69 (500)	21.65 (550)	25.59 (650)	31.50 (800)	35.43 (900)	37.40 (950)	43.31 (1100)	47.24 (1200)

Short Travels - Unsupported



Unsupported e-chains® feature positive camber over short travels. This must be accounted for when specifying the clearance height. Please refer to **Installation dimensions** for further details.

Legend

- S = Length of travel
 - R = Bending radius
 - H = Nominal clearance height
 - D = Overlength e-chain® radius in final position
 - $K = \pi \cdot R + \text{safety buffer}$
 - H_F = Required clearance height
 - H_T = Trough inner height
 - H₂ = *Mounting height
 - D₂ = Overlength - long travels, gliding
 - K₂ = *Add-on
- *If the mounting bracket location is set lower



4.41"

PDF: igus.com/e-chain-pdfs
Product information: igus.com/e-chains

Long Travels - Gliding



If the unsupported length is exceeded, the e-chain®/ Tube must glide on itself. This requires a guide trough. **Design, Chapter 1**

Technical Data



Details of material properties

► Chapter 1

Speed / acceleration FL_G	max. 65.6 ft/s (20 m/s) / max. 656 ft/s ² (200 m/s ²)
Speed / acceleration FL_B	max. 9.84 ft/s (3 m/s) / max. 19.69 ft/s ² (6 m/s ²)
Gliding speed / acceleration (maximum)	max. 32.8 ft/s (10 m/s) / max. 164 ft/s ² (50 m/s ²)
Material - permitted temperature	igumid G / -40°F (-40°C) up to +248°F (+120°C)
Flammability Class, igumid G	VDE 0304 IIC UL94 HB

Series 1640 - e-chain® with crossbars every link

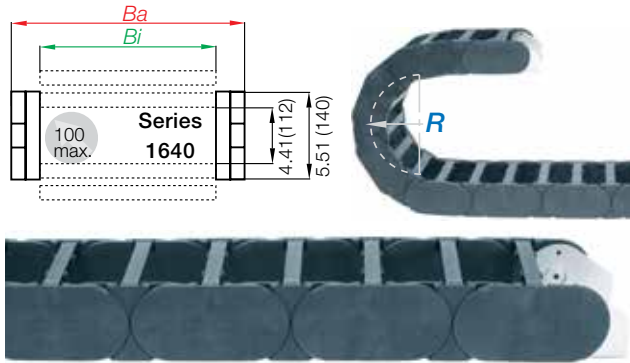

- Crossbars every link
- For use with rigid hydraulic hoses
- For particularly demanding applications
- Can be opened from both sides

Part Number Structure

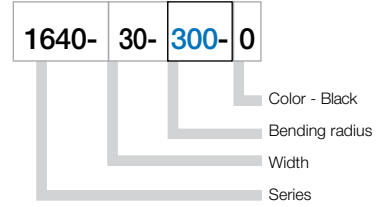

Series R1608 - fully enclosed e-tube

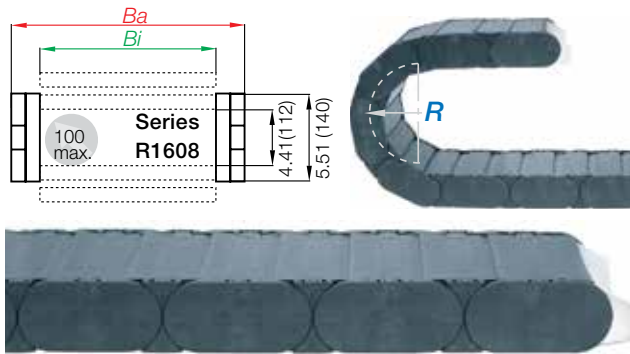

- Fully enclosed
- Excellent cable and hose protection against dirt
- Protection against hot chips
- Lids along inner radius are completely removable
- Lids along the outer radius are single-sided, snap open, hinged on one side as well as completely removable

Part Number Structure

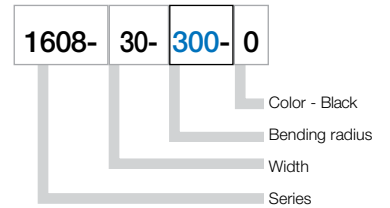

e-chain® as separate parts, links and side plates

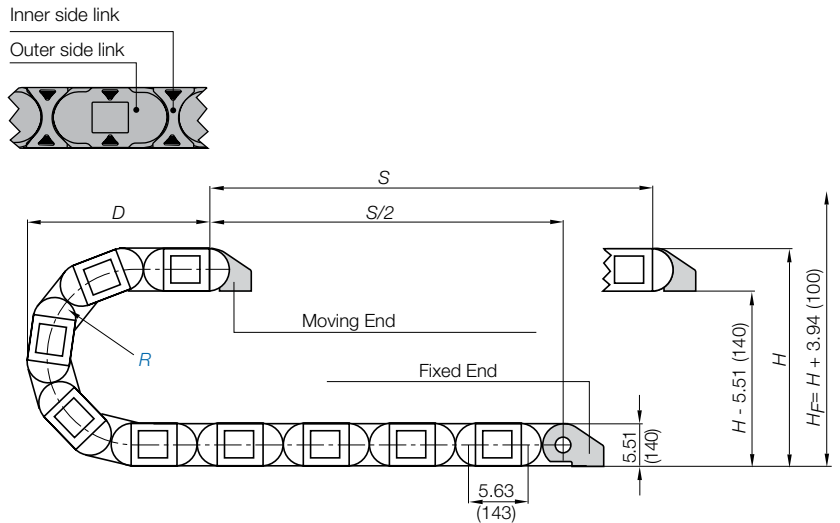
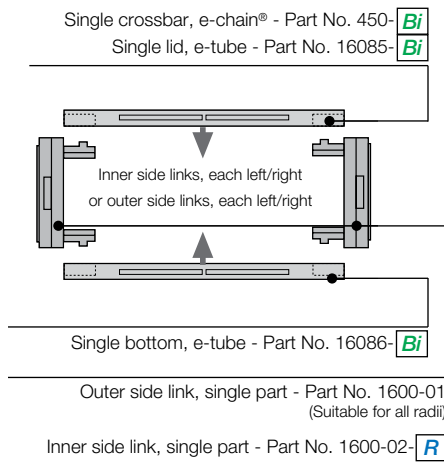

e-chain system® E4 light

Series 1640/R1608



1640
R1608

Supplement part number with required radius. Example: 1640-30-300-0

Pitch: 5.63 in. (143mm) per link links/ft (m) = 2.13 (7)

Part Number.		<i>Bi</i>	<i>Ba</i>	1640	R1608
Crossbars	Tube	in. (mm)	in. (mm)	lbs/ft (kg/m)	lbs/ft (kg/m)
Every link	Version				
1640-05-	<input type="checkbox"/> -0	1.97 (50)	3.31 (84)	≈ 3.43 (5.10)	-
1640-06-	<input type="checkbox"/> -0	2.56 (65)	3.90 (99)	≈ 3.48 (5.18)	-
1640-07-	<input type="checkbox"/> -0	2.95 (75)	4.29 (109)	≈ 3.54 (5.27)	-
1640-08-	<input type="checkbox"/> -0	3.43 (87)	4.76 (121)	≈ 3.57 (5.31)	-
1640-10-	<input type="checkbox"/> -0	3.94 (100)	5.28 (134)	≈ 3.60 (5.36)	-
1640-11-	<input type="checkbox"/> -0	4.41 (112)	5.75 (146)	≈ 3.66 (5.45)	-
1640-12-	<input type="checkbox"/> -0	4.92 (125)	6.26 (159)	≈ 3.72 (5.54)	-
1640-13-	<input type="checkbox"/> -0	5.39 (137)	6.73 (171)	≈ 3.78 (5.63)	-
1640-15-	<input type="checkbox"/> -0	5.91 (150)	7.24 (184)	≈ 3.81 (5.67)	-
1640-16-	<input type="checkbox"/> -0	6.38 (162)	7.72 (196)	≈ 3.86 (5.74)	-
1640-17-	<input type="checkbox"/> -0	6.89 (175)	8.23 (209)	≈ 3.90 (5.81)	-
1640-18-	<input type="checkbox"/> -0	7.36 (187)	8.70 (221)	≈ 3.95 (5.88)	-
1640-20-	1608-20- <input type="checkbox"/> -0	7.87 (200)	9.21 (234)	≈ 3.96 (5.89)	≈ 5.17 (7.69)
1640-21-	<input type="checkbox"/> -0	8.35 (212)	9.69 (246)	≈ 4.00 (5.96)	-
1640-22-	<input type="checkbox"/> -0	8.86 (225)	10.20 (259)	≈ 4.04 (6.01)	-
1640-23-	<input type="checkbox"/> -0	9.33 (237)	10.67 (271)	≈ 4.09 (6.09)	-
1640-25-	1608-25- <input type="checkbox"/> -0	9.84 (250)	11.18 (284)	≈ 4.13 (6.15)	≈ 5.64 (8.39)
1640-26-	<input type="checkbox"/> -0	10.31 (262)	11.65 (296)	≈ 4.17 (6.20)	-
1640-27-	<input type="checkbox"/> -0	10.83 (275)	12.17 (309)	≈ 4.21 (6.27)	-
1640-28-	<input type="checkbox"/> -0	11.30 (287)	12.64 (321)	≈ 4.23 (6.29)	-
1640-30-	1608-30- <input type="checkbox"/> -0	11.81 (300)	13.15 (334)	≈ 4.26 (6.34)	≈ 6.11 (9.09)
1640-31-	<input type="checkbox"/> -0	12.28 (312)	13.62 (346)	≈ 4.31 (6.41)	-
1640-32-	<input type="checkbox"/> -0	12.79 (325)	14.13 (359)	≈ 4.35 (6.48)	-
1640-33-	<input type="checkbox"/> -0	13.27 (337)	14.61 (371)	≈ 4.43 (6.59)	-
1640-35-	1608-35- <input type="checkbox"/> -0	13.78 (350)	15.12 (384)	≈ 4.44 (6.61)	≈ 6.58 (9.79)
1640-36-	<input type="checkbox"/> -0	14.25 (362)	15.59 (396)	≈ 4.48 (6.67)	-
1640-37-	<input type="checkbox"/> -0	14.76 (375)	16.10 (409)	≈ 4.51 (6.71)	-
1640-38-	<input type="checkbox"/> -0	15.24 (387)	16.57 (421)	≈ 4.54 (6.76)	-
1640-40-	1608-40- <input type="checkbox"/> -0	15.75 (400)	17.09 (434)	≈ 4.63 (6.89)	≈ 7.05 (10.49)
1640-41-	<input type="checkbox"/> -0	16.22 (412)	17.56 (446)	≈ 4.70 (6.99)	-
1640-42-	<input type="checkbox"/> -0	16.73 (425)	18.07 (459)	≈ 4.76 (7.08)	-
1640-43-	<input type="checkbox"/> -0	17.20 (437)	18.54 (471)	≈ 4.79 (7.13)	-
1640-45-	<input type="checkbox"/> -0	17.72 (450)	19.06 (484)	≈ 4.82 (7.17)	-
1640-46-	<input type="checkbox"/> -0	18.19 (462)	19.53 (496)	≈ 4.82 (7.18)	-
1640-47-	<input type="checkbox"/> -0	18.70 (475)	20.04 (509)	≈ 4.85 (7.22)	-
1640-48-	<input type="checkbox"/> -0	19.17 (487)	20.51 (521)	≈ 4.89 (7.27)	-
1640-50-	<input type="checkbox"/> -0	19.69 (500)	21.02 (534)	≈ 4.94 (7.35)	-
1640-51-	<input type="checkbox"/> -0	20.16 (512)	21.50 (546)	≈ 4.95 (7.36)	-
1640-52-	<input type="checkbox"/> -0	20.67 (525)	22.01 (559)	≈ 4.97 (7.39)	-
1640-53-	<input type="checkbox"/> -0	21.14 (537)	22.48 (571)	≈ 5.03 (7.49)	-
1640-55-	<input type="checkbox"/> -0	21.65 (550)	22.99 (584)	≈ 5.24 (7.80)	-
1640-60-	<input type="checkbox"/> -0	23.62 (600)	24.96 (634)	≈ 5.32 (7.92)	-

Choose from the radii below for all of the above sizes

Radius (mm) Example: 1640-30-300-0

	200**	250	300	350	400	450	500	550	600
<i>R</i>	7.87 (200)	9.84 (250)	11.81 (300)	13.78 (350)	15.75 (400)	17.72 (450)	19.68 (500)	21.65 (550)	23.62 (600)
<i>H</i>	21.46 (545)	25.39 (645)	29.41 (747)	33.27 (845)	37.20 (945)	41.14 (1045)	45.08 (1145)	49.02 (1245)	52.95 (1345)
<i>D</i>	16.34 (415)	18.31 (465)	20.27 (515)	22.24 (565)	24.21 (615)	26.18 (665)	28.15 (715)	30.12 (765)	32.09 (815)
<i>K</i>	36.22 (920)	42.52 (1080)	48.82 (1240)	55.12 (1400)	61.42 (1560)	67.72 (1720)	73.62 (1870)	79.53 (2020)	85.63 (2175)

0=Standard color black. For other colors see Chapter 1

For wider chains see page 6.257. For large diameter hoses see page 6.257

PDF: igus.com/e-chain-pdfs
Product information: igus.com/e-chains



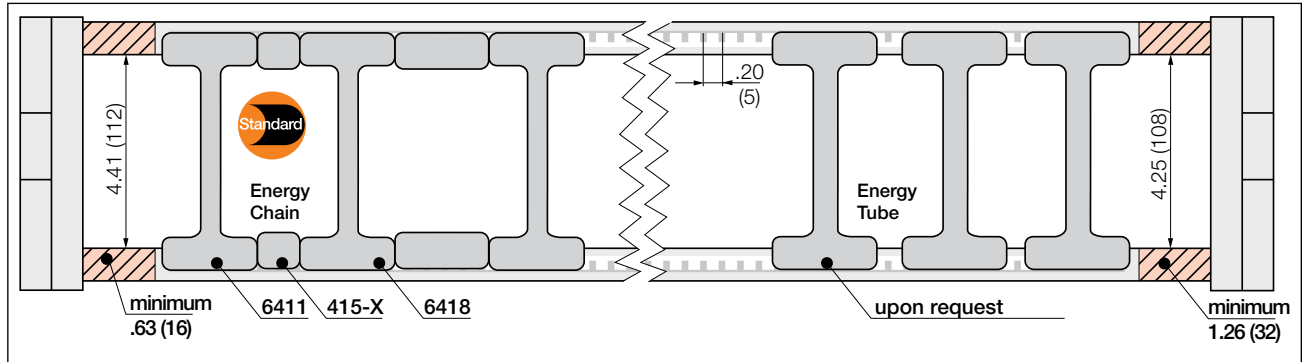

Note Please maintain a lateral spacing of 1.26" (32 mm) for e-tube and .63" (16 mm) for e-chains® between the separators and the side links. In the standard configuration separators are assembled every 2nd e-chain® link

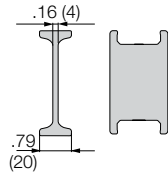

Separator (chain only)

Unassembled	Part No. 6401
Assembled	Part No. 6411

- **Standard separator 6401 for e-chains®**
For a vertical subdivision. Offers safe stability due to its wide base design, also when used with thick cables or hoses (Separator for e-tubes 1608 upon request)

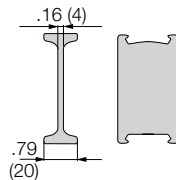

Separator, locking (chain only)

Unassembled	Part No. 6408
Assembled	Part No. 6418

- **Separator 6408 for e-chains®**
For applications exposed to very high humidity (>85%). Locks with extra retention force. Tip: one locking separator per e-chain® link for better mounting.

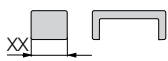

Spacer (chain only)

Unassembled	Part No. 405-XX
Assembled	Part No. 415-XX

XX = width of the spacer

Spacers available in the following sizes:

Part No. Unassembled	Part No. Assembled	Width	
		in.	(mm)
405 -10	415 -10	.39"	(10)
405 -15	415 -15	.59"	(15)
405 -20	415 -20	.79"	(20)
405 -30	415 -30	1.18"	(30)
405 -40	415 -40	1.57"	(40)

- **NOTE ON SPACERS for e-chains®**
Vertical separators are adjustable, but can be fixed in position by means of a spacer. Spacers are most often necessary for side mounted applications. The available inner height is reduced by .08" (2mm) **per spacer** (for example if one spacer is placed on either side of the separator, the overall inner height is reduced by .16" (4mm)). To avoid this, place the spacers on the **outside** of the opening crossbar (**not for long travels**).

Additional elements - interior separation

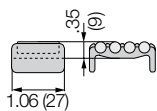

Rollclip

Unassembled	Part No. 489-27
Assembled	Part No. 490-27

- **Rollclip** - minimizes abrasion of particularly sensitive hoses or cables in an e-chain®. The integrated rollers compensate for relative movement between the chain and the hose or cable. This reduces the abrasion of the hoses or cables

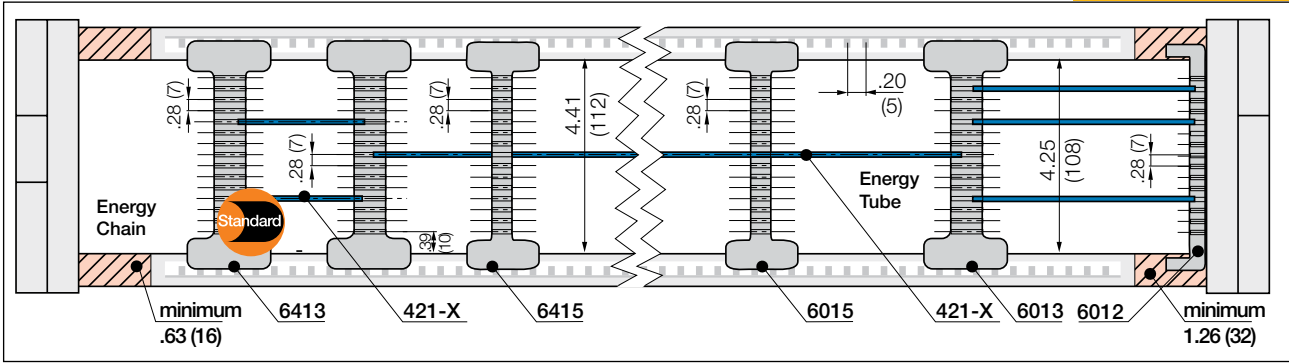

Note Please maintain a lateral spacing of 1.26" (32 mm) for e-tube and .63" (16 mm) for e-chains® between the separators and the side links. In the standard configuration separators are assembled every 2nd e-chain® link

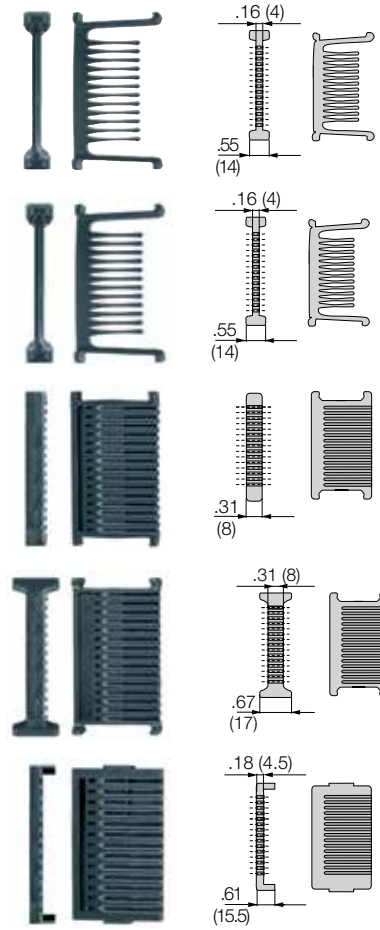

Slotted separator, open (e-chains®)

Unassembled	Part No. 6405
Assembled	Part No. 6415

Slotted separator, open (e-tubes)

Unassembled	Part No. 6005
Assembled	Part No. 6015

Vertical separator (e-chains®)

Unassembled	Part No. 6403
Assembled	Part No. 6413

Vertical separator, locking (e-tubes)

Unassembled	Part No. 6003
Assembled	Part No. 6013

Side plate

Unassembled	Part No. 6002
Assembled	Part No. 6012

- Open, slotted separator 6405**
For e-chains® (unilateral open)
 This separator can be retrofitted into an existing interior separation system without removing the shelves. The top and bottom botches cannot be occupied by shelves
- Open, slotted separator 6005**
For e-tubes (unilateral open)
 This separator can be retrofitted into an existing interior separation system without removing the shelves. The top and bottom botches cannot be occupied by shelves
- Vertical separator 6403**
For e-chains®
 This component is used to form the basic pattern of a shelf system. The shelf 420-X can be installed at 15 different heights in .28" (7 mm) increments
- Locking vertical separator 6003**
For e-tubes
 This component is used to form the basic pattern of a shelf system.
- Side plate 6002**
For e-chains® / Tubes
 This component is used to form the basic pattern of a shelf system. Allows modular shelving close to the side links.

Full-width shelves - for the standard interior separation

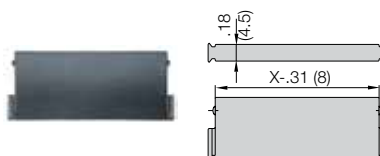

Full width shelf

Unassembled	Part No. 420-X
Assembled	Part No. 421-X

- Full width shelf 420-X**
 These components form the basic pattern of a shelf system. Shelves of various widths can be arranged at 7 different heights in .28" (7mm) increments

Width X in. (mm)	Part No. Unassembled	Part No. Assembled	Width X in. (mm)	Part No. Unassembled	Part No. Assembled	Width X in. (mm)	Part No. Unassembled	Part No. Assembled
.71 (18)	420-18	421-18	1.97 (50)	420-50	421-50	5.91 (150)	420-150	421-150
.91 (23)	420-23	421-23	2.44 (62)	420-62	421-62	6.89 (175)	420-175	421-175
.98 (25)	420-25	421-25	2.95 (75)	420-75	421-75	7.36 (187)	420-187	421-187
1.10 (28)	420-28	421-28	3.46 (88)	420-88	421-88	7.87 (200)	420-200	421-200
1.30 (33)	420-33	421-33	3.94 (100)	420-100	421-100			
1.69 (43)	420-43	421-43	4.92 (125)	420-125	421-125			

PDF: igus.com/e-chain-pdfs
Product information: igus.com/e-chains





Extension links - for extremely wide e-chains® up to 9.84 ft (3m)

- For applications in which particularly high fill weights necessitate extremely wide e-chains®
- The extension link design allows virtually limitless side-by-side attachment of chains
- The unsupported length of a chain can be increased when additional loads are required
- Extension links can be used with e-chains®, e-tubes or a combination of both
- They are suitable for unsupported and gliding applications in a guide trough
- e-chains® with extension links are attached with KMA or steel mounting brackets.

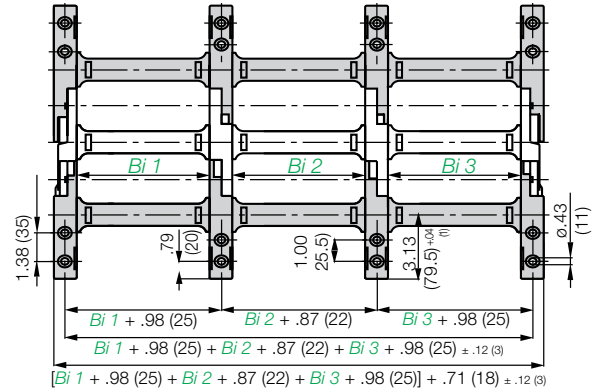

Part number example for e-chain®

1640-10/20/10-**200**-0
1640-Bi1/Bi2/Bi3-**R**-0

We strongly recommend on-site consultation with an igus® technician for individual advice regarding mounting brackets, guide troughs and other design details.



Consult igus® for your extender crossbar applications. We will be happy to assist you with your design layout.

Extender crossbars - For careful guiding of large diameter cables and hoses

- Intended for cables and hoses with a maximum outer diameter of 11.81 in. (300 mm).
- Can be attached along either the inner or outer radius, inner radius preferred
- Gliding operation with crossbars assembled along the outer radius in conjunction with a special guide trough
- Gliding operation not guaranteed with crossbars assembled along the inner radius
- The extender crossbar can either be attached to the side links directly or can be used in combination with two standard snap-open crossbars.

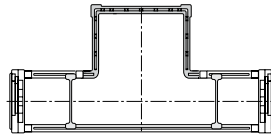

Square extender crossbar combined with standard snap-open crossbars.

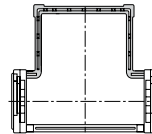

Attached directly to the side link.

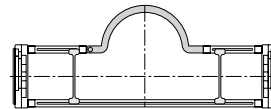

Round extender crossbar combined with standard snap-open crossbars.

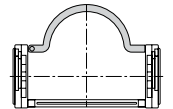

Attached directly to the side link.

Part No.	Max Ø Hose	Style	Installation Side Link	Combined with Snap-Open Crossbars
450-15-RHD115	4.52 (115)	Round	No	Yes
450-17-RD115	4.52 (115)	Round	Yes	No
450-25-D150	5.91 (150)	Square	Yes	No
450-30-D200	7.09 (180)	Square	Yes	No
450-35-D250	7.68 (195)	Square	Yes	No
450-40-D300	9.65 (245)	Square	Yes	No
450-20-HD150	5.91 (150)	Square	No	Yes
450-25-HD200	7.09 (180)	Square	No	Yes
450-30-HD250	7.68 (195)	Square	No	Yes

E4 clip on cable binder

- For side mounted applications
- Serves as a clip-on, lateral guide for hoses and cables on e-chains®
- The loops can be adjusted as needed

- Compatible with many E4 e-chains®
- Economical
- One clip and one locking band are needed for each chain link



Part No.	Form
450-B12	Locking clip, comprised of a locking element
450-B12-200	Locking band, comprised of a locking element and band; 12 x 1.5 x 200 mm

e-chain system® E4 light

Series 1640/R1608

Mounting Brackets - Steel



1640
R1608

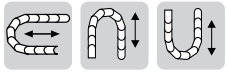

Option 1: pivoting

- For pivoting connections
- One part for all chain widths
- Electrically conductive

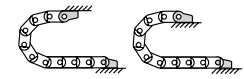
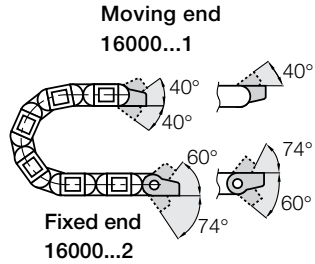

Possible installation configurations -

Part No. Mounting Brackets Full Set

4 parts, 2 with pin, 2 with bore
Series 1640 or R1608
16000-12

Part No. Mounting Bracket Moving End

2 parts, 1 left & 1 right with bore
Series 1640 or R1608
16000-1

Part No. Mounting Bracket Fixed End

2 parts, 1 left & 1 right with pin
Series 1640 or R1608
16000-2

Due to the design of the E4/100 series chains,
please note the following when ordering brackets:

Even number of links = full set, part number ending in -12
Odd number of links = 2 pieces, part number ending in -1

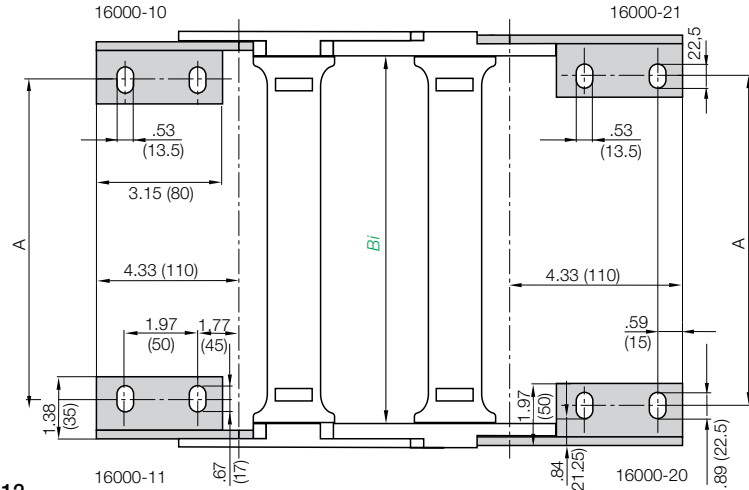

Bracket Mounting dimensions

Mounting Brackets						Mounting Brackets					
Width of Chain <i>Bi</i>	Part Number	Full Set	Moving End Only	Fixed End Only	A in. (mm)	Width of Chain <i>Bi</i>	Part Number	Full Set	Moving End Only	Fixed End Only	A in. (mm)
1.97 (50)	16000	-12	-1	-2	.79 (20)	12.28 (312)	16000	-12	-1	-2	11.10 (282)
2.56 (65)	16000	-12	-1	-2	1.38 (35)	12.79 (325)	16000	-12	-1	-2	11.61 (295)
2.95 (75)	16000	-12	-1	-2	1.77 (45)	13.27 (337)	16000	-12	-1	-2	12.09 (307)
3.43 (87)	16000	-12	-1	-2	2.24 (57)	13.78 (350)	16000	-12	-1	-2	12.60 (320)
3.94 (100)	16000	-12	-1	-2	2.76 (70)	14.25 (362)	16000	-12	-1	-2	13.07 (332)
4.41 (112)	16000	-12	-1	-2	3.23 (82)	14.76 (375)	16000	-12	-1	-2	13.58 (345)
4.92 (125)	16000	-12	-1	-2	3.74 (95)	15.24 (387)	16000	-12	-1	-2	14.06 (357)
5.39 (137)	16000	-12	-1	-2	4.21 (107)	15.75 (400)	16000	-12	-1	-2	14.57 (370)
5.91 (150)	16000	-12	-1	-2	4.72 (120)	16.22 (412)	16000	-12	-1	-2	15.04 (382)
6.38 (162)	16000	-12	-1	-2	5.20 (132)	16.73 (425)	16000	-12	-1	-2	15.55 (395)
6.89 (175)	16000	-12	-1	-2	5.71 (145)	17.20 (437)	16000	-12	-1	-2	16.02 (407)
7.36 (187)	16000	-12	-1	-2	6.18 (157)	17.72 (450)	16000	-12	-1	-2	16.54 (420)
7.87 (200)	16000	-12	-1	-2	6.69 (170)	18.19 (462)	16000	-12	-1	-2	17.01 (432)
8.35 (212)	16000	-12	-1	-2	7.16 (182)	18.70 (475)	16000	-12	-1	-2	17.52 (445)
8.86 (225)	16000	-12	-1	-2	7.68 (195)	19.17 (487)	16000	-12	-1	-2	17.99 (457)
9.33 (237)	16000	-12	-1	-2	8.15 (207)	19.69 (500)	16000	-12	-1	-2	18.50 (470)
9.84 (250)	16000	-12	-1	-2	8.66 (220)	20.16 (512)	16000	-12	-1	-2	18.98 (482)
10.31 (262)	16000	-12	-1	-2	9.13 (232)	20.67 (525)	16000	-12	-1	-2	19.49 (495)
10.83 (275)	16000	-12	-1	-2	9.65 (245)	21.14 (537)	16000	-12	-1	-2	19.96 (507)
11.30 (287)	16000	-12	-1	-2	10.12 (257)	21.65 (550)	16000	-12	-1	-2	20.47 (520)
11.81 (300)	16000	-12	-1	-2	10.63 (270)	23.62 (600)	16000	-12	-1	-2	22.44 (570)

PDF: igus.com/e-chain-pdfs
Product information: igus.com/e-chains



Tiewrap Plates

Tiewrap plates as an individual part

Available as an individual component, can be fixed onto a mounting bracket with the use of a profile rail.

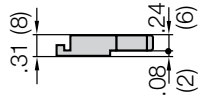
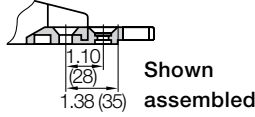

Tiewrap Plate	n Number of Teeth	C Overall Width in. (mm)	B Bore Width in. (mm)	Center Bore
3050-ZB	5	1.97 (50)	1.18 (30)	no
3075-ZB	7	2.95 (75)	2.16 (55)	no
3100-ZB	10	3.94 (100)	3.15 (80)	no
3115-ZB	11	4.53 (115)	3.74 (95)	no
3125-ZB	12	4.92 (125)	4.13 (105)	no
3150-ZB	15	5.91 (150)	5.12 (130)	no
3175-ZB	17	6.89 (175)	6.10 (155)	no
3200-ZB	20	7.87 (200)	7.09 (180)	yes
3225-ZB	22	8.86 (225)	8.07 (205)	yes
3250-ZB	25	9.84 (250)	9.06 (230)	yes

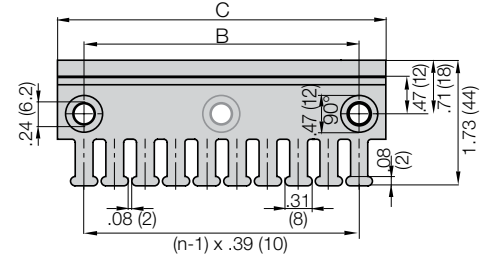

For more information please refer to strain relief section of Chapter 10





igus[®]
System T3
E3
E6-1
E6

T3

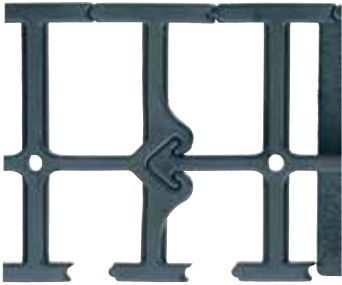

System T3 - Highly flexible, low vibration band chain without pin and bore connection

- For short strokes with extreme demands in low noise and dynamics
- For high speed and high accelerations
- Very low weight
- Hardly any abrasion
- Cost efficient, 3-piece e-chain®

System T3 ▶



E3

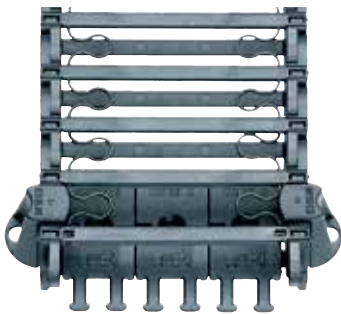

System E3 - Elastic, dampening connector strip replaces pins and bores

- Extremely low noise e-chain® for small spaces with modular 3-piece link design
- 3 sizes available
- Inner heights: .39" (10 mm), .59" (15 mm), .87" (22 mm)

System E3 ▶



E6-1



System E6-1 - Connector replaces pins and bores

- Low noise - from a noise level of 32 dB(A)
- 30% Lighter than the System E6
- 4 sizes available
- Inner heights: 1.14" (29 mm), 1.38" (35mm), 1.57" (40 mm), 2.05" (52 mm)

System E6 ▶



E6



System E6 - Connector replaces pins and bores

- Extremely low noise e-chain® with high stability and tensile strength
- Modular 6-piece link design
- 5 sizes available
- 3 types available (e-chain®, E-Tube, Light version)
- Inner heights: 1.14" (29 mm), 1.57" (40 mm), 2.05" (52 mm), 2.44" (62 mm), 3.15" (80 mm)

System E6 ▶



e-chain system® T3, E3, E6-1 and E6

The extremely low noise igus® e-chain® - System E3, System E6 and System T3

The e-chain® of the E3, E6 and T3 Series have extremely good low noise and vibration performance. The special, abrasion-resistant spring elements replace the conventional pin and bore connection of the chain links enabling the low noise and low vibration operation of the e-chain®. Due to the special fastening system, these e-chains® have minimal wear and abrasions and are therefore suitable for cleanroom applications.

Another advantage of the connector is that in the application of an electrically conductive material it can guarantee constant conductivity value. The e-chain® Series E3, E6 and T3 offer an extensive accessories package and are available in many sizes off the shelf.

Measurement values of sound pressure levels dB(A) in comparison

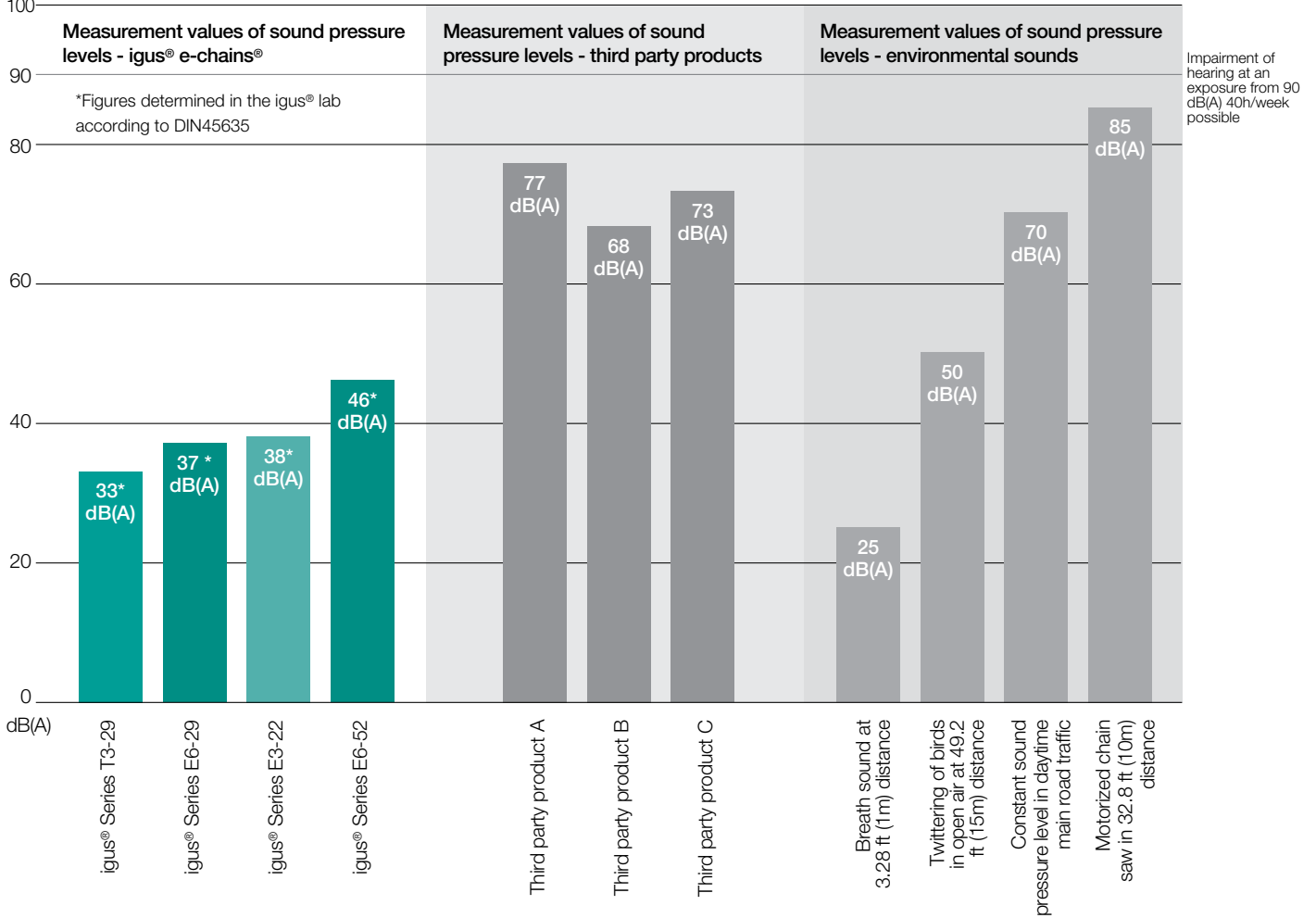

Results of measurement

Particle generation measurement:

For a total of 100 minutes, the air around the moving test object is analyzed for particles.

Result: NO particles larger $\geq 0.2 \mu\text{m}$ were measured.

Result according to DIN EN ISO 14644-1	e-chain® Series	Report No.	Speed ft/s (m/s)
ISO Class 1	E3-15-040-075-0	IG0704-400	1.64 / 3.28 / 6.56 (0.5 / 1.0 / 2.0)
ISO Class 1	E6-29-060-150-CR	IG0704-400	1.64 / 3.28 / 6.56 (0.5 / 1.0 / 2.0)
ISO Class 1	E61-29-050-075-0	IG1303-640-1	1.64 / 3.28 / 6.56 (0.5 / 1.0 / 2.0)
ISO Class 2	T3-29-050-038-0	IG1303-640-1	1.64 / 3.28 / 6.56 (0.5 / 1.0 / 2.0)
ISO Class 3	E6-29-060-150-0	IG0704-400	1.64 / 6.56 (0.5 / 2.0)



e-chain systems® E6-1, E3, E6.29.CR certified according to DIN EN ISO 14644-1 Class 1, by the Fraunhofer IPA Institute.

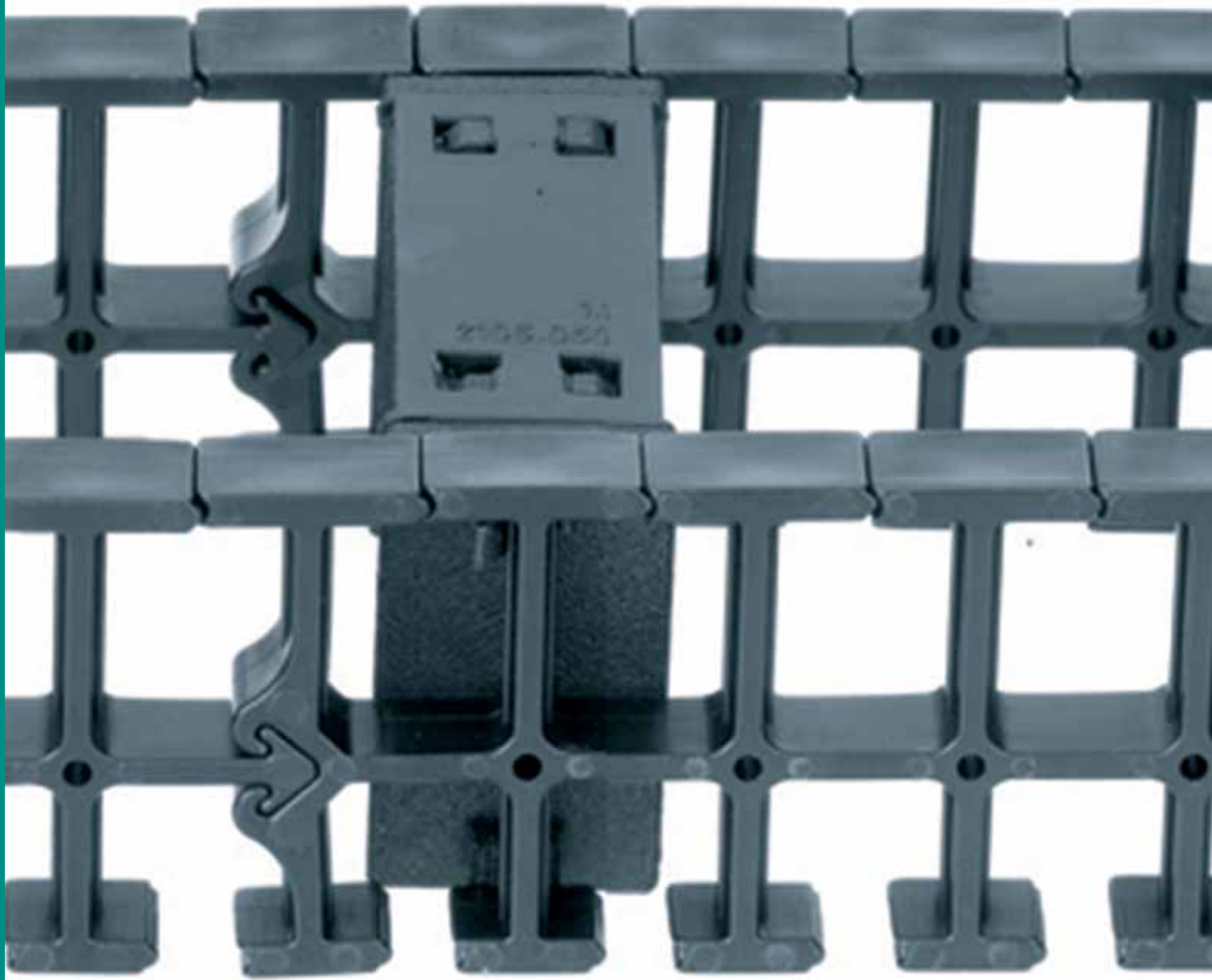

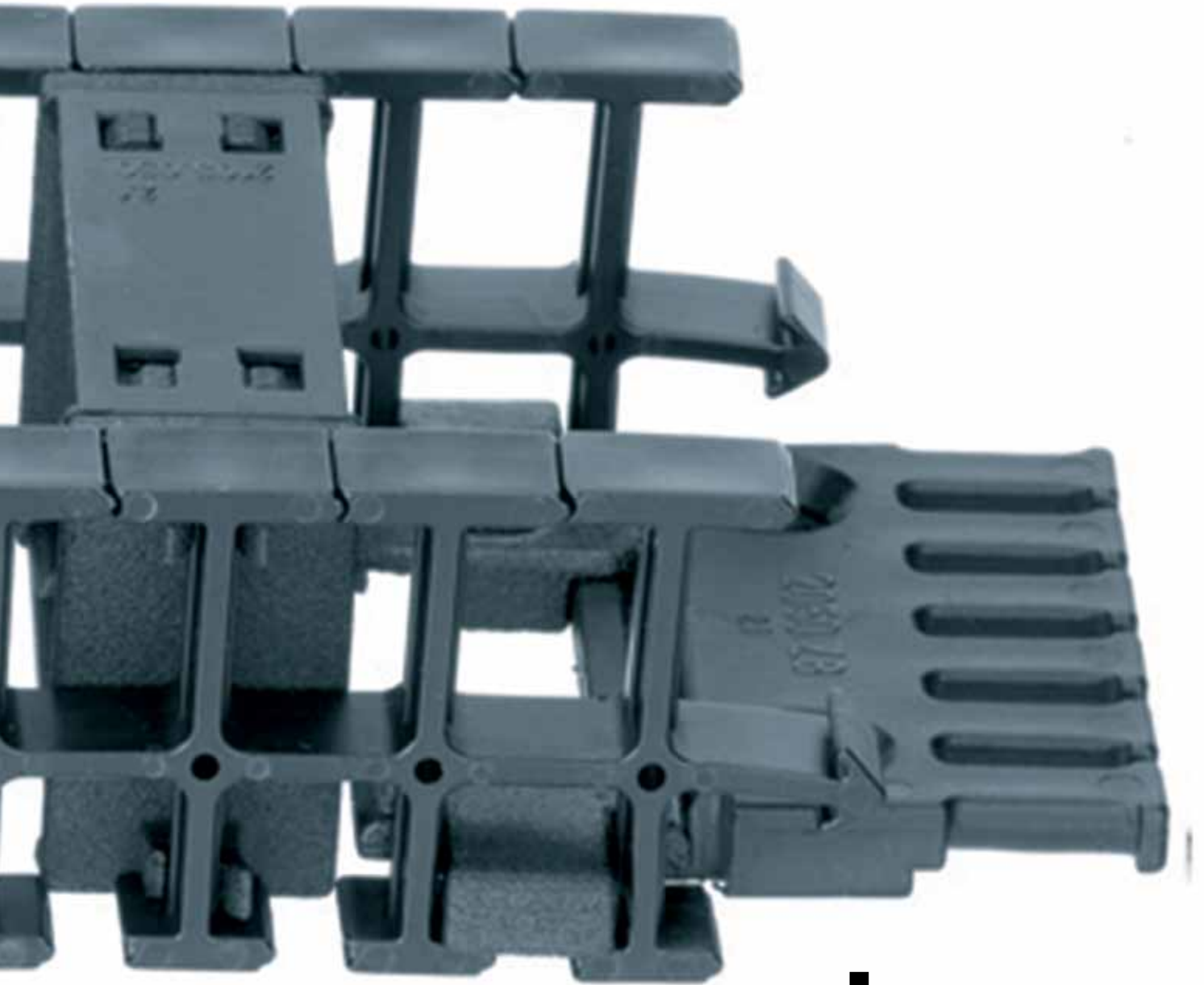

igus[®]
System T3
Highly flexible & low-vibration

System T3 - Highly flexible, low vibration band chain

The T3-System combines low-noise operation, low sound level, simple installation and economy. The side plates that can be plugged into each other replace the conventional pin and bore connection and prevent relative movements between the joints, giving an almost complete freedom from wear. By the unique geometrical shape of the T-band, hardly any polygon effect is generated in operation. The T-band operates in a very smooth arc giving extremely low vibration and noise. In order to reduce the manufacturing and installation costs, the T-band is mounted in a length of 8 chain links. Due to its low mass, the igus® T-band, combined with high speeds and accelerations, is suitable for applications with low fill weights and short strokes.

Typical industries and applications

- Printer and plotter
- Cleanroom applications
- Production and processing of semiconductors
- Optics
- Automatic insertion machines
- Measuring technology



igus® tests at 3.28 ft (1 m) measuring distance: = 33 dB(A) for T3-29-050-038-0 at $v = 3.28$ ft/s (1 m/s) and 26.5 dB(A) basic sound level



Cleanroom test upon request





T3 system on the Z-axis in the positioning system. It has very low vibration and is quiet.



Testing facility at the igus® laboratory System T3 - ideal for high accelerations and short strokes

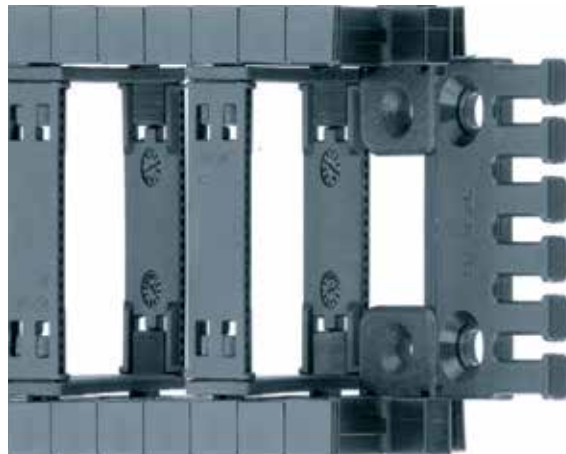

igus® System T3 T band chain - Inner height 1.14" (29 mm)

Next Page ► Find selection table and assembly instructions

e-chain[®] T3 Selection Guide

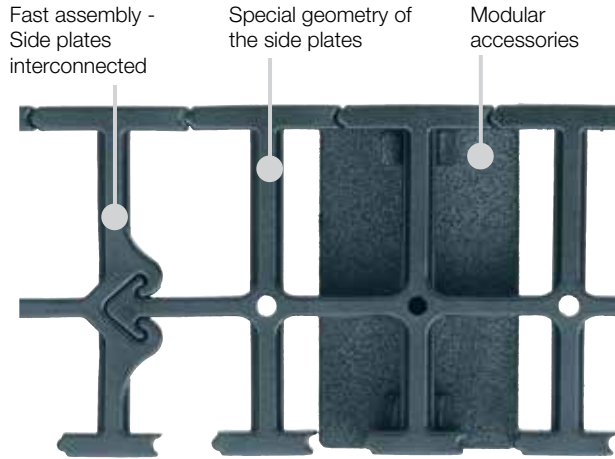

T3: e-chain[®] band for highly dynamic applications

In the development of the 3-piece, T-shaped band chain “T3”, the main focus was on minimum operational noise with lowest cost. This is achieved by the side-plate band consisting of 8 chain links in one piece, as well as the use of existing components of the popular E6 range. Due to the short pitch of the links, the curve section of the e-chain remains fairly round. The omission of a pin and bore connection means the T3 band chain features extremely low abrasion and wear and hence is good for cleanroom applications.

- Extremely low noise and low vibration
- Low-priced e-chain[®] for simple applications
- For high speeds and accelerations
- Very low weight
- Hardly any abrasion
- For short strokes
- Accessories: Separators, integrated strain relief, mounting brackets
- You can find more technical data about the material, chemical resistance, temperatures ► **Design, Section 1**

Series	Inner height <i>hi</i> in. (mm)	Inner width <i>Bi</i> in. (mm)	Outer width <i>Ba</i> in. (mm)	Outer height <i>ha</i> in. (mm)	Bending radius <i>R</i> in. (mm)
T3-29	1.14 (29)	1.18-5.51 (30-140)	2.17-6.50 (55-165)	1.38 (35)	1.50 (038)



Available from stock. Orders ship as early as today.*

*On average 90% of orders ship the same day..

e-chain system® T3 Assembly Instructions

System T3 - 3-piece e-chain®



The abbreviation “T3” stands for a T-shaped E band, which consists of three basic elements:

- ❶ 2 side-plate bands (left/right)
- ❷ Separator element including separators

System T3 - Assembling



Side plates to be plugged into each other

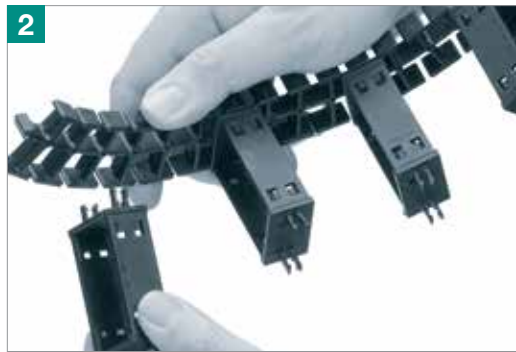

Clip-on “interior separation clips”



System T3 enables quick installation times. The side plates can be simply plugged in

System T3 - Interior Separation and Strain Relief



Separators for dividing the chain cross section from the proven and tested E6 range (E6-29)

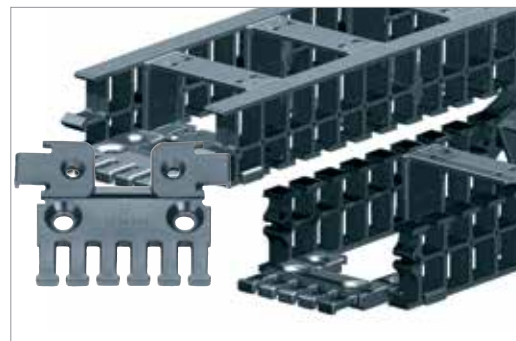

Universal strain relief through optional mounting angle. You can attach the e-chain® at the fixed end, if necessary

Price Index

Series T3-29

Special Features / Options

Extremely low noise
 Test results upon request

Cleanroom test upon request

Assembly Tips

Fast assembly due to side link strip

Usage Guidelines



- At very high speeds and/or accelerations
- If a very light e-chain® is required
- If a particularly low-cost e-chain® is required
- For small bending radii and small spaces
- If easy filling and assembly is required
- Minimal abrasion (e.g. cleanroom applications)



- When an e-chain® is required for more fill weight
 ► **Series E6-29**
- When an enclosed e-chain® is required for low noise operation
 ► **Series R6-29**

Features & Benefits

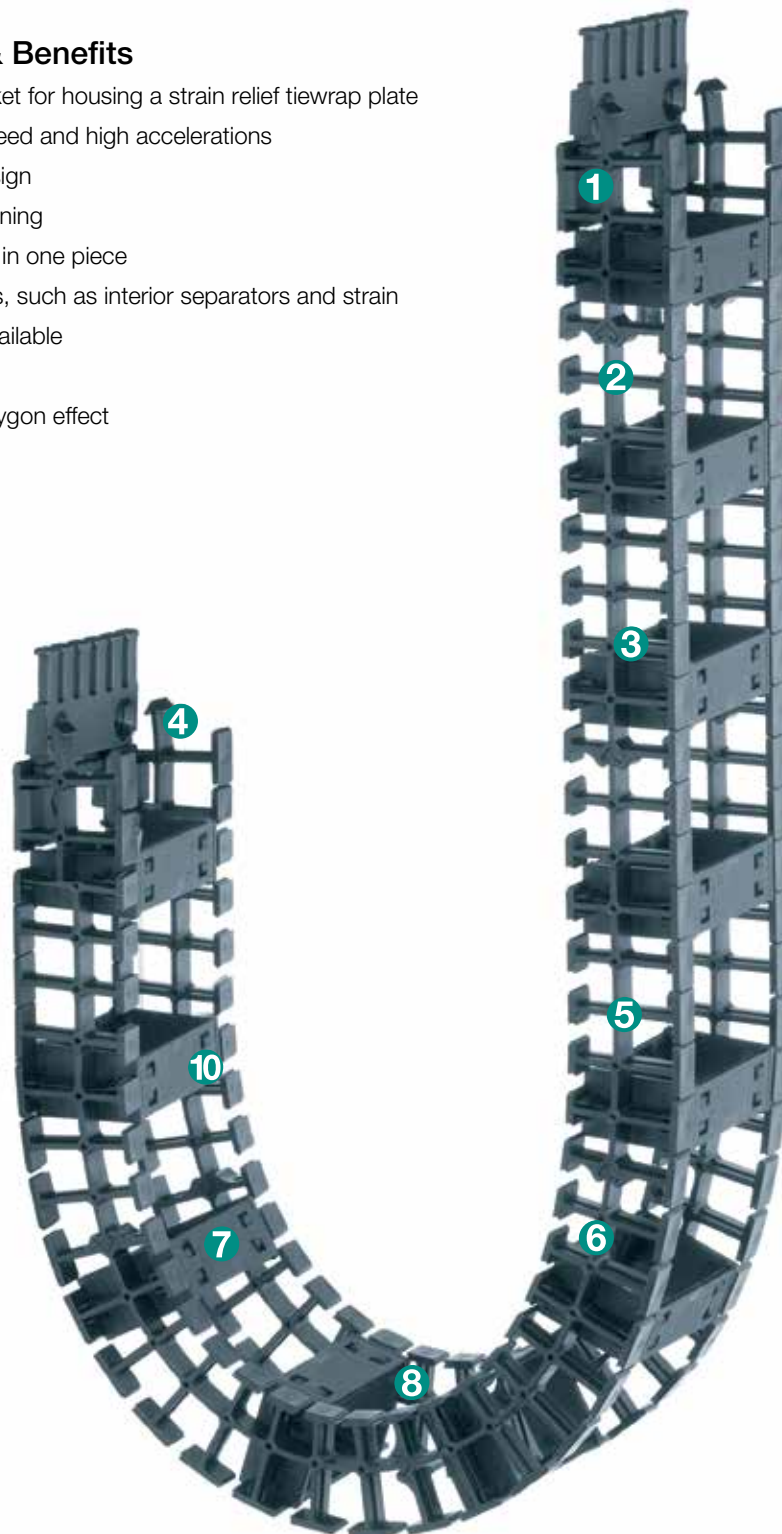
- 1 Angle bracket for housing a strain relief tiwrap plate
- 2 For high speed and high accelerations
- 3 3-piece design
- 4 Easy shortening
- 5 Side plates in one piece
- 6 Accessories, such as interior separators and strain relief are available
- 7 Low weight
- 8 Minimal polygon effect

Order Example: Complete e-chain®

Please indicate chain length or number of links. Example:

3.28 ft (1 m) **T3-29-050-038-0**

e-chain®

With 2 separators **29-1-1** assembled every 2nd link

Interior Separation

1 Set **T3-29-050-12**

Mounting Bracket

e-chain system® T3

Series T3-29

Installation Dimensions



T3-29

Short travel, unsupported length

- FL_B = unsupported with permitted sag
 - FL_G = unsupported with straight upper run
- Further information ► Design, Chapter 1

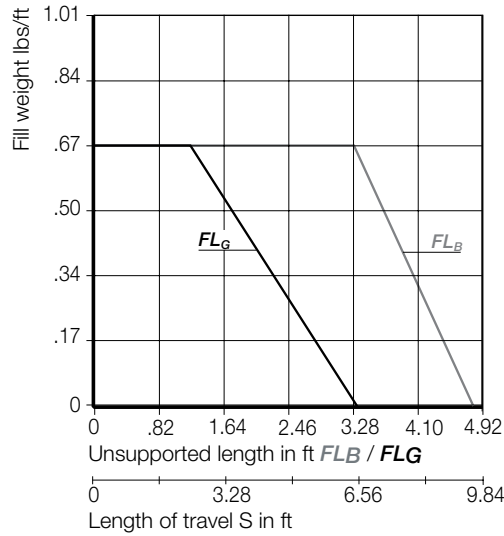
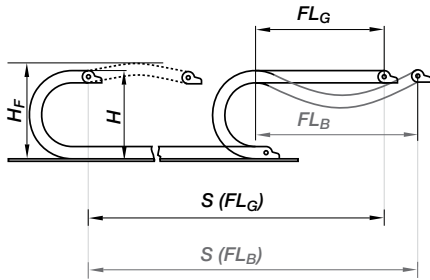

Short Travels - Unsupported



Unsupported e-chains® feature positive camber over short travels. This must be accounted for when specifying the clearance height. Please refer to **Installation dimensions** for further details.

Legend

- S = Length of travel
- R = Bending radius
- H = Nominal clearance height
- D = Overlength e-chain® radius in final position
- $K = \pi \cdot R + \text{safety buffer}$
- H_F = Required clearance height

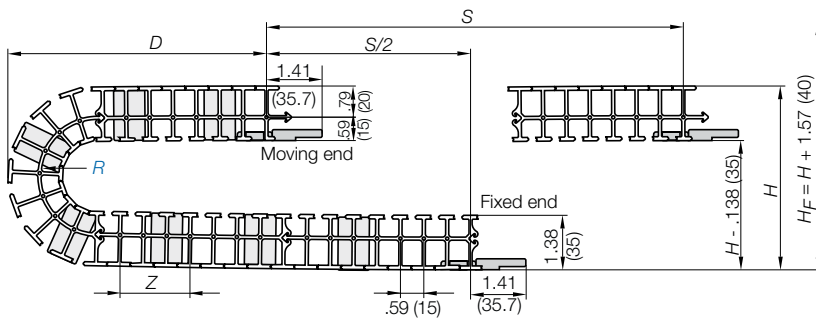

Pitch per link = $.59^\circ$ (15 mm)

Links per ft (m) = 20 (67)

For center mount applications:

Chain length = $\frac{S}{2} + K$

The required clearance height: $H_F = H + 1.57$ in. (40 mm) (with 0.67 lbs/ft (1.0 kg/m) fill weight). Please consult igus® if space is particularly restricted.

R	1.50 (038)
H	8.50 (216)
D	4.57 (111)
K	8.27 (210)

Speed / acceleration FL_G	max. 65.6 ft/s (20 m/s) / max. 656 ft/s ² (200 m/s ²)
Speed / acceleration FL_B	max. 9.84 ft/s (3 m/s) / max. 19.69 ft/s ² (6 m/s ²)
Gliding speed / acceleration (maximum)	upon request
Permitted temperature	-40°F (-40°C) up to +158°F (+70°C)
Flammability Class	VDE 0304 IIC UL94 HB

Technical Data



Details of material properties

► Design, Chapter 1

29

PDF: igus.com/e-chain-pdfs
Product information: igus.com/e-chains

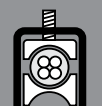

Series T3-29 - e-chain® with crossbars every other link

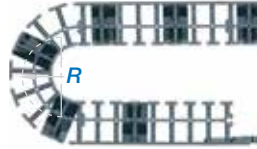
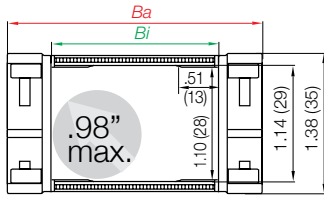

Part Number Structure



- Color - Black
- Bending radius
- Width
- Series

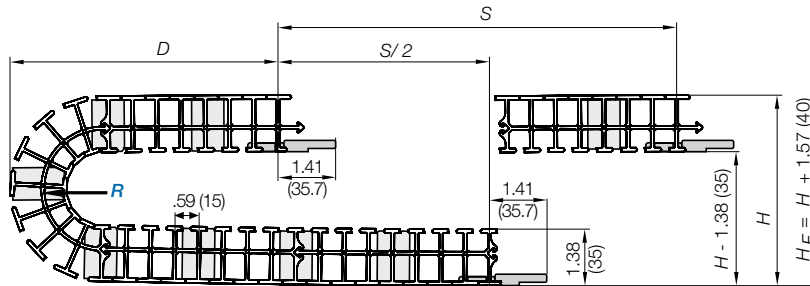

Supplement part number with required radius. Example: T3-29-100--0
Pitch: .59 in. (15 mm) per link links/ft (m) = 20 (67)

Part Number	Bi in. (mm)	Ba in. (mm)	Weight lbs/ft (kg/m)
T3-29-030- <input type="text" value=""/> -0	1.18 (30)	2.16 (55)	≈ 0.27 (0.40)
T3-29-040- <input type="text" value=""/> -0	1.57 (40)	2.56 (65)	≈ 0.28 (0.42)
T3-29-050- <input type="text" value=""/> -0	1.97 (50)	2.95 (75)	≈ 0.30 (0.44)
T3-29-060- <input type="text" value=""/> -0	2.36 (60)	3.35 (85)	≈ 0.31 (0.46)
T3-29-070- <input type="text" value=""/> -0	2.76 (70)	3.74 (95)	≈ 0.32 (0.48)
T3-29-080- <input type="text" value=""/> -0	3.15 (80)	4.13 (105)	≈ 0.34 (0.50)
T3-29-090- <input type="text" value=""/> -0	3.54 (90)	4.53 (115)	≈ 0.34 (0.51)
T3-29-100- <input type="text" value=""/> -0	3.94 (100)	4.92 (125)	≈ 0.36 (0.53)
T3-29-110- <input type="text" value=""/> -0	4.33 (110)	5.31 (135)	≈ 0.37 (0.55)
T3-29-120- <input type="text" value=""/> -0	4.72 (120)	5.71 (145)	≈ 0.38 (0.57)
T3-29-140- <input type="text" value=""/> -0	5.51 (140)	6.50 (165)	≈ 0.40 (0.59)

Choose from the radii below for all of the above sizes

Radius (mm) Example: T3-29-100- -0

<input type="text" value="038"/>	
R	1.50 (038)
H	8.50 (216)
D	4.57 (111)
K	8.27 (210)



Interior separation elements

Distance "Z" for the interior separation elements of the T3 e-chain®

Note: The first and last chain links should not have interior separation elements! As a standard, crossbars are mounted on every 4th chain link!

Part No.

For other distances, e.g. every 6th chain link, change the part number as follows:

Part No.

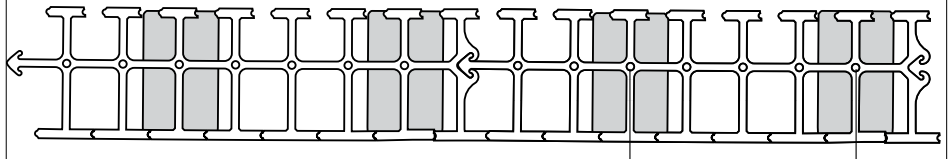

e-chain system® T3
Series T3-29
Interior Separation - New Generation



T3-29

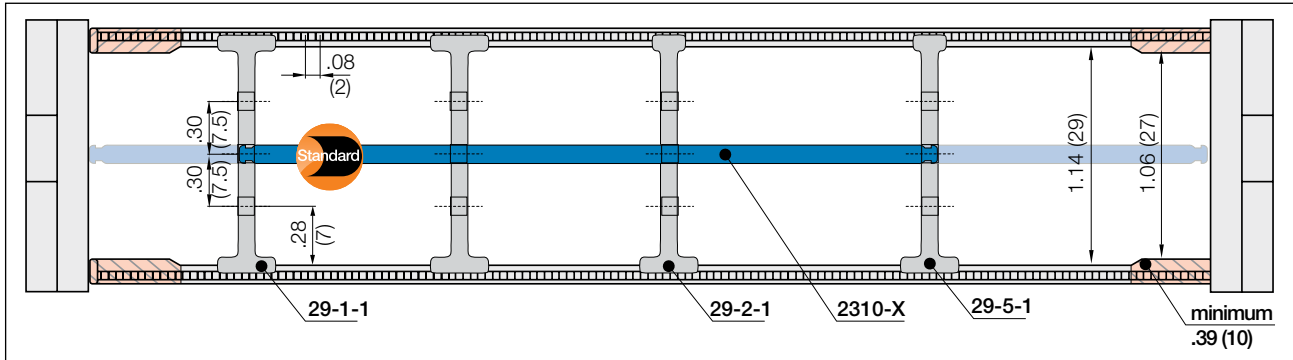

Note: Please maintain a lateral spacing of .39" (10 mm) between the separators and the side links.

In the standard configuration separators are assembled every 2nd e-chain® link

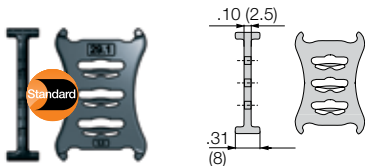

Separator, wide base

Unassembled	Part No. 29-1
Assembled	Part No. 29-1-1

- **Standard separator 29-1**
for all applications

Separator with wide base for maximum locking strength and safe standing in e-chains®.

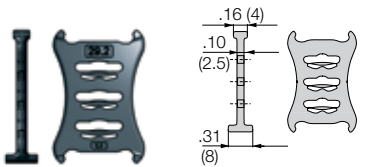

Separator, narrow head

Unassembled	Part No. 29-2
Assembled	Part No. 29-2-1

- **Separator 29-2**
For even faster installation

Firm hold to one side with a wide base, narrow on opposed side for easy cable assembly (slight grip)

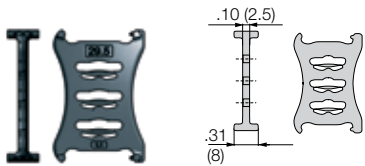

Separator, narrow base

Unassembled	Part No. 29-5
Assembled	Part No. 29-5-1

- **Notch separator 29-5**

Notch separator for exact positioning in e-chains®. Recommended for side mounted applications

Lockable full-width shelves - for the standard interior separation

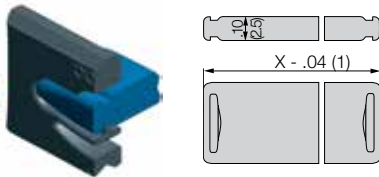

Full width shelf, lockable

Unassembled	Part No. 2300-X
Assembled	Part No. 2310-X

- **Full width shelf, lockable**

Full-width shelf locks safely into the separators on both ends, fixed width possible. Separators can be moved freely over the shelf in horizontal direction. Shelves can be arranged at 3 different heights.

Width X in. (mm)	Part No. Unassembled	Part No. Assembled	Width X in. (mm)	Part No. Unassembled	Part No. Assembled	Width X in. (mm)	Part No. Unassembled	Part No. Assembled
0.59 (015)	2300-015	2310-015	2.36 (060)	2300-060	2310-060	3.43 (087)	2300-807	2310-087
0.98 (025)	2300-025	2310-025	2.44 (062)	2300-062	2310-062	3.54 (090)	2300-090	2310-090
1.18 (030)	2300-030	2310-030	2.56 (065)	2300-065	2310-065	3.94 (100)	2300-100	2310-100
1.50 (038)	2300-038	2310-038	2.76 (070)	2300-070	2310-070	4.06 (103)	2300-103	2310-103
1.57 (040)	2300-040	2310-040	2.95 (075)	2300-075	2310-075	4.33 (110)	2300-110	2310-110
1.97 (050)	2300-050	2310-050	3.03 (077)	2300-077	2310-077	4.72 (120)	2300-120	2310-120
2.24 (057)	2300-057	2310-057	3.15 (080)	2300-080	2310-080	4.92 (125)	2300-125	2310-125

Separator with integrated strain relief

Strain relief separator Part No. E6-29-02-Z can be integrated into the mounting bracket and can be placed there at any point of the e-chain®. It combines strain relief and interior separation, it can be installed on the first or last e-chain® link and is easy to assemble without any screws.

For more information ► Chapter 10, Strain Relief



PDF: igus.com/e-chain-pdfs
Product information: igus.com/e-chains



Moving end
T3-29...2

Fixed end
T3-29...1

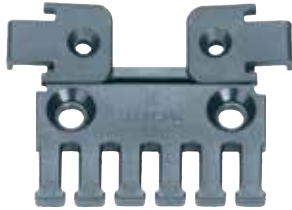
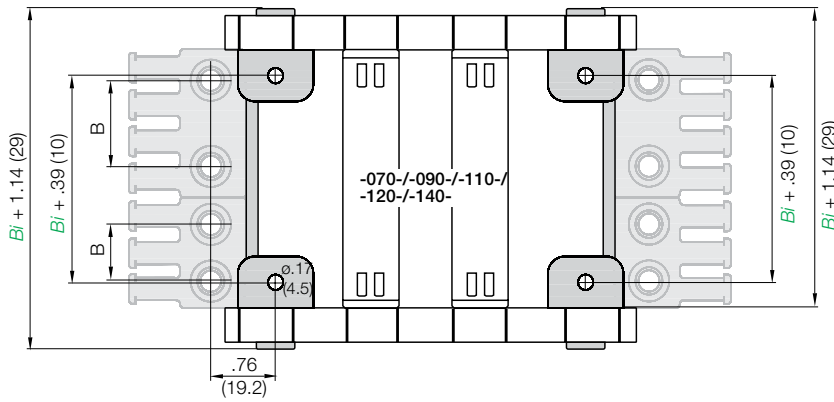
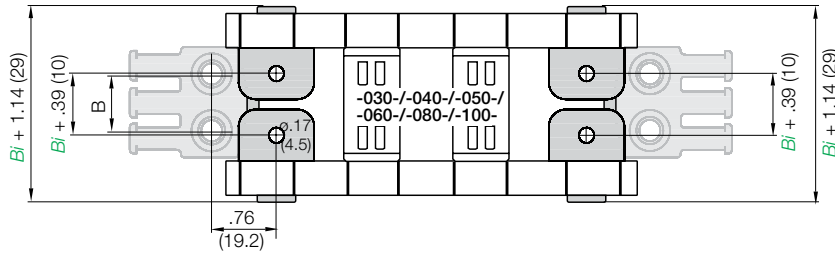

Mounting angle with strain relief



Mounting angle, single

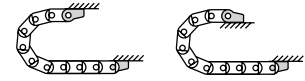

Possible installation configurations -

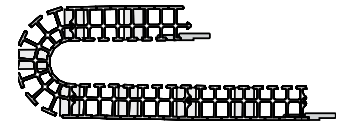

For Series	Part No. Full Set with tiewrap plate	Part No. Full Set without tiewrap plate	Bi in. (mm)	Dimension in. (mm)	Number of teeth
T3-29-030	T3-29-030-12PZ	T3-29-030-12	1.18 (30)	.59 (15)	3
T3-29-040	T3-29-040-12PZ	T3-29-040-12	1.57 (40)	.79 (20)	4
T3-29-050	T3-29-050-12PZ	T3-29-050-12	1.97 (50)	1.18 (30)	5
T3-29-060	T3-29-060-12PZ	T3-29-060-12	2.36 (60)	1.57 (40)	6
T3-29-070	T3-29-070-12PZ	T3-29-070-12	2.76 (70)	1.38 (15+20)	7
T3-29-080	T3-29-080-12PZ	T3-29-080-12	3.15 (80)	2.36 (60)	8
T3-29-090	T3-29-090-12PZ	T3-29-090-12	3.54 (90)	1.97 (20+30)	9
T3-29-100	T3-29-100-12PZ	T3-29-100-12	3.94 (100)	3.15 (80)	10
T3-29-110	T3-29-110-12PZ	T3-29-110-12	4.33 (110)	2.75 (30+40)	11
T3-29-120	T3-29-120-12PZ	T3-29-120-12	4.72 (120)	3.14 (40+40)	12
T3-29-140	T3-29-140-12PZ	T3-29-140-12	5.51(140)	3.93 (60+40)	14

Part Number Structure



Complete Set
Width
Series

Full set, for both ends:

T3-29-030-12 Full set, both fixed and moving end

Single-part order:

T3-29-030-1 Mounting bracket fixed end

T3-29-030-2 Mounting bracket moving end

e-chain system® T3
 Series T3-29
 Strain Relief, Additional installation options



T3-29

Strain Relief

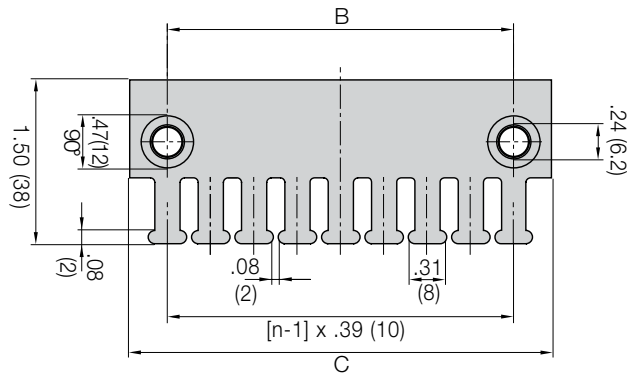
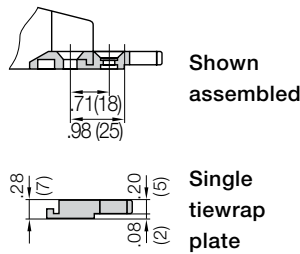

igus® chainfix tiewrap plate as individual part

Tiewrap Plates	n Number of Teeth	Dimension C	Dimension B	
2020-ZB	3	1.18 (30)	.59 (15)	
2030-ZB	4	1.57 (40)	.79 (20)	
2040-ZB	5	1.97 (50)	1.18 (30)	
2050-ZB	6	2.36 (60)	1.57 (40)	
2070-ZB	8	3.15 (80)	2.36 (60)	
2090-ZB	9	3.54 (90)	2.76 (70)	Use (2030-ZB + 2040-ZB)
2100-ZB	10	3.94 (100)	3.15 (80)	
2125-ZB	12	4.72 (120)	3.94 (100)	Use (2050-ZB + 2050-ZB)

● Also available:
 Separator with integrated strain relief
 for use in the first or last chain link
(Part No. E6-29-02-Z)

➤ Strain Relief, Chapter 10



igus®
 e-chain system®

Telephone 1-800-521-2747

T3 e-chains® and modules for circular movement

T3 e-chains® for reverse bending radii (RBR)
 Part No. T3-29-050-38/55, T3-29-050-38-75, T3-29-050-38-100,
 T3-29-050-38-150

- Several reverse bending radii available in 55, 75, 100, and 150
- Quiet
- Low wear
- Several mounting positions
- Complete line of interior separation for Series T3-29



T3 RBR modules for reverse bending radii

Consists of 4 elements: T3 RBR e-chain®, guiding system, chainflex®
 motion cables, iglide® PRT slewing ring bearing
 Part No. T3-29-070-038/055

- Compact guiding module
- Able to turn in inner and outer radius
- For high speeds
- Quiet
- Compact dimensions
- Several mounting positions
- Delivery upon request

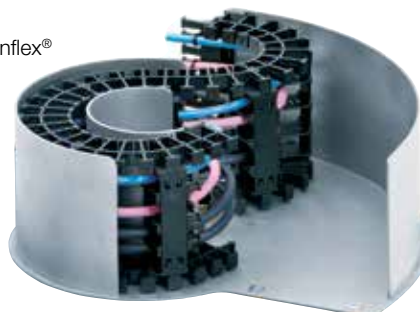

Internet: igus.com
 email: sales@igus.com
 QuickSpec: igus.com/quickspec

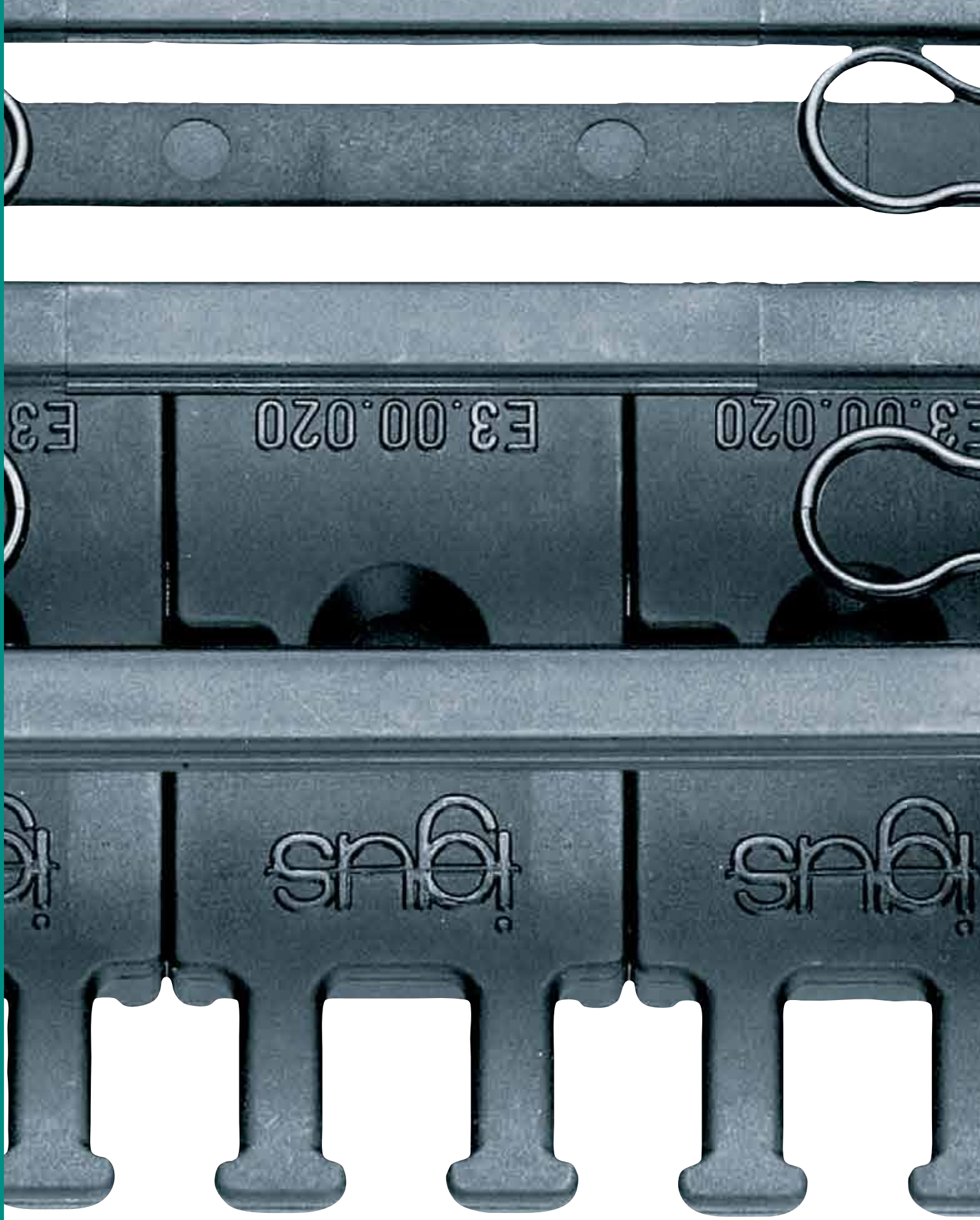



igus[®]
System E3
Highly dynamic &
cleanroom compatible

E3 - Highly dynamic and cleanroom compatible

The igus® System E3 combines small pitches, smooth running, low noise, stability, easy assembly and economic efficiency all in one. The spring connector element replaces the pin and bore design and avoids relative movements between the joints. This means virtually no wear or abrasion for cleanroom applications. To reduce production and assembling costs, the spring connector is not mounted individually, but on a length of ten chain links. Another E3 option is safe performance. A modified spring element made of electrically conductive material, which connects the chain links mechanically and electrically, permanently guarantees constant electrical conductivity, even at high bending stress and in any position.

Typical industries and applications

- Semi-conductor manufacturing and handling
- Pick and place robots
- Optics
- Materials handling technology
- Measuring technology
- Printers and plotters
- Cleanroom environments
- General mechanical engineering



IPA Qualification Certificate - Report IG0704-400:
ISO Class 1, according to Norm DIN EN ISO 14644-1
for System E3, Series E3-15-040-075-0 at
 $v = 1.64 \text{ ft/s (0.5 m/s)}$, $3.28 \text{ ft/s (1 m/s)}$, $6.56 \text{ ft/s (2 m/s)}$



38 dB(A) - Value determined at the igus® test-lab acc. to DIN 45635, with consideration of background noises, for Series E3-22-060-044-0 at $v = 5.91 \text{ ft/s (1.8 m/s)}$



iF-Design
Award 2005



Special equipment: Electrically conductive
ESD/ATEX version upon request

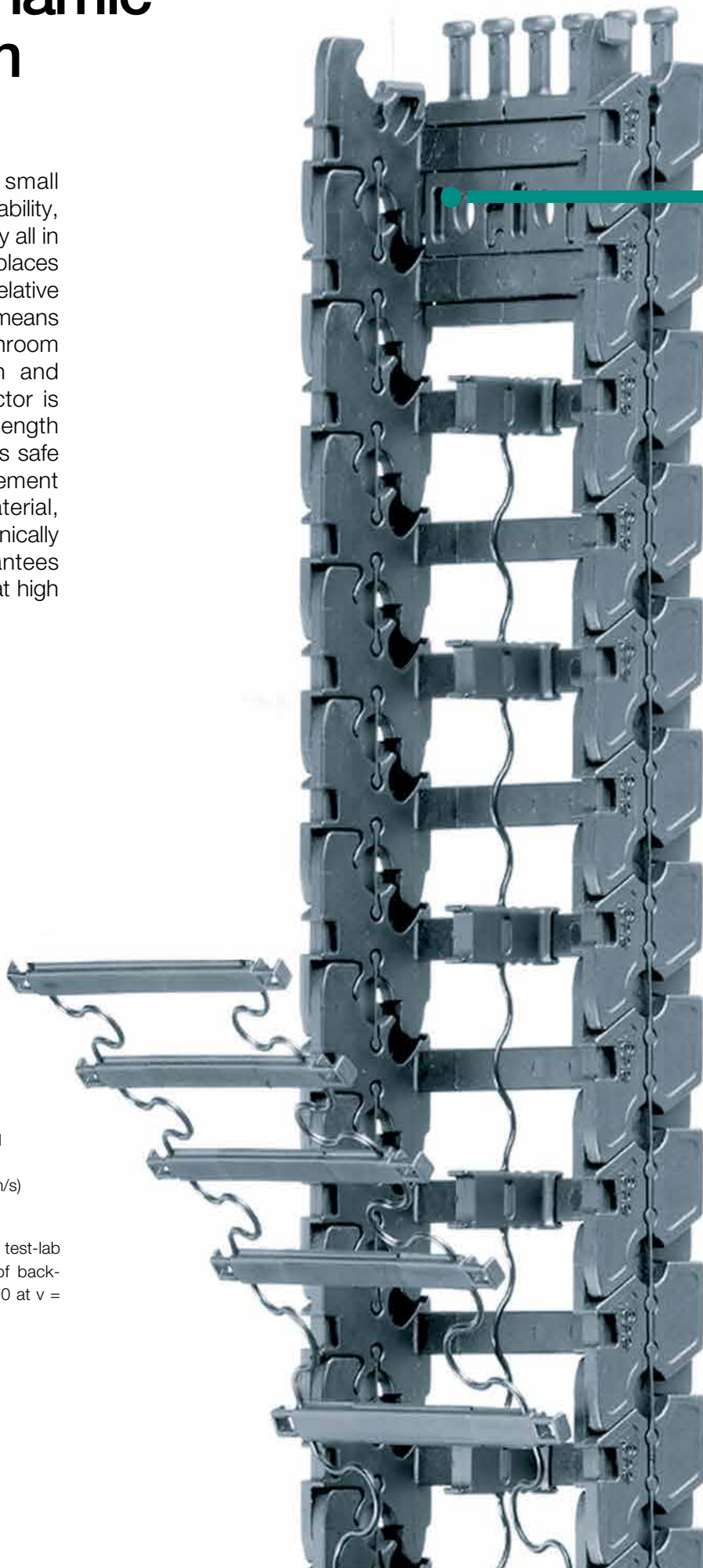

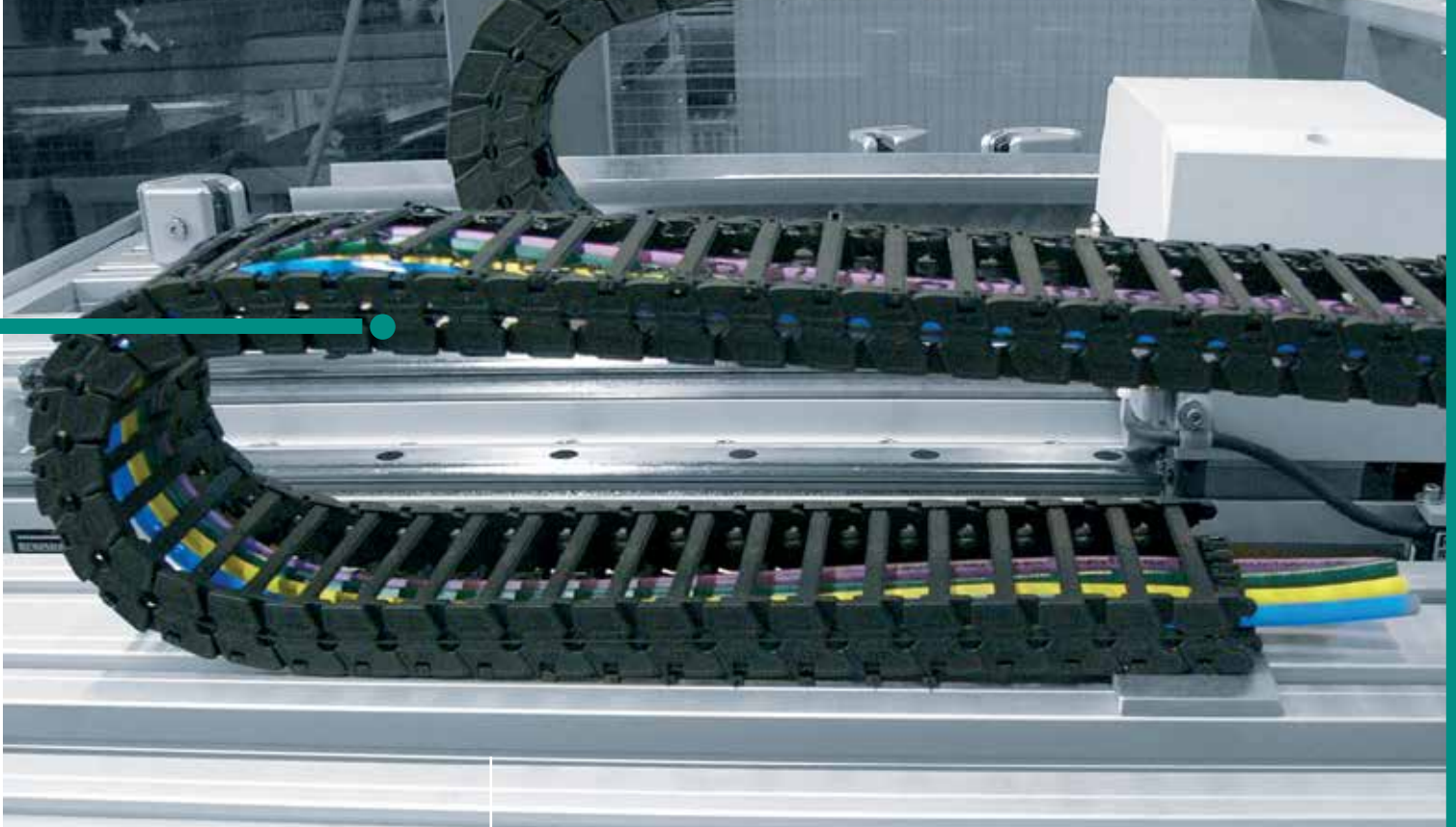

Long-term tests in our acoustics laboratory at a speed of 5.91 ft/s (1.8 m/s) and an acceleration of 9.84 ft/s² (3 m/s²) showed reductions of 19-20 dB(A) compared to conventional e-chains®.



Light-weight and super-silent in small spaces - System E3



During long-term tests the System E3 with the spring band connector easily passes 15 million cycles at a bending radius of 1.73" (44 mm) and an acceleration of 4 g

e-chain system® E3

Selection Guide

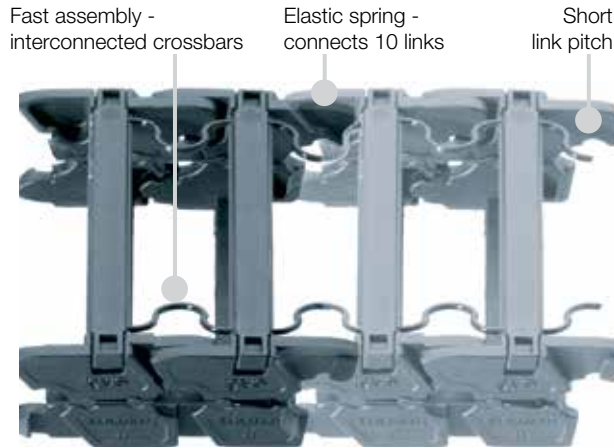

E3 = e-chains® with 3 different elements in one link:

- U-shaped link body
- Spring element
- Interconnected crossbars

E3: System for highly dynamic applications

Cycle times in automation get shorter, while demands for low noise and low vibration levels are increasing. For the broad range of small size e-chain® applications, igus® now introduces the System E3, that fully meets those requirements:

- Extremely low-noise operation - max. 38 dB(A)
- Elastic, dampening connector strip replaces pins and bores
- Modular 3-piece link design
- Cost effective cross bar, separator and connector modules
- Fast and easy cable access due to zipper opening mechanism
- Good unsupported strength due to solid, interlocking side links
- Easy lengthening and shortening
- Also suits flat cables
- Accessories: Separators, integrated strain relief, mounting brackets
- You can find more technical data about the material, chemical resistance, temperatures ► **Design, Chapter 1**

Series	Inner height <i>hi</i> in. (mm)	Inner width <i>Bi</i> in. (mm)	Outer width <i>Ba</i> in. (mm)	Outer height <i>ha</i> in. (mm)	Bending radius <i>R</i> in. (mm)
E3-10	.39 (10)	.79-2.36 (20-60)	1.26-2.83 (32-72)	.59 (15)	.59-1.89 (15-48)
E3-15	.59 (15)	.79-2.36 (20-60)	1.26-2.83 (32-72)	.79 (20)	1.26-2.95 (32-75)
E3-22	.87 (22)	.79-2.36 (20-60)	1.26-2.83 (32-72)	1.06 (27)	1.75-2.95 (44-75)



Available from stock. Orders ship as early as today.*

*On average 90% of orders ship the same day..

e-chain system® E3 Assembly Instructions

System E3 - 3-piece e-chain®

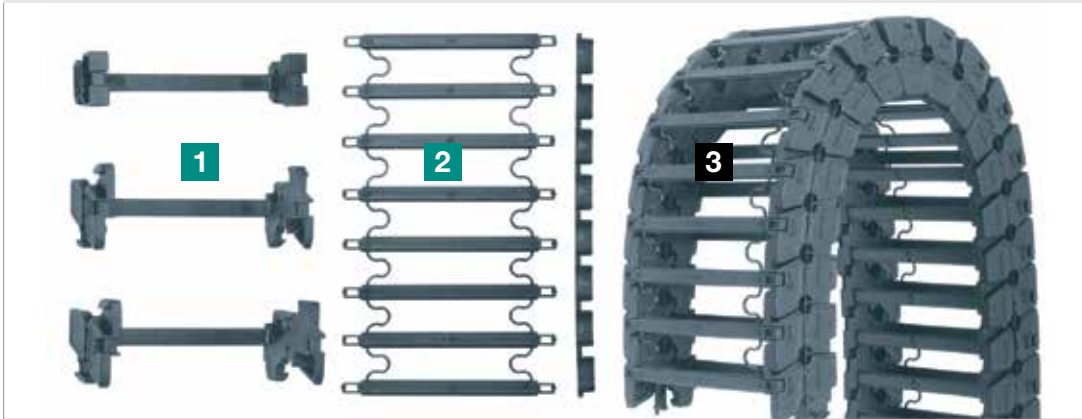

The abbreviation "E3" stands for an e-chain® consisting of three basic elements:

- ❶ e-chain® link body
- ❷ Interconnected crossbars
- ❸ Separator module

System E3 - Opening and Closing



Interconnected crossbars for quick and easy installation - This e-chain system® allows faster assembling times. Opening and closing the e-chain® is made easy by Interconnected crossbars

System E3 - Interior Separation and Strain Relief

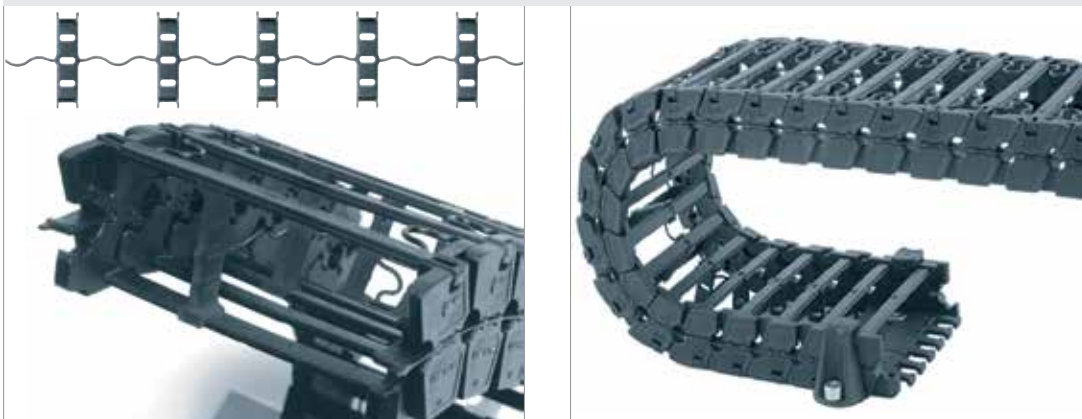

Vertical separators on a band divide carrier space - Five separators on one thread are simultaneously mounted on the crossbars

The universal strain relief can be individually matched to the chain width. You can fix the e-chain® on the fixed end with brackets (option)

Price Index

Series E3-10

Special Features / Options

*Noise test values: max. 38dB(A)
 - Values determined at the igus®
 test lab according to DIN 45635
 (v = 5.91 ft/s)



IPA Classification: Report
 IG0704-400: ISO Class 1,
 according to standard DIN EN
 ISO 14644-1 for E3, Series E3-15-
 040-075-0 (at v = 1.64 ft/s, 3.28
 ft/s, 6.56 ft/s)



Special equipment: Electrically
 conductive ESD/ATEX version
 upon request

Assembly Tips

Rapid assembly time with interconnected
 crossbars

Usage Guidelines



- If a low noise, vibration-free version is required
- For very high speeds and/or accelerations (theoretically up to 100G or 3,281 ft/s (1000 m/s))
- Hard-wearing e-chain® (more than 50 million cycles with minimal abrasion)
- If a very light e-chain® is required (up to 40% lighter than comparable E2 e-chain®)
- For the use of flat cables
- For small bending radii and small spaces
- If easy filling and assembly is required
- Minimal abrasion (e.g. cleanroom applications)



- If a particularly low-cost snap-open solution is required
 ➤ **Series E06/Z06 E-Z Chain**
- If a simple, non snap-open e-chain® is required
 ➤ **Series 05 E2 micro**

Features & Benefits

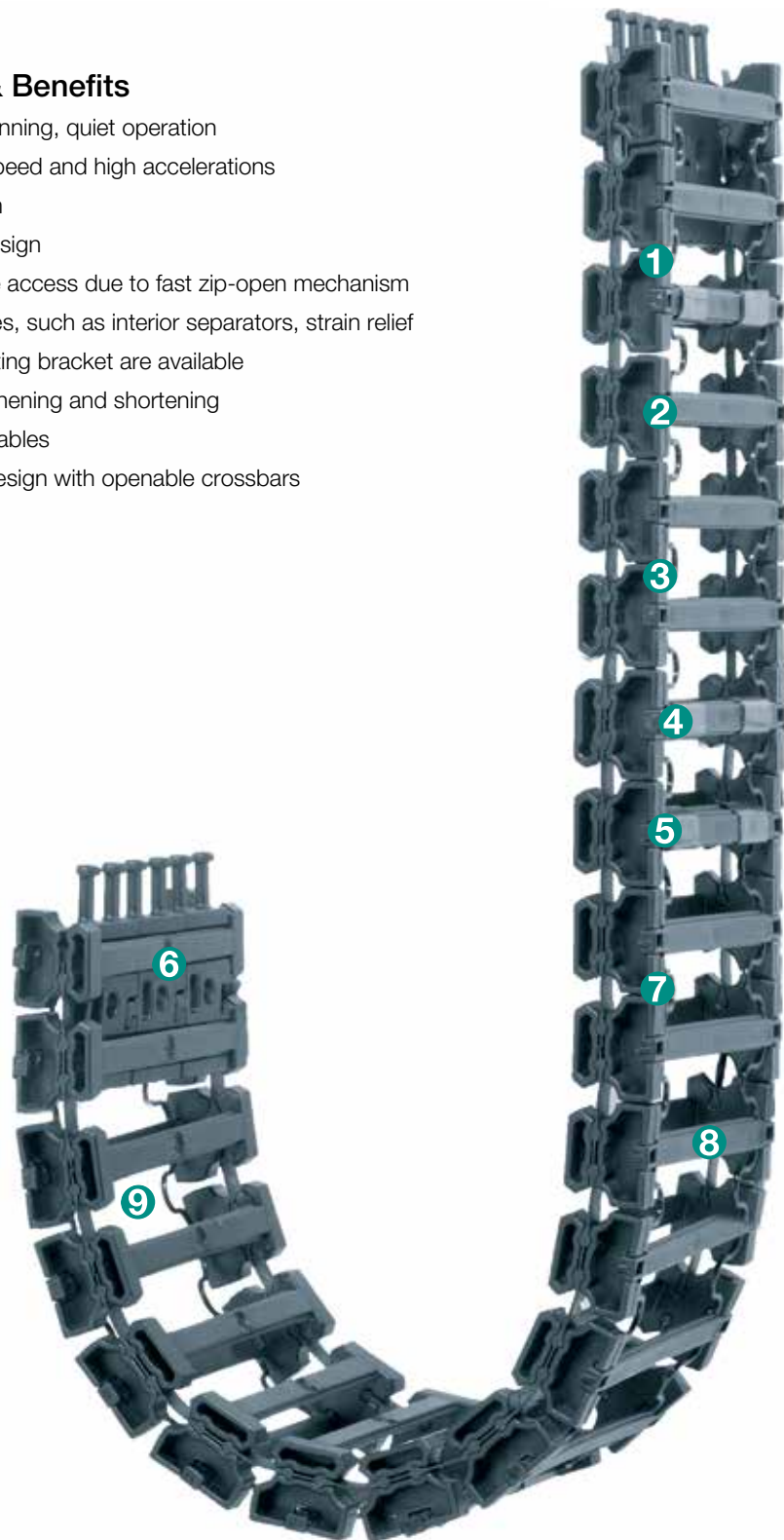
- 1 Smooth running, quiet operation
- 2 For high speed and high accelerations
- 3 Small pitch
- 4 3-piece design
- 5 Easy cable access due to fast zip-open mechanism
- 6 Accessories, such as interior separators, strain relief and mounting bracket are available
- 7 Easy lengthening and shortening
- 8 Suits flat cables
- 9 Modular design with openable crossbars

Order Example: Complete e-chain®

Please indicate chain length or number of links. Example:

3.28 ft (1 m) **E3-10-060-015-0**



e-chain®

With 2 separators **E3-10-11** assembled every 2nd link



Interior Separation

1 Set **E3-10-060-12**



Mounting Bracket

e-chain system® E3 Series E3-10



E3-10

Short travel, unsupported length

- FL_B = unsupported with permitted sag
 - FL_G = unsupported with straight upper run
- Further information ► Design, Chapter 1

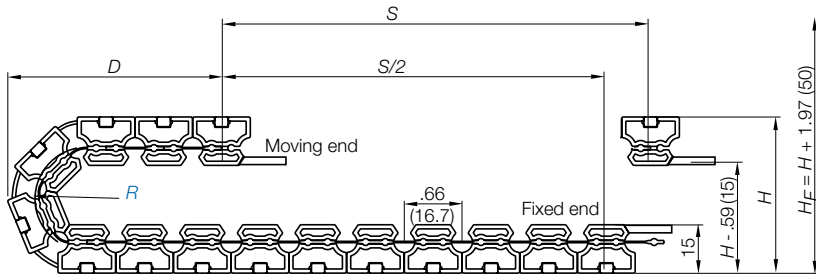
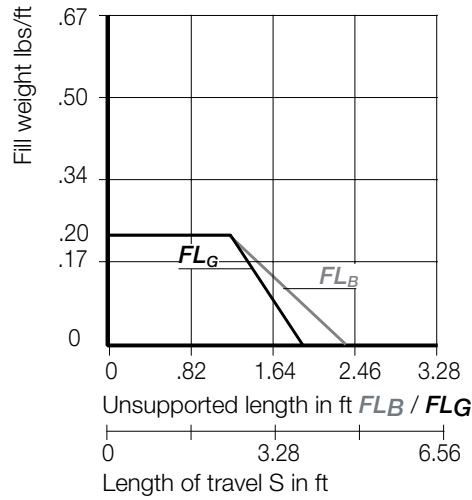
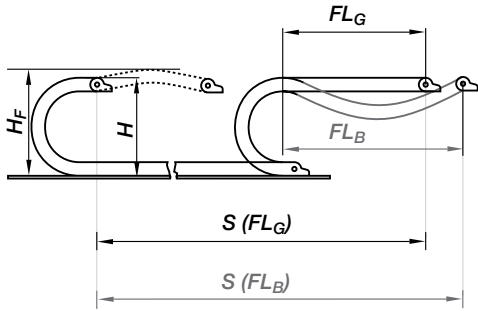

Pitch per link = $.66^\circ$ (16.7 mm)
 Links per ft (m) = 18.29 (60)
 For center mount applications:
 Chain length = $\frac{S}{2} + K$

The required clearance height: $H_F = H + 1.97$ in. (50 mm) (with 0.7 lbs/ft (0.1 kg/m) fill weight).
 Please consult igus® if space is particularly restricted.

R	.59 (015)	1.10 (028)	1.50 (038)	1.89 (048)
H	2.36 (60)	3.39 (86)	4.17 (106)	4.96 (126)
D	1.97 (50)	2.48 (63)	2.87 (73)	3.27 (83)
K	3.35 (85)	4.92 (125)	6.10 (155)	7.28 (185)

Short Travels - Unsupported



Unsupported e-chains® feature positive camber over short travels. This must be accounted for when specifying the clearance height. Please refer to **Installation dimensions** for further details.

Legend

- S = Length of travel
- R = Bending radius
- H = Nominal clearance height
- D = Overlength e-chain® radius in final position
- $K = \pi \cdot R + \text{safety buffer}$
- H_F = Required clearance height



PDF: igus.com/e-chain-pdfs
 Product information: igus.com/e-chains



Speed / acceleration FL_G	max. 65.6 ft/s (20 m/s) / max. 656 ft/s ² (200 m/s ²)
Speed / acceleration FL_B	max. 9.84 ft/s (3 m/s) / max. 19.69 ft/s ² (6 m/s ²)
Gliding speed / acceleration (maximum)	upon request
Permitted temperature	-40°F (-40°C) up to +158°F (+70° C)
Flammability Class	VDE 0304 IIC UL94 HB

Technical Data



Details of material properties

► Design, Chapter 1

Series E3-10 - Snap-open along the outer radius

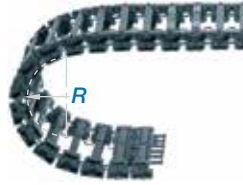
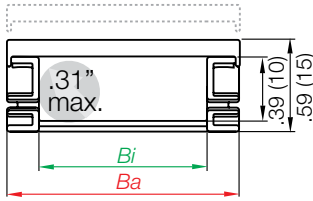

Part Number Structure

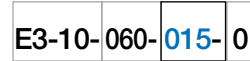

- Color - Black
- Bending radius
- Width
- Series

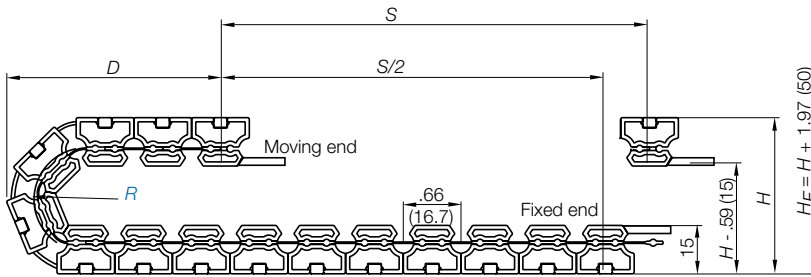

Supplement part number with required radius. Example: E3-10-060-**015**-0
Pitch: .66 in. (16.7 mm) per link links/ft (m) = 18.29 (60)

Part Number	Bi in. (mm)	Ba in. (mm)	Weight lbs/ft (kg/m)
E3-10-020- <input type="text"/> -0	.79 (20)	1.26 (32)	≈ 0.08 (0.12)
E3-10-040- <input type="text"/> -0	1.57 (40)	2.05 (52)	≈ 0.10 (0.15)
E3-10-060- <input type="text"/> -0	2.36 (60)	2.83 (72)	≈ 0.13 (0.20)

Choose from the radii below for all of the above sizes
Radius (mm) Example: E3-10-060-**015**-0

	015	028	038	048
R	.59 (015)	1.10 (028)	1.50 (038)	1.89 (048)
H	2.36 (60)	3.39 (86)	4.17 (106)	4.96 (126)
D	1.97 (50)	2.48 (63)	2.87 (73)	3.27 (83)
K	3.35 (85)	4.92 (125)	6.10 (155)	7.28 (185)

NOTE: E3-10-020-038, E3-10-020-048, E3-10-040-028, E3-10-060-028 and E3-10-060-048 are available upon request

Interior Separation

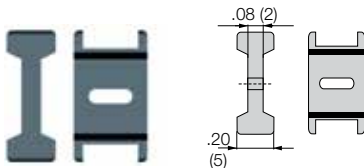

Separator, narrow head

Unassembled	Part No. E3-10-01
Assembled	Part No. E3-10-11

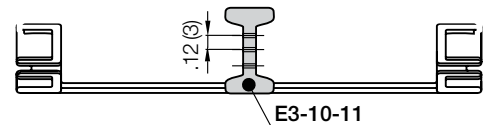

• Separator 45-2

Vertical separators are used if a vertical subdivision of the e-chain® interior is required.

e-chain system® E3
 Series E3-10
 KMA Mounting Bracket, Mounting Angle, Plastic



E3-10

Fixed end
 E3-10-...-2

Moving end
 E3-10-...-1

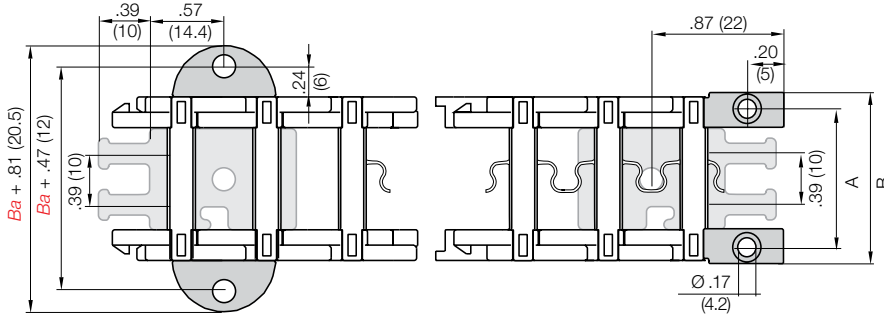

View Mounting angle

View KMA mounting bracket



E3-100-XXX-12 - Space-saving KMA mounting brackets

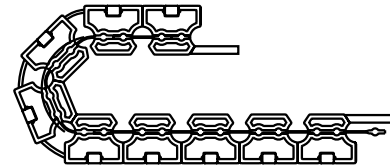

For Series	KMA Mounting bracket	Dimension A in. (mm)	Dimension B in. (mm)	Part No. Full Set strain relief both sides + 2 mounting angles	Part No. strain relief both sides	Part No. mounting angle* (single part)
E3-10-020	E3-100-020-12	1.10 (28)	1.42 (36)	E3-10-020-12	E3-020-12	E3-10-00
E3-10-040	E3-100-040-12	1.89 (48)	2.20 (56)	E3-10-040-12	E3-040-12	E3-10-00
E3-10-060	E3-100-060-12	2.68 (68)	2.99 (76)	E3-10-060-12	E3-060-12	E3-10-00

*Note: If the mounting brackets are used, two links each side must be added to the e-chain® length calculation, because the first to links are fixed by the mounting brackets.

E3-10-XXX-12



E3 with strain relief for both sides and mounting angles

E3-00-020



Strain relief for both sides as single parts

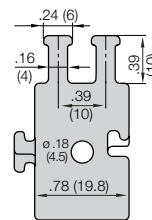

E3-10-00



Mounting angle as single part

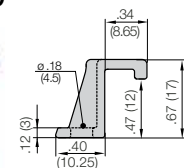

Full set, for both ends:

E3-10- [060- 12] Full set, both fixed and moving end

Single-part order:

E3-10 - [060- 1] Mounting bracket moving end

E3-10 - [060- 2] Mounting bracket fixed end

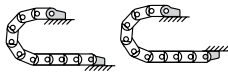

Possible installation configurations -

PDF: igus.com/e-chain-pdfs
 Product information: igus.com/e-chains



Price Index

Series E3-15

Special Features / Options

*Noise test values: max. 38dB(A)
 - Values determined at the igus®
 test lab according to DIN 45635
 (v = 5.91 ft/s)



IPA Classification: Report
 IG0704-400: ISO Class 1,
 according to standard DIN EN
 ISO 14644-1 for E3, Series E3-15-
 040-075-0 (at v = 1.64 ft/s, 3.28
 ft/s, 6.56 ft/s)



Special equipment: Electrically
 conductive ESD/ATEX version
 upon request

Assembly Tips

Rapid assembly time with interconnected
 crossbars

Usage Guidelines



- If a low noise, vibration-free version is required
- For very high speeds and/or accelerations (theoretically up to 100G or 3,281 ft/s (1000 m/s))
- Hard-wearing e-chain® (more than 50 million cycles with minimal abrasion)
- If a very light e-chain® is required (up to 40% lighter than comparable E2 e-chain®)
- For small bending radii and small spaces
- If easy filling and assembly is required
- Minimal abrasion (e.g. cleanroom applications)



- If a particularly low-cost snap-open solution is required
 ► **Series E08/Z08 E-Z Chain**
- If a simple, non snap-open e-chain® is required
 ► **Series 08 E2 Micro**

Features & Benefits

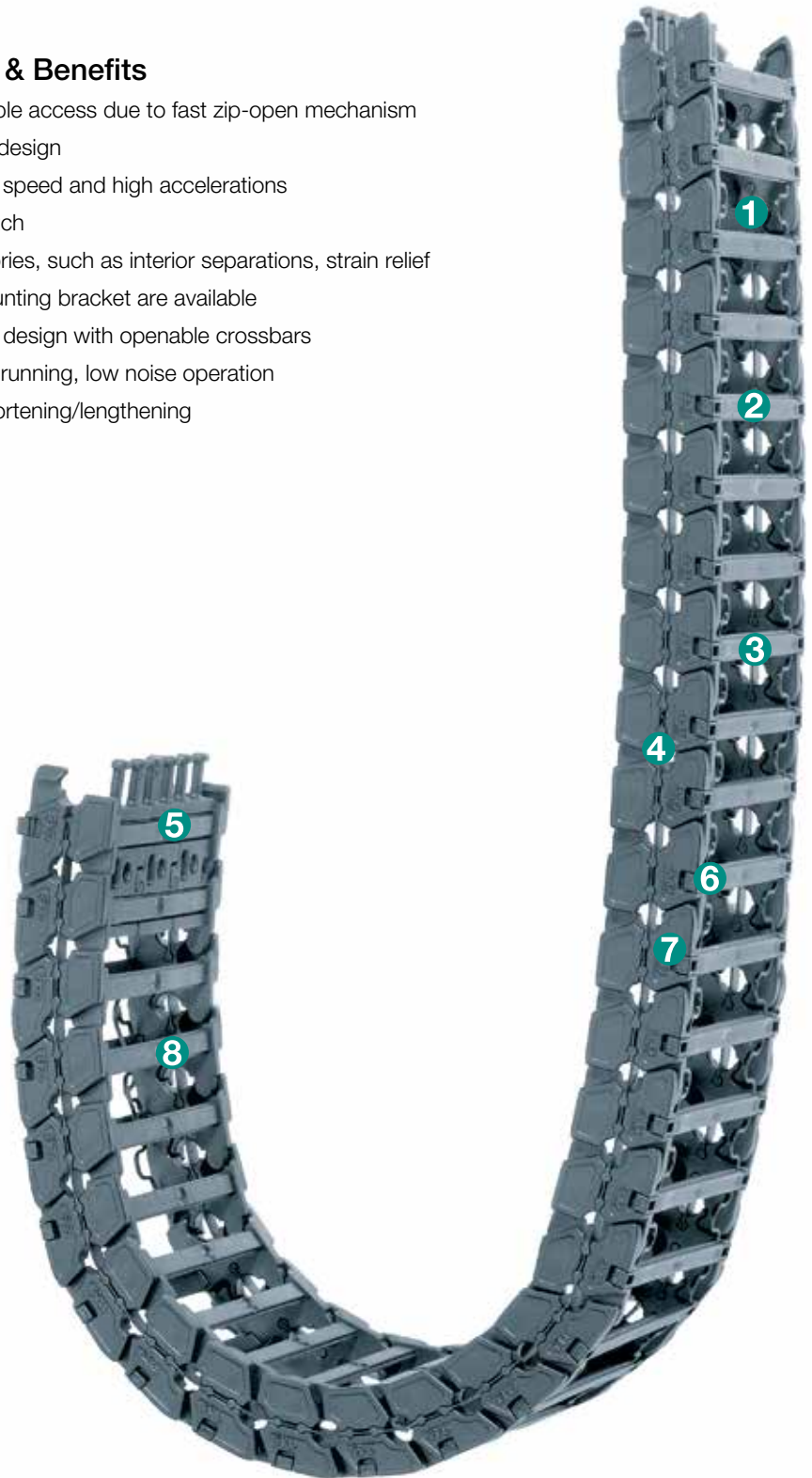
- 1 Easy cable access due to fast zip-open mechanism
- 2 3-piece design
- 3 For high speed and high accelerations
- 4 Small pitch
- 5 Accessories, such as interior separations, strain relief and mounting bracket are available
- 6 Modular design with openable crossbars
- 7 Smooth running, low noise operation
- 8 Easy shortening/lengthening

Order Example: Complete e-chain®

Please indicate chain length or number of links. Example:

3.28 ft (1 m) **E3-15-060-032-0**



e-chain®

With 2 separators **E3-15-11** assembled every 2nd link



Interior Separation

1 Set **E3-15-060-12**



Mounting Bracket

Short travel, unsupported length

- FL_B = unsupported with permitted sag
 - FL_G = unsupported with straight upper run
- Further information ► Design, Chapter 1

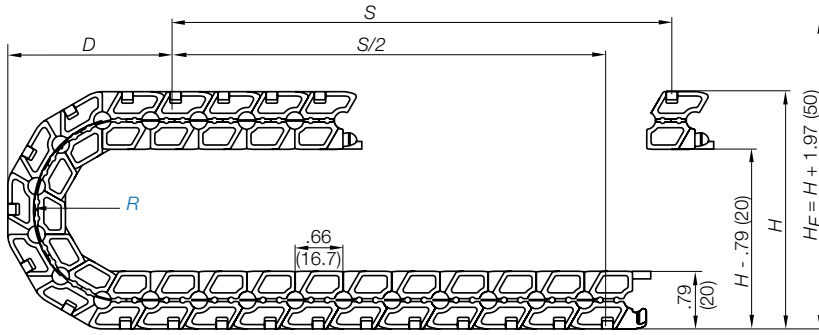
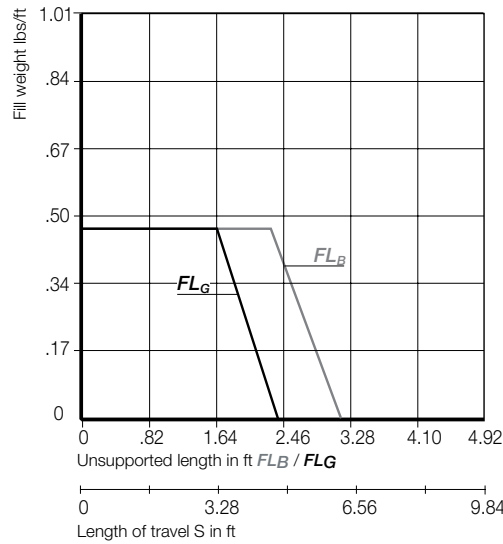
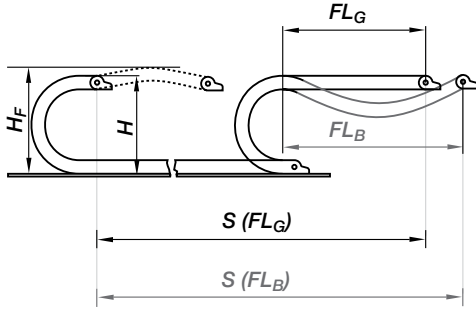

Pitch per link = .66" (16.7 mm)
 Links per ft (m) = 18.29 (60)
 For center mount applications:
 Chain length = $S/2 + K$

The required clearance height: $H_F = H + 1.97$ in. (50 mm) (with 0.13 lbs/ft (0.2 kg/m) fill weight).
 Please consult igus® if space is particularly restricted.

R	1.26 (032)	1.50 (038)	1.89 (048)	2.95 (075)
H	3.90 (99)	4.37 (111)	5.16 (131)	7.28 (185)
D	2.64 (67)	2.87 (73)	3.27 (83)	4.33 (110)
K	5.31 (135)	6.10 (155)	7.28 (185)	10.63 (270)

Short Travels -
Unsupported



Unsupported e-chains® feature positive camber over short travels. This must be accounted for when specifying the clearance height. Please refer to **Installation dimensions** for further details.

Legend

- S = Length of travel
- R = Bending radius
- H = Nominal clearance height
- D = Overlength e-chain® radius in final position
- $K = \pi \cdot R + \text{safety buffer}$
- H_F = Required clearance height



PDF: igus.com/e-chain-pdfs
 Product information: igus.com/e-chains



Speed / acceleration FL_G	max. 65.6 ft/s (20 m/s) / max. 656 ft/s ² (200 m/s ²)
Speed / acceleration FL_B	max. 9.84 ft/s (3 m/s) / max. 19.69 ft/s ² (6 m/s ²)
Gliding speed / acceleration (maximum)	upon request
Permitted temperature	-40°F (-40°C) up to +158°F (+70° C)
Flammability Class	VDE 0304 IIC UL94 HB

Technical Data



Details of material properties

► Design, Chapter 1

Series E3-15 - Snap-open along the outer radius

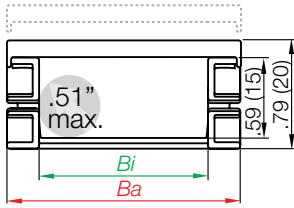

Part Number Structure

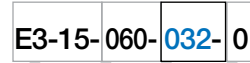

- Color - Black
- Bending radius
- Width
- Series

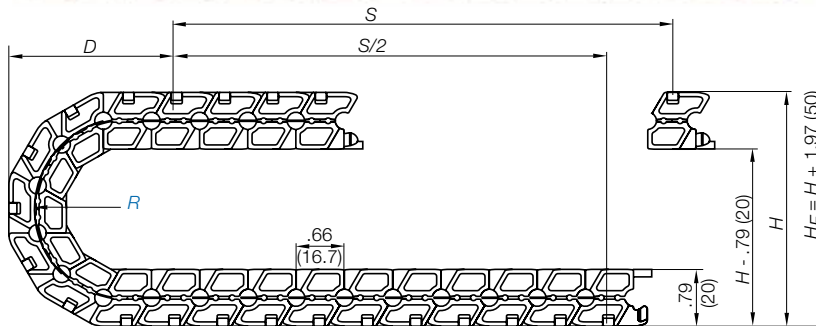

Supplement part number with required radius. Example: E3-15-060-032-0
Pitch: .66 in. (16.7 mm) per link links/ft (m) = 18.29 (60)

Part Number	Bi in. (mm)	Ba in. (mm)	Weight lbs/ft (kg/m)
E3-15-020- <input type="text"/> -0*	.79 (20)	1.26 (32)	≈ 0.15 (0.22)
E3-15-040- <input type="text"/> -0	1.57 (40)	2.05 (52)	≈ 0.17 (0.25)
E3-15-060- <input type="text"/> -0	2.36 (60)	2.83 (72)	≈ 0.22 (0.32)

Choose from the radii below for all of the above sizes

Radius (mm) Example: E3-15-060-032-0

	032	038	048	075
R	1.26 (032)	1.50 (038)	1.89 (048)	2.95 (075)
H	3.90 (99)	4.37 (111)	5.16 (131)	7.28 (185)
D	2.64 (67)	2.87 (73)	3.27 (83)	4.33 (110)
K	5.31 (135)	6.10 (155)	7.28 (185)	10.63 (270)

*Radii 038 and 075 are not available for the E3-15-020
NOTE: E3-15-020-048 is available upon request

Interior Separation

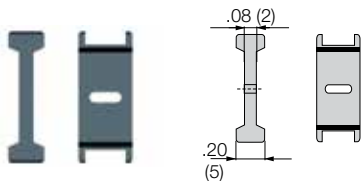
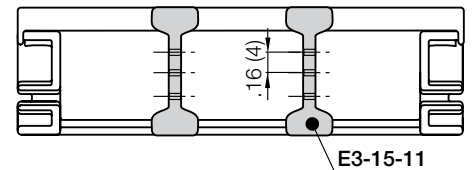

Slotted separator for e-chains®

Unassembled	Part No. E3-15-01
Assembled	Part No. E3-15-11



Separator, narrow base

Unassembled	Part No. E3-15-01-10
Assembled	Part No. E3-15-11-10

- **Separator E3-15-01**
Vertical separators are used if a vertical subdivision of the e-chain® interior is required.

- **Slotted separator on a strip E3-15-01-10**
Five vertical separators connected on one strip span ten e-chain® links and are mounted on the opening crossbars. This creates separate chambers, protecting the cables. The dimensions are the same as the E3-22-01 slotted separator

e-chain® E3
 Series E3-15
 KMA Mounting Bracket, Mounting Angle, Plastic



E3-15

Fixed end
 E3-15-...-2

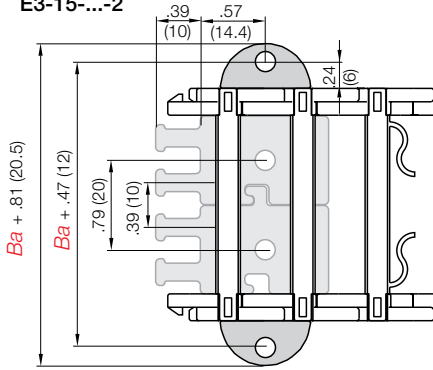

View Mounting angle

Moving end
 E3-15-...-1

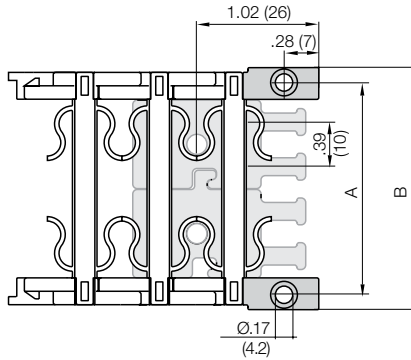

View KMA mounting bracket



E3-150-XXX-12 - Space-saving KMA mounting brackets

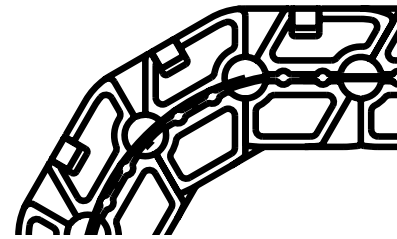

For Series	KMA Mounting bracket	Dimension A in. (mm)	Dimension B in. (mm)	Part No. Full Set strain relief both sides + 2 mounting angles	Part No. strain relief both sides	Part No. mounting angle* (single part)
E3-15-020	E3-150-020-12	.10 (28)	1.42 (36)	E3-15-020-12	E3-020-12	E3-15-00
E3-15-040	E3-150-040-12	1.89 (48)	2.20 (56)	E3-15-040-12	E3-040-12	E3-15-00
E3-15-060	E3-150-060-12	2.68 (68)	2.99 (76)	E3-15-060-12	E3-060-12	E3-15-00

*Note: If the mounting brackets are used, two links each side must be added to the e-chain® length calculation, because the first to links are fixed by the mounting brackets.

E3-15-XXX-12



E3 with strain relief for both sides and mounting angles

E3-00-020



Strain relief for both sides as single parts

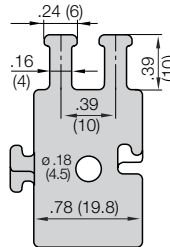

E3-15-00



Mounting angle as single part

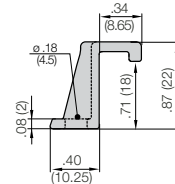

Full set, for both ends:

E3-15- 020- 12 Full set, both fixed and moving end

Single-part order:

E3-15 - 020- 1 Mounting bracket moving end

E3-15 - 020- 2 Mounting bracket fixed end

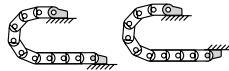

Possible installation configurations -

PDF: igus.com/e-chain-pdfs
 Product information: igus.com/e-chains



Price Index

Series E3-22
Special Features / Options

*Noise test values: max. 38dB(A)
 - Values determined at the igus®
 test lab according to DIN 45635
 (v = 5.91 ft/s)



IPA Classification: Report
 IG0704-400: ISO Class 1,
 according to standard DIN EN
 ISO 14644-1 for E3, Series E3-15-
 040-075-0 (at v = 1.64 ft/s, 3.28
 ft/s, 6.56 ft/s)



Special equipment: Electrically
 conductive ESD/ATEX version
 upon request

Assembly Tips

Rapid assembly time with interconnected
 crossbars

Usage Guidelines



- If a low noise, vibration-free version is required
- For very high speeds and/or accelerations (theoretically up to 100G or 3,281 ft/s (1000 m/s))
- Hard-wearing e-chain® (more than 50 million cycles with minimal abrasion)
- If a very light e-chain® is required (up to 40% lighter than comparable E2 e-chain®)
- For small bending radii and small spaces
- If easy filling and assembly is required
- Minimal abrasion (e.g. cleanroom applications)



- If a particularly low-cost snap-open solution is required
 ➤ **Series E14/Z14 E-Z Chain**
- If a simple, non snap-open e-chain® is required
 ➤ **Series 1400/1450/1500 E2 Medium**

Features & Benefits

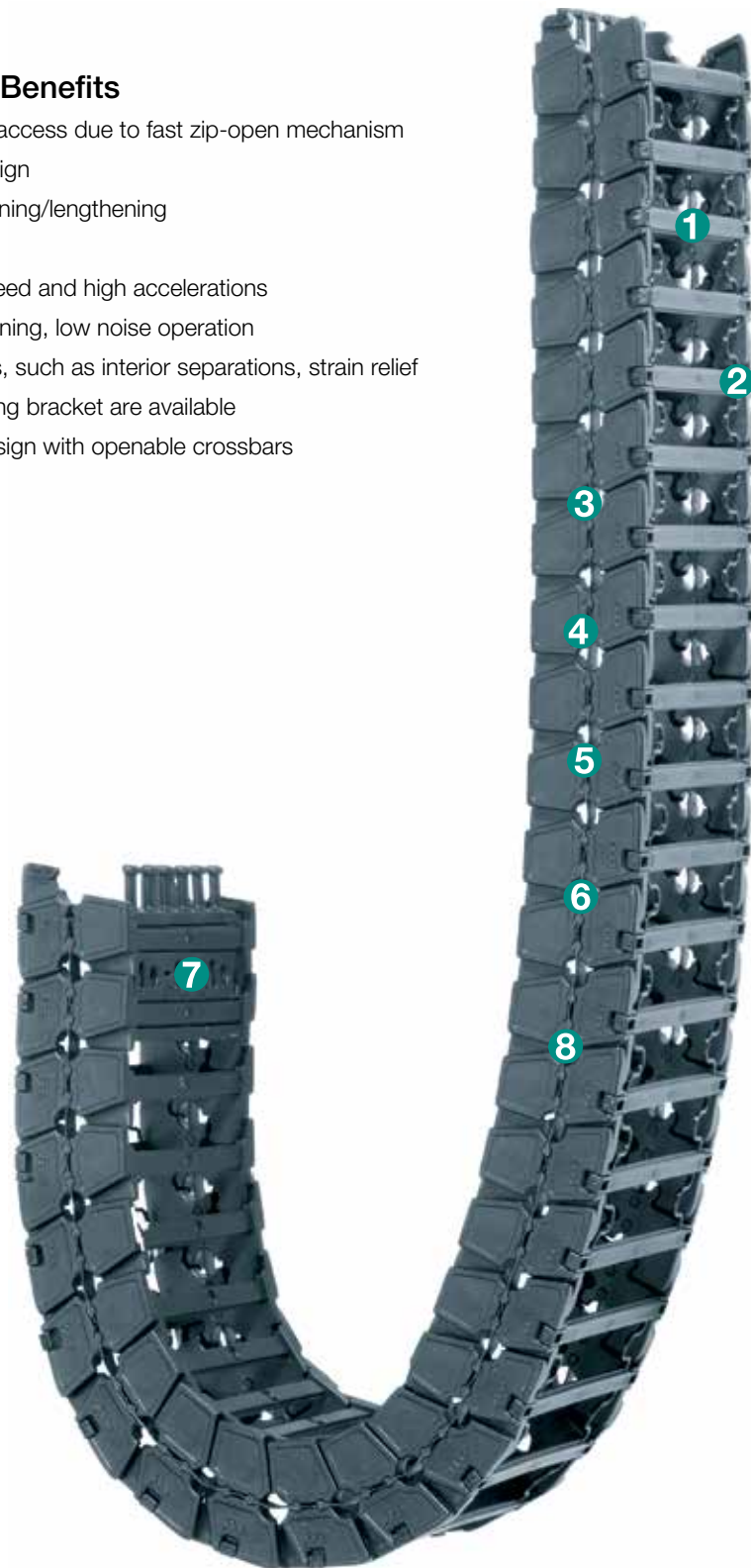
- 1 Easy cable access due to fast zip-open mechanism
- 2 3-piece design
- 3 Easy shortening/lengthening
- 4 Small pitch
- 5 For high speed and high accelerations
- 5 Smooth running, low noise operation
- 7 Accessories, such as interior separations, strain relief and mounting bracket are available
- 8 Modular design with openable crossbars

Order Example: Complete e-chain®

Please indicate chain length or number of links. Example:

3.28 ft (1 m) **E3-22-060-044-0**



e-chain®

With 2 separators **E2-22-11** assembled every 2nd link



Interior Separation

1 Set **E3-22-060-12**



Mounting Bracket

Short travel, unsupported length

- FL_B = unsupported with permitted sag
 - FL_G = unsupported with straight upper run
- Further information ► Design, Chapter 1

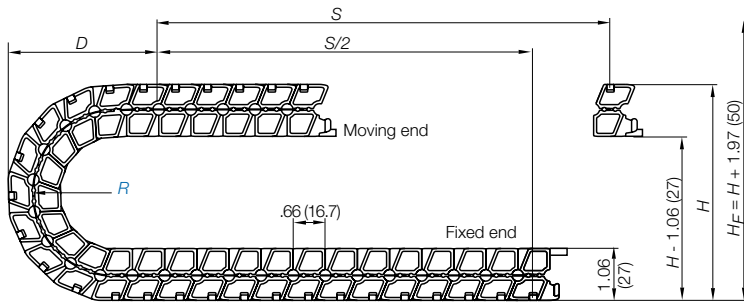
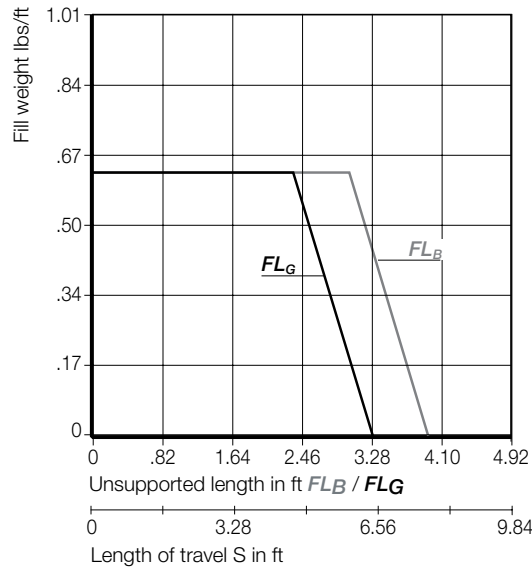
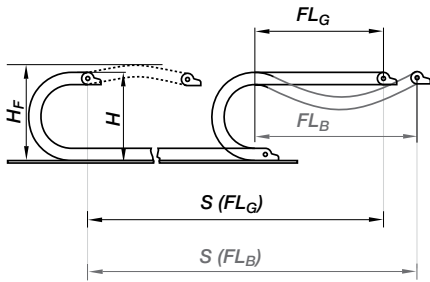

The required clearance height: $H_F = H + 1.97$ in. (50 mm) (with 0.20 lbs/ft (0.3 kg/m) fill weight). Please consult igus® if space is particularly restricted.

R	1.73 (044)	1.97 (050)	2.95 (075)
H	5.28 (134)	5.75 (146)	6.93 (176)
D	3.23 (82)	3.15 (80)	4.13 (105)
K	6.89 (175)	7.68 (195)	10.63 (270)

Short Travels - Unsupported



Unsupported e-chains® feature positive camber over short travels. This must be accounted for when specifying the clearance height. Please refer to **Installation dimensions** for further details.

Legend

- S = Length of travel
- R = Bending radius
- H = Nominal clearance height
- D = Overlength e-chain® radius in final position
- $K = \pi \cdot R + \text{safety buffer}$
- H_F = Required clearance height

Pitch per link = $.66''$ (16.7 mm)
Links per ft (m) = 18.29 (60)
For center mount applications:
Chain length = $\frac{S}{2} + K$

Speed / acceleration FL_G	max. 65.6 ft/s (20 m/s) / max. 656 ft/s ² (200 m/s ²)
Speed / acceleration FL_B	max. 9.84 ft/s (3 m/s) / max. 19.69 ft/s ² (6 m/s ²)
Gliding speed / acceleration (maximum)	upon request
Permitted temperature	-40°F (-40°C) up to +158°F (+70° C)
Flammability Class	VDE 0304 IIC UL94 HB

Technical Data



Details of material properties

► Design, Chapter 1



PDF: igus.com/e-chain-pdfs
Product information: igus.com/e-chains

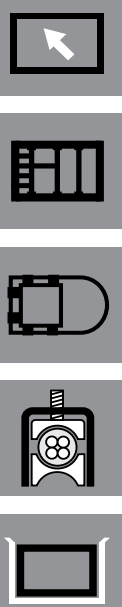

Series E3-22 - Snap-open along the outer radius

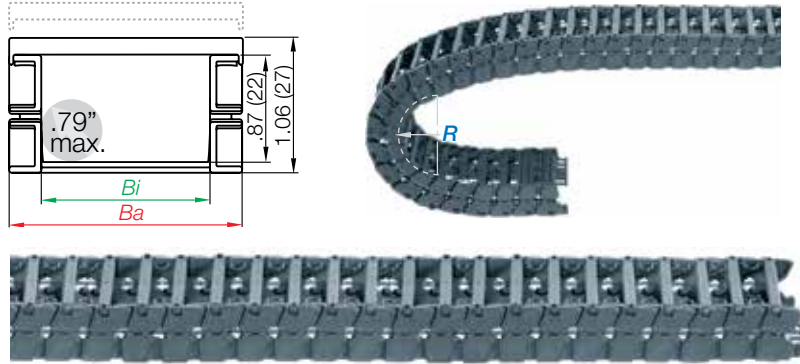

Part Number Structure

E3-22-060-044-0

- Color - Black
- Bending radius
- Width
- Series

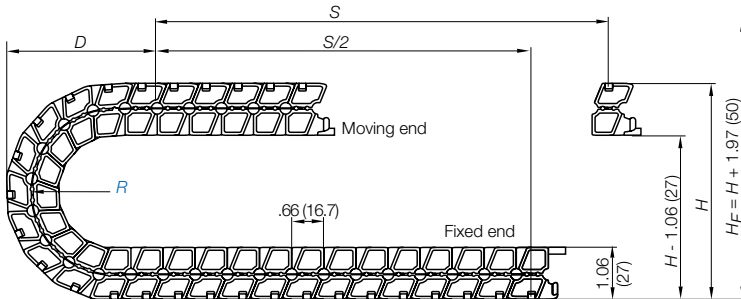

Supplement part number with required radius. Example: E3-22-060-044-0
 Pitch: .66 in. (16.7 mm) per link links/ft (m) = 18.29 (60)

Part Number	Bi in. (mm)	Ba in. (mm)	Weight lbs/ft (kg/m)
E3-22-020- [] -0	.79 (20)	1.26 (32)	≈ 0.20 (0.30)
E3-22-040- [] -0	1.57 (40)	2.05 (52)	≈ 0.22 (0.32)
E3-22-060- [] -0	2.36 (60)	2.83 (72)	≈ 0.28 (0.41)

Choose from the radii below for all of the above sizes

Radius (mm) Example: E3-22-060-044-0

	044	050*	075
R	1.73 (044)	1.97 (050)	2.95 (075)
H	5.28 (134)	5.75 (146)	6.93 (176)
D	3.23 (82)	3.15 (80)	4.13 (105)
K	6.89 (175)	7.68 (195)	10.63 (270)

* Radius 050 is not available for the E3-22-060

Interior Separation

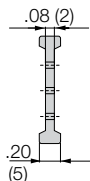
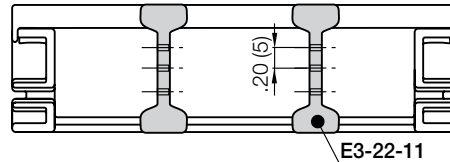

Slotted separator for e-chains®

Unassembled	Part No. E3-22-01
Assembled	Part No. E3-22-11

• Slotted separator E3-22-01

Vertical separators are used if a vertical subdivision of the e-chain® interior is required.

Fixed end
E3-22-...-2

Moving end
E3-22-...-1

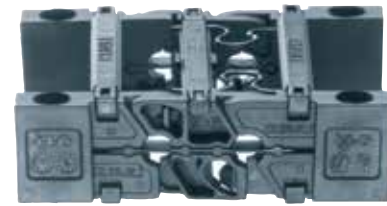
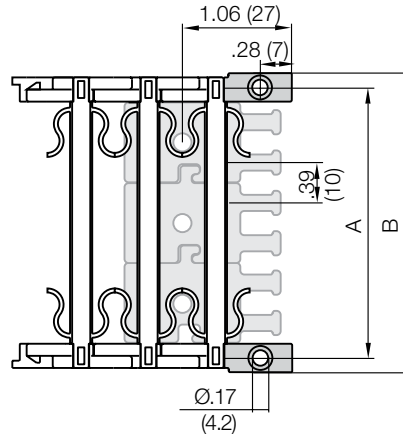
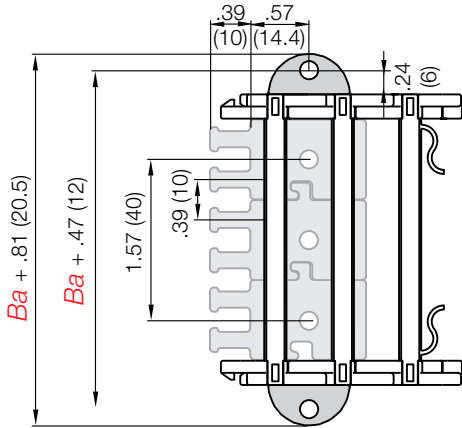

E3-220-XXX-12 - Space-saving KMA mounting brackets

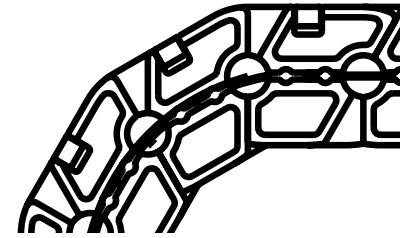

View mounting angle

View KMA mounting bracket

For Series	KMA Mounting bracket	Dimension A in. (mm)	Dimension B in. (mm)	Part No. Full Set strain relief both sides + 2 mounting angles	Part No. strain relief both sides	Part No. mounting angle (single part)
E3-22-020	E3-220-020-12	.10 (28)	1.42 (36)	E3-22-020-12	E3-020-12	E3-22-00
E3-22-040	E3-220-040-12	1.89 (48)	2.20 (56)	E3-22-040-12	E3-040-12	E3-22-00
E3-22-060	E3-220-060-12	2.68 (68)	2.99 (76)	E3-22-060-12	E3-060-12	E3-22-00

*Note: If the mounting brackets are used, two links each side must be added to the e-chain[®] length calculation, because the first to links are fixed by the mounting brackets.

E3-22-XXX-12



E3 with strain relief for both sides and mounting angles

E3-00-020



Strain relief for both sides as single parts

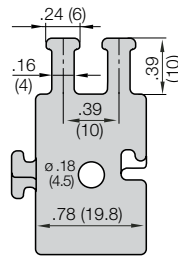

E3-22-00



Mounting angle as single part

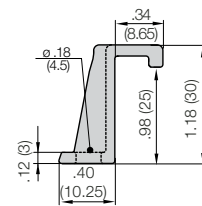

Full set, for both ends:

E3-22- 060- 12 Full set, both fixed and moving end

Single-part order:

E3-22- 060- 1 Mounting bracket moving end

E3-22- 060- 2 Mounting bracket fixed end

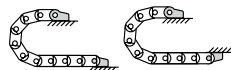

Possible installation configurations -

PDF: igus.com/e-chain-pdfs
Product information: igus.com/e-chains







igus[®] System E6-1

More dynamics, smoother running, easier to open, 2nd generation

The E6-1 series is an advancement of the E6 series. While having all its advantages, like the stability and cleanroom suitability, it is even lighter, faster and quieter. In addition, its accessibility to the interior and the assembly and handling have been improved.

- Crossbars can be opened on both sides and removable along the inner and outer radius
- Option without camber NC by turning the inner link
- Extremely quiet through small pitch and brake in the stop-dog system
- Extremely low vibration
- Low-abrasion link system (no pin/hole connection)
- Virtually no polygon effect, thereby “smooth rolling” operation
- Faster lengthening and shortening through optimized connection design
- Smooth and obstacle free interior design for a long lifetime for cables and hoses
- Weight savings approx. 30% compared to the System E6
- Cost-effective



System E6-1
Extremely low noise



System E6
6-piece link-design



IPA Qualification Certificate - Report IG 1303-640-1:
ISO Class 1, according to DIN EN ISO 14644-1 for System E6-1,
Series E61-29-50-075-0 and E61-29-50-075-0-CR
at $v = 1.64 \text{ ft/s (0.5 m/s), 3.28 ft/s (1 m/s), 6.56 ft/s (2 m/s)}$



e-chain system® E6-1

Selection Table

Series	Inner height <i>hi</i>		Inner width <i>Bi</i>		Outer width <i>Ba</i>		Outer height <i>ha</i>		Bend radius <i>R</i>		Unsupported length	
	in.	(mm)	in.	(mm)	in.	(mm)	in.	(mm)	in.	(mm)	≤ ft.	≤ (m)



E6-1 e-chains®
openable along inner and outer radius, from both sides

E61-29	1.14	(29)	1.18-5.51	(30-140)	1.73-6.06	(44-154)	1.38	(35)	2.17-5.91	(055-150)	5.74	(≈ 1.75)
--------	------	------	-----------	----------	-----------	----------	------	------	-----------	-----------	------	----------



E6-1 e-chains®
crossbars removable along the inner and outer radius

EF61-29	1.14	(29)	1.18-5.51	(30-140)	1.73-6.06	(44-154)	1.38	(35)	2.17-5.91	(055-150)	5.74	(≈ 1.75)
E61-35	1.38	(35)	1.18-5.51	(30-140)	1.81-6.14	(46-156)	1.65	(42)	2.17-5.91	(055-150)	6.23	(≈ 1.90)
E61-40	1.57	(40)	1.57-11.81	(40-300)	2.20-12.44	(56-316)	2.13	(54)	2.48-7.87	(063-200)	8.20	(≈ 2.50)
E61-52	2.05	(52)	1.57-11.81	(40-300)	2.52-12.76	(64-324)	2.56	(65)	2.95-5.91	(075-150)	9.84	(≈ 3.00)
E61-62	2.44	(62)	1.97-15.75	(50-400)	3.22-17.01	(82-432)	3.31	(84)	4.53	(115)	13.12	(≈ 4.00)
E61-80	3.15	(80)	1.97-15.75	(50-600)	3.07-24.72	(78-628)	4.25	(108)	5.91	(150)	17.23	(≈ 5.25)



Available from stock. Orders ship as early as today.*

*On average 90% of orders ship the same day..

Cost-effective - Series EF61-29

- Series EF61-29 - 1.14" (29mm) inner height
- Available at an even lower price without the pivoting function of the crossbars
- Crossbars removable from both sides
- Otherwise, technically the same as the E61-29 series.

More information ► www.igus.com



e-chain system® E6-1

Features - Accessories



New generation interior separation - even more cable-friendly



Snap-open mechanism, Series E61-29 choice of snap-open on left or right

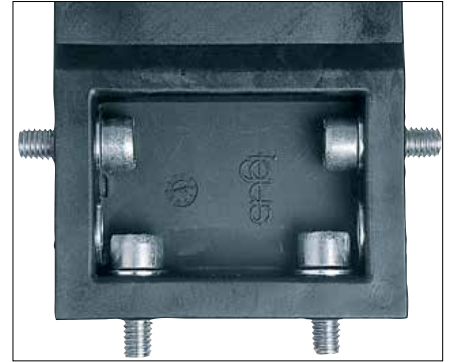

KMA mounting brackets with attachment options on all sides

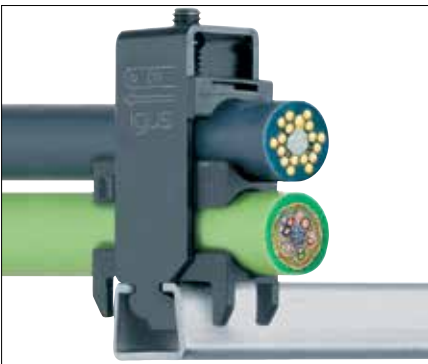

Strain relief clamps, tiwrap plates, nuggets and plug-in clips ▶ **Section 10**



Pivoting and locking KMA mounting brackets are available



Support tray tool kit. For support of the lower run ▶ **Section 9**

E6-1 for cleanrooms

Cleanroom qualification of E6-1 e-chains®

By using a special material, the already low abrasion of the e-chain® can be reduced even further. In many applications where cumbersome special solutions are required, a simple standard e-chain® can be used instead. IPA tests confirm that standard igus® e-chains® meet cleanroom requirements. "Tested and certified as very good!" e-chains® for cleanroom applications demand very high wear resistance of moving parts in order to meet the normal requirements for such a sensitive environment.



IPA Qualification Certificate²⁾ - Report IG 1303-640-1:
 ISO Class 1, according to DIN EN ISO 14644-1 for system E6-1, series E61-29-50-075-0 and E61-29-50-075-0-CR at v = 0.5m/s, 1m/s, 2m/s

e-chain system® E6-1 Advantages



The fact that the interior of the new E6-1 has been designed to be extremely cable-friendly underlines its suitability for cleanrooms by increasing the service life of cables and hoses even more. The crossbars are very smooth and rounded as is the transition from e-chain® link to crossbar, and all markings have been moved outside of the e-chain® cross section.

System E6-1 internal tests in the igus® lab

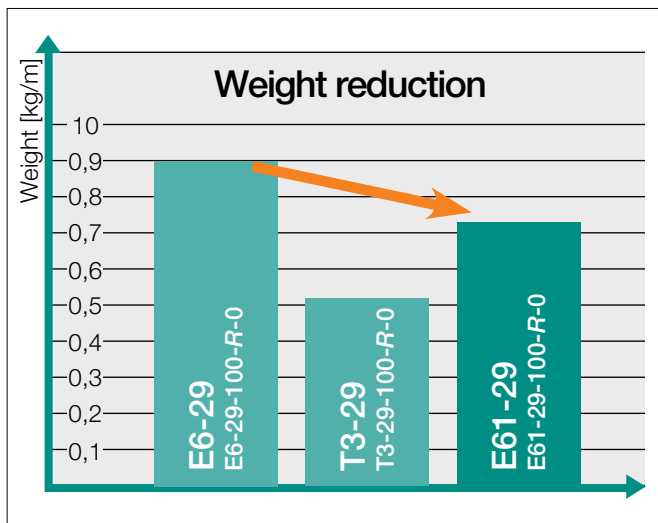

The E6-1 generation can take up higher accelerations, due to a weight reduction, making it a highly dynamic yet still extremely quiet e-chain®

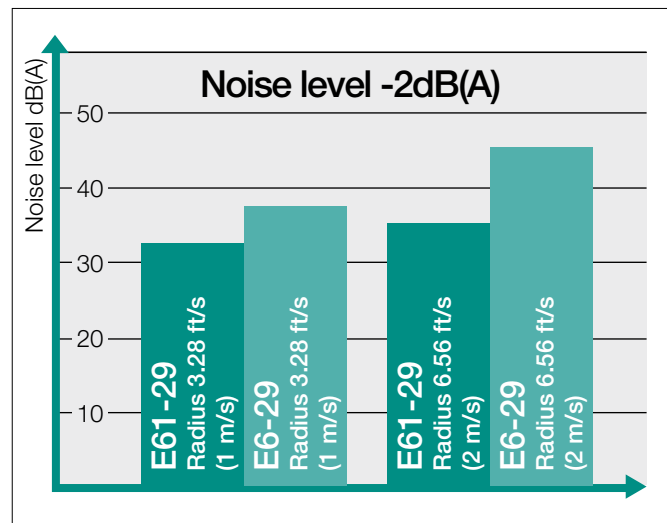

Series E61-29 tests in the igus® test lab show noise levels, which are 2 dB(A) below the already class-leading noise-levels of the igus® E6-29 series

Price Index



Series E61-29

Special Features / Options



Extremely low noise
Test results upon request



IPA Certificate: Class 1, according to standard DIN EN ISO 14644-1 for the E6 system (Series E6-29-060-150-0-CR, (v = 1.64 ft/s, a = 3.28 ft/s²))

Assembly Tips



snap-open mechanism

Other Installation Methods

Vertical, hanging ≤ 82 ft (25 m)

Vertical, standing ≤ 6.56 ft (2 m)

Side-mounted, unsupported = upon request

Unsupported length of upper run ≤ 11.48 ft (3.5 m)

Usage Guidelines



- If a low-noise version is required
- For very high speeds and/or accelerations
- If large stresses and thrust forces are present
- For small bending radii
- If less vibration is required
- Minimal abrasion, suitable for cleanrooms



- For side-mounted applications
➤ Series E2/000
- For RBR (reverse bending radii)
➤ Series E2/000
- For high additional loads
➤ Series E2/000
- For very dirty environments
➤ Series R6

Features & Benefits

- 1 KMA mounting brackets with attachment points on all sides
- 2 Small pitch for low-noise, smooth operation
- 3 Crossbars open on either side
- 4 For high speed and high accelerations
- 5 Minimum vibration, high stability and tensile strength
- 6 No pin and bore connection - polymer spring



Order Example: Complete e-chain®

Please indicate chain length or number of links. Example:

3.28 ft (1 m) E61-29-100-075-0



e-chain®

With 2 separators 29-1-1 assembled every 2nd link



Interior Separation

1 Set E61-290-100-12



Mounting Bracket

e-chain system® E6-1

Series EF61-29 / E61-29

Installation Dimensions



EF61-29
E61-29

Short travel, unsupported length

- FL_B = unsupported with permitted sag
 - FL_G = unsupported with straight upper run
- Further information ► Design, Chapter 1

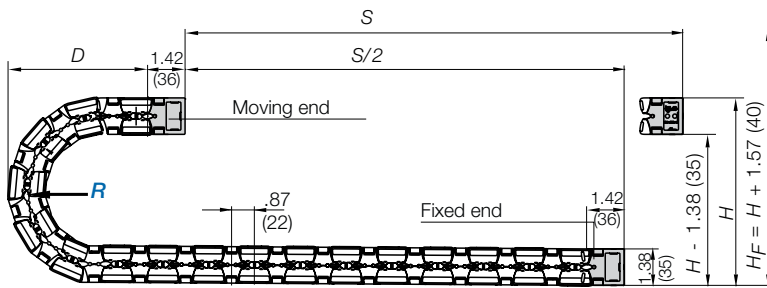
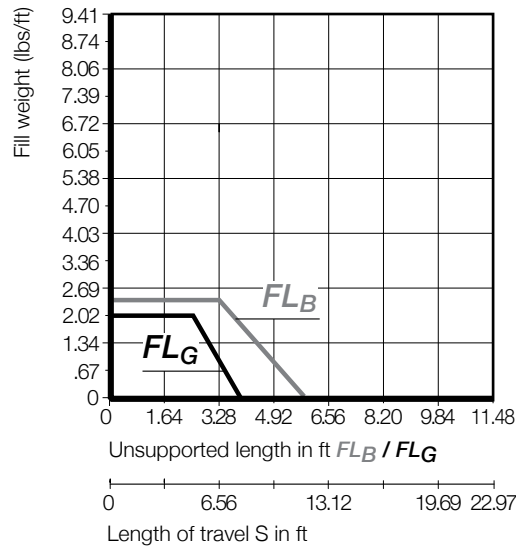
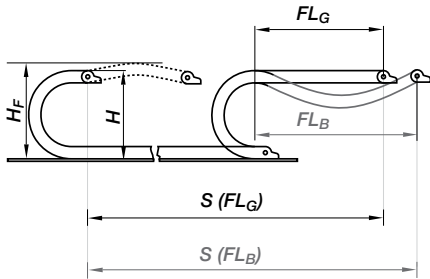

Pitch per link = .87" (22 mm)
 Links per ft (m) = 13.79 (46)
 For center mount applications:
 Chain length = $S/2 + K$

The required clearance height: $H_f = H + 1.57$ in. (40 mm) (with 1.34 lbs/ft (2.0 kg/m) fill weight). Please consult igus® if space is particularly restricted.

R	2.17 (055)	2.95 (075)	3.94 (100)	4.92 (125)	5.91 (150)
H	6.89 (175)	8.46 (215)	10.43 (265)	12.40 (315)	14.37 (365)
D	4.15 (105.5)	4.94 (125.5)	5.93 (150.5)	6.91 (175.5)	7.89 (200.5)
K	8.66 (220)	11.02 (280)	14.17 (360)	17.32 (440)	20.47 (520)

Short Travels - Unsupported



Unsupported e-chains® feature positive camber over short travels. This must be accounted for when specifying the clearance height. Please refer to **Installation dimensions** for further details.

Legend

- S = Length of travel
- R = Bending radius
- H = Nominal clearance height
- D = Overlength e-chain® radius in final position
- $K = \pi \cdot R + \text{safety buffer}$
- H_f = Required clearance height

1.14

PDF: igus.com/e-chain-pdfs
 Product information: igus.com/e-chains



Speed / acceleration FL_G	max. 65.6 ft/s (20 m/s) / max. 656 ft/s ² (200 m/s ²)
Speed / acceleration FL_B	max. 9.84 ft/s (3 m/s) / max. 19.69 ft/s ² (6 m/s ²)
Gliding speed / acceleration (maximum)	upon request
Permitted temperature, igumid G	upon request
Flammability Class	VDE 0304 IIC UL94 HB

Technical Data



Details of material properties

► Design, Chapter 1

7.42

Series EF61-29 - e-chain® - crossbars removable along the inner and outer radius
Series E61-29 - e-chain® - crossbars openable along the inner and outer radius, from both sides

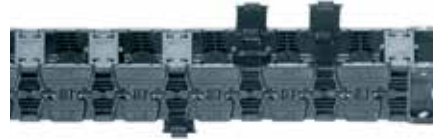
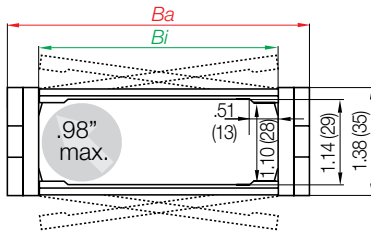

Part Number Structure

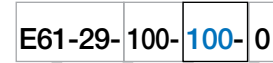

Color - Black
Bending radius
Width
Series

Telephone 1-800-521-2747

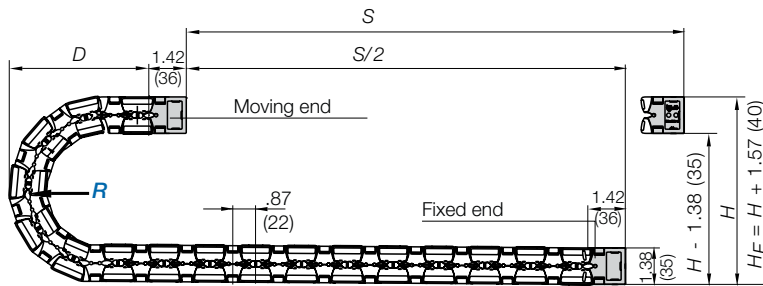

Supplement part number with required radius. Example: E61-29-100-100-0
Pitch: .87 in. (22 mm) per link links/ft (m) = 13.79 (46)

Part Number removable crossbars	Part Number openable from both sides	Bi in. (mm)	Ba in. (mm)	Weight lbs/ft (kg/m)
EF61-29-030-0	E61-29-030-0	1.18 (30)	1.73 (44)	≈ 0.37 (0.558)
EF61-29-040-0	E61-29-040-0	1.57 (40)	2.13 (54)	≈ 0.39 (0.583)
EF61-29-050-0	E61-29-050-0	1.97 (50)	2.52 (64)	≈ 0.41 (0.608)
EF61-29-060-0	E61-29-060-0	2.36 (60)	2.91 (74)	≈ 0.43 (0.633)
EF61-29-070-0	E61-29-070-0	2.76 (70)	3.31 (84)	≈ 0.44 (0.657)
EF61-29-080-0	E61-29-080-0	3.15 (80)	3.70 (94)	≈ 0.46 (0.682)
EF61-29-090-0	E61-29-090-0	3.54 (90)	4.09 (104)	≈ 0.48 (0.707)
EF61-29-100-0	E61-29-100-0	3.94 (100)	4.49 (114)	≈ 0.49 (0.732)
EF61-29-110-0	E61-29-110-0	4.33 (110)	4.88 (124)	≈ 0.51 (0.757)
EF61-29-120-0	E61-29-120-0	4.72 (120)	5.27 (134)	≈ 0.53 (0.782)
EF61-29-140-0	E61-29-140-0	5.51 (140)	6.06 (154)	≈ 0.54 (0.807)

Choose from the radii below for all of the above sizes

Radius (mm) Example: E61-29-100-100-0

	055	075	100	125	150
R	2.17 (055)	2.95 (075)	3.94 (100)	4.92 (125)	5.91 (150)
H	6.89 (175)	8.46 (215)	10.43 (265)	12.40 (315)	14.37 (365)
D	4.15 (105.5)	4.94 (125.5)	5.93 (150.5)	6.91 (175.5)	7.89 (200.5)
K	8.66 (220)	11.02 (280)	14.17 (360)	17.32 (440)	20.47 (520)

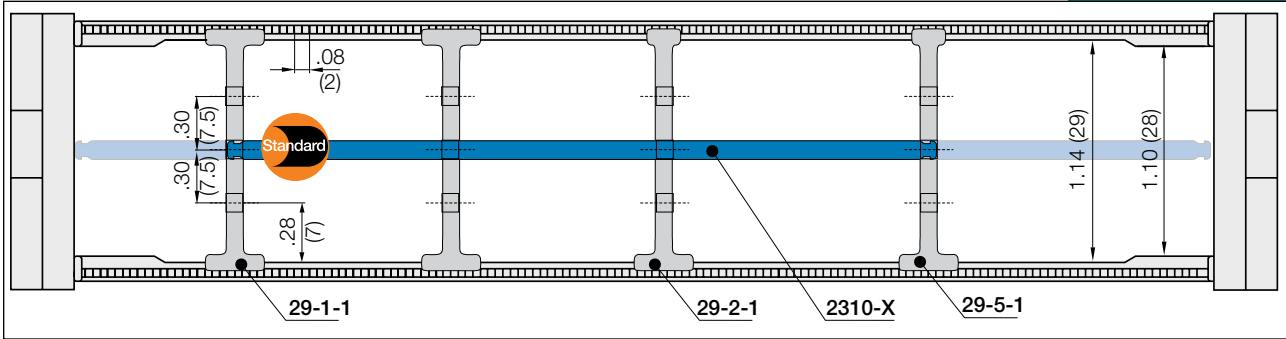

Note: Please maintain a lateral spacing of .51" (13 mm) between the separators and the side links. In the standard configuration separators are assembled every 2nd e-chain® link

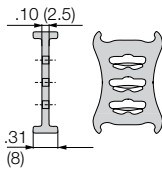

Separator, wide base

Unassembled	Part No. 29-1
Assembled	Part No. 29-1-1

- **Standard separator 29-1 for all applications**

Separator with wide base for maximum locking strength and safe standing in e-chains®.

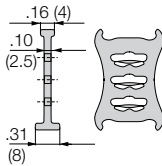

Separator, narrow head

Unassembled	Part No. 29-2
Assembled	Part No. 29-2-1

- **Separator 29-2 For even faster installation**

Firm hold to one side with a wide base, narrow on opposed side for easy cable assembly (slight grip)

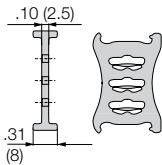

Notch separator, for notch crossbar

Unassembled	Part No. 29-5
Assembled	Part No. 29-5-1

- **Separator 29-5**

Locks safely in .08 (2 mm) increments
For exact positioning in e-chains®. Recommended for side-mounted applications.

Lockable full-width shelves - for the standard interior separation

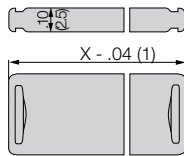

Full width shelf, lockable

Unassembled	Part No. 2300-X
Assembled	Part No. 2310-X

- **Full width shelf, lockable**

Shelf locks safely into separators on both ends, fixed width possible. Separators can be moved freely over the shelf in horizontal direction. Can be arranged at 3 different heights.

Width X in. (mm)	Part No. Unassembled	Part No. Assembled	Width X in. (mm)	Part No. Unassembled	Part No. Assembled	Width X in. (mm)	Part No. Unassembled	Part No. Assembled
0.59 (015)	2300-015	2310-015	2.36 (060)	2300-060	2310-060	3.43 (087)	2300-087	2310-087
0.98 (025)	2300-025	2310-025	2.44 (062)	2300-062	2310-062	3.54 (090)	2300-090	2310-090
1.18 (030)	2300-030	2310-030	2.56 (065)	2300-065	2310-065	3.94 (100)	2300-100	2310-100
1.50 (038)	2300-038	2310-038	2.76 (070)	2300-070	2310-070	4.06 (103)	2300-103	2310-103
1.57 (040)	2300-040	2310-040	2.95 (075)	2300-075	2310-075	4.33 (110)	2300-110	2310-110
1.97 (050)	2300-050	2310-050	3.03 (077)	2300-077	2310-077	4.72 (120)	2300-120	2310-120
2.24 (057)	2300-057	2310-057	3.15 (080)	2300-080	2310-080	4.92 (125)	2300-125	2310-125

Separator with integrated strain relief

Strain relief separator Part No. E6-29-02-Z can be integrated into the mounting bracket and can be placed at any point of the e-chain®. It combines strain relief and interior separation, it can be installed on the first or last e-chain® link and is easy to assemble without any screws.

For more information ► Chapter 10, Strain Relief



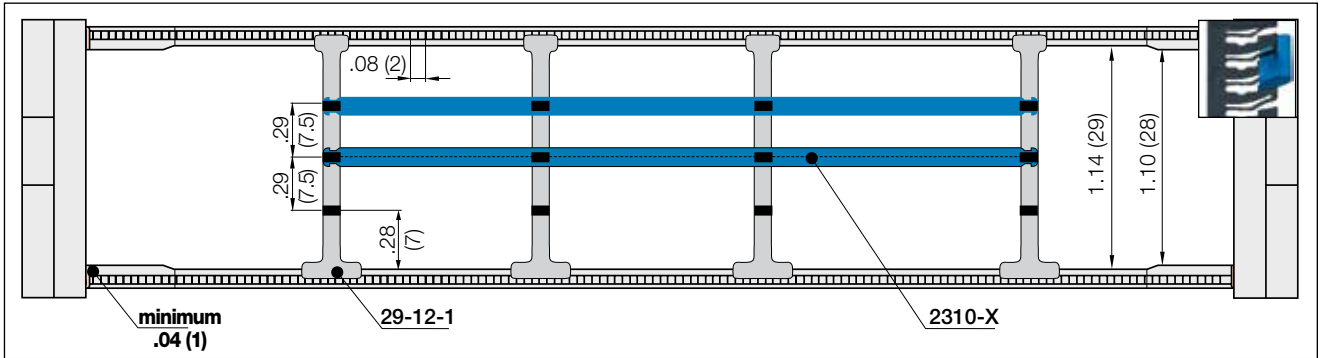

Note: Please maintain a lateral spacing of .04" (1 mm) between the separators and the side links. In the standard configuration separators are assembled every 2nd e-chain® link

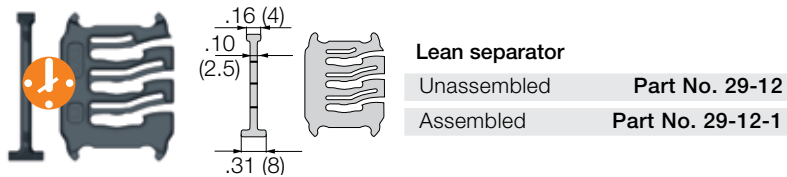

- **Lean separators**
New design allows extremely fast fitting of shelves in several layers, which significantly reduces assembly time. Enables extremely fast replacement of individual cables in a very full e-chain®.



- **Lean separator design - several layers of cables fitted quickly, save up to 50%* assembly time**
(*Lean separator vs. standard separator - measured on a 13.12 ft. (4m) long e-chain® fitted with 12 cables in the igus® harnessing factory)



Cleanroom suitable E6-1 series as harnessing readychain® system for a semiconductor industry

e-chain system® E6-1

Series EF61-29 / E61-29

Mounting Brackets - KMA / Strain Relief



EF61-29
E61-29

KMA - Pivoting

- Bolted connection outside of the chain cross-section
- Recommended for unsupported applications (for gliding applications please contact igus®)
- Confined installation conditions
- Attachment capability on all sides

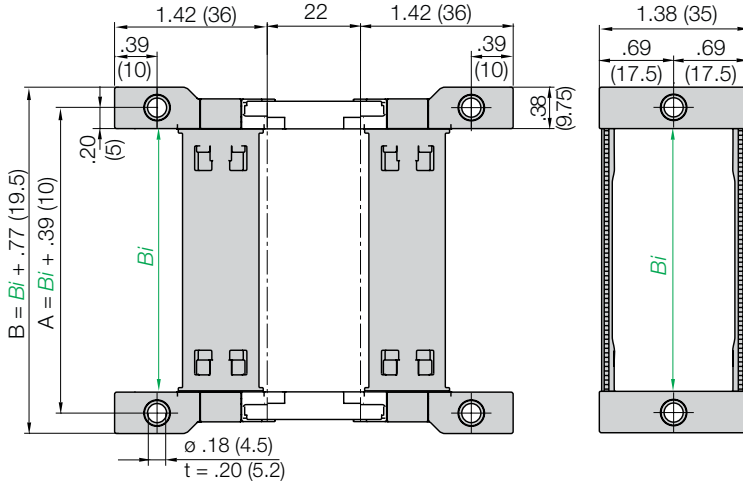
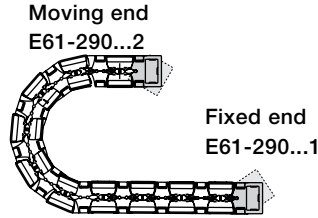

Part Number Structure

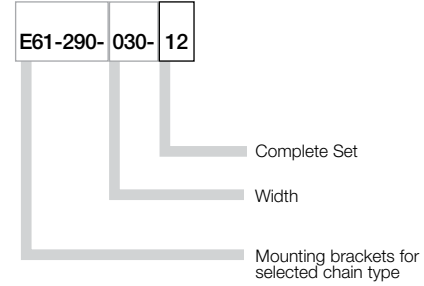

Due to the design of the E6-1 mounting brackets, chain length must be an odd number of links.

Width Index	Part No. Full Set	A in. (mm)	B in. (mm)	Bi in. (mm)
.030	E61-290-030-12	1.57 (40)	1.95 (49.5)	1.18 (30)
.040	E61-290-040-12	1.97 (50)	2.34 (59.5)	1.57 (40)
.050	E61-290-050-12	2.36 (60)	2.74 (69.5)	1.97 (50)
.060	E61-290-060-12	2.76 (70)	3.13 (79.5)	2.36 (60)
.070	E61-290-070-12	3.15 (80)	3.52 (89.5)	2.76 (70)
.080	E61-290-080-12	3.54 (90)	3.92 (99.5)	3.15 (80)
.090	E61-290-090-12	3.94 (100)	4.31 (109.5)	3.54 (90)
.100	E61-290-100-12	4.33 (110)	4.70 (119.5)	3.94 (100)
.110	E61-290-110-12	4.72 (120)	5.10 (129.5)	4.33 (110)
.120	E61-290-120-12	5.12 (130)	5.49 (139.5)	4.72 (120)
.140	E61-290-140-12	5.91 (150)	5.89 (149.5)	5.51 (140)

Tiewrap Plates

Tiewrap plates as an individual part

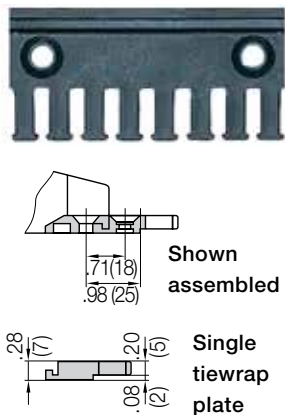

Tiewrap Plates	n Number of Teeth	Dimension C	Dimension B
2020-ZB	3	1.18 (30)	.59 (15)
2030-ZB	4	1.57 (40)	.79 (20)
2040-ZB	5	1.97 (50)	1.18 (30)
2050-ZB	6	2.36 (60)	1.57 (40)
2070-ZB	8	3.15 (80)	2.36 (60)
2090-ZB	9	3.54 (90)	2.76 (70)
2100-ZB	10	3.94 (100)	3.15 (80)
2120-ZB	12	4.72 (120)	3.94 (100)

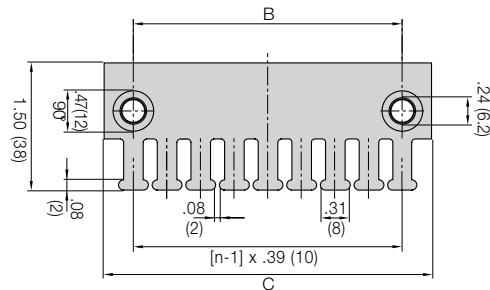

If used with KMA brackets with profile rail please add "KMA" to the end of the part number.

Example: 2020-ZBKMA

Other strain relief elements
 ► Strain Relief, Chapter 10

PDF: igus.com/e-chain-pdfs
 Product information: igus.com/e-chains



Price Index

Series E61-35
Special Features / Options

Extremely low noise
 Test results upon request

Assembly Tips

Snap-open mechanism

Other Installation Methods

Vertical, hanging ≤ 98.4 ft (30 m)

Vertical, standing ≤ 6.56 ft (2 m)

 Side-mounted, unsupported =
 upon request

 Unsupported length of upper run
 ≤ 12.47 ft (3.8 m)

Usage Guidelines

- If a low-noise version is required
- For very high speeds and/or accelerations
- If large stresses and thrust forces are present
- For small bending radii
- If less vibration is required
- Minimal abrasion, suitable for cleanrooms



- For side-mounted applications
 - **Series E2/000**
- For RBR (reverse bending radii)
 - **Series E2/000**
- For high additional loads
 - **Series E2/000**
- For very dirty environments
 - **Series R6**

Features & Benefits

- ➊ KMA mounting brackets with attachment points on all sides
- ➋ Small pitch for low-noise, smooth operation
- ➌ Crossbars open on either side
- ➍ For high speed and high accelerations
- ➎ Minimum vibration, high stability and tensile strength
- ➏ No pin and bore connection - polymer spring

Order Example: Complete e-chain®

Please indicate chain length or number of links. Example:

 3.28 ft (1 m) **E61-35-100-075-0**

e-chain®

 With 2 separators **E6-35-1-1** assembled every 2nd link

Interior Separation

 1 Set **E61-350-100-12**

Mounting Bracket

e-chain system® E6-1

Series E61-35

Installation Dimensions



E61-35

Short travel, unsupported length

- FL_B = unsupported with permitted sag
 - FL_G = unsupported with straight upper run
- Further information ► Design, Chapter 1

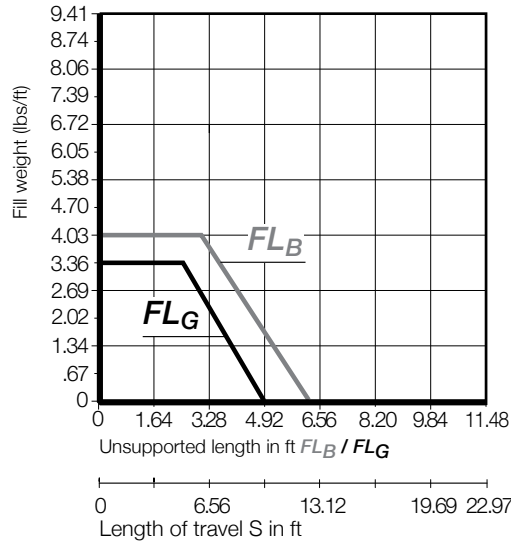
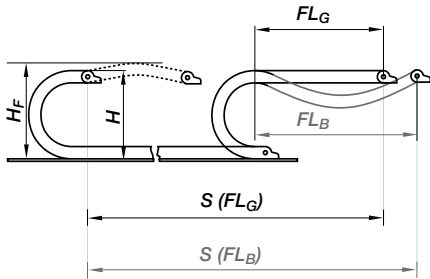

Short Travels - Unsupported



Unsupported e-chains® feature positive camber over short travels. This must be accounted for when specifying the clearance height. Please refer to **Installation dimensions** for further details.

Legend

- S = Length of travel
- R = Bending radius
- H = Nominal clearance height
- D = Overlength e-chain® radius in final position
- $K = \pi \cdot R + \text{safety buffer}$
- H_F = Required clearance height

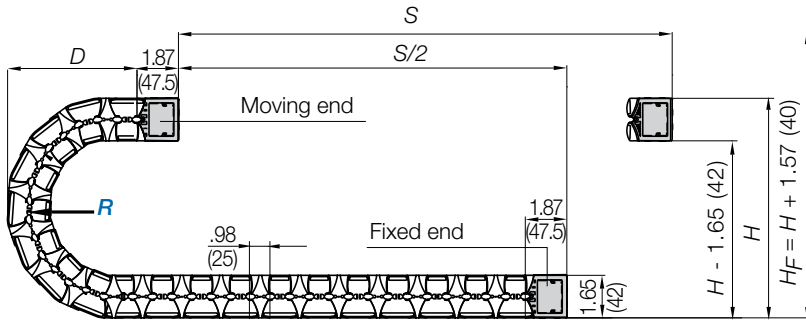

Pitch per link: = .98" (25 mm)
 Links per ft (m): = 12 (40)
 For center mount applications:
 Chain length = $\frac{S}{2} + K$

The required clearance height: $H_F = H + 1.57$ in. (40 mm) (with 1.34 lbs/ft (2.0 kg/m) fill weight). Please consult igus® if space is particularly restricted.

R	2.17 (055)	2.95 (075)	3.94 (100)	4.92 (125)	5.91 (150)
H	7.56 (192)	9.13 (232)	11.10 (282)	13.10 (332)	15.04 (382)
D	4.47 (113.5)	5.26 (133.5)	6.24 (158.5)	7.22 (183.5)	8.21 (208.5)
K	8.86 (225)	11.42 (290)	14.37 (365)	17.52 (445)	20.67 (525)

If a gliding application is required for a long travel, please consult igus®.

Aluminum support tray

- Corrosion-resistant and seawater-resistant aluminum rails with adjustable width
- Noise-reducing glide strip integrated as standard
- Easy installation and connection of the e-chain®
- Open design - dirt and debris fall through

More information ► Chapter 9



Speed / acceleration FL_G	max. 65.6 ft/s (20 m/s) / max. 656 ft/s ² (200 m/s ²)
Speed / acceleration FL_B	max. 9.84 ft/s (3 m/s) / max. 19.69 ft/s ² (6 m/s ²)
Gliding speed / acceleration (maximum)	upon request
Permitted temperature, igumid G	upon request
Flammability Class	VDE 0304 IIC UL94 HB

Technical Data



Details of material properties

► Design, Chapter 1

1.38

PDF: igus.com/e-chain-pdfs
 Product information: igus.com/e-chains



7.48

Series E61-35 - e-chain® - crossbars removable along the inner and outer radius

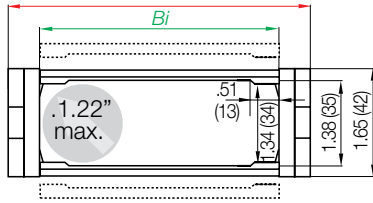

Part Number Structure

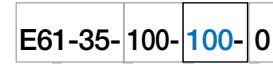

- Color - Black
- Bending radius
- Width
- Series

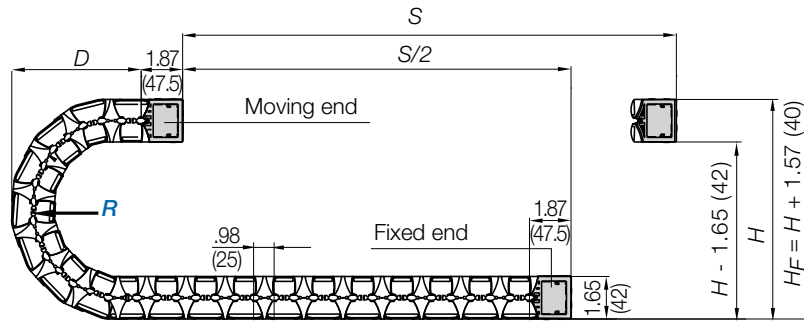

Supplement part number with required radius. Example: E61-35-100-100-0

Pitch: .98 in. (25 mm) per link links/ft (m) = 12 (40)

Part Number	Bi in. (mm)	Ba in. (mm)	Weight lbs/ft (kg/m)
E61-35-030-□-0	1.18 (30)	1.81 (46)	≈ 0.439 (0.653)
E61-35-040-□-0	1.57 (40)	2.20 (56)	≈ 0.454 (0.675)
E61-35-050-□-0	1.97 (50)	2.60 (66)	≈ 0.468 (0.696)
E61-35-060-□-0	2.36 (60)	2.99 (76)	≈ 0.482 (0.718)
E61-35-070-□-0	2.76 (70)	3.39 (86)	≈ 0.497 (0.739)
E61-35-080-□-0	3.15 (80)	3.78 (96)	≈ 0.511 (0.761)
E61-35-090-□-0	3.54 (90)	4.17 (106)	≈ 0.526 (0.783)
E61-35-100-□-0	3.94 (100)	4.57 (116)	≈ 0.540 (0.804)
E61-35-110-□-0	4.33 (110)	4.96 (126)	≈ 0.555 (0.826)
E61-35-120-□-0	4.72 (120)	5.35 (136)	≈ 0.570 (0.848)
E61-35-140-□-0	5.51 (140)	6.14 (156)	≈ 0.599 (0.891)

Choose from the radii below for all of the above sizes
Radius (mm) Example: E61-35-100-100-0

	055	075	100	125	150
R	2.17 (055)	2.95 (075)	3.94 (100)	4.92 (125)	5.91 (150)
H	7.56 (192)	9.13 (232)	11.10 (282)	13.10 (332)	15.04 (382)
D	4.47 (113.5)	5.26 (133.5)	6.24 (158.5)	7.22 (183.5)	8.21 (208.5)
K	8.86 (225)	11.42 (290)	14.37 (365)	17.52 (445)	20.67 (525)

e-chain system® E6-1
Series E61-35
Interior Separation



E61-35

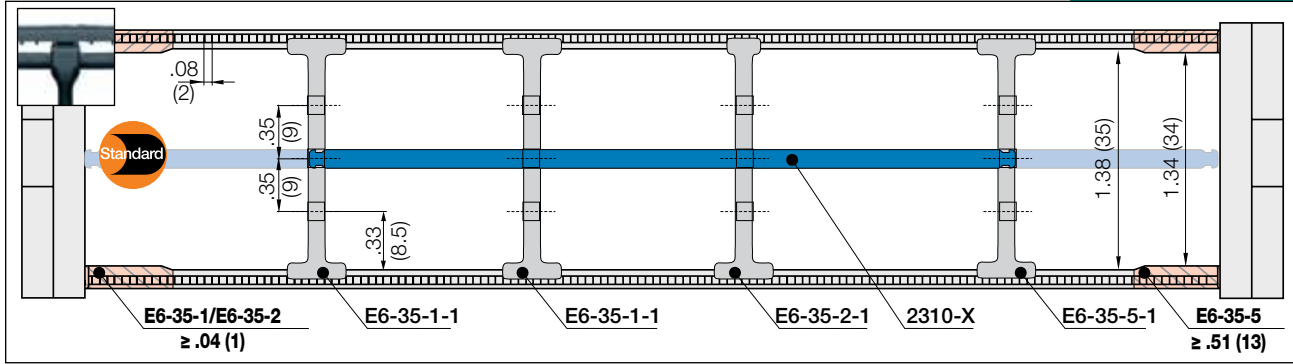

Note: Please maintain a lateral spacing of .51" (13 mm) between the separators and the side links. In the standard configuration separators are assembled every 2nd e-chain® link

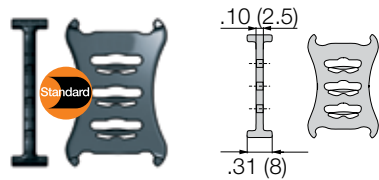

Separator, wide base

Unassembled Part No. E6-35-1

Assembled Part No. E6-35-1-1

- Standard separator E6-35-1 for all applications

Separator with wide base for maximum locking strength and safe standing in e-chains®.

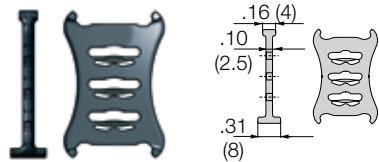

Separator, narrow head

Unassembled Part No. E6-35-2

Assembled Part No. E6-35-2-1

- Separator E6-35-2 For even faster installation

Firm hold to one side with a wide base, narrow on opposed side for easy cable assembly (slight grip)

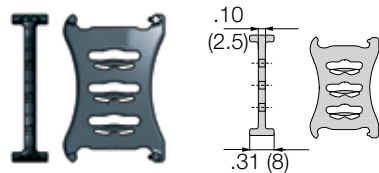

Notch separator, for notch crossbar

Unassembled Part No. E6-35-5

Assembled Part No. E6-35-5-1

- Separator E6-35-5 Locks safely in .08 (2 mm) increments For exact positioning in e-chains®. Recommended for side-mounted applications.

Lockable full-width shelves - for the standard interior separation

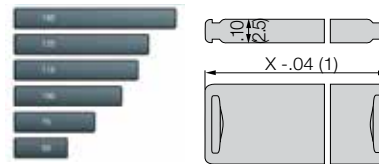

Full width shelf, lockable

Unassembled Part No. 2300-X

Assembled Part No. 2310-X

- Full width shelf, lockable

Shelf locks safely into separators on both ends, fixed width possible. Separators can be moved freely over the shelf in horizontal direction. Can be arranged at 3 different heights.

Width X in. (mm)	Part No. Unassembled	Part No. Assembled	Width X in. (mm)	Part No. Unassembled	Part No. Assembled	Width X in. (mm)	Part No. Unassembled	Part No. Assembled
0.59 (015)	2300-015	2310-015	2.36 (060)	2300-060	2310-060	3.43 (087)	2300-087	2310-087
0.98 (025)	2300-025	2310-025	2.44 (062)	2300-062	2310-062	3.54 (090)	2300-090	2310-090
1.18 (030)	2300-030	2310-030	2.56 (065)	2300-065	2310-065	3.94 (100)	2300-100	2310-100
1.50 (038)	2300-038	2310-038	2.76 (070)	2300-070	2310-070	4.06 (103)	2300-103	2310-103
1.57 (040)	2300-040	2310-040	2.95 (075)	2300-075	2310-075	4.33 (110)	2300-110	2310-110
1.97 (050)	2300-050	2310-050	3.03 (077)	2300-077	2310-077	4.72 (120)	2300-120	2310-120
2.24 (057)	2300-057	2310-057	3.15 (080)	2300-080	2310-080	4.92 (125)	2300-125	2310-125

Separator with integrated strain relief

Strain relief separator Part No. E6-35-02-Z can be integrated into the mounting bracket and can be placed at any point of the e-chain®. It combines strain relief and interior separation, it can be installed on the first or last e-chain® link and is easy to assemble without any screws.

For more information ► Chapter 10, Strain Relief



PDF: igus.com/e-chain-pdfs
Product information: igus.com/e-chains





KMA - Pivoting

- Bolted connection outside of the chain cross-section
- Recommended for unsupported applications (for gliding applications please contact igus®)
- Confined installation conditions
- Attachment capability on all sides

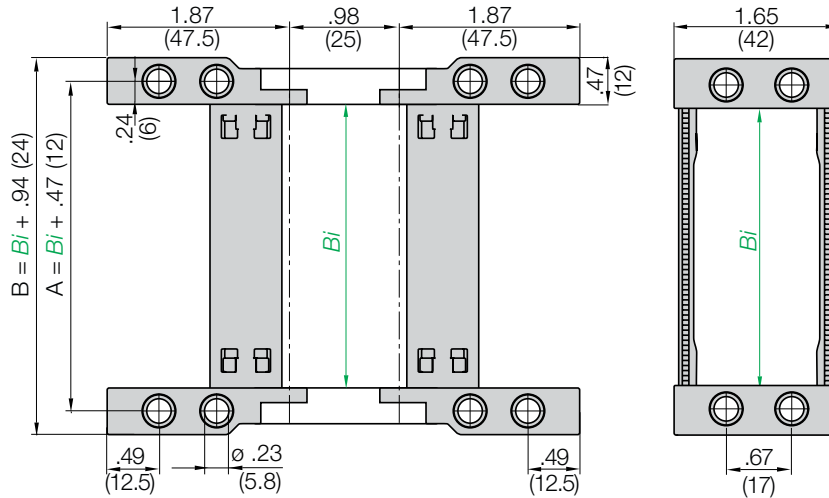
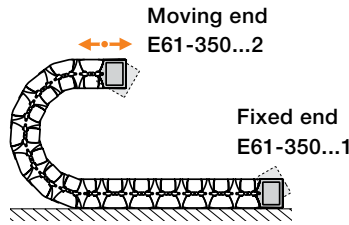

Part Number Structure

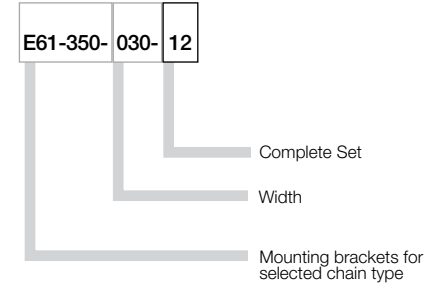

Due to the design of the E6-1 mounting brackets, chain length must be an odd number of links.

Width Index	Part No. Full Set	A in. (mm)	B in. (mm)	Bi in. (mm)
.030	E61-350-030-12	1.57 (40)	1.95 (49.5)	1.18 (30)
.040	E61-350-040-12	1.97 (50)	2.34 (59.5)	1.57 (40)
.050	E61-350-050-12	2.36 (60)	2.74 (69.5)	1.97 (50)
.060	E61-350-060-12	2.76 (70)	3.13 (79.5)	2.36 (60)
.070	E61-350-070-12	3.15 (80)	3.52 (89.5)	2.76 (70)
.080	E61-350-080-12	3.54 (90)	3.92 (99.5)	3.15 (80)
.090	E61-350-090-12	3.94 (100)	4.31 (109.5)	3.54 (90)
.100	E61-350-100-12	4.33 (110)	4.70 (119.5)	3.94 (100)
.110	E61-350-110-12	4.72 (120)	5.10 (129.5)	4.33 (110)
.120	E61-350-120-12	5.12 (130)	5.49 (139.5)	4.72 (120)
.140	E61-350-140-12	5.91 (150)	5.89 (149.5)	5.51 (140)

Tiewrap Plates

Tiewrap plates as an individual part

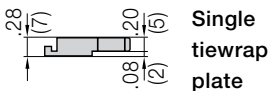
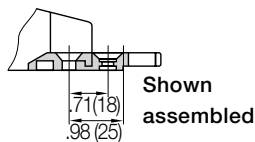

Tiewrap Plates	n Number of Teeth	Dimension C	Dimension B
2020-ZB	3	1.18 (30)	.59 (15)
2030-ZB	4	1.57 (40)	.79 (20)
2040-ZB	5	1.97 (50)	1.18 (30)
2050-ZB	6	2.36 (60)	1.57 (40)
2070-ZB	8	3.15 (80)	2.36 (60)
2090-ZB	9	3.54 (90)	2.76 (70)
2100-ZB	10	3.94 (100)	3.15 (80)
2120-ZB	12	4.72 (120)	3.94 (100)

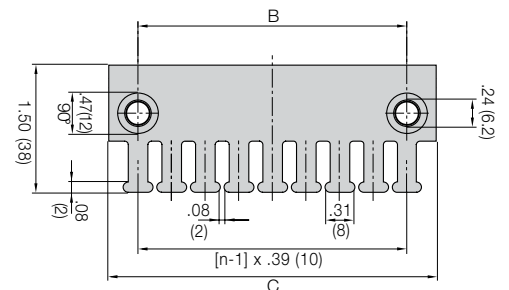

If used with KMA brackets with profile rail please add "KMA" to the end of the part number.

Example: 2020-ZBKMA

Other strain relief elements

➤ **Strain Relief, Chapter 10**

PDF: igus.com/e-chain-pdfs
Product information: igus.com/e-chains



Price Index

Series E61-40
Special Features / Options

Extremely low noise
 Test results upon request

Assembly Tips

snap-open mechanism

Other Installation Methods

Vertical, hanging ≤ 98.4 ft (30 m)

Vertical, standing ≤ 6.56 ft (2 m)

 Side-mounted, unsupported =
 upon request

 Unsupported length of upper run
 ≤ 16.4 ft (5 m)

Usage Guidelines

- If a low-noise version is required
- For very high speeds and/or accelerations
- If large stresses and thrust forces are present
- For small bending radii
- If less vibration is required
- Minimal abrasion, suitable for cleanrooms



- For side-mounted applications
 ➤ **Series E2/000**
- For RBR (reverse bending radii)
 ➤ **Series E2/000**
- For high additional loads
 ➤ **Series E2/000**
- For very dirty environments
 ➤ **Series R6**

Features & Benefits

- ➊ KMA mounting brackets with attachment points on all sides
- ➋ Small pitch for low-noise, smooth operation
- ➌ Crossbars open on either side
- ➍ For high speed and high accelerations
- ➎ Minimum vibration, high stability and tensile strength
- ➏ No pin and bore connection - polymer spring

Order Example: Complete e-chain®

Please indicate chain length or number of links. Example:

 3.28 ft (1 m) **E61-40-100-075-0**

e-chain®

 With 2 separators **E6-40-1-1** assembled every 2nd link

Interior Separation

 1 Set **E61-400-100-12**

Mounting Bracket

e-chain system® E6-1

Series E61-40

Installation Dimensions



E61-40

Short travel, unsupported length

- FL_B = unsupported with permitted sag
 - FL_G = unsupported with straight upper run
- Further information ► Design, Chapter 1

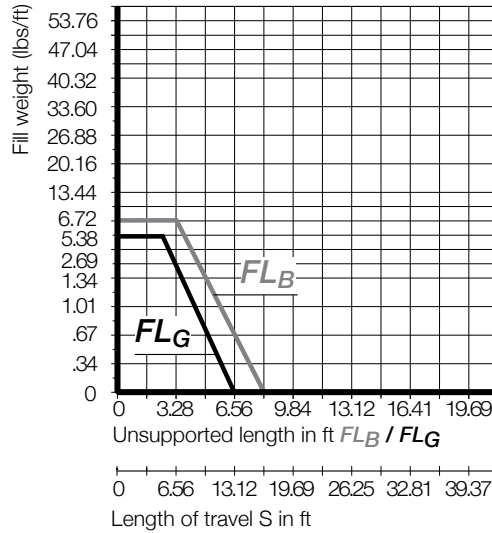
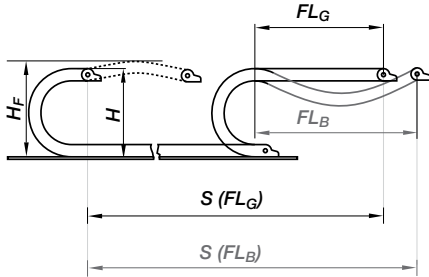

Short Travels - Unsupported



Unsupported e-chains® feature positive camber over short travels. This must be accounted for when specifying the clearance height. Please refer to **Installation dimensions** for further details.

Legend

- S = Length of travel
- R = Bending radius
- H = Nominal clearance height
- D = Overlength e-chain® radius in final position
- $K = \pi \cdot R + \text{safety buffer}$
- $H_F = \text{Required clearance height}$

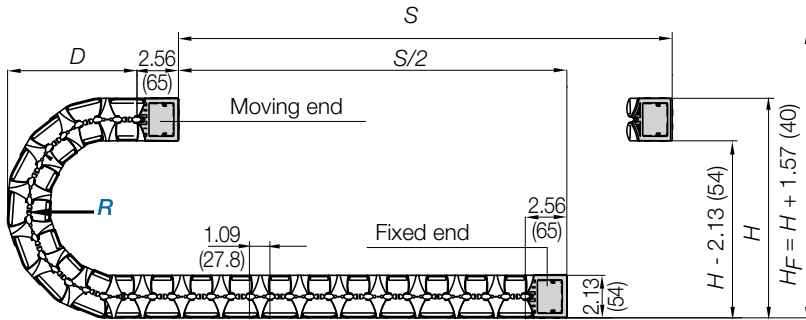

Pitch per link = 1.09" (27.8 mm)
 Links per ft (m) = 11 (36)
 For center mount applications:
 Chain length = $\frac{S}{2} + K$

The required clearance height: $H_F = H + 1.57$ in. (40 mm) (with 1.34 lbs/ft (2.0 kg/m) fill weight). Please consult igus® if space is particularly restricted.

R	2.48 (063)	2.95 (075)	3.94 (100)	4.92 (125)	5.91 (150)	7.87 (200)
H	8.66 (220)	9.61 (244)	11.57 (294)	13.54 (344)	15.51 (394)	19.45 (494)
D	5.20 (132)	5.67 (144)	6.65 (169)	7.64 (194)	8.62 (219)	10.59 (269)
K	10.04 (255)	11.61 (295)	14.57 (370)	17.72 (450)	2.09 (530)	26.97 (685)



i If a gliding application is required for a long travel, please consult igus®.

Aluminum support tray

- Corrosion-resistant and seawater-resistant aluminum rails with adjustable width
- Noise-reducing glide strip integrated as standard
- Easy installation and connection of the e-chain®
- Open design - dirt and debris fall through

More information ► Chapter 9



Speed / acceleration FL_G	max. 65.6 ft/s (20 m/s) / max. 656 ft/s ² (200 m/s ²)
Speed / acceleration FL_B	max. 9.84 ft/s (3 m/s) / max. 19.69 ft/s ² (6 m/s ²)
Gliding speed / acceleration (maximum)	upon request
Permitted temperature, igumid G	upon request
Flammability Class	VDE 0304 IIC UL94 HB

Technical Data



Details of material properties

► Design, Chapter 1

PDF: igus.com/e-chain-pdfs
 Product information: igus.com/e-chains



Series E61-40 - e-chain® - crossbars removable along the inner and outer radius

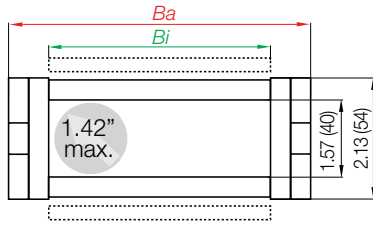

Part Number Structure

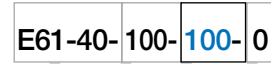

- Color - Black
- Bending radius
- Width
- Series

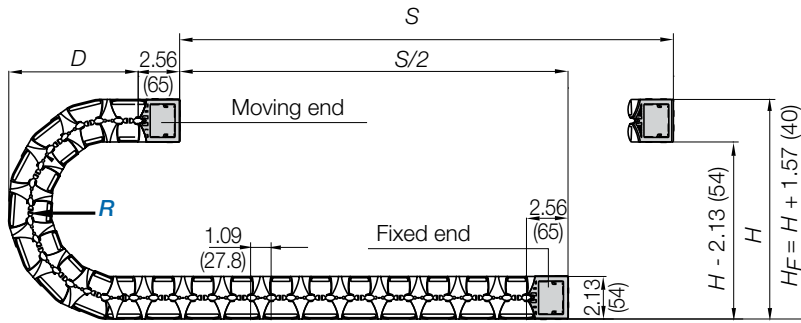

Supplement part number with required radius. Example: E61-40-100-**100**-0
Pitch: 1.09 in. (27.8 mm) per link links/ft (m) = 11 (36)

Part Number	Bi in. (mm)	Ba in. (mm)	Weight lbs/ft (kg/m)
E61-40-040-□-0	1.57 (40)	2.20 (56)	≈ 0.613 (0.913)
E61-40-050-□-0	1.97 (50)	2.60 (66)	≈ 0.638 (0.950)
E61-40-052-□-0	2.05 (52)	2.68 (68)	≈ 0.643 (0.957)
E61-40-062-□-0	2.44 (62)	3.07 (78)	≈ 0.668 (0.994)
E61-40-070-□-0	2.76 (70)	3.39 (86)	≈ 0.687 (1.023)
E61-40-075-□-0	2.95 (75)	3.58 (91)	≈ 0.700 (1.042)
E61-40-087-□-0	3.43 (87)	4.06 (103)	≈ 0.716 (1.066)
E61-40-100-□-0	3.94 (100)	4.57 (116)	≈ 0.762 (1.134)
E61-40-125-□-0	4.92 (125)	5.55 (141)	≈ 0.824 (1.226)
E61-40-150-□-0	5.91 (150)	6.54 (166)	≈ 0.886 (1.318)
E61-40-175-□-0	6.89 (175)	7.52 (191)	≈ 0.947 (1.410)
E61-40-200-□-0	7.87 (200)	8.50 (216)	≈ 1.009 (1.502)
E61-40-225-□-0	8.86 (225)	9.49 (241)	≈ 1.072 (1.595)
E61-40-250-□-0	9.84 (250)	10.47 (266)	≈ 1.134 (1.687)
E61-40-275-□-0	10.83 (275)	11.46 (291)	≈ 1.195 (1.779)
E61-40-300-□-0	11.81 (300)	12.44 (316)	≈ 1.257 (1.871)

Choose from the radii below for all of the above sizes
Radius (mm) Example: E61-40-100-**100**-0

	063	075	100	125	150	150
R	2.48 (063)	2.95 (075)	3.94 (100)	4.92 (125)	5.91 (150)	7.87 (200)
H	8.66 (220)	9.61 (244)	11.57 (294)	13.54 (344)	15.51 (394)	19.45 (494)
D	5.20 (132)	5.67 (144)	6.65 (169)	7.64 (194)	8.62 (219)	10.59 (269)
K	10.04 (255)	11.61 (295)	14.57 (370)	17.72 (450)	2.09 (530)	26.97 (685)

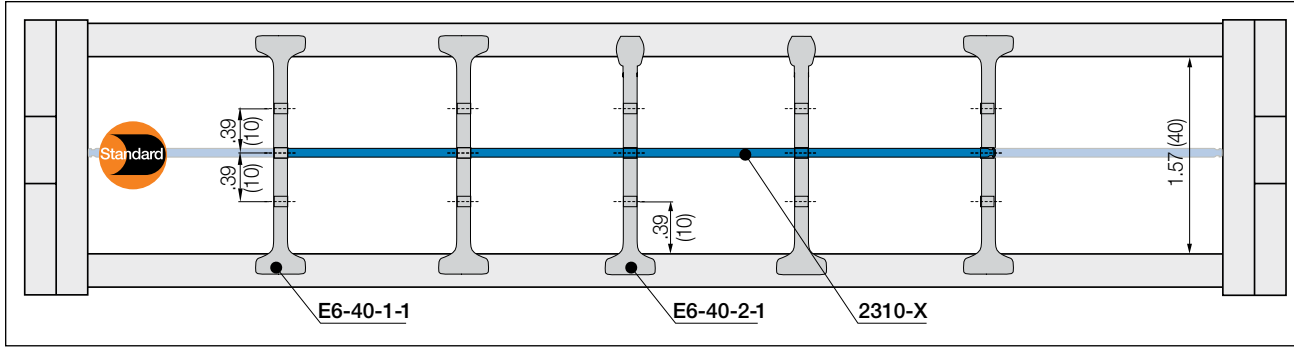

Note: Please maintain a lateral spacing of .51" (13 mm) between the separators and the side links. In the standard configuration separators are assembled every 2nd e-chain® link

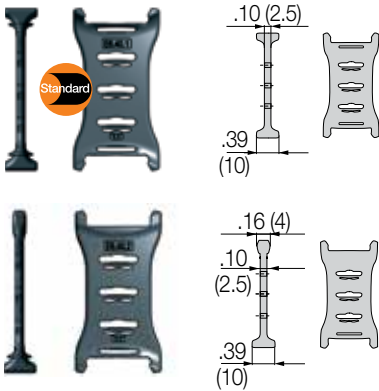

Separator, wide base
Unassembled Part No. E6-40-1
Assembled Part No. E6-40-1-1

- **Standard separator E6-40-1 for all applications**
Separator with wide base for maximum locking strength and safe standing in e-chains®.

Separator, narrow head
Unassembled Part No. E6-40-2
Assembled Part No. E6-40-2-1

- **Separator E6-40-2 For even faster installation**
Firm hold to one side with a wide base, narrow on opposed side for easy cable assembly (slight grip)

Lockable full-width shelves - for the standard interior separation

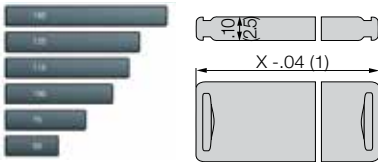

Full width shelf, lockable
Unassembled Part No. 2300-X
Assembled Part No. 2310-X

- **Full width shelf, lockable**
Shelf locks safely into separators on both ends, fixed width possible. Separators can be moved freely over the shelf in horizontal direction. Can be arranged at 3 different heights.

Width X in. (mm)	Part No. Unassembled	Part No. Assembled	Width X in. (mm)	Part No. Unassembled	Part No. Assembled	Width X in. (mm)	Part No. Unassembled	Part No. Assembled
0.59 (015)	2300-015	2310-015	2.36 (060)	2300-060	2310-060	3.43 (087)	2300-087	2310-087
0.98 (025)	2300-025	2310-025	2.44 (062)	2300-062	2310-062	3.54 (090)	2300-090	2310-090
1.18 (030)	2300-030	2310-030	2.56 (065)	2300-065	2310-065	3.94 (100)	2300-100	2310-100
1.50 (038)	2300-038	2310-038	2.76 (070)	2300-070	2310-070	4.06 (103)	2300-103	2310-103
1.57 (040)	2300-040	2310-040	2.95 (075)	2300-075	2310-075	4.33 (110)	2300-110	2310-110
1.97 (050)	2300-050	2310-050	3.03 (077)	2300-077	2310-077	4.72 (120)	2300-120	2310-120
2.24 (057)	2300-057	2310-057	3.15 (080)	2300-080	2310-080	4.92 (125)	2300-125	2310-125

Separator with integrated strain relief

Strain relief separator Part No. E6-40-02-Z can be integrated into the mounting bracket and can be placed at any point of the e-chain®. It combines strain relief and interior separation, it can be installed on the first or last e-chain® link and is easy to assemble without any screws.

For more information ► Chapter 10, Strain Relief



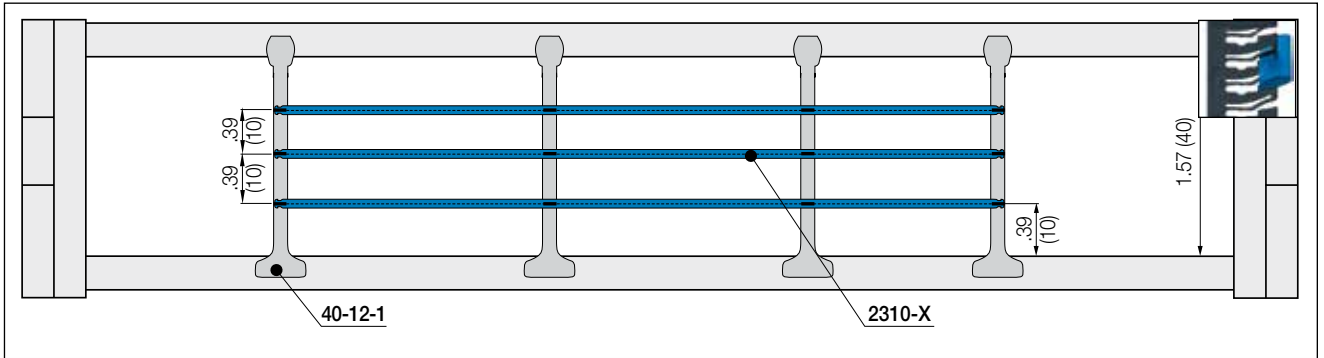

Note: No lateral gap to side links is necessary.

In the standard configuration separators are assembled every 2nd e-chain® link

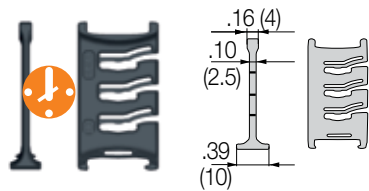

Lean separator

Unassembled Part No. 40-12

Assembled Part No. 40-12-1

• Lean separators

New design allows extremely fast fitting of shelves in several layers, which significantly reduces assembly time. Enables extremely fast replacement of individual cables in a very full e-chain®.

• Lean separator design - several layers of cables fitted quickly, save up to 50%* assembly time

(*Lean separator vs. standard separator - measured on a 13.12 ft (4m) long e-chain® fitted with 12 cables in the igus® harnessing factory)



Telephone 1-800-521-2747

Internet: igus.com
 email: sales@igus.com
 QuickSpec: igus.com/quickspec



Very small bend radii are possible with chainflex® CF98 control cable in this E6-1 readychain® system. It offers smooth operation and is suitable for cleanrooms

e-chain system® E6-1

Series E61-40

Mounting Brackets - KMA



E61-40

KMA - Pivoting

- Bolted connection outside of the chain cross-section
- Recommended for unsupported applications (for gliding applications please contact igus®)
- Confined installation conditions
- Attachment capability on all sides

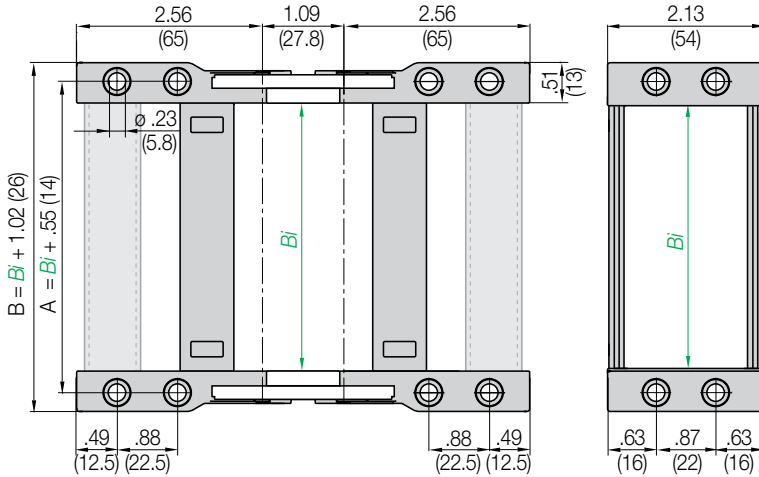
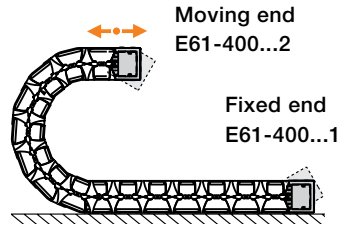

Part Number Structure

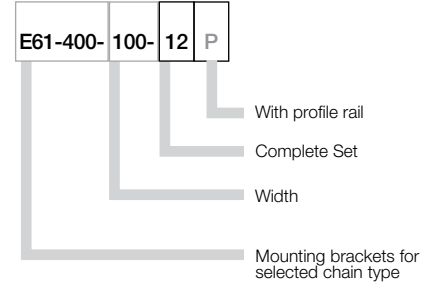

Due to the design of the E6-1 mounting brackets, chain length must be an odd number of links.

For Series	Part No. Full Set Without Profile Rail	Part No. Full Set With Profile Rail	Dimension A		Dimension B		Bi	
			in.	(mm)	in.	(mm)	in.	(mm)
.040	E61-400-040-12	E61-400-040-12P	2.13	(54)	2.60	(66)	1.57	(40)
.050	E61-400-050-12	E61-400-050-12P	2.52	(64)	2.99	(76)	1.97	(50)
.052	E61-400-052-12	E61-400-052-12P	2.66	(66)	3.07	(78)	2.05	(52)
.062	E61-400-062-12	E61-400-062-12P	2.99	(76)	3.46	(88)	2.44	(62)
.070	E61-400-070-12	E61-400-070-12P	3.31	(84)	3.78	(96)	2.76	(70)
.075	E61-400-075-12	E61-400-075-12P	3.50	(89)	3.98	(101)	2.95	(75)
.087	E61-400-087-12	E61-400-087-12P	3.98	(101)	4.45	(113)	3.42	(87)
.100	E61-400-100-12	E61-400-100-12P	4.49	(114)	4.96	(126)	3.94	(100)
.125	E61-400-125-12	E61-400-125-12P	5.47	(139)	5.94	(151)	4.92	(125)
.150	E61-400-150-12	E61-400-150-12P	6.46	(164)	6.93	(176)	5.91	(150)
.175	E61-400-175-12	E61-400-175-12P	7.44	(189)	7.91	(201)	6.89	(175)
.200	E61-400-200-12	E61-400-200-12P	8.43	(214)	8.90	(226)	7.87	(200)
.225	E61-400-225-12	E61-400-225-12P	9.41	(239)	9.88	(251)	8.86	(225)
.250	E61-400-250-12	E61-400-250-12P	10.39	(264)	10.87	(276)	9.84	(250)
.275	E61-400-275-12	E61-400-275-12P	11.38	(289)	11.85	(301)	10.83	(275)
.300	E61-400-300-12	E61-400-300-12P	12.36	(314)	12.83	(326)	11.81	(300)

PDF: igus.com/e-chain-pdfs
 Product information: igus.com/e-chains

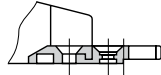

Tiewrap Plates

Shown
assembled

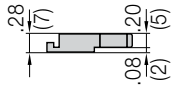

Single
tiewrap
plate

Tiewrap plates as an individual part

Tiewrap Plates	n Number of Teeth	Dimension C	Dimension B
2020-ZB	3	1.18 (30)	.59 (15)
2030-ZB	4	1.57 (40)	.79 (20)
2040-ZB	5	1.97 (50)	1.18 (30)
2050-ZB	6	2.36 (60)	1.57 (40)
2070-ZB	8	3.15 (80)	2.36 (60)
2090-ZB	9	3.54 (90)	2.76 (70)
2100-ZB	10	3.94 (100)	3.15 (80)
2120-ZB	12	4.72 (120)	3.94 (100)

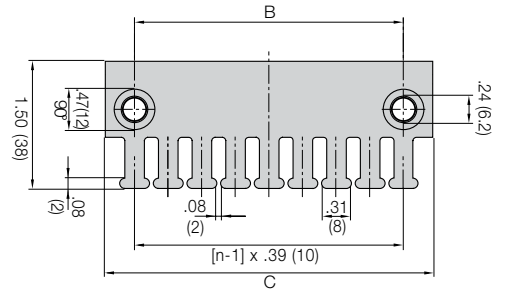

If used with KMA brackets with profile rail please add "KMA" to the end of the part number.

Example: 2020-ZBKMA

Other strain relief elements

► **Strain Relief, Chapter 10**



PDF: igus.com/e-chain-pdfs
Product information: igus.com/e-chains



Price Index

Series E61-52
Special Features / Options

Extremely low noise
 Test results upon request

Assembly Tips

snap-open mechanism

Other Installation Methods

Vertical, hanging ≤ 164 ft (50 m)

Vertical, standing ≤ 6.56 ft (2 m)

 Side-mounted, unsupported =
 upon request

 Unsupported length of upper run
 ≤ 19.69 ft (6 m)

Usage Guidelines

- If a low-noise version is required
- For very high speeds and/or accelerations
- If large stresses and thrust forces are present
- For small bending radii
- If less vibration is required
- Minimal abrasion, suitable for cleanrooms



- For side-mounted applications
 - **Series E2/000**
- For RBR (reverse bending radii)
 - **Series E2/000**
- For high additional loads
 - **Series E2/000**
- For very dirty environments
 - **Series R6**

Features & Benefits

- ➊ KMA mounting brackets with attachment points on all sides
- ➋ Small pitch for low-noise, smooth operation
- ➌ Crossbars open on either side
- ➍ For high speed and high accelerations
- ➎ Minimum vibration, high stability and tensile strength
- ➏ No pin and bore connection - polymer spring

Order Example: Complete e-chain®

Please indicate chain length or number of links. Example:

 3.28 ft (1 m) **E61-52-100-075-0**

e-chain®

 With 2 separators **E6-52-1-1** assembled every 2nd link

Interior Separation

 1 Set **E61-520-100-12**

Mounting Bracket

e-chain system® E6-1

Series E61-52

Installation Dimensions



E61-52

Short travel, unsupported length

- FL_B = unsupported with permitted sag
 - FL_G = unsupported with straight upper run
- Further information ► Design, Chapter 1

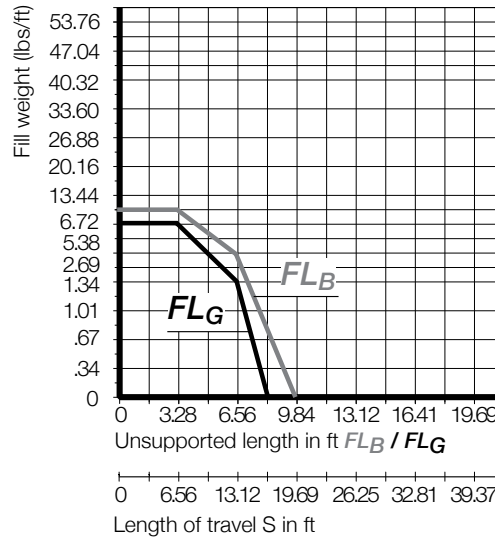
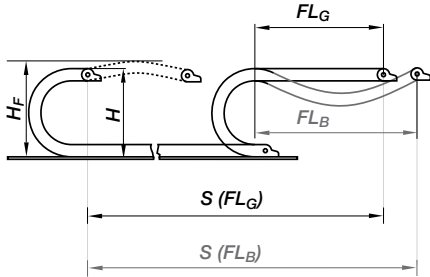

Short Travels - Unsupported

2.05



Unsupported e-chains® feature positive camber over short travels. This must be accounted for when specifying the clearance height. Please refer to **Installation dimensions** for further details.

Legend

- S = Length of travel
- R = Bending radius
- H = Nominal clearance height
- D = Overlength e-chain® radius in final position
- $K = \pi \cdot R + \text{safety buffer}$
- H_F = Required clearance height

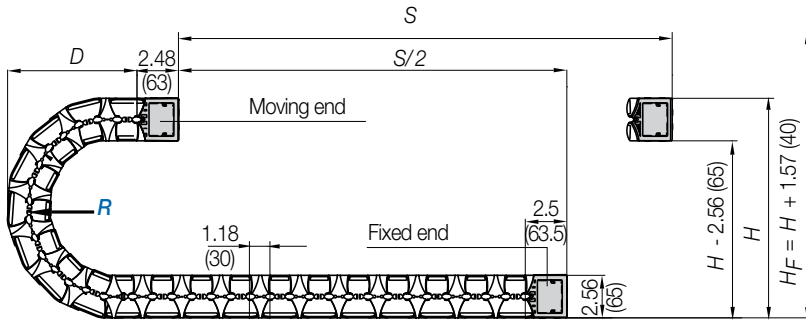

Pitch per link = 1.18" (30 mm)
 Links per ft (m) = 10 (34)
 For center mount applications:
 Chain length = $\frac{S}{2} + K$

The required clearance height: $H_F = H + 1.57$ in. (40 mm) (with 1.34 lbs/ft (2.0 kg/m) fill weight). Please consult igus® if space is particularly restricted.

R	2.95 (075)	3.94 (100)	4.92 (125)	5.91 (150)
H	10.43 (265)	12.40 (315)	14.37 (365)	16.34 (415)
D	6.02 (153)	7.01 (178)	7.99 (203)	8.98 (228)
K	11.81 (300)	14.76 (375)	17.91 (455)	21.06 (535)

If a gliding application is required for a long travel, please consult igus®.

Steel support tray for support of lower run

- Simple one-piece support trays for the lower run
- To your requirements and specifications
- 4 options available

More information ► Chapter 9



Speed / acceleration FL_G	max. 65.6 ft/s (20 m/s) / max. 656 ft/s ² (200 m/s ²)
Speed / acceleration FL_B	max. 9.84 ft/s (3 m/s) / max. 19.69 ft/s ² (6 m/s ²)
Gliding speed / acceleration (maximum)	upon request
Permitted temperature, igumid G	upon request
Flammability Class	VDE 0304 IIC UL94 HB

Technical Data



Details of material properties

► Design, Chapter 1

PDF: igus.com/e-chain-pdfs
 Product information: igus.com/e-chains



Series E61-52 - e-chain® -
crossbars removable along the inner and outer radius

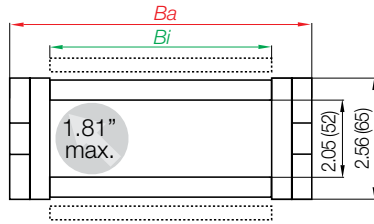

Part Number Structure

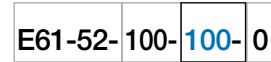

- Color - Black
- Bending radius
- Width
- Series

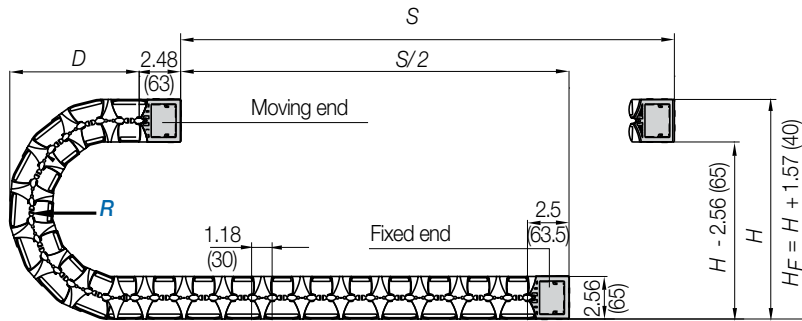

Supplement part number with required radius. Example: E61-52-100--0

Pitch: 1.18 in. (30 mm) per link links/ft (m) = 10 (34)

Part Number	Bi in. (mm)	Ba in. (mm)	Weight lbs/ft (kg/m)
E61-52-040- <input type="text"/> -0	1.57 (40)	2.52 (64)	≈ 1.128 (1.679)
E61-52-050- <input type="text"/> -0	1.97 (50)	2.91 (74)	≈ 1.158 (1.724)
E61-52-052- <input type="text"/> -0	2.05 (52)	2.99 (76)	≈ 1.165 (1.733)
E61-52-062- <input type="text"/> -0	2.44 (62)	3.41 (86.5)	≈ 1.196 (1.780)
E61-52-070- <input type="text"/> -0	2.76 (70)	3.70 (94)	≈ 1.219 (1.814)
E61-52-075- <input type="text"/> -0	2.95 (75)	3.90 (99)	≈ 1.234 (1.836)
E61-52-087- <input type="text"/> -0	3.43 (87)	4.39 (111.5)	≈ 1.271 (1.892)
E61-52-100- <input type="text"/> -0	3.94 (100)	4.88 (124)	≈ 1.309 (1.948)
E61-52-125- <input type="text"/> -0	4.92 (125)	5.87 (149)	≈ 1.384 (2.060)
E61-52-150- <input type="text"/> -0	5.91 (150)	6.85 (174)	≈ 1.460 (2.172)
E61-52-175- <input type="text"/> -0	6.89 (175)	7.83 (199)	≈ 1.534 (2.283)
E61-52-200- <input type="text"/> -0	7.87 (200)	8.81 (224)	≈ 1.609 (2.395)
E61-52-225- <input type="text"/> -0	8.86 (225)	9.80 (249)	≈ 1.685 (2.507)
E61-52-250- <input type="text"/> -0	9.84 (250)	10.79 (274)	≈ 1.760 (2.619)
E61-52-275- <input type="text"/> -0	10.83 (275)	11.77 (299)	≈ 1.835 (2.731)
E61-52-300- <input type="text"/> -0	11.81 (300)	12.76 (324)	≈ 1.910 (2.843)

Choose from the radii below for all of the above sizes
Radius (mm) Example: E61-52-100--0

	075	100	125	150
R	2.95 (075)	3.94 (100)	4.92 (125)	5.91 (150)
H	10.43 (265)	12.40 (315)	14.37 (365)	16.34 (415)
D	6.02 (153)	7.01 (178)	7.99 (203)	8.98 (228)
K	11.81 (300)	14.76 (375)	17.91 (455)	21.06 (535)

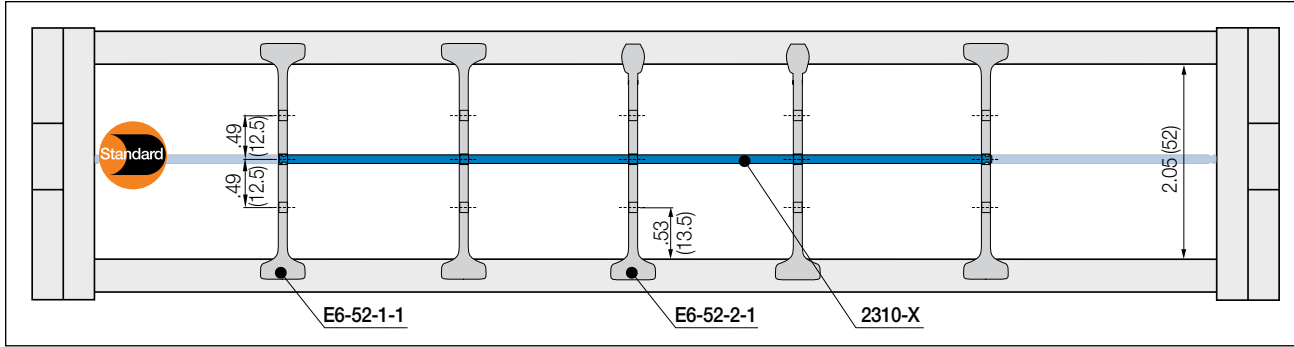

Note: Please maintain a lateral spacing of .51" (13 mm) between the separators and the side links. In the standard configuration separators are assembled every 2nd e-chain® link

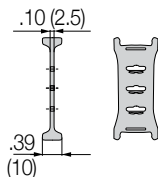

Separator, wide base

Unassembled	Part No. E6-52-1
Assembled	Part No. E6-52-1-1

- **Standard separator E6-52-1 for all applications**

Separator with wide base for maximum locking strength and safe standing in e-chains®.

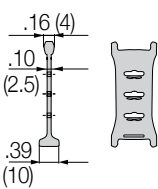

Separator, narrow head

Unassembled	Part No. E6-52-2
Assembled	Part No. E6-52-2-1

- **Separator E6-52-2 For even faster installation**

Firm hold to one side with a wide base, narrow on opposed side for easy cable assembly (slight grip)

Lockable full-width shelves - for the standard interior separation

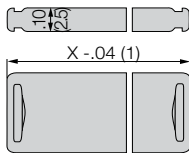

Full width shelf, lockable

Unassembled	Part No. 2300-X
Assembled	Part No. 2310-X

- **Full width shelf, lockable**

Shelf locks safely into separators on both ends, fixed width possible. Separators can be moved freely over the shelf in horizontal direction. Can be arranged at 3 different heights.

Width X in. (mm)	Part No. Unassembled	Part No. Assembled	Width X in. (mm)	Part No. Unassembled	Part No. Assembled	Width X in. (mm)	Part No. Unassembled	Part No. Assembled
0.59 (015)	2300-015	2310-015	2.36 (060)	2300-060	2310-060	3.43 (087)	2300-087	2310-087
0.98 (025)	2300-025	2310-025	2.44 (062)	2300-062	2310-062	3.54 (090)	2300-090	2310-090
1.18 (030)	2300-030	2310-030	2.56 (065)	2300-065	2310-065	3.94 (100)	2300-100	2310-100
1.50 (038)	2300-038	2310-038	2.76 (070)	2300-070	2310-070	4.06 (103)	2300-103	2310-103
1.57 (040)	2300-040	2310-040	2.95 (075)	2300-075	2310-075	4.33 (110)	2300-110	2310-110
1.97 (050)	2300-050	2310-050	3.03 (077)	2300-077	2310-077	4.72 (120)	2300-120	2310-120
2.24 (057)	2300-057	2310-057	3.15 (080)	2300-080	2310-080	4.92 (125)	2300-125	2310-125





matix 100ar/2

12
16.28.01.055

12
16.28.01.055

12
16.28.01.055

CAPE-A.06.0

CAPE-A.06.0



igus[®] System E6

E6 - 6-piece e-chains® - Extremely low- noise, minimum vibrations

The E6 Series offers numerous advantages in addition to long life cycles. It provides extremely quiet, low-vibration operation. It minimizes the polygon effect which can occur during the rolling motion of an e-chain®. The ultra-low noise levels have been confirmed in a recent report by the Rheinland Technical Inspection Agency. Our extensive delivery program offers the right chain size for any application; a wide range of interior separators are also available. The same applies to the mounting brackets. .

Typical industries and applications

- Cleanroom
- Printing machines
- Handling & robot
- Machine Tools
- Measuring machines
- Semiconductor industries
- Medical industries
- Electronic industries
- General machinery



System E6 - Extremely
low noise - TÜV certified



System E6 -
6-piece link-design



LEVEL 1 absorption confirmed by IPA-Fraunhofer-
Institut according to SEMI E78-0998 for the E6 standard
material. Continuously constant conductance value as
there are no pin-bore connection (no air gaps).

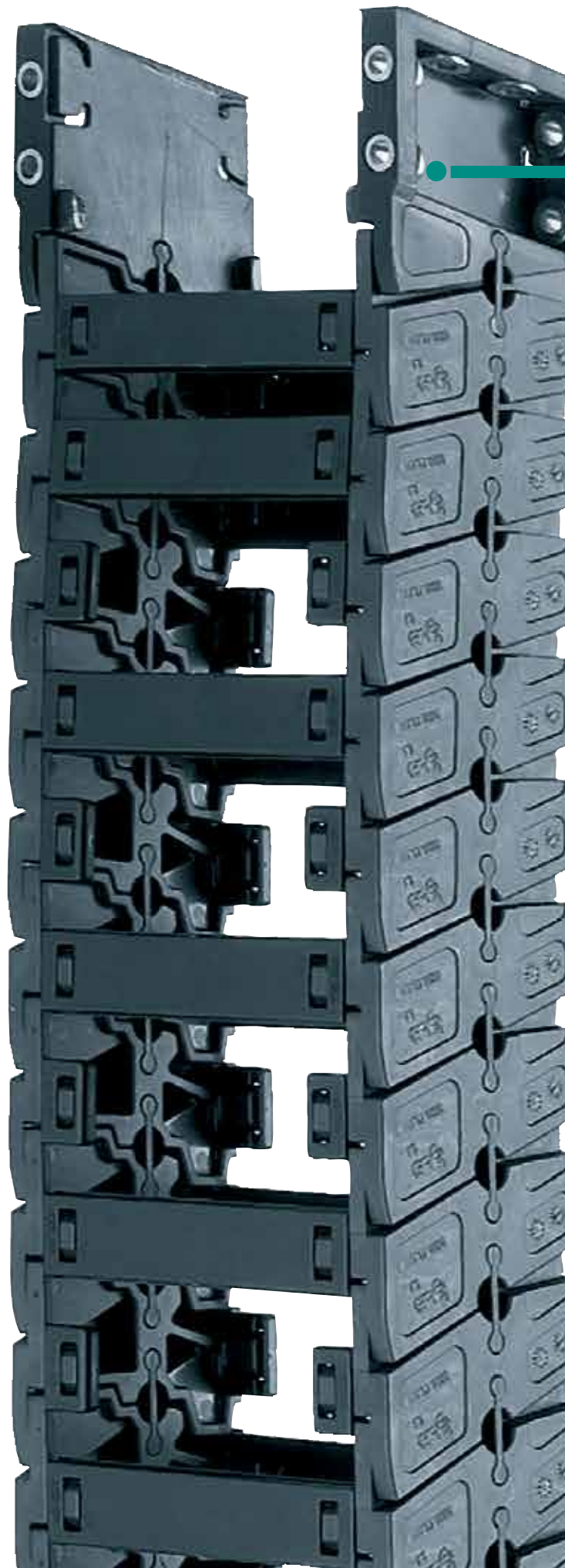



A linear drive provides for highly dynamic feed of PCBs. This system is twice as fast as handling units with a toothed-belt drive; designed to withstand high dynamic loads, the E6 e-chains® ensure a supply of power, coolant and control data with ultra-low noise and vibration

Selected noise tests - External noise corrected measurement values

e-chain® Series	Averaging of the corrected sound pressure levels	Test method
igus® Series E6-29*	≈ 37 dB(A)	unsupported v = 3.28 ft/s (1.0 m/s)
igus® Series E6-52*	≈ 41 dB(A)	unsupported, side mounted v = 1.64 ft/s (0.5 m/s)
igus® Series E6-52	≈ 46 dB(A)	unsupported v = 6.56 ft/s (2.0 m/s)
Chain 1 Third-party product	≈ 77 dB(A)	unsupported v = 6.56 ft/s (2.0 m/s)
Chain 2 Third-party product	≈ 68 dB(A)	unsupported v = 6.56 ft/s (2.0 m/s)
Chain 3 Third-party product	≈ 73 dB(A)	unsupported v = 6.56 ft/s (2.0 m/s)

Source: TÜV Rheinland *Source: igus® laboratory



Noise level ≤ 46 dB(A)

A measurement conducted by the Rhineland Technical Inspection Authority (TÜV Rheinland) in May 2002 indicates a value of ≤ 46 dB(A) at 6.56 ft/s (2 m/s) and with an unsupported length of 4.92 ft (1.5 m) with **Series E6-52-100-100-0**, and all this with at least 10 dB(A) sound pressure level generated by external noise. **We have received an official noise certificate from the Rhineland Technical Inspection Authority (TÜV Rheinland Berlin Brandenburg) and we are happy to provide you with a copy upon request.**

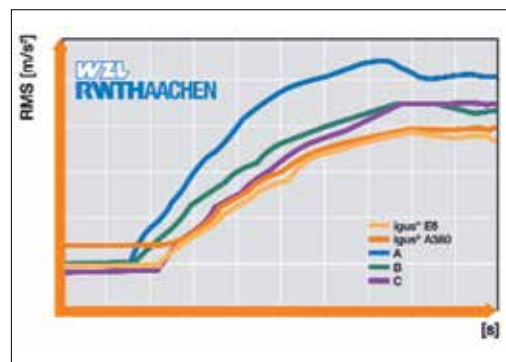

Study of the Laboratory of Machine Tools and Production Engineering (WZL) of the RWTH Aachen on "Vibration tests in energy supply chains".
Result: The E6 energy supply system of the company of igus® GmbH, Cologne, is characterized by extreme low vibration and smooth running.

e-chain system® E6 Selection Guide

Crossbars every 2nd link for almost all applications - Standard



Series	Inner height <i>hi</i> in. (mm)	Inner width <i>Bi</i> in. (mm)	Outer width <i>Ba</i> in. (mm)	Outer height <i>ha</i> in. (mm)	Bending radius <i>R</i> in. (mm)
E6-29	1.14 (29)	1.18-5.51 (30-140)	1.81-5.35 (46-136)	1.38 (35)	2.17-5.91 (55-150)
E6-35	1.38 (35)	1.18-5.51 (30-140)	1.97-6.30 (50-160)	1.65 (42)	2.17-5.91 (55-100)
E6-40	1.57 (40)	1.57-11.81 (40-300)	2.36-12.60 (60-320)	2.12 (54)	2.48-7.87 (63-200)
E6-52	2.05 (52)	1.57-11.81 (40-300)	2.52-12.76 (64-324)	2.56 (65)	2.95-9.84 (75-250)
E6-62	2.44 (62)	1.97-15.75 (50-400)	3.39-17.17 (86-436)	3.31 (84)	4.53-13.78 (115-350)
E6-80L	3.15 (80)	3.53-21.65 (87-550)	4.53-22.76 (115-578)	4.25 (108)	5.91-11.81 (150-300)
E6-80	3.15 (80)	1.97-23.62 (50-600)	3.94-25.59 (100-650)	4.25 (108)	5.91-17.72 (150-450)

E-Tubes fully enclosed, for complete cable protection



Series	Inner height <i>hi</i> in. (mm)	Inner width <i>Bi</i> in. (mm)	Outer width <i>Ba</i> in. (mm)	Outer height <i>ha</i> in. (mm)	Bending radius <i>R</i> in. (mm)
R6-29	1.10 (28)	1.18-4.72 (30-120)	1.81-5.35 (46-136)	1.38 (35)	2.17-5.91 (55-150)
R6-40	1.57 (40)	2.44-2.95 (62-75)	3.23-3.74 (82-95)	2.12 (54)	2.48-7.87 (63-200)
R6-52	2.05 (52)	1.97-6.89 (50-175)	2.91-7.83 (74-199)	2.56 (65)	2.95-9.84 (75-250)

Cleanroom qualification of E6 e-chains®



In many applications where cumbersome special solutions are used, a simple standard e-chain® can be used instead. A comprehensive test program was devised and performed for both gliding use and unsupported use. For many applications, the e-chains® in special materials are practically abrasion-free. Detailed tests results are available upon request. IPA tests confirm that standard igus® e-chains® meet cleanroom requirements. "Tested and certified as very good!" In cleanrooms a very high resistance to wear of moving parts is required. Therefore, e-chains® must be very resistant to wear. In order to meet the standard requirements for such a sensitive environment.

By eliminating the pin/bore connection, the unsupported E6 has very low abrasion and is suitable for cleanrooms



IPA classification - Report IG0704-400:

- Special material "cleanroom" - **Class 1 according to standard DIN EN ISO 14644-1** - Note: None of the classes corresponding to the DIN EN ISO 14644-1 Class 1 is included in the US standard at $v = (0.5 \text{ m/s})$, $a = (1.0 \text{ m/s}^2)$ - Series E6-29-060-150-0-CR
- Standard material - **Class 3 according to standard DIN EN ISO 14644-1** (according to US Fed. Stand. 209E, Class 1) at $v = (0.5 \text{ m/s})$, $a = (1.0 \text{ m/s}^2)$ Series E6-29-060-150-0 and $v = 1 \text{ m/s}$, $a = 2 \text{ m/s}^2$ Series E6-29-050-055-0 with inserted cables CF34-15-04, CF9-05-12, CF11-02-01-02-PBA-LC-D



Available from stock. Orders ship as early as today.*

*On average 90% of orders ship the same day..

e-chain system® E6 Assembly Instructions

System E6 e-chains® - Assembling



1 Position side links ...



2 ... gently twist and snap in



3 Gently insert connector by using a hammer



4 Position crossbars.
Push down and snap in

E-Tubes - Assembling Lids



1 Insert lid ...



2 ... push down and snap in



1 Lever with screwdriver ...



2 ... and remove lids by hand

System E6 e-chains® - Separating



1 Lever crossbars with screwdriver



2 Tap gently to remove connectors



3 Twist and ...



4 ... separate side links

Price Index



Series E6-29

Special Features / Options



Extremely low noise
Test results upon request



IPA Certificate: Class 1, according to standard DIN EN ISO 14644-1 for the E6 system (Series E6-29-060-150-0-CR, (v = 1.64 ft/s, a = 3.28 ft/s²))



LEVEL 1 absorption confirmed by IPA-Fraunhofer-Institute according to SEMI E78-0998 for the E6 standard material

Assembly Tips

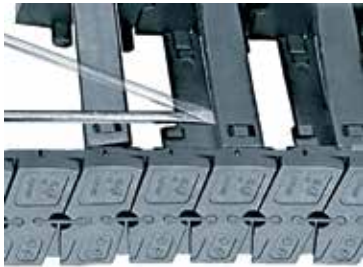

To close, push and click shut

Other Installation Methods

Vertical, hanging ≤ 98.4 ft (30 m)

Vertical, standing ≤ 6.56 ft (2 m)

Side-mounted, un_supp. =

possible to a limited extent

Unsupported length of upper run upon request

Usage Guidelines



- If a low-noise version is required
- For very high speeds and/or accelerations
- If large stresses and thrust forces are present
- For small bending radii
- If less vibration is required
- Minimal abrasion, suitable for cleanrooms



- For side-mounted applications
 - Series 2400/2500 E2/000
- For RBR (reverse bending radii)
 - Series 2400/2500 E2/000
- For high additional loads
 - Series 2400/2500 E2/000
- For very dirty environments
 - Series R6-29

Features & Benefits

- 1 No pin and bore connection
- 2 Small pitch for low-noise, smooth operation
- 3 Very large gliding surfaces
- 4 Can be shortened or lengthened due to modular design
- 5 Increased inner height
- 6 Interior stop dog
- 7 KMA mounting brackets with attachment points on all sides (strain relief with separate tiwrap plates possible)

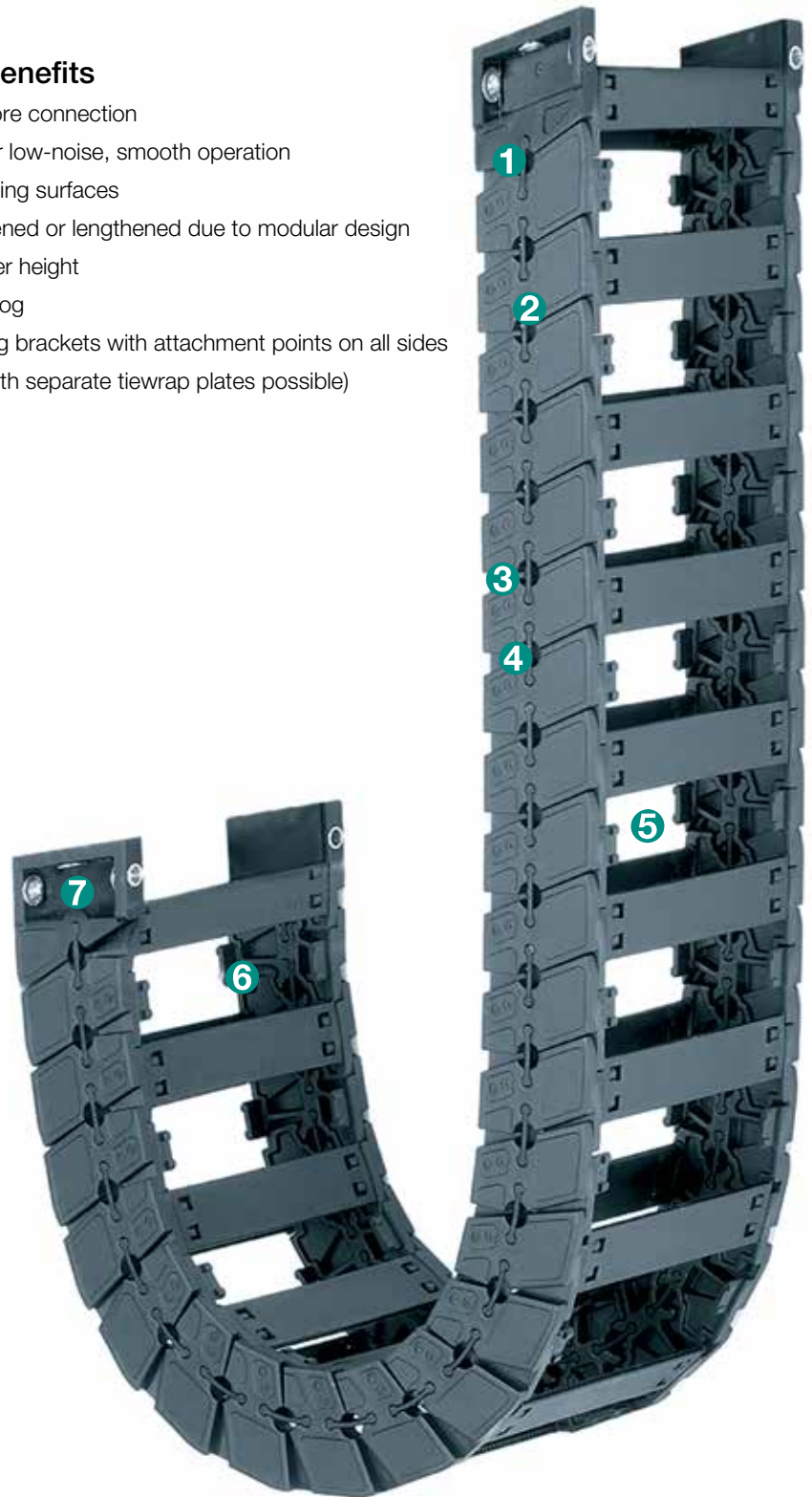

Order Example: Complete e-chain®

Please indicate chain length or number of links. Example:

6.56 ft (2 m) **E6-29-100-075-0**



e-chain®

With 2 separators **E6-29-11** assembled every 2nd link



Interior Separation

1 Set **E6-290-100-12**



Mounting Bracket

e-chain system® E6

Series E6-29

Installation Dimensions



E6-29

Short travel, unsupported length

- FL_B = unsupported with permitted sag
 - FL_G = unsupported with straight upper run
- Further information ► Design, Chapter 1

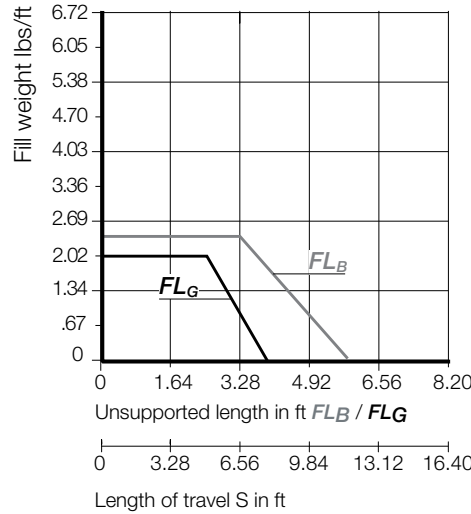
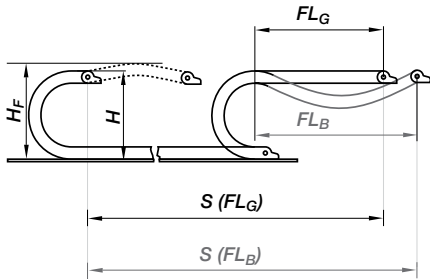

Short Travels - Unsupported



Unsupported e-chains® feature positive camber over short travels. This must be accounted for when specifying the clearance height. Please refer to **Installation dimensions** for further details.

Legend

- S = Length of travel
- R = Bending radius
- H = Nominal clearance height
- D = Overlength e-chain® radius in final position
- K = $\pi \cdot R$ + safety buffer
- H_F = Required clearance height

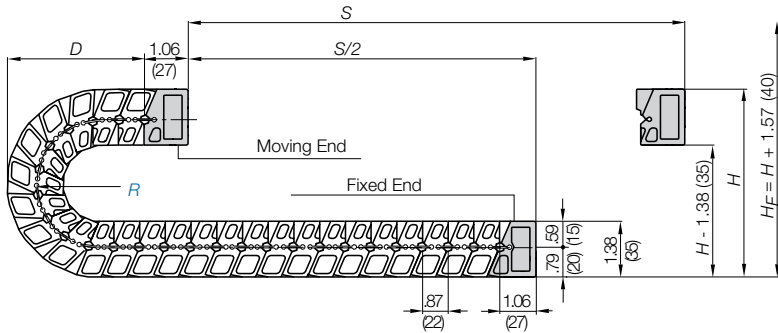

Pitch per link = .87" (22 mm)
 Links per ft (m) = 13.79 (46)
 For center mount applications:
 Chain length = $S/2 + K$

The required clearance height: $H_F = H + 1.57$ in. (40 mm) (with 1.34 lbs/ft (2.0 kg/m) fill weight). Please consult igus® if space is particularly restricted.

R	2.17 (055)	2.95 (075)	3.94 (100)	5.91 (150)
H	7.09 (180)	8.66 (220)	10.63 (270)	14.57 (370)
D	4.25 (108)	5.04 (128)	6.02 (153)	7.99 (203)
K	8.66 (220)	11.02 (280)	14.17 (360)	20.47 (520)

Speed / acceleration FL_G	max. 65.6 ft/s (20 m/s) / max. 656 ft/s ² (200 m/s ²)
Speed / acceleration FL_B	max. 9.84 ft/s (3 m/s) / max. 19.69 ft/s ² (6 m/s ²)
Gliding speed / acceleration (maximum)	upon request
Permitted temperature	-40°F (-40°C) up to +158°F (+70° C)
Flammability Class	VDE 0304 IIC UL94 HB

Technical Data



Details of material properties

► Design, Chapter 1

1.14

PDF: igus.com/e-chain-pdfs
 Product information: igus.com/e-chains



Series E6-29 - e-chain® with crossbars every link

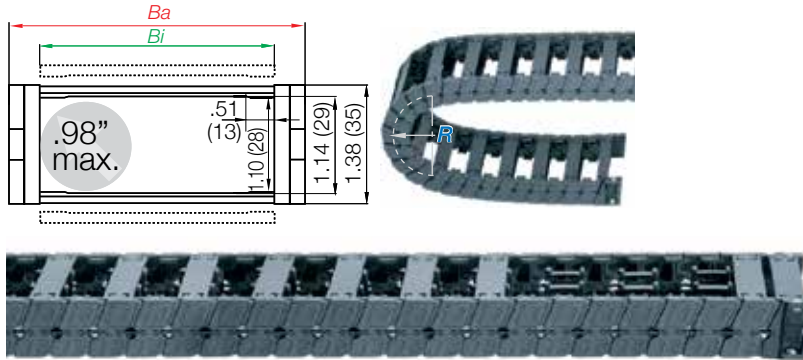

Part Number Structure

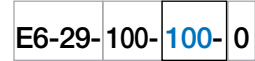

- Color - Black
- Bending radius
- Width
- Series

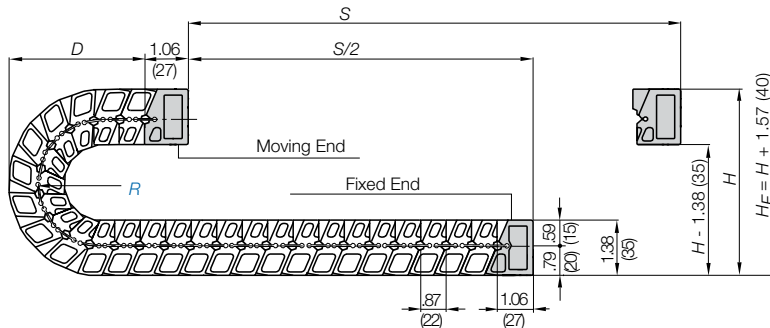

Supplement part number with required radius. Example: E6-29-100--0
Pitch: .87 in. (22 mm) per link links/ft (m) = 13.79 (46)

Part Number	Bi in. (mm)	Ba in. (mm)	Weight lbs/ft (kg/m)
E6-29-030- <input type="text"/> -0	1.18 (30)	1.81 (46)	≈ 0.49 (0.73)
E6-29-040- <input type="text"/> -0	1.57 (40)	2.20 (56)	≈ 0.50 (0.75)
E6-29-050- <input type="text"/> -0	1.97 (50)	2.60 (66)	≈ 0.52 (0.78)
E6-29-060- <input type="text"/> -0	2.36 (60)	2.99 (76)	≈ 0.54 (0.80)
E6-29-070- <input type="text"/> -0	2.76 (70)	3.39 (86)	≈ 0.56 (0.83)
E6-29-080- <input type="text"/> -0	3.15 (80)	3.78 (96)	≈ 0.57 (0.85)
E6-29-090- <input type="text"/> -0	3.54 (90)	4.17 (106)	≈ 0.59 (0.88)
E6-29-100- <input type="text"/> -0	3.94 (100)	4.57 (116)	≈ 0.60 (0.90)
E6-29-110- <input type="text"/> -0	4.33 (110)	4.96 (126)	≈ 0.62 (0.93)
E6-29-120- <input type="text"/> -0	4.72 (120)	5.35 (136)	≈ 0.64 (0.95)
E6-29-140- <input type="text"/> -0	5.51 (140)	6.14 (156)	≈ 0.67 (1.00)

Choose from the radii below for all of the above sizes
Radius (mm) Example: E6-29-100--0

	055	075	100	150
R	2.17 (055)	2.95 (075)	3.94 (100)	5.91 (150)
H	7.09 (180)	8.66 (220)	10.63 (270)	14.57 (370)
D	4.25 (108)	5.04 (128)	6.02 (153)	7.99 (203)
K	8.66 (220)	11.02 (280)	14.17 (360)	20.47 (520)

e-chain® as separate parts, links and side plates

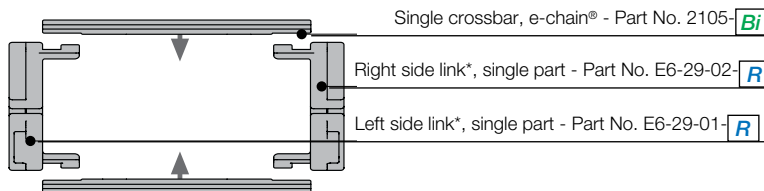

Polymer spring as single part -
Part No. E6-29-140

*View from the fixed point of the e-chain®/E-Tube

e-chain system® E6
Series E6-29
Interior Separation - New Generation



E6-29

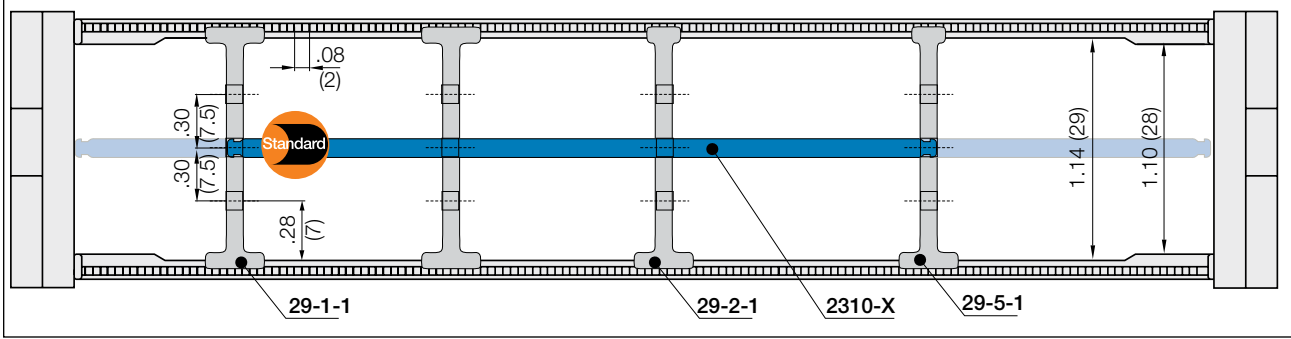

 Note: Please maintain a lateral spacing of .51" (13 mm) between the separators and the side links. In the standard configuration separators are assembled every 2nd e-chain® link

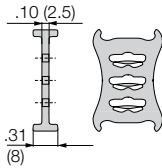

Separator, wide base

Unassembled	Part No. 29-1
Assembled	Part No. 29-1-1

- **Standard separator 29-1 for all applications**

Separator with wide base for maximum locking strength and safe standing in e-chains®.

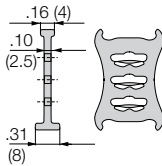

Separator, narrow head

Unassembled	Part No. 29-2
Assembled	Part No. 29-2-1

- **Separator 29-2**

For even faster installation

is used when vertical and horizontal separation is required. Due to its slot, it allows basic vertical/horizontal shelving arrangements.

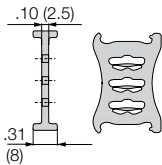

Notch separator, for notch crossbar

Unassembled	Part No. 29-5
Assembled	Part No. 29-5-1

- **Separator 29-5**

Locks safely in .08 (2 mm) increments

For exact positioning in e-chains®. Recommended for side-mounted applications.

Lockable full-width shelves - for the standard interior separation

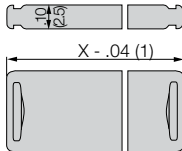

Full width shelf, lockable

Unassembled	Part No. 2300-X
Assembled	Part No. 2310-X

- **Full width shelf, lockable**

is used when vertical and horizontal separation is required. Due to its slot, it allows basic vertical/horizontal shelving arrangements.

Width X in. (mm)	Part No. Unassembled	Part No. Assembled	Width X in. (mm)	Part No. Unassembled	Part No. Assembled	Width X in. (mm)	Part No. Unassembled	Part No. Assembled
0.59 (015)	2300-15	2310-15	2.36 (060)	2300-60	2310-60	3.43 (087)	2300-87	2310-87
0.98 (025)	2300-25	2310-25	2.44 (062)	2300-62	2310-62	3.54 (090)	2300-90	2310-90
1.18 (030)	2300-30	2310-30	2.56 (065)	2300-65	2310-65	3.94 (100)	2300-100	2310-100
1.50 (038)	2300-38	2310-38	2.76 (070)	2300-70	2310-70	4.06 (103)	2300-103	2310-103
1.57 (040)	2300-40	2310-40	2.95 (075)	2300-75	2310-75	4.33 (110)	2300-110	2310-110
1.97 (050)	2300-50	2310-50	3.03 (077)	2300-77	2310-77	4.72 (120)	2300-120	2310-120
2.24 (057)	2300-57	2310-57	3.15 (080)	2300-80	2310-80	4.92 (125)	2300-125	2310-125

Separator with integrated strain relief

Strain relief separator Part No. E6-29-02-Z can be integrated into the mounting bracket and can be placed there at any point of the e-chain®. It combines strain relief and interior separation, it can be installed on the first or last e-chain® link and is easy to assemble without any screws.

For more information ► Chapter 10, Strain Relief



PDF: igus.com/e-chain-pdfs
Product information: igus.com/e-chains



Vertical separators

Vertical separators are used if a vertical subdivision of the e-chain® interior is re-quired. By standard, vertical separators are assembled every other e-chain® link.

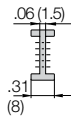
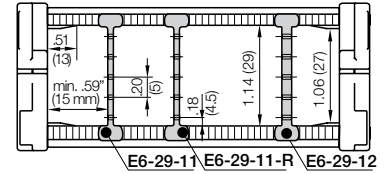

Vertical Separator

Unassembled	E6-29-01
Assembled	E6-29-11

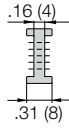

Vertical Separator

Unassembled	E6-29-02
Assembled	E6-29-12

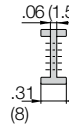

Vertical Separator

Unassembled	E6-29-01R
Assembled	E6-29-11R

• **Slotted vertical separator E6-29-01**

This separator is used for general subdivision of e-chains®. Can be used in combination with full-width shelf 111-X

• **Vertical separator E6-29-02**

For use with side plate E6-29-13, full-width shelf 221-X and shelf 2210-X

• **Locking separator E6-29-01R**

Can be locked onto crossbars in .08" (2mm) increments. For side-mounted applications use with full-width shelf 111-X

Full-width shelf

For applications involving many thin cables with similar or identical diameters.

Full-width shelf **111-X** can be used with vertical separator **E6-29-11** and locking separator **E6-29-11-R**.

Full-width shelf **221-X** can be used with vertical separator **E6-29-12**, side plate **E6-29-13**

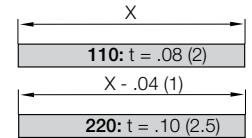
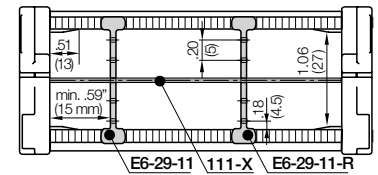

Shelves 110-X/220-XX

Shelves can be inserted at 5 different heights in .20" (5mm) increments

Width X in. (mm)	Part No.		Part No.		Width X in. (mm)	Part No.		Part No.	
	Unassembled	Assembled	Unassembled	Assembled		Unassembled	Assembled	Unassembled	Assembled
1.18 (030)	110-30	220-30	111-30	221-30	3.15 (080)	110-80	220-80	111-80	221-80
1.57 (040)	110-40	220-40	111-40	221-40	3.54 (090)	110-90	220-90	111-90	221-90
1.97 (050)	110-50	220-50	111-50	221-50	3.94 (100)	110-100	220-100	111-100	221-100
2.36 (060)	110-60	220-60	111-60	221-60	4.33 (110)	110-110	220-110	111-110	221-110
2.76 (070)	110-70	220-70	111-70	221-70	4.72 (120)	110-120	220-120	111-120	221-120

Shelves

These components form the basic pattern of a shelf system.

Shelves of various widths can be arranged at 5 different heights in .20" (5mm) increments

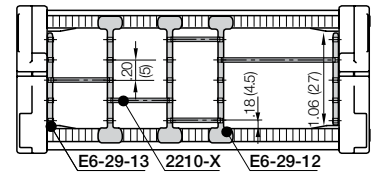

Shelves 2200-XX

Shelf **2210-X** can be used with vertical separator **E6-29-12** and side plate **E6-29-13**

Width X in. (mm)	Part No.	Part No.	Width X in. (mm)	Part No.	Part No.
	Unassembled	Assembled		Unassembled	Assembled
.71 (18)	2200-18	2210-18	1.89 (48)	2200-48	2210-48
.91 (23)	2200-23	2210-23	2.28 (58)	2200-58	2210-58
1.10 (28)	2200-28	2210-28	2.68 (68)	2200-68	2210-68
1.30 (33)	2200-33	2210-33	2.87 (73)	2200-73	2210-73
1.50 (38)	2200-38	2210-38	3.46 (88)	2200-88	2210-88
1.69 (43)	2200-43	2210-43	3.90 (99)	2200-99	2210-99

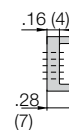

Slotted Separator

Unassembled	E6-29-03
Assembled	E6-29-13

- **Side plate, slotted**
 This separator is used for general subdivision of e-chains®.

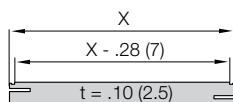

KMA - Pivoting



- Bolted connection outside of the chain cross-section
- Recommended for unsupported applications (for gliding applications please contact igus®)
- Confined installation conditions
- Attachment capability on all sides

Moving end
E6-290...2

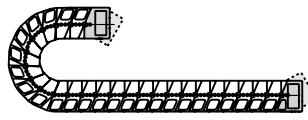

Fixed end
E6-290...1

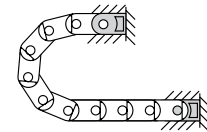

Possible installation configurations -

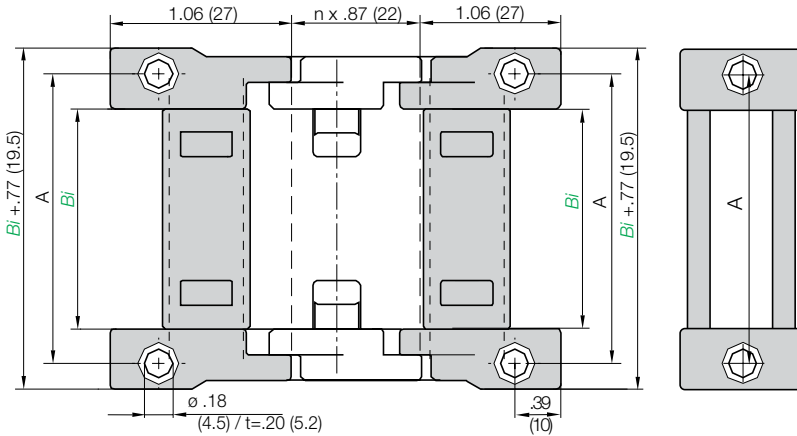

Part Number Structure

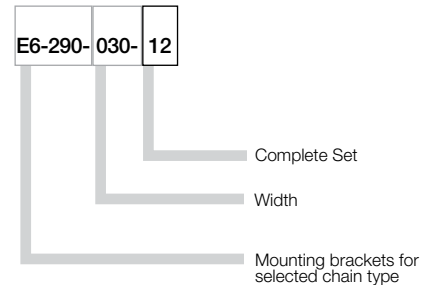

Full set, for both ends:

E6-290-030-12 Full set, both fixed and moving end

Single-part order:

E6-290-030-1 Mounting bracket fixed end

E6-290-030-2 Mounting bracket moving end

For Series	Part No. Full Set	Dimension A in. (mm)	For Series	Part No. Full Set	Dimension A in. (mm)
E6-29-030	E6-290-030-12	1.57 (40)	E6-29-090	E6-290-090-12	3.94 (100)
E6-29-040	E6-290-040-12	1.97 (50)	E6-29-100	E6-290-100-12	4.33 (110)
E6-29-050	E6-290-050-12	2.36 (60)	E6-29-110	E6-290-110-12	4.72 (120)
E6-29-060	E6-290-060-12	2.76 (70)	E6-29-120	E6-290-120-12	5.12 (130)
E6-29-070	E6-290-070-12	3.15 (80)	E6-29-140	E6-290-140-12	5.91 (150)
E6-29-080	E6-290-080-12	3.54 (90)			

Tiewrap Plates



Tiewrap plates as an individual part

Tiewrap Plates	n Number of Teeth	Dimension C	Dimension B
2020-ZB	3	1.18 (30)	.59 (15)
2030-ZB	4	1.57 (40)	.79 (20)
2040-ZB	5	1.97 (50)	1.18 (30)
2050-ZB	6	2.36 (60)	1.57 (40)
2070-ZB	8	3.15 (80)	2.36 (60)
2090-ZB	9	3.54 (90)	2.76 (70)
2100-ZB	10	3.94 (100)	3.15 (80)
2120-ZB	12	4.72 (120)	3.94 (100)

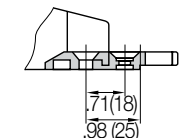

Shown assembled

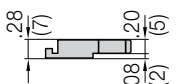

Single tiewrap plate

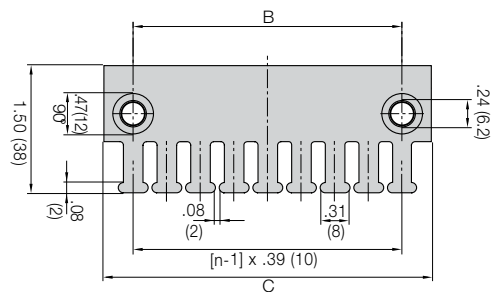

If used with KMA brackets with profile rail please add "KMA" to the end of the part number.

Example: 2020-ZBKMA

- Other strain relief elements
- Strain Relief, Chapter 10



Price Index



Series R6-29

Special Features / Options



Extremely low noise
Test results upon request



IPA Certificate: Class 1, according to standard DIN EN ISO 14644-1 for the E6 system (Series E6-29-060-150-0-CR, (v = 1.64 ft/s, a = 3.28 ft/s²))



LEVEL 1 absorption confirmed by IPA-Fraunhofer-Institute according to SEMI E78-0998 for the E6 standard material

Assembly Tips



Lever and remove lids

Other Installation Methods

Vertical, hanging ≤ 98.4 ft (30 m)

Vertical, standing ≤ 6.56 ft (2 m)

Side-mounted, unsupp. = possible to a limited extent

Unsupported length of upper run upon request

Usage Guidelines



- If a low-noise version is required
- For very high speeds and/or accelerations
- Protection against dirt and chips
- For small bending radii
- If less vibration is required
- Minimal abrasion, suitable for cleanrooms



- For side-mounted applications
 - **Series 2480 E2 Tubes**
- For RBR (reverse bending radii)
 - **Series 2480 E2 Tubes**
- For high additional loads
 - **Series 2480 E2 Tubes**

Features & Benefits

- 1 Fully enclosed E-Tube
- 2 No pin and bore connection
- 3 Interior stop dog
- 4 Very large gliding surfaces
- 5 KMA mounting brackets with attachment points on all sides (strain relief with separate tie-wrap plates possible)
- 6 Can be shortened or lengthened due to modular design
- 7 Small pitch for low-noise, smooth operation



Order Example: Complete e-chain®

Please indicate chain length or number of links. Example:

6.56 ft (2 m) **R6-29-080-100-0**

E-Tube

With 2 separators **R6-29-11** assembled every 2nd link

Interior Separation

1 Set **R6-290-080-12**

Mounting Bracket

e-chain system® E6

Series R6-29

Installation Dimensions



R6-29

Short travel, unsupported length

- FL_B = unsupported with permitted sag
 - FL_G = unsupported with straight upper run
- Further information ► Design, Chapter 1

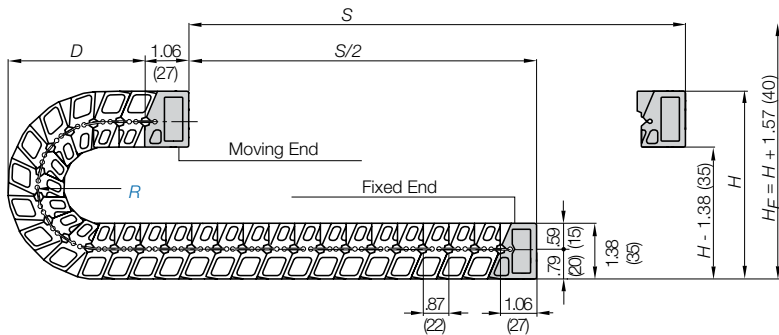
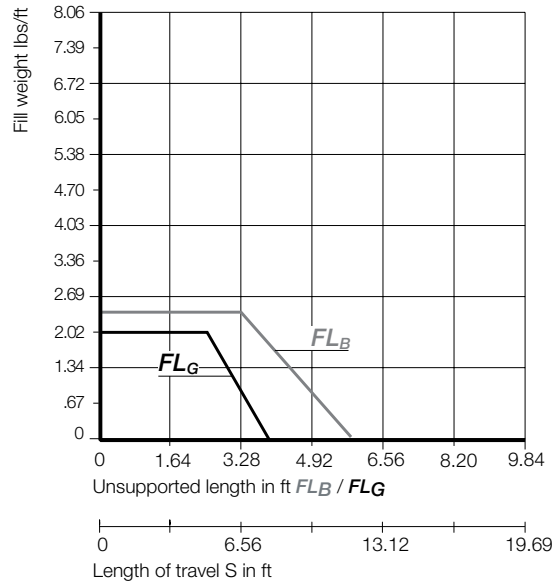
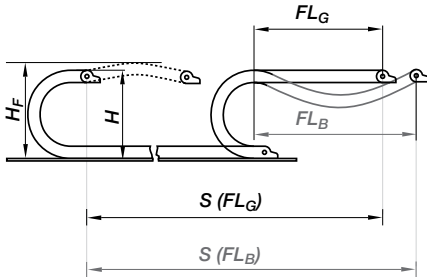

Pitch per link = .87" (22 mm)
 Links per ft (m) = 13.79 (46)
 For center mount applications:
 Chain length = $\frac{S}{2} + K$

The required clearance height: $H_F = H + 1.57$ in. (40 mm) (with 1.34 lbs/ft (2.0 kg/m) fill weight). Please consult igus® if space is particularly restricted.

R	2.17 (055)	2.95 (075)	3.94 (100)	5.91 (150)
H	7.09 (180)	8.66 (220)	10.63 (270)	14.57 (370)
D	4.25 (108)	5.04 (128)	6.02 (153)	7.99 (203)
K	8.66 (220)	11.02 (280)	14.17 (360)	20.47 (520)

Speed / acceleration FL_G	max. 65.6 ft/s (20 m/s) / max. 656 ft/s ² (200 m/s ²)
Speed / acceleration FL_B	max. 9.84 ft/s (3 m/s) / max. 19.69 ft/s ² (6 m/s ²)
Gliding speed / acceleration (maximum)	upon request
Permitted temperature	-40°F (-40°C) up to +158°F (+70° C)
Flammability Class	VDE 0304 IIC UL94 HB

Short Travels - Unsupported



Unsupported e-chains® feature positive camber over short travels. This must be accounted for when specifying the clearance height. Please refer to **Installation dimensions** for further details.

Legend

- S = Length of travel
- R = Bending radius
- H = Nominal clearance height
- D = Overlength e-chain® radius in final position
- $K = \pi \cdot R + \text{safety buffer}$
- H_F = Required clearance height

1.10

PDF: igus.com/e-chain-pdfs
 Product information: igus.com/e-chains



Technical Data



Details of material properties

► Design, Chapter 1

7.78

Series R6-29 - E-Tube, removable lids along the inner and outer radius

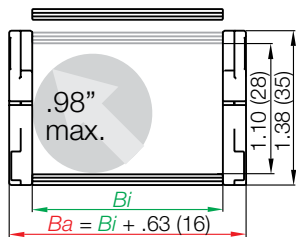

Part Number Structure

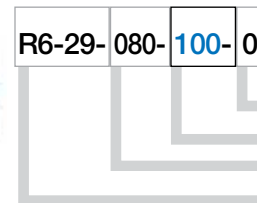

Color - Black
Bending radius
Width
Series

Supplement part number with required radius.

Example: R6-29-080-100-0

Pitch: .87 in. (22 mm) per link links/ft (m) = 13.79 (46)

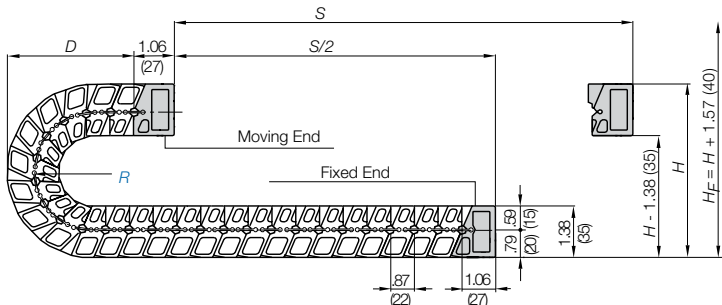

Part Number	Bi in. (mm)	Ba in. (mm)	Weight lbs/ft (kg/m)
R6-29-030- -0	1.18 (30)	1.81 (46)	≈ 0.54 (0.80)
R6-29-040- -0	1.57 (40)	2.20 (56)	≈ 0.57 (0.85)
R6-29-050- -0	1.97 (50)	2.60 (66)	≈ 0.60 (0.89)
R6-29-060- -0	2.36 (60)	2.99 (76)	≈ 0.63 (0.94)
R6-29-080- -0	3.15 (80)	3.78 (96)	≈ 0.69 (1.03)
R6-29-110- -0	4.33 (110)	4.96 (126)	≈ 0.79 (1.18)
R6-29-120- -0	4.72 (120)	5.35 (136)	≈ 0.82 (1.22)

Choose from the radii below for all of the above sizes
Radius (mm) Example: R6-29-080-100-0

	055	075	100	150
R	2.17 (055)	2.95 (075)	3.94 (100)	5.91 (150)
H	7.09 (180)	8.66 (220)	10.63 (270)	14.57 (370)
D	4.25 (108)	5.04 (128)	6.02 (153)	7.99 (203)
K	8.66 (220)	11.02 (280)	14.17 (360)	20.47 (520)

Vertical separators

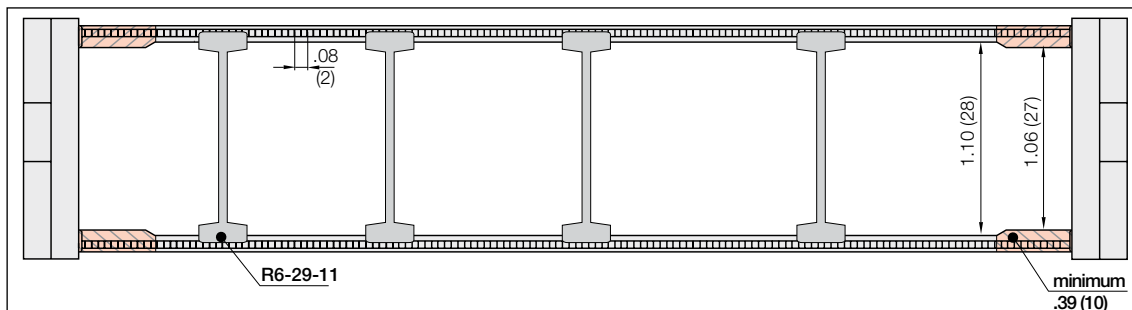

Note: Please maintain a lateral spacing of .39" (10 mm) between the separators and the side links. In the standard configuration separators are assembled every 2nd e-chain® link

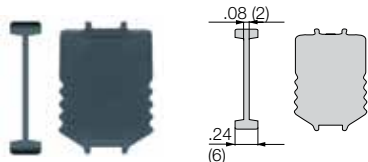

Separator for E-Tubes

Unassembled Part No. R6-29-01

Assembled Part No. R6-29-11

Vertical separator R6-29-01

This separator is used for general subdivision of E-Tubes. Separator snaps onto either the bottom of the carrier or the lid. Stays attached to that side. Opposite side can be removed.

e-chain system® E6

Series R6-29

Mounting Bracket - KMA / Strain Relief



R6-29



Option 1: KMA - Pivoting

- Bolted connection outside of the chain cross-section
- Recommended for unsupported applications (for gliding applications please contact igus®)
- Confined installation conditions
- Attachment capability on all sides

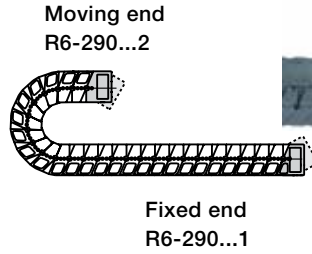

Possible installation configurations -

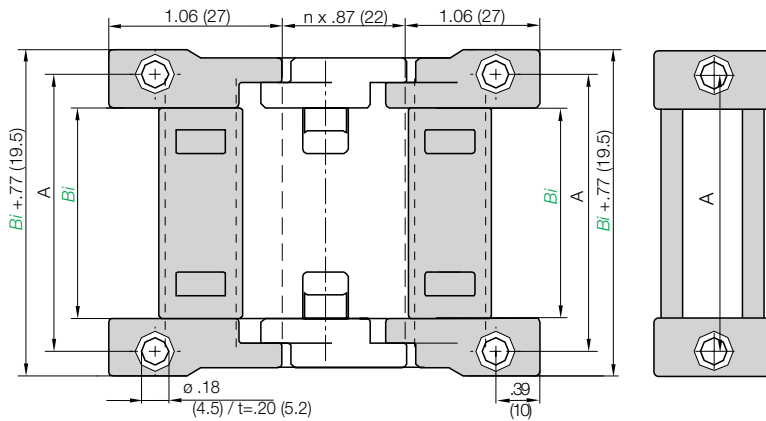

Part Number Structure

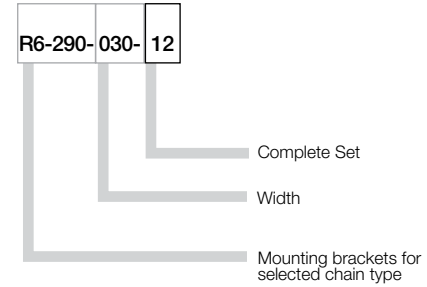

For Series	Part No. Full Set	Dimension A in. (mm)
R6-290-030	R6-290-030-12	1.57 (40)
R6-290-040	R6-290-040-12	1.97 (50)
R6-290-050	R6-290-050-12	2.36 (60)
R6-290-060	R6-290-060-12	2.76 (70)
R6-290-080	R6-290-080-12	3.54 (90)
R6-290-110	R6-290-110-12	4.72 (120)
R6-290-120	R6-290-120-12	5.12 (130)

Full set, for both ends:

R6-290-030-12 Full set, both fixed and moving end

Single-part order:

R6-290-025-1 Mounting bracket fixed end

R6-290-025-2 Mounting bracket moving end

Tiewrap Plates

Option 1: Tiewrap plates as an individual part

Available as an individual component, can be fixed onto a mounting bracket with the use of a profile rail.

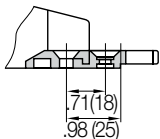

Shown assembled

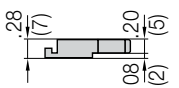

Single tiewrap plate

Tiewrap Plates	n Number of Teeth	Dimension C	Dimension B
2020-ZB	3	1.18 (30)	.59 (15)
2030-ZB	4	1.57 (40)	.79 (20)
2040-ZB	5	1.97 (50)	1.18 (30)
2050-ZB	6	2.36 (60)	1.57 (40)
2070-ZB	8	3.15 (80)	2.36 (60)
2090-ZB	9	3.54 (90)	2.76 (70)
2100-ZB	10	3.94 (100)	3.15 (80)
2120-ZB	12	4.72 (120)	3.94 (100)

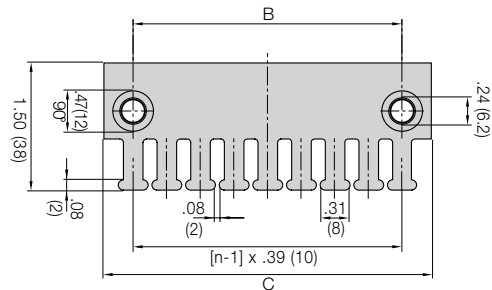

If used with KMA brackets with profile rail please add "KMA" to the end of the part number.

Example: 2020-ZBKMA

- Other strain relief elements
- Strain Relief, Chapter 10

PDF: igus.com/e-chain-pdfs
Product information: igus.com/e-chains



Price Index

Series E6-35
Special Features / Options

Extremely low noise
 Test results upon request

IPA Certificate: Class 1, according to standard DIN EN ISO 14644-1 for the E6 system (Series E6-29-060-150-0-CR, (v = 1.64 ft/s, a = 3.28 ft/s²))

LEVEL 1 absorption confirmed by IPA-Fraunhofer-Institute according to SEMI E78-0998 for the E6 standard material

Assembly Tips

To close, push and click shut

Other Installation Methods

Vertical, hanging ≤ 98.4 ft (30 m)

Vertical, standing ≤ 6.56 ft (2 m)

Side-mounted, un_supp. = possible to a limited extent

Unsupported length of upper run upon request

Usage Guidelines



- If a low-noise version is required
- For very high speeds and/or accelerations
- If large stresses and thrust forces are present
- For small bending radii
- If less vibration is required
- Minimal abrasion, suitable for cleanrooms



- If a fully enclosed tube is required
 ➤ **Series 2680 E2/000**
- For side mounted applications
 ➤ **Series E4-32 E4-1**
- For RBR (Reverse Bending Radius)
 ➤ **Series E4-32 E4-1**
- For high additional loads
 ➤ **Series E4-32 E4-1**
- For dirty environments
 ➤ **Series E4-32 E4-1**

Features & Benefits

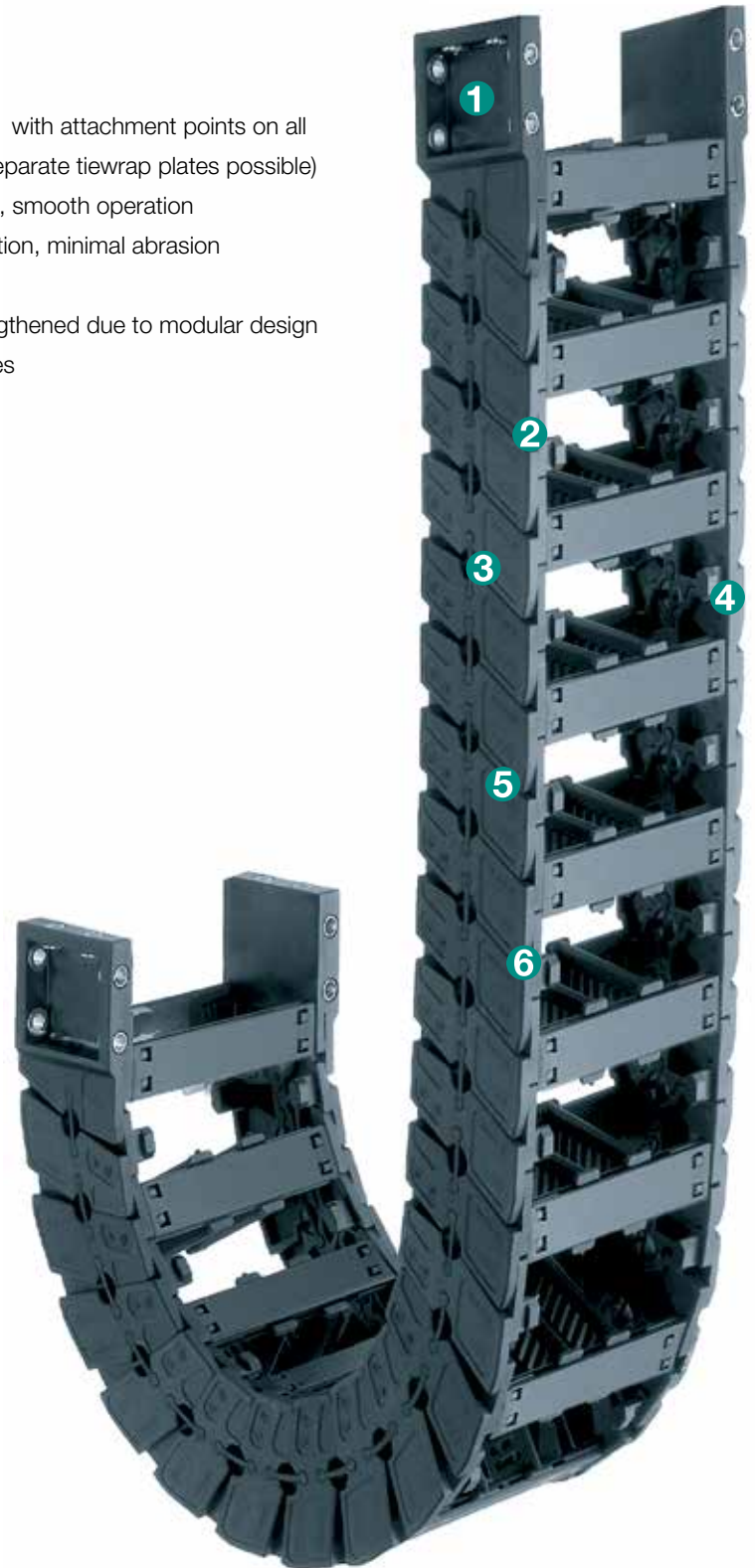
- 1 KMA mounting brackets with attachment points on all sides (strain relief with separate tie-wrap plates possible)
- 2 Small pitch for low-noise, smooth operation
- 3 No pin and bore connection, minimal abrasion
- 4 Interior stop dog
- 5 Can be shortened or lengthened due to modular design
- 6 Very large gliding surfaces

Order Example: Complete e-chain®

Please indicate chain length or number of links. Example:

 6.56 ft (2 m) **E6-35-100-055-0**

e-chain®

 With 2 separators **E6-35-11** assembled every 2nd link

Interior Separation

 1 Set **E6-350-100-12**

Mounting Bracket

e-chain system® E6

Series E6-35

Installation Dimensions



E6-35

Short travel, unsupported length

- FL_B = unsupported with permitted sag
 - FL_G = unsupported with straight upper run
- Further information ► Design, Chapter 1

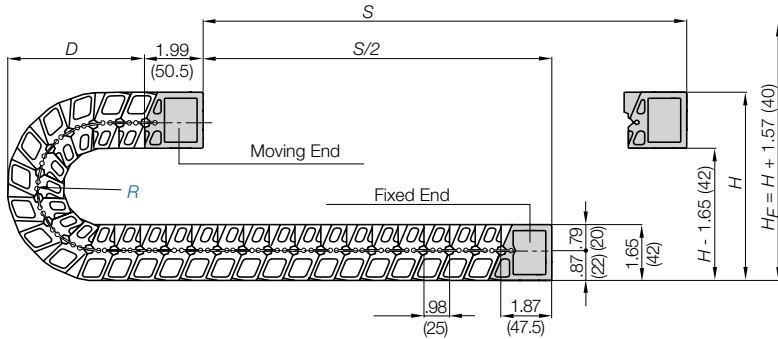
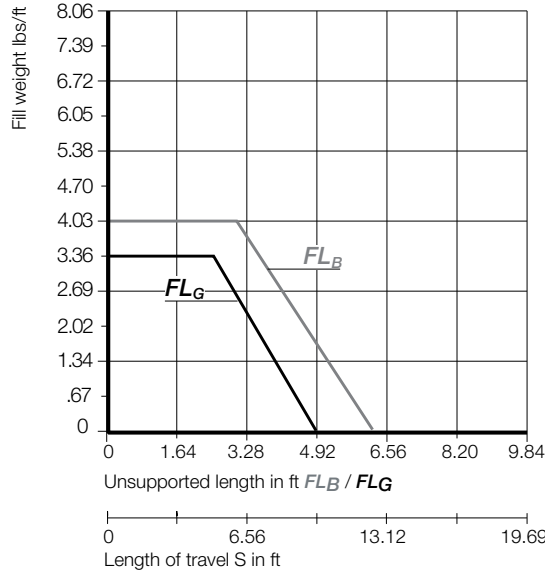
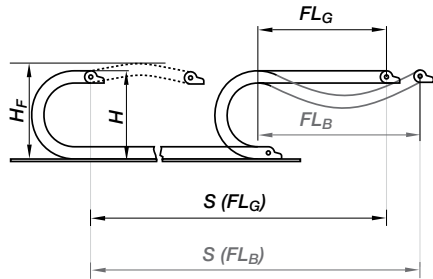

Pitch per link = .98" (25 mm)
 Links per ft (m) = 12.19 (40)
 For center mount applications:
 Chain length = $\frac{S}{2} + K$

The required clearance height: $H_f = H + 1.57$ in. (40 mm) (with 1.34 lbs/ft (2.0 kg/m) fill weight). Please consult igus® if space is particularly restricted.

R	2.17 (055)	2.95 (075)	3.94 (100)	5.91 (150)
H	7.44 (189)	9.01 (229)	10.98 (279)	14.92 (379)
D	4.53 (115)	5.31 (135)	6.30 (160)	8.27 (210)
K	8.86 (225)	11.42 (290)	14.37 (365)	20.67 (525)

Short Travels - Unsupported

1.38



Unsupported e-chains® feature positive camber over short travels. This must be accounted for when specifying the clearance height. Please refer to **Installation dimensions** for further details.

Legend

- S = Length of travel
- R = Bending radius
- H = Nominal clearance height
- D = Overlength e-chain® radius in final position
- $K = \pi \cdot R + \text{safety buffer}$
- H_f = Required clearance height

PDF: igus.com/e-chain-pdfs
 Product information: igus.com/e-chains



Speed / acceleration FL_G	max. 65.6 ft/s (20 m/s) / max. 656 ft/s² (200 m/s²)
Speed / acceleration FL_B	max. 9.84 ft/s (3 m/s) / max. 19.69 ft/s² (6 m/s²)
Gliding speed / acceleration (maximum)	upon request
Permitted temperature	-40°F (-40°C) up to +158°F (+70° C)
Flammability Class	VDE 0304 IIC UL94 HB

Technical Data



Details of material properties

► Design, Chapter 1

Series E6-35 - e-chain® with crossbars every other link

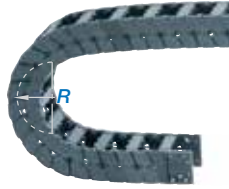
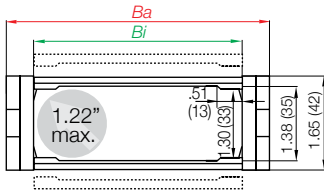

Part Number Structure

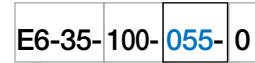

Color - Black
Bending radius
Width
Series

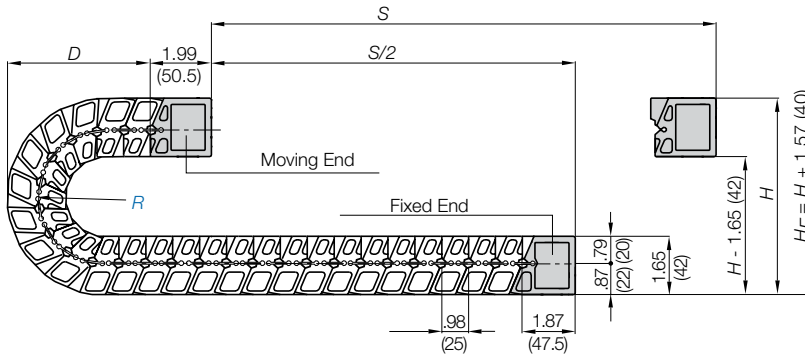

Supplement part number with required radius.
Example: E6-35-100-055-0
Pitch: .98 in. (25 mm) per link links/ft (m) = 12.19 (40)

Part Number	Bi in. (mm)	Ba in. (mm)	Weight lbs/ft (kg/m)
E6-35-030- <input type="checkbox"/> -0	1.18 (30)	1.97 (50)	≈ 0.59 (0.88)
E6-35-040- <input type="checkbox"/> -0	1.57 (40)	2.36 (60)	≈ 0.54 (0.90)
E6-35-050- <input type="checkbox"/> -0	1.97 (50)	2.76 (70)	≈ 0.90 (0.92)
E6-35-060- <input type="checkbox"/> -0	2.36 (60)	3.15 (80)	≈ 0.63 (0.94)
E6-35-070- <input type="checkbox"/> -0	2.76 (70)	3.54 (90)	≈ 0.65 (0.96)
E6-35-080- <input type="checkbox"/> -0	3.15 (80)	3.94 (100)	≈ 0.66 (0.99)
E6-35-090- <input type="checkbox"/> -0	3.54 (90)	4.33 (110)	≈ 0.68 (1.01)
E6-35-100- <input type="checkbox"/> -0	3.94 (100)	4.72 (120)	≈ 0.69 (1.03)
E6-35-110- <input type="checkbox"/> -0	4.33 (110)	5.12 (130)	≈ 0.76 (1.05)
E6-35-120- <input type="checkbox"/> -0	4.72 (120)	5.51 (140)	≈ 0.72 (1.07)
E6-35-140- <input type="checkbox"/> -0	5.51 (140)	6.30 (160)	≈ 0.75 (1.11)

Choose from the radii below for all of the above sizes
Radius (mm) Example: E6-35-100-055-0

	055	075	100	150
R	2.17 (055)	2.95 (075)	3.94 (100)	5.91 (150)
H	7.44 (189)	9.01 (229)	10.98 (279)	14.92 (379)
D	4.53 (115)	5.31 (135)	6.30 (160)	8.27 (210)
K	8.86 (225)	11.42 (290)	14.37 (365)	20.67 (525)

e-chain® as separate parts, links and side plates

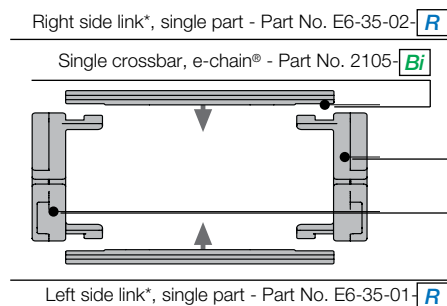

Polymer spring as single part -
Part No. E6-35-150

*View from the fixed point of the e-chain®/E-Tube

e-chain system® E6
Series E6-35
Interior Separation - New Generation



E6-35

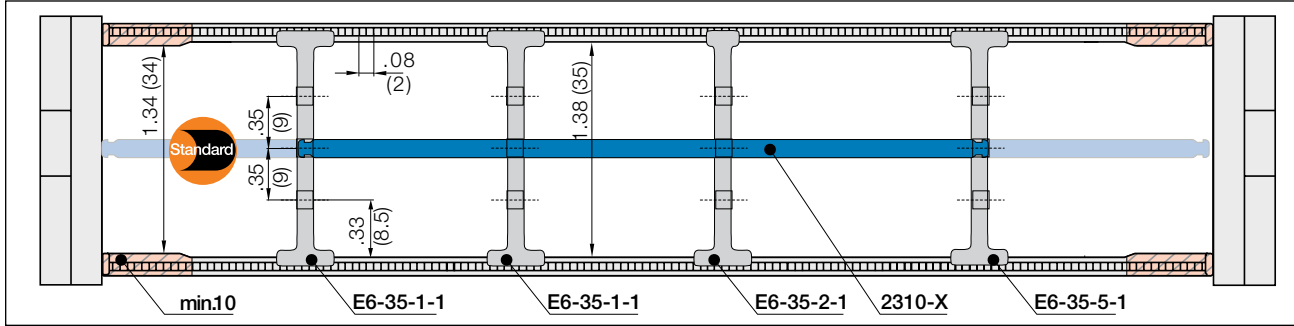

Note: Please maintain a lateral spacing of .39" (10 mm) between the separators and the side links. In the standard configuration separators are assembled every 2nd e-chain® link

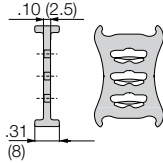

Separator, wide base

Unassembled	Part No. E6-35-1
Assembled	Part No. E6-35-1-1

- **Standard separator E6-35-1 for all applications**

Separator with wide base for maximum locking strength and safe standing in e-chains®.

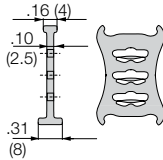

Separator, narrow head

Unassembled	Part No. E6-35-2
Assembled	Part No. E6-35-2-1

- **Separator E6-35-2 For even faster installation**

Firmly holds to one side with a wide base, narrow on opposite side for easy cable assembly (slight grip).

Lockable full-width shelves - for the standard interior separation

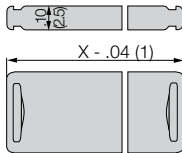

Full width shelf, lockable

Unassembled	Part No. 2300-X
Assembled	Part No. 2310-X

- **Full width shelf, lockable**

Shelf locks safely into separators on both ends, fixed width possible. Separators can be moved freely over the shelf horizontally. Can be arranged at three different heights.

Width X in. (mm)	Part No. Unassembled	Part No. Assembled	Width X in. (mm)	Part No. Unassembled	Part No. Assembled	Width X in. (mm)	Part No. Unassembled	Part No. Assembled
0.59 (015)	2300-15	2310-15	2.36 (060)	2300-60	2310-60	3.43 (087)	2300-87	2310-87
0.98 (025)	2300-25	2310-25	2.44 (062)	2300-62	2310-62	3.54 (090)	2300-90	2310-90
1.18 (030)	2300-30	2310-30	2.56 (065)	2300-65	2310-65	3.94 (100)	2300-100	2310-100
1.50 (038)	2300-38	2310-38	2.76 (070)	2300-70	2310-70	4.06 (103)	2300-103	2310-103
1.57 (040)	2300-40	2310-40	2.95 (075)	2300-75	2310-75	4.33 (110)	2300-110	2310-110
1.97 (050)	2300-50	2310-50	3.03 (077)	2300-77	2310-77	4.72 (120)	2300-120	2310-120
2.24 (057)	2300-57	2310-57	3.15 (080)	2300-80	2310-80	4.92 (125)	2300-125	2310-125

Separator with integrated strain relief

Strain relief separator Part No. E6-35-02-Z can be integrated into the mounting bracket and can be placed there at any point of the e-chain®. It combines strain relief and interior separation, it can be installed on the first or last e-chain® link and is easy to assemble without any screws.

For more information ► **Chapter 10, Strain Relief**



PDF: igus.com/e-chain-pdfs
Product information: igus.com/e-chains



Vertical separators

Vertical separators are used if a vertical subdivision of the e-chain® interior is required. By standard, vertical separators are assembled every other e-chain® link.

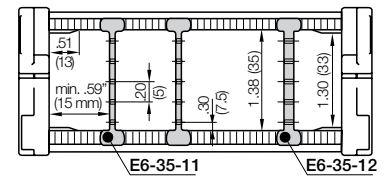

• **Slotted vertical separator E6-35-01**

This separator is used for general subdivision of e-chains®. Can be used in combination with full-width shelf 111-X.

• **Vertical separator E6-35-02**

For use with side plate E6-35-13, full-width shelf 221-X and shelf 2210-X

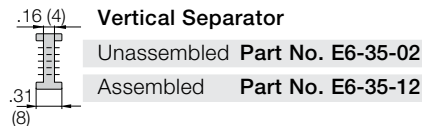
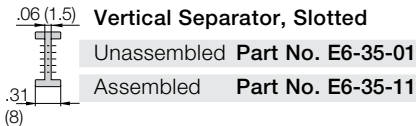

Full-width shelf

For applications involving many thin cables with similar or identical diameters. Full-width shelf **111-X** can be used with vertical separator **E6-35-11**. Full-width shelf **221-X** can be used with vertical separator **E6-35-12**.

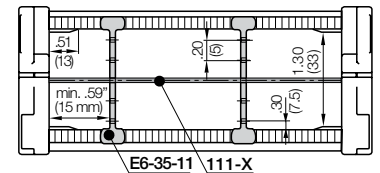

Shelves 110-X/220-XX

Shelves can be inserted at 5 different heights in .20" (5mm) increments

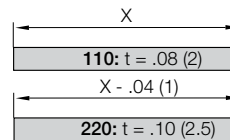

Width X in. (mm)	Part No.		Part No.		Width X in. (mm)	Part No.		Part No.	
	Unassembled	Assembled	Unassembled	Assembled		Unassembled	Assembled	Unassembled	Assembled
1.18 (030)	110-30	220-30	111-30	221-30	3.15 (080)	110-80	220-80	111-80	221-80
1.57 (040)	110-40	220-40	111-40	221-40	3.54 (090)	110-90	220-90	111-90	221-90
1.97 (050)	110-50	220-50	111-50	221-50	3.94 (100)	110-100	220-100	111-100	221-100
2.36 (060)	110-60	220-60	111-60	221-60	4.33 (110)	110-110	220-110	111-110	221-110
2.76 (070)	110-70	220-70	111-70	221-70	4.72 (120)	110-120	220-120	111-120	221-120

Shelves

These components form the basic pattern of a shelf system. Shelves of various widths can be arranged at 5 different heights in .20" (5mm) increments

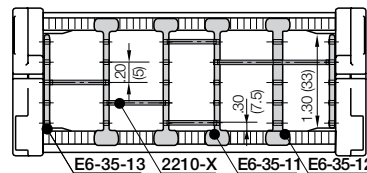

• **Side plate**

This separator is used for general subdivision of e-chains®.



Shelves 2200-XX

Shelf 2210-X can be used with vertical separator E6-35-12 and side plate E6-35-13

Width X in. (mm)	Part No.		Width X in. (mm)	Part No.	
	Unassembled	Assembled		Unassembled	Assembled
.71 (18)	2200-18	2210-18	1.89 (48)	2200-48	2210-48
.91 (23)	2200-23	2210-23	2.28 (58)	2200-58	2210-58
1.10 (28)	2200-28	2210-28	2.68 (68)	2200-68	2210-68
1.30 (33)	2200-33	2210-33	2.87 (73)	2200-73	2210-73
1.50 (38)	2200-38	2210-38	3.46 (88)	2200-88	2210-88
1.69 (43)	2200-43	2210-43	3.90 (99)	2200-99	2210-99

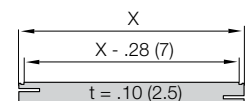

e-chain system® E6

Series E6-35

Mounting Bracket - KMA / Strain Relief



E6-35

KMA - Pivoting

- Bolted connection outside of the chain cross-section
- Recommended for unsupported applications (for gliding applications please contact igus®)
- Confined installation conditions
- Attachment capability on all sides

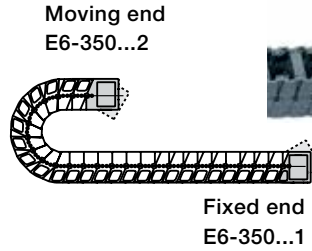

Possible installation configurations -

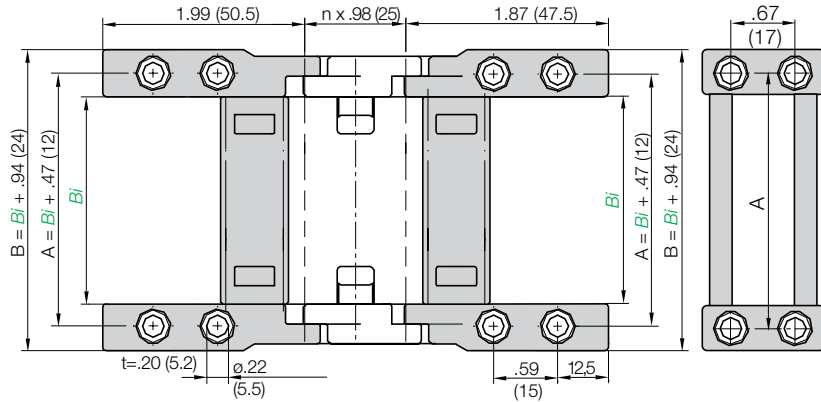

Part Number Structure

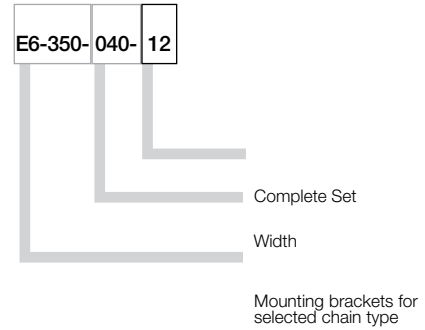

For Series	Part No. Full Set	Dimension B in. (mm)	Dimension A in. (mm)	Bi in. (mm)
E6-35-030	E6-350-030-12	2.13 (54)	1.65 (42)	30
E6-35-040	E6-350-040-12	2.52 (64)	2.05 (52)	40
E6-35-050	E6-350-050-12	2.91 (74)	2.44 (62)	50
E6-35-060	E6-350-060-12	3.31 (84)	2.83 (72)	60
E6-35-070	E6-350-070-12	3.70 (94)	3.23 (82)	70
E6-35-080	E6-350-080-12	4.09 (104)	3.62 (92)	80
E6-35-090	E6-350-090-12	4.49 (114)	4.02 (102)	90
E6-35-100	E6-350-100-12	4.88 (124)	4.41 (112)	100
E6-35-110	E6-350-110-12	5.28 (134)	4.80 (122)	110
E6-35-120	E6-350-120-12	5.67 (144)	5.20 (132)	120
E6-35-140	E6-350-140-12	6.46 (164)	5.98 (152)	140

Full set, for both ends:

E6-350-040-12 Full set, both fixed and moving end

Single-part order:

E6-350-040-1 Mounting bracket fixed end

E6-350-040-2 Mounting bracket moving end

Tiewrap Plates

Tiewrap plates as an individual part

Available as an individual component, can be fixed onto a mounting bracket with the use of a profile rail.

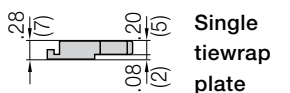
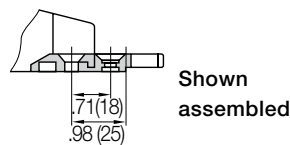

Tiewrap Plates	n Number of Teeth	Dimension C	Dimension B
2020-ZB	3	1.18 (30)	.59 (15)
2030-ZB	4	1.57 (40)	.79 (20)
2040-ZB	5	1.97 (50)	1.18 (30)
2050-ZB	6	2.36 (60)	1.57 (40)
2070-ZB	8	3.15 (80)	2.36 (60)
2090-ZB	9	3.54 (90)	2.76 (70)
2100-ZB	10	3.94 (100)	3.15 (80)
2120-ZB	12	4.72 (120)	3.94 (100)

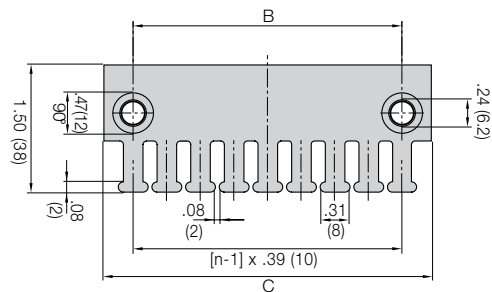

If used with KMA brackets with profile rail please add "KMA" to the end of the part number.

Example: 2020-ZBKMA

Other strain relief elements
 ► Strain Relief, Chapter 10

PDF: igus.com/e-chain-pdfs
 Product information: igus.com/e-chains



Price Index



Series E6-40

Special Options Available



Extremely low noise
Test results upon request



IPA Certificate: Class 1, according to standard DIN EN ISO 14644-1 for the E6 system (Series E6-29-060-150-0-CR, $v = 1.64 \text{ ft/s}$, $a = 3.28 \text{ ft/s}^2$)



LEVEL 1 absorption confirmed by IPA-Fraunhofer-Institute according to SEMI E78-0998 for the E6 standard material

Assembly Tips

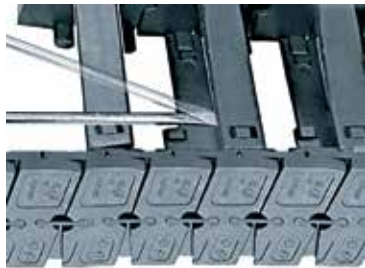

To close, push and click shut

Other Installation Methods

Vertical, hanging $\leq 98.4 \text{ ft}$ (30 m)Vertical, standing $\leq 6.56 \text{ ft}$ (2 m)

Side-mounted, un supp. =

possible to a limited extent

Unsupported length of upper run upon request

Usage Guidelines



- If a low-noise version is required
- For very high speeds and/or accelerations
- If large stresses and thrust forces are present
- For small bending radii
- If less vibration is required
- Minimal abrasion, suitable for cleanrooms



- For side mounted applications
➤ Series E4-32 E4-1
- For RBR (Reverse Bending Radius)
➤ Series E4-32 E4-1
- For high additional loads
➤ Series E4-32 E4-1
- For dirty environments
➤ Series E4-32 E4-1

Features & Benefits

- 1 KMA mounting brackets with attachment points on all sides (strain relief with separate tie-wrap plates possible)
- 2 Small pitch for low-noise, smooth operation
- 3 No pin and bore connection, minimal abrasion
- 4 Interior stop dog
- 5 Can be shortened or lengthened due to modular design
- 6 Available with or without integrated profile rail
- 7 Very large gliding surfaces

- Also available:
Separator with integrated strain relief for use in the first or last chain link (Part No. E6-40-02-Z)
➤ Strain Relief, Chapter 10

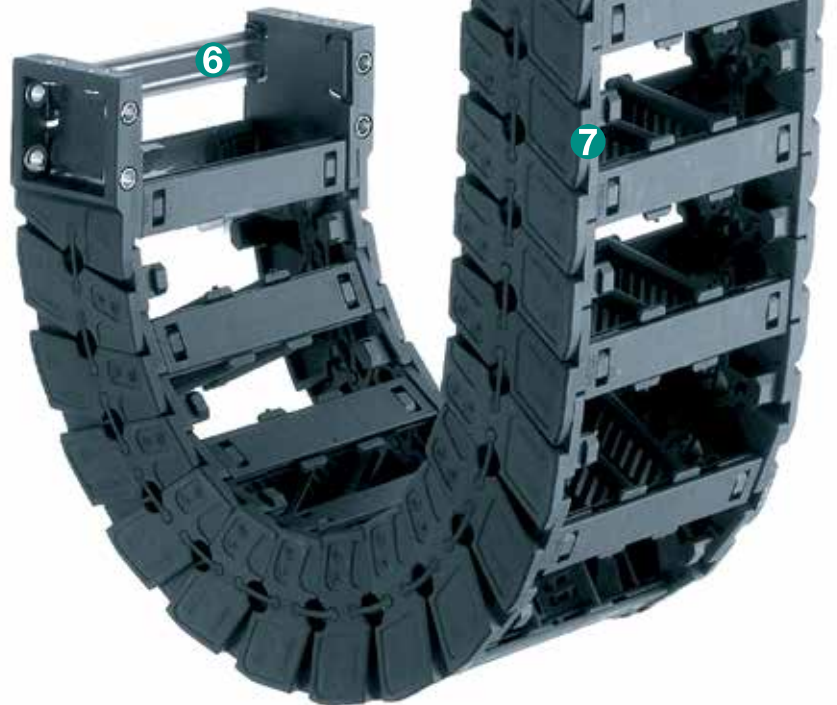

Order Example: Complete e-chain®

Please indicate chain length or number of links. Example:

6.56 ft (2 m) E6-40-100-075-0



e-chain®

With 2 separators 28222 assembled every 2nd link



Interior Separation

1 Set E6-400-100-12



Mounting Bracket

e-chain system® E6

Series E6-40

Installation Dimensions



E6-40

Short travel, unsupported length

- FL_B = unsupported with permitted sag
- FL_G = unsupported with straight upper run

Further information ► Design, Chapter 1

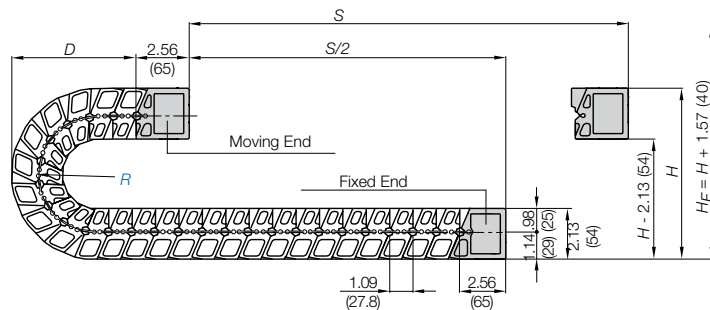
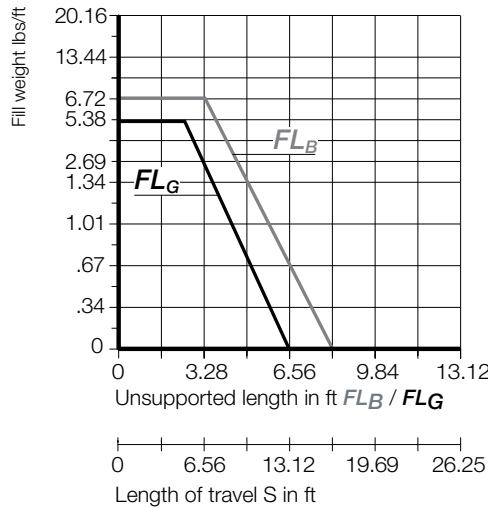
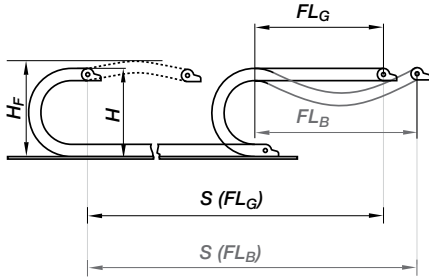

Pitch per link = 1.09" (27.8 mm)
 Links per ft (m) = 10.97 (36)
 For center mount applications:
 Chain length = $\frac{S}{2} + K$

The required clearance height: $H_F = H + 1.57$ in. (40 mm) (with 1.34 lbs/ft (2.0 kg/m) fill weight).
 Please consult igus® if space is particularly restricted.

	2.48 (063)	2.95 (075)	3.94 (100)	4.92 (125)	5.91 (150)	7.87 (200)
R	2.48 (063)	2.95 (075)	3.94 (100)	4.92 (125)	5.91 (150)	7.87 (200)
H	8.82 (224)	9.76 (248)	11.73 (298)	13.71 (348)	15.67 (398)	19.61 (498)
D	5.28 (134)	5.75 (146)	6.73 (171)	7.72 (196)	8.70 (221)	10.67 (271)
K	10.04 (255)	11.61 (295)	14.57 (370)	17.72 (450)	20.87 (530)	26.97 (685)

Short Travels - Unsupported



Unsupported e-chains® feature positive camber over short travels. This must be accounted for when specifying the clearance height. Please refer to **Installation dimensions** for further details.

Legend

- S = Length of travel
- R = Bending radius
- H = Nominal clearance height
- D = Overlength e-chain® radius in final position
- $K = \pi \cdot R + \text{safety buffer}$
- H_F = Required clearance height
- H_{in} = Trough inner height
- H_2 = *Mounting height
- D_2 = Overlength - long travels, gliding
- K_2 = *Add-on

*If the mounting bracket location is set lower

1.57

PDF: igus.com/e-chain-pdfs
 Product information: igus.com/e-chains



Speed / acceleration FL_G	max. 65.6 ft/s (20 m/s) / max. 656 ft/s ² (200 m/s ²)
Speed / acceleration FL_B	max. 9.84 ft/s (3 m/s) / max. 19.69 ft/s ² (6 m/s ²)
Gliding speed / acceleration (maximum)	upon request
Permitted temperature	-40°F (-40°C) up to +158°F (+70° C)
Flammability Class	VDE 0304 IIC UL94 HB

Technical Data



Details of material properties

► Design, Chapter 1

Series E6-40 - e-chain® with crossbars every other link

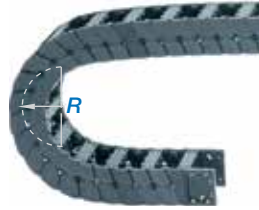
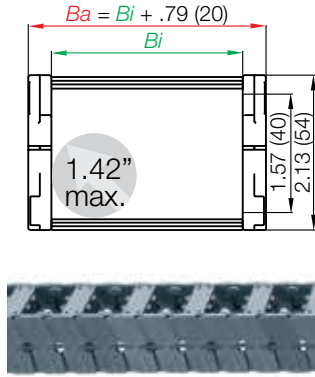

Part Number Structure

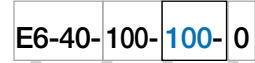

- Color - Black
- Bending radius
- Width
- Series

e-chain® as separate parts, links and side plates

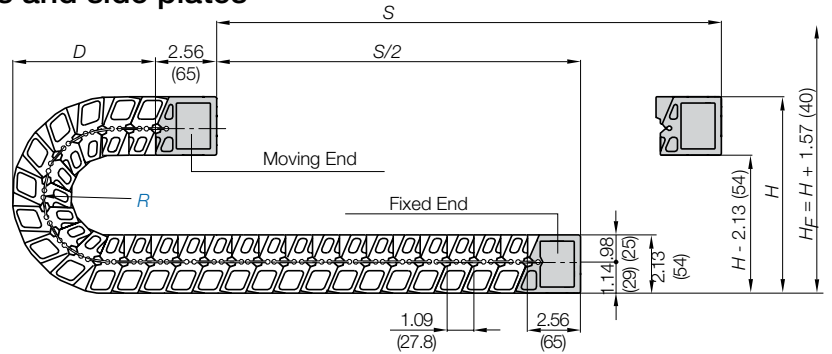
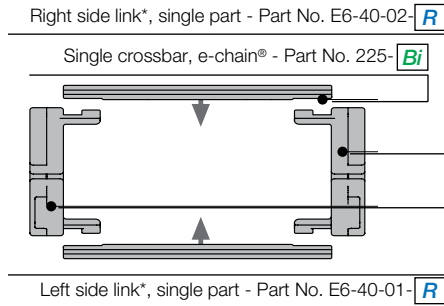

Polymer spring as single part -
Part No. E6-40-177

*View from the fixed point of the e-chain®/E-Tube

Supplement part number with required radius. Example: E6-40-100--0
Pitch: 1.09 in. (27.8 mm) per link links/ft (m) = 10.97 (36)

Part Number	Bi in. (mm)	Ba in. (mm)	Weight lbs/ft (kg/m)
E6-40-040- <input type="text"/> -0	1.57 (40)	2.36 (60)	≈ 0.87 (1.29)
E6-40-050- <input type="text"/> -0	1.97 (50)	2.76 (70)	≈ 0.89 (1.33)
E6-40-052- <input type="text"/> -0	2.05 (52)	2.83 (72)	≈ 0.90 (1.34)
E6-40-062- <input type="text"/> -0	2.44 (62)	3.23 (82)	≈ 0.93 (1.38)
E6-40-070- <input type="text"/> -0	2.76 (70)	3.54 (90)	≈ 0.95 (1.41)
E6-40-075- <input type="text"/> -0	2.95 (75)	3.74 (95)	≈ 0.96 (1.43)
E6-40-087- <input type="text"/> -0	3.42 (87)	4.21 (107)	≈ 0.99 (1.48)
E6-40-100- <input type="text"/> -0	3.94 (100)	4.72 (120)	≈ 1.02 (1.53)
E6-40-125- <input type="text"/> -0	4.92 (125)	5.71 (145)	≈ 1.10 (1.63)
E6-40-150- <input type="text"/> -0	5.91 (150)	6.69 (170)	≈ 1.16 (1.73)
E6-40-175- <input type="text"/> -0	6.89 (175)	7.68 (195)	≈ 1.23 (1.83)
E6-40-200- <input type="text"/> -0	7.87 (200)	8.66 (220)	≈ 2.50 (1.93)
E6-40-225- <input type="text"/> -0	8.86 (225)	9.65 (245)	≈ 1.36 (2.02)
E6-40-250- <input type="text"/> -0	9.84 (250)	10.63 (270)	≈ 1.42 (2.12)
E6-40-275- <input type="text"/> -0	10.83 (275)	11.61 (295)	≈ 1.49 (2.22)
E6-40-300- <input type="text"/> -0	11.81 (300)	12.60 (320)	≈ 1.56 (2.32)

Choose from the radii below for all of the above sizes

Radius (mm) Example: E6-40-100--0

	063	075	100	125	150	200
R	2.48 (063)	2.95 (075)	3.94 (100)	4.92 (125)	5.91 (150)	7.87 (200)
H	8.82 (224)	9.76 (248)	11.73 (298)	13.71 (348)	15.67 (398)	19.61 (498)
D	5.28 (134)	5.75 (146)	6.73 (171)	7.72 (196)	8.70 (221)	10.67 (271)
K	10.04 (255)	11.61 (295)	14.57 (370)	17.72 (450)	20.87 (530)	26.97 (685)

e-chain system® E6
 Series E6-40
 Interior Separation - New Generation



E6-40

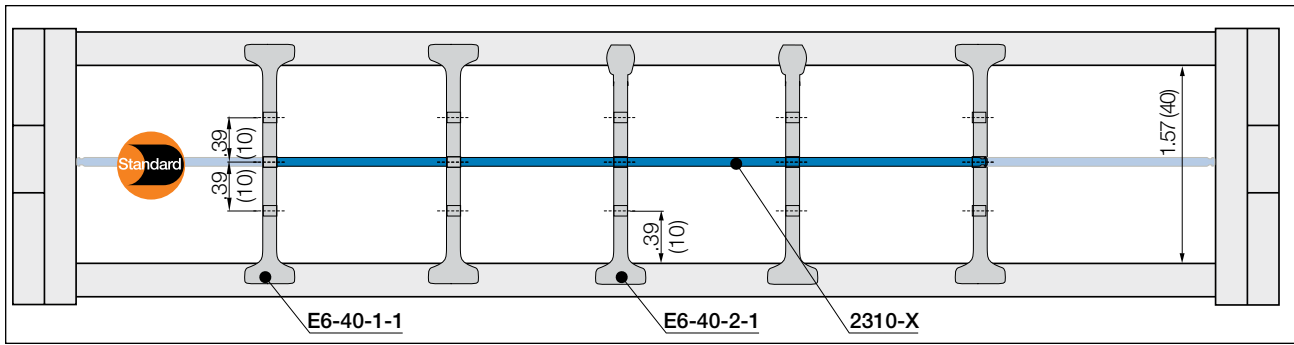

No lateral spacing between the separators and the side links is necessary.
 In the standard configuration separators are assembled every 2nd e-chain® link

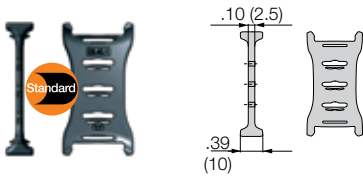

Separator, wide base
 Unassembled Part No. E6-40-1
 Assembled Part No. E6-40-1-1

- **Standard separator E6-40-1 for all applications**
 Separator with wide base for maximum locking strength and safe standing in e-chains®.

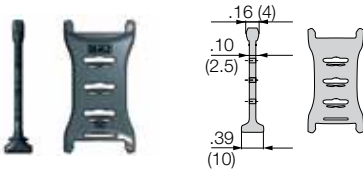

Separator, narrow head
 Unassembled Part No. E6-40-2
 Assembled Part No. E6-40-2-1

- **Separator E6-40-2 For even faster installation**
 Firmly holds to one side with a wide base, narrow on opposite side for easy cable assembly (slight grip).

Lockable full-width shelves - for the standard interior separation

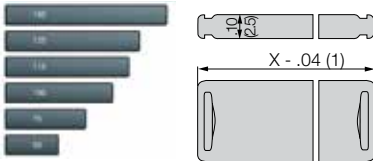

Full width shelf, lockable
 Unassembled Part No. 2300-X
 Assembled Part No. 2310-X

- **Full width shelf, lockable**
 Shelf locks safely into separators on both ends, fixed width possible. Separators can be moved freely over the shelf horizontally. Can be arranged at three different heights.

Width X in. (mm)	Part No. Unassembled	Part No. Assembled	Width X in. (mm)	Part No. Unassembled	Part No. Assembled	Width X in. (mm)	Part No. Unassembled	Part No. Assembled
0.59 (015)	2300-15	2310-15	2.36 (060)	2300-60	2310-60	3.43 (087)	2300-87	2310-87
0.98 (025)	2300-25	2310-25	2.44 (062)	2300-62	2310-62	3.54 (090)	2300-90	2310-90
1.18 (030)	2300-30	2310-30	2.56 (065)	2300-65	2310-65	3.94 (100)	2300-100	2310-100
1.50 (038)	2300-38	2310-38	2.76 (070)	2300-70	2310-70	4.06 (103)	2300-103	2310-103
1.57 (040)	2300-40	2310-40	2.95 (075)	2300-75	2310-75	4.33 (110)	2300-110	2310-110
1.97 (050)	2300-50	2310-50	3.03 (077)	2300-77	2310-77	4.72 (120)	2300-120	2310-120
2.24 (057)	2300-57	2310-57	3.15 (080)	2300-80	2310-80	4.92 (125)	2300-125	2310-125

Separator with integrated strain relief

Strain relief separator Part No. E6-40-02-Z can be integrated into the mounting bracket and can be placed there at any point of the e-chain®. It combines strain relief and interior separation, it can be installed on the first or last e-chain® link and is easy to assemble without any screws.

For more information ► Chapter 10, Strain Relief



PDF: igus.com/e-chain-pdfs
 Product information: igus.com/e-chains



Vertical separators

Vertical separators are used if a vertical subdivision of the e-chain® interior is required. By standard, vertical separators are assembled every other e-chain® link.

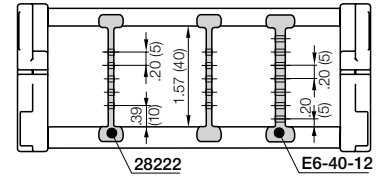

- **Slotted vertical separator**
 This separator is used for general subdivision of e-chains®. Can be used in combination with full-width shelf 221-X.

- **Locking vertical separator**
 For use with shelf 2210-X

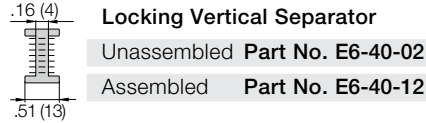
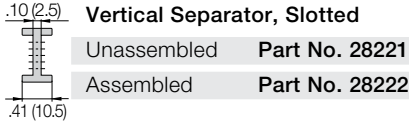

Full-width shelf

For applications involving many thin cables with similar or identical diameters.

Full-width shelf **221-X** can be used with vertical separator **28222**, side plate **E6-40-13** and asymmetrical separator **E6-40-18**

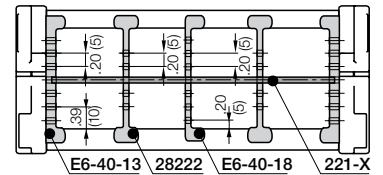

- **Side plate**
 This separator is used for general subdivision of e-chains®.

- **Asymmetrical separator**
 This separator is used for general subdivision of e-chains®.

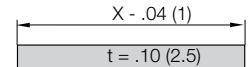
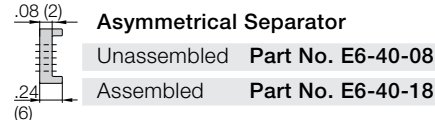
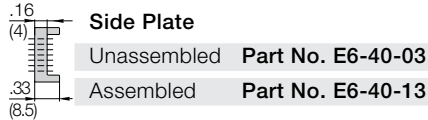

Shelves 220-XX

Shelves can be inserted at 5 different heights in .20" (5mm) increments

Width X	Part No.	Part No.	Width X	Part No.	Part No.
in. (mm)	Unassembled	Assembled	in. (mm)	Unassembled	Assembled
1.57 (040)	220-40	221-40	3.94 (100)	220-100	221-100
1.97 (050)	220-50	221-50	4.92 (125)	220-125	221-125
2.44 (062)	220-62	221-62	5.91 (150)	220-150	221-150
2.76 (070)	220-70	221-70	6.89 (175)	220-175	221-175
2.95 (075)	220-75	221-75	7.87 (200)	220-200	221-200
3.43 (087)	220-87	221-87			

Shelves

These components form the basic pattern of a shelf system. Shelves of various widths can be arranged at 7 different heights in .20" (5mm) increments

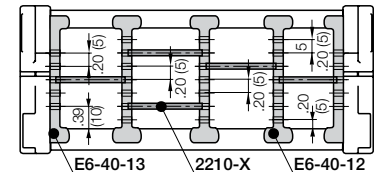

Shelves 2200-XX

Shelf 2210-X can be used with locking vertical separator E6-40-12 and side plate E6-40-13

Width X	Part No.	Part No.	Width X	Part No.	Part No.
in. (mm)	Unassembled	Assembled	in. (mm)	Unassembled	Assembled
.71 (18)	2200-18	2210-18	2.28 (58)	2200-58	2210-58
.91 (23)	2200-23	2210-23	2.28 (63)	2200-65	2210-65
1.10 (28)	2200-28	2210-28	2.68 (68)	2200-68	2210-68
1.30 (33)	2200-33	2210-33	2.87 (73)	2200-73	2210-73
1.50 (38)	2200-38	2210-38	3.46 (88)	2200-88	2210-88
1.69 (43)	2200-43	2210-43	3.90 (99)	2200-99	2210-99
1.89 (48)	2200-48	2210-48			

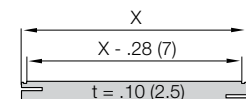

e-chain system® E6

Series E6-40

Mounting Bracket - KMA



E6-40



Option 1: KMA - Pivoting

- Option - profile rail with integrated strain relief chainfix clip or tiwrap plates
- Profile rail can be mounted in the inner or outer radius of the e-chain®
- Bolted connection outside of the chain cross-section
- Recommended for unsupported applications (for gliding applications please contact igus®)
- Confined installation conditions
- Attachment capability on all sides



Adapters for gliding applications available upon request

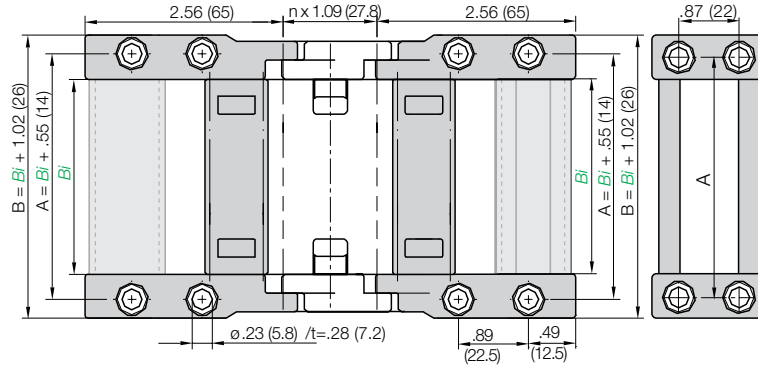
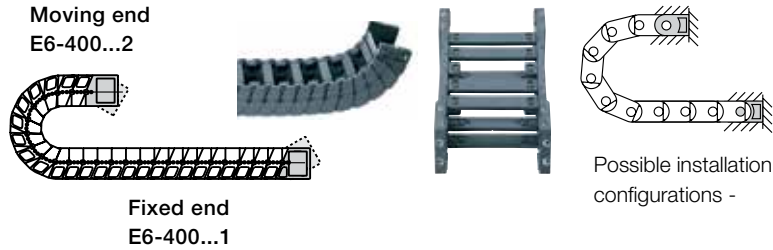

For Series	Part No. Full Set Without Profile Rail	Part No. Full Set With Profile Rail	Dimension A in. (mm)	Dimension B in. (mm)
E6-40-040	E6-400-040-12	E6-400-040-12P	2.13 (54)	2.60 (66)
E6-40-050	E6-400-050-12	E6-400-050-12P	2.52 (64)	2.99 (76)
E6-40-052	E6-400-052-12	E6-400-052-12P	2.66 (66)	3.07 (78)
E6-40-062	E6-400-062-12	E6-400-062-12P	2.99 (76)	3.46 (88)
E6-40-070	E6-400-070-12	E6-400-070-12P	3.31 (84)	3.78 (96)
E6-40-075	E6-400-075-12	E6-400-075-12P	3.50 (89)	3.98 (101)
E6-40-087	E6-400-087-12	E6-400-087-12P	3.98 (101)	4.45 (113)
E6-40-100	E6-400-100-12	E6-400-100-12P	4.49 (114)	4.96 (126)
E6-40-125	E6-400-125-12	E6-400-125-12P	5.47 (139)	5.94 (151)
E6-40-150	E6-400-150-12	E6-400-150-12P	6.46 (164)	6.93 (176)
E6-40-175	E6-400-175-12	E6-400-175-12P	7.44 (189)	7.91 (201)
E6-40-200	E6-400-200-12	E6-400-200-12P	8.43 (214)	8.90 (226)
E6-40-225	E6-400-225-12	E6-400-225-12P	9.41 (239)	9.88 (251)
E6-40-250	E6-400-250-12	E6-400-250-12P	10.39 (264)	10.87 (276)
E6-40-275	E6-400-275-12	E6-400-275-12P	11.38 (289)	11.85 (301)
E6-40-300	E6-400-300-12	E6-400-300-12P	12.36 (314)	12.83 (326)

Part Number Structure

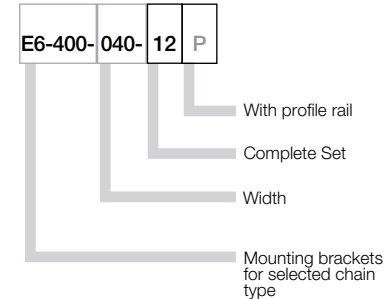

Full set, for both ends:

E6-400- [040-] 12 Full set, both fixed and moving end

Single-part order:

E6-400 - [040-] 1

Mounting bracket fixed end

E6-400 - [040-] 2

Mounting bracket moving end

Tiewrap Plates

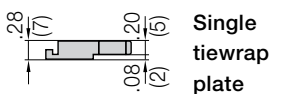
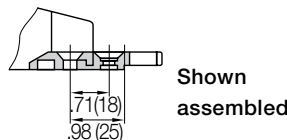

Option 1: Tiewrap plates as an individual part

Available as an individual component, can be fixed onto a mounting bracket with the use of a profile rail.

Tiewrap Plates	n Number of Teeth	Dimension C	Dimension B
2020-ZB	3	1.18 (30)	.59 (15)
2030-ZB	4	1.57 (40)	.79 (20)
2040-ZB	5	1.97 (50)	1.18 (30)
2050-ZB	6	2.36 (60)	1.57 (40)
2070-ZB	8	3.15 (80)	2.36 (60)
2090-ZB	9	3.54 (90)	2.76 (70)
2100-ZB	10	3.94 (100)	3.15 (80)
2120-ZB	12	4.72 (120)	3.94 (100)

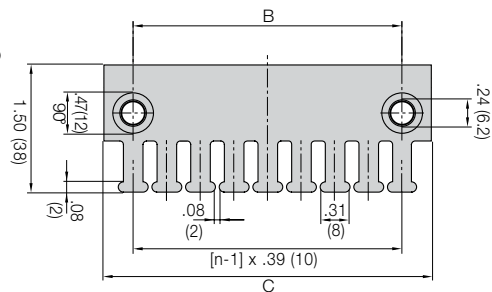

If used with KMA brackets with profile rail please add "KMA" to the end of the part number.

Example: 2020-ZBKMA

- Other strain relief elements
- Strain Relief, Chapter 10

PDF: igus.com/e-chain-pdfs
Product information: igus.com/e-chains



Price Index

Series R6-40

Special Features / Options

Extremely low noise
Test results upon request



IPA Certificate: Class 1, according to standard DIN EN ISO 14644-1 for the E6 system (Series E6-29-060-150-0-CR, (v = 1.64 ft/s, a = 3.28 ft/s²))



LEVEL 1 absorption confirmed by IPA-Fraunhofer-Institute according to SEMI E78-0998 for the E6 standard material

Assembly Tips

Lever and remove lids

Other Installation Methods

Vertical, hanging ≤ 98.4 ft (30 m)

Vertical, standing ≤ 6.56 ft (2 m)

Side-mounted, un_supp. =

possible to a limited extent

Unsupported length of upper run upon request

Usage Guidelines



- If a low-noise version is required
- For very high speeds and/or accelerations
- If large stresses and thrust forces are present
- Protection against hot chips
- For small bending radii
- If less vibration is required
- Minimal abrasion, suitable for cleanrooms



- For side mounted applications
➤ Series R4-32 E4-1

Features & Benefits

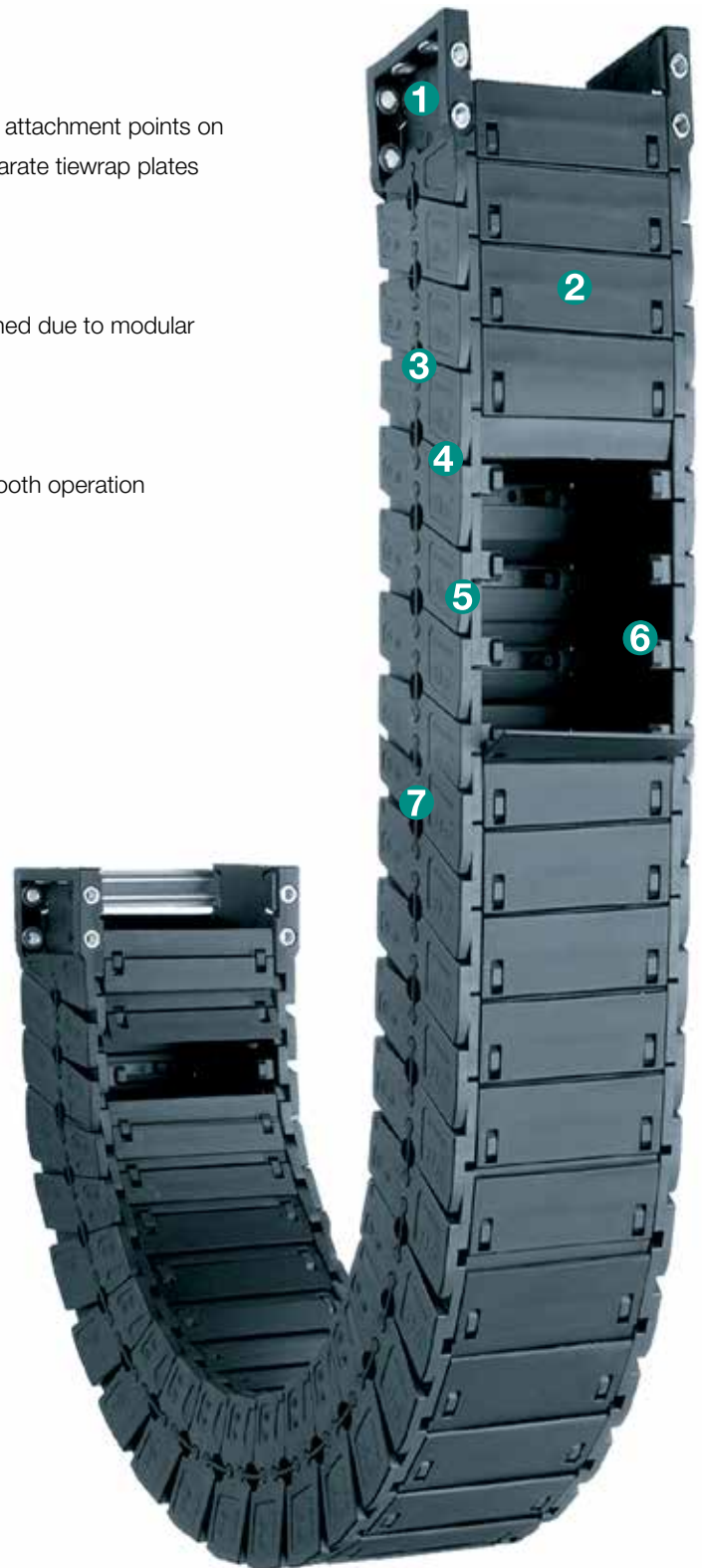
- 1 KMA mounting brackets with attachment points on all sides (strain relief with separate tie-wrap plates possible)
- 2 Fully enclosed E-Tube
- 3 No pin and bore connection
- 4 Can be shortened or lengthened due to modular design
- 5 Very large gliding surfaces
- 6 Interior stop dog
- 7 Small pitch for low-noise, smooth operation

Order Example: Complete e-chain®

Please indicate chain length or number of links. Example:

6.56 ft (2 m) **R6-40-062-075-0****e-chain®**With 2 separators **R6-40-11** assembled every 2nd link**Interior Separation**1 Set **R6-400-062-12****Mounting Bracket**

e-chain system® E6

Series R6-40

Installation Dimensions

Short travel, unsupported length

- FL_B = unsupported with permitted sag
 - FL_G = unsupported with straight upper run
- Further information ► Design, Chapter 1

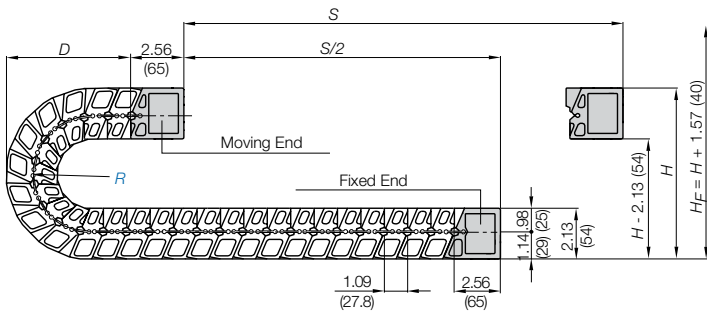
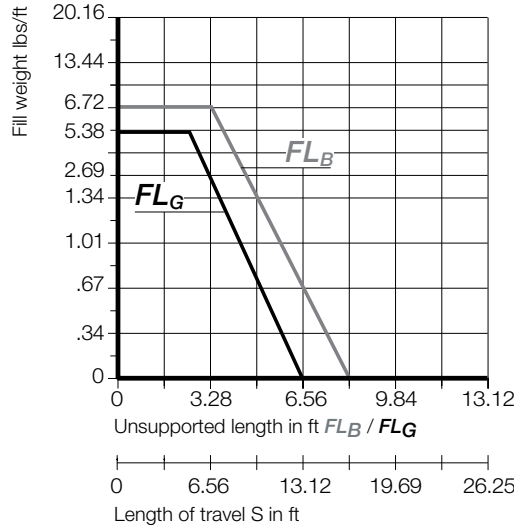
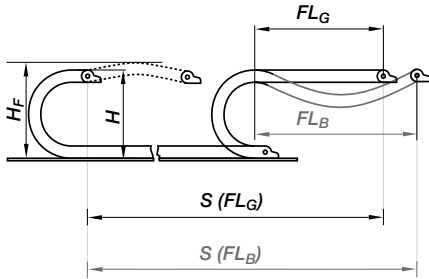

Pitch per link: = 1.09" (27.8 mm)
 Links per ft (m): = 10.97 (36)
 For center mount applications:
 Chain length = $\frac{S}{2} + K$

The required clearance height: $H_F = H + 1.57$ in. (40 mm) (with 1.34 lbs/ft (2.0 kg/m) fill weight).
 Please consult igus® if space is particularly restricted.

R	2.48 (063)	2.95 (075)	3.94 (100)	4.92 (125)	5.91 (150)	7.87 (200)
H	8.82 (224)	9.76 (248)	11.73 (298)	13.71 (348)	15.67 (398)	19.61 (498)
D	5.28 (134)	5.75 (146)	6.73 (171)	7.72 (196)	8.70 (221)	10.67 (271)
K	10.04 (255)	11.61 (295)	13.50 (343)	16.65 (423)	20.87 (530)	26.97 (685)



R6-40

Short Travels - Unsupported



Unsupported e-chains® feature positive camber over short travels. This must be accounted for when specifying the clearance height. Please refer to **Installation dimensions** for further details.

Legend

- S = Length of travel
- R = Bending radius
- H = Nominal clearance height
- D = Overlength e-chain® radius in final position
- $K = \pi \cdot R + \text{safety buffer}$
- H_F = Required clearance height
- H_{in} = Trough inner height
- H_2 = *Mounting height
- D_2 = Overlength - long travels, gliding
- K^2 = *Add-on

*If the mounting bracket location is set lower

1.57

PDF: igus.com/e-chain-pdfs
 Product information: igus.com/e-chains



Speed / acceleration FL_G	max. 65.6 ft/s (20 m/s) / max. 656 ft/s ² (200 m/s ²)
Speed / acceleration FL_B	max. 9.84 ft/s (3 m/s) / max. 19.69 ft/s ² (6 m/s ²)
Gliding speed / acceleration (maximum)	upon request
Permitted temperature	-40°F (-40°C) up to +158°F (+70° C)
Flammability Class	VDE 0304 IIC UL94 HB

Technical Data



Details of material properties

► Design, Chapter 1

Series R6-40 - E-Tube, removable lids along the inner and outer radius

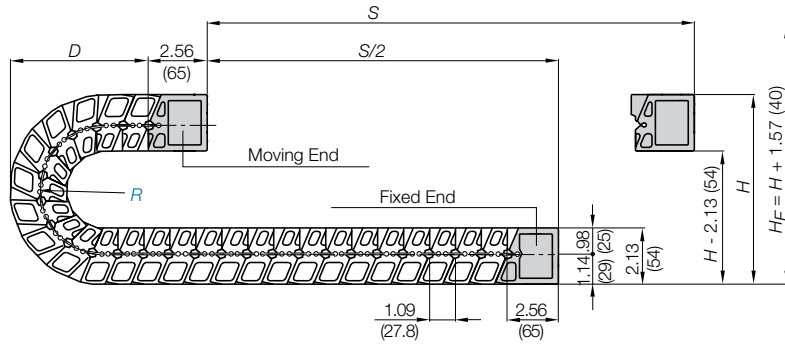
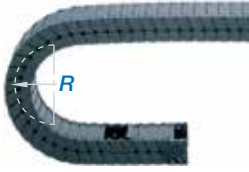
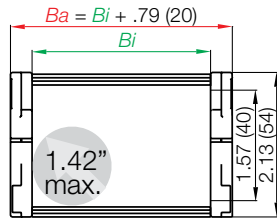

Part Number Structure

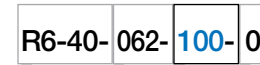

- Color - Black
- Bending radius
- Width
- Series

Supplement part number with required radius. Example: R6-40-062-**100**-0

Pitch: 1.09 in. (27.8 mm) per link links/ft (m) = 10.97 (36)

Part Number	Bi in. (mm)	Ba in. (mm)	Weight lbs/ft (kg/m)
R6-40-062- <input type="text"/> -0	2.44 (62)	3.23 (82)	≈ 1.07 (1.59)
R6-40-075- <input type="text"/> -0	2.95 (75)	3.74 (95)	≈ 1.11 (1.65)

Choose from the radii below for all of the above sizes
Radius (mm) Example: R6-40-062-**100**-0

	063	075	100	125	150	200
R	2.48 (63)	2.95 (75)	3.94 (100)	4.92 (125)	5.91 (150)	7.87 (200)
H	8.82 (224)	9.76 (248)	11.73 (298)	13.71 (348)	15.67 (398)	19.61 (498)
D	5.28 (134)	5.75 (146)	6.73 (171)	7.72 (196)	8.70 (221)	10.67 (271)
K	10.04 (255)	11.61 (295)	13.50 (343)	16.65 (423)	20.87 (530)	26.97 (685)

Vertical separators

Vertical separators are used if a vertical subdivision of the e-chain® interior is required. By standard, vertical separators are assembled every other E-Tube link.

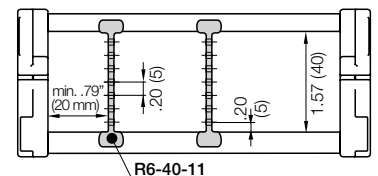

Vertical separator R6-40-01

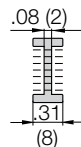

Vertical Separator

Unassembled Part No. R6-40-01

Assembled Part No. R6-40-11

- Vertical separator R6-40-01 This separator is used for general subdivision of E-Tubes.
- Separator snaps onto either the bottom of the carrier or the lid. Stays attached to that side. Opposite side can be removed.

e-chain system® E6

Series R6-40

Mounting Bracket - KMA / Strain Relief



R6-40



KMA - Pivoting

- Option - profile rail with integrated strain relief chainfix clip or tiewrap plates
- Profile rail can be mounted in the inner or outer radius of the e-chain®
- Bolted connection outside of the chain cross-section
- Recommended for unsupported applications (for gliding applications please contact igus®)
- Confined installation conditions
- Attachment capability on all sides

Moving end
R6-400...2

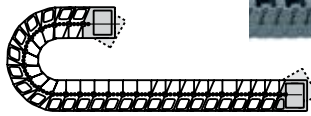

Fixed end
R6-400...1

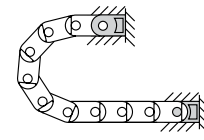

Possible installation configurations -



Adapters for gliding applications available upon request

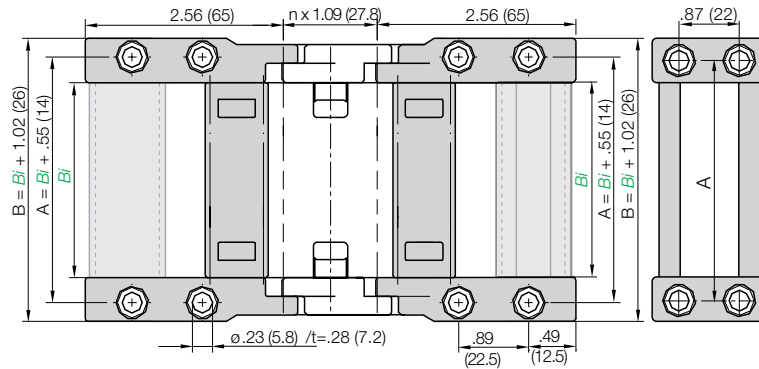

For Series	Part No. Full Set Without Profile Rail	Part No. Full Set With Profile Rail	Dimension A		Dimension B	
			in.	(mm)	in.	(mm)
R6-40-062	R6-400-062-12	R6-400-062-12P	2.99	(76)	3.46	(88)
R6-40-075	R6-400-075-12	R6-400-075-12P	3.50	(89)	3.98	(101)

Full set, for both ends:

R6-400-062-12 Full set, both fixed and moving end

Single-part order:

R6-400-062-1 Mounting bracket fixed end

R6-400-062-2 Mounting bracket moving end

Tiewrap Plates



Tiewrap plates as an individual part

Available as an individual component, can be fixed onto a mounting bracket with the use of a profile rail.

Tiewrap Plates	n Number of Teeth	Dimension C	Dimension B
2020-ZB	3	1.18 (30)	.59 (15)
2030-ZB	4	1.57 (40)	.79 (20)
2040-ZB	5	1.97 (50)	1.18 (30)
2050-ZB	6	2.36 (60)	1.57 (40)
2070-ZB	8	3.15 (80)	2.36 (60)
2090-ZB	9	3.54 (90)	2.76 (70)
2100-ZB	10	3.94 (100)	3.15 (80)
2120-ZB	12	4.72 (120)	3.94 (100)

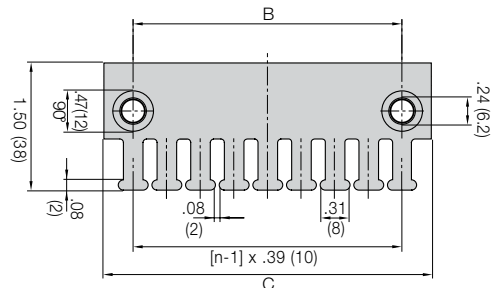

If used with KMA brackets with profile rail please add "KMA" to the end of the part number.

Example: 2020-ZBKMA

Other strain relief elements
► Strain Relief, Chapter 10

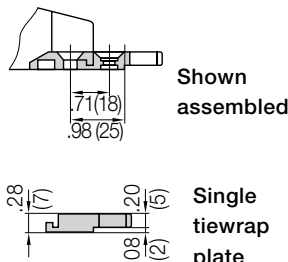

PDF: igus.com/e-chain-pdfs
Product information: igus.com/e-chains



Price Index

Series E6-52
Special Features / Options

Extremely low noise
 Test results upon request

IPA Certificate: Class 1, according to standard DIN EN ISO 14644-1 for the E6 system (Series E6-29-060-150-0-CR, (v = 1.64 ft/s, a = 3.28 ft/s²))

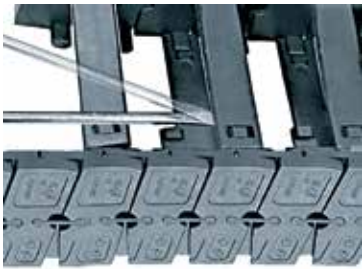
LEVEL 1 absorption confirmed by IPA-Fraunhofer-Institute according to SEMI E78-0998 for the E6 standard material
Assembly Tips

To close, push and click shut

Other Installation Methods

Vertical, hanging ≤ 164 ft (50 m)

Vertical, standing ≤ 6.56 ft (2 m)

Side-mounted, un supp. =

possible to a limited extent

Unsupported length of upper run upon request

Usage Guidelines



- If a low-noise version is required
- For very high speeds and/or accelerations
- If large stresses and thrust forces are present
- For small bending radii
- If less vibration is required
- Minimal abrasion, suitable for cleanrooms



- For side mounted applications
 - **Series E4-56 E4-1**
- For RBR (Reverse Bending Radius)
 - **Series E4-56 E4-1**
- For high additional loads
 - **Series E4-56 E4-1**
- For dirty environments
 - **Series E4-56 E4-1**

Features & Benefits

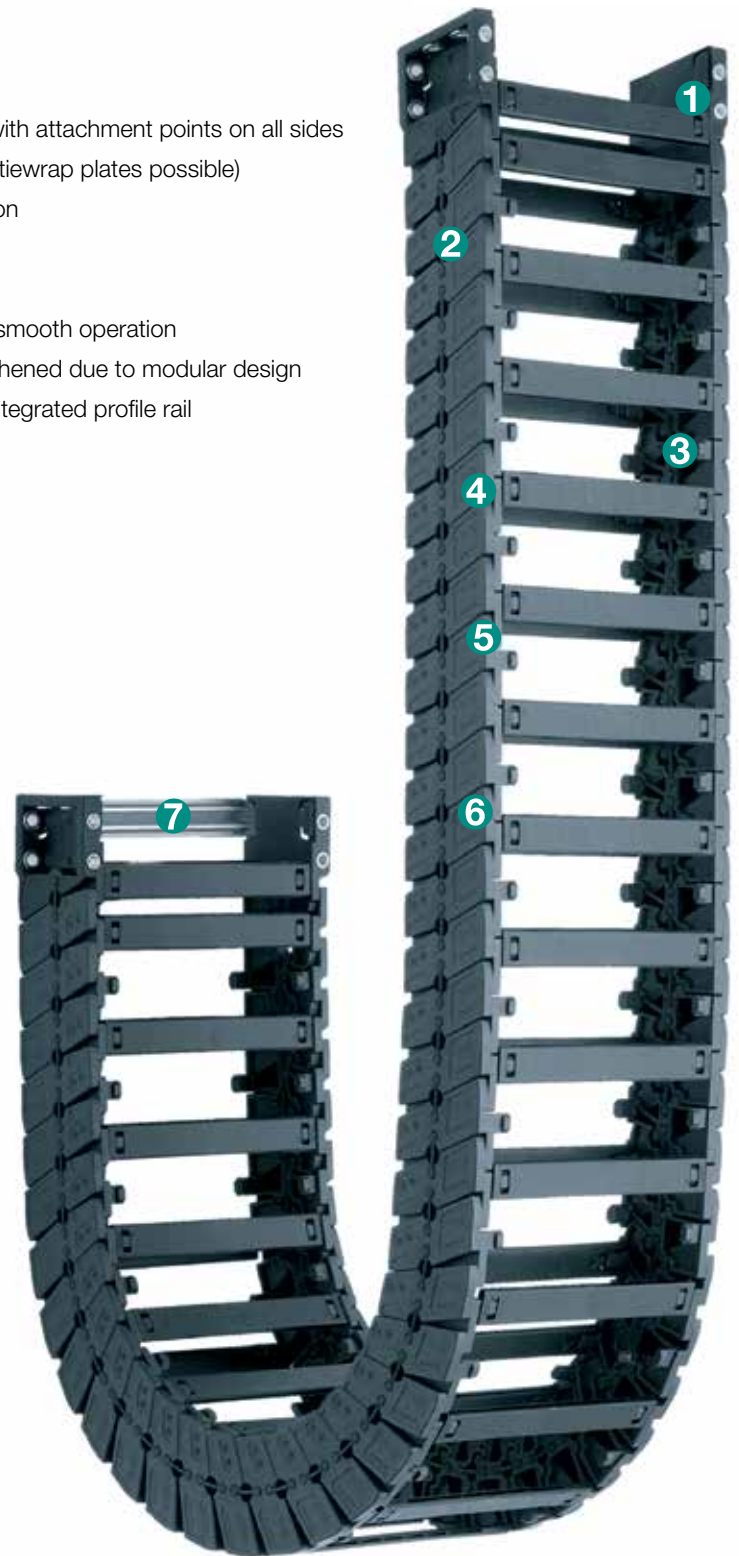
- ➊ KMA mounting brackets with attachment points on all sides (strain relief with separate tie-wrap plates possible)
- ➋ No pin and bore connection
- ➌ Interior stop dog
- ➍ Very large gliding surfaces
- ➎ Small pitch for low-noise, smooth operation
- ➏ Can be shortened or lengthened due to modular design
- ➐ Available with or without integrated profile rail

Order Example: Complete e-chain®

Please indicate chain length or number of links. Example:

 6.56 ft (2 m) **E6-52-100-175-0**

e-chain®

 With 2 separators **38222** assembled every 2nd link

Interior Separation

 1 Set **E6-520-100-12**

Mounting Bracket

e-chain system® E6

Series E6-52

Installation Dimensions

Short travel, unsupported length

- FL_B = unsupported with permitted sag
 - FL_G = unsupported with straight upper run
- Further information ► Design, Chapter 1

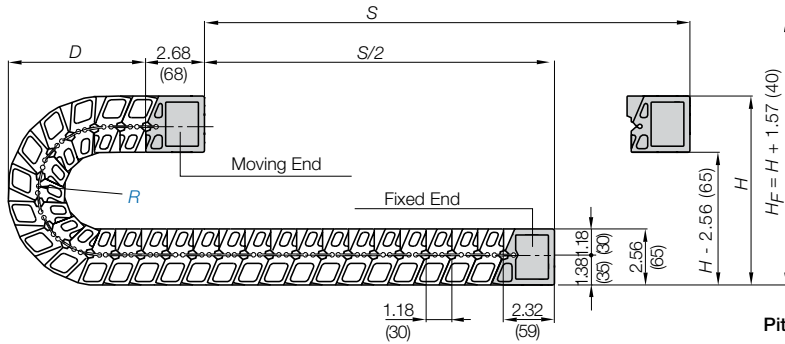
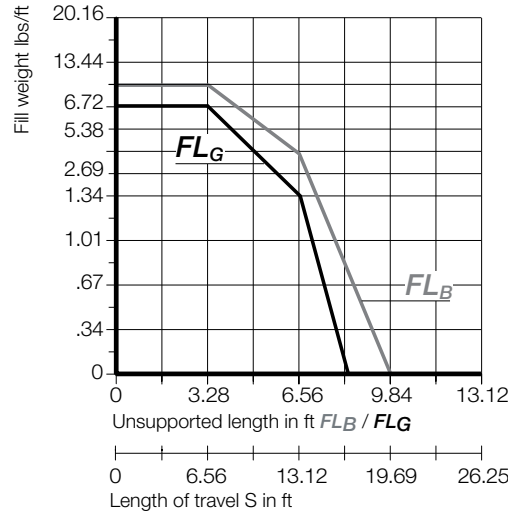
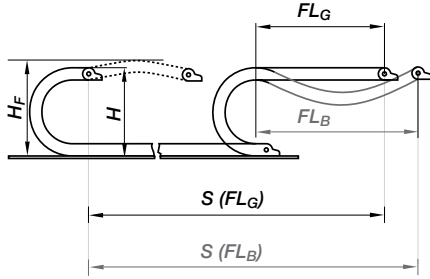

The required clearance height: $H_F = H + 1.57$ in. (40 mm) (with 1.34 lbs/ft (2.0 kg/m) fill weight. Please consult igus® if space is particularly restricted.

Pitch per link = 1.18" (30 mm)
 Links per ft (m) = 10.17 (34)
 For center mount applications:
 Chain length = $\frac{S}{2} + K$

R	2.95 (075)	3.94 (100)	5.91 (150)	7.87 (200)	9.84 (250)
H	10.63 (270)	12.60 (320)	16.54 (420)	20.47 (520)	24.41 (620)
D	6.10 (155)	7.09 (180)	9.06 (230)	11.02 (280)	12.99 (330)
K	11.81 (300)	14.76 (375)	21.06 (535)	27.17 (690)	33.46 (850)



E6-52

Short Travels - Unsupported



Unsupported e-chains® feature positive camber over short travels. This must be accounted for when specifying the clearance height. Please refer to **Installation dimensions** for further details.

Legend

- S = Length of travel
- R = Bending radius
- H = Nominal clearance height
- D = Overlength e-chain® radius in final position
- $K = \pi \cdot R + \text{safety buffer}$
- H_F = Required clearance height
- H_{in} = Trough inner height
- H_2 = *Mounting height
- D_2 = Overlength - long travels, gliding
- K_2 = *Add-on

*If the mounting bracket location is set lower

2.05

PDF: igus.com/e-chain-pdfs
 Product information: igus.com/e-chains



Speed / acceleration FL_G	max. 65.6 ft/s (20 m/s) / max. 656 ft/s ² (200 m/s ²)
Speed / acceleration FL_B	max. 9.84 ft/s (3 m/s) / max. 19.69 ft/s ² (6 m/s ²)
Gliding speed / acceleration (maximum)	upon request
Permitted temperature	-40°F (-40°C) up to +158°F (+70° C)
Flammability Class	VDE 0304 IIC UL94 HB

Technical Data



Details of material properties

► Design, Chapter 1

Series E6-52 - e-chain® with crossbars every other link

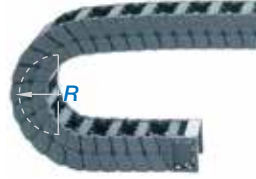
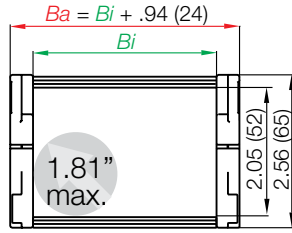

Part Number Structure

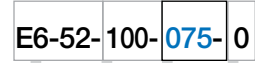

- Color - Black
- Bending radius
- Width
- Series



e-chain® as separate parts, side links and crossbars

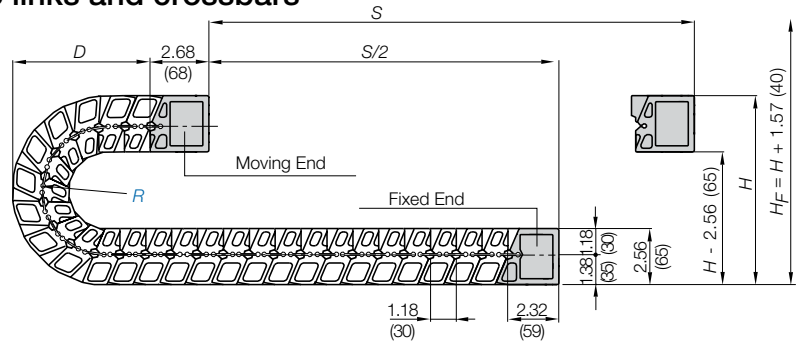
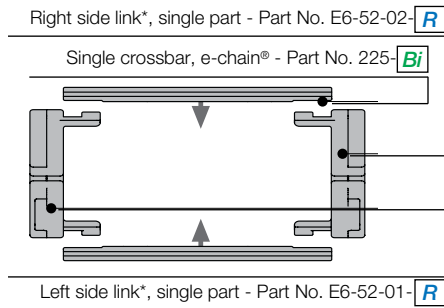

Polymer spring as single part -
Part No. E6-52-195

*View from the fixed point of the e-chain®/E-Tube

Supplement part number with required radius. Example: E6-52-100-075-0
Pitch: 1.18 in. (30 mm) per link links/ft (m) = 10.36 (34)

Part Number	Bi in. (mm)	Ba in. (mm)	Weight lbs/ft (kg/m)
E6-52-040- -0	1.57 (40)	2.51 (64)	≈1.18 (1.76)
E6-52-050- -0	1.97 (50)	2.91 (74)	≈1.21 (1.80)
E6-52-052- -0	2.05 (52)	2.60 (66)	≈1.22 (1.81)
E6-52-062- -0	2.44 (62)	3.39 (86)	≈1.24 (1.84)
E6-52-070- -0	2.76 (70)	3.70 (94)	≈1.26 (1.87)
E6-52-075- -0	2.95 (75)	3.90 (99)	≈1.27 (1.89)
E6-52-087- -0	3.42 (87)	4.37 (111)	≈1.30 (1.94)
E6-52-100- -0	3.94 (100)	4.88 (124)	≈1.33 (1.98)
E6-52-125- -0	4.92 (125)	5.87 (149)	≈1.39 (2.07)
E6-52-150- -0	5.91 (150)	6.85 (174)	≈1.46 (2.17)
E6-52-175- -0	6.89 (175)	7.83 (199)	≈1.52 (2.26)
E6-52-200- -0	7.87 (200)	8.82 (224)	≈1.59 (2.36)
E6-52-225- -0	8.86 (225)	9.80 (249)	≈1.65 (2.45)
E6-52-250- -0	9.84 (250)	10.79 (274)	≈1.71 (2.54)
E6-52-275- -0	10.83 (275)	11.77 (299)	≈1.77 (2.64)
E6-52-300- -0	11.81 (300)	12.76 (324)	≈1.83 (2.73)

Choose from the radii below for all of the above sizes

Radius (mm) Example: E6-52-100-075-0

	075	100	150	200	250
R	2.95 (75)	3.94 (100)	5.91 (150)	7.87 (200)	9.84 (250)
H	10.63 (270)	12.60 (320)	16.54 (420)	20.47 (520)	24.41 (620)
D	6.10 (155)	7.09 (180)	9.06 (230)	11.02 (280)	12.99 (330)
K	11.81 (300)	14.76 (375)	21.06 (535)	27.17 (690)	33.46 (850)

e-chain system® E6
 Series E6-52
 Interior Separation - New Generation



E6-52

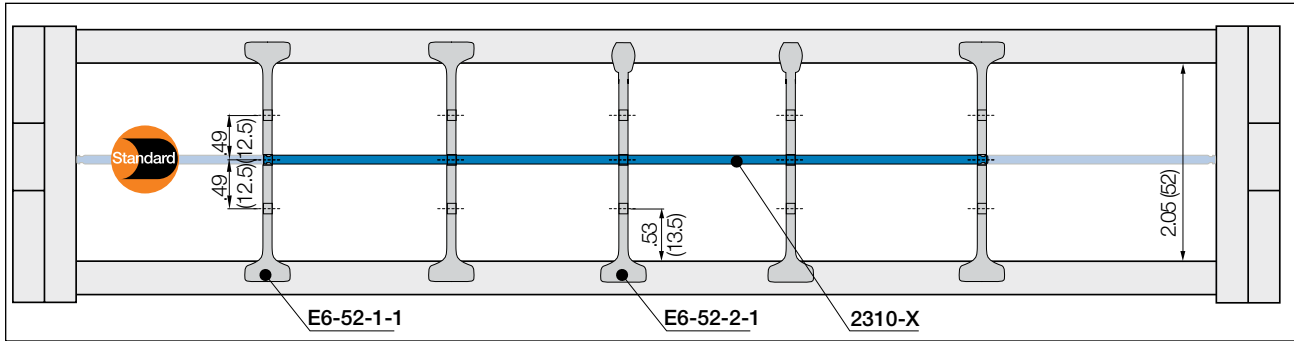

No lateral spacing between the separators and the side links is necessary.
 In the standard configuration separators are assembled every 2nd e-chain® link

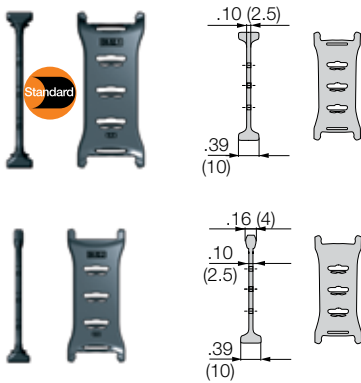

Separator, wide base
 Unassembled Part No. E6-52-1
 Assembled Part No. E6-52-1-1

- **Standard separator E6-52-1 for all applications**
 Separator with wide base for maximum locking strength and safe standing in e-chains®.

Separator, narrow head
 Unassembled Part No. E6-52-2
 Assembled Part No. E6-52-2-1

- **Separator E6-52-2 For even faster installation**
 Firmly holds to one side with a wide base, narrow on opposite side for easy cable assembly (slight grip).

Lockable full-width shelves - for the standard interior separation

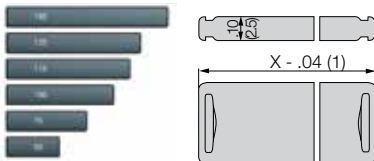

Full width shelf, lockable
 Unassembled Part No. 2300-X
 Assembled Part No. 2310-X

- **Full width shelf, lockable**
 Shelf locks safely into separators on both ends, fixed width possible. Separators can be moved freely over the shelf horizontally. Can be arranged at three different heights.

Width X in. (mm)	Part No. Unassembled	Part No. Assembled	Width X in. (mm)	Part No. Unassembled	Part No. Assembled	Width X in. (mm)	Part No. Unassembled	Part No. Assembled
0.59 (015)	2300-15	2310-15	2.36 (060)	2300-60	2310-60	3.43 (087)	2300-87	2310-87
0.98 (025)	2300-25	2310-25	2.44 (062)	2300-62	2310-62	3.54 (090)	2300-90	2310-90
1.18 (030)	2300-30	2310-30	2.56 (065)	2300-65	2310-65	3.94 (100)	2300-100	2310-100
1.50 (038)	2300-38	2310-38	2.76 (070)	2300-70	2310-70	4.06 (103)	2300-103	2310-103
1.57 (040)	2300-40	2310-40	2.95 (075)	2300-75	2310-75	4.33 (110)	2300-110	2310-110
1.97 (050)	2300-50	2310-50	3.03 (077)	2300-77	2310-77	4.72 (120)	2300-120	2310-120
2.24 (057)	2300-57	2310-57	3.15 (080)	2300-80	2310-80	4.92 (125)	2300-125	2310-125

PDF: igus.com/e-chain-pdfs
 Product information: igus.com/e-chains



Vertical separators and spacers

Vertical separators are used if a vertical subdivision of the e-chain® interior is required. By standard, vertical separators are assembled every other e-chain® link.

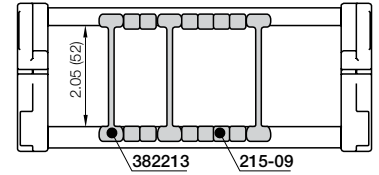

● **Vertical separator**

This separator is used for general subdivision of e-chains®.

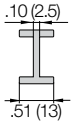

Vertical Separator

Unassembled	Part No. 382212
Assembled	Part No. 382213

● **Spacer**

Used when a broad distance needs to be maintained between the separators. Generally used in side-mounted applications



Spacer

Unassembled	Part No. 205-09
Assembled	Part No. 215-09

Full-width shelf

For applications involving many thin cables with similar or identical diameters. Slotted separator **38226** and **38229** can be used in combination with full-width shelf **321-X**. Locking vertical separator **382215** can also be used with full-width shelf **221-X**.

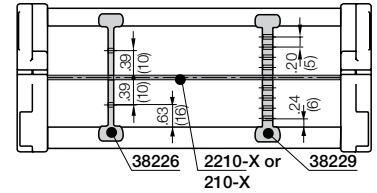

Width X in. (mm)	Part No. Unassembled		Part No. Assembled	
	220-X	320-X	221-X	321-X
1.57 (040)	220-40	320-40	221-40	321-40
1.97 (050)	220-50	320-50	221-50	321-50
2.44 (062)	220-62	320-62	221-62	321-62
2.76 (070)	220-70	320-70	221-70	321-70
2.95 (075)	220-75	320-75	221-75	321-75
3.43 (087)	220-87	320-87	221-87	321-87
3.94 (100)	220-100	320-100	221-100	321-100
4.92 (125)	220-125	320-125	221-125	321-125
5.91 (150)	220-150	320-150	221-150	321-150
6.89 (175)	220-175	320-175	221-175	321-175
7.87 (200)	220-200	320-200	221-200	321-200

Shelves 220-X/320-XX
Shelves can be inserted at 9 different heights in .20" (5mm) increments

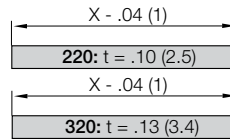

● **Vertical separator, slotted**

This separator is used for general subdivision of e-chains®. Can be used in combination with full-width shelf 321-X.

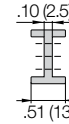

Vertical Separator, slotted

Unassembled	Part No. 38225
Assembled	Part No. 38226

● **Locking vertical separator**

This separator is used for general subdivision of e-chains®.

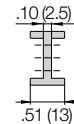

Locking Vertical Separator

Unassembled	Part No. 38228
Assembled	Part No. 38229

Shelves

These components form the basic pattern of a shelf system. Shelves of various widths can be arranged at 9 different heights in .20" (5mm) increments

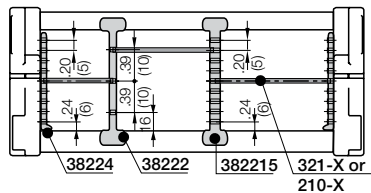

Shelves 2200-XX

Shelf **2210-X** can be used with vertical separator **38222**, locking separator **382215** and side plate **38224**.

Locking vertical separator **382215** can also be used with full-width shelf **221-X**.

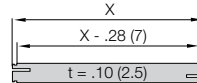

Width X in. (mm)	Part No.		Width X in. (mm)	Part No.	
	Unassembled	Assembled		Unassembled	Assembled
.71 (18)	2200-18	2210-18	2.28 (58)	2200-58	2210-58
.91 (23)	2200-23	2210-23	2.28 (63)	2200-65	2210-65
1.10 (28)	2200-28	2210-28	2.68 (68)	2200-68	2210-68
1.30 (33)	2200-33	2210-33	2.87 (73)	2200-73	2210-73
1.50 (38)	2200-38	2210-38	3.46 (88)	2200-88	2210-88
1.69 (43)	2200-43	2210-43	3.90 (99)	2200-99	2210-99
1.89 (48)	2200-48	2210-48			

● **Locking vertical separator**

This separator is used when higher retention force is needed.

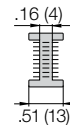

Locking Vertical Separator

Unassembled	Part No. 382214
Assembled	Part No. 382215

● **Side plate**

This separator is used for general subdivision of e-chains®.

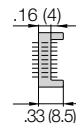

Side Plate

Unassembled	Part No. 38223
Assembled	Part No. 38224

● **Vertical separator, slotted**

Can be used in combination with full-width shelf 321-X.

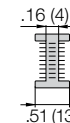

Vertical Separator, Slotted

Unassembled	Part No. 38221
Assembled	Part No. 38222



Option 1: KMA - Pivoting

- Option - profile rail with integrated strain relief chainfix clip or tiwrap plates
- Profile rail can be mounted in the inner or outer radius of the e-chain®
- Bolted connection outside of the chain cross-section
- Recommended for unsupported applications (for gliding applications please contact igus®)
- Confined installation conditions
- Attachment capability on all sides



Adapters for gliding applications available upon request

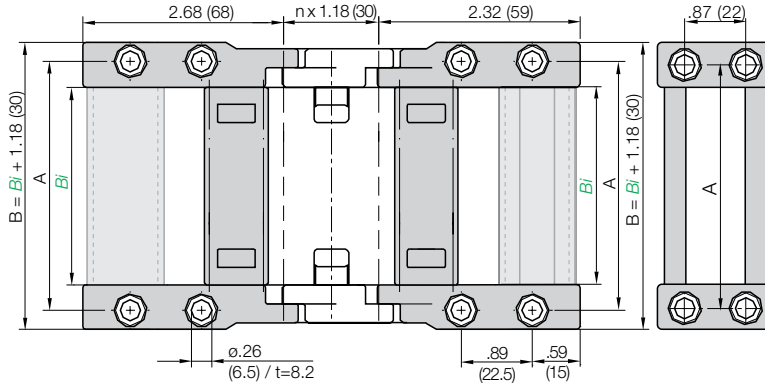
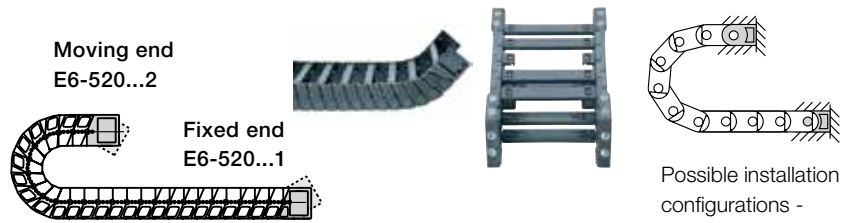

For Series	Part No. Full Set Without Profile Rail	Part No. Full Set With Profile Rail	Dimension A		Dimension B	
			in.	(mm)	in.	(mm)
E6-52-040	E6-520-040-12	E6-520-040-12P	2.20	(56)	2.76	(70)
E6-52-050	E6-520-050-12	E6-520-050-12P	2.60	(66)	3.15	(80)
E6-52-052	E6-520-052-12	E6-520-052-12P	2.68	(68)	3.23	(82)
E6-52-062	E6-520-062-12	E6-520-062-12P	3.07	(78)	3.62	(92)
E6-52-070	E6-520-070-12	E6-520-070-12P	3.39	(86)	3.94	(100)
E6-52-075	E6-520-075-12	E6-520-075-12P	3.58	(91)	4.13	(105)
E6-52-087	E6-520-087-12	E6-520-087-12P	4.06	(103)	4.61	(117)
E6-52-100	E6-520-100-12	E6-520-100-12P	4.57	(116)	5.12	(130)
E6-52-125	E6-520-125-12	E6-520-125-12P	5.55	(141)	6.10	(155)
E6-52-150	E6-520-150-12	E6-520-150-12P	6.54	(166)	7.09	(180)
E6-52-175	E6-520-175-12	E6-520-175-12P	7.52	(191)	8.07	(205)
E6-52-200	E6-520-200-12	E6-520-200-12P	8.50	(216)	9.06	(230)
E6-52-225	E6-520-225-12	E6-520-225-12P	9.49	(241)	10.04	(255)
E6-52-250	E6-520-250-12	E6-520-250-12P	10.47	(266)	11.02	(280)
E6-52-275	E6-520-275-12	E6-520-275-12P	11.46	(291)	11.81	(300)
E6-52-300	E6-520-300-12	E6-520-300-12P	12.44	(316)	12.99	(330)

Part Number Structure

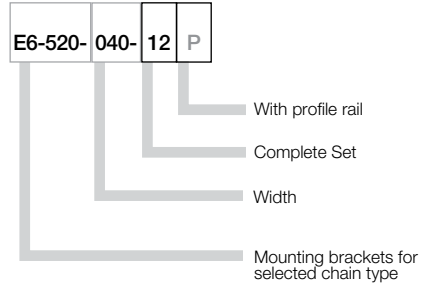

Full set, for both ends:

E6-520-040-12 Full set, both fixed and moving end

Single-part order:
E6-520-040-1

Mounting bracket fixed end

E6-520-040-2

Mounting bracket moving end

Tiewrap Plates

Option 1:

Tiewrap plates as an individual part

Available as an individual component, can be fixed onto a mounting bracket with the use of a profile rail.

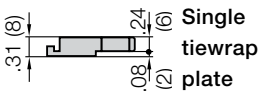
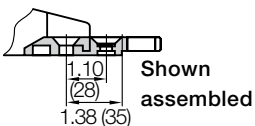

Tiewrap Plate	n Number of Teeth	C Overall Width in. (mm)	B Bore Width in. (mm)	Center Bore
3050-ZB	5	1.97 (50)	1.18 (30)	no
3075-ZB	7	2.95 (75)	2.16 (55)	no
3100-ZB	10	3.94 (100)	3.15 (80)	no
3115-ZB	11	4.53 (115)	3.74 (95)	no
3125-ZB	12	4.92 (125)	4.13 (105)	no
3150-ZB	15	5.91 (150)	5.12 (130)	no
3175-ZB	17	6.89 (175)	6.10 (155)	no
3200-ZB	20	7.87 (200)	7.09 (180)	yes
3225-ZB	22	8.86 (225)	8.07 (205)	yes
3250-ZB	25	9.84 (250)	9.06 (230)	yes

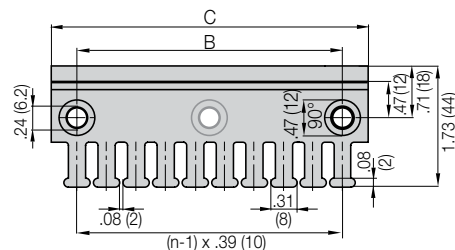

If used with KMA brackets with profile rail please add "KMA" to the end of the part number.

Example: 3050-ZBKMA

Other strain relief elements

► **Strain Relief, Chapter 10**



Price Index



Series R6-52

Special Features / Options



Extremely low noise
Test results upon request



IPA Certificate: Class 1, according to standard DIN EN ISO 14644-1 for the E6 system (Series E6-29-060-150-0-CR, (v = 1.64 ft/s, a = 3.28 ft/s²))



LEVEL 1 absorption confirmed by IPA-Fraunhofer-Institute according to SEMI E78-0998 for the E6 standard material

Assembly Tips



Lever and remove lids

Other Installation Methods

Vertical, hanging ≤ 164 ft (50 m)

Vertical, standing ≤ 6.56 ft (2 m)

Side-mounted, unsupp. =

possible to a limited extent

Unsupported length of upper run upon request

Usage Guidelines



- If a low-noise version is required
- For very high speeds and/or accelerations
- If large stresses and thrust forces are present
- Protection against dirt and chips
- For small bending radii
- If less vibration is required
- Minimal abrasion, suitable for cleanrooms



- For side mounted applications
➤ Series R4-56 E4-1

Features & Benefits

- 1 KMA mounting brackets with attachment points on all sides
- 2 Very large gliding surfaces
- 3 Smooth, cable protecting inner chamber
- 4 Continuous glide surfaces
- 5 Interior stop dog
- 6 Small pitch for low-noise, smooth operation
- 7 Available with or without integrated profile rail
- 8 Can be shortened or lengthened due to modular design
- 9 No pin and bore connection
- 10 Fully enclosed E-Tube

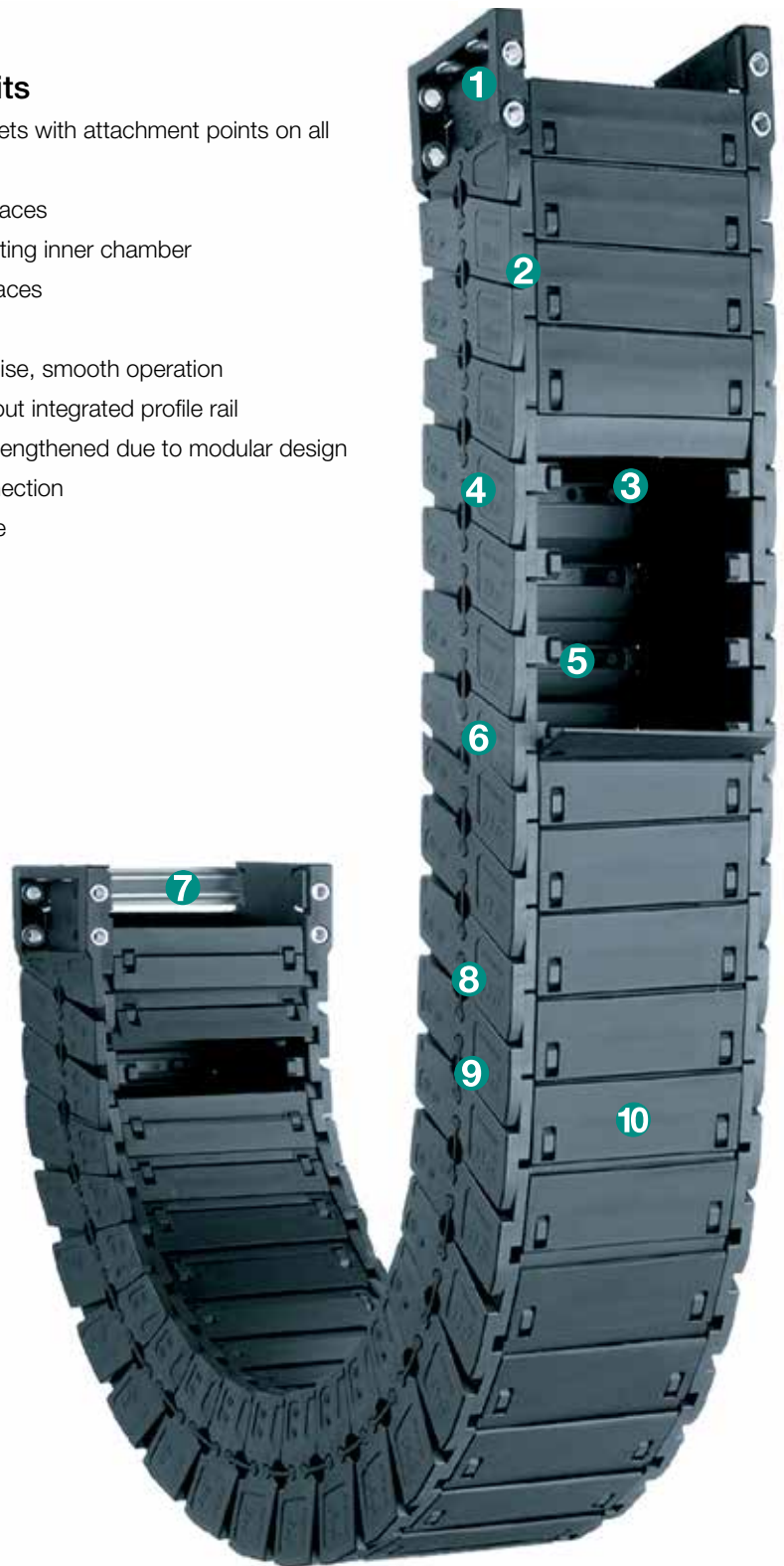

Order Example: Complete e-chain®

Please indicate chain length or number of links. Example:

6.56 ft (2 m) R6-52-100-075-0



e-chain®

With 2 separators R6-52-11 assembled every 2nd link



Interior Separation

1 Set R6-520-100-12



Mounting Bracket

e-chain system® E6

Series R6-52

Installation Dimensions

Short travel, unsupported length

- FL_B = unsupported with permitted sag
 - FL_G = unsupported with straight upper run
- Further information ► Design, Chapter 1

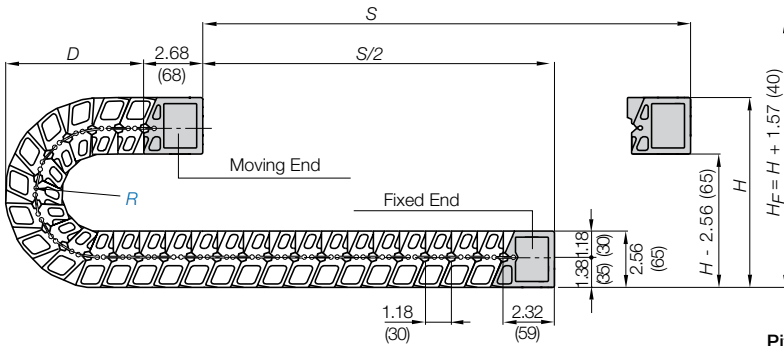
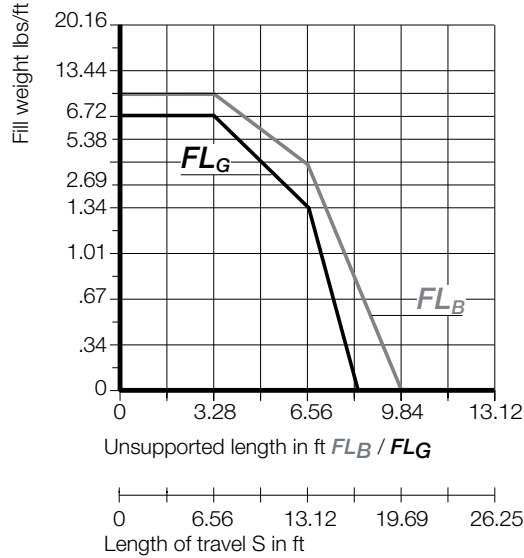
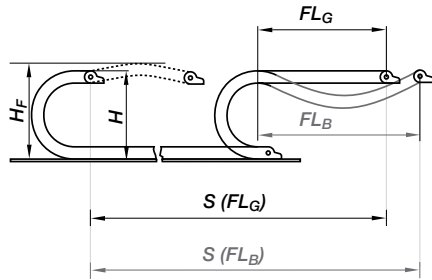

The required clearance height: $H_F = H + 1.57$ in. (40 mm) (with 1.34 lbs/ft (2.0 kg/m) fill weight. Please consult igus® if space is particularly restricted.

R	2.95 (075)	3.94 (100)	5.91 (150)	7.87 (200)	9.84 (250)
H	10.63 (270)	12.60 (320)	16.54 (420)	20.47 (520)	24.41 (620)
D	6.10 (155)	7.09 (180)	9.06 (230)	11.02 (280)	12.99 (330)
K	11.81 (300)	14.76 (375)	21.06 (535)	27.17 (690)	33.46 (850)

Pitch per link: = 1.18" (30 mm)
 Links per ft (m): = 10.17 (34)
 For center mount applications:
 Chain length = $S/2 + K$



R6-52

Short Travels - Unsupported



Unsupported e-chains® feature positive camber over short travels. This must be accounted for when specifying the clearance height. Please refer to **Installation dimensions** for further details.

Legend

- S = Length of travel
- R = Bending radius
- H = Nominal clearance height
- D = Overlength e-chain® radius in final position
- $K = \pi \cdot R + \text{safety buffer}$
- H_F = Required clearance height
- H_{in} = Trough inner height
- H_2 = *Mounting height
- D_2 = Overlength - long travels, gliding
- K_2 = *Add-on

*If the mounting bracket location is set lower

2.05

PDF: igus.com/e-chain-pdfs
 Product information: igus.com/e-chains



Speed / acceleration FL_G	max. 65.6 ft/s (20 m/s) / max. 656 ft/s ² (200 m/s ²)
Speed / acceleration FL_B	max. 9.84 ft/s (3 m/s) / max. 19.69 ft/s ² (6 m/s ²)
Gliding speed / acceleration (maximum)	upon request
Permitted temperature	-40°F (-40°C) up to +158°F (+70° C)
Flammability Class	VDE 0304 IIC UL94 HB

Technical Data



Details of material properties

► Design, Chapter 1

7.104

Series R6-52 - e-chain® with lids

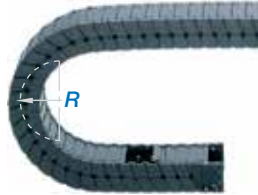
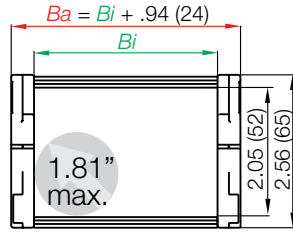

Part Number Structure

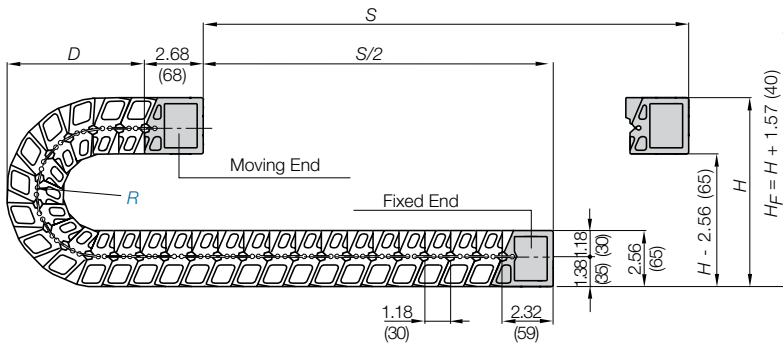
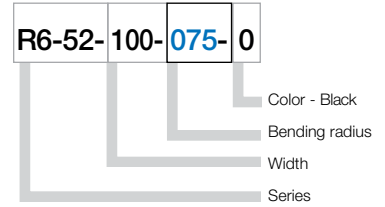

Supplement part number with required radius. Example: R6-52-100-075-0
Pitch: 1.18 in. (30 mm) per link links/ft (m) = 10.36 (34)

Part Number	Bi in. (mm)	Ba in. (mm)	Weight lbs/ft (kg/m)
R6-52-050- <input type="text"/> -0	1.97 (50)	2.91 (74)	≈1.27 (1.89)
R6-52-075- <input type="text"/> -0	2.95 (75)	3.90 (99)	≈1.42 (2.12)
R6-52-100- <input type="text"/> -0	3.94 (100)	4.88 (124)	≈1.58 (2.35)
R6-52-125- <input type="text"/> -0	4.92 (125)	5.87 (149)	≈1.73 (2.57)
R6-52-150- <input type="text"/> -0	5.91 (150)	6.85 (174)	≈1.88 (2.80)
R6-52-175- <input type="text"/> -0	6.89 (175)	7.83 (199)	≈2.04 (3.03)

Choose from the radii below for all of the above sizes
Radius (mm) Example: R6-52-100-075-0

	075	100	150	200	250
R	2.95 (75)	3.94 (100)	5.91 (150)	7.87 (200)	9.84 (250)
H	10.63 (270)	12.60 (320)	16.54 (420)	20.47 (520)	24.41 (620)
D	6.10 (155)	7.09 (180)	9.06 (230)	11.02 (280)	12.99 (330)
K	11.81 (300)	14.76 (375)	21.06 (535)	27.17 (690)	33.46 (850)

Option 1: Vertical separators

Vertical separators are used if a vertical subdivision of the e-chain® interior is required. By standard, vertical separators are assembled every other e-chain® link.

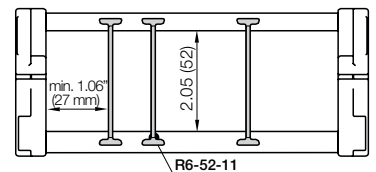

Vertical separator R6-52-01

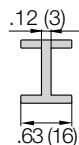

Vertical Separator

Unassembled Part No. R6-52-01

Assembled Part No. R6-52-11

- Vertical separator R6-52-01
This separator is used for general subdivision of E-Tubes.
- Separator snaps onto either the bottom of the carrier or the lid. Stays attached to that side. Opposite side can be removed.

e-chain system® E6

Series R6-52

Mounting Bracket



R6-52



Option 1: KMA - Pivoting

- Option - profile rail with integrated strain relief chainfix clip or tiwrap plates
- Profile rail can be mounted in the inner or outer radius of the e-chain®
- Bolted connection outside of the chain cross-section
- Recommended for unsupported applications (for gliding applications please contact igus®)
- Confined installation conditions
- Attachment capability on all sides

Moving end
R6-520...2

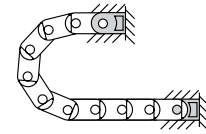
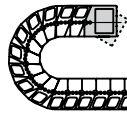

Possible installation configurations -

Fixed end
E6-520...1

Part Number Structure

R6-520-	040-	12	P
---------	------	----	---

With profile rail
Complete Set
Width

Mounting brackets for selected chain type

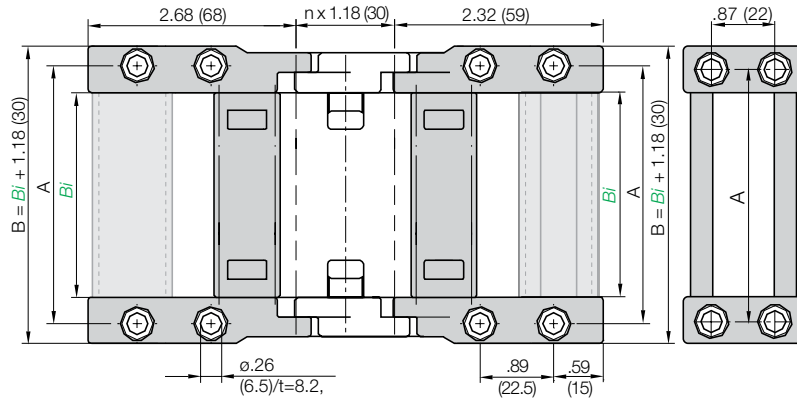

For Series	Part No. Full Set Without Profile Rail	Part No. Full Set With Profile Rail	Dimension A in. (mm)	Dimension B in. (mm)
R6-52-050	R6-520-050-12	R6-520-050-12P	2.60 (66)	3.15 (80)
R6-52-075	R6-520-075-12	R6-520-075-12P	3.58 (91)	4.13 (105)
R6-52-100	R6-520-100-12	R6-520-100-12P	4.57 (116)	5.12 (130)
R6-52-125	R6-520-125-12	R6-520-125-12P	5.55 (141)	6.10 (155)
R6-52-150	R6-520-150-12	R6-520-150-12P	6.54 (166)	7.09 (180)
R6-52-175	R6-520-175-12	R6-520-175-12P	7.52 (191)	8.07 (205)

Full set, for both ends:

R6-520- 040- 12 Full set, both fixed and moving end

Single-part order:

R6-520 - 040- 1

Mounting bracket fixed end

R6-520 - 040- 2

Mounting bracket moving end

Tiewrap Plates

Option 1: Tiewrap plates as an individual part

Available as an individual component, can be fixed onto a mounting bracket with the use of a profile rail.

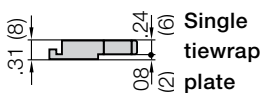
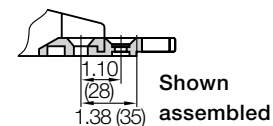

Tiewrap Plate	n Number of Teeth	C Overall Width in. (mm)	B Bore Width in. (mm)	Center Bore
3050-ZB	5	1.97 (50)	1.18 (30)	no
3075-ZB	7	2.95 (75)	2.16 (55)	no
3100-ZB	10	3.94 (100)	3.15 (80)	no
3115-ZB	11	4.53 (115)	3.74 (95)	no
3125-ZB	12	4.92 (125)	4.13 (105)	no
3150-ZB	15	5.91 (150)	5.12 (130)	no
3175-ZB	17	6.89 (175)	6.10 (155)	no
3200-ZB	20	7.87 (200)	7.09 (180)	yes
3225-ZB	22	8.86 (225)	8.07 (205)	yes
3250-ZB	25	9.84 (250)	9.06 (230)	yes

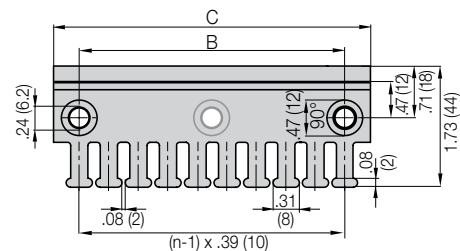

If used with KMA brackets with profile rail please add "KMA" to the end of the part number.

Example: 3050-ZBKMA

Other strain relief elements
► Strain Relief, Chapter 10

PDF: igus.com/e-chain-pdfs
Product information: igus.com/e-chains



Price Index

Series E6-62

Special Features / Options



Extremely low noise
Test results upon request



IPA Certificate: Class 1, according to standard DIN EN ISO 14644-1 for the E6 system (Series E6-29-060-150-0-CR, (v = 1.64 ft/s, a = 3.28 ft/s²))

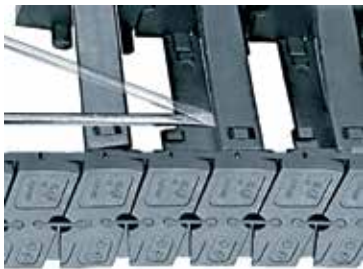

LEVEL 1 absorption confirmed by IPA-Fraunhofer-Institute according to SEMI E78-0998 for the E6 standard material

Assembly Tips

To close, push and click shut

Other Installation Methods

Vertical, hanging ≤ 196.8 ft (60 m)

Vertical, standing ≤ 9.84 ft (3 m)

Side-mounted, un supp. =

possible to a limited extent

Unsupported length of upper run upon request

Usage Guidelines



- If a low-noise version is required
- For very high speeds and/or accelerations
- If large stresses and thrust forces are present
- For small bending radii
- If less vibration is required
- Minimal abrasion, suitable for cleanrooms



- For side mounted applications
 - Series E4-56 E4-1
- For RBR (Reverse Bending Radius)
 - Series E4-56 E4-1
- For high additional loads
 - Series E4-56 E4-1
- For dirty environments
 - Series E4-56 E4-1

Features & Benefits

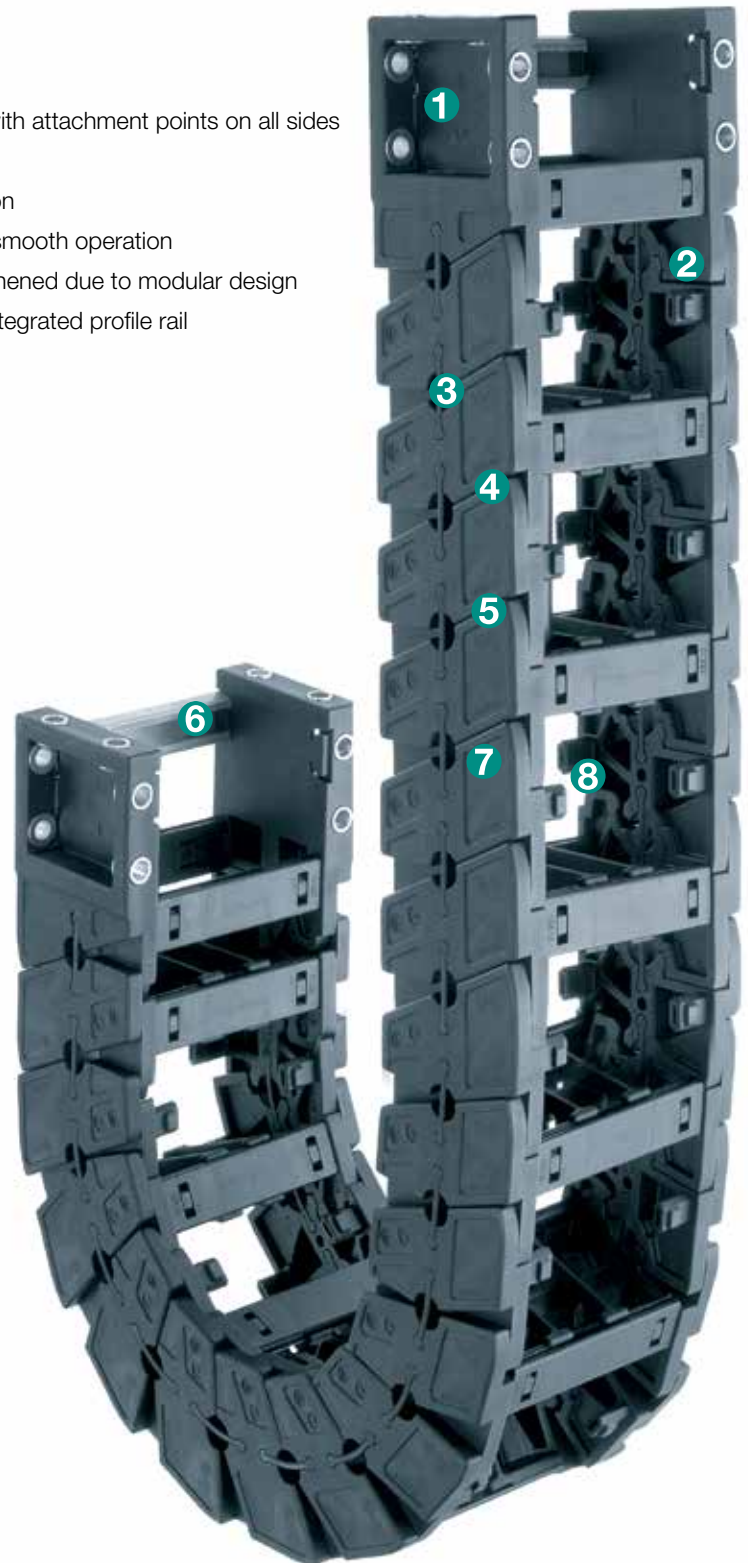
- 1 KMA mounting brackets with attachment points on all sides
- 2 Interior stop dog
- 3 No pin and bore connection
- 4 Small pitch for low-noise, smooth operation
- 5 Can be shortened or lengthened due to modular design
- 6 Available with or without integrated profile rail
- 7 Very large gliding surfaces
- 8 Increased inner height

Order Example: Complete e-chain®

Please indicate chain length or number of links. Example:

6.56 ft (2 m) **E6-62-10-200-0****e-chain®**With 2 separators **E6-62-11** assembled every 2nd link**Interior Separation**1 Set **E6-620-10-12P****Mounting Bracket**

e-chain system® E6

Series E6-62

Installation Dimensions

Short travel, unsupported length

- FL_B = unsupported with permitted sag
 - FL_G = unsupported with straight upper run
- Further information ► Design, Chapter 1

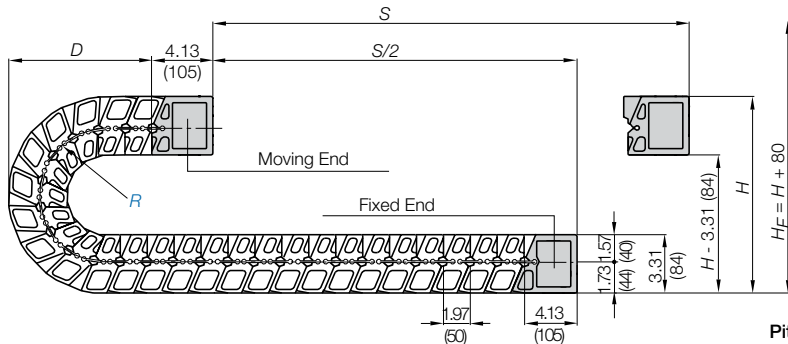
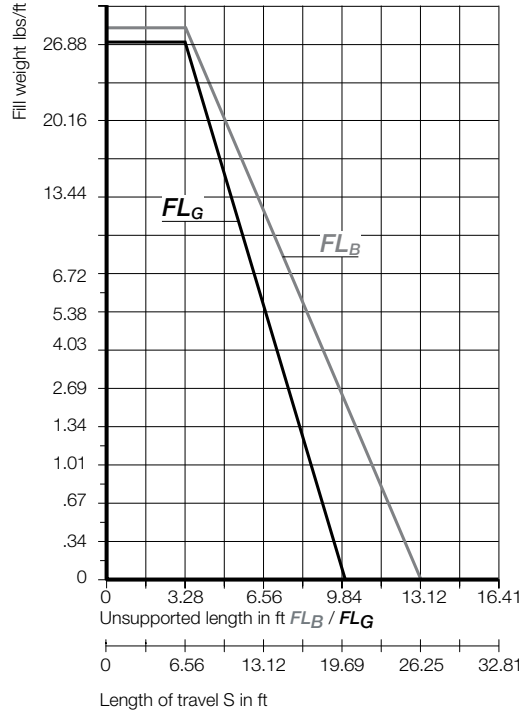
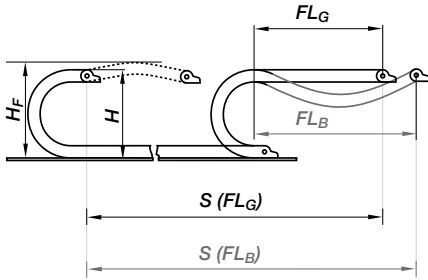

The required clearance height: $H_F = H + 3.15$ in. (80 mm) (with 1.34 lbs/ft (2.0 kg/m) fill weight. Please consult igus® if space is particularly restricted.

R	4.53 (115)	5.91 (150)	7.87 (200)	9.84 (250)	11.81 (300)	13.78 (350)
H	15.28 (388)	18.03 (458)	21.97 (558)	25.91 (658)	29.84 (758)	33.78 (858)
D	9.21 (234)	10.59 (269)	12.56 (319)	14.53 (369)	16.50 (419)	18.46 (469)
K	18.31 (465)	22.64 (575)	28.74 (730)	35.04 (890)	41.14 (1045)	47.24 (1200)

Pitch per link = 1.97" (50 mm)

Links per ft (m) = 6.1 (20)

For center mount applications:

Chain length = $\frac{S}{2} + K$

Short Travels - Unsupported

2.44



Unsupported e-chains® feature positive camber over short travels. This must be accounted for when specifying the clearance height. Please refer to **Installation dimensions** for further details.

Legend

- S = Length of travel
- R = Bending radius
- H = Nominal clearance height
- D = Overlength e-chain® radius in final position
- $K = \pi \cdot R + \text{safety buffer}$
- H_F = Required clearance height
- H_{in} = Trough inner height
- H_2 = *Mounting height
- D_2 = Overlength - long travels, gliding
- K_2 = *Add-on

*If the mounting bracket location is set lower



Speed / acceleration FL_G	max. 65.6 ft/s (20 m/s) / max. 656 ft/s ² (200 m/s ²)
Speed / acceleration FL_B	max. 9.84 ft/s (3 m/s) / max. 19.69 ft/s ² (6 m/s ²)
Gliding speed / acceleration (maximum)	upon request
Permitted temperature	-40°F (-40°C) up to +158°F (+70° C)
Flammability Class	VDE 0304 IIC UL94 HB

Technical Data



Details of material properties

► Design, Chapter 1

Series E6-62 - e-chain® with crossbars every other link

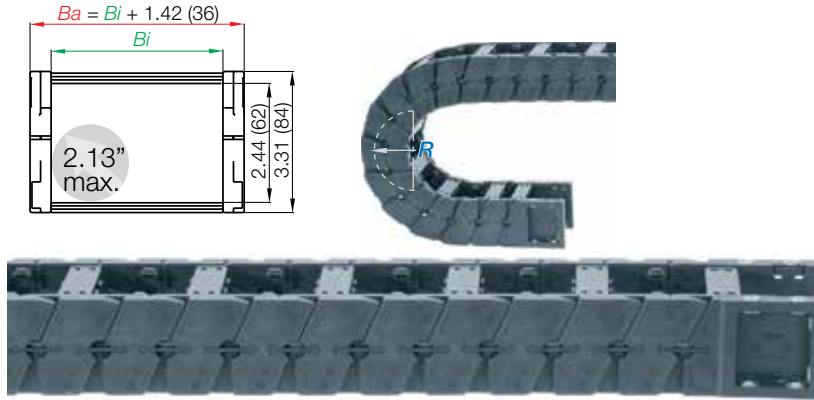

Part Number Structure

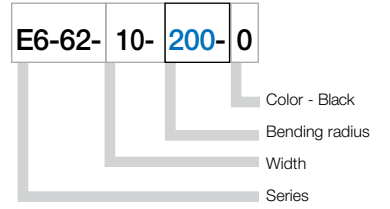

e-chain® as separate parts, links and side plates

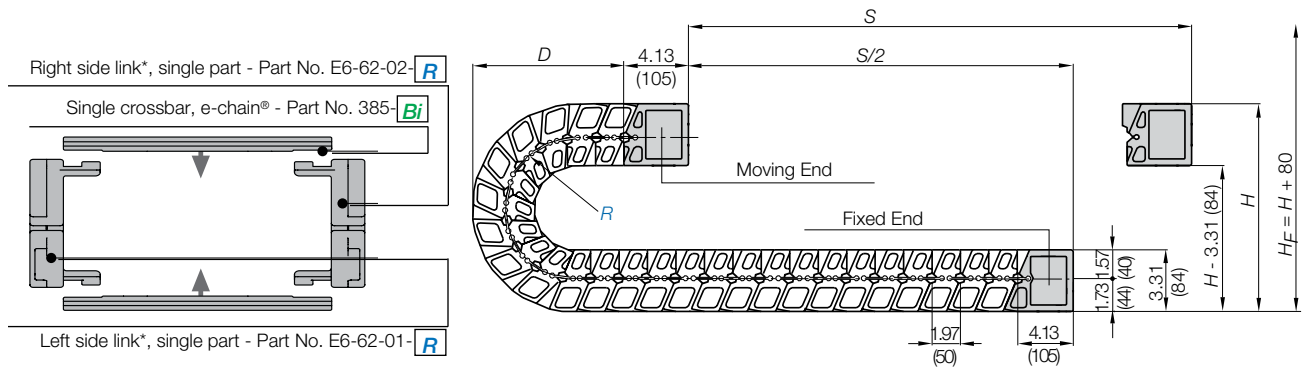

Polymer spring as single part -
Part No. E6-62-340

Supplement part number with required radius. Example: E6-62-10-200-0
Pitch: 1.97 in. (50 mm) per link links/ft (m) = 6.1 (20)

Part Number	Radius		Weight lbs/ft (kg/m)
	<i>Bi</i> in. (mm)	<i>Ba</i> in. (mm)	
E6-62-05- <input type="checkbox"/> -0	1.97 (50)	3.39 (86)	≈ 2.16 (3.22)
E6-62-06- <input type="checkbox"/> -0	2.67 (68)	4.09 (104)	≈ 2.20 (3.28)
E6-62-07- <input type="checkbox"/> -0	2.95 (75)	4.37 (111)	≈ 2.22 (3.31)
E6-62-087- <input type="checkbox"/> -0	3.43 (87)	4.84 (123)	≈ 2.25 (3.35)
E6-62-097- <input type="checkbox"/> -0	3.82 (97)	5.24 (133)	≈ 2.27 (3.38)
E6-62-10- <input type="checkbox"/> -0	3.94 (100)	5.35 (136)	≈ 2.28 (3.39)
E6-62-11- <input type="checkbox"/> -0	4.25 (108)	5.67 (144)	≈ 2.30 (3.42)
E6-62-112- <input type="checkbox"/> -0	4.41 (112)	5.83 (148)	≈ 2.30 (3.43)
E6-62-12- <input type="checkbox"/> -0	4.92 (125)	6.34 (161)	≈ 2.34 (3.48)
E6-62-137- <input type="checkbox"/> -0	5.39 (137)	6.81 (173)	≈ 2.37 (3.52)
E6-62-15- <input type="checkbox"/> -0	5.91 (150)	7.32 (186)	≈ 2.40 (3.57)
E6-62-162- <input type="checkbox"/> -0	6.38 (162)	7.80 (198)	≈ 2.43 (3.61)
E6-62-17- <input type="checkbox"/> -0	6.61 (168)	8.03 (204)	≈ 2.44 (3.63)
E6-62-18- <input type="checkbox"/> -0	6.89 (175)	8.31 (211)	≈ 2.45 (3.65)
E6-62-187- <input type="checkbox"/> -0	7.36 (187)	8.78 (223)	≈ 2.48 (3.69)
E6-62-20- <input type="checkbox"/> -0	7.87 (200)	9.29 (236)	≈ 2.51 (3.74)
E6-62-212- <input type="checkbox"/> -0	8.35 (212)	9.76 (248)	≈ 2.54 (3.78)
E6-62-23- <input type="checkbox"/> -0	8.86 (225)	10.28 (261)	≈ 2.57 (3.83)
E6-62-237- <input type="checkbox"/> -0	9.33 (237)	10.75 (273)	≈ 2.60 (3.87)
E6-62-25- <input type="checkbox"/> -0	9.84 (250)	11.26 (286)	≈ 2.63 (3.91)
E6-62-262- <input type="checkbox"/> -0	10.31 (262)	11.73 (298)	≈ 2.65 (3.95)
E6-62-28- <input type="checkbox"/> -0	10.83 (275)	12.24 (311)	≈ 2.69 (4.00)
E6-62-29- <input type="checkbox"/> -0	11.30 (287)	12.72 (323)	≈ 2.71 (4.04)
E6-62-30- <input type="checkbox"/> -0	11.81 (300)	13.23 (336)	≈ 2.75 (4.09)
E6-62-312- <input type="checkbox"/> -0	12.28 (312)	13.70 (348)	≈ 2.78 (4.13)
E6-62-325- <input type="checkbox"/> -0	12.80 (325)	14.21 (361)	≈ 2.80 (4.17)
E6-62-337- <input type="checkbox"/> -0	13.27 (337)	14.69 (373)	≈ 2.83 (4.21)
E6-62-350- <input type="checkbox"/> -0	13.78 (350)	15.20 (386)	≈ 2.86 (4.26)
E6-62-362- <input type="checkbox"/> -0	14.25 (362)	15.67 (398)	≈ 2.89 (4.30)
E6-62-375- <input type="checkbox"/> -0	14.76 (375)	16.18 (411)	≈ 2.92 (4.35)
E6-62-387- <input type="checkbox"/> -0	15.24 (387)	16.65 (423)	≈ 2.95 (4.39)
E6-62-400- <input type="checkbox"/> -0	15.75 (400)	17.16 (436)	≈ 2.98 (4.43)

Choose from the radii below for all of the above sizes

Radius (mm) Example: E6-62-10-200-0

	115	150	200	250	300	350
R	4.53 (115)	5.91 (150)	7.87 (200)	9.84 (250)	11.81 (300)	13.78 (350)
H	15.28 (388)	18.03 (458)	21.97 (558)	25.91 (658)	29.84 (758)	33.78 (858)
D	9.21 (234)	10.59 (269)	12.56 (319)	14.53 (369)	16.50 (419)	18.46 (469)
K	18.31 (465)	22.64 (575)	28.74 (730)	35.04 (890)	41.14 (1045)	47.24 (1200)

PDF: igus.com/e-chain-pdfs
Product information: igus.com/e-chains



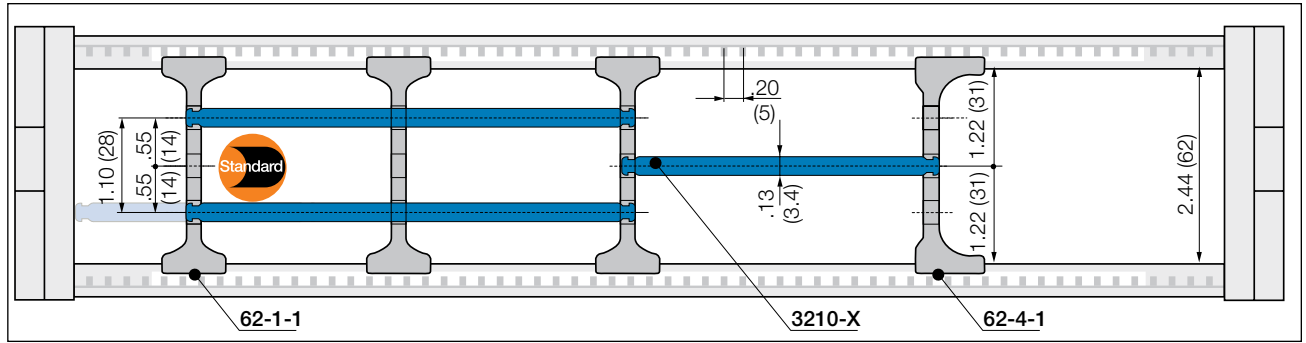

No lateral spacing between the separators and the side links is necessary.
 In the standard configuration separators are assembled every 2nd e-chain® link

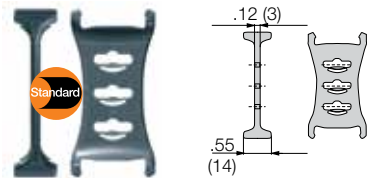

Separator, wide base

Unassembled	Part No. 62-1
Assembled	Part No. 62-1-1

- **Standard separator 62-1 for all applications**

Separator with wide base for maximum locking strength and safe standing in e-chains®.

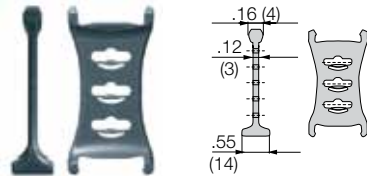

Separator for QuickLock crossbar

Unassembled	Part No. 62-2
Assembled	Part No. 62-2-1

- **Separator 62-2 For even faster installation**

Separator for QuickLock crossbar 385-X-Q. Firmly holds to one side with a wide base, narrow on opposite side for easy cable assembly (slight grip).

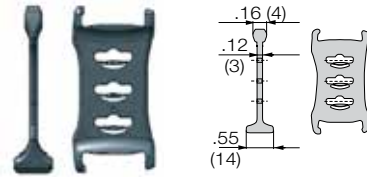

Notch separator for Notch crossbar

Unassembled	Part No. 62-5
Assembled	Part No. 62-5-1

- **Separator 62-5 Locks safely in .20" (5mm) increments**
 Notch separator for exact positioning in e-chains®. Recommended for side mounted applications.

Lockable full-width shelves - for the standard interior separation

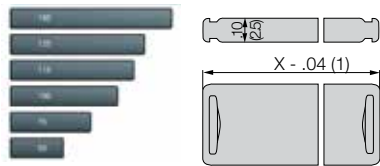

Full width shelf, lockable

Unassembled	Part No. 3200-X
Assembled	Part No. 3210-X

- **Full width shelf, lockable**
 Shelf locks safely into separators on both ends, fixed width possible. Separators can be moved freely over the shelf horizontally. Can be arranged at three different heights.

Width X in. (mm)	Part No. Unassembled	Part No. Assembled	Width X in. (mm)	Part No. Unassembled	Part No. Assembled
1.97 (050)	3200-50	3210-50	5.91 (150)	3200-150	3210-150
2.95 (075)	3200-75	3210-75	6.89 (175)	3200-175	3210-175
3.94 (100)	3200-100	3210-100	7.87 (200)	3200-200	3210-200
4.53 (115)	3200-115	3210-115	8.86 (225)	3200-225	3210-225
4.92 (125)	3200-125	3210-125	9.84 (250)	3200-250	3210-250

e-chain system® E6

Series E6-62

Interior Separation - Previous Generation



E6-62

Option 1: Vertical separators and spacers

Vertical separators are used if a vertical subdivision of the e-chain® interior is required. By standard, vertical separators are assembled every other e-chain® link.

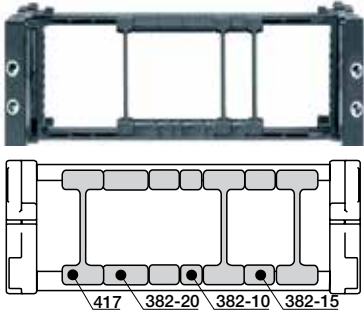

- Vertical separator**
 This separator is used for general subdivision of e-chains®.

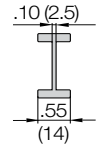

Vertical Separator	
Unassembled	Part No. 407
Assembled	Part No. 417

Spacer*

*For side-mounted applications



Unassembled	Part No. 381-XX
Assembled	Part No. 382-XX

XX = width of the spacer

Spacers available in the following sizes:

Part No. Unassembled	Part No. Assembled	in. (mm)
381 -10	382 -10	.39" (10)
381 -15	382 -15	.59" (15)
381 -20	382 -20	.79" (20)

Option 2: Full-width shelf

For applications involving many thin cables with similar or identical diameters. Vertical separator **E6-62-11** can be used in combination with full-width shelf **321-X**.

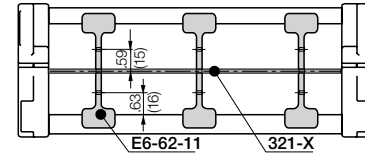

- Vertical separator, slotted**
 This separator is used for general subdivision of e-chains®.

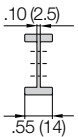

Vertical Separator	
Unassembled	Part No. E6-62-01
Assembled	Part No. E6-62-11

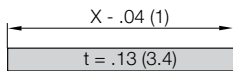

Width X in. (mm)	Part No. Unassem.	Part No. Assem.
1.97 (050)	320-50	321-50
2.68 (068)	320-68	321-68
2.95 (075)	320-75	321-75
3.43 (087)	320-87	321-87
3.94 (100)	320-100	321-100
4.25 (108)	320-108	321-108
4.41 (112)	320-112	321-112
4.92 (125)	320-125	321-125
5.39 (137)	320-137	321-137
5.91 (150)	320-150	321-150

Width X in. (mm)	Part No. Unassem.	Part No. Assem.
6.38 (162)	320-162	321-162
6.61 (168)	320-168	321-168
2.95 (175)	320-175	321-175
7.36 (187)	320-187	321-187
7.87 (200)	320-200	321-200
8.35 (212)	320-212	321-212
8.86 (225)	320-225	321-225
9.33 (237)	320-237	321-237
9.84 (250)	320-250	321-250

Option 3: Shelves

These components form the basic pattern of a shelf system. Shelves of various widths can be arranged at 7 different heights in .28" (7mm) increments

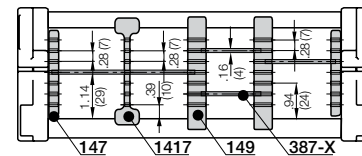

- Vertical separator**
 This separator is used when higher retention force is needed.

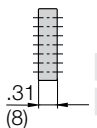

Vertical Separator	
Unassembled	Part No. 148
Assembled	Part No. 149

Width X in. (mm)	Part No. Unassembled	Part No. Assembled
.71 (18)	386-18	387-18
.91 (23)	386-23	387-23
.98 (25)	386-25	387-25
1.10 (28)	386-28	387-28
1.30 (33)	386-33	387-33
1.69 (43)	386-43	387-43
1.97 (50)	386-50	387-50
2.13 (54)	386-54	387-54
2.44 (62)	386-62	387-62

- Side plate**
 This separator is used for general subdivision of e-chains®.

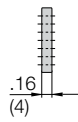

Side Plate	
Unassembled	Part No. 146
Assembled	Part No. 147

Width X in. (mm)	Part No. Unassembled	Part No. Assembled
2.95 (75)	386-75	387-75
3.43 (87)	386-87	387-87
3.94 (100)	386-100	387-100
4.25 (108)	386-108	387-108
4.92 (125)	386-125	387-125
5.91 (150)	386-150	387-150
6.89 (175)	386-175	387-175
7.87 (200)	386-200	387-200
8.19 (208)	386-208	387-208

- Vertical separator, slotted**
 This separator is used for general subdivision of e-chains®.

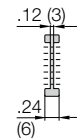

Vertical Separator, Slotted	
Unassembled	Part No. 1407
Assembled	Part No. 1417

Shelves 387-XX
 Shelf 387-XX can be used with vertical separator 149 and side plate 147

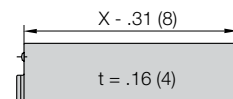

PDF: igus.com/e-chain-pdfs
 Product information: igus.com/e-chains





Option 1: KMA - Pivoting

- Option - profile rail with integrated strain relief chainfix clip or tiwrap plates
- Profile rail can be mounted in the inner or outer radius of the e-chain®
- Bolted connection outside of the chain cross-section
- Recommended for unsupported applications (for gliding applications please contact igus®)
- Confined installation conditions
- Attachment capability on all sides

Moving end
E6-620...2

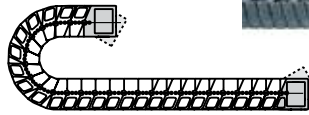

Fixed end
E6-620...1

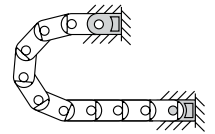

Possible installation configurations -

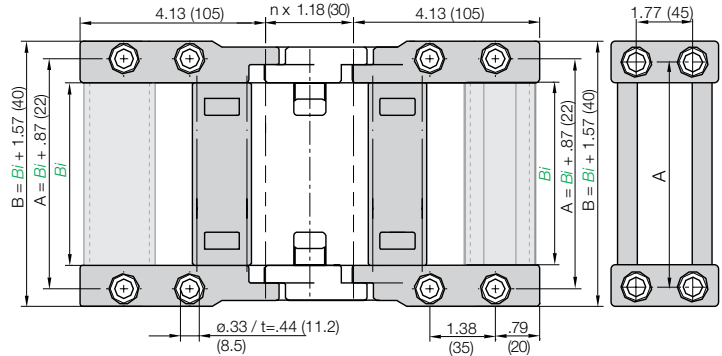

For Series	Part No. Full Set Without Profile Rail	Part No. Full Set With Profile Rail	Bi	
			in.	(mm)
E6-62-05	E6-620-05-12	E6-620-05-12P	1.97	(50)
E6-62-06	E6-620-06-12	E6-620-06-12P	2.67	(68)
E6-62-07	E6-620-07-12	E6-620-07-12P	2.95	(75)
E6-62-087	E6-620-087-12	E6-620-087-12P	3.43	(87)
E6-62-097	E6-620-097-12	E6-620-097-12P	3.82	(97)
E6-62-10	E6-620-10-12	E6-620-10-12P	3.94	(100)
E6-62-11	E6-620-11-12	E6-620-11-12P	4.25	(108)
E6-62-112	E6-620-112-12	E6-620-112-12P	4.41	(112)
E6-62-12	E6-620-12-12	E6-620-12-12P	4.92	(125)
E6-62-137	E6-620-137-12	E6-620-137-12P	5.39	(137)
E6-62-15	E6-620-15-12	E6-620-15-12P	5.91	(150)
E6-62-162	E6-620-162-12	E6-620-162-12P	6.38	(162)
E6-62-17	E6-620-17-12	E6-620-17-12P	6.61	(168)
E6-62-18	E6-620-18-12	E6-620-18-12P	6.89	(175)
E6-62-187	E6-620-187-12	E6-620-187-12P	7.36	(187)
E6-62-20	E6-620-20-12	E6-620-20-12P	7.87	(200)
E6-62-212	E6-620-212-12	E6-620-212-12P	8.35	(212)
E6-62-23	E6-620-23-12	E6-620-23-12P	8.86	(225)
E6-62-237	E6-620-237-12	E6-620-237-12P	9.33	(237)
E6-62-25	E6-620-25-12	E6-620-25-12P	9.84	(250)
E6-62-262	E6-620-262-12	E6-620-262-12P	10.31	(262)
E6-62-28	E6-620-28-12	E6-620-28-12P	10.83	(275)
E6-62-29	E6-620-29-12	E6-620-29-12P	11.30	(287)
E6-62-30	E6-620-30-12	E6-620-30-12P	11.81	(300)
E6-62-312	E6-620-312-12	E6-620-312-12P	12.28	(312)
E6-62-325	E6-620-325-12	E6-620-325-12P	12.80	(325)
E6-62-337	E6-620-337-12	E6-620-337-12P	13.27	(337)
E6-62-350	E6-620-350-12	E6-620-350-12P	13.78	(350)
E6-62-362	E6-620-362-12	E6-620-362-12P	14.25	(362)
E6-62-375	E6-620-375-12	E6-620-375-12P	14.76	(375)
E6-62-387	E6-620-387-12	E6-620-387-12P	15.24	(387)
E6-62-400	E6-620-400-12	E6-620-400-12P	15.75	(400)

Part Number Structure



- With profile rail
- Complete Set
- Width
- Mounting brackets for selected chain type

Full set, for both ends:

E6-620-10-12 Full set, both fixed and moving end

Single-part order:

E6-620-10-1

Mounting bracket fixed end

E6-620-10-2

Mounting bracket moving end



Adapters for gliding applications available upon request

Tiewrap Plates

Option 1:
Tiewrap plates as an individual part

Available as an individual component, can be fixed onto a mounting bracket with the use of a profile rail.

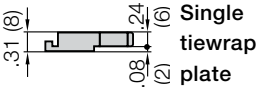
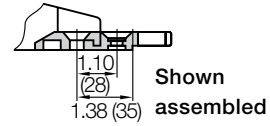

Tiewrap Plate	n Number of Teeth	C Overall Width in. (mm)	B Bore Width in. (mm)	Center Bore
3050-ZB	5	1.97 (50)	1.18 (30)	no
3075-ZB	7	2.95 (75)	2.16 (55)	no
3100-ZB	10	3.94 (100)	3.15 (80)	no
3115-ZB	11	4.53 (115)	3.74 (95)	no
3125-ZB	12	4.92 (125)	4.13 (105)	no
3150-ZB	15	5.91 (150)	5.12 (130)	no
3175-ZB	17	6.89 (175)	6.10 (155)	no
3200-ZB	20	7.87 (200)	7.09 (180)	yes
3225-ZB	22	8.86 (225)	8.07 (205)	yes
3250-ZB	25	9.84 (250)	9.06 (230)	yes

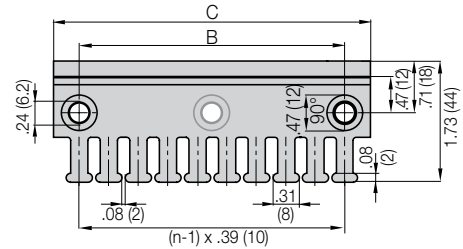

If used with KMA brackets with profile rail please add "KMA" to the end of the part number.

Example: 3050-ZBKMA

Other strain relief elements
► Strain Relief, Chapter 10



Price Index

Series E6-80

Special Features / Options

Extremely low noise
Test results upon request



IPA Certificate: Class 1, according
to standard DIN EN ISO 14644-1
for the E6 system
(Series E6-29-060-150-0-CR,
(v = 1.64 ft/s, a = 3.28 ft/s²))



LEVEL 1 absorption confirmed
by IPA-Fraunhofer-Institute
according to SEMI E78-0998 for
the E6 standard material

Assembly Tips

To close, push and click shut

Other Installation Methods

Vertical, hanging ≤ 196.9 ft (60 m)

Vertical, standing ≤ 13.12 ft (4 m)

Side-mounted, un_supp. = possible to a
limited extentUnsupported length of upper run upon
request
Usage Guidelines



- If a low-noise version is required
- For very high speeds and/or accelerations
- If large stresses and thrust forces are present
- For small bending radii
- If less vibration is required
- Minimal abrasion, suitable for cleanrooms



- For side mounted applications
➤ **Series E4-80 E4-1**
- For RBR (Reverse Bending Radius)
➤ **Series E4-80 E4-1**
- For high additional loads
➤ **Series E4-80 E4-1**

Features & Benefits

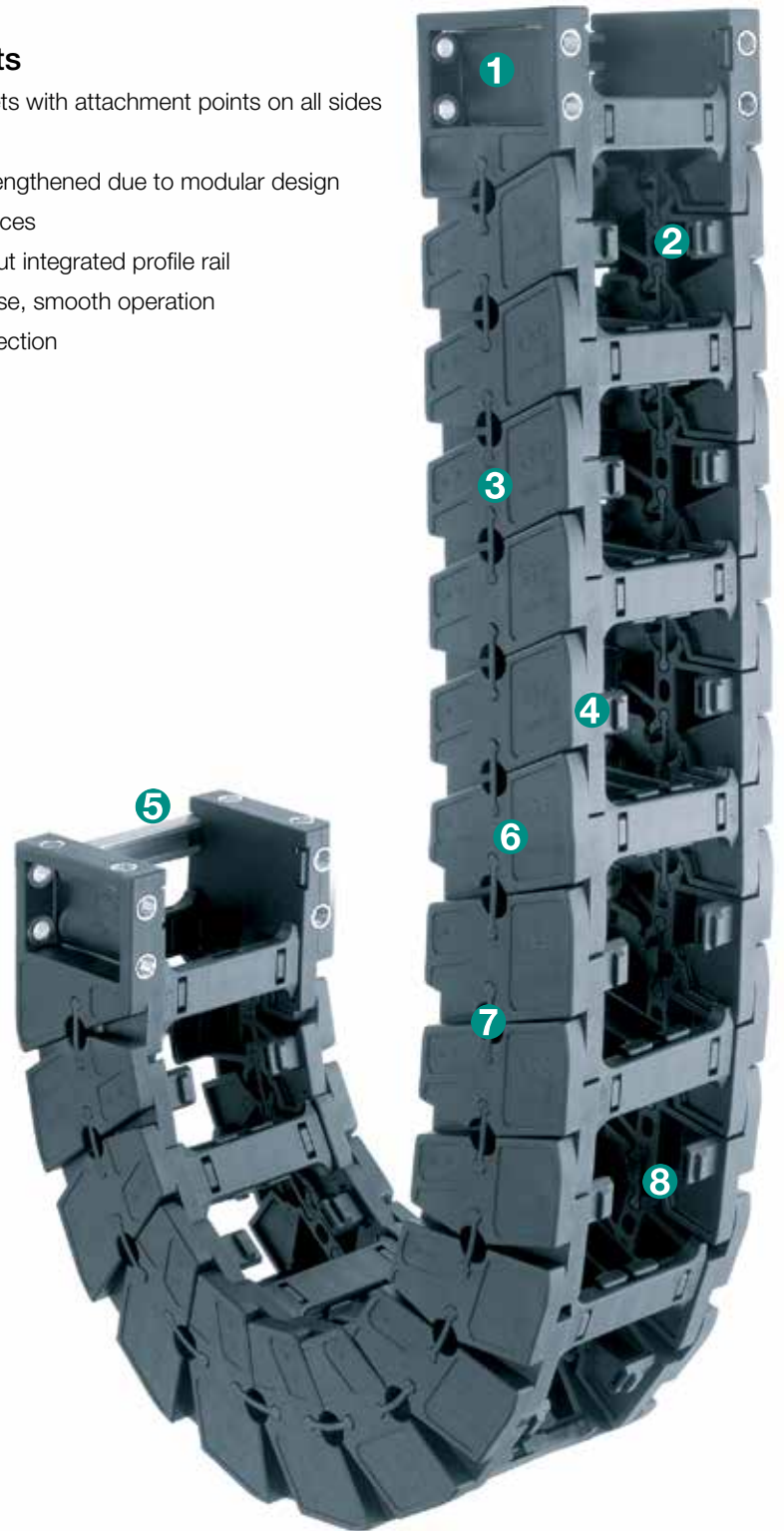
- 1 KMA mounting brackets with attachment points on all sides
- 2 Increased inner height
- 3 Can be shortened or lengthened due to modular design
- 4 Very large gliding surfaces
- 5 Available with or without integrated profile rail
- 6 Small pitch for low-noise, smooth operation
- 7 No pin and bore connection
- 8 Interior stop dog

Order Example: Complete e-chain®

Please indicate chain length or number of links. Example:

16.4 ft (5 m) **E6-80-10-200-0****e-chain®**With 2 separators **511** assembled every 2nd link**Interior Separation**1 Set **E6-800-10-12****Mounting Bracket**

e-chain system® E6

Series E6-80

Installation Dimensions

Short travel, unsupported length

- FL_B = unsupported with permitted sag
 - FL_G = unsupported with straight upper run
- Further information ► Design, Chapter 1

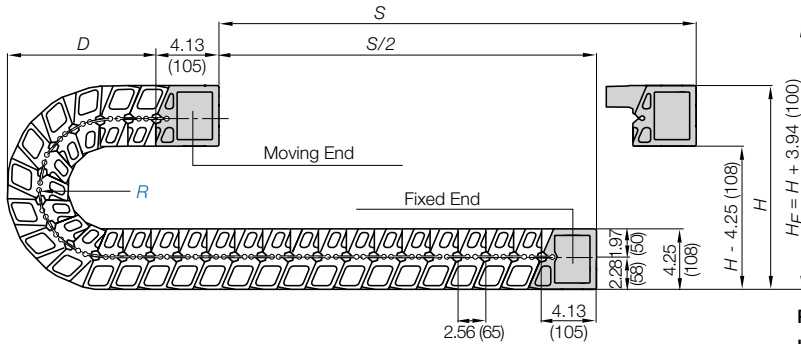
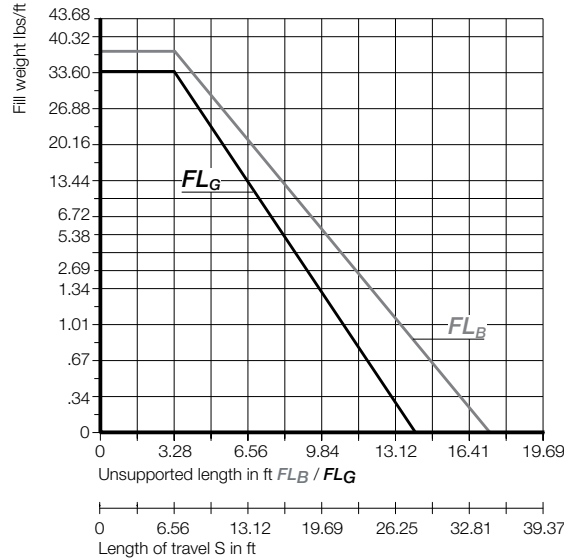
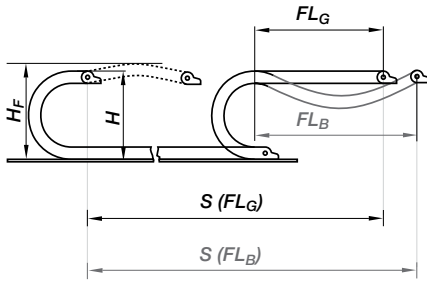

Pitch per link = 2.56" (65 mm)
 Links per ft (m) = 4.68 (16)
 Chain length = $\frac{S}{2} + K$

The required clearance height: $H_f = H + 3.94$ in. (100 mm) (with 3.36 lbs/ft (5.0 kg/m) fill weight). Please consult igus® if space is particularly restricted.

	5.91 (150)	7.87 (200)	9.84 (250)	11.81 (300)	13.78 (350)	15.75 (400)	17.71 (450)
R	5.91 (150)	7.87 (200)	9.84 (250)	11.81 (300)	13.78 (350)	15.75 (400)	17.71 (450)
H*	20.31 (516)	24.25 (616)	28.19 (716)	32.13 (816)	36.06 (916)	40.00 (1016)	43.94 (1116)
D	12.05 (306)	14.02 (356)	15.98 (406)	17.95 (456)	19.92 (506)	21.89 (556)	23.86 (606)
K	23.82 (605)	29.92 (760)	36.22 (920)	42.32 (1075)	48.43 (1230)	54.72 (1390)	60.83 (1545)



E6-80

3.15

Short Travels - Unsupported



Unsupported e-chains® feature positive camber over short travels. This must be accounted for when specifying the clearance height. Please refer to **Installation dimensions** for further details.

Legend

- S = Length of travel
- R = Bending radius
- H = Nominal clearance height
- D = Overlength e-chain® radius in final position
- $K = \pi \cdot R + \text{safety buffer}$
- H_f = Required clearance height
- H_{in} = Trough inner height
- $H_2 = *$ Mounting height
- D_2 = Overlength - long travels, gliding
- $K_2 = *$ Add-on

*If the mounting bracket location is set lower

PDF: igus.com/e-chain-pdfs
 Product information: igus.com/e-chains



Speed / acceleration FL_G	max. 65.6 ft/s (20 m/s) / max. 656 ft/s ² (200 m/s ²)
Speed / acceleration FL_B	max. 9.84 ft/s (3 m/s) / max. 19.69 ft/s ² (6 m/s ²)
Gliding speed / acceleration (maximum)	upon request
Permitted temperature	-40°F (-40°C) up to +158°F (+70°C)
Flammability Class	VDE 0304 IIC UL94 HB

Technical Data



Details of material properties

► Design, Chapter 1

7.116

Series E6-80 - e-chain® with crossbars every other link

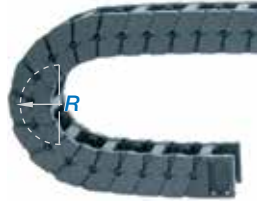
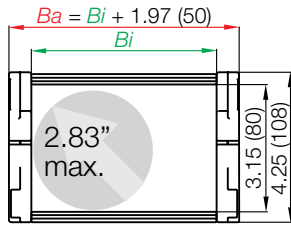

Part Number Structure



- Color - Black
- Bending radius
- Width
- Series



e-chain® as separate parts, side links and crossbars

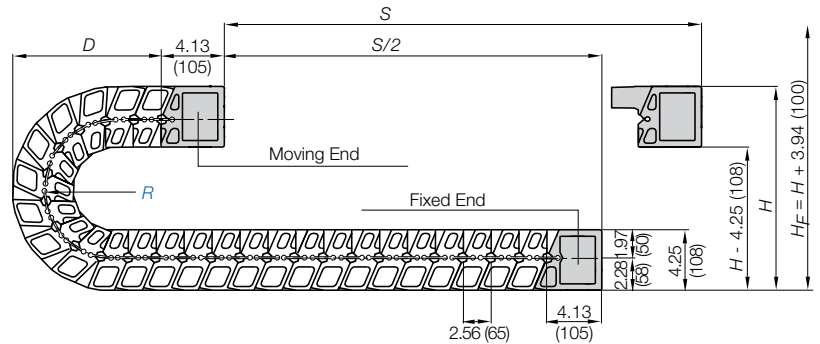
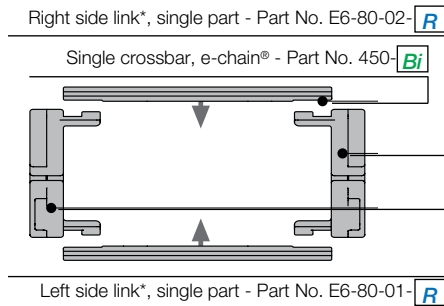

Polymer spring as single part - Part No. E6-80-350

*View from the fixed point of the e-chain®/E-Tube

e-chain system® E6

Series E6-80



E6-80

Supplement part number with required radius. Example: E6-80-10-200-0
Pitch: 2.56 in. (65 mm) per link links/ft (m) = 4.68 (16)

Part Number	<i>Bi</i>		<i>Ba</i>		Weight	
	in. (mm)		in. (mm)		lbs/ft (kg/m)	
E6-80-05- <input type="checkbox"/> -0	1.97 (50)	3.94 (100)	≈3.50 (5.21)			
E6-80-06- <input type="checkbox"/> -0	2.56 (65)	4.53 (115)	≈3.55 (5.28)			
E6-80-07- <input type="checkbox"/> -0	2.95 (75)	4.92 (125)	≈3.58 (5.33)			
E6-80-08- <input type="checkbox"/> -0	3.43 (87)	5.91 (137)	≈3.62 (5.38)			
E6-80-10- <input type="checkbox"/> -0	3.94 (100)	5.91 (150)	≈3.66 (5.45)			
E6-80-11- <input type="checkbox"/> -0	4.41 (112)	6.38 (162)	≈3.70 (5.50)			
E6-80-12- <input type="checkbox"/> -0	4.92 (125)	6.89 (175)	≈3.74 (5.57)			
E6-80-13- <input type="checkbox"/> -0	5.39 (137)	7.36 (187)	≈3.78 (5.62)			
E6-80-15- <input type="checkbox"/> -0	5.91 (150)	7.87 (200)	≈3.82 (5.68)			
E6-80-16- <input type="checkbox"/> -0	6.38 (162)	8.35 (212)	≈3.86 (5.74)			
E6-80-17- <input type="checkbox"/> -0	6.89 (175)	8.86 (225)	≈3.90 (5.80)			
E6-80-18- <input type="checkbox"/> -0	7.36 (187)	9.33 (237)	≈3.94 (5.86)			
E6-80-20- <input type="checkbox"/> -0	7.87 (200)	9.84 (250)	≈3.98 (5.92)			
E6-80-21- <input type="checkbox"/> -0	8.35 (212)	10.31 (262)	≈4.02 (5.98)			
E6-80-22- <input type="checkbox"/> -0	8.86 (225)	10.83 (275)	≈4.06 (6.04)			
E6-80-23- <input type="checkbox"/> -0	9.33 (237)	11.30 (287)	≈4.10 (6.10)			
E6-80-25- <input type="checkbox"/> -0	9.84 (250)	11.81 (300)	≈4.14 (6.16)			
E6-80-26- <input type="checkbox"/> -0	10.31 (262)	12.28 (312)	≈4.17 (6.21)			
E6-80-27- <input type="checkbox"/> -0	10.83 (275)	12.80 (325)	≈4.22 (6.28)			
E6-80-28- <input type="checkbox"/> -0	11.30 (287)	13.27 (337)	≈4.25 (6.33)			
E6-80-30- <input type="checkbox"/> -0	11.81 (300)	13.78 (350)	≈4.29 (6.39)			
E6-80-31- <input type="checkbox"/> -0	12.28 (312)	14.25 (362)	≈4.33 (6.45)			
E6-80-32- <input type="checkbox"/> -0	12.80 (325)	14.76 (375)	≈4.37 (6.51)			
E6-80-33- <input type="checkbox"/> -0	13.27 (337)	15.24 (387)	≈4.41 (6.57)			
E6-80-35- <input type="checkbox"/> -0	13.78 (350)	15.75 (400)	≈4.46 (6.63)			
E6-80-36- <input type="checkbox"/> -0	14.25 (362)	16.22 (412)	≈4.50 (6.69)			
E6-80-37- <input type="checkbox"/> -0	14.76 (375)	16.73 (425)	≈4.54 (6.75)			
E6-80-38- <input type="checkbox"/> -0	15.24 (387)	17.20 (437)	≈4.57 (6.80)			
E6-80-40- <input type="checkbox"/> -0	15.75 (400)	17.72 (450)	≈4.62 (6.88)			
E6-80-41- <input type="checkbox"/> -0	16.22 (412)	18.19 (462)	≈4.65 (6.92)			
E6-80-42- <input type="checkbox"/> -0	16.73 (425)	18.70 (475)	≈4.70 (6.99)			
E6-80-43- <input type="checkbox"/> -0	17.20 (437)	19.17 (487)	≈4.73 (7.04)			
E6-80-45- <input type="checkbox"/> -0	17.72 (450)	19.69 (500)	≈4.77 (7.10)			
E6-80-46- <input type="checkbox"/> -0	18.19 (462)	20.16 (512)	≈4.81 (7.16)			
E6-80-47- <input type="checkbox"/> -0	18.70 (475)	20.67 (525)	≈4.85 (7.22)			
E6-80-48- <input type="checkbox"/> -0	19.17 (487)	21.14 (537)	≈4.89 (7.28)			
E6-80-50- <input type="checkbox"/> -0	19.69 (500)	21.65 (550)	≈4.93 (7.34)			
E6-80-51- <input type="checkbox"/> -0	20.16 (512)	22.13 (562)	≈4.97 (7.40)			
E6-80-52- <input type="checkbox"/> -0	20.67 (525)	22.64 (575)	≈5.01 (7.46)			
E6-80-53- <input type="checkbox"/> -0	21.14 (537)	23.11 (587)	≈5.05 (7.52)			
E6-80-55- <input type="checkbox"/> -0	21.65 (550)	23.62 (600)	≈5.09 (7.58)			
E6-80-60- <input type="checkbox"/> -0	23.62 (600)	25.59 (650)	≈5.25 (7.81)			

Choose from the radii below for all of the above sizes
Radius (mm) Example: E6-80-10-200-0

	150	200	250	300	350	400	450
R	5.91 (150)	7.87 (200)	9.84 (250)	11.81 (300)	13.78 (350)	15.75 (400)	17.71 (450)
H*	20.31 (516)	24.25 (616)	28.19 (716)	32.13 (816)	36.06 (916)	40.00 (1016)	43.94 (1116)
D	12.05 (306)	14.02 (356)	15.98 (406)	17.95 (456)	19.92 (506)	21.89 (556)	23.86 (606)
K	23.82 (605)	29.92 (760)	36.22 (920)	42.32 (1075)	48.43 (1230)	54.72 (1390)	60.82 (1545)

PDF: igus.com/e-chain-pdfs
Product information: igus.com/e-chains



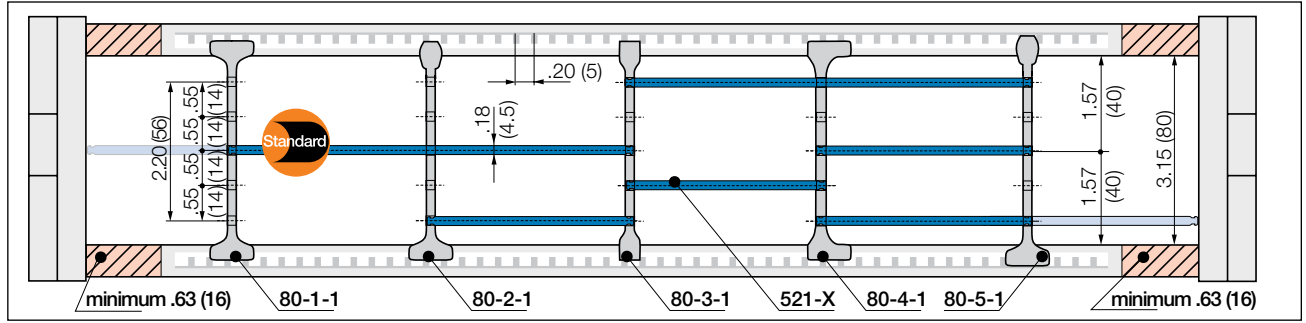

Note: Please maintain a lateral spacing of .63" (16 mm) between the separators and the side links.
In the standard configuration separators are assembled every 2nd e-chain® link

Telephone 1-800-521-2747

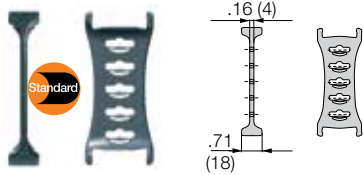

Separator, wide base

Unassembled	Part No. 80-1
Assembled	Part No. 80-1-1

- **Standard separator 80-1 for all applications**
Separator with wide base for maximum locking strength and safe standing in e-chains®.

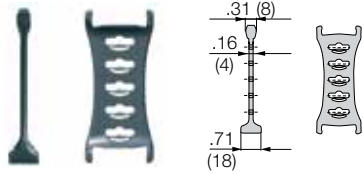

Separator for QuickLock crossbar

Unassembled	Part No. 80-2
Assembled	Part No. 80-2-1

- **Separator 80-2 For even faster installation**
Separator for QuickLock crossbar 385-X-Q. Firmly holds to one side with a wide base, narrow on opposite side for easy cable assembly (slight grip).

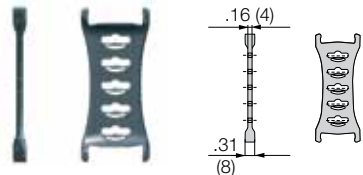

Separator, narrow base

Unassembled	Part No. 80-3
Assembled	Part No. 80-3-1

- **Separator 80-3 For many thin cables**
Separator with a narrow base for a large number of thin cables side by side. Save space in e-chains®.

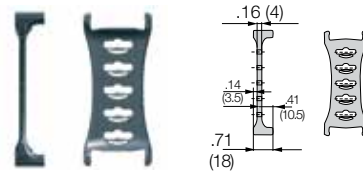

Separator, asymmetrical

Unassembled	Part No. 80-4
Assembled	Part No. 80-4-1

- **Separator 80-4 For side-mounted applications**
Asymmetrical separator, for defined distance. No additional spacers necessary.

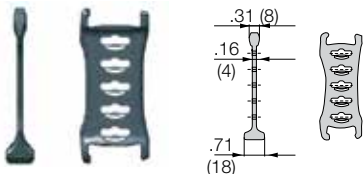

Notch separator for Notch crossbar

Unassembled	Part No. 80-5
Assembled	Part No. 80-5-1

- **Separator 80-5 Locks safely in .20" (5mm) increments**
Notch separator for exact positioning in e-chains®. Recommended for side mounted applications.

Lockable full-width shelves - for the standard interior separation

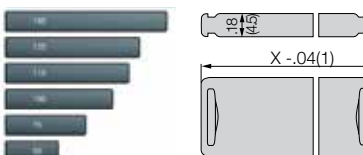

Full width shelf, lockable

Unassembled	Part No. 520-X
Assembled	Part No. 521-X

- **Full width shelf, lockable**
Shelf locks safely into separators on both ends, fixed width possible. Separators can be moved freely over the shelf horizontally. Can be arranged at three different heights.

Internet: igus.com
email: sales@igus.com
QuickSpec: igus.com/quickspec

Width X	Part No.	Part No.	Width X	Part No.	Part No.	Width X	Part No.	Part No.
in. (mm)	Unassembled	Assembled	in. (mm)	Unassembled	Assembled	in. (mm)	Unassembled	Assembled
1.97 (050)	520-050	521-050	5.91 (150)	520-150	521-150	11.81 (300)	520-300	521-300
2.55 (065)	520-065	521-065	6.89 (175)	520-175	521-175	13.78 (350)	520-350	521-350
2.95 (075)	520-075	521-075	7.87 (200)	520-200	521-200	14.76 (375)	520-375	521-375
3.94 (100)	520-100	521-100	8.86 (225)	520-225	521-225	15.24 (387)	520-387	521-387
4.92 (125)	520-125	521-125	9.84 (250)	520-250	521-250	17.72 (450)	520-450	521-450

e-chain system® E6
 Series E6-80
 Interior Separation - Previous Generation



E6-80



Option 1: Vertical separators and spacers

Vertical separators are used if a vertical subdivision of the e-chain® interior is required. By standard, vertical separators are assembled every other e-chain® link.

NOTE: Observe a lateral spacing of at least 1.30 in. (33mm) for E-Tubes and .63 in. (16mm) for e-chain®. There is no minimum spacing needed for side plates

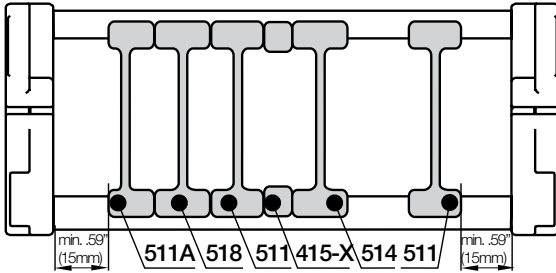

Vertical separator
501

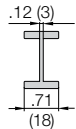

Vertical separator

Unassembled	Part No. 501
Assembled	Part No. 511

• **Standard separator 501**

This separator offers safe stability due to its wide base design, also when used with thick cables or hoses.



Locking separator
504

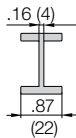

Locking separator

Unassembled	Part No. 504
Assembled	Part No. 514

• **Locking separator 504**

This separator features increased retention force for applications exposed to very high humidity and extreme loads. If locking separators are used, the e-chain® is more difficult to open.



Locking separator
508

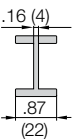

Locking separator

Unassembled	Part No. 508
Assembled	Part No. 518

• **Locking separator 508**

This separator is used for applications that are exposed to extremely high humidity. The clamp at the side serves to uniformly align the separators. In order to avoid destroying the separators when opening the e-chain®, make sure all separators are identically aligned.



Asymmetric separator
501A

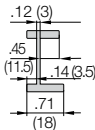

Asymmetrical separator

Unassembled	Part No. 501A
Assembled	Part No. 511A

• **Asymmetrical separator 501A**

This separator features an (18mm) base. It can be used in combinations between spacers of different widths and vertical separators in side mounted applications.



Spacers
405-XX



Spacer

Unassembled	Part No. 405-XX
Assembled	Part No. 415-XX

XX = width of the spacer

• **NOTE ON SPACERS**

Vertical separators are adjustable, but can be fixed in position by means of a spacer. Spacers are most often necessary for side mounted applications. The available inner height is reduced by .08" (2mm) **per spacer** (for example if one spacer is placed on either side of the separator, the overall inner height is reduced by .16" (4mm). To avoid this, place the spacers on the **outside** of the opening crossbar (**not for long travels**).

Spacers available in the following sizes:

Part No. Unassembled	Part No. Assembled	in.	(mm)
405 -10	415 -10	.39"	(10)
405 -15	415 -15	.59"	(15)
405 -20	415 -20	.79"	(20)
405 -30	415 -30	1.18"	(30)
405 -40	415 -40	1.57"	(40)



PDF: igus.com/e-chain-pdfs
 Product information: igus.com/e-chains

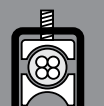



Option 2: Shelves

e-chains® and E-Tubes can be subdivided both vertically and horizontally using the various interior separation elements.

► **Design, Chapter 1** for layout recommendations.

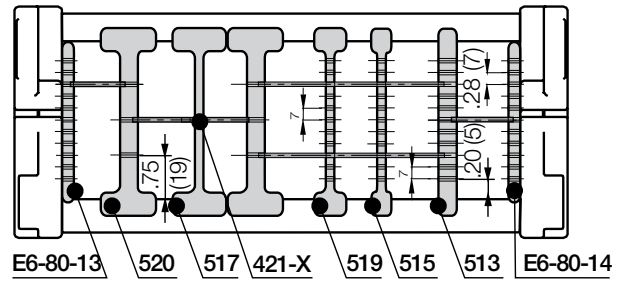

- **Side plates E6-80-03/E6-80-04**
This component is used to form the basic pattern of a shelf system.

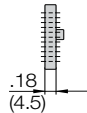

Side plate (left)

Unassembled **Part No. E6-80-03**

Assembled **Part No. E6-80-13**

Side plate (right)

Unassembled **Part No. E6-80-04**

Assembled **Part No. E6-80-14**

Side plate

E6-80-03 (left)

E6-80-04 (right)

- **Vertical separator 503**
This component is used to form the basic pattern of a shelf system.

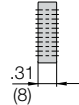

Vertical separator

Unassembled **Part No. 503**

Assembled **Part No. 513**

Vertical separator

503



- **Locking separator, slotted 507**
This separator features increased retention force for applications exposed to very high humidity and extreme loads. The extra retention force is achieved by asymmetric claws for the crossbar. Take care to ensure proper alignment.

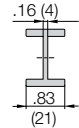

Locking separator, slotted

Unassembled **Part No. 507**

Assembled **Part No. 517**

Locking separator,
slotted

507



- **Locking vertical separator 510**
This separator is slotted and able to be combined with shelves.

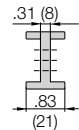

Locking vertical separator

Unassembled **Part No. 510**

Assembled **Part No. 520**

Locking vertical

separator
510



- **Slotted separators 505**
These are used for very complex subdivisions. However, they cannot be retrofitted into an existing separation system without removing the shelves first.

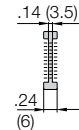

Slotted separators, closed

Unassembled **Part No. 505**

Assembled **Part No. 515**

Closed slotted

separator
505



- **Slotted separator 509**
This separator can be retrofitted into an existing interior separation system without removing the shelves, as long as these shelves fit into any of the 7 middle slots

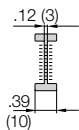

Slotted separators, open

Unassembled **Part No. 509**

Assembled **Part No. 519**

Open slotted

separator
509



Shelves 420-XX

These components form the basic pattern of a shelf system. Shelves of various widths can be arranged at 11 different heights in .28" (7mm) increments

Width X in.(mm)	Usable Width in.	Part No. Unassembled (mm)	Part No. Assembled	Width X in. (mm)	Usable Width in. (mm)	Part No. Unassembled	Part No. Assembled
.71 (18)	.39 (10)	420-18	421-18	2.95 (75)	2.64 (67)	420-75	421-75
.91 (23)	.59 (15)	420-23	421-23	3.46 (88)	3.15 (80)	420-88	421-88
.98 (25)	.67 (17)	420-25	421-25	3.94 (100)	3.62 (92)	420-100	421-100
1.10 (28)	.79 (20)	420-28	421-28	4.92 (125)	4.61 (117)	420-125	421-125
1.30 (33)	.98 (25)	420-33	421-33	5.91 (150)	5.59 (142)	420-150	421-150
1.69 (43)	1.38 (35)	420-43	421-43	6.89 (175)	6.57 (167)	420-175	421-175
1.97 (50)	1.65 (42)	420-50	421-50	7.36 (187)	7.05 (179)	420-187	421-187
2.44 (62)	2.13 (54)	420-62	421-62	7.87 (200)	7.56 (192)	420-200	421-200

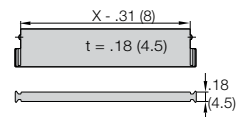

e-chain system® E6

Series E6-80

Mounting Brackets - KMA



E6-80



Option 1: KMA - Pivoting

- Option - profile rail with integrated strain relief chainfix clip or tiwrap plates
- Profile rail can be mounted in the inner or outer radius of the e-chain®
- Bolted connection outside of the chain cross-section
- Recommended for unsupported applications
- Confined installation conditions
- Attachment capability on all sides

Moving end
E6-800...2

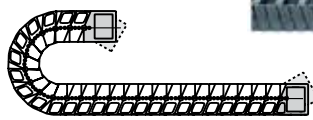

Fixed end
E6-800...1

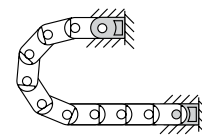

Possible installation configurations -

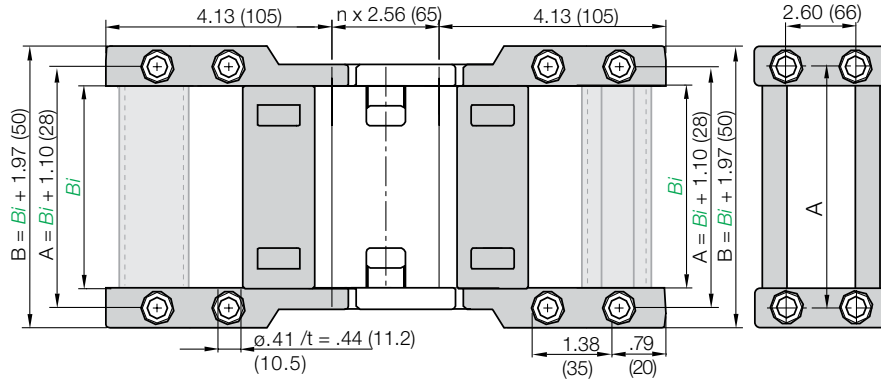

Part Number Structure

E6-800-	05-	12	P
---------	-----	----	---

With profile rail

Complete Set

Width

Mounting brackets for selected chain type

Full set, for both ends:

E6-800- 05- 12 Full set,

both fixed and moving end

Single-part order:

E6-800- 05- 1

Mounting bracket fixed end

E6-800- 05- 2

Mounting bracket moving end



Adapters for gliding applications available upon request

For Series	Part No. Full Set W/O Profile Rail	Part No. Full Set With Profile Rail	Bi in.	Bi (mm)	For Series	Part No. Full Set W/O Profile Rail	Part No. Full Set With Profile Rail	Bi in.	Bi (mm)
E6-80-05	E6-800-05-12	E6-800-05-12P	1.97	(50)	E6-80-31	E6-800-31-12	E6-800-31-12P	12.28	(312)
E6-80-06	E6-800-06-12	E6-800-06-12P	2.56	(65)	E6-80-32	E6-800-32-12	E6-800-32-12P	12.80	(325)
E6-80-07	E6-800-07-12	E6-800-07-12P	2.95	(75)	E6-80-33	E6-800-33-12	E6-800-33-12P	13.27	(337)
E6-80-08	E6-800-08-12	E6-800-08-12P	3.43	(87)	E6-80-35	E6-800-35-12	E6-800-35-12P	13.78	(350)
E6-80-10	E6-800-10-12	E6-800-10-12P	3.94	(100)	E6-80-36	E6-800-36-12	E6-800-36-12P	14.25	(362)
E6-80-11	E6-800-11-12	E6-800-11-12P	4.41	(112)	E6-80-37	E6-800-37-12	E6-800-37-12P	14.76	(375)
E6-80-12	E6-800-12-12	E6-800-12-12P	4.92	(125)	E6-80-38	E6-800-38-12	E6-800-38-12P	15.24	(387)
E6-80-13	E6-800-13-12	E6-800-13-12P	5.39	(137)	E6-80-40	E6-800-40-12	E6-800-40-12P	15.75	(400)
E6-80-15	E6-800-15-12	E6-800-15-12P	5.91	(150)	E6-80-41	E6-800-41-12	E6-800-41-12P	16.72	(412)
E6-80-16	E6-800-16-12	E6-800-16-12P	6.38	(162)	E6-80-42	E6-800-42-12	E6-800-42-12P	16.73	(425)
E6-80-17	E6-800-17-12	E6-800-17-12P	6.89	(175)	E6-80-43	E6-800-43-12	E6-800-43-12P	17.20	(437)
E6-80-18	E6-800-18-12	E6-800-18-12P	7.36	(187)	E6-80-45	E6-800-45-12	E6-800-45-12P	17.72	(450)
E6-80-20	E6-800-20-12	E6-800-20-12P	7.87	(200)	E6-80-46	E6-800-46-12	E6-800-46-12P	18.19	(462)
E6-80-21	E6-800-21-12	E6-800-21-12P	8.35	(212)	E6-80-47	E6-800-47-12	E6-800-47-12P	18.70	(475)
E6-80-22	E6-800-22-12	E6-800-22-12P	8.86	(225)	E6-80-48	E6-800-48-12	E6-800-48-12P	19.17	(487)
E6-80-23	E6-800-23-12	E6-800-23-12P	9.33	(237)	E6-80-50	E6-800-50-12	E6-800-50-12P	19.69	(500)
E6-80-25	E6-800-25-12	E6-800-25-12P	9.84	(250)	E6-80-51	E6-800-51-12	E6-800-51-12P	20.16	(512)
E6-80-26	E6-800-26-12	E6-800-26-12P	10.31	(262)	E6-80-52	E6-800-52-12	E6-800-52-12P	20.67	(525)
E6-80-27	E6-800-27-12	E6-800-27-12P	10.83	(275)	E6-80-53	E6-800-53-12	E6-800-53-12P	21.14	(537)
E6-80-28	E6-800-28-12	E6-800-28-12P	11.30	(287)	E6-80-55	E6-800-55-12	E6-800-55-12P	21.65	(550)
E6-80-30	E6-800-30-12	E6-800-30-12P	11.81	(300)	E6-80-60	E6-800-60-12	E6-800-60-12P	25.59	(600)

PDF: igus.com/e-chain-pdfs
Product information: igus.com/e-chains

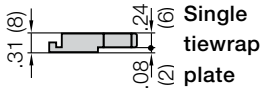
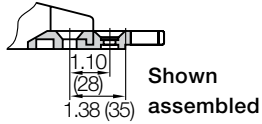

Tiewrap Plates

Option 1:
Tiewrap plates as an individual part

Available as an individual component, can be fixed onto a mounting bracket with the use of a profile rail.

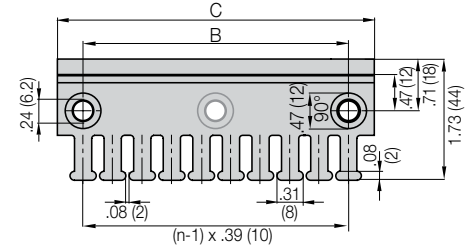
Tiewrap Plate	n Number of Teeth	C Overall Width in. (mm)	B Bore Width in. (mm)	Center Bore
3050-ZB	5	1.97 (50)	1.18 (30)	no
3075-ZB	7	2.95 (75)	2.16 (55)	no
3100-ZB	10	3.94 (100)	3.15 (80)	no
3115-ZB	11	4.53 (115)	3.74 (95)	no
3125-ZB	12	4.92 (125)	4.13 (105)	no
3150-ZB	15	5.91 (150)	5.12 (130)	no
3175-ZB	17	6.89 (175)	6.10 (155)	no
3200-ZB	20	7.87 (200)	7.09 (180)	yes
3225-ZB	22	8.86 (225)	8.07 (205)	yes
3250-ZB	25	9.84 (250)	9.06 (230)	yes



If used with KMA brackets with profile rail please add "KMA" to the end of the part number.

Example: 3050-ZBKMA
Other strain relief elements

 ➤ **Strain Relief, Chapter 10**

PDF: igus.com/e-chain-pdfs
Product information: igus.com/e-chains



Price Index

Series E6-80L

Special Features / Options

Extremely low noise
Test results upon request



IPA Certificate: Class 1, according to standard DIN EN ISO 14644-1 for the E6 system (Series E6-29-060-150-0-CR, (v = 1.64 ft/s, a = 3.28 ft/s²))



LEVEL 1 absorption confirmed by IPA-Fraunhofer-Institute according to SEMI E78-0998 for the E6 standard material

Assembly Tips

To close, push and click shut

Other Installation Methods

Vertical, hanging ≤ 196.8 ft (60 m)

Vertical, standing ≤ 13.12 ft (4 m)

Side-mounted, un supp. =

possible to a limited extent

Unsupported length of upper run upon request

Usage Guidelines



- If a low-noise version is required
- For very high speeds and/or accelerations
- If large stresses and thrust forces are present
- For small bending radii
- If less vibration is required
- Minimal abrasion, suitable for cleanrooms



- For side mounted applications
 - Series 15050 E4/Light
- For RBR (Reverse Bending Radius)
 - Series 15050 E4/Light
- For high additional loads
 - Series 15050 E4/Light

Features & Benefits

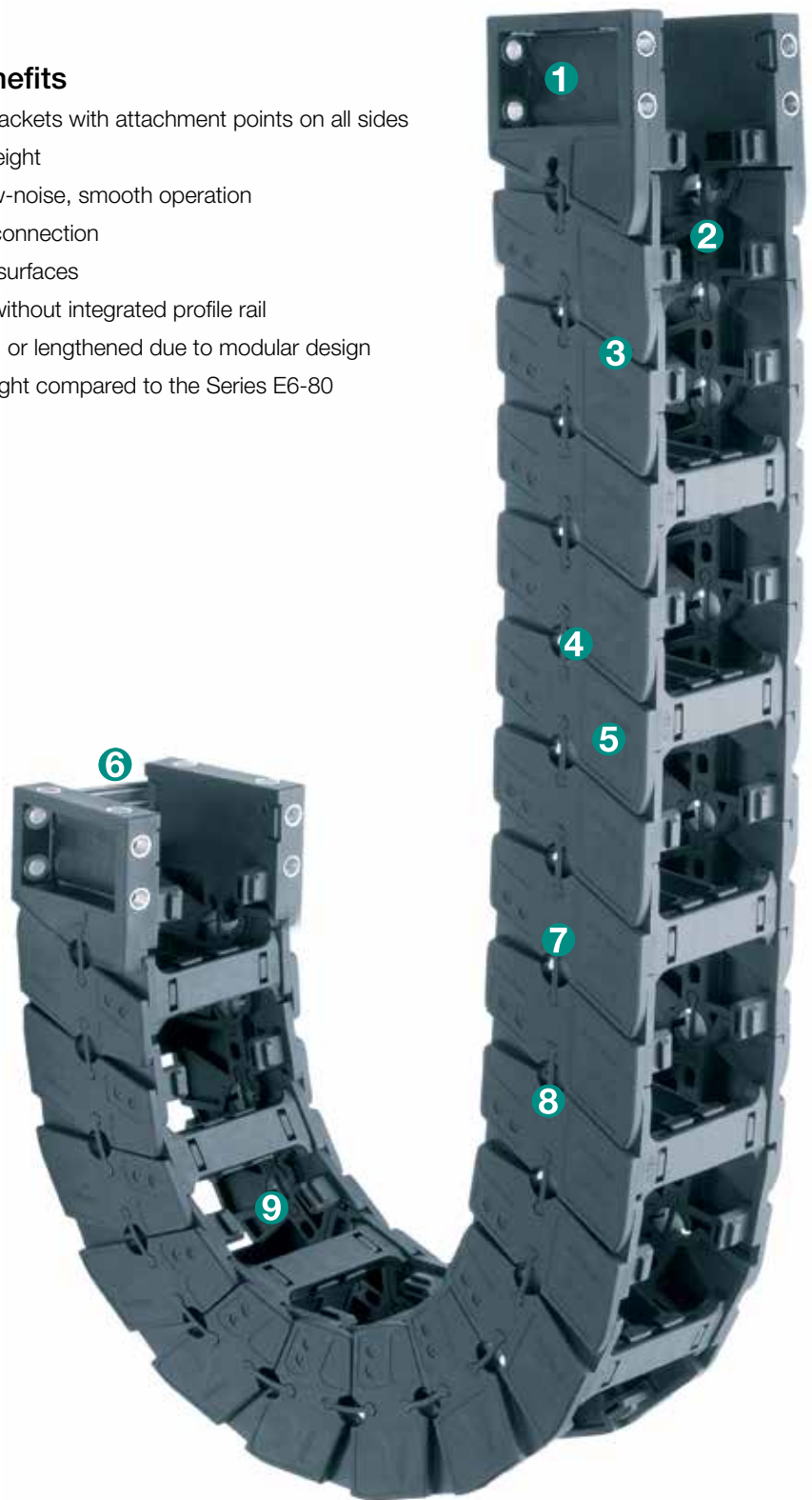
- 1 KMA mounting brackets with attachment points on all sides
- 2 Increased inner height
- 3 Small pitch for low-noise, smooth operation
- 4 No pin and bore connection
- 5 Continuous glide surfaces
- 6 Available with or without integrated profile rail
- 7 Can be shortened or lengthened due to modular design
- 8 45% lighter in weight compared to the Series E6-80
- 9 Interior stop dog

Order Example: Complete e-chain®

Please indicate chain length or number of links. Example:

16.4 ft (5 m) **E6-80L-15-175-0**

e-chain®

With 2 separators **511** assembled every 2nd link

Interior Separation

1 Set **E6-800L-15-12**

Mounting Bracket

e-chain system® E6

Series E6-80L

Installation Dimensions

Short travel, unsupported length

- FL_B = unsupported with permitted sag
 - FL_G = unsupported with straight upper run
- Further information ► Design, Chapter 1

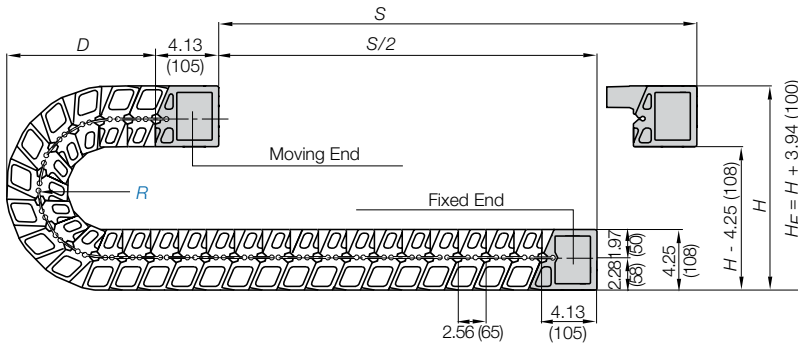
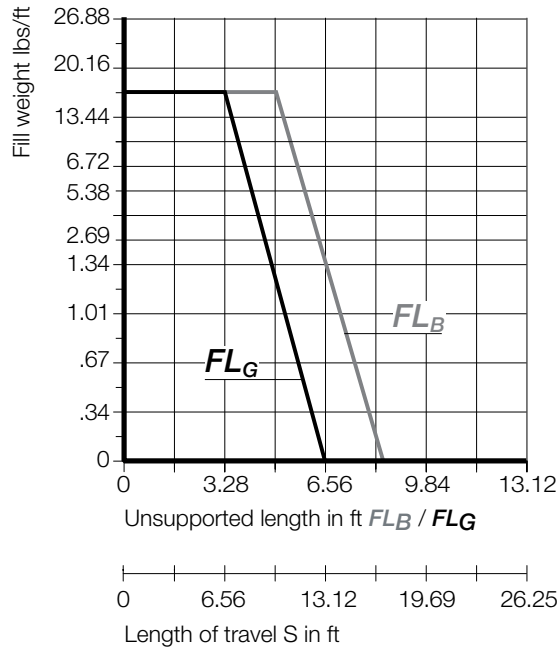
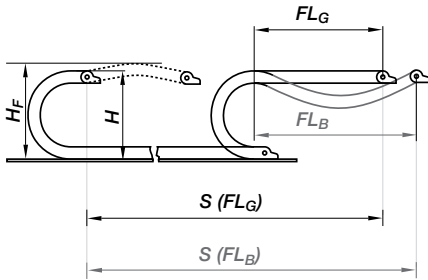

The required clearance height: $H_F = H + 3.94$ in. (100 mm) (with 3.36 lbs/ft (5.0 kg/m) fill weight. Please consult igus® if space is particularly restricted.

R	5.91 (150)	6.89 (175)	7.87 (200)	9.84 (250)	11.81 (300)
H^*	20.31 (516)	22.28 (566)	24.25 (616)	28.19 (716)	32.13 (816)
D	12.05 (306)	13.03 (331)	14.02 (356)	15.98 (406)	17.95 (456)
K	23.82 (605)	26.77 (680)	29.92 (760)	36.02 (915)	42.32 (1075)

Pitch per link: = 2.56" (65 mm)

Links per ft (m): = 4.68 (16)

For center mount applications:

Chain length = $\frac{S}{2} + K$

Speed / acceleration FL_G	max. 65.6 ft/s (20 m/s) / max. 656 ft/s ² (200 m/s ²)
Speed / acceleration FL_B	max. 9.84 ft/s (3 m/s) / max. 19.69 ft/s ² (6 m/s ²)
Gliding speed / acceleration (maximum)	upon request
Permitted temperature	-40°F (-40°C) up to +158°F (+70° C)
Flammability Class	VDE 0304 IIC UL94 HB

igus®

E6-80L

Short Travels - Unsupported

3.15



Unsupported e-chains® feature positive camber over short travels. This must be accounted for when specifying the clearance height. Please refer to **Installation dimensions** for further details.

Legend

- S = Length of travel
- R = Bending radius
- H = Nominal clearance height
- D = Overlength e-chain® radius in final position
- $K = \pi \cdot R + \text{safety buffer}$
- H_F = Required clearance height

PDF: igus.com/e-chain-pdfs
Product information: igus.com/e-chains



Technical Data



Details of material properties

► Design, Chapter 1

7.126

Series E6-80L - e-chain® with crossbars every other link

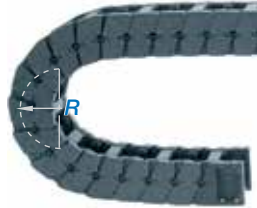
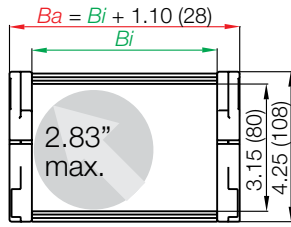

Part Number Structure

E6-80L-	15-	175-	0
---------	-----	------	---

- Color - Black
- Bending radius
- Width
- Series

e-chain® as separate parts, side links and crossbars

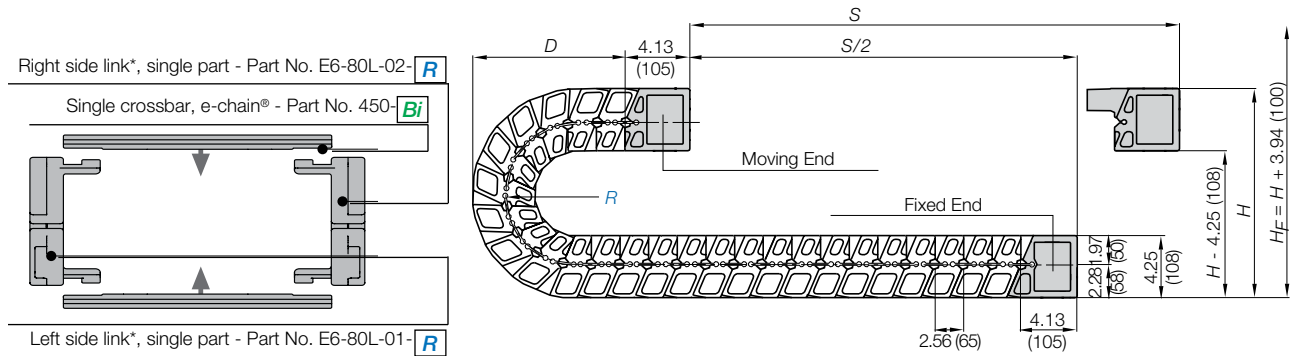

Polymer spring as single part -
Part No. E6-80-350

*View from the fixed point of the e-chain®/E-Tube

e-chain system® E6

Series E6-80L



E6-80L

Supplement part number with required radius. Example: E6-80L-15-175-0
Pitch: 2.56 in. (65 mm) per link links/ft (m) = 4.68 (16)

Part Number	<i>Bi</i>		<i>Ba</i>		Weight	
	in. (mm)		in. (mm)		lbs/ft (kg/m)	
E6-80L-08- <input type="checkbox"/> -0	3.43 (87)		4.53 (115)		≈ 2.20 (3.28)	
E6-80L-10- <input type="checkbox"/> -0	3.94 (100)		5.04 (128)		≈ 2.24 (3.33)	
E6-80L-11- <input type="checkbox"/> -0	4.41 (112)		5.51 (140)		≈ 2.26 (3.38)	
E6-80L-12- <input type="checkbox"/> -0	4.92 (125)		6.02 (153)		≈ 2.30 (3.43)	
E6-80L-13- <input type="checkbox"/> -0	5.39 (137)		6.50 (165)		≈ 2.35 (3.49)	
E6-80L-15- <input type="checkbox"/> -0	5.91 (150)		7.01 (178)		≈ 2.39 (3.55)	
E6-80L-16- <input type="checkbox"/> -0	6.38 (162)		7.48 (190)		≈ 2.43 (3.61)	
E6-80L-17- <input type="checkbox"/> -0	6.89 (175)		7.99 (203)		≈ 2.47 (3.67)	
E6-80L-18- <input type="checkbox"/> -0	7.36 (187)		8.46 (215)		≈ 2.51 (3.73)	
E6-80L-20- <input type="checkbox"/> -0	7.87 (200)		8.98 (228)		≈ 2.55 (3.79)	
E6-80L-21- <input type="checkbox"/> -0	8.35 (212)		9.45 (240)		≈ 2.59 (3.85)	
E6-80L-22- <input type="checkbox"/> -0	8.86 (225)		9.96 (253)		≈ 2.63 (3.91)	
E6-80L-23- <input type="checkbox"/> -0	9.33 (237)		10.43 (265)		≈ 2.67 (3.97)	
E6-80L-25- <input type="checkbox"/> -0	9.84 (250)		10.94 (278)		≈ 2.70 (4.02)	
E6-80L-26- <input type="checkbox"/> -0	10.31 (262)		11.42 (290)		≈ 2.75 (4.09)	
E6-80L-27- <input type="checkbox"/> -0	10.83 (275)		11.93 (303)		≈ 2.78 (4.14)	
E6-80L-28- <input type="checkbox"/> -0	11.30 (287)		12.40 (315)		≈ 2.82 (4.20)	
E6-80L-30- <input type="checkbox"/> -0	11.81 (300)		12.91 (328)		≈ 2.86 (4.26)	
E6-80L-31- <input type="checkbox"/> -0	12.28 (312)		13.39 (340)		≈ 2.90 (4.32)	
E6-80L-32- <input type="checkbox"/> -0	12.80 (325)		13.90 (353)		≈ 2.94 (4.38)	
E6-80L-33- <input type="checkbox"/> -0	13.27 (337)		14.37 (365)		≈ 2.98 (4.44)	
E6-80L-35- <input type="checkbox"/> -0	13.78 (350)		14.88 (378)		≈ 3.02 (4.50)	
E6-80L-36- <input type="checkbox"/> -0	14.25 (362)		15.35 (390)		≈ 3.06 (4.56)	
E6-80L-37- <input type="checkbox"/> -0	14.76 (375)		15.87 (403)		≈ 3.10 (4.62)	
E6-80L-38- <input type="checkbox"/> -0	15.24 (387)		16.34 (415)		≈ 3.14 (4.68)	
E6-80L-40- <input type="checkbox"/> -0	15.75 (400)		16.85 (428)		≈ 3.19 (4.74)	
E6-80L-41- <input type="checkbox"/> -0	16.22 (412)		17.32 (440)		≈ 3.23 (4.80)	
E6-80L-42- <input type="checkbox"/> -0	16.73 (425)		17.83 (453)		≈ 3.26 (4.85)	
E6-80L-43- <input type="checkbox"/> -0	17.20 (437)		18.31 (465)		≈ 3.31 (4.92)	
E6-80L-45- <input type="checkbox"/> -0	17.72 (450)		18.82 (478)		≈ 3.38 (5.03)	
E6-80L-46- <input type="checkbox"/> -0	18.19 (462)		19.29 (490)		≈ 3.42 (5.09)	
E6-80L-47- <input type="checkbox"/> -0	18.70 (475)		19.80 (503)		≈ 3.46 (5.15)	
E6-80L-48- <input type="checkbox"/> -0	19.17 (487)		20.28 (515)		≈ 3.50 (5.21)	
E6-80L-50- <input type="checkbox"/> -0	19.69 (500)		20.79 (528)		≈ 3.54 (5.27)	
E6-80L-51- <input type="checkbox"/> -0	20.16 (512)		21.26 (540)		≈ 3.58 (5.33)	
E6-80L-52- <input type="checkbox"/> -0	20.67 (525)		21.77 (553)		≈ 3.62 (5.39)	
E6-80L-53- <input type="checkbox"/> -0	21.14 (537)		22.24 (565)		≈ 3.66 (5.45)	
E6-80L-55- <input type="checkbox"/> -0	21.65 (550)		22.76 (578)		≈ 3.70 (5.51)	

Choose from the radii below for all of the above sizes
Radius (mm) Example: E6-80L-15-175-0

	150	175	200	250	300
R	5.91 (150)	6.89 (175)	7.87 (200)	9.84 (250)	11.81 (300)
H*	20.31 (516)	22.28 (566)	24.25 (616)	28.19 (716)	32.13 (816)
D	12.05 (306)	13.03 (331)	14.02 (356)	15.98 (406)	17.95 (456)
K	23.82 (605)	26.77 (680)	29.92 (760)	36.02 (915)	42.32 (1075)

PDF: igus.com/e-chain-pdfs
Product information: igus.com/e-chains



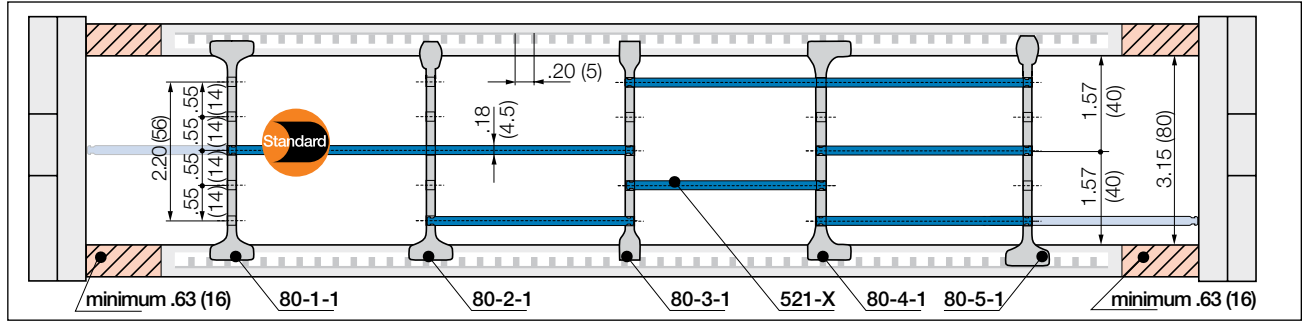

Note: Please maintain a lateral spacing of .63" (16 mm) between the separators and the side links.
In the standard configuration separators are assembled every 2nd e-chain® link

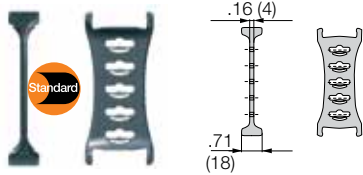

Separator, wide base

Unassembled	Part No. 80-1
Assembled	Part No. 80-1-1

- **Standard separator 80-1 for all applications**

Separator with wide base for maximum locking strength and safe standing in e-chains®.

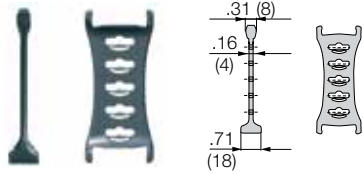

Separator for QuickLock crossbar

Unassembled	Part No. 80-2
Assembled	Part No. 80-2-1

- **Separator 80-2 For even faster installation**

Separator for QuickLock crossbar 385-X-Q. Firmly holds to one side with a wide base, narrow on opposite side for easy cable assembly (slight grip).

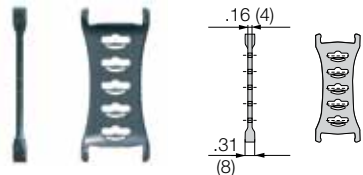

Separator, narrow base

Unassembled	Part No. 80-3
Assembled	Part No. 80-3-1

- **Separator 80-3 For many thin cables**

Separator with a narrow base for a large number of thin cables side by side. Save space in e-chains®.

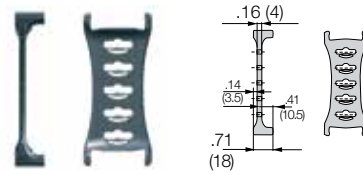

Separator, asymmetrical

Unassembled	Part No. 80-4
Assembled	Part No. 80-4-1

- **Separator 80-4 For side-mounted applications**

Asymmetrical separator, for defined distance. No additional spacers necessary.

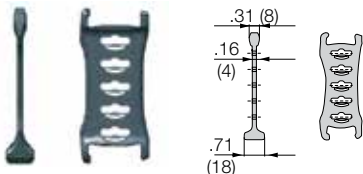

Notch separator for Notch crossbar

Unassembled	Part No. 80-5
Assembled	Part No. 80-5-1

- **Separator 80-5 Locks safely in .20" (5mm) increments**
Notch separator for exact positioning in e-chains®. Recommended for side mounted applications.

Lockable full-width shelves - for the standard interior separation

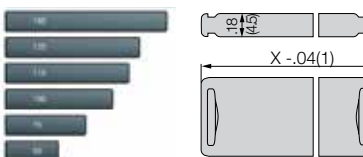

Full width shelf, lockable

Unassembled	Part No. 520-X
Assembled	Part No. 521-X

- **Full width shelf, lockable**
Shelf locks safely into separators on both ends, fixed width possible. Separators can be moved freely over the shelf horizontally. Can be arranged at three different heights.

Width X	Part No.	Part No.	Width X	Part No.	Part No.	Width X	Part No.	Part No.
in. (mm)	Unassembled	Assembled	in. (mm)	Unassembled	Assembled	in. (mm)	Unassembled	Assembled
1.97 (050)	520-050	521-050	5.91 (150)	520-150	521-150	11.81 (300)	520-300	521-300
2.55 (065)	520-065	521-065	6.89 (175)	520-175	521-175	13.78 (350)	520-350	521-350
2.95 (075)	520-075	521-075	7.87 (200)	520-200	521-200	14.76 (375)	520-375	521-375
3.94 (100)	520-100	521-100	8.86 (225)	520-225	521-225	15.24 (387)	520-387	521-387
4.92 (125)	520-125	521-125	9.84 (250)	520-250	521-250	17.72 (450)	520-450	521-450

e-chain system® E6
 Series E6-80L
 Interior Separation - Previous Generation



E6-80L



Option 1: Vertical separators and spacers

Vertical separators are used if a vertical subdivision of the e-chain® interior is required. By standard, vertical separators are assembled every other e-chain® link.

NOTE: Observe a lateral spacing of at least 1.30 in. (33mm) for E-Tubes and .63 in. (16mm) for e-chain®. There is no minimum spacing needed for side plates

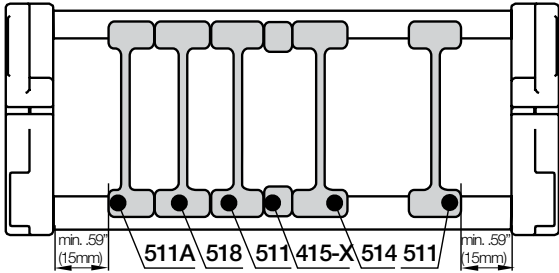

Vertical separator
501

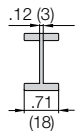

Vertical separator

Unassembled	Part No. 501
Assembled	Part No. 511

- **Standard separator 501**
 This separator offers safe stability due to its wide base design, also when used with thick cables or hoses.



Locking separator
504

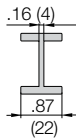

Locking separator

Unassembled	Part No. 504
Assembled	Part No. 514

- **Locking separator 504**
 This separator features increased retention force for applications exposed to very high humidity and extreme loads. If locking separators are used, the e-chain® is more difficult to open.



Locking separator
508

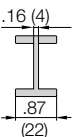

Locking separator

Unassembled	Part No. 508
Assembled	Part No. 518

- **Locking separator 508**
 This separator is used for applications that are exposed to extremely high humidity. The clamp at the side serves to uniformly align the separators. In order to avoid destroying the separators when opening the e-chain®, make sure all separators are identically aligned.



Asymmetric separator
501A

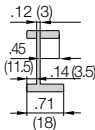

Asymmetrical separator

Unassembled	Part No. 501A
Assembled	Part No. 511A

- **Asymmetrical separator 501A**
 This separator features an (18mm) base. It can be used in combinations between spacers of different widths and vertical separators in side mounted applications.



Spacers
405-XX



Spacer

Unassembled	Part No. 405-XX
Assembled	Part No. 415-XX

XX = width of the spacer

- **NOTE ON SPACERS**
 Vertical separators are adjustable, but can be fixed in position by means of a spacer. Spacers are most often necessary for side mounted applications. The available inner height is reduced by .08" (2mm) **per spacer** (for example if one spacer is placed on either side of the separator, the overall inner height is reduced by .16" (4mm). To avoid this, place the spacers on the **outside** of the opening crossbar (**not for long travels**).

Spacers available in the following sizes:

Part No. Unassembled	Part No. Assembled	in.	(mm)
405 -10	415 -10	.39"	(10)
405 -15	415 -15	.59"	(15)
405 -20	415 -20	.79"	(20)
405 -30	415 -30	1.18"	(30)
405 -40	415 -40	1.57"	(40)



PDF: igus.com/e-chain-pdfs
 Product information: igus.com/e-chains





Option 2: Shelves

e-chains® and E-Tubes can be subdivided both vertically and horizontally using the various interior separation elements.

► **Design, Chapter 1** for layout recommendations.

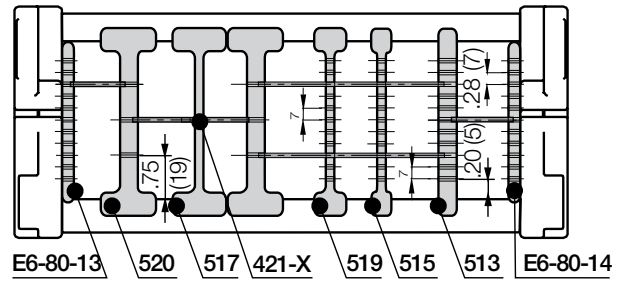

- **Side plates E6-80-03/E6-80-04**
This component is used to form the basic pattern of a shelf system.

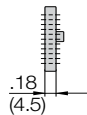

Side plate (left)

Unassembled **Part No. E6-80-03**

Assembled **Part No. E6-80-13**

Side plate (right)

Unassembled **Part No. E6-80-04**

Assembled **Part No. E6-80-14**

Side plate

E6-80-03 (left)

E6-80-04 (right)

- **Vertical separator 503**
This component is used to form the basic pattern of a shelf system.

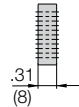

Vertical separator

Unassembled **Part No. 503**

Assembled **Part No. 513**

Vertical separator

503



- **Locking separator, slotted 507**
This separator features increased retention force for applications exposed to very high humidity and extreme loads. The extra retention force is achieved by asymmetric claws for the crossbar. Take care to ensure proper alignment.

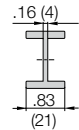

Locking separator, slotted

Unassembled **Part No. 507**

Assembled **Part No. 517**

Locking separator,
slotted

507



- **Locking vertical separator 510**
This separator is slotted and able to be combined with shelves.

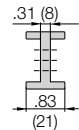

Locking vertical separator

Unassembled **Part No. 510**

Assembled **Part No. 520**

Locking vertical

separator

510



- **Slotted separators 505**
These are used for very complex subdivisions. However, they cannot be retrofitted into an existing separation system without removing the shelves first.

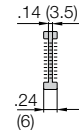

Slotted separators, closed

Unassembled **Part No. 505**

Assembled **Part No. 515**

Closed slotted

separator

505



- **Slotted separator 509**
This separator can be retrofitted into an existing interior separation system without removing the shelves, as long as these shelves fit into any of the 7 middle slots

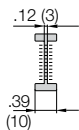

Slotted separators, open

Unassembled **Part No. 509**

Assembled **Part No. 519**

Open slotted

separator

509



Shelves 420-XX

These components form the basic pattern of a shelf system. Shelves of various widths can be arranged at 11 different heights in .28" (7mm) increments

Width X in.(mm)	Usable Width in.	Part No. Unassembled (mm)	Part No. Assembled	Width X in. (mm)	Usable Width in. (mm)	Part No. Unassembled	Part No. Assembled
.71 (18)	.39 (10)	420-18	421-18	2.95 (75)	2.64 (67)	420-75	421-75
.91 (23)	.59 (15)	420-23	421-23	3.46 (88)	3.15 (80)	420-88	421-88
.98 (25)	.67 (17)	420-25	421-25	3.94 (100)	3.62 (92)	420-100	421-100
1.10 (28)	.79 (20)	420-28	421-28	4.92 (125)	4.61 (117)	420-125	421-125
1.30 (33)	.98 (25)	420-33	421-33	5.91 (150)	5.59 (142)	420-150	421-150
1.69 (43)	1.38 (35)	420-43	421-43	6.89 (175)	6.57 (167)	420-175	421-175
1.97 (50)	1.65 (42)	420-50	421-50	7.36 (187)	7.05 (179)	420-187	421-187
2.44 (62)	2.13 (54)	420-62	421-62	7.87 (200)	7.56 (192)	420-200	421-200

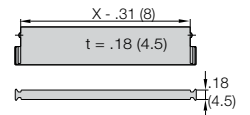

e-chain system® E6

Series E6-80L

Mounting Brackets - KMA



E6-80L



Option 1: KMA - Pivoting

- Option - profile rail with integrated strain relief chainfix clip or tiwrap plates
- Profile rail can be mounted in the inner or outer radius of the e-chain®
- Bolted connection outside of the chain cross-section
- Recommended for unsupported applications
- Confined installation conditions
- Attachment capability on all sides

Moving end
E6-800...2

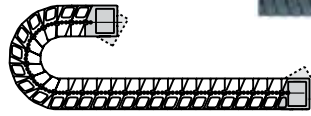

Fixed end
E6-800...1

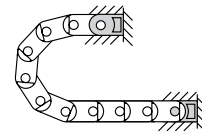

Possible installation configurations -

Part Number Structure

E6-800L-	10-	12	P
----------	-----	----	---

With profile rail

Complete Set

Width

Mounting brackets for selected chain type

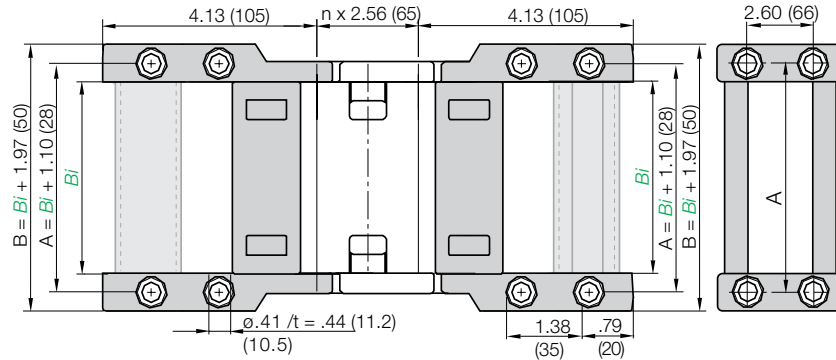

Full set, for both ends:

E6-800L-10-12 Full set,
both fixed and moving end

Single-part order:

E6-800L-10-1

Mounting bracket **fixed end**

E6-800L-10-2

Mounting bracket **moving end**

For Series	Part No. Full Set W/O Profile Rail	Part No. Full Set With Profile Rail	Bi	in.	(mm)	For Series	Part No. Full Set W/O Profile Rail	Part No. Full Set With Profile Rail	Bi	in.	(mm)
E6-80L-08	E6-800L-08-12	E6-800L-08-12P	3.43	(87)		E6-80L-32	E6-800L-32-12	E6-800L-32-12P	12.80	(325)	
E6-80L-10	E6-800L-10-12	E6-800L-10-12P	3.94	(100)		E6-80L-33	E6-800L-33-12	E6-800L-33-12P	13.27	(337)	
E6-80L-11	E6-800L-11-12	E6-800L-11-12P	4.41	(112)		E6-80L-35	E6-800L-35-12	E6-800L-35-12P	13.78	(350)	
E6-80L-12	E6-800L-12-12	E6-800L-12-12P	4.92	(125)		E6-80L-36	E6-800L-36-12	E6-800L-36-12P	14.25	(362)	
E6-80L-13	E6-800L-13-12	E6-800L-13-12P	5.39	(137)		E6-80L-37	E6-800L-37-12	E6-800L-37-12P	14.76	(375)	
E6-80L-15	E6-800L-15-12	E6-800L-15-12P	5.91	(150)		E6-80L-38	E6-800L-38-12	E6-800L-38-12P	15.24	(387)	
E6-80L-16	E6-800L-16-12	E6-800L-16-12P	6.38	(162)		E6-80L-40	E6-800L-40-12	E6-800L-40-12P	15.75	(400)	
E6-80L-17	E6-800L-18-12	E6-800L-18-12P	6.89	(175)		E6-80L-41	E6-800L-41-12	E6-800L-41-12P	16.72	(412)	
E6-80L-18	E6-800L-18-12	E6-800L-18-12P	7.36	(187)		E6-80L-42	E6-800L-42-12	E6-800L-42-12P	16.73	(425)	
E6-80L-20	E6-800L-20-12	E6-800L-20-12P	7.87	(200)		E6-80L-43	E6-800L-43-12	E6-800L-43-12P	17.20	(437)	
E6-80L-21	E6-800L-21-12	E6-800L-21-12P	8.35	(212)		E6-80L-45	E6-800L-45-12	E6-800L-45-12P	17.72	(450)	
E6-80L-22	E6-800L-23-12	E6-800L-23-12P	8.86	(225)		E6-80L-46	E6-800L-46-12	E6-800L-46-12P	18.19	(462)	
E6-80L-23	E6-800L-23-12	E6-800L-23-12P	9.33	(237)		E6-80L-47	E6-800L-47-12	E6-800L-47-12P	18.70	(475)	
E6-80L-25	E6-800L-25-12	E6-800L-25-12P	9.84	(250)		E6-80L-48	E6-800L-48-12	E6-800L-48-12P	19.17	(487)	
E6-80L-26	E6-800L-26-12	E6-800L-26-12P	10.31	(262)		E6-80L-50	E6-800L-50-12	E6-800L-50-12P	19.69	(500)	
E6-80L-27	E6-800L-28-12	E6-800L-28-12P	10.83	(275)		E6-80L-51	E6-800L-51-12	E6-800L-51-12P	20.16	(512)	
E6-80L-28	E6-800L-29-12	E6-800L-29-12P	11.30	(287)		E6-80L-52	E6-800L-52-12	E6-800L-52-12P	20.67	(525)	
E6-80L-30	E6-800L-30-12	E6-800L-30-12P	11.81	(300)		E6-80L-53	E6-800L-53-12	E6-800L-53-12P	21.14	(537)	
E6-80L-31	E6-800L-31-12	E6-800L-31-12P	12.28	(312)		E6-80L-55	E6-800L-55-12	E6-800L-55-12P	21.65	(550)	

PDF: igus.com/e-chain-pdfs
Product information: igus.com/e-chains

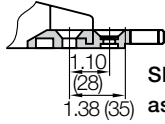
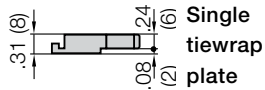

Tiewrap Plates

 Shown
 assembled

 Single
 tiewrap
 plate

Option 1:
Tiewrap plates as an individual part

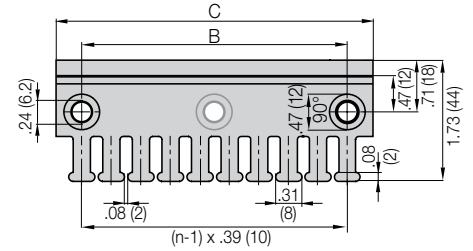
Available as an individual component, can be fixed onto a mounting bracket with the use of a profile rail.

Tiewrap Plate	n Number of Teeth	C Overall Width in. (mm)	B Bore Width in. (mm)	Center Bore
3050-ZB	5	1.97 (50)	1.18 (30)	no
3075-ZB	7	2.95 (75)	2.16 (55)	no
3100-ZB	10	3.94 (100)	3.15 (80)	no
3115-ZB	11	4.53 (115)	3.74 (95)	no
3125-ZB	12	4.92 (125)	4.13 (105)	no
3150-ZB	15	5.91 (150)	5.12 (130)	no
3175-ZB	17	6.89 (175)	6.10 (155)	no
3200-ZB	20	7.87 (200)	7.09 (180)	yes
3225-ZB	22	8.86 (225)	8.07 (205)	yes
3250-ZB	25	9.84 (250)	9.06 (230)	yes



If used with KMA brackets with profile rail please add "KMA" to the end of the part number.

Example: 3050-ZBKMA
Other strain relief elements

 ► **Strain Relief, Chapter 10**

PDF: igus.com/e-chain-pdfs
Product information: igus.com/e-chains







e-skin

Novel energy supply system for cleanrooms



- Hose consisting of an upper and lower shell that form a complete enclosure when connected together
- Easy filling with “zipper” function
- Special design allows unsupported lengths
- Less installation space required
- Cable-friendly with defined minimum bend radius
- Available with interior separation
- Prevents unintentional sideways movement
- Simple maintenance and inspection of the cables inside
- Protection against dust and water ingress
- Suitable for cleanrooms according to **IPA ISO class 1**



When to use another e-chain® series:

- For longer unsupported lengths
 - ▶ **E3**
 - ▶ **E6.1**
- For higher speeds
 - ▶ **E3,**
 - ▶ **E6.1**
- For high exposure to dirt
 - ▶ **RX e-tubes**



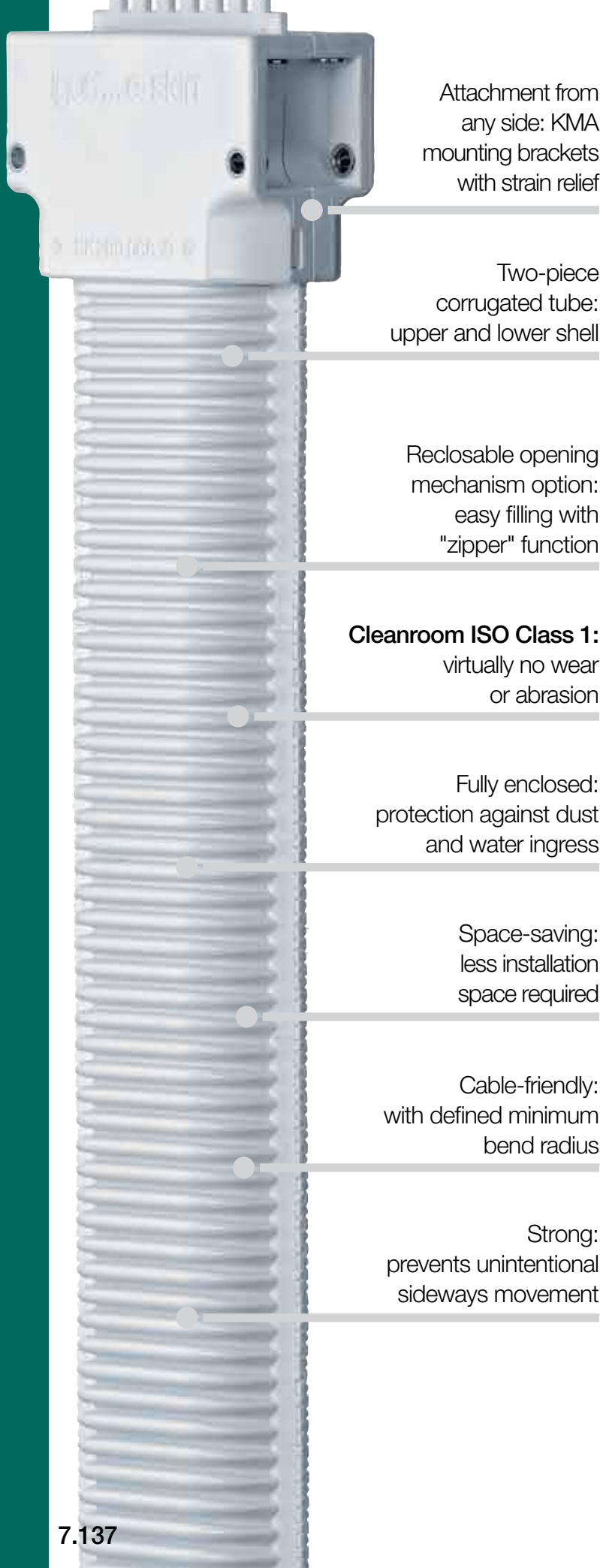

Attachment from any side: KMA mounting brackets with strain relief

Two-piece corrugated tube: upper and lower shell

Reclosable opening mechanism option: easy filling with "zipper" function

Cleanroom ISO Class 1: virtually no wear or abrasion

Fully enclosed: protection against dust and water ingress

Space-saving: less installation space required

Cable-friendly: with defined minimum bend radius

Strong: prevents unintentional sideways movement

Novel energy supply system for cleanrooms - e-skin[®]

e-skin[®] is a hose consisting of an upper and lower shell that form a complete enclosure when connected together. The simple and reclosable opening mechanism enables easy maintenance and inspection of the cables inside. e-skin[®] has many advantages over conventional corrugated tubes.

- Special design allows unsupported lengths
- Openable, quick assembly
- Available with interior separation
- Less installation space required
- Protection against dust and water ingress

Typical industries and applications

- Cleanroom ● Pick & Place ● Printers ● Any machine that uses corrugated hoses



Easy filling, can be opened and closed like a zipper



IPA Qualification Certificate2) - Report IG 1504-755:

e-skin[®] **RBR** (prototype) tested at
 $v = 1.64 \text{ ft/s (0.5m/s)}, 3.28 \text{ ft/s (1m/s)}, 6.56 \text{ ft/s (2m/s)}$ and
 $a = 3.28 \text{ ft/s}^2 (1\text{m/s}^2), 6.56 \text{ ft/s}^2 (2\text{m/s}^2), 13.12 \text{ ft/s}^2 (4\text{m/s}^2)$

e-skin® - Selection table

Series	Inner height h_i in. (min)	Inner width B_i in. (min)	Outer width B_a in. (min)	Outer height h_a in. (min)	Bend radius $R_{min}^{1)}$ in. (min)
--------	---------------------------------	--------------------------------	--------------------------------	---------------------------------	---



**e-skin® -
oval design**
Can be opened and closed like a zipper

SK28	1.10 (28)	2.68 (68)	3.74 (95)	1.57 (40)	2.17 (055)
SK40	1.50 (38)	3.35 (85)	4.65 (118)	2.24 (57)	3.94 (100)

¹⁾Note: The minimum bend radius is determined by the bottom of the e-skin® tube!



Available from stock. Orders ship as early as today.*

*On average 90% of orders ship the same day..



With the e-skin®, igus® offers a modular corrugated tube with a self-supporting function for energy supply in the smallest possible space. The product is certified in accordance with IPA ISO Class 1 and can be used in cleanrooms. e-skin® provides systems with data, media and energy without generating airborne particles through friction which could contaminate the room.

The corrugated tube is made up of abrasion-resistant plastic and its separable upper and lower shells can be easily put together by a "zipper" to a fully enclosed tube. This simultaneously guarantees cleanroom suitability as well as offering quick filling with cables.

e-chain system® e-skin® - Comparison e-skin® vs. conventional corrugated tubes

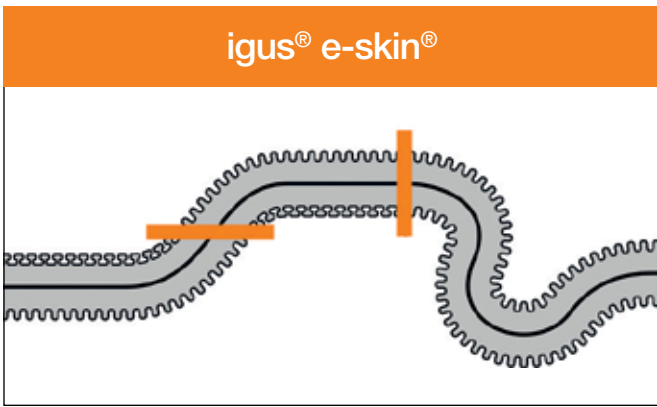

e-skin® consists of two shells (upper and lower). The shells can be configured in order to define movement

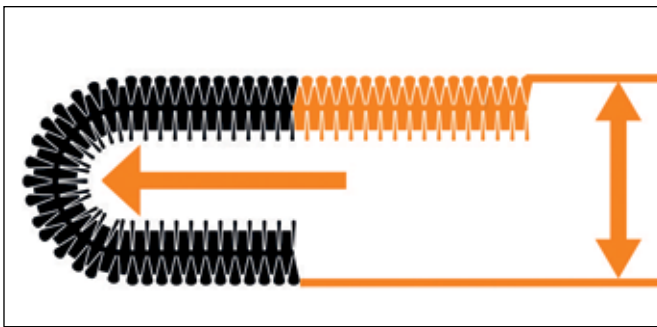

e-skin® is suitable for short unsupported lengths

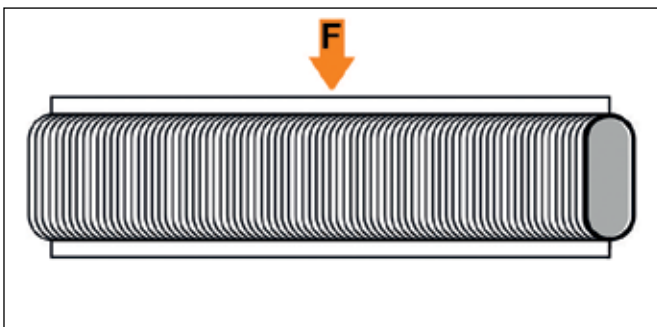

Lateral stability thanks to an oval geometry of the e-skin®

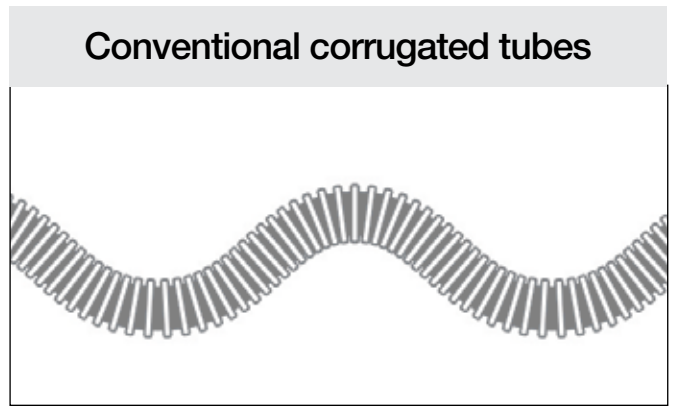

Corrugated tubes have the same bend radius along their entire length

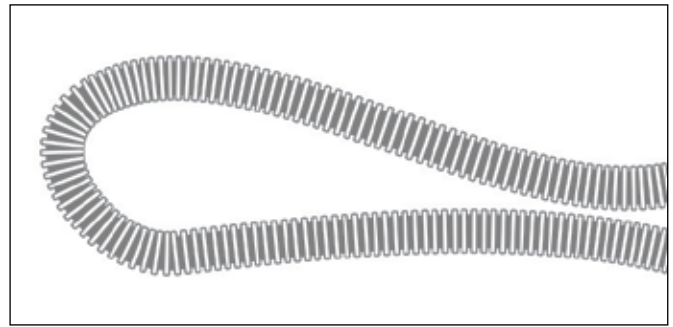

Corrugated tubes cannot be used for unsupported applications

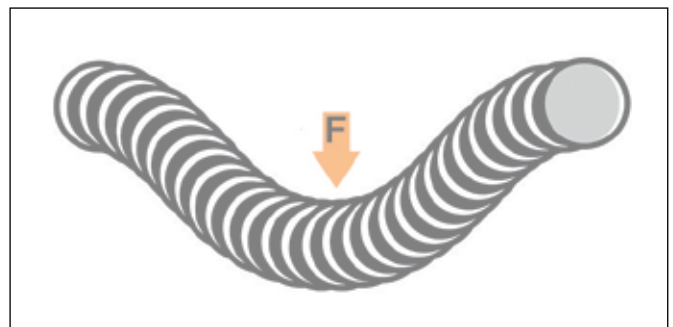

Very little, if any stability in respect of forces acting on the sides

e-chain system® e-skin® - Comparison e-skin® vs. conventional corrugated tubes

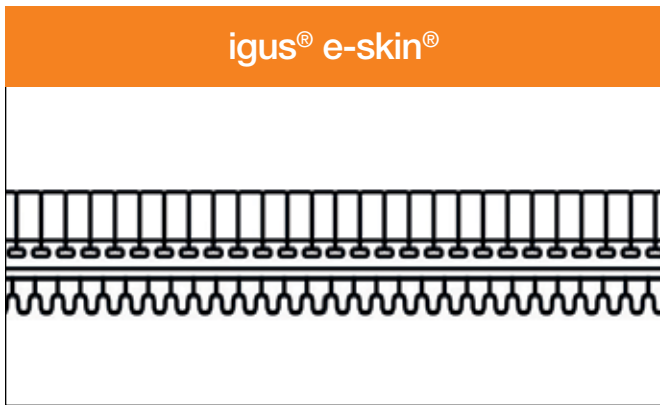

e-skin® supports itself

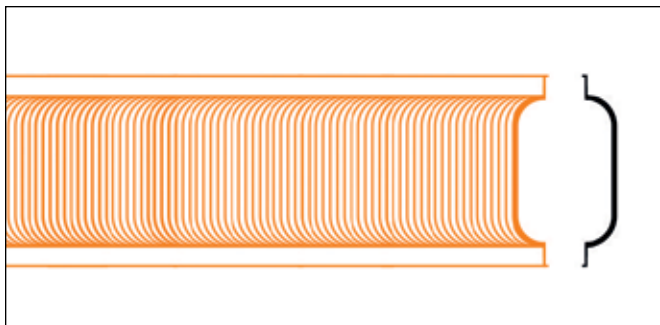

e-skin® is openable, easy to fill

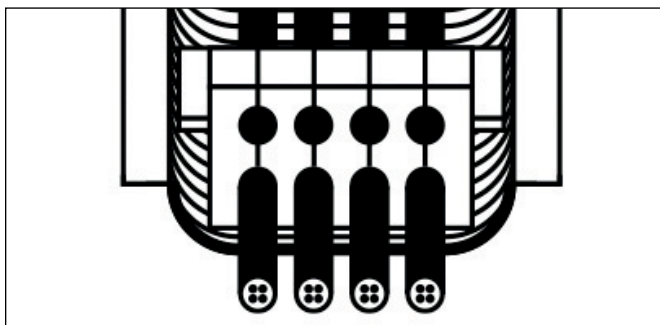

e-skin® can be fitted with interior separation

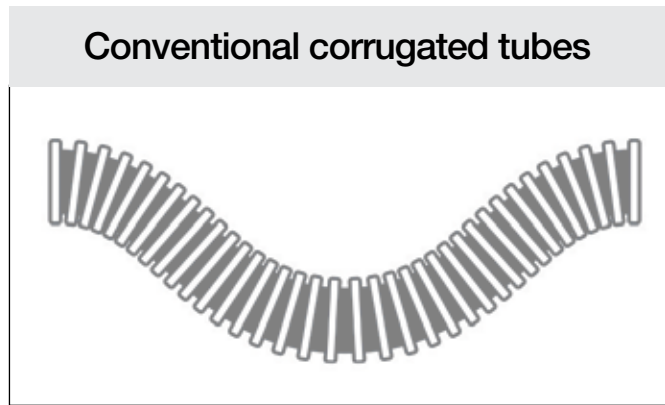

Corrugated tubes have very little any inherent rigidity. e-rib solves this ► **Chapter 2**

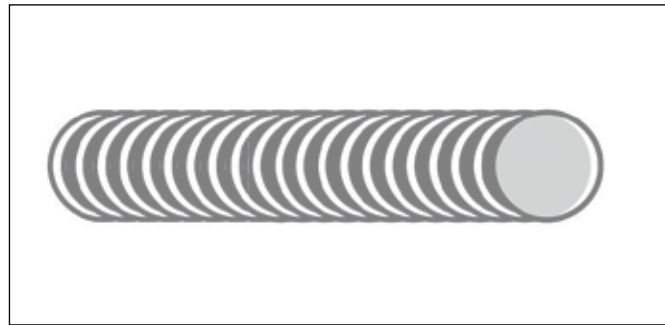

Corrugated tubes (for dynamic applications) cannot be opened

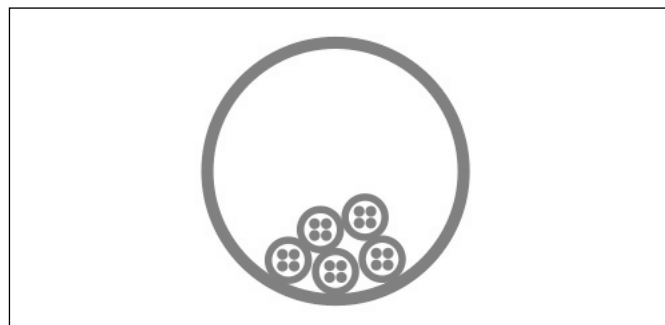

The interior of corrugated tubes cannot be divided into sections

Price Index

Series SK28

Special Options Available

Especially suitable for cleanroom environments

Assembly Tips

Option: Easy filling, can be opened and closed like a zipper

Other Installation Methods

Vertical, hanging - upon request

Vertical, standing - upon request

Side-mounted, un_supp. - upon request

Usage Guidelines



- When easy filling is required
- When less installation space required
- When protection against dust and water egress is necessary
- When cleanroom ISO Class 1 is required



- For longer unsupported lengths
 - Series E3
 - Series E6.1
- For higher speeds
 - Series E3
 - Series E6.1
- For high exposure to dirt
 - Series RX tubes

Features & Benefits

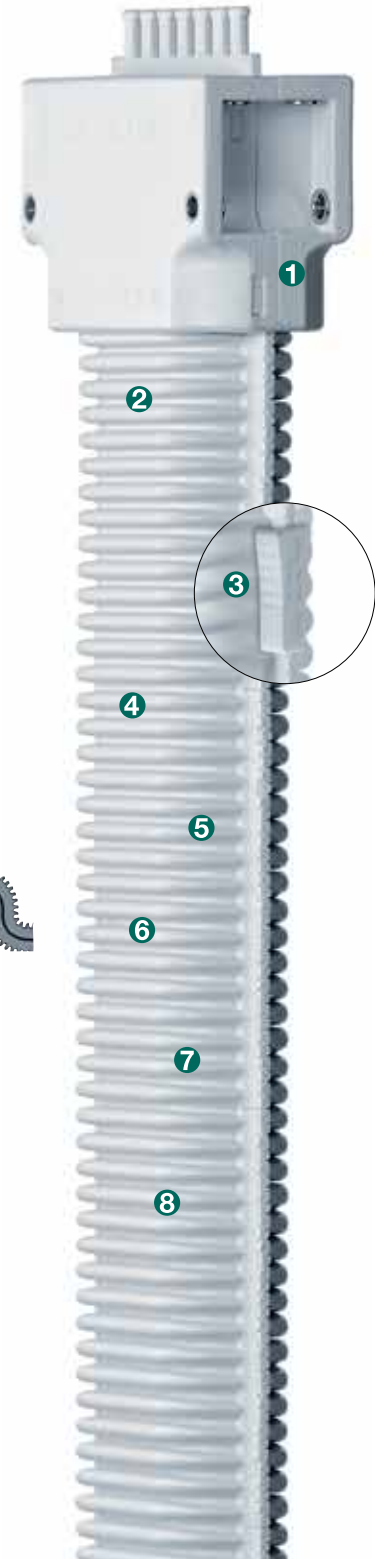
- 1 Attachment from any side: KMA mounting brackets with strain relief
- 2 Two-piece corrugated tube: upper and lower shell
- 3 Reclosable opening mechanism option: easy filling with zipper function
- 4 Cleanroom ISO Class 1: virtually no wear or abrasion
- 5 Fully enclosed: protection against dust and water egress
- 6 Space saving: less installation space required
- 7 Cable friendly: with defined minimum bend radius
- 8 Strong: prevents unintentional sideways movement
- 9 Also available with Reverse Bend Radius "RBR"

Order Example: Complete e-chain®

Please indicate chain length or number of links. Example:

3.28 ft (1000 mm) **SK28.068.02.1** (specify in mm)**e-chain®****SK28.1.1.01** fitted every 112 mm**Interior Separation**1 Set KMA with tiewrap plates **SK280.068.12.1****Mounting Bracket**

e-chain system® e-skin® Series SK28 Installation Dimensions

Short travel, unsupported length

● FL_G = unsupported with straight upper run

Further information ► Design, Chapter 1

igus®

SK28

1.10

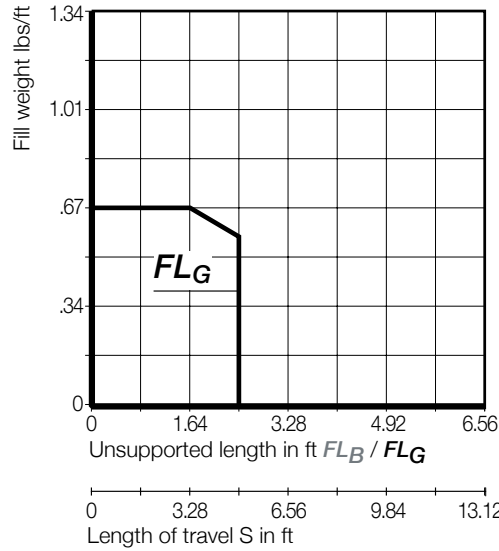

Short Travels - Unsupported

Unsupported e-chains® feature positive camber over short travels. This must be accounted for when specifying the clearance height. Please refer to **Installation dimensions** for further details.

Legend

- S = Length of travel
- R = Bending radius
- H = Nominal clearance height
- D = Overlength e-chain® radius in final position
- $K = \pi \cdot R + \text{safety buffer}$
- H_r = Required clearance height

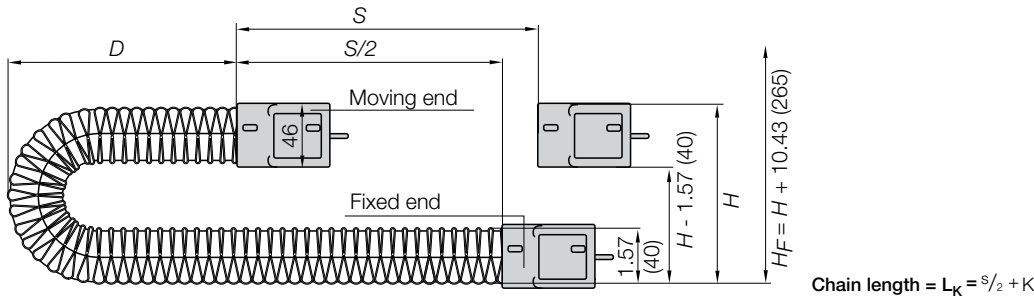

The required clearance height: $H_r = H + 10.43$ in. (265 mm) (with .50 lbs/ft (0.75 kg/m) fill weight). Please consult igus® if space is particularly restricted.

R_{min}^*	2.16 (055)	*NOTE: The minimum bend radius is determined by the bottom of the e-skin® tube!
H	9.84 (250)	No bend radius is specified in the part number since it depends on travel and fill weight. The smallest specified radius below is the minimum to guarantee the service life of the cables. In most applications,
D	6.30 (160)	however, the radius remains larger because the shape of the tube defines this.
K	15.71 (399)	

PDF: igus.com/e-chain-pdfs
Product information: igus.com/e-chains



Speed / acceleration FL_G	max. 32.8 ft/s (10 m/s) / max. 246 ft/s ² (75 m/s ²)
Speed / acceleration FL_B	upon request
Material, e-chain® - permitted temperature	igumid SK / +50°F (+10°C) up to +122°F (+50°C)
Material, mounting bracket - permitted temperature	igumid NB / +50°F (+10°C) up to +122°F (+50°C)
Flammability Class, igumid G	UL94 HB

Technical Data



Details of material properties
► Chapter 1

7.142

Series SK28 - Oval design - Can be opened and closed like a zipper

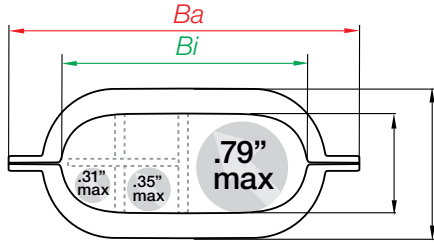

Part Number Structure

SK 28.068.02.1



Part No.	Bi	Ba	hi	ha	R bend radii	SK28
e-chain®	in. (mm)	in. (mm)	in. (mm)	in. (mm)	(mm)	lbs/ft (kg/m)
SK28.068.02.1	2.68 (68)	3.74 (95)	1.10 (28)	1.57 (40)	2.16 (055)	≈ 0.362 (0.54)

*Note: The minimum bend radius is determined by the bottom of the e-skin® tube!

Series SK28 - Interior Separation

e-skin separators should be fitted every 112mm onto the connection points!

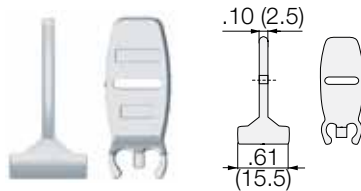

Separator, narrow head

Unassembled Part No. SK28.1.01

Assembled Part No. SK28.1.1.01

Full-width shelves - for the standard interior separation

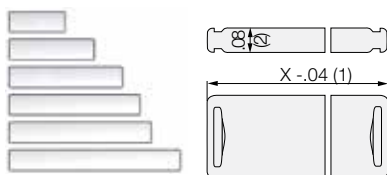

Full width shelf

Unassembled Part No. 110.63.1

Assembled Part No. 111.63.1

Vertical separator

The interior separation system for the igus® e-skin® consists of individual separators and full-width shelves, which can be fitted in a variety of ways.

Full width shelf

is used in applications with many small cables with similar diameters.

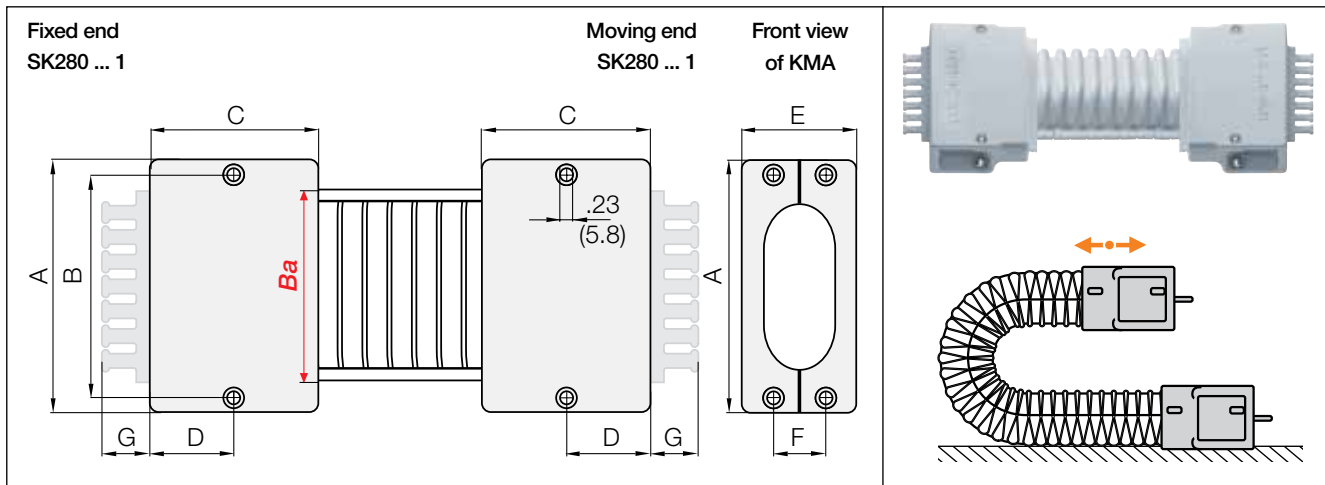

KMA | Recommended for unsupported, vertical hanging, standing applications

Width index	Part No. full set without tiewrap plates	Part No. full set with tiewrap plates	A in. (mm)	B in. (mm)	C in. (mm)	D in. (mm)	E in. (mm)	F in. (mm)	G in. (mm)	Number of teeth
068.	▶ SK280.068.12.1	SK280.068.12ZB.1	4.09 (104)	3.62 (92)	2.68 (68)	1.38 (35)	1.81 (46)	.83 (21)	.71(18)	7

(KMA = polymer metal mounting bracket)



Absolutely dust-free environment for printed-circuit-board production using the abrasion-resistant e-skin® from igus®

PDF: igus.com/e-chain-pdfs
 Product information: igus.com/e-chains



Price Index

Series SK40

Special Options Available

Especially suitable for cleanroom environments

Assembly Tips

Option: Easy filling, can be opened and closed like a zipper

Other Installation Methods

Vertical, hanging - upon request

Vertical, standing - upon request

Side-mounted, un_supp. - upon request

Usage Guidelines



- When easy filling is required
- When less installation space required
- When protection against dust and water egress is necessary
- When cleanroom ISO Class 1 is required



- For longer unsupported lengths
 - Series E3
 - Series E6.1
- For higher speeds
 - Series E3
 - Series E6.1
- For high exposure to dirt
 - Series RX tubes

Features & Benefits

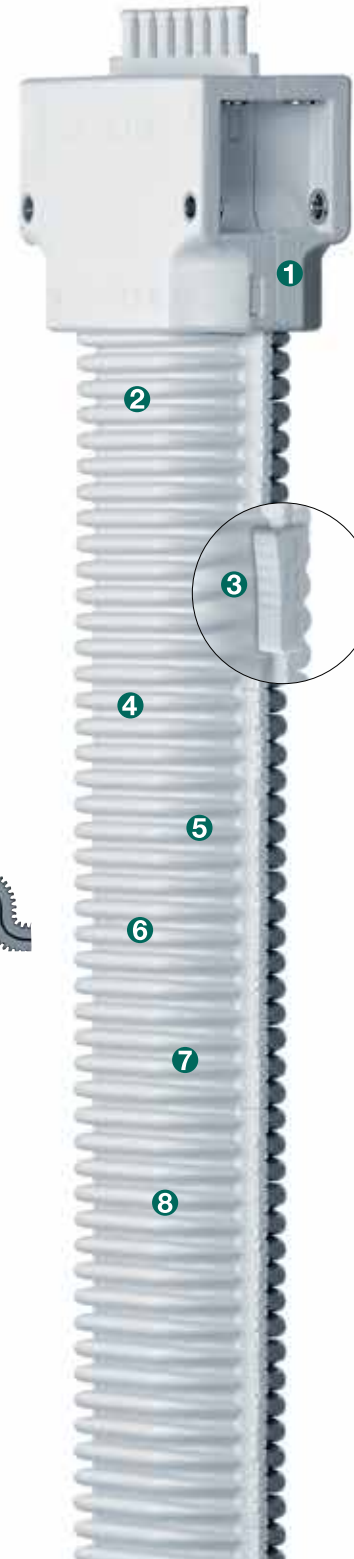
- 1 Attachment from any side: KMA mounting brackets with strain relief
- 2 Two-piece corrugated tube: upper and lower shell
- 3 Reclosable opening mechanism option: easy filling with zipper function
- 4 Cleanroom ISO Class 1: virtually no wear or abrasion
- 5 Fully enclosed: protection against dust and water egress
- 6 Space saving: less installation space required
- 7 Cable friendly: with defined minimum bend radius
- 8 Strong: prevents unintentional sideways movement
- 9 Also available with Reverse Bend Radius "RBR"

Order Example: Complete e-chain®

Please indicate chain length or number of links. Example:

3.28 ft (1000 mm) **SK40.085.02.1** (specify in mm)**e-chain®****SK40.1.1.01** fitted every 112 mm**Interior Separation**1 Set KMA with tiewrap plates **SK400.085.12.1****Mounting Bracket**

e-chain system® e-skin® Series SK40 Installation Dimensions

Short travel, unsupported length

● FL_G = unsupported with straight upper run

Further information ► Design, Chapter 1

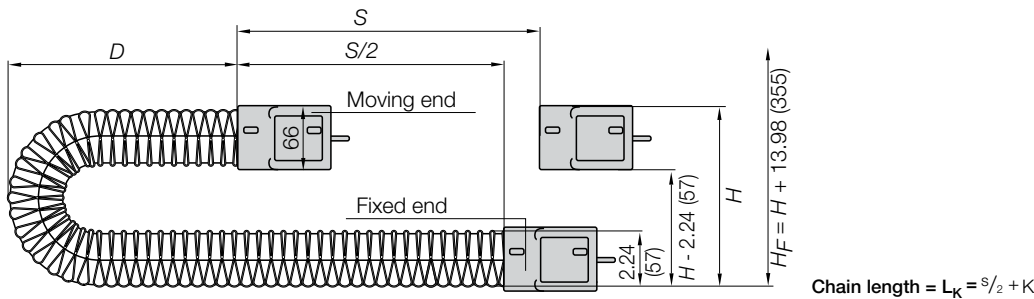
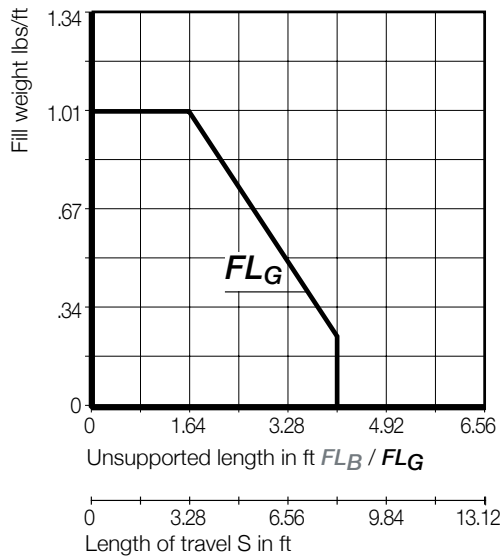

The required clearance height: $H_F = H + 13.98$ in. (355 mm) (with .50 lbs/ft (0.75 kg/m) fill weight). Please consult igus® if space is particularly restricted.

R_{min}^*	3.94 (100)	*NOTE: The minimum bend radius is determined by the bottom of the e-skin® tube! No bend radius is specified in the part number since it depends on travel and fill weight. The smallest specified radius below is the minimum to guarantee the service life of the cables. In most applications, however, the radius remains larger because the shape of the tube defines this.
H	13.78 (350)	
D	11.81 (300)	
K	27.28 (693)	



SK40

Short Travels -
Unsupported

1.50

Unsupported e-chains® feature positive camber over short travels. This must be accounted for when specifying the clearance height. Please refer to **Installation dimensions** for further details.

Legend

- S = Length of travel
- R = Bending radius
- H = Nominal clearance height
- D = Overlength e-chain® radius in final position
- $K = \pi \cdot R + \text{safety buffer}$
- H_F = Required clearance height

PDF: igus.com/e-chain-pdfs
Product information: igus.com/e-chains



Speed / acceleration FL_G	max. 32.8 ft/s (10 m/s) / max. 246 ft/s ² (75 m/s ²)
Speed / acceleration FL_B	upon request
Material, e-chain® - permitted temperature	igumid SK / +50°F (+10°C) up to +122°F (+50°C)
Material, mounting bracket - permitted temperature	igumid NB / +50°F (+10°C) up to +122°F (+50°C)
Flammability Class, igumid G	UL94 HB

Technical Data



Details of material properties

► Chapter 1

7.146

Series SK40 - Oval design - Can be opened and closed like a zipper

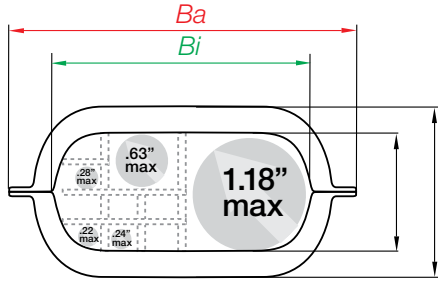

Part Number Structure

SK 40.085.02.1



Part No.	Bi	Ba	hi	ha	R bend radii	SK40
e-chain®	in. (mm)	in. (mm)	in. (mm)	in. (mm)	(mm)	lbs/ft (kg/m)
SK40.085.02.1	3.35 (85)	4.65 (118)	1.50 (38)	2.24 (57)	3.94 (100)	≈ 0.773 (1.15)

*Note: The minimum bend radius is determined by the bottom of the e-skin® tube!

Series SK40 - Interior Separation

e-skin separators should be fitted every 112mm onto the connection points!

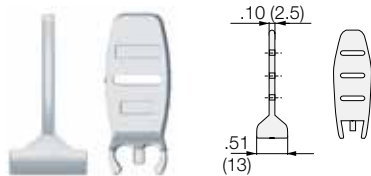

Separator, narrow head

Unassembled Part No. SK40.1.01

Assembled Part No. SK40.1.1.01

Vertical separator

The interior separation system for the igus® e-skin® consists of individual separators and full-width shelves, which can be fitted in a variety of ways.

Full-width shelves - for the standard interior separation

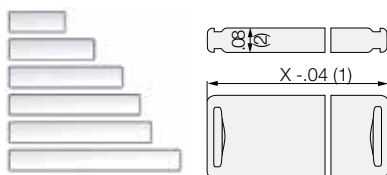

Full width shelf

Unassembled Part No. 110.80.1

Assembled Part No. 111.80.1

Full width shelf

is used in applications with many small cables with similar diameters.

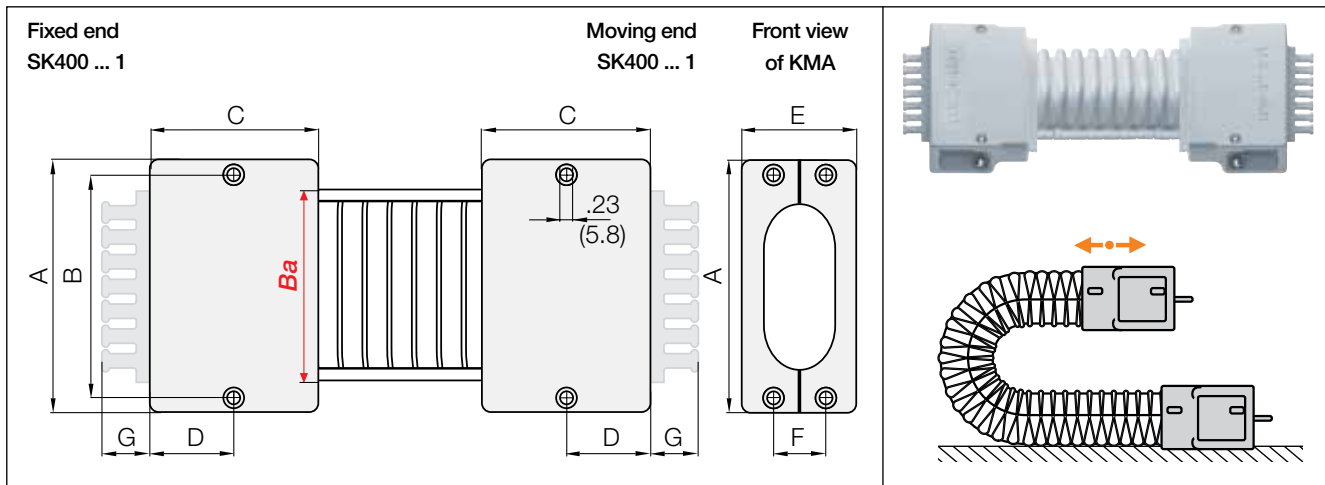

KMA | Recommended for unsupported, vertical hanging, standing applications

Width index	Part No. full set with tie-wrap plates	Part No. full set without tie-wrap plates	A in. (mm)	B in. (mm)	C in. (mm)	D in. (mm)	E in. (mm)	F in. (mm)	G in. (mm)	Number of teeth
085.	▶ SK400.085.12.1	SK400.085.12ZB.1	4.92 (125)	4.45 (113)	2.68 (68)	1.38 (35)	2.60 (66)	1.61 (41)	.71 (18)	10

(KMA = polymer metal mounting bracket)



The igus® e-skin® e-chain® can be used for short unsupported lengths in cleanrooms

PDF: igus.com/e-chain-pdfs
 Product information: igus.com/e-chains



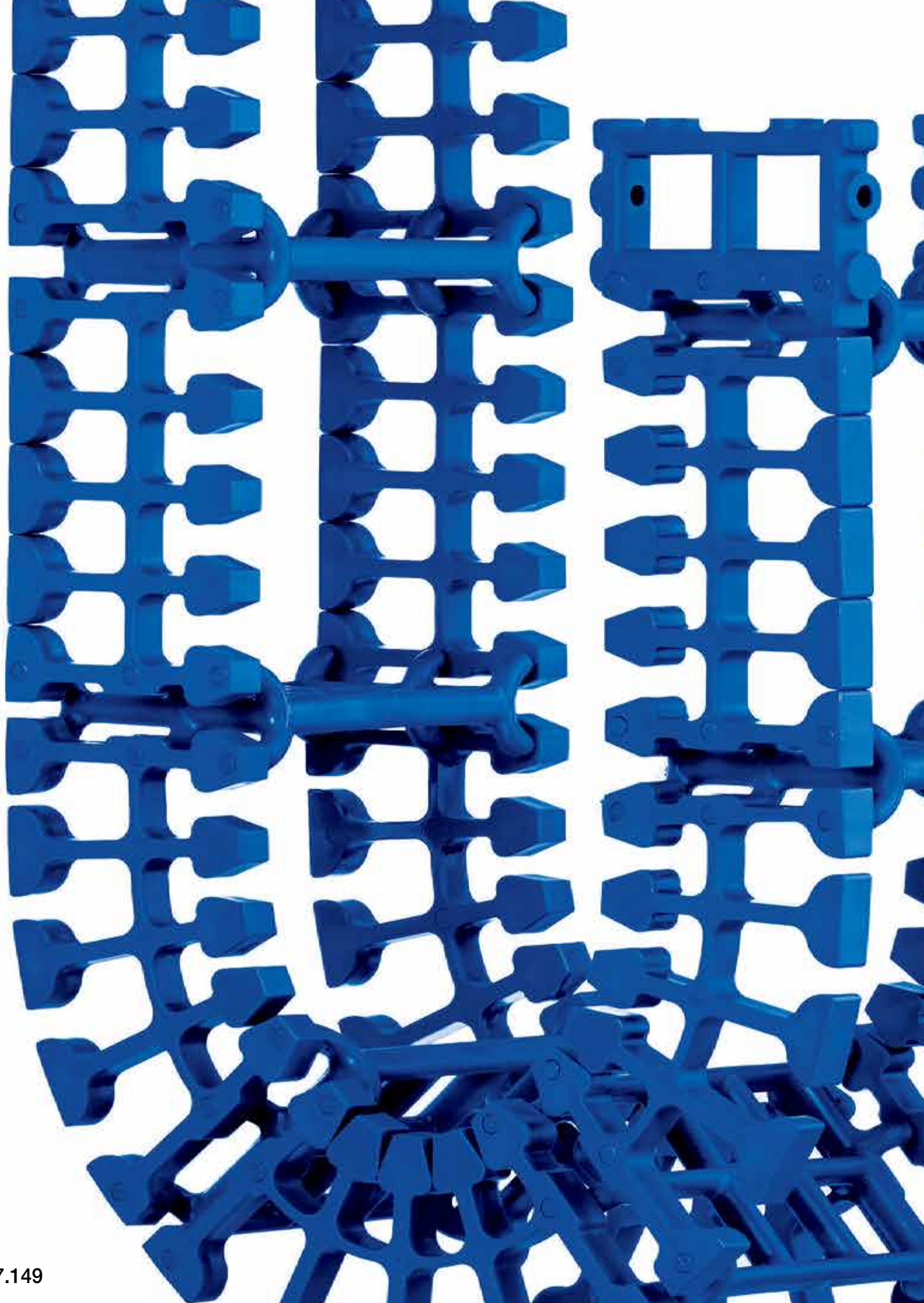



TH3

The first e-chain[®] designed according to hygienic principles



Advantages of the TH3 system:

- The first e-chain[®] designed according to hygienic principles
- Easy to clean due to open design
- FDA- and EU-compliant materials - blue material, typical for plastic parts in the food industry (consists of igumid TH NB for the side parts and igumid TH G for the frames and mounting brackets)
- Good resistance to aggressive cleaning agents and chemicals
- Rounded edges mean that there are no dead spaces or resulting germ formation
- No material on material rubbing
- No bolted connections
- Operating temperature -40°F / +158°F
- reddot award winner 2017



When to use another igus[®] e-chain[®] series:

- When hygienic design does not matter but cleanroom capability is required
 - ▶ T3
- When Cleanroom ISO Class 1 is required
 - ▶ E6.1

The first e-chain[®] designed according to hygienic principles - TH3

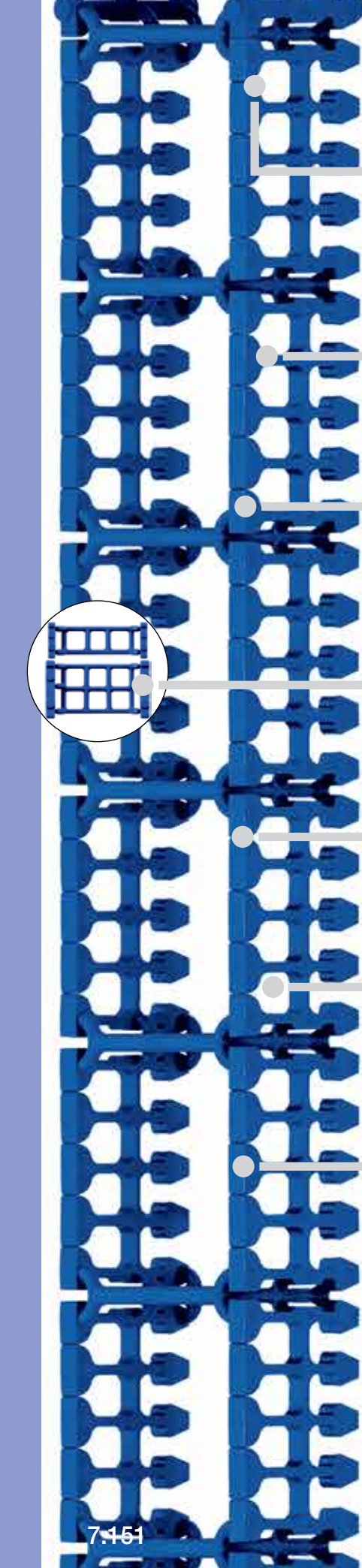

Attachment from any side:
polymer mounting
brackets

Easy to clean:
open design for effective
and easy cleaning

Hygienic design principle:
FDA-compliant materials

Modular design:
4 different widths for
interior separation,
available in 2 inner heights

Cable-friendly:
due to smooth,
rounded contours

No dead spaces:
large gaps - no
material overlaps

Food industry material:
resistant to detergents
and chemicals

The igus[®] TH3 e-chain[®] is the world's first plastic e-chain[®] developed according to "Hygienic Design Guidelines". The open design of the e-chain[®] is very easy to clean and, thanks to rounded corners and the absence of bolted connections, dead spaces and the resulting germ formation are avoided. The blue material, which is typical of plastic parts in the food industry, is also highly resistant to aggressive cleaning agents and chemicals. The e-chain[®] is suitable for applications with the highest hygienic requirements for safe cable and hose guidance.

- Choice of 2 inner heights and 4 inner widths
- Interior separation segments separate the cables and hoses from each other to provide enough clearance for easy cleaning
- For plastic parts in the food industry, the blue material is FDA-compliant
- reddot award winner 2017

Typical industries and applications

- Packaging machines
- Food and beverage/filling machines
- Wherever hygiene requirements are very high and cables and hoses have to be guided safely and securely



reddot award 2017
winner









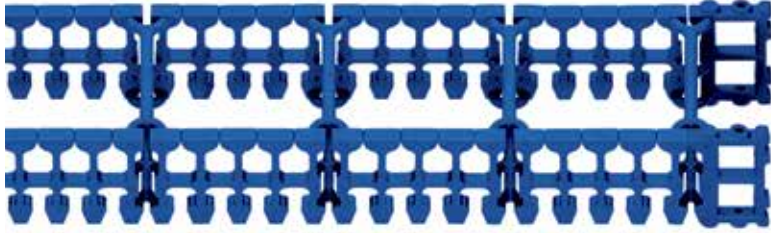

The material of the igus[®] hygienic design e-chain[®] is FDA and EU regulation-compliant

TH3 - Selection table

Segment design	Series	Inner height h_i in. (mm)	Inner width B_i in. (mm)	Outer width B_a in. (mm)	Outer height h_a in. (mm)	Bend radius R in. (mm)	Unsupported length \leq ft (m)
----------------	--------	--------------------------------	-------------------------------	-------------------------------	--------------------------------	-----------------------------	----------------------------------



**System TH3 -
hygienic design e-chain®**
3-piece, hygienic design
consisting of two side parts and an
interior separation segment

2-segment  	TH3.25.2/26	1.00 (25.5)	2.76 (70)	3.39 (86)	1.38 (35)	2.76 (070)	3.94 (1.2)
	TH3.45.2/20	2 x .79 (20)	2.76 (70)	3.54 (90)	2.24 (57)	3.54 (090)	4.59 (1.4)
3-segment  	TH3.25.3/26	1.00 (25.5)	3.74 (95)	4.37 (111)	1.38 (35)	2.76 (070)	3.94 (1.2)
	TH3.45.3/20	2 x .79 (20)	3.74 (95)	4.53 (115)	2.24 (57)	3.54 (090)	4.59 (1.4)
4-segment  	TH3.25.4/26*	1.00 (25.5)	4.72 (120)	5.35 (136)	1.38 (35)	2.76 (070)	3.94 (1.2)
	TH3.45.4/20*	2 x .79 (20)	4.72 (120)	5.51 (140)	2.24 (57)	3.54 (090)	4.59 (1.4)
5-segment  	TH3.25.5/26*	1.00 (25.5)	5.71 (145)	6.34 (161)	35 1.38 (35)	2.76 (070)	3.94 (1.2)
	TH3.45.5/20	2 x .79 (20)	5.71 (145)	6.50 (165)	2.24 (57)	3.54 (090)	4.59 (1.4)

*Width available upon request. Please consult igus® for delivery time.



Available from stock. Ready to ship in 24 - 48 hrs.*

*The delivery times indicated correspond to the average time until the ordered goods are dispatched.

Size overview - Interior separation segments

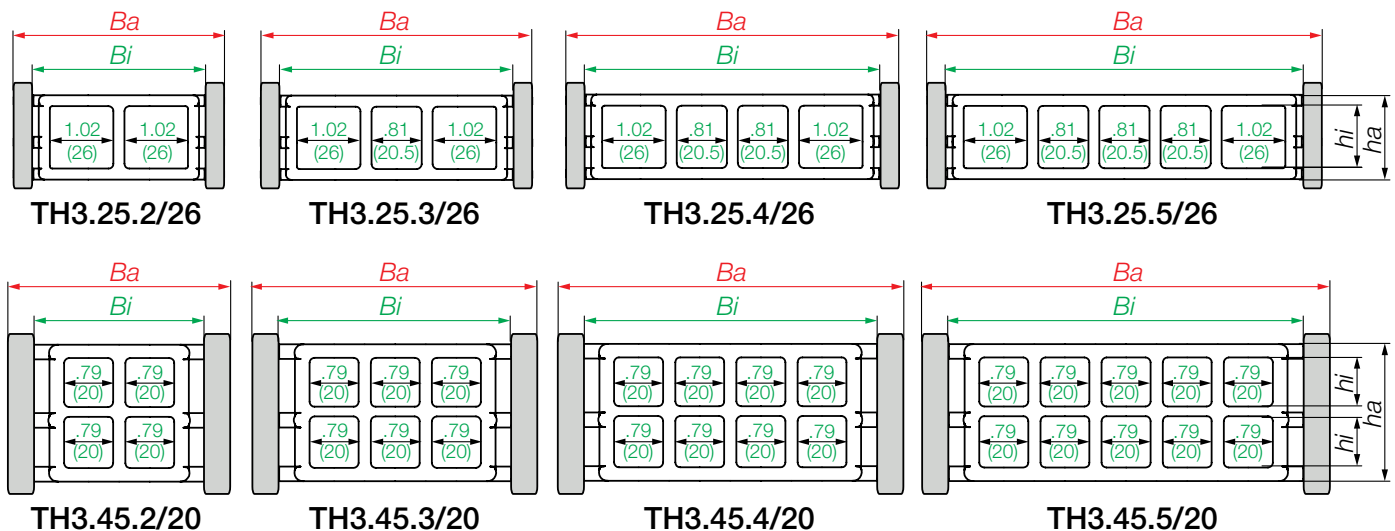

Price Index

Series TH3.25

Special Options Available

Especially suitable for clean-room environments

ESD classification:
Electrically conductive ESD version upon request
Assembly Tips
Side segments of the e-chain[®] are connected using the interior separation segments
Other Installation Methods

Vertical, hanging ≤ 19.68 ft (6 m)

Vertical, standing ≤ 5.91 ft (1.8 m)

Usage Guidelines



- When an FDA/EU compliant material is required
- If an easy to clean open design is needed
- If good resistance to aggressive cleaning agents and chemicals is required



- When a hygienic design is not required
 - **Series T3**
- When cleanroom ISO Class 1 is required
 - **Series E6.1**

Features & Benefits

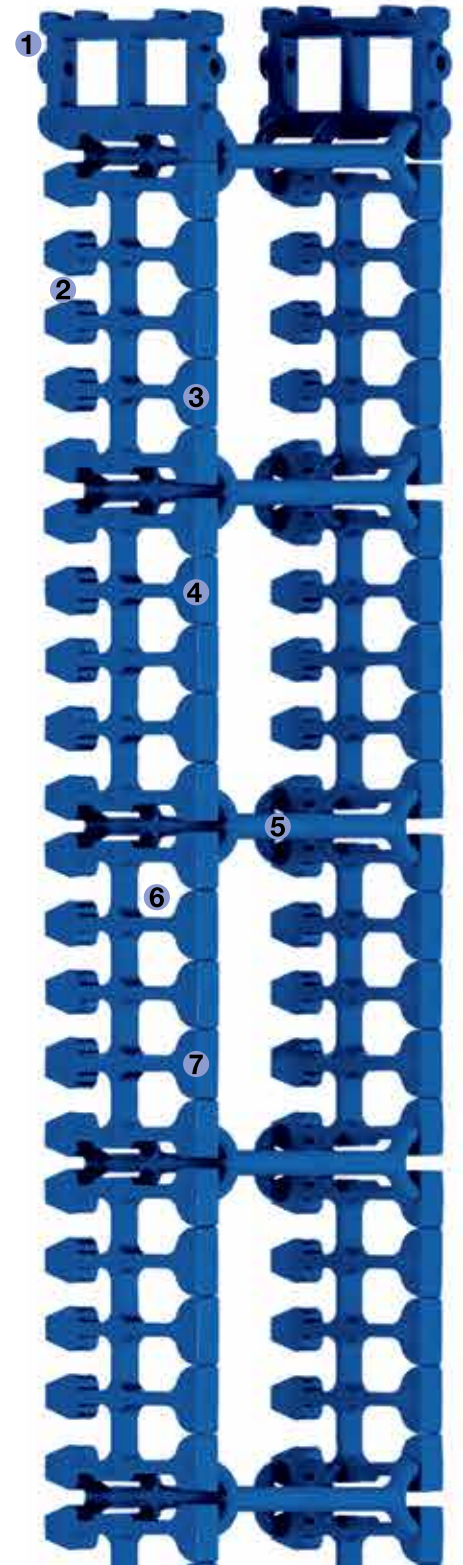
- 1 Attachment from any side: polymer mounting brackets
- 2 Easy to clean: open design for effective and easy cleaning
- 3 Hygienic design principle: FDA-compliant materials
- 4 Cable friendly due to smooth rounded contours
- 5 4 different widths for interior separation
- 6 No dead spaces. Large gaps - no material overlaps
- 7 Food industry material - resistant to detergents and chemicals

Order Example: Complete e-chain[®]

Please indicate chain length or number of links. Example:

3.28 ft (1 m) **TH3.25.3/26.070.8****e-chain[®]**The interior separation segments connect the side parts of the e-chain[®] and are included in the part number of the e-chain[®]**Interior Separation**1 Set **TH3.250.3/26.12.8****Mounting Bracket**

e-chain system® TH3

Series TH3.25

Installation Dimensions



TH3.25

Short travel, unsupported length

● FL_G = unsupported with straight upper run

Further information ► Design, Chapter 1

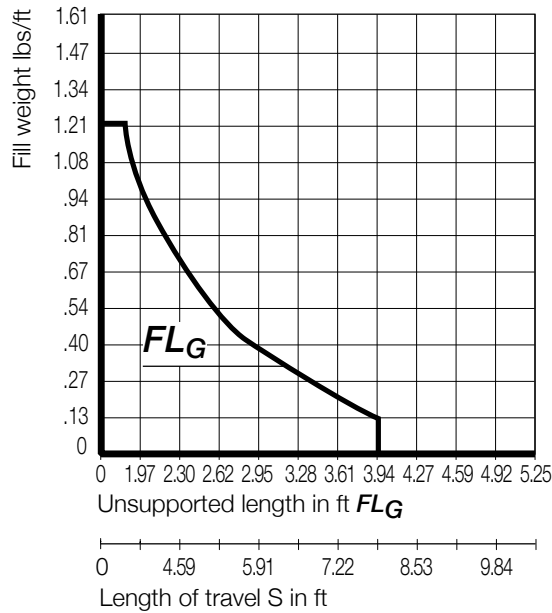

Short Travels - Unsupported

Unsupported e-chains® feature positive camber over short travels. This must be accounted for when specifying the clearance height. Please refer to **Installation dimensions** for further details.

Legend

- S = Length of travel
- R = Bending radius
- H = Nominal clearance height
- D = Overlength e-chain® radius in final position
- $K = \pi \cdot R + \text{safety buffer}$
- H_r = Required clearance height
- H_i = Trough inner height
- H_m = *Mounting height
- D = Overlength - long travels, gliding
- K_r = *Add-on

*If the mounting bracket location is set lower

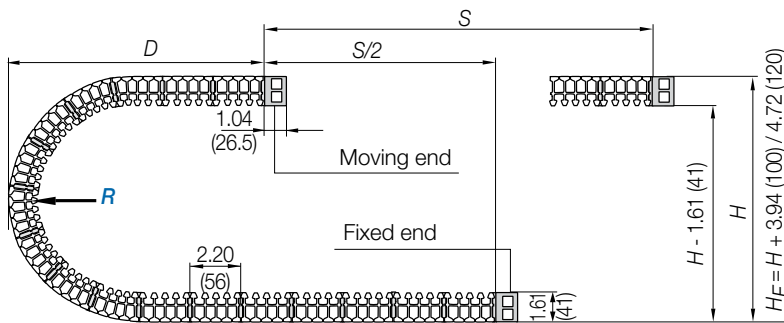

Pitch per link: = 2.20" (56 mm)

Links per ft (m) = 5.45 (18)

For center mount applications:

Chain length = $\frac{S}{2} + K$

The required clearance height: $H_r = H + 3.94$ in. (100 mm) and accordingly $H = 4.72$ in. (120mm) (with .27 lbs/ft (0.4 kg/m) fill weight. Please consult igus® if space is particularly restricted.

R	2.76 (070)
H	7.09 (180)
D	4.33 (110)
K	9.45 (240)

TH3 - 3-piece hygienic design e-chain®

- The TH3 e-chain® consists of 3 parts, the two side parts ① and one interior separation segment ②
- The interior separation segments connect the side parts of the e-chain®
- The segments are available in 4 different widths

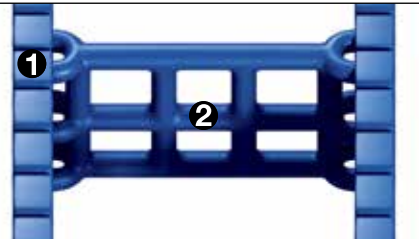

Speed / acceleration FL_G	upon request
Gliding speed / acceleration (maximum)	max. 32.8 ft/s (10 m/s) / max. 164 ft/s ² (50 m/s ²)
Material - side part	igumid TH NB / -40°F (-40°C) up to +158°F (+70 °C)
Material - Mounting bracket	igumid TH G / -40°F (-40°C) up to +158°F (+70 °C)
Material - interior separation segment	igumid TH G / -40°F (-40°C) up to +158°F (+70 °C)
Flammability Class, igumid TH NB	VDE 0304 IIC UL94 HB
Flammability Class, igumid TH G	VDE 0304 IIC UL94 HB

Technical Data



Details of material properties

► Chapter 1



PDF: igus.com/e-chain-pdfs
Product information: igus.com/e-chains



7.154

Series TH3.25 - Three-piece, hygienic design

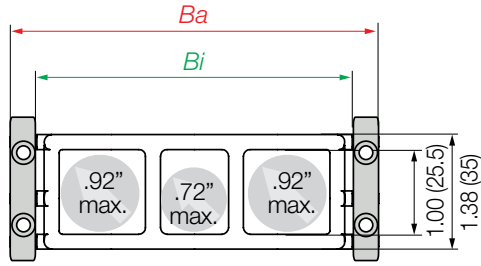

Part Number Structure

TH3. 25. 3/26. 070. 8

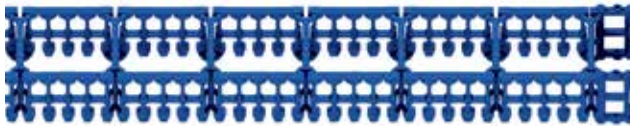

Segment design	Part No. e-chain®	Chamber width (mm)	Bi in. (mm)	Ba in. (mm)	R bend radii in. (mm)	TH3.25 lbs/ft (kg/m)
2-segment	TH3.25.2/26.R.8	26/26	2.76 (70)	3.39 (86)	2.76 (070)	≈ 0.302 (0.45)
3-segment	TH3.25.3/26.R.8	26/20.5/26	3.74 (95)	4.37 (111)	2.76 (070)	≈ 0.316 (0.47)
4-segment	TH3.25.4/26.R.8*	26/20.5/20.5/26	4.72 (120)	5.35 (136)	2.76 (070)	≈ 0.336 (0.50)
5-segment	TH3.25.5/26.R.8*	26/20.5/20.5/20.5/26	5.71 (145)	6.34 (161)	2.76 (070)	≈ 0.363 (0.54)

*Width available upon request. Please consult igus® for delivery time.

Complete Part No. with required radius (R). Example: TH3.25.3/26.070.8

Series TH3.25 - Interior separation segments - Size overview

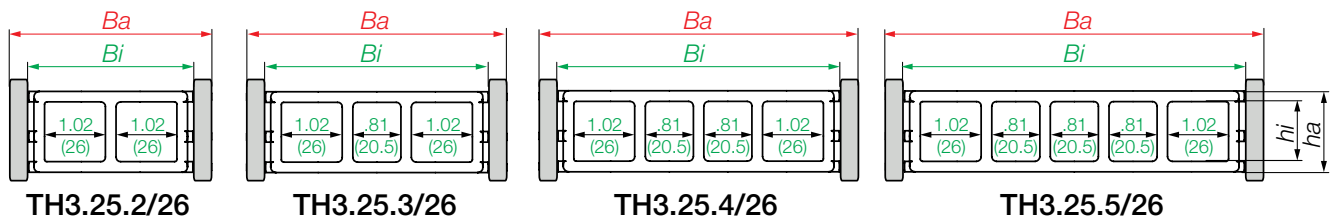

e-chain system® TH3
 Series TH3.25
 Interior Separation



TH3.25

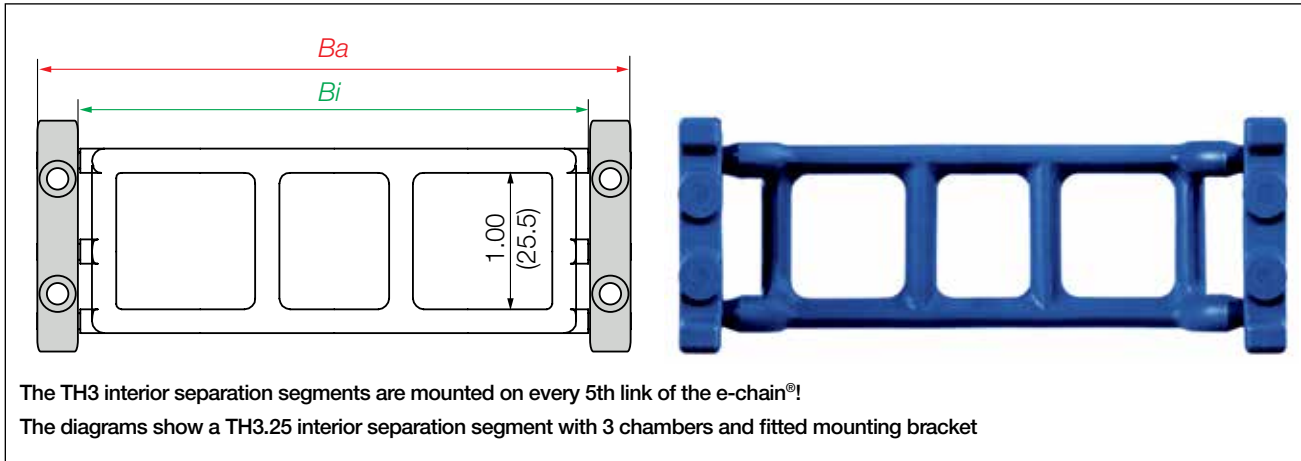

The TH3 interior separation segments are mounted on every 5th link of the e-chain®!
 The diagrams show a TH3.25 interior separation segment with 3 chambers and fitted mounting bracket

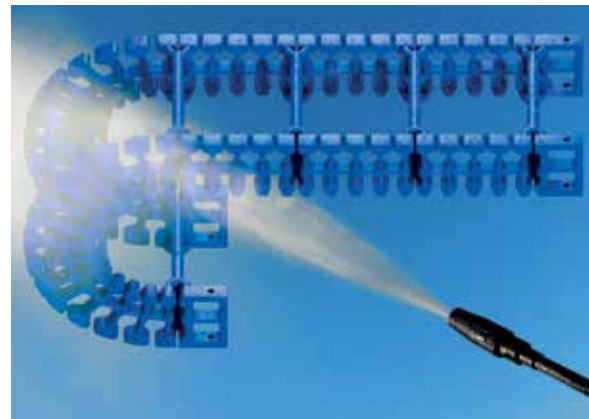
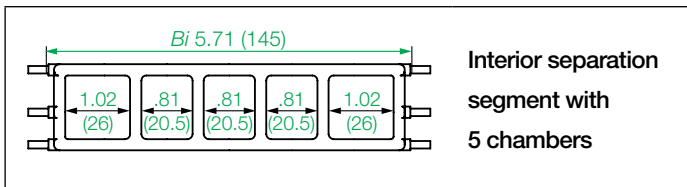
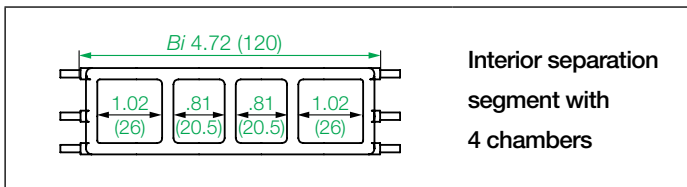
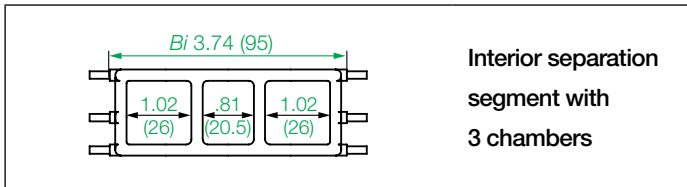
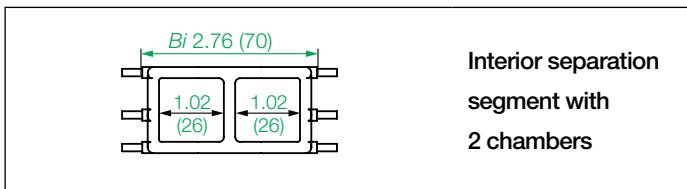

System TH3 - the open design allows effective and easy cleaning

PDF: igus.com/e-chain-pdfs
 Product information: igus.com/e-chains



FDA-compliant mounting brackets, locking - Attachment from any side

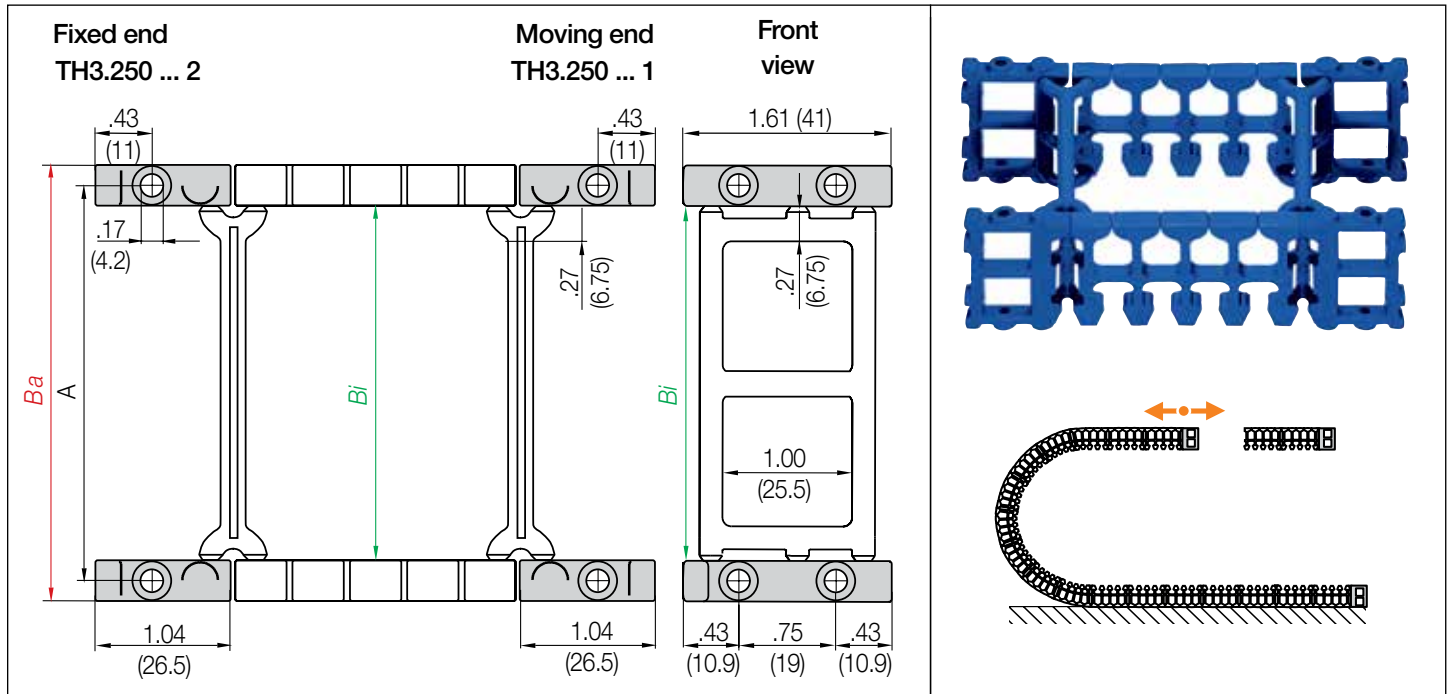

FDA-compliant mounting brackets, locking

Width index	Part No. full set locking	A in. (mm)	Bi in. (mm)	Ba in. (mm)
2/26 ▶	TH3.250.2/26.12.8	3.05 (77.5)	2.76 (70)	3.39 (86)
3/26 ▶	TH3.250.3/26.12.8	4.04 (102.5)	3.74 (95)	4.37 (111)
4/26 ▶	TH3.250.4/26.12.8*	5.02 (127.5)	4.72 (120)	5.35 (136)
5/26 ▶	TH3.250.5/26.12.8*	6.00 (152.5)	5.71 (145)	6.34 (161)

*Width available upon request. Please consult igus® for delivery time.



The TH3 e-chain® is the world's first plastic e-chain® developed according to "Hygienic Design Guidelines" (04/2018)

PDF: igus.com/e-chain-pdfs
Product information: igus.com/e-chains



Price Index

Series TH3.45

Special Options Available

Especially suitable for clean-room environments

ESD classification:
Electrically conductive ESD version upon request
Assembly Tips

Side segments of the e-chain® are connected using the interior separation segments

Other Installation Methods

Vertical, hanging ≤ 19.68 ft (6 m)

Vertical, standing ≤ 6.56 ft (2 m)

Usage Guidelines



- When an FDA/EU compliant material is required
- If an easy to clean open design is needed
- If good resistance to aggressive cleaning agents and chemicals is required



- When a hygienic design is not required
 - **Series T3**
- When cleanroom ISO Class 1 is required
 - **Series E6.1**

Features & Benefits

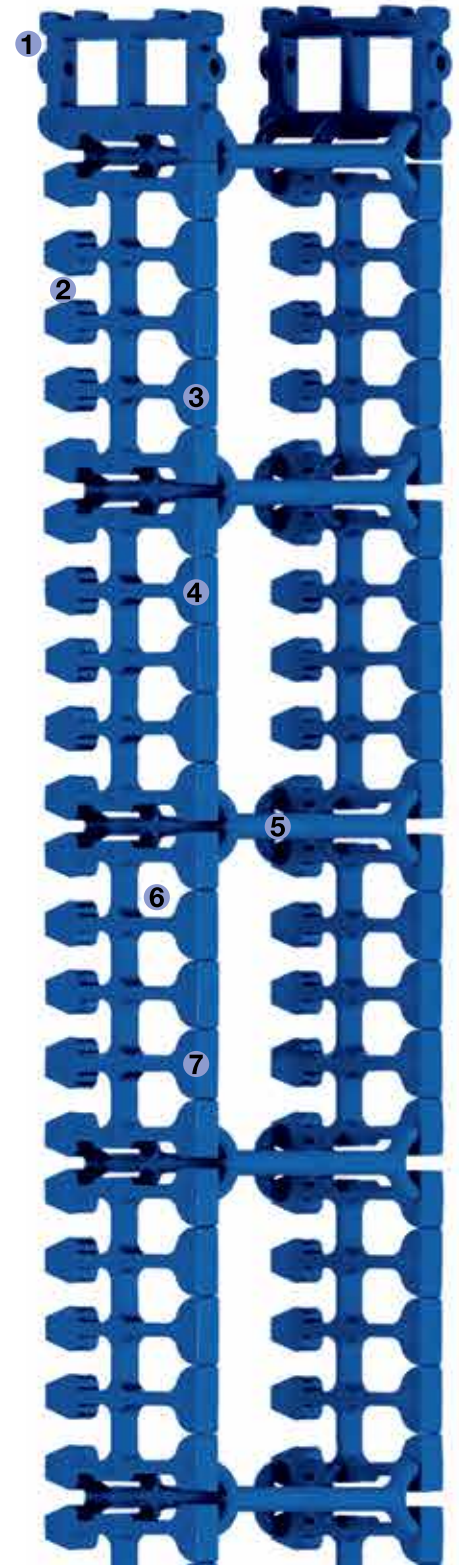
- 1 Attachment from any side: polymer mounting brackets
- 2 Easy to clean: open design for effective and easy cleaning
- 3 Hygienic design principle: FDA-compliant materials
- 4 Cable friendly due to smooth rounded contours
- 5 4 different widths for interior separation
- 6 No dead spaces. Large gaps - no material overlaps
- 7 Food industry material - resistant to detergents and chemicals

Order Example: Complete e-chain®

Please indicate chain length or number of links. Example:

3.28 ft (1 m) **TH3.45.3/20.090.8****e-chain®**

The interior separation segments connect the side parts of the e-chain® and are included in the part number of the e-chain®

**Interior Separation**1 Set **TH3.450.3/20.12.8****Mounting Bracket**

e-chain system® TH3

Series TH3.45

Installation Dimensions



TH3.45

Short travel, unsupported length

- FL_G = unsupported with straight upper run

Further information ► Design, Chapter 1

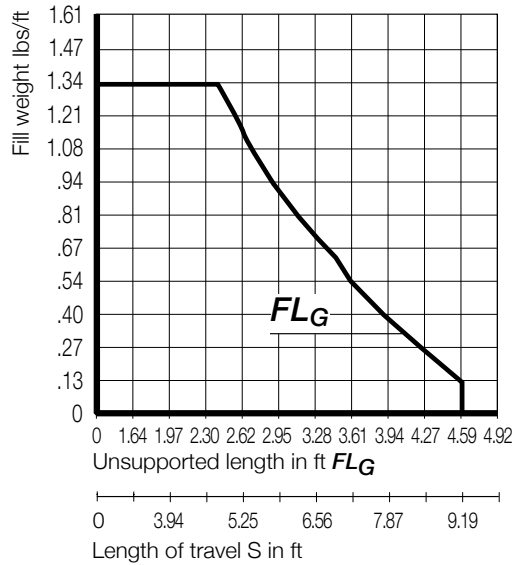

Short Travels - Unsupported

Unsupported e-chains® feature positive camber over short travels. This must be accounted for when specifying the clearance height. Please refer to **Installation dimensions** for further details.

Legend

- S = Length of travel
- R = Bending radius
- H = Nominal clearance height
- D = Overlength e-chain® radius in final position
- $K = \pi \cdot R + \text{safety buffer}$
- H_r = Required clearance height

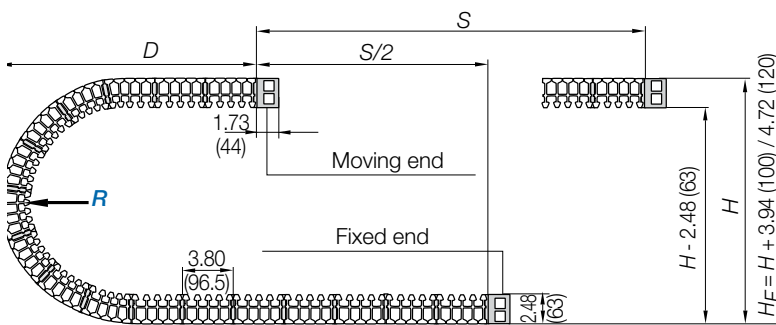

Pitch per link = 3.80" (96.5 mm)
 Links per ft (m) = 3.16 (11)
 For center mount applications:
 Chain length = $S/2 + K$

The required clearance height: $H_r = H + 3.94$ in. (100 mm) and accordingly $H = 4.72$ in. (120mm) (with .67 lbs/ft (1.0 kg/m) fill weight). Please consult igus® if space is particularly restricted.

R	3.54 (090)
H	9.84 (250)
D	4.72 (120)
K	13.31 (338)

TH3 - 3-piece hygienic design e-chain®

- The TH3 e-chain® consists of 3 parts, the two side parts ① and one interior separation segment ②
- The interior separation segments connect the side parts of the e-chain®
- The segments are available in 4 different widths

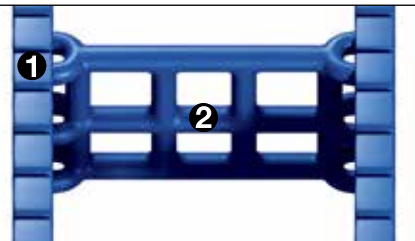

Speed / acceleration FL_G	upon request
Gliding speed / acceleration (maximum)	max. 32.8 ft/s (10 m/s) / max. 164 ft/s² (50 m/s²)
Material - side part	igumid TH NB / -40°F (-40°C) up to +158°F (+70°C)
Material - Mounting bracket	igumid TH G / -40°F (-40°C) up to +158°F (+70°C)
Material - interior separation segment	igumid TH G / -40°F (-40°C) up to +158°F (+70°C)
Flammability Class, igumid TH NB	VDE 0304 IIC UL94 HB
Flammability Class, igumid TH G	VDE 0304 IIC UL94 HB

Technical Data



Details of material properties

► Chapter 1

PDF: igus.com/e-chain-pdfs
 Product information: igus.com/e-chains



Series TH3.45 - Three-piece, hygienic design

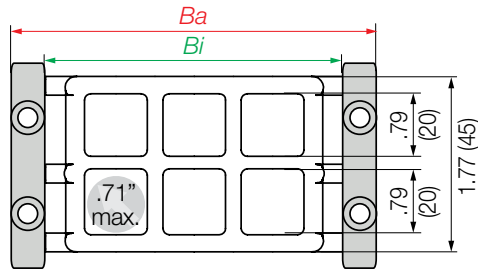

Part Number Structure

TH3. 45. **3/20**. **090**. **8**



Segment design	Part No.	Chamber width (mm)	<i>Bi</i> in. (mm)	<i>Ba</i> in. (mm)	<i>R</i> bend radii in. (mm)	TH3.45 lbs/ft (kg/m)
2-segment	TH3.45.2/20. <i>R</i> .8	20/20	2.76 (70)	3.54 (90)	3.54 (090)	≈ 0.551 (0.82)
3-segment	TH3.45.3/20. <i>R</i> .8	20/20/20	3.74 (95)	4.53 (115)	3.54 (090)	≈ 0.585 (0.87)
4-segment	TH3.45.4/20. <i>R</i> .8*	20/20/20/20	4.72 (120)	5.51 (140)	3.54 (090)	≈ 0.618 (0.92)
5-segment	TH3.45.5/20. <i>R</i> .8*	20/20/20/20/20	5.71 (145)	6.50 (165)	3.54 (090)	≈ 0.659 (0.98)

*Width available upon request. Please consult igus® for delivery time.

Complete Part No. with required radius (*R*). Example: TH3.45.3/20.090.8

Series TH3.45 - Interior separation segments - Size overview

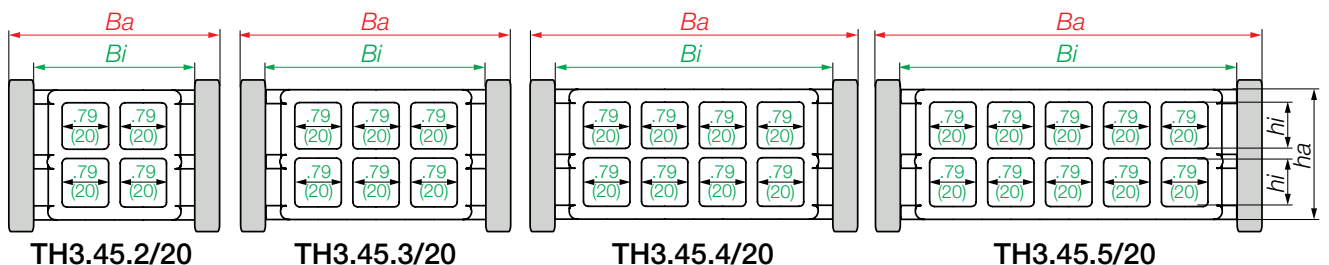

e-chain system® TH3
 Series TH3.45
 Interior Separation



TH3.45

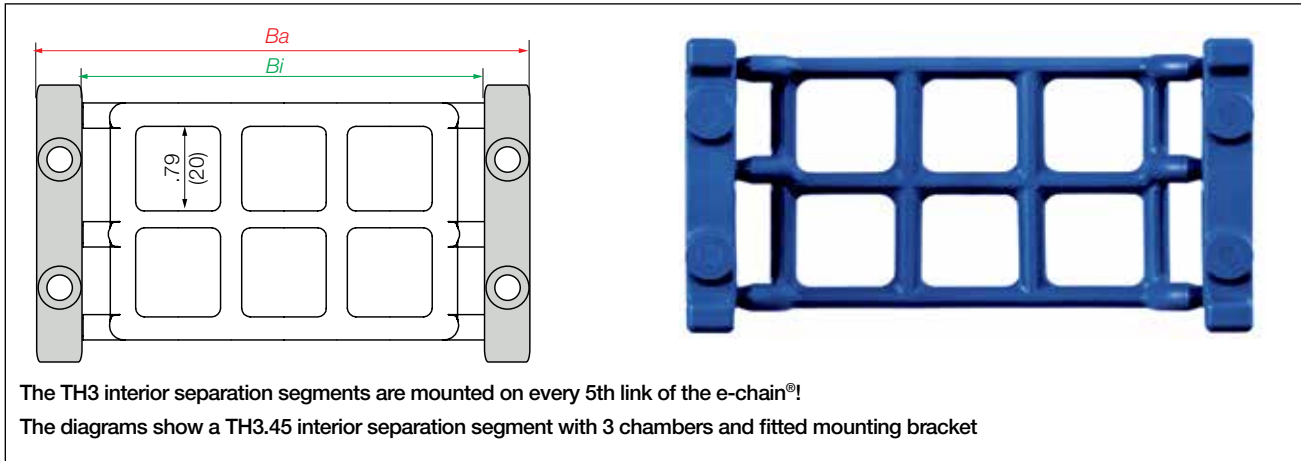

The TH3 interior separation segments are mounted on every 5th link of the e-chain®!
 The diagrams show a TH3.45 interior separation segment with 3 chambers and fitted mounting bracket

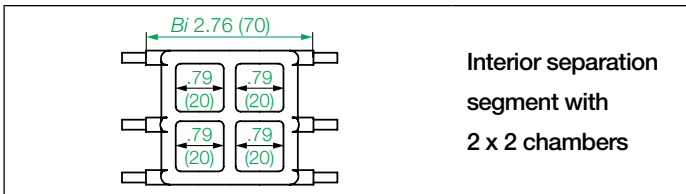

Interior separation segment with 2 x 2 chambers

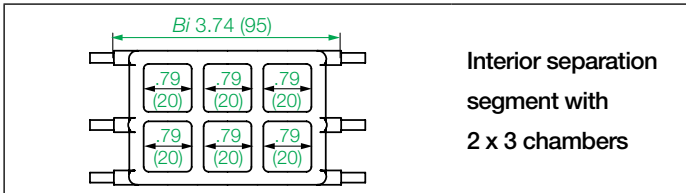

Interior separation segment with 2 x 3 chambers

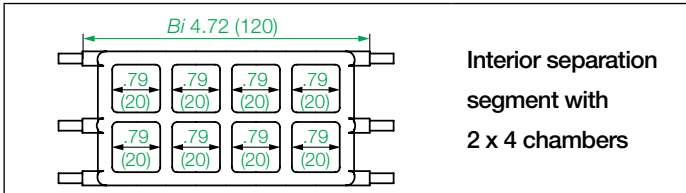

Interior separation segment with 2 x 4 chambers

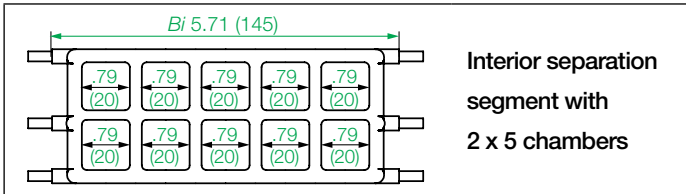

Interior separation segment with 2 x 5 chambers



The TH3 series is suitable for applications with the highest hygienic requirements for safe cable and hose guidance

PDF: igus.com/e-chain-pdfs
 Product information: igus.com/e-chains

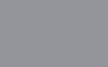

FDA-compliant mounting brackets, locking - Attachment from any side

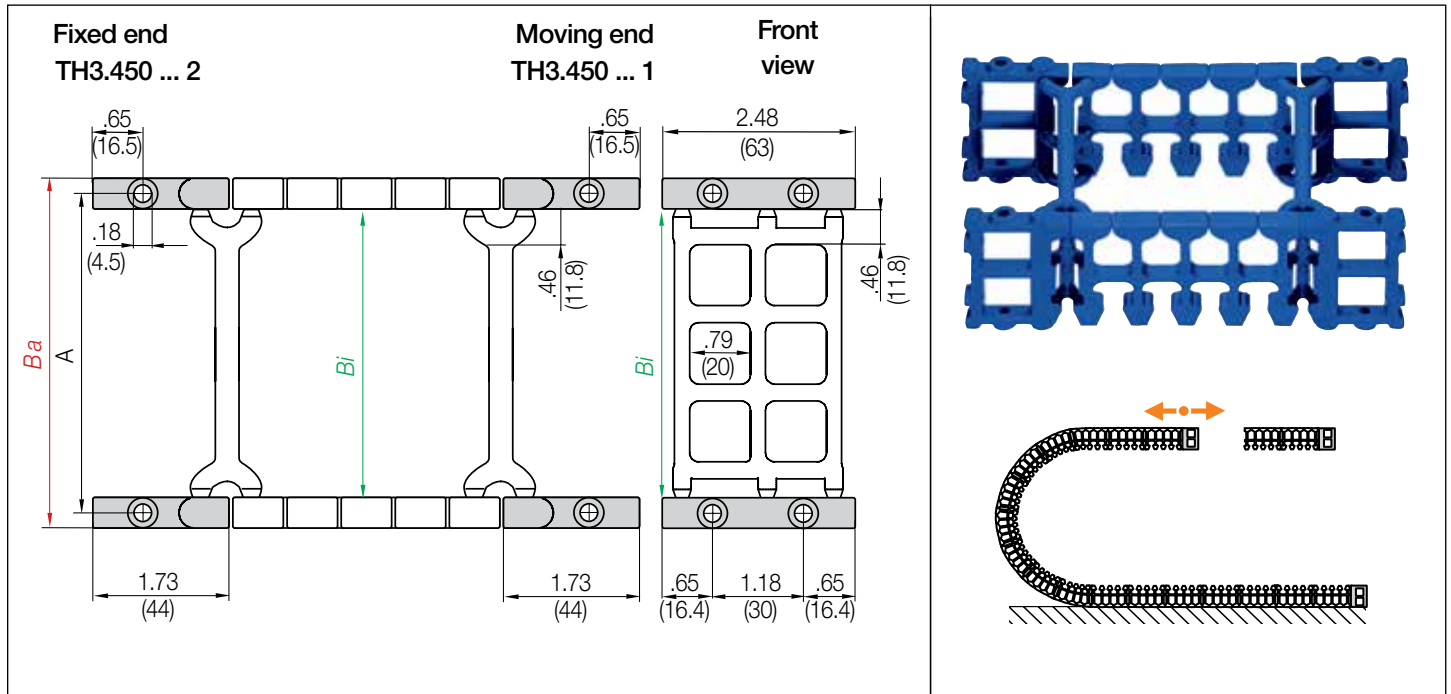

FDA-compliant mounting brackets, locking

Width index	Part No. full set locking	A in. (mm)	Bi in. (mm)	Ba in. (mm)
2/20 ▶	TH3.450.2/20.12.8	3.15 (80)	2.76 (70)	3.54 (90)
3/20 ▶	TH3.450.3/20.12.8	4.13 (105)	3.74 (95)	4.53 (115)
4/20 ▶	TH3.450.4/20.12.8*	5.12 (130)	4.72 (120)	5.51 (140)
5/20 ▶	TH3.450.5/20.12.8*	6.10 (155)	5.71 (145)	6.50 (165)

*Width available upon request. Please consult igus® for delivery time.

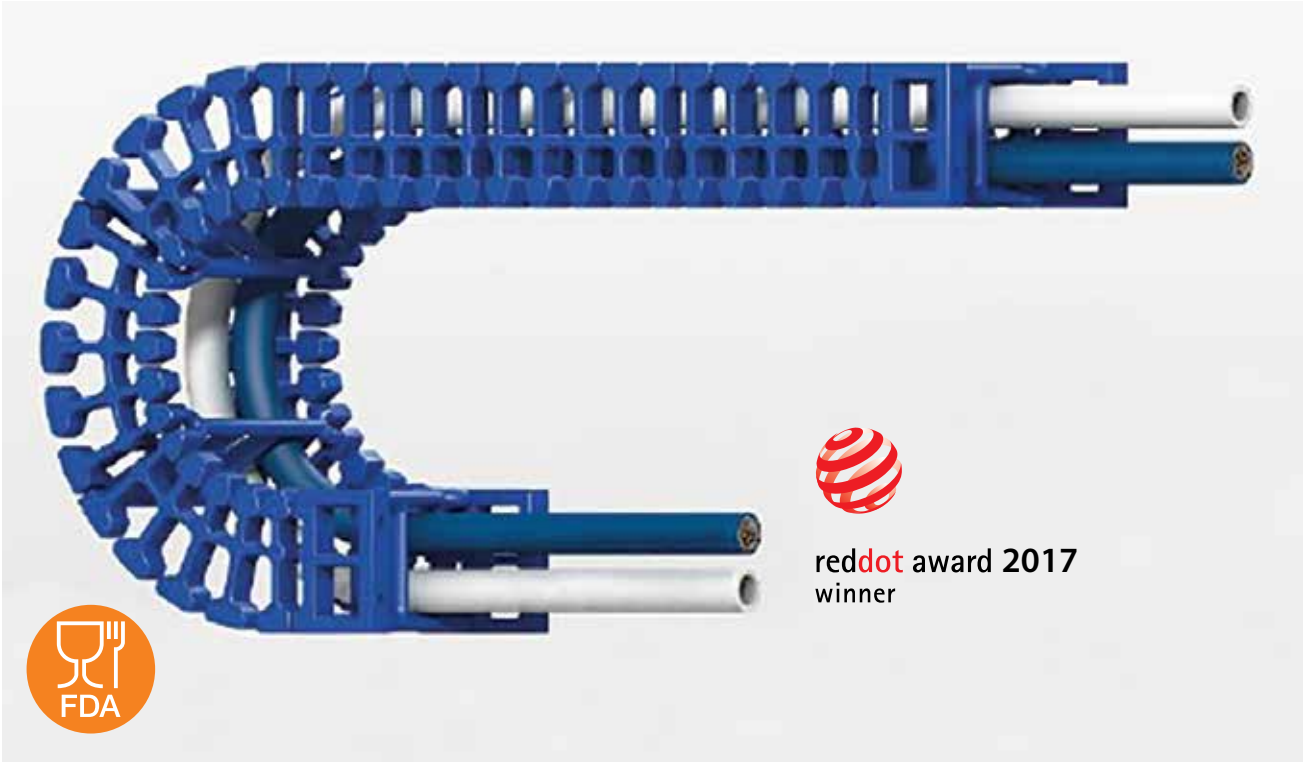

The TH3 e-chain® is the world's first plastic e-chain® developed according to "Hygienic Design Guidelines" (04/2018)

PDF: igus.com/e-chain-pdfs
Product information: igus.com/e-chains



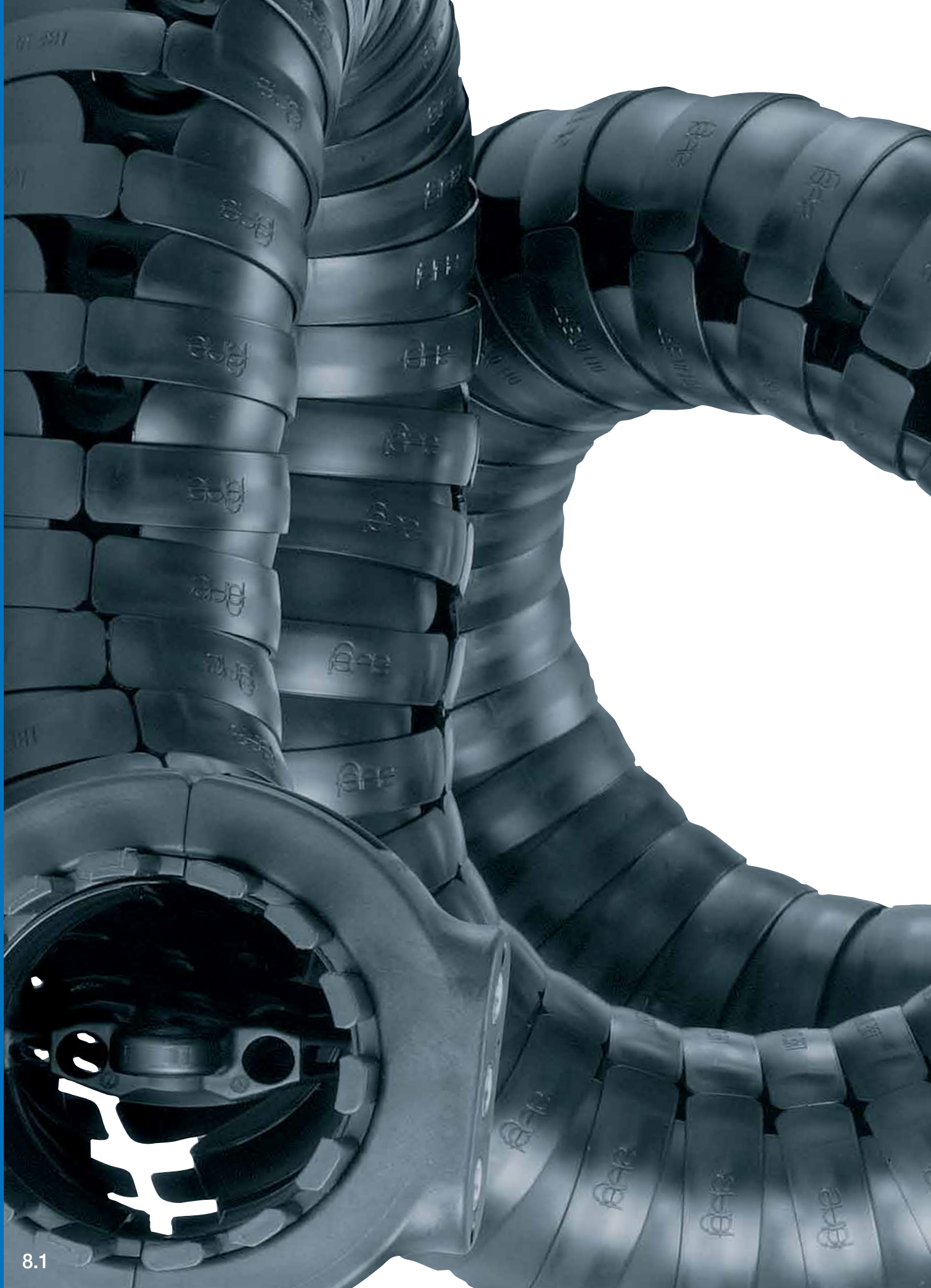



igus[®] 3-D e-chains[®]

Robotic, 3D and
circular movements:
triflex[®]
twisterchain
twisterband

triflex® R, E-Z triflex® and triflex® e-chains® for Robotic and 3D Applications



triflex® R - 3D-robotic e-chains®

- The first choice for multi-axis-robots
- **TRC version** - closed design with smooth and robust exterior
- **TRCF version** - closed design with snap-open mechanism
- **TRE version** - “easy” design, easy to fill from outside
- **TRL version** - light weight, cost-efficient and very easy to fill, for non robotic applications
- **TRLF version** - light weight, snap-open mechanism
- Torsion approximately $\pm 10^\circ$ per link possible
- High torsional stability (TRC/TRE)
- Easy shortening and lengthening
- Small bending radius, small pitch

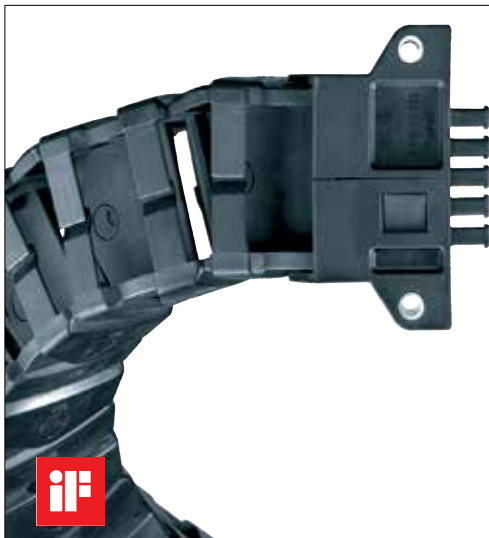

E-Z triflex® - easy filling

- Easy filling from two sides and complex movements
- For reparations or supplements of existing triflex® Systems
- For simple robotic- and 3D-applications
- Fast cable assembly with “easy” design
- Where rectangular shapes fit better
- Combination of different bending radii and movement directions possible
- Shortening and lengthening anywhere
- 3D e-chain® for non robotic applications



triflex® - enclosed version

- 3-axis motions in machinery of all kinds (combined circle- and stroke-movements)
- Completely enclosed - protection against dirt and chips
- For simple 3D-applications
- High tensile strength
- Where rectangular shapes fit better
- Modular, robust
- Combinations of varying bending radii and moving axes possible
- 3D e-chain® for non robotic applications
- Connecting, separating possible at every link

twisterchain® and twisterband e-chains® for Circular and Spiral Movements



twisterchain® circular and spiral e-chains®

- e-chains® for circular and spiral movements up to 360° available from stock
- Tough, quiet and high dynamics. suitable for high fill weights
- Rotary speeds up to 3.28 ft/s (1 m/s) and more
- Modular interior separation
- Smooth cable-friendly interior
- Openable from both sides - crossbars removable along the inner and outer radius



twisterband - rotary motions

- Rotary motions in a small spaces
- 4 sizes available
- Rotary movements up to 7000°
(Installation position, vertical: up to 3.000°, horizontal 7.000° and more possible)
- Rotary speeds up to 360°/s possible
- Compact, modular and lightweight
- Ribbons can be shortened easily
- Minimum installation space
- Can be used in various installation positions
- Cost-effective







triflex[®] R

For multi-axis movements and robots



triflex[®] R advantages:

- For the most demanding multi-axis applications on industrial robots
- Defined torsion stop-dog
- Defined minimum bend radius
- Easy to lengthen and shorten
- Small bend radius and short pitch
- Fillable from the outside



When to use another 3D e-chain[®] series:

- For circular movements with high loads
 - ▶ **twisterchain system**

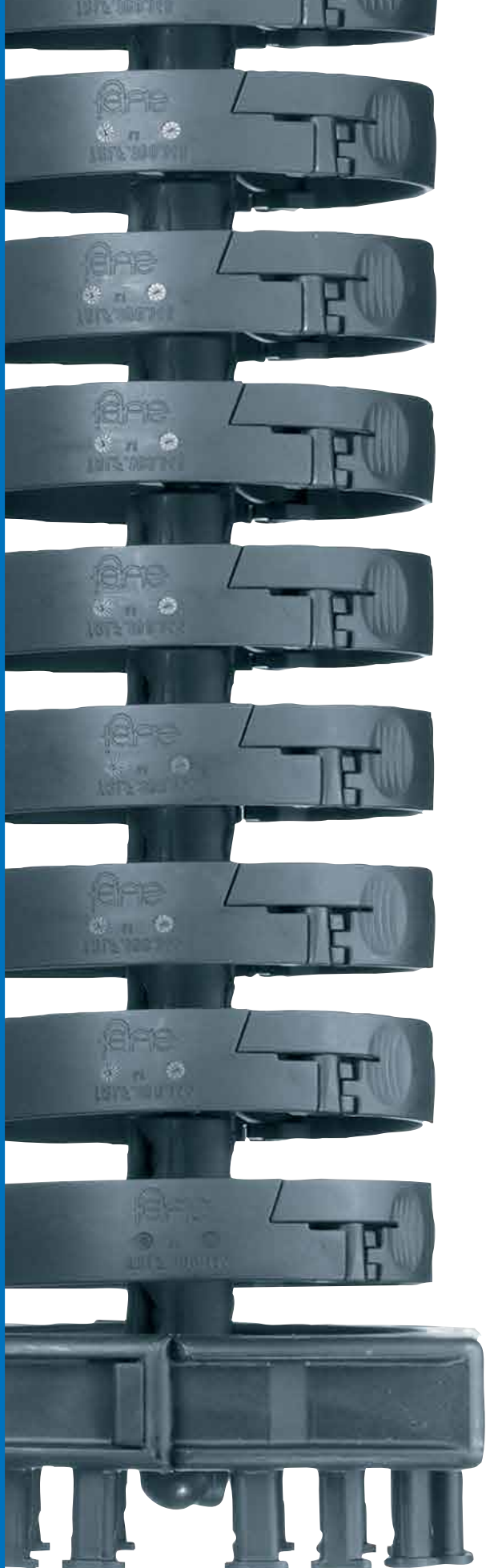

For multi-axis movements and robots - triflex® R

triflex® R (R for “round”) is the third generation of multi-axis e-chains®. The key design characteristics of igus® triflex® R have made this product very successful in the robot industry.

- Defined torsion stop-dog on each e-chain® link
- Defined minimum bend radius
- High tensile strength ball and socket joint
- Compact retraction system options to prevent loop formation
- Fiber-rod option for partial directional control and reinforcement
- No extra support elements required e.g. steel cables, spring suspensions etc.
- Wide range of accessories

The triflex® R product family is available in 5 versions from stock:

- TRC - closed design with a smooth and robust exterior
- TRCF - closed design with snap-open mechanism
- TRE - “easy” design, simply press the cables in
- TRL - lightweight, also features “easy design”
- TRLF - Light version with snap lock mechanism

Typical industries and applications

- Robotics/Automation
- Machine tools
- Handling machines - 6-axis
- Packaging machines
- General mechanical engineering, etc.



Assembly video available online at
▶ www.igus.com/triflexR_assembly



Available from stock. **Orders ship as early as today.***

*On average 90% of orders ship the same day..

triflex® R - Features - Accessories



The defined torsion stop ensures an even distribution of the torsional load across the entire length



A tough, bend radius stop-dog actively prevents cables and hoses from kinking



Interior separation: two or three chamber design for a reliable cable guidance



Openable - series TRCF and TRLF have snap lock mechanism for easy filling



Tensile strength is absorbed directly by the e-chain® - no additional supports are necessary



5 retraction system options available to prevent formation of loops in the robot's working area



Standard and light mounting brackets available with or without integrated strain relief. Some versions available in ESD material, from stock



Mounting brackets options with gliding feed-through and swivel bearing. Bearing with a maintenance-free igubal® ball and socket joint



Various heavy duty and compact connections and quick-change units are available



Series TRC - Electrically conductive ESD e-chains® - several series available from stock



UL94-V2 classification



IF product design awards

2004 for igus® series TRC
2007 for igus® series TRL
2013 for igus® series TRLF

triflex® R - Selection Guide

Series	Inner height				max. cable ø				Outer width		Bend radius		Pitch		Links	
	Bi 1		Bi 2		d1		d2		Ba		R		in.	(mm)	per ft	per m
	in.	(mm)	in.	(mm)	in.	(mm)	in.	(mm)	in.	(mm)	in.	(mm)				



Series TRC - closed design
chip protection,
smooth outer contour

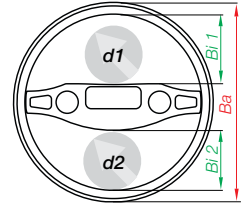

TRC-30	.47	(12)	.39	(10)	.39	(10)	.31	(8)	1.36	(34.5)	1.97	(50)	.44	(11.3)	27.27	(89)
TRC-40	.59	(15)	.51	(13)	.51	(13)	.43	(11)	1.69	(43)	2.28	(58)	.55	(13.9)	21.82	(72)
TRC-50	.74	(18.8)	.64	(16.2)	.65	(16.5)	.55	(14)	2.13	(54)	3.15	(80)	.69	(17.4)	17.39	(58)
TRC-60	.88	(22.5)	.77	(19.5)	.81	(20.5)	.69	(17.5)	2.56	(65)	3.43	(87)	.80	(20.4)	15.00	(49)
TRC-70	1.10	(28)	.94	(24)	1.02	(26)	.87	(22)	3.19	(81)	4.33	(110)	1.01	(25.6)	11.88	(39)
TRC-85	1.30	(33)	1.10	(28)	1.22	(31)	1.02	(26)	3.72	(94.5)	5.31	(135)	1.20	(30.6)	10.00	(33)
TRC-100	1.48	(37.5)	1.28	(32.5)	1.40	(35.5)	1.20	(30.5)	4.25	(108)	5.71	(145)	1.36	(34.5)	8.82	(29)
TRC-125 ³⁾	1.70	(43.3)	1.70	(43.3)	1.61	(41)	1.61	(41)	5.31	(135)	7.17	(182)	1.76	(44.6)	6.82	(23)



Series TRE - "easy" design
very easy to fill, cables
are simply pushed in

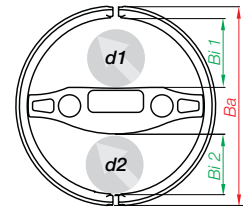

TRE-30	.47	(12)	.39	(10)	.39 ¹⁾	(10) ¹⁾	.31 ¹⁾	(8) ¹⁾	1.36	(34.5)	1.97	(50)	.44	(11.3)	27.27	(89)
TRE-40	.59	(15)	.51	(13)	.51 ¹⁾	(13) ¹⁾	.43 ¹⁾	(11) ¹⁾	1.69	(43)	2.28	(58)	.55	(13.9)	21.82	(72)
TRE-50	.74	(18.8)	.64	(16.2)	.65 ¹⁾	(16.5) ¹⁾	.55 ¹⁾	(14) ¹⁾	2.13	(54)	3.15	(80)	.69	(17.4)	17.39	(58)
TRE-60	.88	(22.5)	.77	(19.5)	.81 ¹⁾	(20.5) ¹⁾	.69 ¹⁾	(17.5) ¹⁾	2.56	(65)	3.43	(87)	.80	(20.4)	15.00	(49)
TRE-70	1.10	(28)	.94	(24)	1.02 ¹⁾	(26) ¹⁾	.87 ¹⁾	(22) ¹⁾	3.19	(81)	4.33	(110)	1.01	(25.6)	11.88	(39)
TRE-85	1.30	(33)	1.10	(28)	1.22 ¹⁾	(31) ¹⁾	1.02 ¹⁾	(26) ¹⁾	3.72	(94.5)	5.31	(135)	1.20	(30.6)	10.00	(33)
TRE-100	1.48	(37.5)	1.28	(32.5)	1.40 ¹⁾	(35.5) ¹⁾	1.20 ¹⁾	(30.5) ¹⁾	4.25	(108)	5.71	(145)	1.36	(34.5)	8.82	(29)
TRE-125 ³⁾	1.70	(43.3)	1.70	(43.3)	1.61 ¹⁾	(41) ¹⁾	1.61 ¹⁾	(41) ¹⁾	5.31	(135)	7.17	(182)	1.76	(44.6)	6.82	(23)



Series TRCF - closed design with snap lock mechanism
chip protection,
smooth outer contour

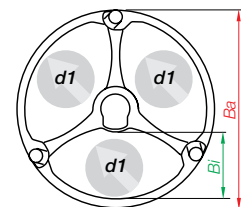

TRCF-65	.88	(22.3)	—	—	.79	(20)	—	—	2.76	(70.2)	3.94	(100)	.91	(23.1)	13.19	(44)
TRCF-65 ⁴⁾	.88	(22.3)	—	—	.79	(20)	—	—	2.76	(70.2)	7.87	(200)	.91	(23.1)	13.19	(44)
TRCF-85	1.18	(30)	—	—	1.10	(28)	—	—	3.72	(94.5)	5.31	(135)	1.20	(30.6)	10.00	(33)
TRCF-85 ⁴⁾	1.18	(30)	—	—	1.10	(28)	—	—	3.72	(94.5)	9.45	(240)	1.20	(30.6)	10.00	(33)
TRCF-100	1.35	(34.3)	—	—	1.27	(32.3)	—	—	4.25	(108)	5.71	(145)	1.35	(34.4)	8.89	(29)

- 1) For quick and easy fitting or removal of cables using the "easy" design, we recommend a maximum cable diameter of 70% of the specified value
- 2) Max. cable diameter Ø 1.61" (41mm). Max. cable diameter changes to Ø 1.42" (36 mm), if lengthening or shortening an already populated triflex® R
- 3) TRL 30 with 2-chamber design
- 4) Special size with increased bend radius and special range of accessories

Series	Inner height				max. cable ø				Outer width		Bending radii		Pitch		Links	
	Bi 1		Bi 2		d1		d2		Ba		R		in.	(mm)	per ft	per m
	in.	(mm)	in.	(mm)	in.	(mm)	in.	(mm)	in.	(mm)	in.	(mm)				



Series TRL -
the “light” version with
“easy” design
easy to fill and cost effective

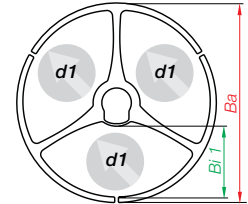

TRL-30 [®]	.47	(12)	.39	(10)	.39	(10*)	.31	(8*)	1.36	(34.5)	1.97	(50)	.44	(11.3)	27.27	(89)
TRL-40	.59	(15)	-	-	.51	(13*)	-	-	1.69	(43)	2.28	(58)	.55	(13.9)	21.82	(72)
TRL-60	.91	(23)	-	-	.81	(20.5*)	-	-	2.56	(65)	3.43	(87)	.80	(20.4)	15.00	(49)
TRL-70	1.10	(28)	-	-	1.02	(26*)	-	-	3.19	(81)	4.33	(110)	1.01	(25.6)	11.88	(39)
TRL-100	1.50	(38)	-	-	1.40	(35.5*)	-	-	4.25	(108)	5.31	(145)	1.36	(34.5)	8.82	(29)



Series TRLF -
the “light” version with
snap lock mechanism
lightweight and cost effective

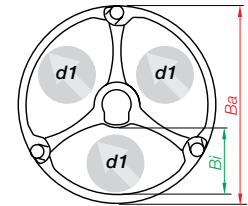

TRLF-65	.96	(24.4)	-	-	.87	(22)	-	-	2.76	(70.2)	3.94	(100)	.91	(23.1)	13.19	(44)
TRLF-85	1.29	(32.8)	-	-	1.18	(30)	-	-	3.72	(94.5)	5.31	(135)	1.20	(30.6)	10.00	(33)
TRLF-100	1.48	(37.5)	-	-	1.40	(35.5)	-	-	4.25	(108)	5.71	(145)	1.35	(34.4)	8.89	(29)
TRLF-125	1.84	(46.8)	-	-	1.75	(44.5)	-	-	5.31	(135)	7.17	(182)	1.74	(44.1)	6.90	(23)

triflex® R - Retraction system overview

Series	System	For triflex® R	
		e-chains®	For ø Index in. (mm)
	RSE linear - retraction system	TRC-TRE-TRCF	1.57 - 4.92 (40 - 100)
	RS - modular retraction system	TRC-TRE	1.57 - 3.94 (40 - 100)
	RSP - pneumatic retraction system	TRC-TRE-TRCF	2.36 - 4.92 (60 - 125)
	RSE Wheel- retraction system	TRC-TRE	1.57 - 1.97 (40 - 50)
	RSEL linear- retraction system	TRC-TRE-TRCF	2.76 - 3.35 (70-85)

Technical data

 Speed / acceleration upon request

 Material - permitted temperature, igumid G (TRLF/TRCF) -40°F / +248°F (-40°C / +120°C)

Material - permitted temperature, igumid NB (TRC/TRE/TRL) -40°F / +176°F (-40°C / +80°C)

 Flammability class, igumid G (TRLF/TRCF) VDE 0304 IIC UL94-HB

Flammability class, igumid NB (TRC/TRE/TRL) VDE 0304 IIC UL94-V2

Reduce installation times with easy-to-use disassembly tools



Easy-to-use disassembly tools for triflex® TRE (B version) and TRCF. Easy disassembly at any point along the e-chain®, even when full.

More information

► www.igus.com/triflex_B_disassemblytool

 Assembly video available online at
► www.igus.com/triflexR_assembly

For series	Part No.
TRE-B	disassembly tool
TRE-40-B	MAT0050175
TRE-50-B	MAT0051190
TRE-60-B / TRE-70-B	MAT0051135
TRE-85-B	MAT0050170
TRE-100-B	MAT0050172

For series	Part No.
TRCF	disassembly tool
TRCF-65	MAT0051135
TRCF-85	MAT0050170
TRCF-100	MAT0050172



igus® triflex® R TRLF - light version, easily openable by hand or with a screwdriver

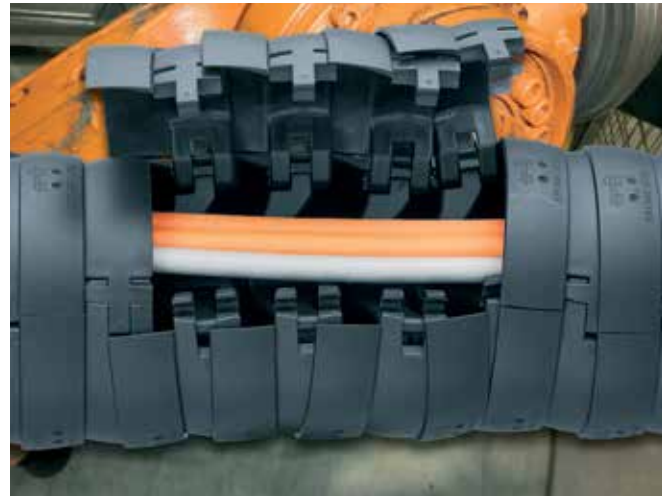

igus® triflex® R TRCF - closed version, openable with a screwdriver



triflex® RS for a low profile retraction system.. Integrated fiber rods generate the directed pretension so that loops do not form in the working area



Pneumatic retraction system triflex® RSP - prevents loop formation on the robot



triflex® TR-RSE-40-L or R, cost-effective and lightweight retraction system with guide roller, for small robots



TR-RSE linear retraction system for triflex® R, sizes 40-125

Closed and chip-repellent - TRC

TRC - enclosed, chip-repellent design

High tensile strength thanks to special ball and socket design

Defined torsion stop, allows free movement in any direction but still protects the cables

Impact-resistant, abrasion resistant and chip-resistant

Easy assembly and disassembly

High strength - thanks to external stop-dogs

Small bend radius and short pitch

Easy attachment and special accessories for the robot or machine

- Secure, closed and chip-repellent energy supply for multi-axis movements
- Smooth but robust exterior
- High torsional strength
- Easy to lengthen and shorten

Typical industries and applications

- Robotics and automation
- Multi-axis machine tools
- Wet and cold cells
- Painting applications and ESD
- Sand and dust exposure



Electrically conductive ESD e-chains® -



iF product design award

2004 igus® series TRC

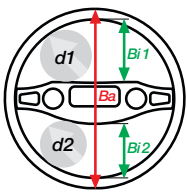

triflex® R - Series TRC - Product Range

Robotic applications, closed, chip repellent



TRC



e-tubes - Series TRC - Totally enclosed, non-openable

Series	Inner height				Max. cable ø				Outer width		Bend radius		Pitch		Links		Weight	
	Bi 1		Bi 2		d1		d2		Ba		R							
	in.	(mm)	in.	(mm)	in.	(mm)	in.	(mm)	in.	(mm)	in.	(mm)	in.	(mm)	per ft.	per m	lbs/ft	(kg/m)
TRC-30-050-0	.47	(12)	.39	(10)	.39	(10)	.31	(8)	1.36	(34.5)	1.97	(50)	.44	(11.3)	27.27	(89)	≈ 0.18	≈ 0.27
TRC-40-058-0 ¹⁾	.59	(15)	.51	(13)	.51	(13)	.43	(11)	1.69	(43)	2.28	(58)	.55	(13.9)	21.82	(72)	≈ 0.25	≈ 0.37
TRC-50-080-0	.74	(18.8)	.64	(16.2)	.65	(16.5)	.55	(14)	2.13	(54)	3.15	(80)	.69	(17.4)	17.39	(58)	≈ 0.40	≈ 0.59
TRC-60-087-0 ¹⁾	.88	(22.5)	.77	(19.5)	.81	(20.5)	.69	(17.5)	2.56	(65)	3.43	(87)	.80	(20.4)	15.00	(49)	≈ 0.57	≈ 0.85
TRC-70-110-0 ¹⁾	1.10	(28)	.94	(24)	1.02	(26)	.87	(22)	3.19	(81)	4.33	(110)	1.01	(25.6)	11.88	(39)	≈ 0.89	≈ 1.32
TRC-85-135-0	1.30	(33)	1.10	(28)	1.22	(31)	1.02	(26)	3.72	(94.5)	5.31	(135)	1.20	(30.6)	10.00	(33)	≈ 1.18	≈ 1.75
TRC-100-145-0	1.48	(37.5)	1.28	(32.5)	1.40	(35.5)	1.20	(30.5)	4.25	(108)	5.71	(145)	1.36	(34.5)	8.82	(29)	≈ 1.60	≈ 2.38
TRC-125-182-0	1.70	(43.3)	1.70	(43.3)	1.61	(41)	1.61	(41) ²⁾	5.31	(135)	7.17	(182)	1.76	(44.6)	6.82	(23)	≈ 3.16	≈ 4.70

1) Available as ESD version from stock

2) TRE 125 max. cable diameter Ø 1.61" (41mm). Max. cable diameter changes to Ø 1.42" (36mm) when an already populated e-chain needs to be shortened or lengthened

Installation dimensions

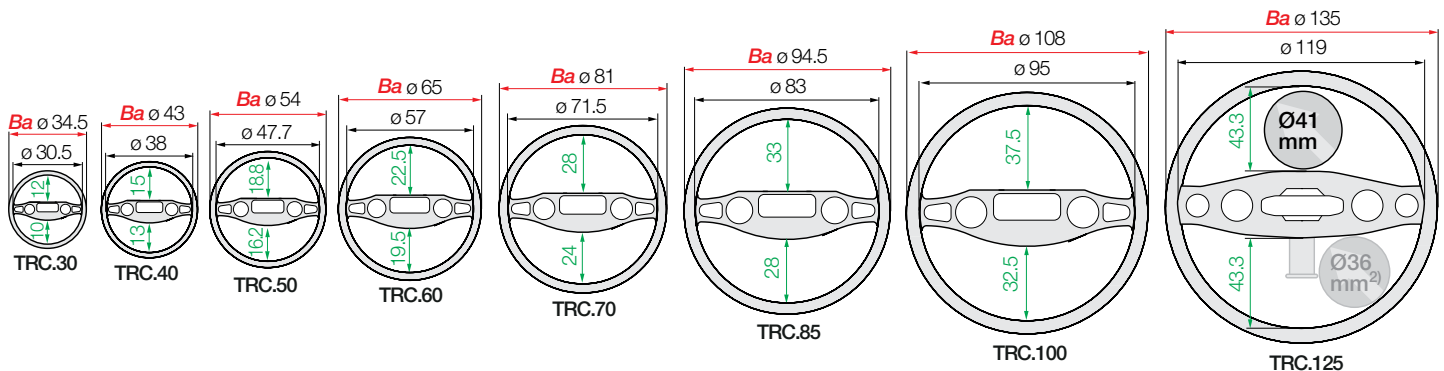

ESD - many sizes

- Standardized product made from igumid ESD
- ESD material tested with over 10 million cycles for the toughest requirements
- Short delivery times including mounting brackets and interior separation; 24hrs, from stock

More information ► www.igus.com/esd

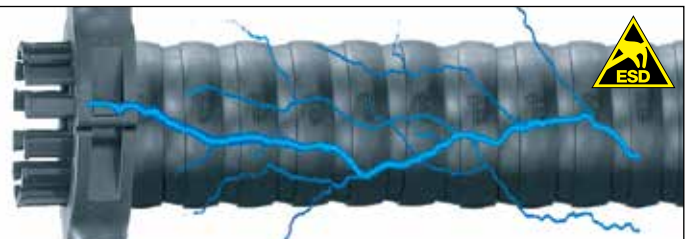

Easy to fill - simply press cables in - TRE

TRE - "easy" design - simply press cables in

High tensile strength thanks to special ball and socket design

Defined torsion stop, allows free movement in any direction but still protects the cables

"Easy" design for fast filling with cables and hoses

Simple tool for fast disassembly of the triflex® B versions

High strength - thanks to external stop-dogs

Small bend radius and short pitch

Easy attachment and special accessories for the robot or machine

- Easy to fill energy supply for multi-axis movements
- High torsional strength
- Easy to shorten and lengthen.
- **B version** - 4x increase in radial stability, allows larger torsion forces
- **C version TRE-100 and TRE-125** - fast assembly due to pin connection and spherical igubal® joint allowing 50% higher tensile forces

Typical industries and applications

- Robotics and automation
- Spot welding
- Pick and place applications
- When fast replacement is needed



Electrically conductive ESD e-chains® upon request



Save time - easy disassembly tool available for triflex® R



TRE - very easy to fill, cables are simply pushed in

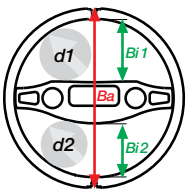

triflex® R - Series TRE - Product Range

Robotic applications, easy filling



TRE

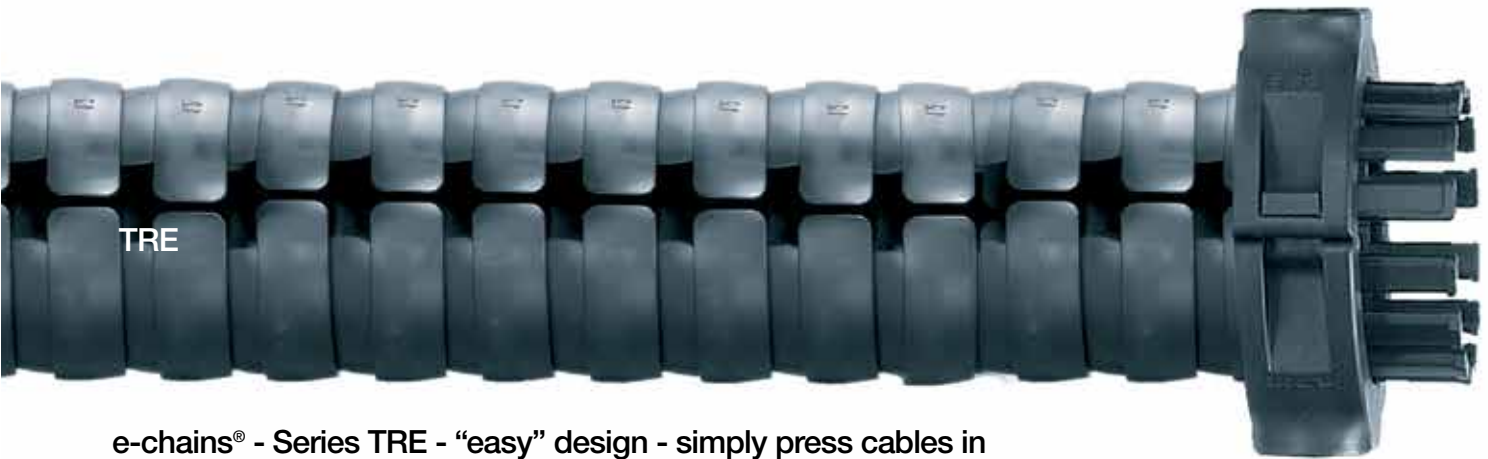

e-chains® - Series TRE - “easy” design - simply press cables in

Series	Inner height				Max. cable ø				Outer width		Bend radius		Pitch		Links		Weight	
	Bi 1		Bi 2		d1 ²⁾		d2 ²⁾		Ba		R							
	in.	(mm)	in.	(mm)	in.	(mm)	in.	(mm)	in.	(mm)	in.	(mm)	in.	(mm)	per ft.	per m	lbs/ft	(kg/m)
TRE-30-050-0	.47	(12)	.39	(10)	.39	(10*)	.31	(8*)	1.36	(34.5)	1.97	(50)	.44	(11.3)	27.27	(89)	≈ 0.18	≈ (0.27)
TRE-40-058-0-B	.59	(15)	.51	(13)	.51	(13*)	.43	(11*)	1.69	(43)	2.28	(58)	.55	(13.9)	21.82	(72)	≈ 0.25	≈ (0.37)
TRE-50-087-0-B	.74	(18.8)	.64	(16.2)	.65	(16.5)	.55	(14)	2.13	(54)	3.15	(80)	.69	(17.4)	17.39	(58)	≈ 0.38	≈ (0.56)
TRE-60-087-0-B	.88	(22.5)	.77	(19.5)	.81	(20.5)	.69	(17.5)	2.56	(65)	3.43	(87)	.80	(20.4)	15.00	(49)	≈ 0.57	≈ (0.85)
TRE-70-110-B	1.10	(28)	.94	(24)	1.02	(26)	.87	(22)	3.19	(81)	4.33	(110)	1.01	(25.6)	11.88	(39)	≈ 0.89	≈ (1.32)
TRE-85-135-B	1.30	(33)	1.10	(28)	1.22	(31)	1.02	(26)	3.72	(94.5)	5.31	(135)	1.20	(30.6)	10.00	(33)	≈ 1.18	≈ (1.75)
TRE-100-145-B/C ¹⁾	1.48	(37.5)	1.28	(32.5)	1.40	(35.5)	1.20	(30.5)	4.25	(108)	5.71	(145)	1.36	(34.5)	8.82	(29)	≈ 1.60	≈ (2.38)
TRE-125-182-0	1.70	(43.3)	1.70	(43.3)	1.61	(41)	1.61	(41) ³⁾	5.31	(135)	7.17	(182)	1.76	(44.6)	6.82	(23)	≈ 3.16	≈ (4.70)

B-Series = 4-x higher torsion forces **C-Series** = quick assembly, 50% higher forces

1) Available as **C-Version** Part No. **TRE-100-145-0-C**

2) For quick and easy fitting or removal of cables using the "easy" design, we recommend a maximum cable diameter of 70% of the specified value

3) TRE 125: max. cable diameter Ø 1.61" (41mm). Max. cable diameter changes to Ø 1.42" (36mm) when an already populated e-chain needs to be shortened or lengthened

Installation dimensions

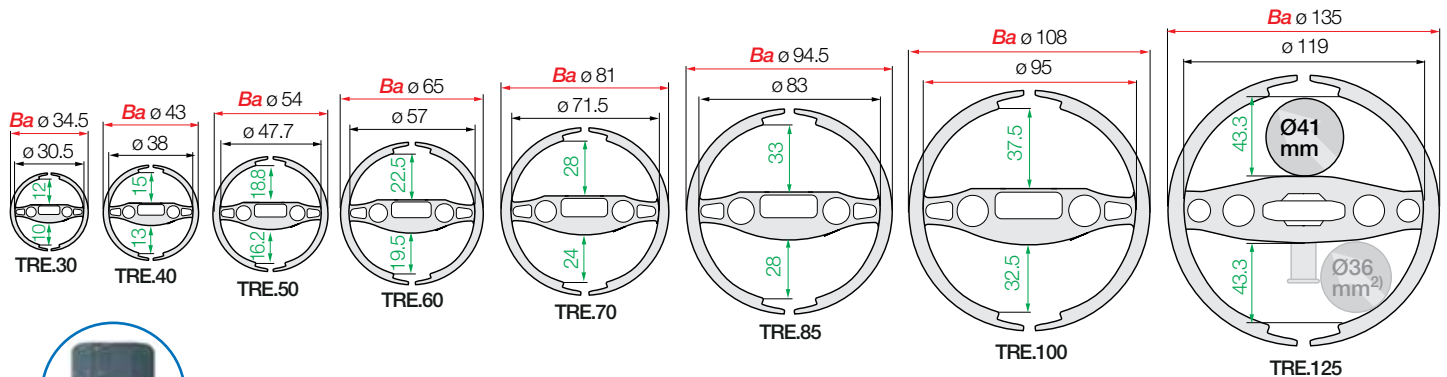

TRE-LOCK clips

Clips for a secure fit in the mounting bracket. Supplied with every mounting bracket. Please use the Part No. on the right for reordering individual parts

Part No. as an individual part	Size		Part No. as an individual part	Size	
	in.	(mm)		in.	(mm)
TRE.40.LOCK	1.18/1.57	(30/40)	TRE.70.LOCK	2.75/3.35	(70/85)
TRE.50.LOCK	1.97	(50)	TRE.100.LOCK	3.94	(100)
TRE.60.LOCK	2.36	(60)	TRE.125.LOCK	4.92	(125)

Easy to fill - simply press cables in - TRCF

TRCF - enclosed design with snap lock mechanism

High tensile strength thanks to special ball and socket design

Defined torsion stop, allows free movement in any direction but still protects the cables

Easy to open for large, stiff hoses or many cables

Easy assembly and disassembly - 4-piece, with openable lids

Impact-resistant and chip-resistant

3-chamber design for interior separation

Small bend radius and short pitch

Mounting bracket with strain relief also available as intermediate bracket

- Snap lock mechanism for fast opening to insert large cables or hoses
- Snap lock mechanism openable with a screwdriver
- Defined minimum bend radius and torsion stop-dog for optimum cable protection
- Enclosed version, for use with dirt and chip exposure
- 3 chamber design for ideal cable distribution and separation
- Easy to lengthen and shorten

Typical industries and applications

- Robotics and automation
- Painting applications
- Large hydraulic hoses
- Screw and rivet feeds
- Tool changer applications
- Laser welding applications
- Screw and rivet applications



Save time - easy disassembly tool available for triflex® R



Flip open, insert cable, and close snap lock mechanism - then ready to run!

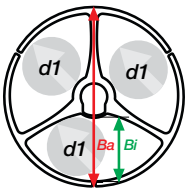

triflex® R - Series TRCF - Product Range

Closed design, chip-resistant, quick filling



TRCF



e-tubes - Series TRCF - Fully enclosed design, with snap lock mechanism

Series	Inner height		max. cable ϕ		Outer width		Bending radii		Pitch		Links		Weight	
	Bi		$d1$		Ba		R				per ft.	per m	in.	(mm)
	in.	(mm)	in.	(mm)	in.	(mm)	in.	(mm)	in.	(mm)				
TRCF-65-100-0	0.88	(22.3)	.79	(20)	2.76	(70.2)	3.94	(100)	0.91	(23.1)	13.19	(44)	\approx 0.74	\approx (1.10)
TRCF-65-200-0	0.88	(22.3)	.79	(20)	2.76	(70.2)	7.87	(200)	0.91	(23.1)	13.19	(44)	\approx 0.74	\approx (1.10)
TRCF-85-135-0	1.18	(30)	1.10	(28)	3.72	(94.5)	5.31	(135)	1.20	(30.6)	10.00	(33)	\approx 1.41	\approx (2.10)
TRCF-85-240-0 ¹⁾	1.18	(30)	1.10	(28)	3.72	(94.5)	9.45	(240)	1.20	(30.6)	10.00	(33)	\approx 1.41	\approx (2.10)
TRCF-100-145-0	1.35	(34.3)	1.27	(32.3)	4.25	(108)	5.71	(145)	1.36	(34.5)	8.82	(29)	\approx 1.81	\approx (2.70)

1) Special size Part No. TRCF-85-240-0 with 240 degree bend radius and a range of accessories

Installation dimensions

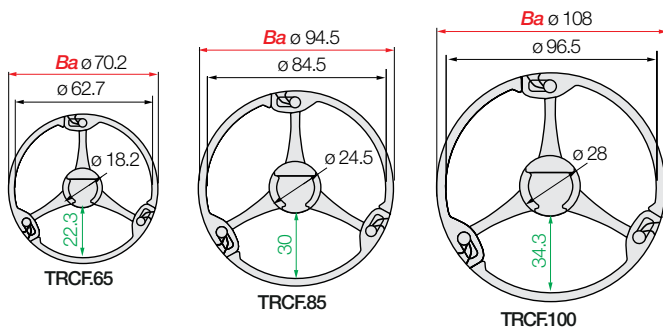

Snap lock mechanism for fast opening, video online

► www.igus.com/TRCF

Special sizes TRCF-65-200-0 and TRCF-85-240-0

- For secure guidance of fiber optic laser welding cables
- The large bend radius R 7.87" and 9.45" (200mm and 240mm) increases the service life of the fiber optic laser welding cable by preventing kinking

More information ► www.igus.com/TRCF



Lightweight and cost-effective - TRL

TRL - light and cost-effective with "easy" design

High tensile strength thanks to special ball and socket design

Defined torsion stop, allows free movement in any direction but still protects the cables

"Easy" design for fast filling with cables and hoses

Easy assembly and disassembly

Extremely lightweight due to one-piece design

Small bend radius and short pitch

Mounting bracket with strain relief also available as intermediate bracket

- Very easy to fill
- Multi-axis e-chain® for simple applications
- Easy to lengthen and shorten

Typical industries and applications

- Robot axes 1-3
- Non-robotic applications
- Bundling cables for operator controls
- Filament feeds on 3D printers
- Office applications



iF product design award

2007 igus® series TRL

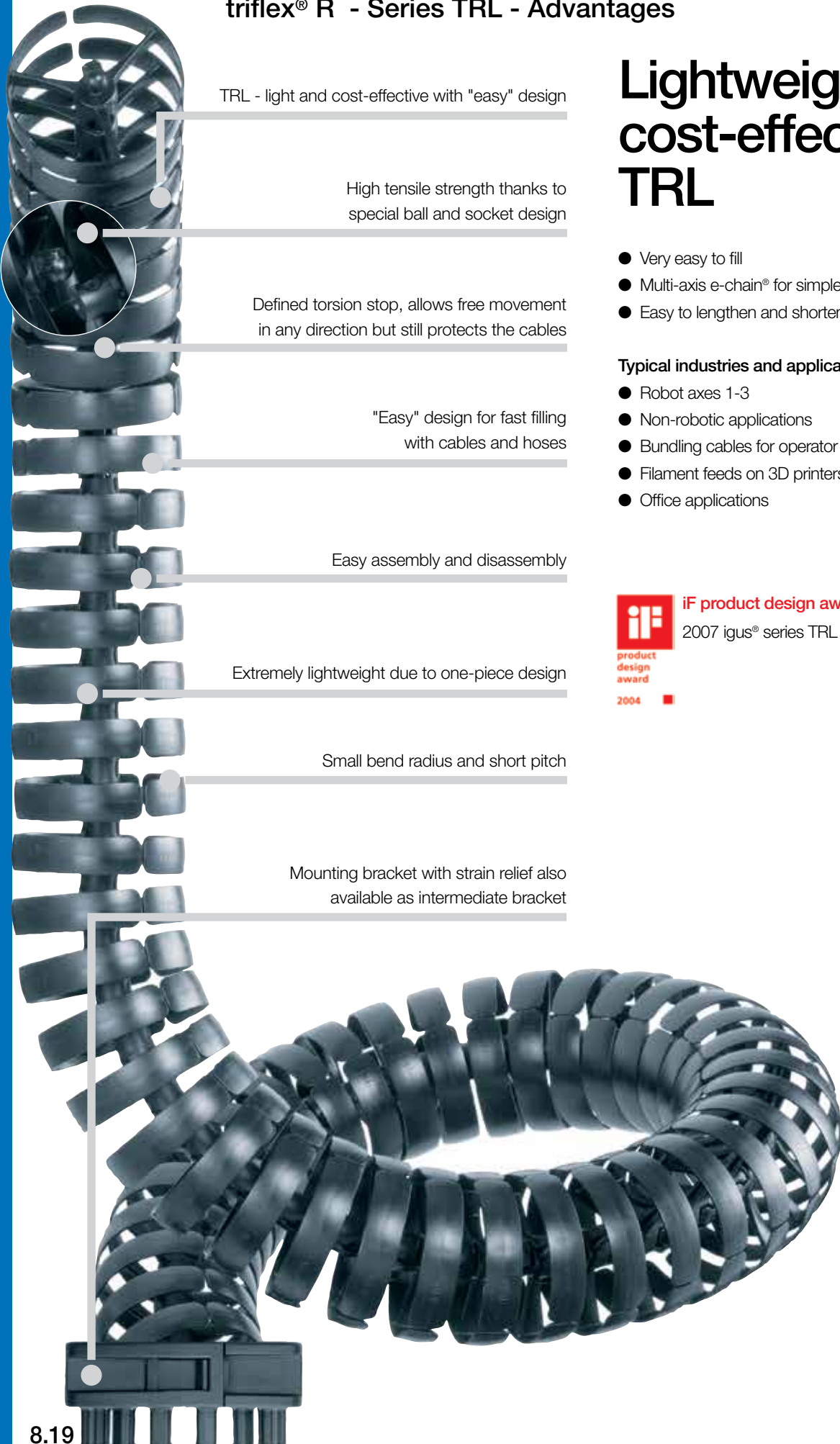

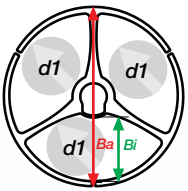

triflex® R - Series TRL - Product Range

Robotic applications, light and cost-effective



TRL

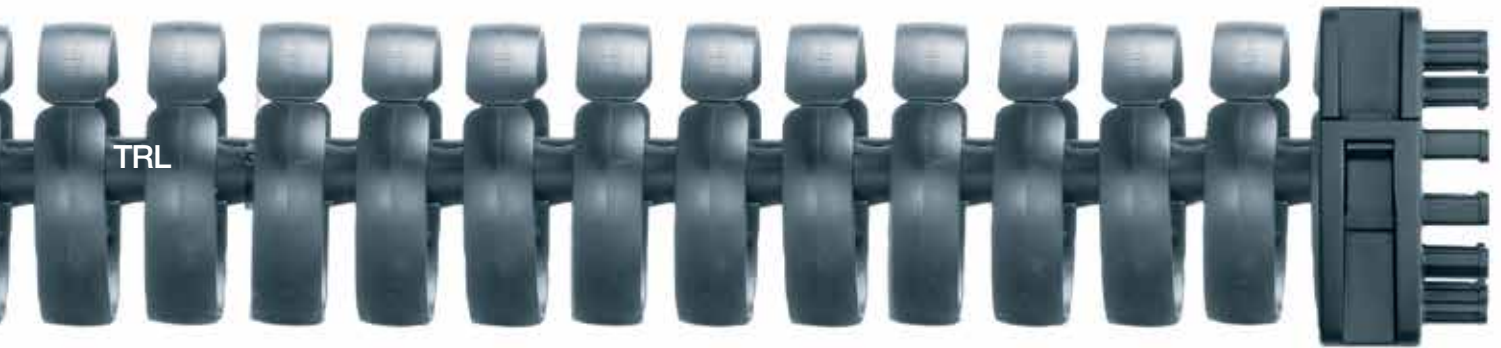

e-chains® - TRL series - Light version with "easy" design - simply press cables in

Series	Inner height				max. cable ø				Outer width		Bend radius		Pitch		Links		Weight	
	Bi 1		Bi 2		d1 ²⁾		d2 ²⁾		Ba		R		Pitch		Links		Weight	
	in.	(mm)	in.	(mm)	in.	(mm)	in.	(mm)	in.	(mm)	in.	(mm)	in.	(mm)	per ft.	per m	lbs/ft	kg/m
TRL-30-050-0 ¹⁾	.47	(12)	.43	(11)	.39	(10)	.31	(8)	1.36	(34.5)	1.97	(50)	.44	(11.3)	27.27	(89)	≈ 0.18	≈ 0.27
TRL-40-058-0	.59	(15)	–		.51	(13)	–		1.77	(45)	2.28	(58)	.55	(13.9)	21.82	(72)	≈ 0.25	≈ 0.37
TRL-60-087-0	.91	(23)	–		.81	(20.5)	–		2.56	(65)	3.43	(87)	.80	(20.4)	15.00	(49)	≈ 0.57	≈ 0.85
TRL-70-110-0	1.10	(28)	–		1.02	(26)	–		3.19	(81)	4.33	(110)	1.01	(25.6)	11.88	(39)	≈ 0.89	≈ 1.32
TRL-100-145-0	1.50	(38)	–		1.40	(35.5)	–		4.25	(108)	5.71	(145)	1.36	(34.5)	8.82	(29)	≈ 1.60	≈ 2.38

1) Only available with 2-chamber design

2) For quick and easy fitting or removal of cables using the "easy" design, we recommend a maximum cable diameter of 70% of the specified value

Installation dimensions

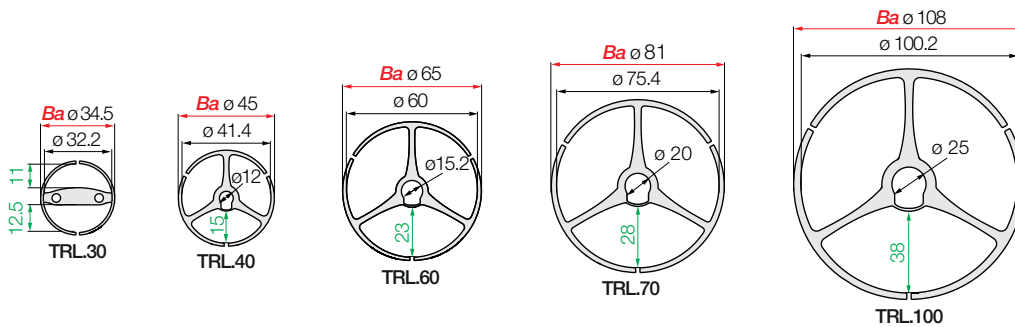

Lightweight with snap lock mechanism - TRLF

TRLF - light and cost-effective
with snap lock mechanism

High tensile strength thanks to
special ball and socket design

Defined torsion stop, allows free movement
in any direction but still protects the cables

Easy to open for large, stiff hoses or many cables

Easy assembly and disassembly

3-chamber design for interior separation

Small bend radius and short pitch

Lightweight mounting bracket available
with strain relief or as intermediate bracket

- Snap lock mechanism for fast opening
- Openable by hand or with a screwdriver
- For large, stiff hoses or many cables
- Economical multi-axis e-chain® for less demanding applications
- Easy to lengthen and shorten

Typical industries and applications

- Painting hoses
- Rivet feeds
- Robot axes 1-3
- Non-robotic applications
- Special machine construction
- High-tech design



Flip open, insert cable, and
close snap lock mechanism -
then ready to run!

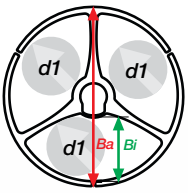

triflex® R - Series TRLF - Product Range

Quick filling with larger hoses and cables



TRLF



e-chains® - TRLF series - Light version with snap lock mechanism

Series	Inner height		max. cable ø		Outer width		Bend radius		Pitch		Links		Weight	
	<i>Bi 1</i>		<i>d1</i>		<i>Ba</i>		<i>R</i>							
	in.	(mm)	in.	(mm)	in.	(mm)	in.	(mm)	in.	(mm)	per ft.	per m	lbs/ft	kg/m
TRLF-65-100-0	.96	(24.4)	.87	(22)	2.76	(70.2)	3.94	(100)	.91	(23.1)	13.2	(44)	≈ 0.53	≈ 0.79
TRLF-85-135-0	1.29	(32.8)	1.18	(30)	3.72	(94.5)	5.31	(135)	1.20	(30.6)	10.0	(33)	≈ 0.97	≈ 1.45
TRLF-100-145-0	1.48	(37.5)	1.40	(35.5)	4.25	(108)	5.71	(145)	1.36	(34.5)	8.8	(29)	≈ 1.28	≈ 1.90
TRLF-125-182-0	1.84	(46.8)	1.75	(44.5)	5.31	(135)	7.17	(182)	1.74	(44.1)	6.9	(23)	≈ 2.78	≈ 4.13

Installation dimensions

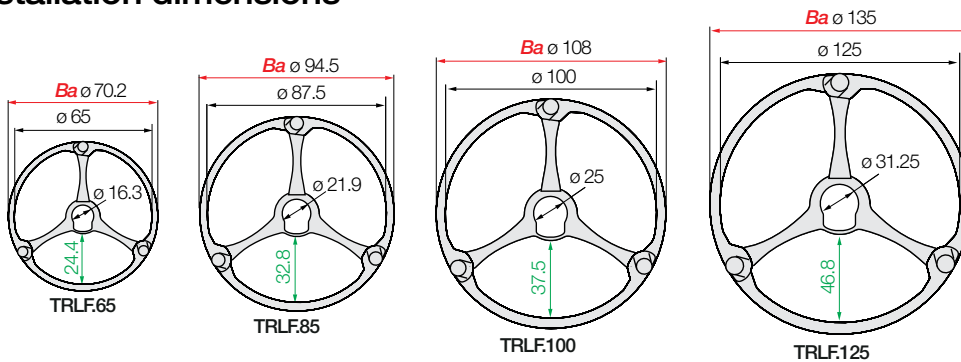

Snap lock mechanism for fast opening, video online

► www.igus.com/TRLF

With integrated strain relief tiewrap plates
TR.40.01 / TR.100.01

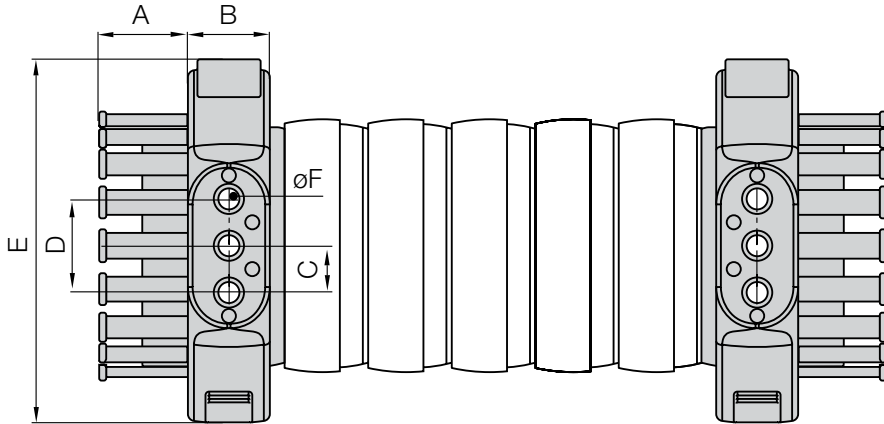

- Recommended for TRC/TRE/TRCF, also compatible with TRL/TRLF
- Standard fixation onto the robot or machine, with strain relief

Standard mounting brackets - With strain relief



TR.40.01 –
TR.100.01

Index	Part No. with strain relief	A		B		C		D		E		F	
		in.	(mm)	in.	(mm)	in.	(mm)	in.	(mm)	in.	(mm)	in.	(mm)
30.	▶ Alternative: light mounting bracket	-	-	-	-	-	-	-	-	-	-	-	-
40.	▶ TR.40.01.M6 ¹⁾²⁾	.70	(17.8)	.83	(21)	.53	(13.5)	1.06	(27)	3.33	(84.5)	.26	(6.5)
50.	▶ TR.50.01.M6 ¹⁾	.83	(21)	.83	(21)	.53	(13.5)	1.06	(27)	3.33	(84.5)	.26	(6.5)
60.	▶ TR.60.01.M8 ¹⁾²⁾	.98	(25)	1.26	(32)	.79	(20)	1.57	(40)	4.96	(126)	.35	(9)
65.	▶ TR.65.01.M8 ⁵⁾	.98	(25)	1.26	(32)	.79	(20)	1.57	(40)	4.96	(126)	.35	(9)
70.	▶ TR.70.01.M8 ¹⁾²⁾	.98	(25)	1.26	(32)	.79	(20)	1.57	(40)	4.96	(126)	.35	(9)
85.	▶ TR.85.01.M8 ¹⁾	1.50	(38)	1.38	(35)	.79	(20)	1.57	(40)	6.10	(155)	.35	(9)
85. (R 240)	▶ TR.85.240.01.M8 ¹⁾	1.50	(38)	1.38	(35)	.79	(20)	1.57	(40)	6.10	(155)	.35	(9)
100.	▶ TR.100.01.M8 ¹⁾	1.50	(38)	1.38	(35)	.79	(20)	1.57	(40)	6.10	(155)	.35	(9)
125.	▶ Alternative: standard mounting bracket without strain relief	-	-	-	-	-	-	-	-	-	-	-	-

Strain relief is for use on the fixed end and/or moving end.

Standard: through holes in Ø F - 1) option: with threaded bushings, steel, M6/M8

2) Available as ESD version from stock

5) Available for delivery upon request. Please consult igus® for delivery time.

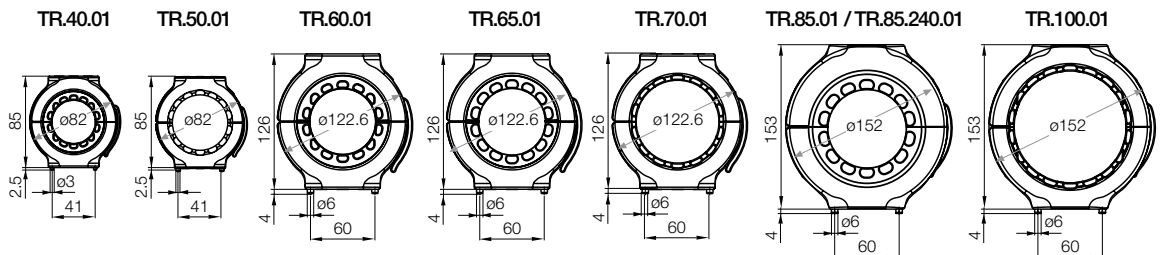

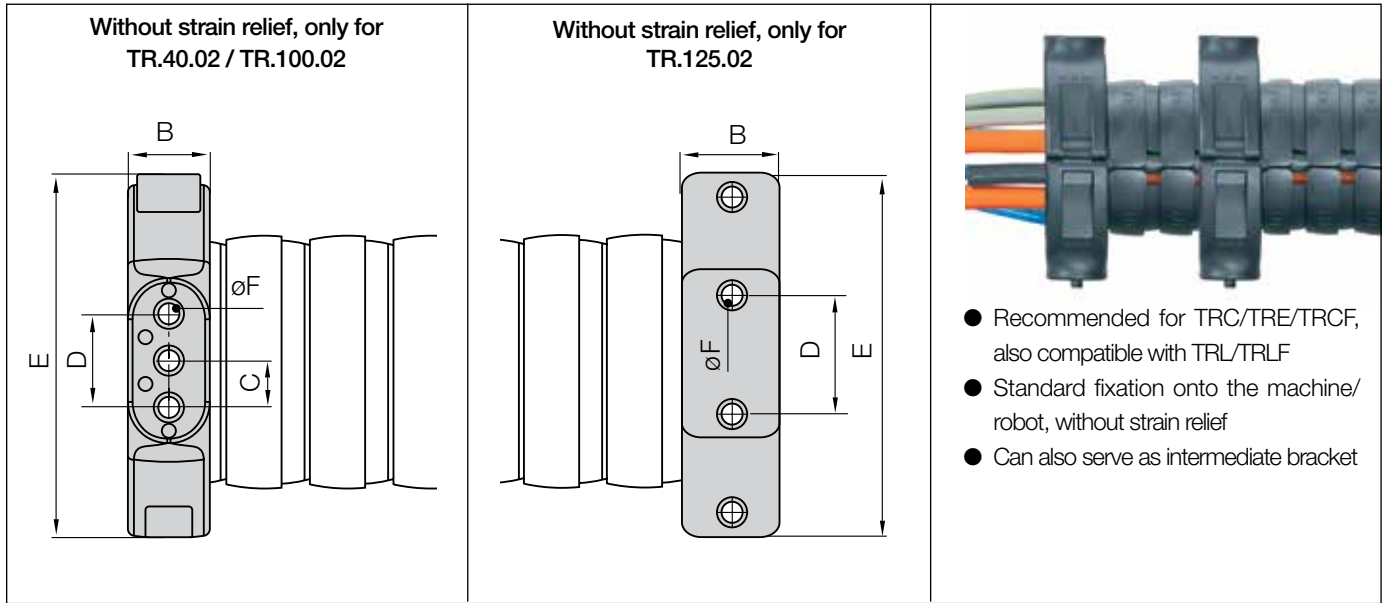

- Recommended for TRC/TRE/TRCF, also compatible with TRL/TRLF
- Standard fixation onto the machine/robot, without strain relief
- Can also serve as intermediate bracket

Standard mounting brackets - Without strain relief



TR.40.02 –
TR.100.02



TR.125.02

Ø Index	Part No. without strain relief or as intermediate bracket	A		B		C		D		E		F	
		in.	(mm)	in.	(mm)	in.	(mm)	in.	(mm)	in.	(mm)	in.	(mm)
30.	▶ Alternative: light mounting bracket	-	-	-	-	-	-	-	-	-	-	-	-
40.	▶ TR.40.02.M6 ¹⁾	-	.83 (21)	.53 (13.5)	1.06 (27)	3.33 (84.5)	.26 (6.5)						
50.	▶ TR.50.02.M6 ¹⁾	-	.83 (21)	.53 (13.5)	1.06 (27)	3.33 (84.5)	.26 (6.5)						
60.	▶ TR.60.02.M8 ¹⁾	-	1.26 (32)	.79 (20)	1.57 (40)	4.96 (126)	.35 (9)						
65.	▶ TR.65.02.M8 ¹⁾	-	1.26 (32)	.79 (20)	1.57 (40)	4.96 (126)	.35 (9)						
70.	▶ TR.70.02.M8 ¹⁾	-	1.26 (32)	.79 (20)	1.57 (40)	4.96 (126)	.35 (9)						
85.	▶ TR.85.02.M8 ¹⁾	-	1.38 (35)	.79 (20)	1.57 (40)	6.10 (155)	.35 (9)						
85. (R 240)	▶ TR.85.240.02.M8 ¹⁾	-	1.38 (35)	.79 (20)	1.57 (40)	6.10 (155)	.35 (9)						
100.	▶ TR.100.02.M8 ¹⁾	-	1.38 (35)	.79 (20)	1.57 (40)	6.10 (155)	.35 (9)						
125.	▶ Alternative: standard mounting bracket without strain relief												

Standard: through holes in Ø F - 1) option: with threaded bushings, steel, M6/M8
 2) ⚠ Available as ESD version from stock

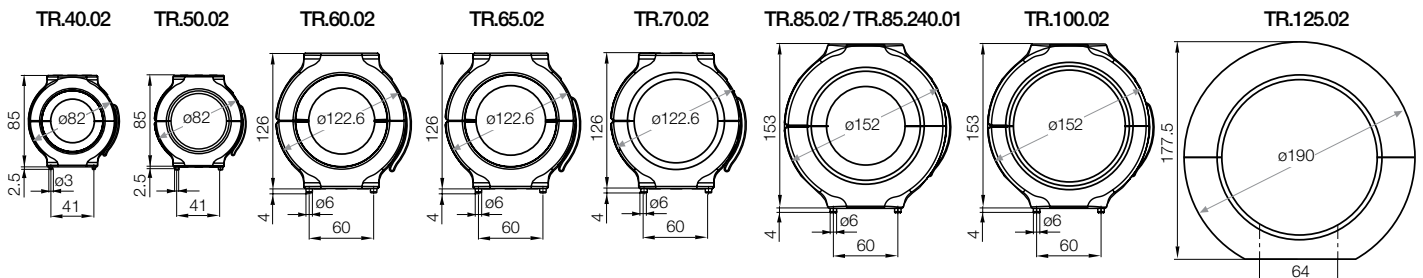

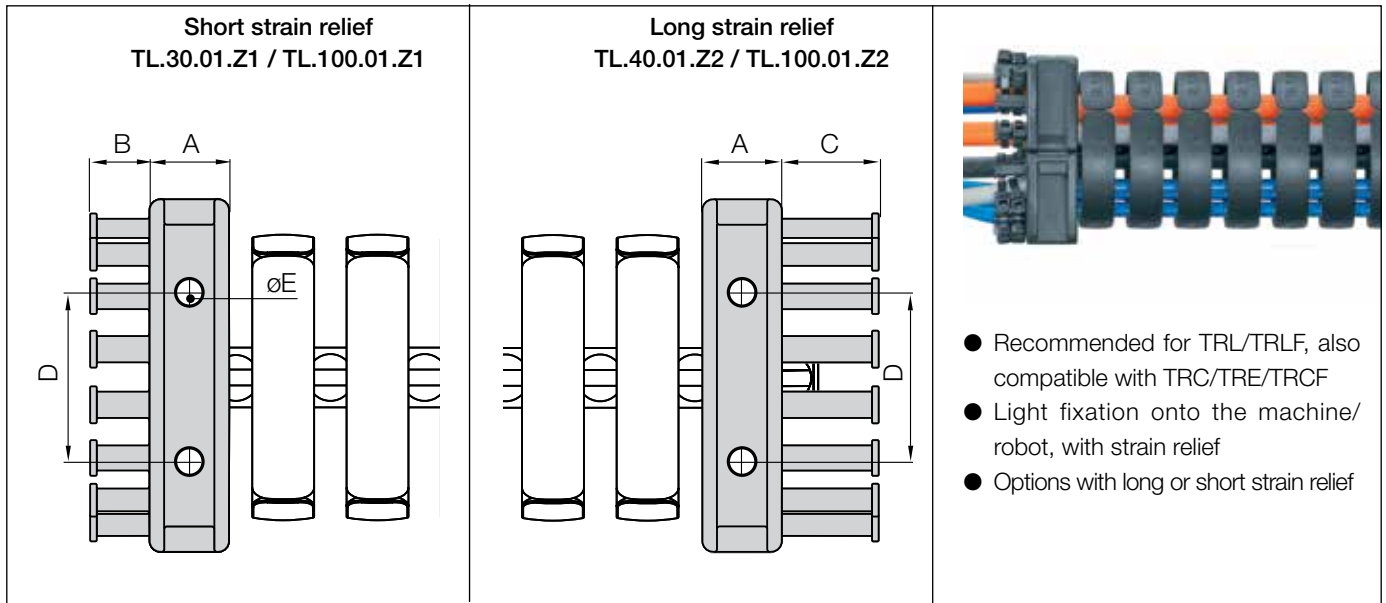

- Recommended for TRL/TRLF, also compatible with TRC/TRE/TRCF
- Light fixation onto the machine/robot, with strain relief
- Options with long or short strain relief

Light mounting brackets - With strain relief



TL.30.01.Z1 to TL.100.01.Z1



TL.40.01.Z2 to TL.100.01.Z2

Index	Part No. with short strain relief	Part No. with long strain relief	A		B		C		D		E	
			in.	(mm)	in.	(mm)	in.	(mm)	in.	(mm)	in.	(mm)
30.	▶ TL.30.01.Z1	-	.51	(13)	.49	(12.5)	-	-	.94	(24)	.18	4.5
40.	▶ TL.40.01.Z1 ¹⁾	TL.40.01.Z2	.55	(14)	.49	(12.5)	.79	(20)	1.42	(36)	.23	(5.8)
50.	▶ Alternative: standard mounting bracket		-	-	-	-	-	-	-	-	-	-
60.	▶ TL.60.01.Z1 ¹⁾	TL.60.01.Z2	.79	(20)	.67	(17)	1.06	(27)	1.89	(48)	.23	(5.8)
65.	▶ TL.65.01.Z1 ¹⁾	-	1.06	(27)	.53	(13.5)	-	-	2.52	(64)	.26	(6.5)
70.	▶ TL.70.01.Z1 ¹⁾	TL.70.01.Z2	1.06	(27)	.69	(17.5)	1.08	(27.5)	2.52	(64)	.26	(6.5)
85.	▶ TL.85.01.Z1	-	1.18	(30)	1.04	(26.5)	-	-	2.52	(64)	.26	(6.5)
85. (R 240)	▶ Alternative: standard mounting bracket		-	-	-	-	-	-	-	-	-	-
100.	▶ TL.100.01.Z ¹⁾	TL.100.01.Z2	1.18	(30)	.88	(22.5)	1.67	(42.5)	2.52	(64)	.26	(6.5)
125.	▶ Alternative: standard mounting bracket		-	-	-	-	-	-	-	-	-	-

1) For moving end (ball) suitable only for series TRL/TRLF

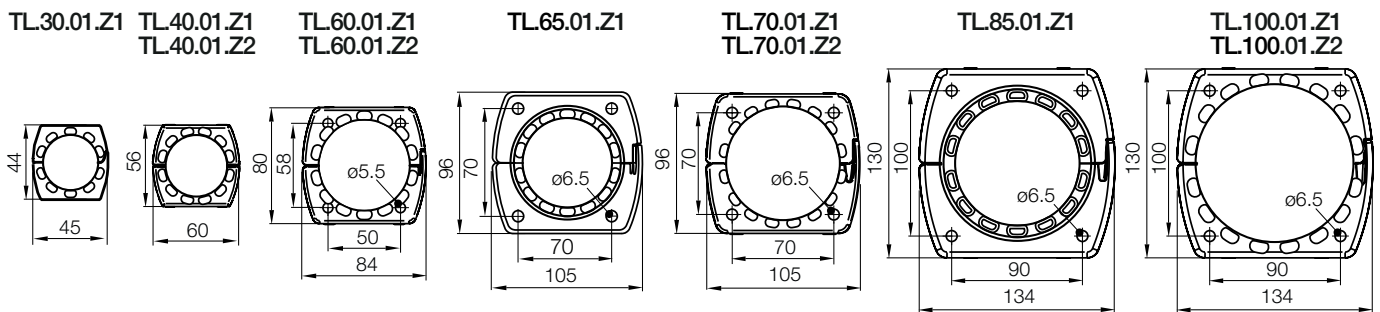

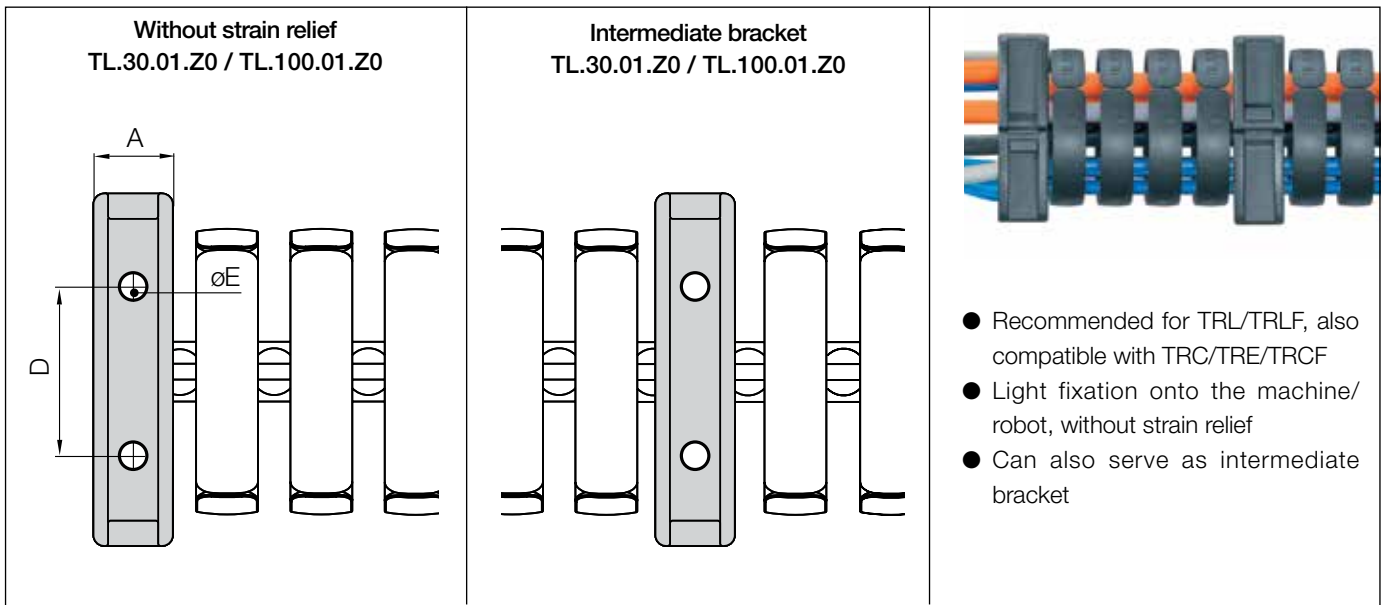

- Recommended for TRL/TRLF, also compatible with TRC/TRE/TRCF
- Light fixation onto the machine/robot, without strain relief
- Can also serve as intermediate bracket

Light mounting brackets - Without strain relief



TL.30.01.Z0 to TL.100.01.Z0

ø Index	Part No. without strain relief or as intermediate bracket	A		B		C		D		E	
		in.	(mm)	in.	(mm)	in.	(mm)	in.	(mm)	in.	(mm)
30.	▶ TL.30.01.Z0	.51	(13)	-	-	-	-	.94	(24)	.18	4.5
40.	▶ TL.40.01.Z0	.55	(14)	-	-	-	-	1.42	(36)	.23	(5.8)
60.	▶ TL.60.01.Z0	.79	(20)	-	-	-	-	1.89	(48)	.23	(5.8)
65.	▶ TL.65.01.Z0	1.06	(27)	-	-	-	-	2.52	(64)	.26	(6.5)
70.	▶ TL.70.01.Z0	1.06	(27)	-	-	-	-	2.52	(64)	.26	(6.5)
85.	▶ TL.85.01.Z0	1.18	(30)	-	-	-	-	2.52	(64)	.26	(6.5)
85. (R 240)	▶ TL.85.240.01.Z0	-	-	-	-	-	-	-	-	-	-
100.	▶ TL.100.01.Z0	1.18	(30)	-	-	-	-	2.52	(64)	.26	(6.5)
125.	▶ Alternative: standard mounting bracket	-	-	-	-	-	-	-	-	-	-

TL.30.01.Z0 TL.40.01.Z0 TL.60.01.Z0 TL.65.01.Z0 TL.70.01.Z0 TL.85.01.Z0 TL.100.01.Z0

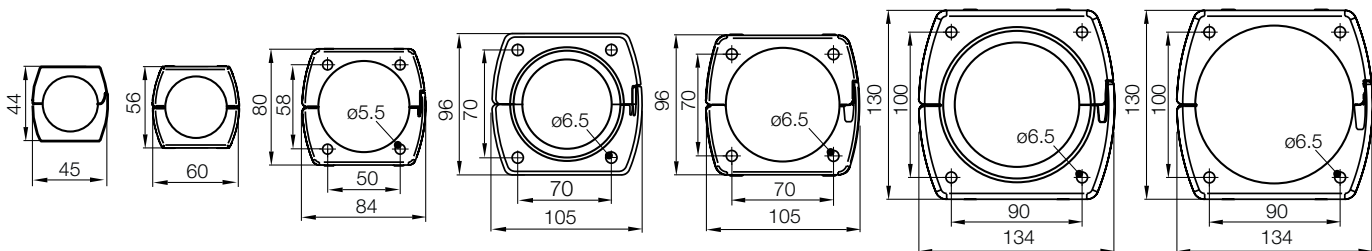

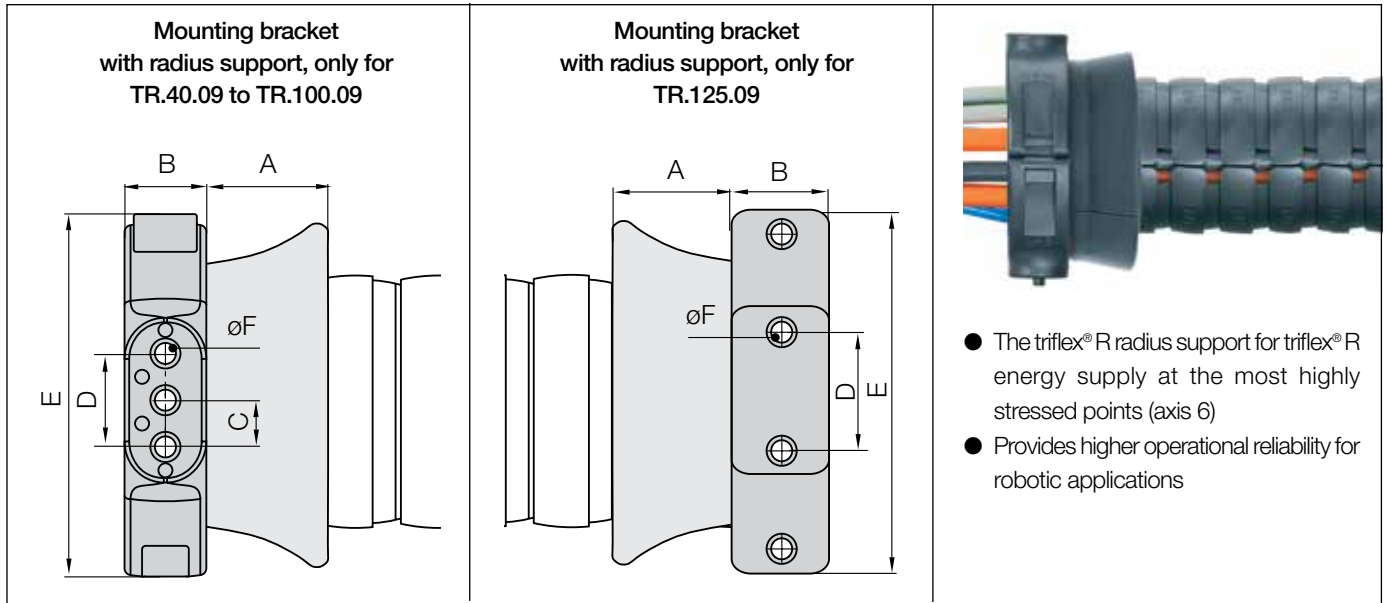

- The triflex® R radius support for triflex® R energy supply at the most highly stressed points (axis 6)
- Provides higher operational reliability for robotic applications

Mounting brackets - With radius support - For TRC·TRE·TRCF·TRL·TRLF



TR.40.09 to TR.100.09



TR.125.09

ø Index	Part No. with short strain relief	A		B		C		D		E		F	
		in.	(mm)	in.	(mm)	in.	(mm)	in.	(mm)	in.	(mm)	in.	(mm)
30.	▶ -	-	-	-	-	-	-	-	-	-	-	-	-
40.	▶ TR.40.09.M6 ¹⁾	1.10	(28)	.83	(21)	.53	(13.5)	1.06	(27)	3.33	(84.5)	.26	(6.5)
50.	▶ TR.50.09.M6 ¹⁾	1.50	(38)	.83	(21)	.53	(13.5)	1.06	(27)	3.33	(84.5)	.26	(6.5)
60.	▶ TR.60.09.M8 ¹⁾	1.50	(38)	1.26	(32)	.79	(20)	1.57	(40)	4.96	(126)	.35	(9)
65.	▶ TR.65.09.M8 ¹⁾	1.77	(45)	1.26	(32)	.79	(20)	1.57	(40)	4.96	(126)	.35	(9)
70.	▶ TR.70.09.M8 ¹⁾	1.69	(43)	1.26	(32)	.79	(20)	1.57	(40)	4.96	(126)	.35	(9)
85.	▶ TR.85.09.M8 ¹⁾	1.93	(49)	1.38	(35)	.79	(20)	1.57	(40)	6.10	(155)	.35	(9)
85. (R 240)	▶ -	-	-	-	-	-	-	-	-	-	-	-	-
100.	▶ TR.100.09.M8 ¹⁾	2.64	(67)	1.38	(35)	.79	(20)	1.57	(40)	6.10	(155)	.35	(9)
125.	▶ TR.125.09.M8 ¹⁾	2.83	(72)	1.57	(40)	-	-	2.52	(64)	7.48	(190)	.35	(9)

Standard: through holes in Ø F - 1) option: with threaded bushings, steel, M6/M8

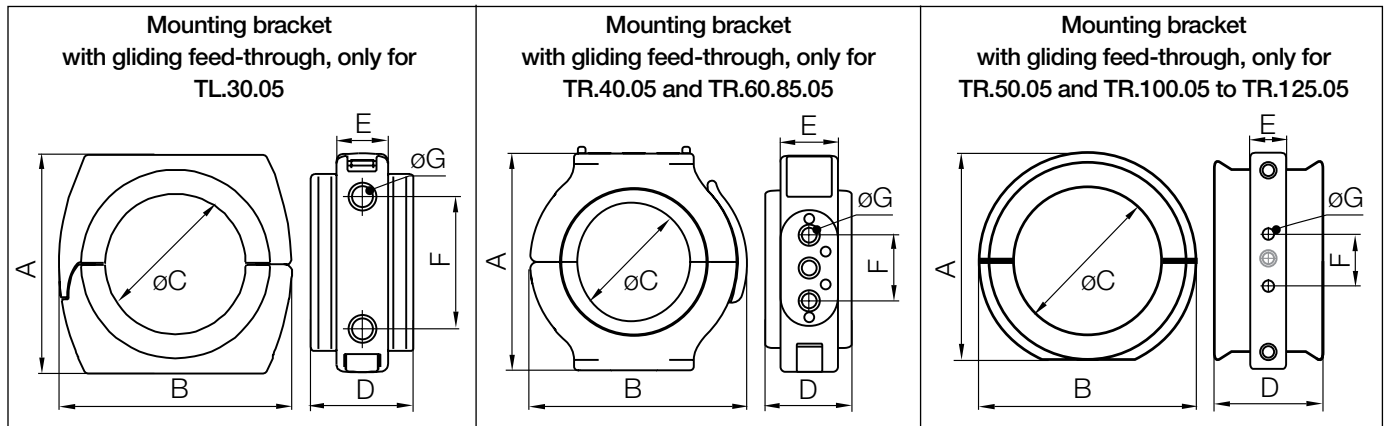

- The gliding feed-through enables easy guidance of the e-chain® and can also be used as an additional guide
- Gliding feed-through with swivel bearing also available



Gliding feed-through - For TRC·TRE·TRCF·TRL·TRLF



TL.30.05



TR.40.05 and TR.60.05 to TR.85.05



TR.50.05 and TR.100.05 to TR.125.05

Index	Part No. with short strain relief	A		B		C		D		E		F		G	
		in.	(mm)	in.	(mm)	in.	(mm)	in.	(mm)	in.	(mm)	in.	(mm)	in.	(mm)
30.	▶ TL.30.05	2.20	(56)	2.36	(60)	1.42	(36)	1.10	(28)	.55	(14)	1.42	(36)	.23	(5.8)
40.	▶ TR.40.05.M6 ¹⁾	3.35	(85)	3.33	(84.5)	1.81	(46)	1.26	(32)	.83	(21)	1.06	(27)	.26	(6.5)
50.	▶ TR.50.05.M6 ¹⁾	3.78	(96)	4.02	(102)	2.28	(58)	2.64	(67)	.83	(21)	1.06	(27)	.26	(6.5)
60.	▶ TR.60.05.M8 ¹⁾	4.96	(126)	4.96	(126)	2.76	(70)	1.97	(50)	1.26	(32)	1.57	(40)	.35	(9)
65. (R 200)	▶ TR.65.05.M8 ¹⁾	4.96	(126)	4.96	(126)	2.95	(75)	2.95	(75)	1.26	(32)	1.57	(40)	.35	(9)
70.	▶ TR.70.05.M8 ¹⁾	6.02	(153)	6.10	(155)	3.39	(86)	2.76	(70)	1.38	(35)	1.57	(40)	.35	(9)
85.	▶ TR.85.05.M8 ¹⁾	6.02	(153)	6.10	(155)	3.94	(100)	3.31	(84)	1.38	(35)	1.57	(40)	.35	(9)
85. (R 240)	▶ TR.85.05.M8 ¹⁾	6.02	(153)	6.10	(155)	3.94	(100)	3.31	(84)	1.38	(35)	1.57	(40)	.35	(9)
100.	▶ TR.100.05.M8 ¹⁾ *	6.40	(162.5)	6.67	(169.5)	4.53	(115)	3.35	(85)	1.10	(28)	1.57	(40)	.33	(8.5)
125.	▶ TR.125.05.M8 ¹⁾	7.05	(179)	7.48	(190)	5.59	(142)	3.31	(84)	1.57	(40)	2.52	(64)	.35	(9)

TR.100.05 with 3 holes

Standard: through holes in Ø G

1) option: with insert nuts, steel, M6/M8

Mounting bracket
with strain relief, only for TR.40.03 to TR.100.03

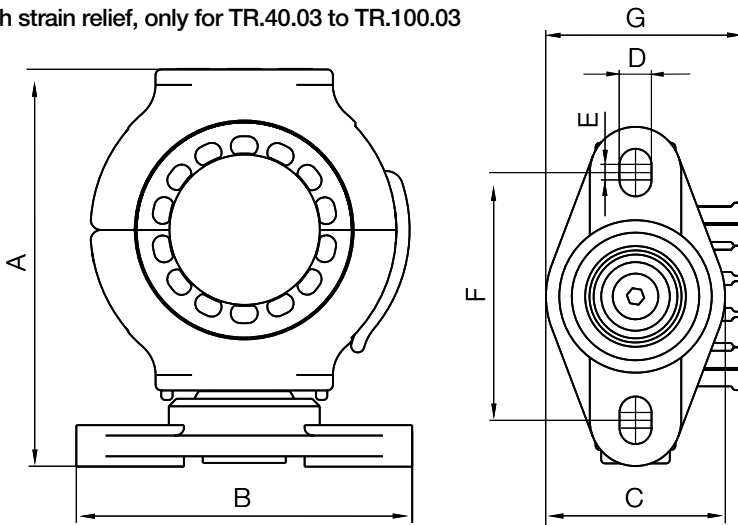

- Standard mounting bracket with strain relief and maintenance-free igubal® spherical bearing
- Pivoting mounting for extreme rotating and reverse bending movements
- For TRC·TRE·TRCF·TRL·TRLF

Swivel bearing mounting brackets - With strain relief - For TRC·TRE·TRCF·TRL·TRLF



TR.40.03 /
TR.100.03

ø Index	Part No. with strain relief	A		B		C		D		E		F		G	
		in.	(mm)	in.	(mm)	in.	(mm)	in.	(mm)	in.	(mm)	in.	(mm)	in.	(mm)
30.	▶	-	-	-	-	-	-	-	-	-	-	-	-	-	-
40.	▶ TR.40.03	4.13	(105)	3.50	(89)	1.85	(47)	.33	(8.4)	.16	(4.1)	2.56	(65)	2.04	(51.8)
50.	▶ TR.50.03	4.13	(105)	3.50	(89)	1.85	(47)	.33	(8.4)	.16	(4.1)	2.56	(65)	2.17	(55)
60.	▶ TR.60.03	5.98	(152)	4.65	(118)	2.56	(65)	.41	(10.5)	.22	(5.5)	3.44	(87.5)	2.89	(73.5)
65.	▶ TR.65.03	5.98	(152)	4.65	(118)	2.56	(65)	.41	(10.5)	.22	(5.5)	3.44	(87.5)	2.89	(73.5)
70.	▶ TR.70.03	5.98	(152)	4.65	(118)	2.56	(65)	.41	(10.5)	.22	(5.5)	3.44	(87.5)	2.89	(73.5)
85.	▶ TR.85.03	7.05	(179)	4.65	(118)	2.56	(65)	.41	(10.5)	.22	(5.5)	3.44	(87.5)	3.46	(88)
85. (R 240)	▶ TR.85.240.03	7.05	(179)	4.65	(118)	2.56	(65)	.41	(10.5)	.22	(5.5)	3.44	(87.5)	3.46	(88)
100.	▶ TR.100.03	7.05	(179)	4.65	(118)	2.56	(65)	.41	(10.5)	.22	(5.5)	3.44	(87.5)	3.46	(88)
125.	▶	-	-	-	-	-	-	-	-	-	-	-	-	-	-

Mounting bracket
 without strain relief, only for TR.40.04 to TR.100.04

- Standard mounting bracket without strain relief and maintenance-free igubal® spherical bearing
- Pivoting mounting for extreme rotating and reverse bending movements
- For TRC·TRE·TRCF·TRL·TRLF

Swivel bearing mounting brackets - Without strain relief - For TRC·TRE·TRCF·TRL·TRLF



TR.40.04 / TR.100.04

ø Index	Part No. without strain relief	A		B		C		D		E		F		G	
		in.	(mm)	in.	(mm)	in.	(mm)	in.	(mm)	in.	(mm)	in.	(mm)	in.	(mm)
30.	▶	-	-	-	-	-	-	-	-	-	-	-	-	-	-
40.	▶ TR.40.04	4.13	(105)	3.50	(89)	1.85	(47)	.33	(8.4)	.16	(4.1)	2.56	(65)	-	-
50.	▶ TR.50.04	4.13	(105)	3.50	(89)	1.85	(47)	.33	(8.4)	.16	(4.1)	2.56	(65)	-	-
60.	▶ TR.60.04	5.98	(152)	4.65	(118)	2.56	(65)	.41	(10.5)	.22	(5.5)	3.44	(87.5)	-	-
65.	▶ TR.65.04	5.98	(152)	4.65	(118)	2.56	(65)	.41	(10.5)	.22	(5.5)	3.44	(87.5)	-	-
70.	▶ TR.70.04	5.98	(152)	4.65	(118)	2.56	(65)	.41	(10.5)	.22	(5.5)	3.44	(87.5)	-	-
85.	▶ TR.85.04	7.05	(179)	4.65	(118)	2.56	(65)	.41	(10.5)	.22	(5.5)	3.44	(87.5)	-	-
85. (R 240)	▶ TR.85.240.04	7.05	(179)	4.65	(118)	2.56	(65)	.41	(10.5)	.22	(5.5)	3.44	(87.5)	-	-
100.	▶ TR.100.04	7.05	(179)	4.65	(118)	2.56	(65)	.41	(10.5)	.22	(5.5)	3.44	(87.5)	-	-
125.	▶	-	-	-	-	-	-	-	-	-	-	-	-	-	-

Swivel bearing gliding feed-throughs
TR.40.07 to TR.85.07

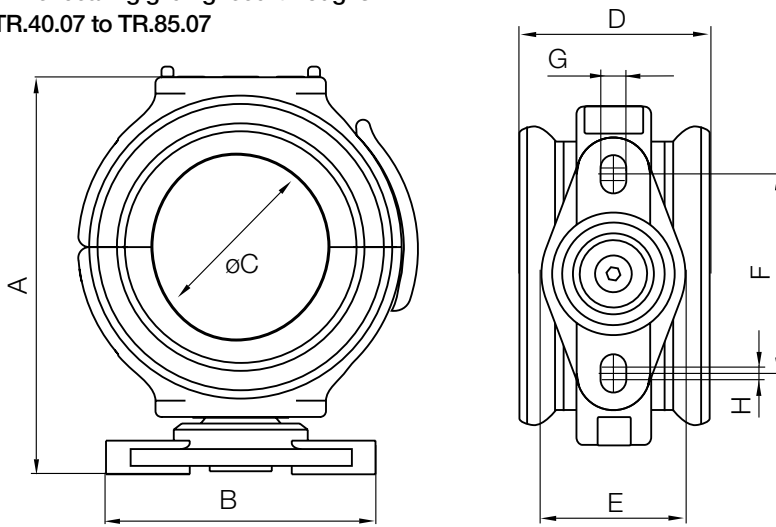

- Gliding feed-through with swivel bearing
- For TRC·TRE·TRCF e-chains®
- Pivoting mounting with maintenance-free igubal® spherical bearings

Swivel bearing gliding feed-throughs - For TRC·TRE·TRCF



TR.40.07 to
TR.100.07

Ø Index	Part No. with swivel bearing	A		B		C		D		E		F		G	
		in.	(mm)	in.	(mm)	in.	(mm)	in.	(mm)	in.	(mm)	in.	(mm)	in.	(mm)
30.	▶	-	-	-	-	-	-	-	-	-	-	-	-	-	-
40.	▶ TR.40.07	4.25	(108)	3.50	(89)	1.81	(46)	1.26	(32)	1.85	(47)	2.56	(65)	.33	(8.4)
50.	▶ TR.50.07	4.69	(119)	3.50	(89)	2.28	(58)	2.64	(67)	1.85	(47)	2.56	(65)	.33	(8.4)
60.	▶ TR.60.07	6.14	(156)	4.65	(118)	2.76	(70)	1.97	(50)	2.56	(65)	3.44	(87.5)	.41	(10.5)
60.	▶ TR.65.07	6.14	(156)	4.65	(118)	2.95	(75)	2.95	(75)	2.56	(65)	3.44	(87.5)	.41	(10.5)
70.	▶ TR.70.07	7.20	(183)	4.65	(118)	3.39	(86)	2.76	(70)	2.56	(65)	3.44	(87.5)	.41	(10.5)
85.	▶ TR.85.07	7.20	(183)	4.65	(118)	3.94	(100)	3.31	(84)	2.56	(65)	3.44	(87.5)	.41	(10.5)
85. (R 240)	▶ TR.85.07	7.20	(183)	4.65	(118)	3.94	(100)	3.31	(84)	2.56	(65)	3.44	(87.5)	.41	(10.5)
100.	▶ -	-	-	-	-	-	-	-	-	-	-	-	-	-	-
125.	▶ -	-	-	-	-	-	-	-	-	-	-	-	-	-	-

Protector
 TR.XX.10 to TR.XX.30

- Optional protectors can be fitted at contact points
- For extreme operations and long service life
- Easy gliding over edges
- Damping, light, freely positionable
- Easy to fit and quick replacement
- Protector with quick-release fastener also available

Protectors - For TRC·TRE·TRCF



TR.40.10 to
 TR.125.10



TR.40.30 to
 TR.100.30

\varnothing Index	Part No. with screw connection	Part No. with quick release	A in. (mm)	B in. (mm)
30.	▶	-	-	-
40.	▶ TR.40.10	TR.40.30 ²⁾	1.06 (27)	2.17 (55)
50.	▶ TR.50.10	TR.50.30 ¹⁾	1.34 (34)	2.72 (69)
60.	▶ TR.60.10	TR.60.30 ²⁾	1.57 (40)	3.15 (80)
65.	▶ TR.65.10	TR.65.30 ¹⁾	1.73 (44)	3.46 (88)
70.	▶ TR.70.10	TR.70.30	1.97 (50)	4.02 (102)
85.	▶ TR.85.10	TR.85.30	2.32 (59)	4.65 (118)
85. (R 240)	▶ TR.85.240.10	TR.85.240.30 ¹⁾	2.48 (63)	4.72 (120)
100.	▶ TR.100.10	TR.100.30	2.64 (67)	5.24 (133)
125.	▶ TR.125.10	-	3.23 (82)	6.69 (170)

1) Available upon request. Delivery time upon request
 2) TR-40-30, TR-60-30 without an additional locking clip

Heavy duty connections - Standard
TR.60.20.XX to TR.125.20.XX

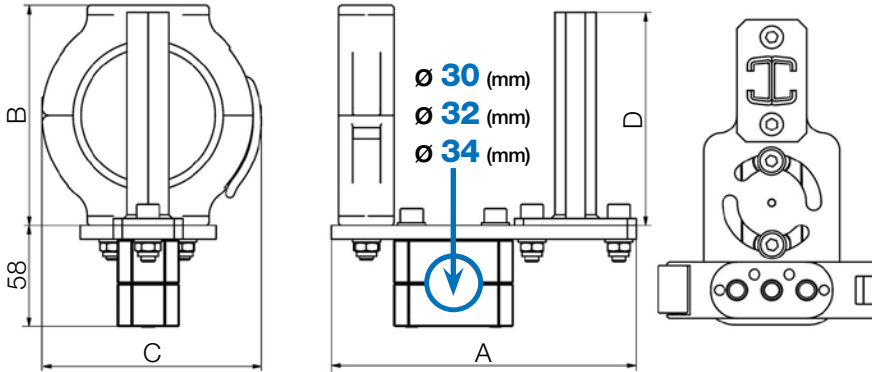

- Heavy duty connection - standard
- For cables with large cross section
- For heavy hydraulic hoses
- Double C-profile for CFX clamps
- igus® chainfix clamps must be ordered separately

Heavy duty connections - For TRC·TRE·TRCF

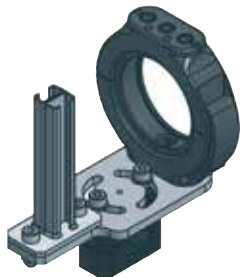

TR.60.20.XX to
TR.125.20.XX

Ø Index	Part No. standard	Clamp diameter Ø (mm)	A		B		C		D	
			in.	(mm)	in.	(mm)	in.	(mm)	in.	(mm)
30.	▶ -	-	-	-	-	-	-	-	-	-
40.	▶ -	-	-	-	-	-	-	-	-	-
50.	▶ -	-	-	-	-	-	-	-	-	-
60.	▶ TR.60.20.	30 32 34	6.89	(175)	4.96	(126)	4.96	(126)	4.80	(122)
65.	▶ TR.65.20.	30 32 34	6.89	(175)	4.96	(126)	4.96	(126)	4.80	(122)
70.	▶ TR.70.20.	30 32 34	6.89	(175)	4.96	(126)	4.96	(126)	4.80	(122)
85.	▶ TR.85.20.	30 32 34	6.89	(175)	6.02	(153)	6.10	(155)	5.87	(149)
85. (R 240)	▶ TR.85.240.20.	30 32 34	6.89	(175)	6.02	(153)	6.10	(155)	5.87	(149)
100.	▶ TR.100.20.	30 32 34	6.89	(175)	6.02	(153)	6.10	(155)	5.87	(149)
125.	▶ TR.125.20.	30 32 34	7.09	(180)	7.48	(190)	7.48	(190)	6.89	(175)

Standard clamp for axis 6: Ø (30mm) 1.18"

Part No. with desired diameter for the axis 6 clamp | 30 | 32 | 34 | e.g. TR.100.20.30

Heavy duty connections - With radius support
 TR.60.23.XX to TR.125.23.XX

- With radius support
- For cables with large cross section
- For heavy hydraulic hoses
- Double C-profile for CFX clamps
- igus® chainfix clamps must be ordered separately. Protector with quick-release fastener also available

Heavy duty connections - With radius support - For TRC·TRE·TRCF



TR.60.23.XX to
TR.125.23.XX

ø Index	Part No. with radius support	Clamp diameter ø (mm)	A		B		C		D		E	
			in.	(mm)	in.	(mm)	in.	(mm)	in.	(mm)	in.	(mm)
30.	▶ -	-	-	-	-	-	-	-	-	-	-	-
40.	▶ -	-	-	-	-	-	-	-	-	-	-	-
50.	▶ -	-	-	-	-	-	-	-	-	-	-	-
60.	▶ TR.60.23.	30 32 34	8.23	(209)	4.96	(126)	5.12	(130)	4.80	(122)	1.50	(38)
65.	▶ TR.65.23.	30 32 34	8.43	(214)	4.96	(126)	5.12	(130)	4.80	(122)	1.77	(45)
70.	▶ TR.70.23.	30 32 34	8.43	(214)	4.96	(126)	5.12	(130)	4.80	(122)	1.69	(43)
85.	▶ TR.85.23.	30 32 34	8.74	(222)	6.10	(155)	6.10	(155)	5.87	(149)	1.93	(49)
85. (R 240)	▶ -	-	-	-	-	-	-	-	-	-	-	-
100.	▶ TR.100.23.	30 32 34	9.45	(240)	6.10	(155)	6.10	(155)	5.87	(149)	2.64	(67)
125.	▶ TR.125.23.	30 32 34	9.92	(252)	7.48	(190)	7.48	(190)	6.89	(175)	2.83	(72)

Standard clamp for axis 6: ø (30mm) 1.18"

Part No. with desired diameter for the axis 6 clamp | 30 | 32 | 34 | e.g. TR.100.20.30

Compact connection - **With strain relief**
TR.40.21.01.XX to TR.100.21.01.XX

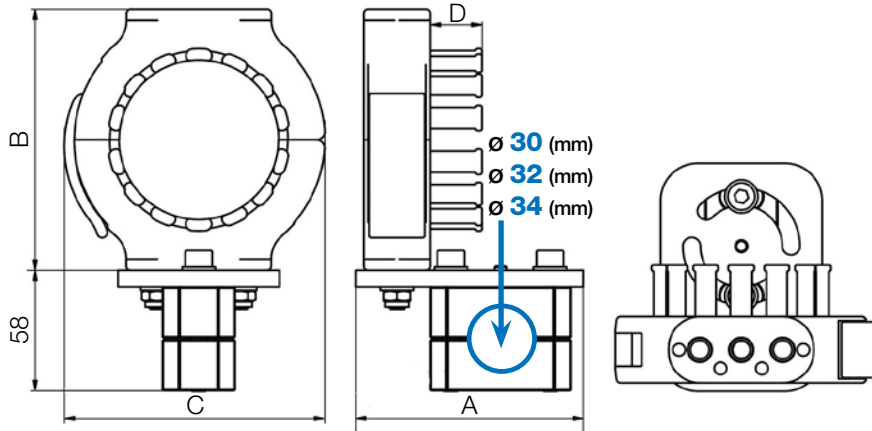

- With integrated strain relief tiwrap plates
- Safe and simple securing of the cables with cable ties
- Various adjustment options

Compact connections - With strain relief - For TRC-TRE-TRCF



TR.40.21.01.XX to
TR.100.21.01.XX

Ø Index	Part No. with strain relief	Clamp diameter Ø (mm)	A		B		C		D	
			in.	(mm)	in.	(mm)	in.	(mm)	in.	(mm)
30.	▶ -	-	-	-	-	-	-	-	-	-
40.	▶ TR.40.21.01.	30 32 34	4.33	(110)	3.35	(85)	3.33	(84.5)	.70	(17.8)
50.	▶ TR.50.21.01.	30 32 34	4.33	(110)	3.35	(85)	3.33	(84.5)	.83	(21)
60.	▶ TR.60.21.01.	30 32 34	4.33	(110)	4.96	(126)	4.96	(126)	.98	(25)
70.	▶ TR.70.21.01.	30 32 34	4.33	(110)	4.96	(126)	4.96	(126)	.98	(25)
85.	▶ TR.85.21.01.	30 32 34	4.33	(110)	6.02	(153)	6.10	(155)	1.50	(38)
85. (R 240)	▶ TR.85.240.21.01.	30 32 34	4.33	(110)	6.02	(153)	6.10	(155)	1.50	(38)
100.	▶ TR.100.21.01.	30 32 34	4.33	(110)	6.02	(153)	6.10	(155)	1.50	(38)
125.	▶ -	-	-	-	-	-	-	-	-	-

Standard clamp for axis 6: Ø (30mm) 1.18"

Part No. with desired diameter for the axis 6 clamp | 30 | 32 | 34 | e.g. TR.100.21.30

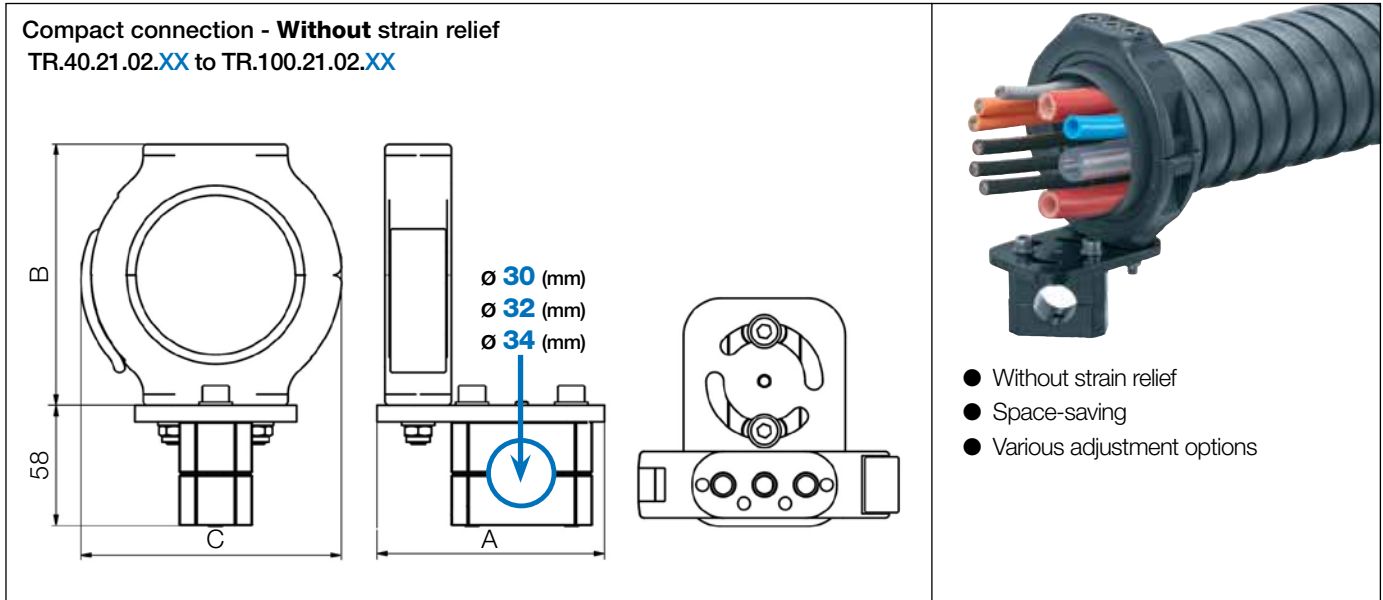

Compact connections - Without strain relief - For TRC-TRE-TRCF



TR.40.21.02.XX to
TR.100.21.02.XX

Ø Index	Part No. without strain relief	Clamp diameter Ø (mm)	A in. (mm)	B in. (mm)	C in. (mm)
30.	▶ -	-	-	-	-
40.	▶ TR.40.21.02.	30 32 34	4.33 (110)	3.35 (85)	3.33 (84.5)
50.	▶ TR.50.21.02.	30 32 34	4.33 (110)	3.35 (85)	3.33 (84.5)
60.	▶ TR.60.21.02.	30 32 34	4.33 (110)	4.96 (126)	4.96 (126)
65.	▶ TR.65.21.02.	30 32 34	4.33 (110)	4.96 (126)	4.96 (126)
70.	▶ TR.70.21.02.	30 32 34	4.33 (110)	6.02 (153)	6.10 (155)
85.	▶ TR.85.21.02.	30 32 34	4.33 (110)	6.02 (153)	6.10 (155)
85. (R 240)	▶ TR.85.240.21.02.	30 32 34	4.33 (110)	6.02 (153)	6.10 (155)
100.	▶ TR.100.21.02.	30 32 34	9.45 (240)	6.10 (155)	6.10 (155)
125.	▶ -	-	-	-	-

Standard clamp for axis 6: Ø (30mm) 1.18"

Part No. with desired diameter for the axis 6 clamp | 30 | 32 | 34 | e.g. TR.100.21.02.30

Quick exchange kit
TR.60.22.XX to TR.100.22.XX

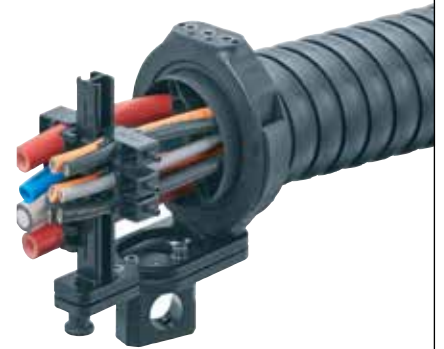
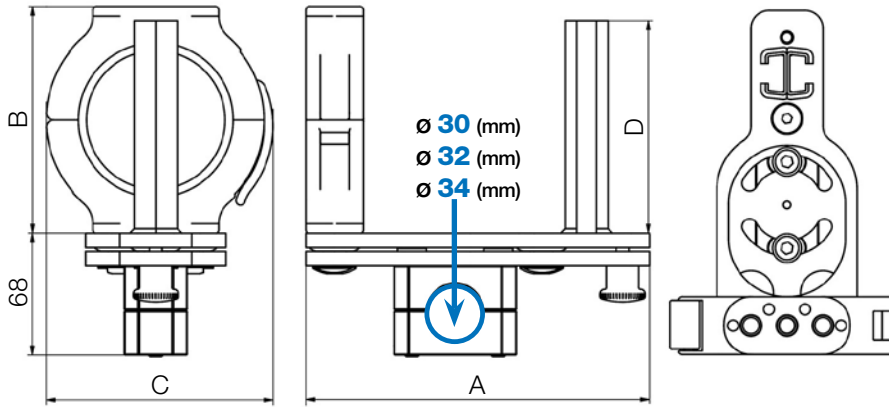

- Exchange in seconds
- No repeat alignment required
- Exchange the triflex® R unit incl. cables without tools
- Option available with strain relief

Quick exchange kit - For TRC-TRE-TRCF

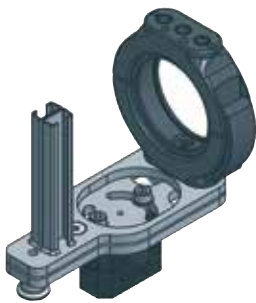

TR.60.22.XX to
TR.100.22.XX

Ø Index	Part No. quick change unit	Clamp diameter Ø (mm)	A		B		C		D	
			in.	(mm)	in.	(mm)	in.	(mm)	in.	(mm)
30.	▶ -	-	-	-	-	-	-	-	-	-
40.	▶ -	-	-	-	-	-	-	-	-	-
50.	▶ -	-	-	-	-	-	-	-	-	-
60.	▶ TR.60.22.	30 32 34	7.52	(191)	4.96	(126)	4.96	(126)	4.96	(126)
65.	▶ TR.65.22.	30 32 34	7.52	(191)	4.96	(126)	4.96	(126)	4.96	(126)
70.	▶ TR.70.22.	30 32 34	7.52	(191)	4.96	(126)	4.96	(126)	4.96	(126)
85.	▶ TR.85.22.	30 32 34	7.52	(191)	6.02	(153)	6.10	(155)	6.02	(153)
85. (R 240)	▶ TR.85.240.22.	30 32 34	7.52	(191)	6.02	(153)	6.10	(155)	6.02	(153)
100.	▶ TR.100.22.	30 32 34	7.52	(191)	6.02	(153)	6.10	(155)	6.02	(153)
125.	▶ -	-	-	-	-	-	-	-	-	-

Standard clamp for axis 6: Ø (30mm) 1.18"

Part No. with desired diameter for the axis 6 clamp | 30 | 32 | 34 | e.g. TR.100.22-30

chainfix - Single clamp including bottom saddles

- For use with heavy-duty connection
TR.XX.20 / TR.XX.23 and quick release unit **TR.XX.22**
- Reliably absorbs tensile forces even for larger cable diameters
- Specifically recommended for solid welding cables and rigid hydraulic hoses
- Space- and time-saving assembly onto the profile rail
- Simple assembly with hex head set screw
- High strength for dynamic applications with improved stacker elements
- Built-in ribs on the stacker elements give secure grip on the cables
- Steel (material galvanized steel) or stainless steel (material 1.4301/AISI 304) available



Part No. steel	Part No. stainless steel*	≤ Ø		B*2		H	
		in.	(mm)	in.	(mm)	in.	(mm)
CFX12-1	CFX12-1-E	.24 - .47	06 - 12	.63	16	1.57	40
CFX14-1	CFX14-1-E	.47 - .55	12 - 14	.71	18	1.97	50
CFX16-1	CFX16-1-E	.55 - .63	14 - 16	.79	20	2.05	52
CFX18-1	CFX18-1-E	.63 - .71	16 - 18	.87	22	2.13	54
CFX20-1	CFX20-1-E	.71 - .79	18 - 20	.94	24	2.20	56
CFX22-1	CFX22-1-E	.79 - .87	20 - 22	1.02	26	2.28	58
CFX26-1	CFX26-1-E	.87 - 1.02	22 - 26	1.18	30	2.64	67
CFX30-1	CFX30-1-E	1.02 - 1.18	26 - 30	1.34	34	2.80	71
CFX34-1	CFX34-1-E	1.18 - 1.34	30 - 34	1.50	38	2.95	75

*Stainless steel material: 1.4301/AISI 304

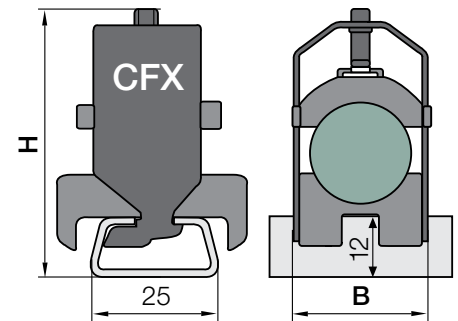

Individual strain relief for every cable offers security and easy replacement



Cable management systems for Cobots

Secure mounting brackets combined with superior triflex® cable management for all collaborative robots

Now, you can quickly attach or retrofit your cobot's cable management system in just a few simple steps using our plastic mounting brackets with hook and loop attachment straps. The adjustable straps fit around virtually any cobot manufacturer's arm. Each kit includes a length of triflex® R TRE cable carrier, designed for superior cable management and protection. The triflex® R TRE is designed with two easy access chambers to keep cables protected and features high tensile strength due to the ball-and-socket design. The triflex® R TRE has a small bend radius and short pitch as well as a defined torsion stop which allows for multi-axis movement in any direction.

Benefits:

- For various robot arm diameters, universal applications
- Compact, smooth design
- Silicone-free, suitable for the automotive industry
- Assembled and retrofitted in just a few steps
- Low-cost addition to cobot accessories product range



Cobot kit with hook and loop brackets



TR.COB.VEL.30 / TR.COB.VEL.40

Cost-effective mounting with hook-and-loop on both the robot and the cable carrier sides

Included in the kit:

- 1 triflex® cable carrier (approx. 6 ft.)
- 4 one-meter hook-and-loop lengths
- 4 Plastic bases
- 1 strain relief bracket
- 1 set of lock clips
- 1 set of screws
- 1 triflex® assembly tool



Cobot kit with light plastic brackets



TR.COB.LT.30 / TR.COB.LT.40

Lightweight plastic brackets for securing the cable carrier

Included in the kit:

- 1 triflex® cable carrier (approx. 6 ft.)
- 4 one-meter hook-and-loop lengths
- 4 Plastic bases
- 4 light brackets (screws included)
- 1 strain relief bracket
- 1 set of lock clips
- 1 triflex® assembly tool



Cobot kit with protected plastic brackets brackets



TR.COB.PRO.40



Plastic brackets with rounded edges for increased safety

Included in the kit:

- 1 triflex® cable carrier (approx. 6 ft.)
- 4 one-meter hook-and-loop lengths
- 4 Plastic bases
- 4 protector brackets (screws included)
- 1 strain relief bracket
- 1 set of lock clips
- 1 triflex® assembly tool



Cobot kit accessories

Part. No.	Description	Availability		
		30mm	40mm	50mm
TR.COB.01.00.0	 Plastic Base with hook and loop adjustable strap	●	●	●
TR.COB.LT.30	 Plastic Base with hook and loop adjustable strap and light mounting bracket	●	—	—
TR.COB.LT.40		—	●	—
TR.COB.PRO.40	 Plastic Base with hook and loop adjustable strap and protector bracket	—	●	—

Universal robot kits with metal clamp brackets

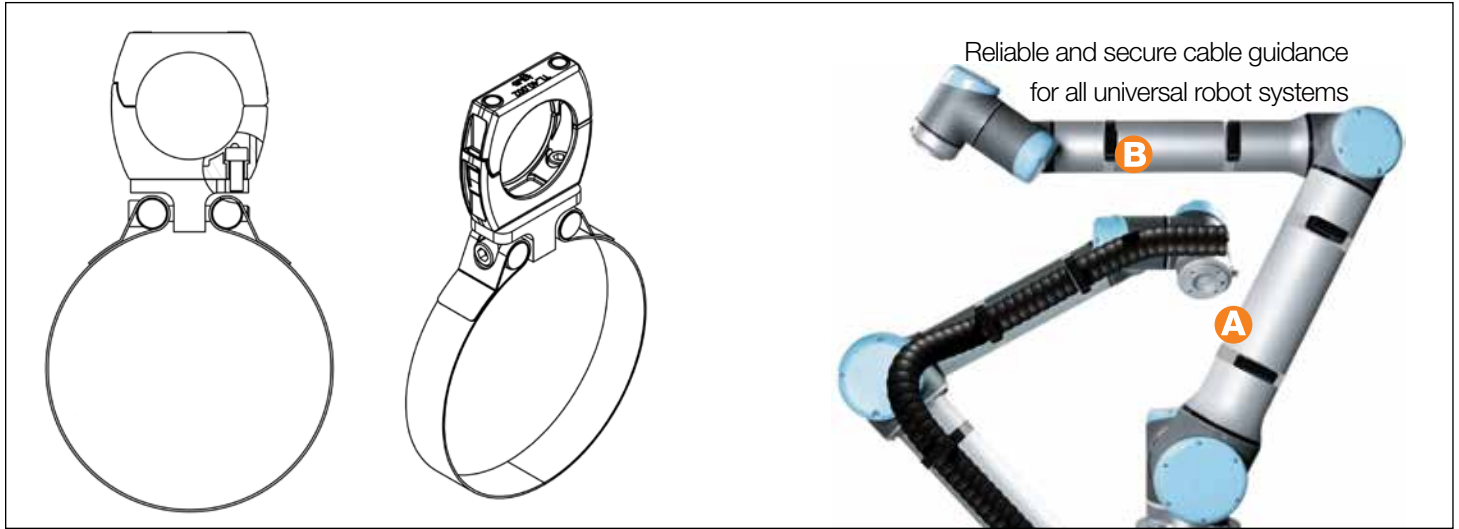

Universal Robot Kits using igus® metal brackets

igus part number	For UR-robot system	Triflex size
TR.UR3.TRE.30	UR3/UR3e	TRE.30
TR.UR3.TRE.40B	UR3/UR3e	TRE.40B
TR.UR3.TRC.30	UR3/UR3e	TRC.30
TR.UR3.TRC.40	UR3/UR3e	TRC.40
TR.UR5.TRE.30	UR5/UR5e	TRE.30
TR.UR5.TRE.40B	UR5/UR5e	TRE.40B

igus part number	For UR-robot system	Triflex size
TR.UR5.TRC.30	UR5/UR5e	TRC.30
TR.UR5.TRC.40	UR5/UR5e	TRC.40
TR.UR10.TRE.30	UR10/UR10e/UR16e	TRE.30
TR.UR10.TRE.40B	UR10/UR10e/UR16e	TRE.40B
TR.UR10.TRC.30	UR10/UR10e/UR16e	TRC.30
TR.UR10.TRC.40	UR10/UR10e/UR16e	TRC.40

Metal brackets - suitable for TRC-30 / TRE-30 / TRL-30 e-chains®

Part No. without strain relief	Part No. with strain relief	For UR-robot system	∅		Position
			in.	(mm)	
TR.911.965.054.Z0	TR.911.965.054.Z1	UR3/UR3e	2.13	(054)	B
TR.911.965.066.Z0	TR.911.965.066.Z1	UR3/UR3e	2.60	(066)	A
TR.911.965.075.Z0	TR.911.965.075.Z1	UR5/UR5e	2.95	(075)	B
TR.911.965.086.Z0	TR.911.965.086.Z1	UR5/UR5e	3.39	(086)	A
TR.911.965.086.Z0	TR.911.965.086.Z1	UR10/UR10e/UR16e	3.39	(086)	B
TR.911.965.108.Z0	TR.911.965.108.Z1	UR10/UR10e/UR16e	4.25	(108)	A

Metal brackets - suitable for TRC-40 / TRE-40 / TRL-40 e-chains®

Part No. without strain relief	Part No. with strain relief	For UR-robot system	∅		Position
			in.	(mm)	
TR.911.966.054.Z0	TR.911.966.054.Z1	UR3/UR3e	2.13	(054)	B
TR.911.966.066.Z0	TR.911.966.066.Z1	UR3/UR3e	2.60	(066)	A
TR.911.966.075.Z0	TR.911.966.075.Z1	UR5/UR5e	2.95	(075)	B
TR.911.966.086.Z0	TR.911.966.086.Z1	UR5/UR5e	3.39	(086)	A
TR.911.966.086.Z0	TR.911.966.086.Z1	UR10/UR10e/UR16e	3.39	(086)	B
TR.911.966.108.Z0	TR.911.966.108.Z1	UR10/UR10e/UR16e	4.25	(108)	A

Standard protective jacket



- Base support: fabric
- Plastic coated
- Easy to replace with Velcro fastenings
- Elastic sealing strips
- Standard lengths available from stock
- For paint or sealing applications
- PVC material
- Polyester coated fabrics

Heat shield protective jacket



- Made from heat resistant, wear-resistant Kevlar
- Short-term protection against welding and metal spatter, temperatures up to 540°C
- High abrasion resistance
- Sealed design
- For tough environments
- Easy to replace or retrofit with zipper closure
- Velcro straps at each end
- Tough design Silicone-free
- Asbestos-free
- Standard lengths from stock

Wear resistant protective jacket



- Extremely high abrasion resistance
- Black leather
- For use in temperatures from -40°F to +212°F (-40°C to +100°C)
- Very Flexible
- Easy to exchange or retrofit
- Silicone-free
- Asbestos-free
- Standard lengths from stock

ø Index	Part No. jacket	Standard lengths ²⁾ XXXX (mm)
30.	▶ -	-
40.	▶ TR.40.14.	500 1000 1500 2000
50.	▶ TR.50.14.	500 1000 1500 2000
60.	▶ TR.60.14.	500 1000 1500 2000
65.	▶ TR.65.14.	500 1000 1500 2000
70.	▶ TR.70.14.	500 1000 1500 2000
85.	▶ TR.85.14.	500 1000 1500 2000
100.	▶ TR.100.14.	500 1000 1500 2000
125.	▶ TR.125.14.	500 1000 1500 2000

2) Special lengths upon request

Part No. with the desired standard value for the length **XXXX**

Example: TR.60.14.**500**

ø Index	Part No. jacket	Standard lengths ²⁾ XXXX (mm)
30.	▶ -	-
40.	▶ TR.40.18.	500 1000 1500 2000
50.	▶ TR.50.18.	500 1000 1500 2000
60.	▶ TR.60.18.	500 1000 1500 2000
65.	▶ TR.65.18.	500 1000 1500 2000
70.	▶ TR.70.18.	500 1000 1500 2000
85.	▶ TR.85.18.	500 1000 1500 2000
100.	▶ TR.100.18.	500 1000 1500 2000
125.	▶ TR.125.18.	500 1000 1500 2000

2) Special lengths upon request

Part No. with the desired standard value for the length **XXXX**

Example: TR.60.18.**500**

ø Index	Part No. jacket	Standard lengths ²⁾ XXXX (mm)
30.	▶ -	-
40.	▶ TR.40.19.	500 1000 1500 2000
50.	▶ TR.50.19.	500 1000 1500 2000
60.	▶ TR.60.19.	500 1000 1500 2000
65.	▶ TR.65.19.	500 1000 1500 2000
70.	▶ TR.70.19.	500 1000 1500 2000
85.	▶ TR.85.19.	500 1000 1500 2000
100.	▶ TR.100.19.	500 1000 1500 2000
125.	▶ TR.125.19.	500 1000 1500 2000

2) Special lengths upon request

Part No. with the desired standard value for the length **XXXX**

Example: TR.60.19.**500**

triflex® R interior separation - configure e-chains® easily

Quick and easy creation of interior separation layouts for triflex® R. After selecting the cables, they can be dragged & dropped into the e-chain® layout. The interior separation configurator creates a parts list of the e-chain® and the cables contained in the configuration. The configurations can be saved and reloaded. The entire configuration can be transferred to the shopping cart with a click.

- Quick and easy interior separation configurator
- Accounts for maximum filling rules for cables and hoses
- Creation of parts lists
- Easy inquiry and ordering

More information and interior separation configurator

► www.igus.com/triflexR-IA

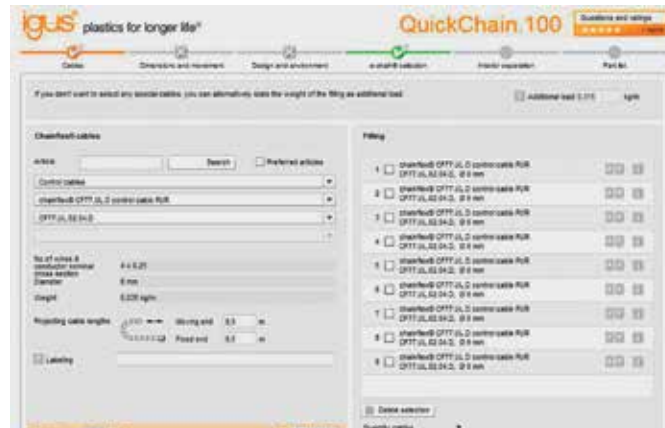

1. Select cables, hoses and lengths



2. Select e-chain® and size

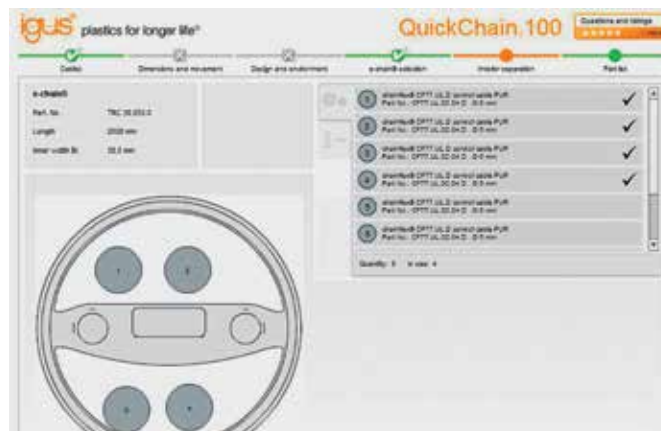

3. Fill the e-chain® with cables and hoses

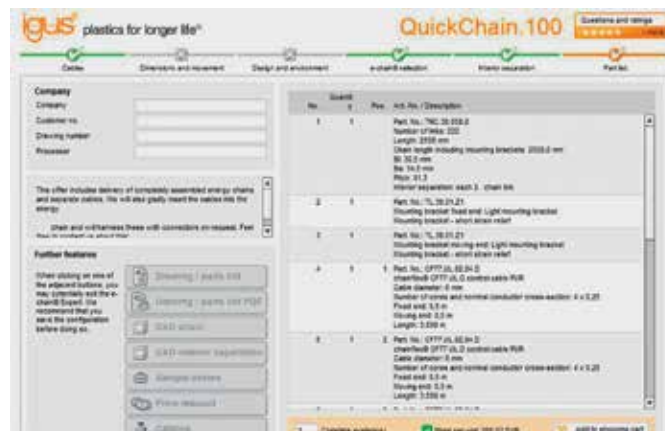

4. Result: parts list, price and drawings

triflex® R - readychain® dress-packs

Customized system consisting of the triflex® R, chainflex® and connectors

- Eliminate storage costs for cables, e-chains® and plugs
- Shorten turnaround times by half, minimize your machine downtime
- Reduce the number of suppliers and orders by 75%

More information ► www.igus.com/readychain





RSE linear
retraction system

⊕ Advantages:

- Special linear guide avoids small bend radii
- Simple, linear retraction without loops, fiber-rods or guide rollers
- Up to 19.29" (490mm) retraction length possible
- Space-saving
- Maintenance-free igus® drylin® W linear unit
- For series TRC·TRE·TRCF* with \varnothing -index 1.57-3.94" (40-100mm)

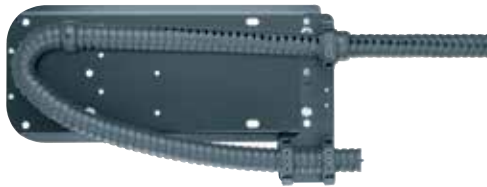

RS modular
retraction system

⊕ Advantages:

- For use with adverse environmental influences
- Retraction force provided by integrated fiber-rods
- For robots with a load capacity from approximately 22.05 lbs (10kg)
- Up to 26.38" (670mm) retraction length possible
- If a linear guide system is not needed
- For series TRC·TRE with \varnothing -index 1.57-3.94" (40-100mm)

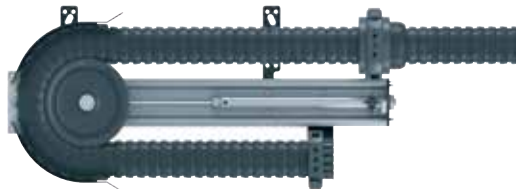

RSP pneumatic
retraction system

⊕ Advantages:

- Standard pneumatic components
- Sensor based monitoring possible
- For applications with a high fill weight
- Constant force over the complete travel
- For robots with a load capacity from approximately 110.2 lbs (50kg)
- Up to 30.71" (780mm) retraction length possible
- For series TRC·TRE·TRCF with a \varnothing -index of 2.36-4.92" (60-125mm)

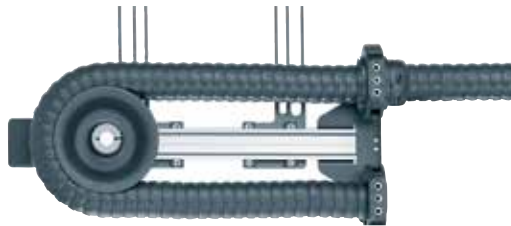

RSE wheel
retraction system

⊕ Advantages:

- For small robots, very light
- Up to 19.69" (500mm) retraction length possible
- For highly dynamic movements
- Cost-effective
- Maintenance-free igus® drylin® W linear unit
- For series TRC·TRE with \varnothing -index 1.57-1.97" (40-50mm)



RSEL linear,
retraction system

⊕ Advantages:

- Linear guidance even for highly dynamic applications
- For robots with high and medium payloads
- Up to 14.96" (380mm) retraction length possible
- Cost-effective
- For series TRC·TRE·TRCF with a \varnothing -index of 2.76-3.35" (70-85mm)

Choosing the right e-chain® size and retraction system

If you want to select a suitable retraction system yourself, please ensure that you observe the maximum cable diameter and usage data.

1

The largest cable diameter \varnothing ...

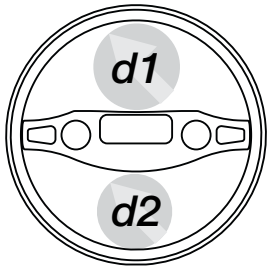

2

... and max. usable e-chain® cross section area ...

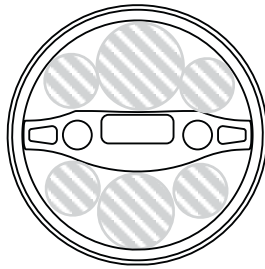

3

... determine the necessary \varnothing index of the triflex® R ...

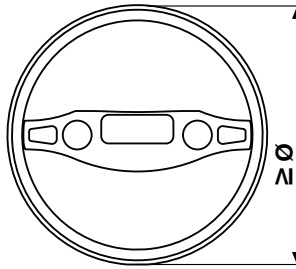

4

... select from 4 retraction systems options:

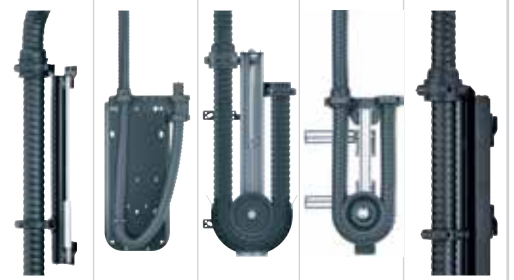

Max. cable \varnothing				Coverage of the entire area		Minimum \varnothing -index triflex® R	Retraction system				
1. chamber d1		2. chamber d2		in ²	(mm ²)		RSE linear	RS	RSP	RSE wheel	RSEL linear
in.	(mm)	in.	(mm)								
-	-	-	-		-	30-	-	-	-	-	-
< 0.59	< 15	< 0.51	< 13	< 0.775	< 500	40-	●	●	-	●	-
< 0.74	< 18.8	< 0.64	< 16.2	< 1.163	< 750	50-	●	-	-	●	-
< 0.89	< 22.5	< 0.77	< 19.5	< 1.550	< 1000	60-	●	●	●	-	-
< 0.88	< 22.3	< 0.88	< 22.3	< 61.5	< 1562	65-	●	-	●	-	-
< 1.10	< 28	< 0.94	< 24	< 2.713	< 1750	70-	●	●	●	-	●
< 1.30	< 33	< 1.10	< 28	< 3.875	< 2500	85-	●	●	●	-	●
< 1.48	< 37.5	< 1.28	< 32.5	< 4.650	< 3000	100-	●	●	●	-	-
< 1.69	< 43	< 1.69	< 43	< 6.975	< 4500	125-	-	-	●	-	-

● Available - Not Available



Interior separation configurator - quick and easy creation of interior layouts for triflex® R.
More information ► www.igus.com/triflexR-IA

Selection tool for triflex® R retraction systems

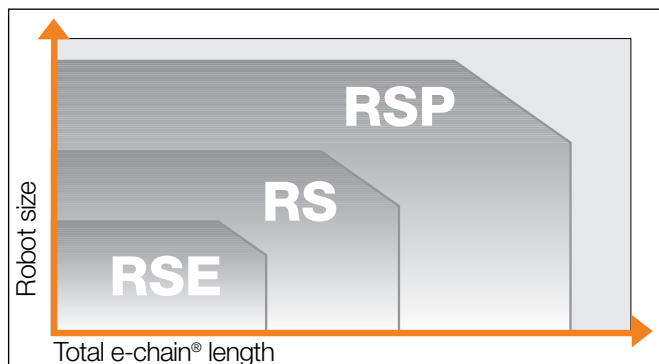

For series	RSE linear \varnothing Index	RS \varnothing Index	RSP \varnothing Index	RSE Wheel \varnothing Index	RSEL linear \varnothing Index
TRC	40 - 100	40 - 100	60 - 125	40 - 50	70 - 85
TRE	40 - 100	40 - 100	60 - 125	40 - 50	70 - 85
TRCF	65 - 100	-	65 - 100	-	-
TRL*	-	-	-	-	-
TRLF*	-	-	-	-	-

* Retraction systems not available for this series

Up to 19.29" (490mm) retraction length possible with triflex® RSE

For TRC-TRE-TRCF series with a Ø index of 1.57 - 4.92" (40-125mm)

Simple, linear retraction without loops, fiber-rods or guide rollers

Special linear guide avoids small bend radii

Maintenance-free igus® drylin® W linear unit

Custom connection possibilities using adapter consoles

Compact design, no loops

Cost-effective

triflex® RSE linear retraction system

The more complex the automated production technology, the greater the requirements placed on the energy supply system. It is increasingly the case that not only electric power and fluids have to be supplied to production robots; but also laser cables and supply hoses for rivets, pins and screws. As these often cannot function with small bend radii, the new triflex® RSE relies on very easy linear retraction without loops and spring rods or deflection rollers. The purpose of the triflex® RSE retraction system is to hold the e-chain® as closely as possible to the robot arm in order to prevent the e-chain® from intruding upon or blocking the robot's movements.

- Simple, linear retraction without bends, fiber-rods or guide rollers
- For series TRC-TRE-TRCF with a \varnothing -index of 1.57 - 4.92" (40-125mm)
- Special linear guide avoids small bend radii
- Up to 19.29" (490mm) retraction length possible
- Cost-effective
- Maintenance-free igus® drylin® W linear unit

Optional accessories - RSE linear, cost-effective linear retraction system



Adapter brackets for customized mounting options



Clamps - axis 6 - for triflex® R mounting bracket



igus® TR.RSE system on test robot



Lightweight, linear retraction system for small robots in sizes 40 and 50



Linear TR.RSE retraction system for sizes 2.36 - 3.94" (60-100) with attachment brackets for a wide variety of robot models

Dimensions - RSE linear retraction system

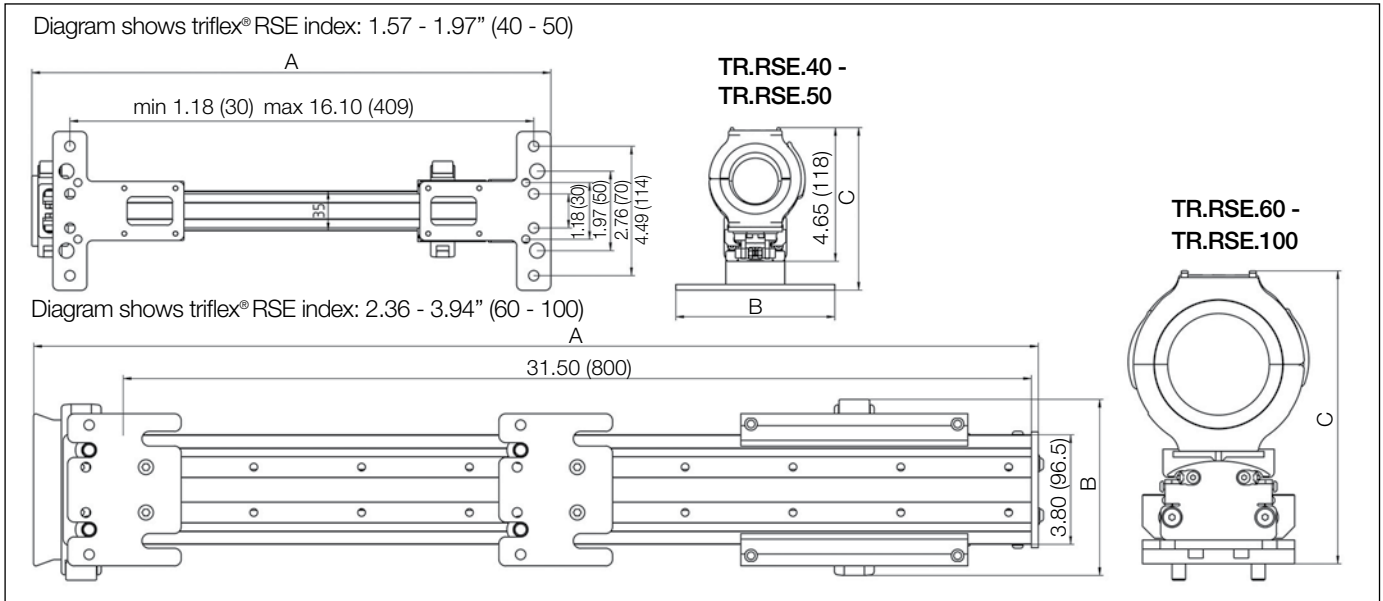

Possible installation positions for TR.RS.60 - TR.RS.100 | RSE linear

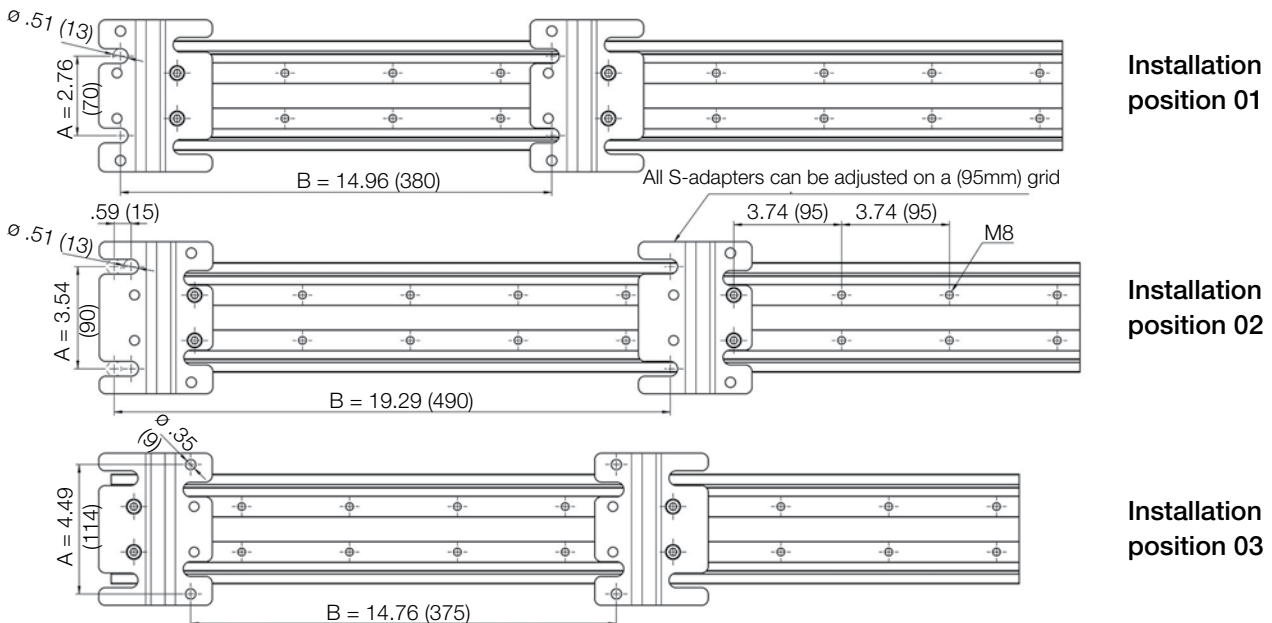

Installation position 01

A	B	Thread size
in. (mm)	in. (mm)	
2.76 (70)	7.48 (190)	M12
2.76 (70)	11.22 (285)	M12
2.76 (70)	14.96 (380)	M12
2.76 (70)	18.70 (475)	M12
2.76 (70)	22.44 (570)	M12
2.76 (70)	26.18 (665)	M12
2.76 (70)	29.92 (760)	M12

Installation position 02

A	B	Thread size
in. (mm)	in. (mm)	
3.54 (90)	6.89 - 8.07 (175 - 205)	M12
3.54 (90)	10.63 - 11.81 (270 - 300)	M12
3.54 (90)	14.37 - 15.55 (365 - 395)	M12
3.54 (90)	18.11 - 19.29 (460 - 490)	M12
3.54 (90)	21.85 - 23.03 (555 - 585)	M12
3.54 (90)	25.59 - 26.77 (650 - 680)	M12
3.54 (90)	29.33 - 30.51 (745 - 775)	M12

Installation position 03

A	B	Thread size
in. (mm)	in. (mm)	
4.49 (114)	7.28 (185)	M8
4.49 (114)	11.02 (280)	M8
4.49 (114)	14.76 (375)	M8
4.49 (114)	18.50 (470)	M8
4.49 (114)	22.24 (565)	M8
4.49 (114)	25.98 (660)	M8

Ø Index	Part No. RSE linear	Retraction length ¹⁾		A		B		C		Weight		Part No. RSE support
		≤ in.	≤ (mm)	in.	(mm)	in.	(mm)	in.	(mm)	lb	(kg)	
30.	-	-	-	-	-	-	-	-	-	-	-	-
40.	▶ TR.RSE.40	11.42	(290)	17.99	(457)	5.51	(140)	5.63	(143)	3.09	(1.4)	-
50.	▶ TR.RSE.50	11.42	(290)	18.70	(475)	5.51	(140)	5.94	(151)	3.75	(1.7)	-
60.	▶ TR.RSE.60	19.29	(490)	34.17	(868)	5.28	(134)	9.09	(231)	21.83	(9.9)	TR.914.973.60
65.	▶ TR.RSE.65	19.29	(490)	34.65	(880)	5.28	(134)	9.09	(231)	22.04	(10.0)	TR.914.973.65
70.	▶ TR.RSE.70	19.29	(490)	34.57	(878)	6.10	(155)	1.02	(258)	22.04	(10.0)	TR.914.973.70
85.	▶ TR.RSE.85	19.29	(490)	34.84	(885)	6.10	(155)	1.02	(258)	22.04	(10.0)	TR.914.973.85
85. (R 240)	▶ TR.RSE.85.240	19.29	(490)	34.84	(885)	6.10	(155)	1.02	(258)	22.04	(10.0)	-
100.	▶ TR.RSE.100	19.29	(490)	34.88	(886)	6.69	(170)	1.04	(264)	22.49	(10.2)	TR.914.973.100

1) These are the maximum values. In normal operation a filling of no more than 70% is advised.

Please order matching triflex® R e-chain® separately. Optional RSE support must be ordered separately.

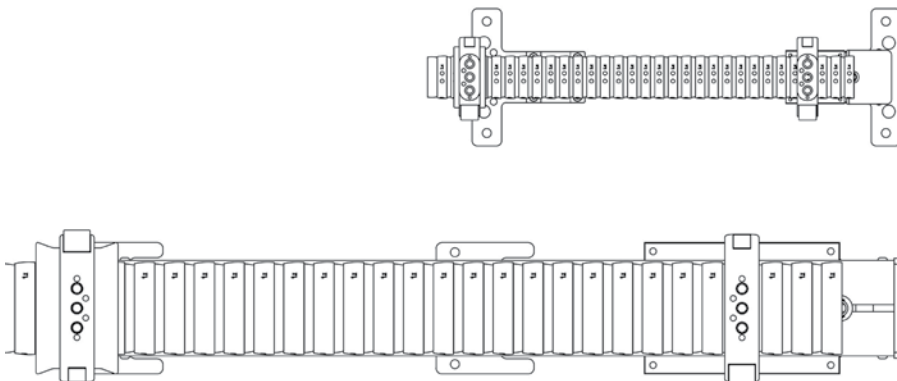
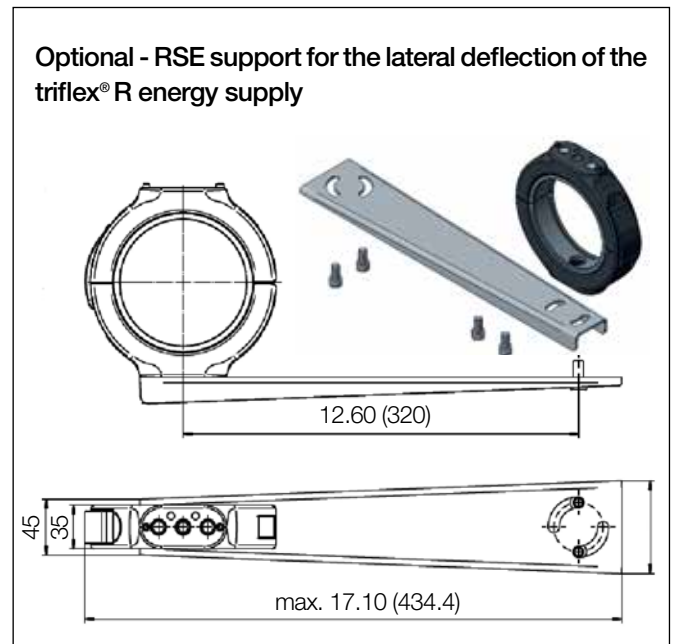
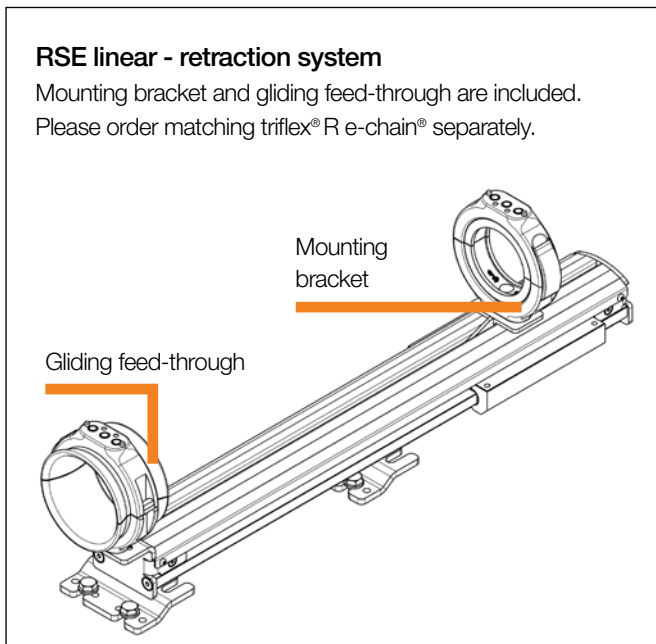

Order key

TR.RSE.XX



System design | RSE linear and matching e-chain®

Matching triflex® R e-chain® for RSE linear

TRC .XX.R.0
TRE .XX.R.0.B
TRCF.XX.R.0



Excess length in direction **A1** +
Dimension **A** +
Excess length in direction **A6** =
Total e-chain® length

Limit protector

RSE linear system
(without e-chain®) +
Mounting bracket +
Gliding feed-through =
TR.RSE.XX

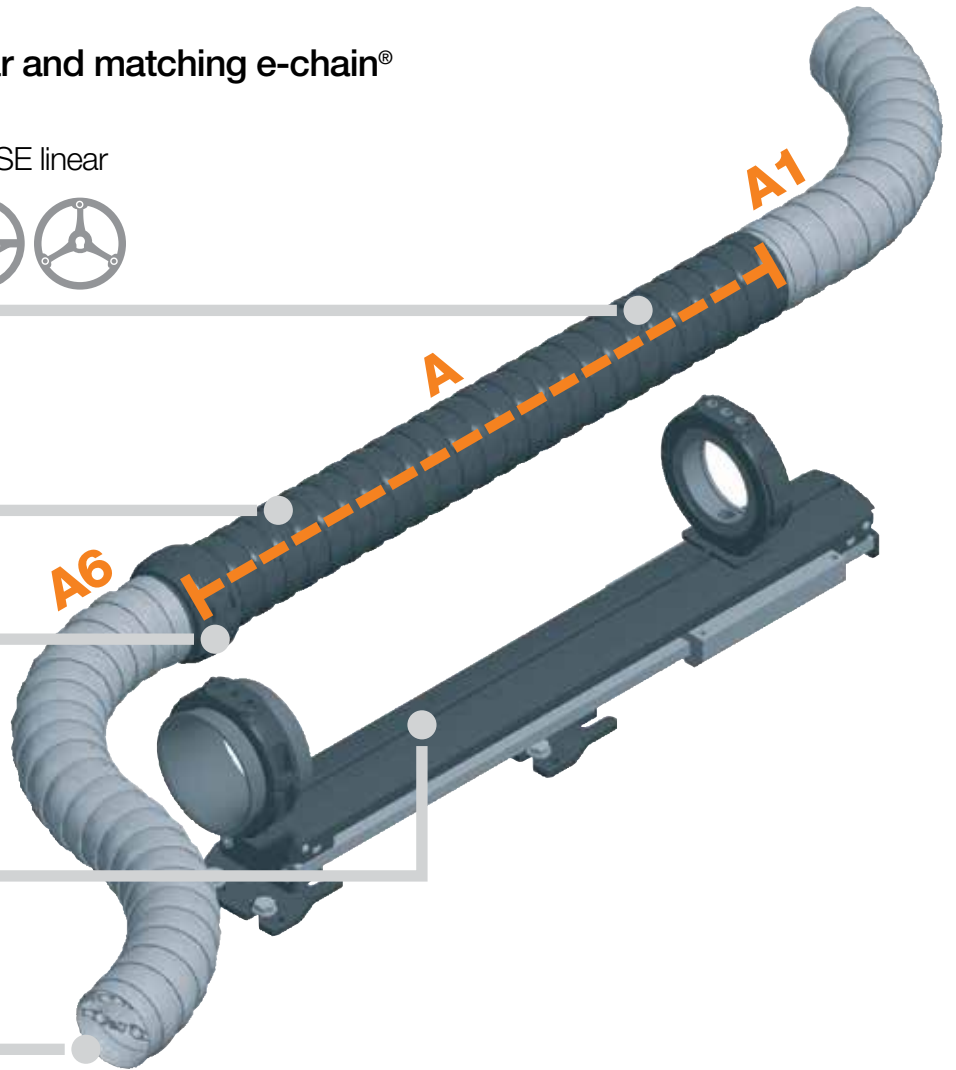

IMPORTANT - Ball end of triflex® must run in direction of the end of arm tool



Sample order of a complete TR.RSE linear system,
Ø index 1.57" (40), and e-chain® length: 6.56" (2 m)

System	Insert Ø index XX	TR.RSE.XX
+ e-chain®	Insert Ø index XX / Insert bend radius R / Insert standard length LLLL in meters	2 m TRC.XX.R.0
+ protector	Protector with quick-lock fastener	TR.XX.30
Order text:	TR.RSE.40. + 2 m TRC.40.058.0 + TR.40.30	



Order key e-chains®

TRC .XX.R.0
TRE .XX.R.0.B
TRCF .XX.R.0



Product range - Matching e-chains® and protectors for RSE linear

∅ Index	Part No. TRC enclosed	Part No. TRE "easy" design	Part No. TRCF with snap lock mechanism	Protector with screw fastener	Protector with quick-lock fastener
30.	▶ -	-	-	-	-
40.	▶ TRC.40.058.0	TRE.40.058.0.B	-	TR.40.10	TR.40.30
50.	▶ TRC.50.080.0	TRE.50.080.0.B	-	TR.50.10	-
60.	▶ TRC.60.087.0	TRE.60.087.0.B	-	TR.60.10	TR.60.30
65.	▶ -	-	TRCF.65.100.0	TR.65.10	-
70.	▶ TRC.70.110.0	TRE.70.110.B	-	TR.70.10	TR.70.30
85.	▶ TRC.85.135.0	TRE.85.135.B	TRCF.85.135.0	TR.85.10	TR.85.30
85. (R 240)	▶ -	-	TRCF.85.240.0	TR.85.240.10	-
100.	▶ TRC.100.145.0	TRE.100.145.0.B/C ¹⁾	TRCF.100.145.0	TR.100.10	TR.100.30

1) Available for B- and C-versions

Please order e-chains® as piece parts and purchase a protector for each one.

Please order protectors with screw connections or quick release as limit protectors.

To calculate the total chain length, add the desired excess length from axis 1 and axis 6 to dimension A (lower table). Additionally, at least 1 limit protector must be ordered. Please note that all triflex® R e-chains can be lengthened and shortened individually and can be customized to meet the needs of your application.

Calculating the overall chain length - RSE linear e-chains®

∅ Index	Bend radius <i>R</i>		A	
	in.	(mm)	in.	[mm]
30.	▶ -	-	-	-
40.	▶ 2.28	058	15.35	390
50.	▶ 3.15	080	15.35	390
60.	▶ 3.43	087	29.53	750
65.	▶ 3.94	100	29.53	750
70.	▶ 4.33	110	29.53	750
85.	▶ 5.31	135	29.53	750
85. (R 240)	▶ 9.45	240	29.53	750
100.	▶ 5.71	145	29.53	750
125.	▶ 7.17	182	29.53	750

Excess length in direction **A6** + Dimension **A** +
 excess length in direction **A1** = total chain length

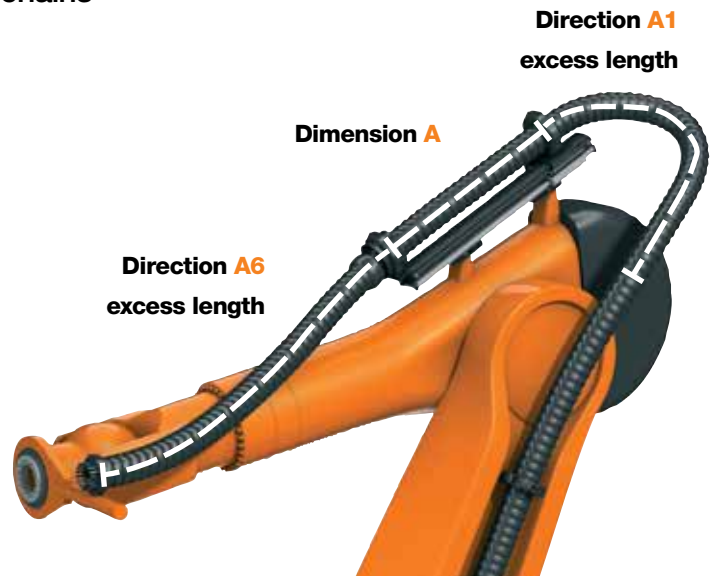

triflex® R length calculation for RSE linear

Up to 26.38" (670mm) retraction length possible with triflex® RS

Gliding feed-through for close parallel guidance to the robotic arm

Mounting brackets for secure fastening

For TRC and TRE (matching e-chains® must be ordered separately)

Single module, space-saving and quickly mounted on robot

End stop for a defined yet free movement

Retraction force provided by integrated fiber-rods

triflex® RS Modular retraction system

triflex® RS is a retraction system for robots with medium and high load-bearing capacity. The triflex® RS is used as a space-saving guide for the multi-dimensionally moving triflex® R in parallel to the robot arm. Integrated fiber rods generate a directed camber to prevent undesirable loops from forming in the working space of the robot. This permits applications with very tight installation space to be realized as well. triflex® RS provides the option to reliably implement the energy supply system to the tool, without placing stress on the cable, therefore making a key contribution to minimizing downtimes.

- Saves space - low interfering contours, closely routed on the robotic arm
- System solution tested by the tens of thousands
- Universally applicable
- Integrated fiber rods - no external mechanical components such as springs or steel wires needed!

Optional accessories - RS modular retraction system



Cover - for additional installation space and extreme motions



Adjustment unit - accurate adjustment of the assembly position



Adapter brackets for customized mounting options



Clamps - axis 6 - for triflex® R mounting bracket

triflex® R - RS - Application example
For Series TRC / TRE
RS - R(etraction) S(ystem)



triflex® RS for a lean chain guide. The triflex® RS is used as a space-saving guide for the multi-dimensionally moving triflex® R in parallel to the robot arm.
Video at ► www.igus.com/triflexR



Optional: triflex® RS with cover - creates additional installation space on the robot

Installation height - RS modular retraction system

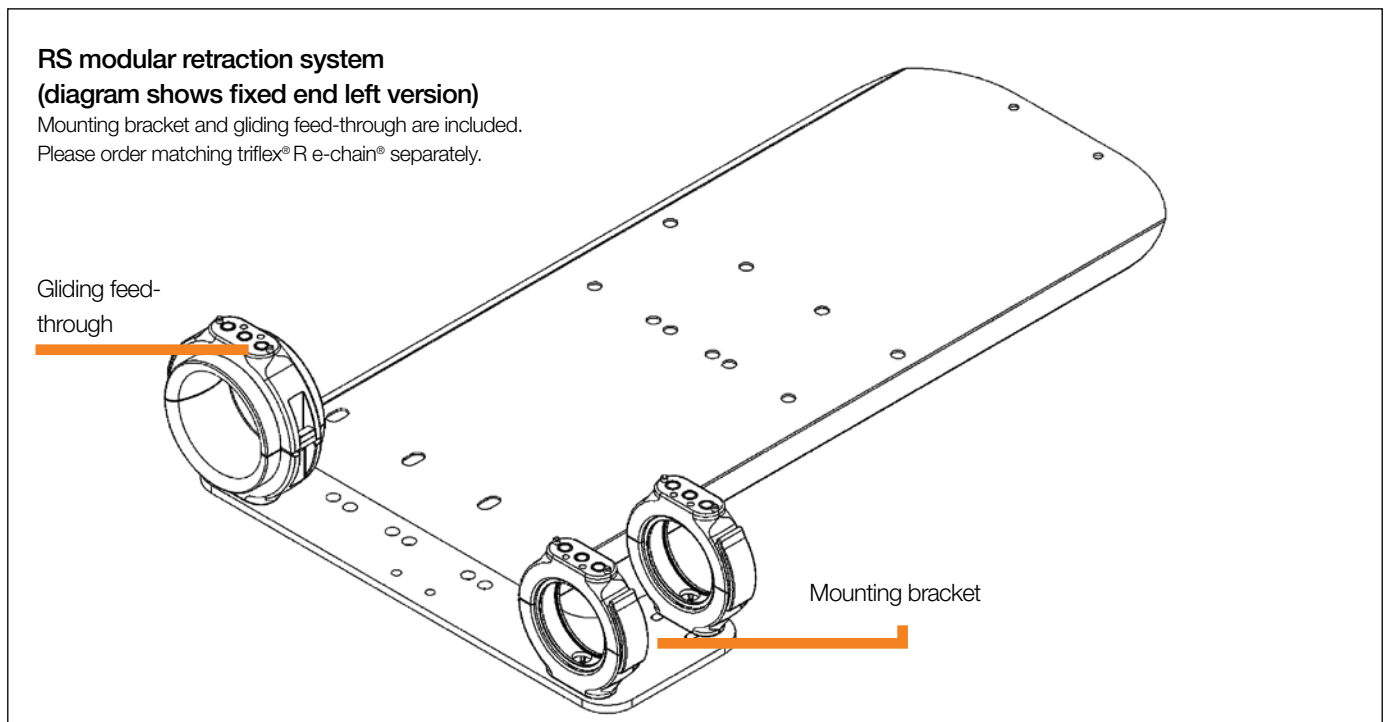
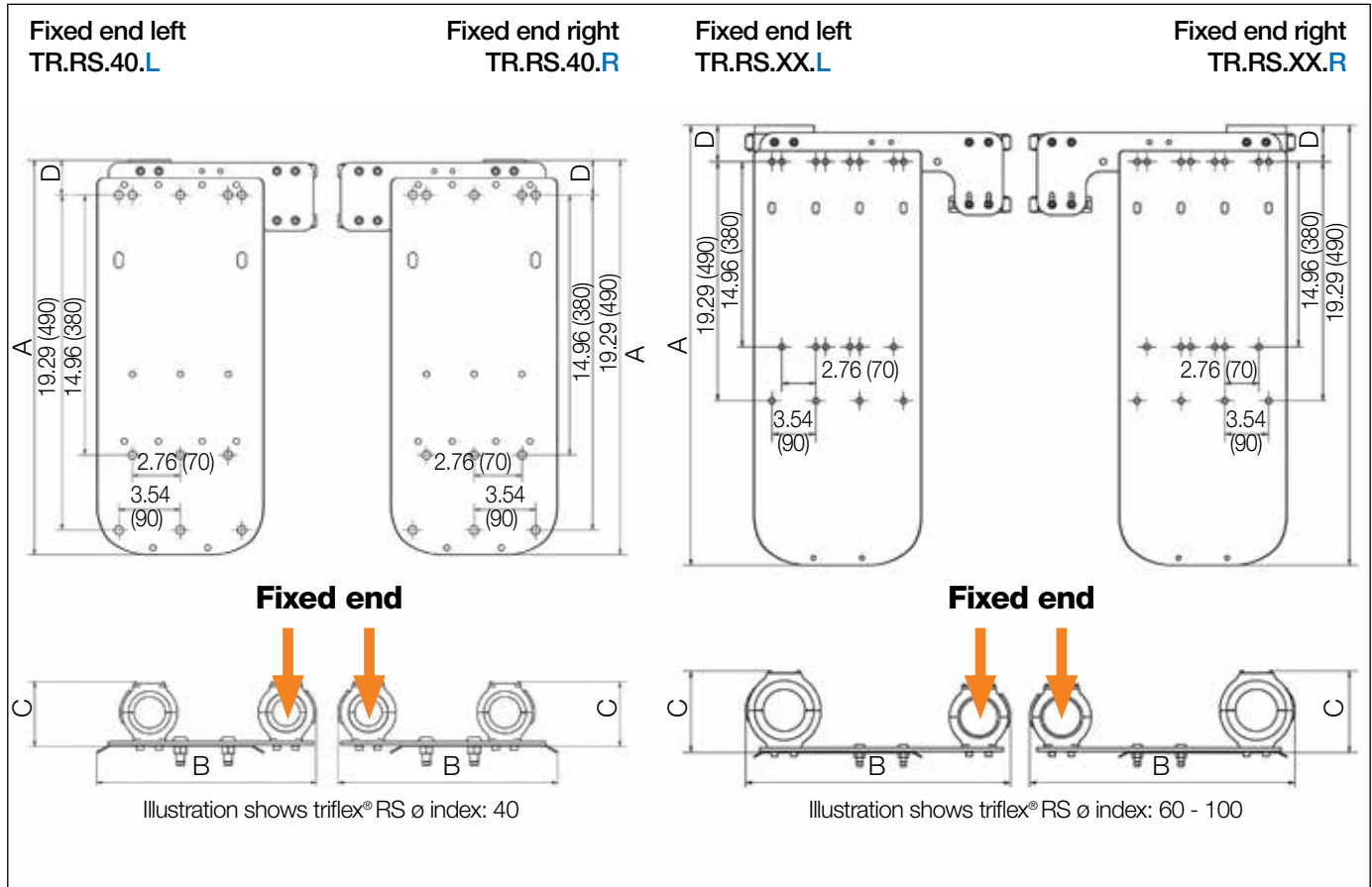

Product range - RS modular retraction system

triflex® RS - Fastening point, right		Retraction										Weight	
Universal module TRS	Part No.	Length ¹⁾		A		B		C		D		lb	(kg)
For Series TRC	For Series TRE	≤ in.	≤ (mm)	in.	(mm)	in.	(mm)	in.	(mm)	in.	(mm)		
TRC.RS.40.R	▶ TRE.RS.40.R.B	18.11	(460)	24.41	(620)	11.85	(301)	3.74	(95)	2.01	(51)	7.72	(3.5)
TRC.RS.60.R	▶ TRE.RS.60.R.B	21.65	(550)	34.84	(885)	20.79	(528)	5.91	(150)	2.56	(65)	19.18	(8.7)
TRC.RS.70.R	▶ TRE.RS.70.R.B	24.41	(620)	34.84	(885)	21.46	(545)	6.57	(167)	2.56	(65)	20.28	(9.2)
TRC.RS.85.R	▶ TRE.RS.85.R.B	26.38	(670)	34.84	(885)	22.24	(565)	6.57	(167)	2.56	(65)	20.94	(9.5)
TRC.RS.100.R	▶ TRE.RS.100.R.B	22.83	(580)	35.93	(912.5)	24.17	(614)	6.57	(167)	4.25	(108)	25.35	(11.5)

triflex® RS - Fastening point, left		Retraction										Weight	
Universal module	Part No.	Length ¹⁾		A		B		C		D		lb	(kg)
For Series TRC	For Series TRE	≤ in.	≤ (mm)	in.	(mm)	in.	(mm)	in.	(mm)	in.	(mm)		
TRC.RS.40.L	▶ TRE.RS.40.L.B	18.11	(460)	24.41	(620)	11.85	(301)	3.74	(95)	2.01	(51)	7.72	(3.5)
TRC.RS.60.L	▶ TRE.RS.60.L.B	21.65	(550)	34.84	(885)	20.79	(528)	5.91	(150)	2.56	(65)	19.18	(8.7)
TRC.RS.70.L	▶ TRE.RS.70.L.B	24.41	(620)	34.84	(885)	21.46	(545)	6.57	(167)	2.56	(65)	20.28	(9.2)
TRC.RS.85.L	▶ TRE.RS.85.L.B	26.38	(670)	34.84	(885)	22.24	(565)	6.57	(167)	2.56	(65)	20.94	(9.5)
TRC.RS.100.L	▶ TRE.RS.100.L.B	22.83	(580)	35.93	(912.5)	24.17	(614)	6.57	(167)	4.25	(108)	25.35	(11.5)

Product range - with cover

triflex® RS - Fastening point, right, with cover		Retraction										Weight	
Universal module TRS	Part No.	Length ¹⁾		A		B		C		D		lb	(kg)
For Series TRC	For Series TRE	≤ in.	≤ (mm)	in.	(mm)	in.	(mm)	in.	(mm)	in.	(mm)		
TRC.RS.40.RC	▶ TRE.RS.40.RC.B	18.11	(460)	24.41	(620)	11.85	(301)	3.74	(95)	2.01	(51)	7.72	(3.5)
TRC.RS.60.RC	▶ TRE.RS.60.RC.B	21.65	(550)	34.84	(885)	20.79	(528)	5.91	(150)	2.56	(65)	19.18	(8.7)
TRC.RS.70.RC	▶ TRE.RS.70.RC	24.41	(620)	34.84	(885)	21.46	(545)	6.57	(167)	2.56	(65)	20.28	(9.2)
TRC.RS.85.RC	▶ TRE.RS.85.RC	26.38	(670)	34.84	(885)	22.24	(565)	6.57	(167)	2.56	(65)	20.94	(9.5)
TRC.RS.100.RC	▶ TRE.RS.100.RCB	22.83	(580)	35.93	(912.5)	24.17	(614)	6.57	(167)	4.25	(108)	25.35	(11.5)

triflex® RS - Fastening point, left, with cover		Retraction										Weight	
Universal module	Part No.	Length ¹⁾		A		B		C		D		lb	(kg)
For Series TRC	For Series TRE	≤ in.	≤ (mm)	in.	(mm)	in.	(mm)	in.	(mm)	in.	(mm)		
TRC.RS.40.LC	▶ TRE.RS.40.LC.B	18.11	(460)	24.41	(620)	11.85	(301)	3.74	(95)	2.01	(51)	7.72	(3.5)
TRC.RS.60.LC	▶ TRE.RS.60.LC.B	21.65	(550)	34.84	(885)	20.79	(528)	5.91	(150)	2.56	(65)	19.18	(8.7)
TRC.RS.70.LC	▶ TRE.RS.70.LC.B	24.41	(620)	34.84	(885)	21.46	(545)	6.57	(167)	2.56	(65)	20.28	(9.2)
TRC.RS.85.LC	▶ TRE.RS.85.LC	26.38	(670)	34.84	(885)	22.24	(565)	6.57	(167)	2.56	(65)	20.94	(9.5)
TRC.RS.100.LC	▶ TRE.RS.100.LCB	22.83	(580)	35.93	(912.5)	24.17	(614)	6.57	(167)	4.25	(108)	25.35	(11.5)

Up to 30.71" (780mm) retraction length possible
with TRC, TRE and TRCF e-chains®
(please order matching e-chain® separately)

triflex® RSP Pneumatic retraction system

Increased protection against failure by
optional end position monitoring

Standard pneumatic
components for
easy integration

Pressure compensation unit for
an adjustable retraction force

Open system, low profile design

Custom connection possibilities
using adapter consoles

Double retraction distance
relative to the overall length

triflex® RSP prevents loops on the robot head, with a continuously adjustable retraction force. Extension lengths of up to 30.71" (780mm) enable a secure guidance of the cables and hoses, even with large arm diameters and very complex movements. The retraction forces can be adjusted using a pneumatic cylinder. Whether light or heavy fill weights, long or short robot arms - with the igus® RSP retraction system the retraction force can be adjusted to the individual application.

- For axis 3-6 on industrial robots
- Larger retraction forces than RS system
- Even larger e-chains® up to Ø 4.92" (125mm) can be guided safely
- Almost constant force over the complete travel, even with heavy fill weights
- The end position can be monitored so damage can be prevented
- Mounting options for numerous robot models and manufacturers with adapter consoles
- Very low energy consumption with integrated air reservoir

Optional accessories - RSP pneumatic retraction system



Adjustment unit - for accurate adjustment of the system position



Adapter consoles - for custom mounting options



Axis 6 clamp - for triflex®R mounting bracket

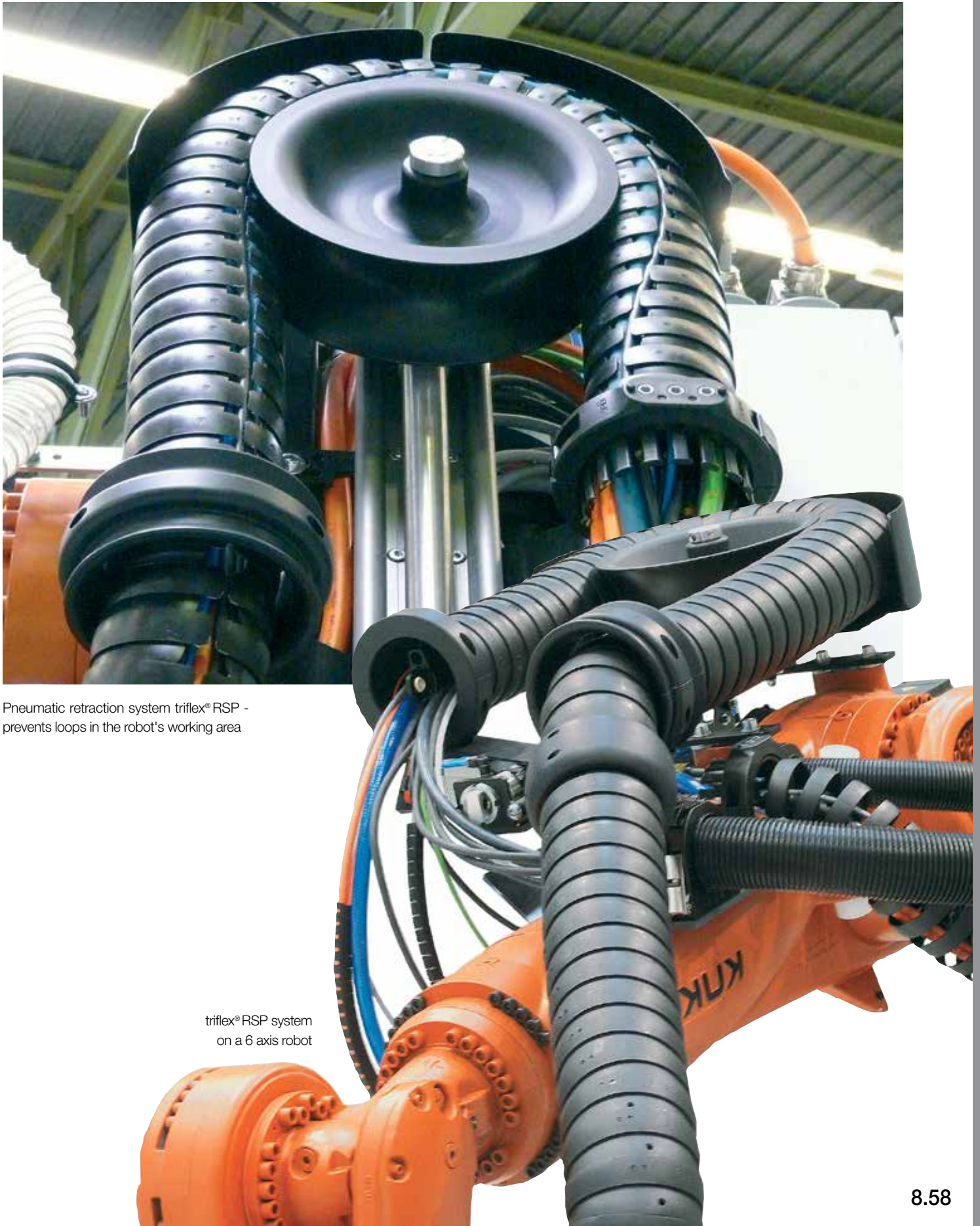

Pneumatic retraction system triflex® RSP - prevents loops in the robot's working area

triflex® RSP system
on a 6 axis robot

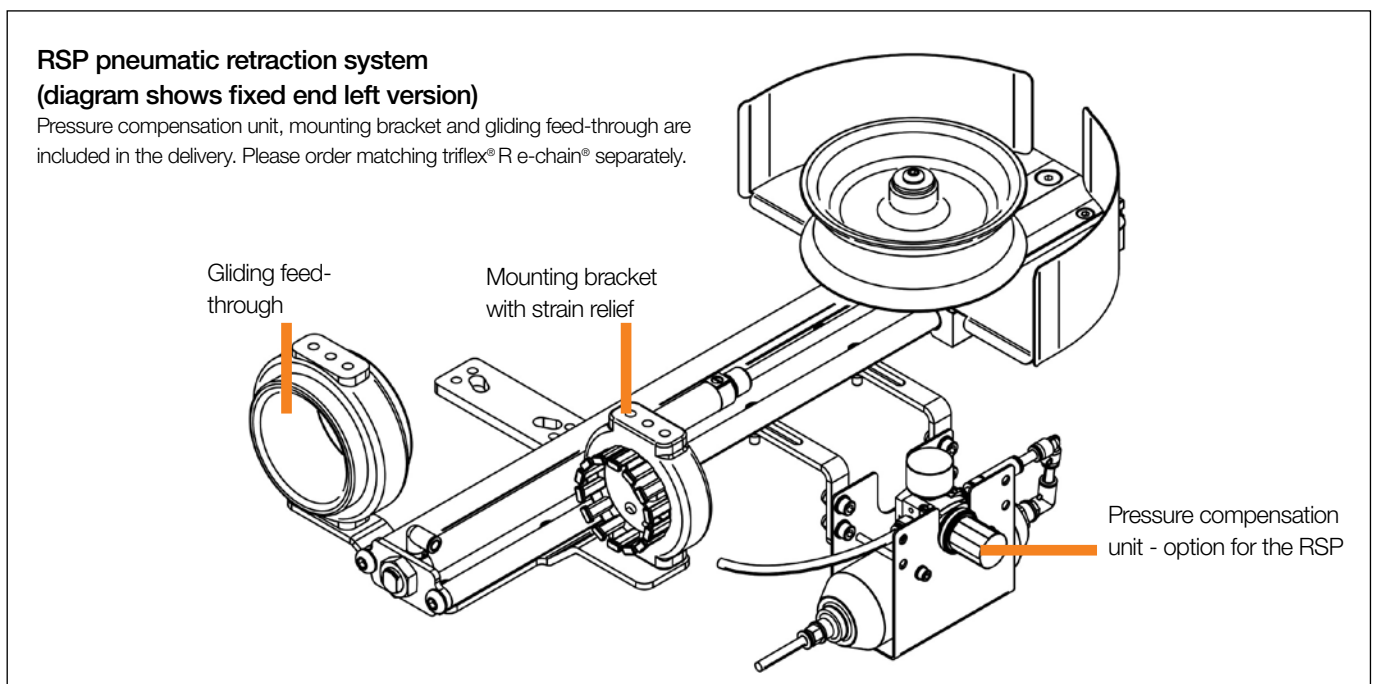
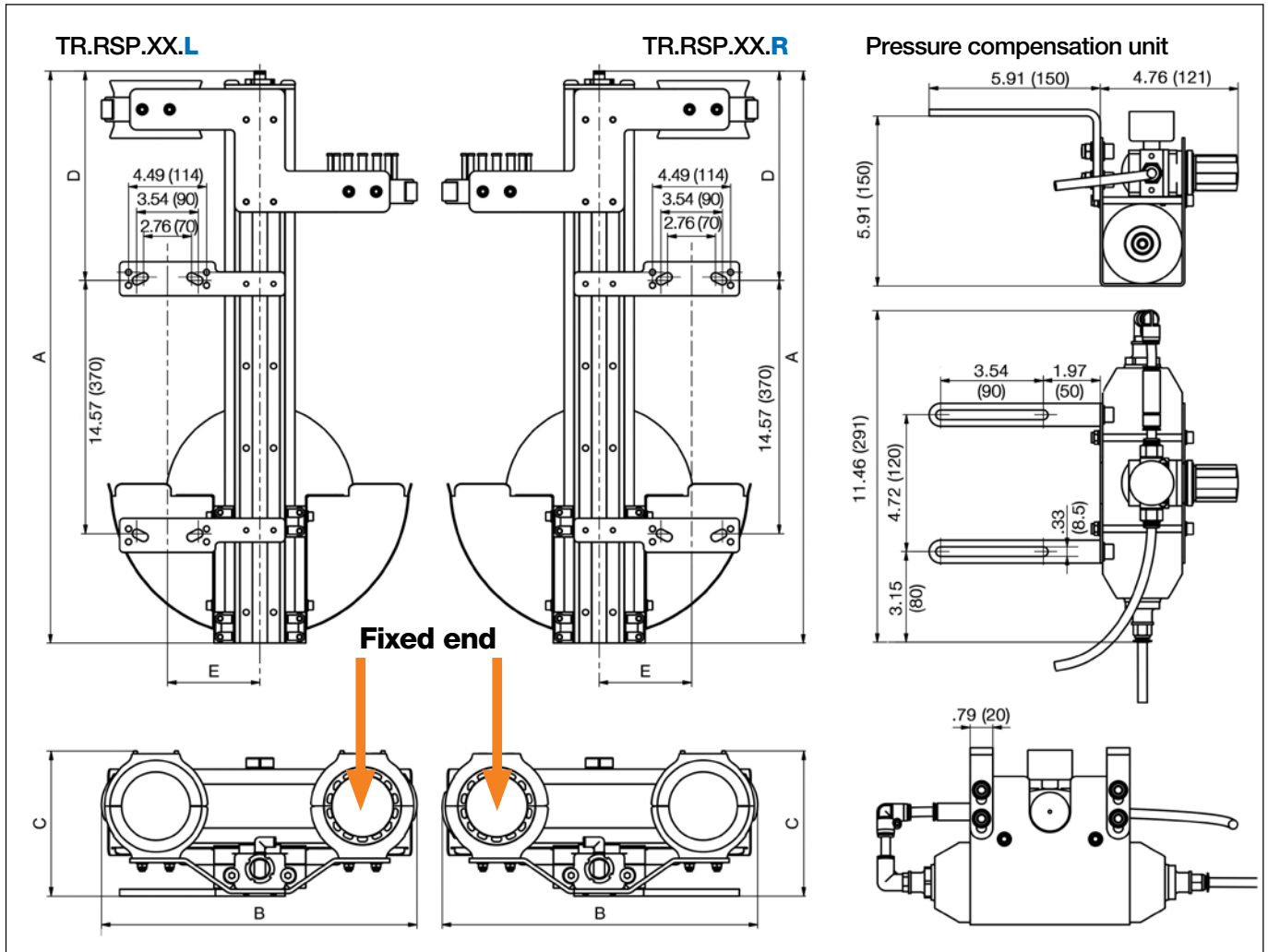

Product range - RSP Pneumatic Retraction System - for TRC TRE

For Series Ø	RSP Left fixed point Part. No.	RSP Right fixed point Part. No.	Retract travel maximum in. (mm) ¹⁾	Dimension A in. (mm)	Dimension B in. (mm)	Dimension C in. (mm)	Dimension D in. (mm)	Dimension E in. (mm)	Weight lb. (kg)
.30.	▶ -	-	-	-	-	-	-	-	-
.40.	▶ -	-	-	-	-	-	-	-	-
.50.	▶ -	-	-	-	-	-	-	-	-
.60.	▶ TR.RSP.60.L	TR.RSP.60.R	22.83 (580)	31.18 (792)	15.59 (396)	6.97 (177)	10.91 (277)	5.31 (135)	35.49 (16.1)
.65.	▶ TR.RSP.65.L	TR.RSP.65.R	22.83 (580)	31.18 (792)	15.59 (396)	6.97 (177)	10.91 (277)	5.31 (135)	35.49 (16.1)
.70.	▶ TR.RSP.70.L	TR.RSP.70.R	22.83 (580)	31.18 (792)	15.59 (396)	6.97 (177)	10.91 (277)	5.31 (135)	35.71 (16.2)
.85.	▶ TR.RSP.85.L	TR.RSP.85.R	24.41 (620)	32.91 (836)	18.15 (461)	8.39 (213)	12.05 (306)	5.31 (135)	42.77 (19.4)
.85.(R240)	▶ -	-	-	-	-	-	-	-	-
.100.	▶ TR.RSP.100.L	TR.RSP.100.R	24.41 (620)	33.27 (845)	18.39 (467)	8.39 (213)	12.05 (306)	5.31 (135)	42.99 (19.5)
.125.	▶ TR.RSP.125.L	TR.RSP.125.R	30.71 (780)	41.06 (1043)	22.44 (570)	9.65 (245)	15.94 (405)	5.31 (135)	53.13 (24.1)

Pressure compensation unit, mounting bracket, and feed-through guides are included.

Please order matching triflex® e-chain® separately.

1) These are maximum values. We do not recommend using more than 70% during normal operations to preserve a margin of error.

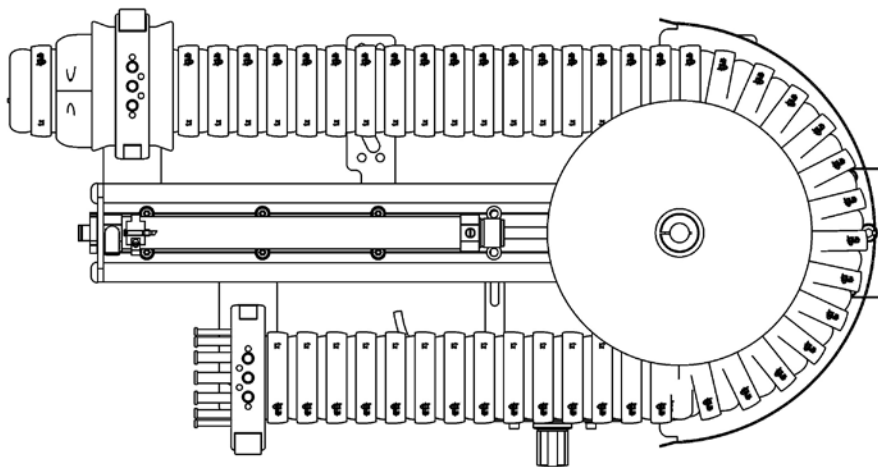

TR. RSP.XX .L / R  Order Key

- R** = Right fixed end
- L** = Left fixed end
- Series Ø
- System
- triflex® series

System design | RSP and matching e-chains®

Standard chain length for each system. See chart below



Additional chain from gliding feed-through bracket to end of arm tool

IMPORTANT - Ball end of triflex® must run in direction of the end of arm tool

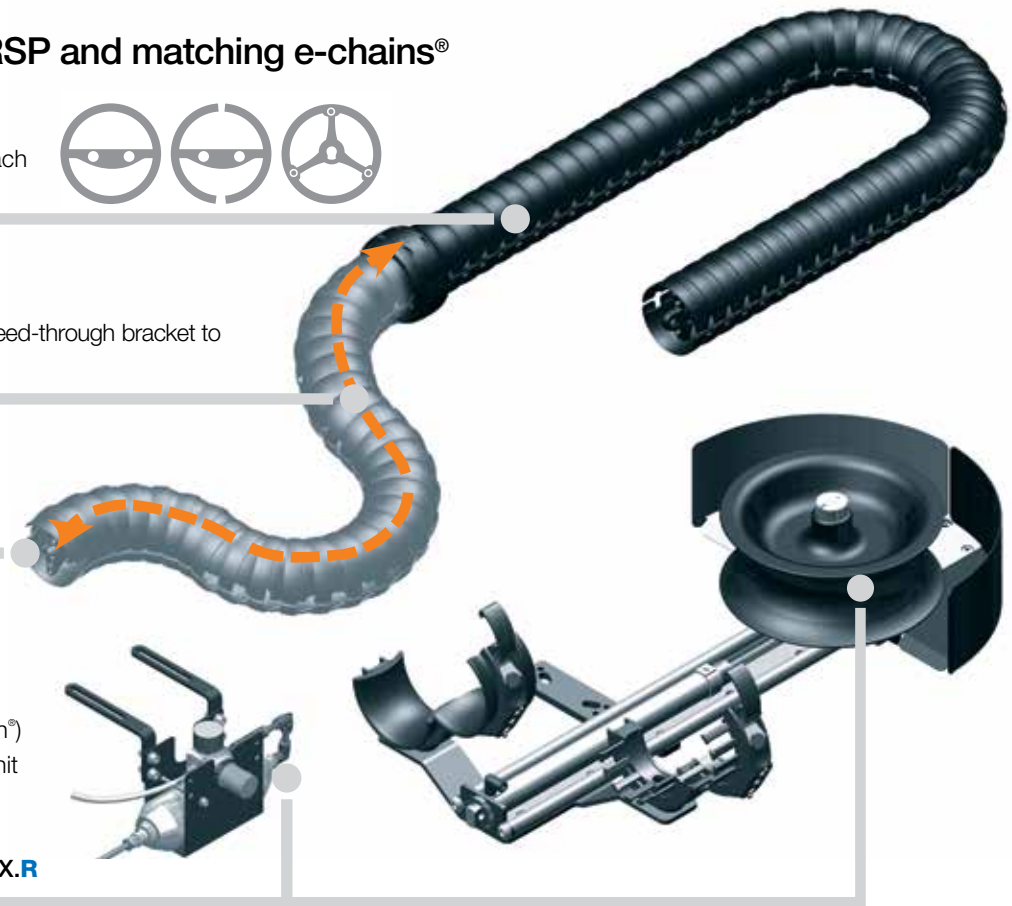

RSP system (without e-chain®)
+ pressure compensation unit
+ mounting bracket
+ gliding feed-through =
TR.RSP.XX.L or **TR.RSP.XX.R**



Sample order of a complete TR-RSP system, Ø-Index 60, fixed end on the left, and e-chain®

System	Insert Ø index XX / select fixed end -L / -R	TR.RSP.60.L
+ e-chain®	Standard Length TRE-60-080-0-B x 1489mm + Additional Length TRE-60-080-0-B x 1500mm = 2989mm	
+ Protector:		TR.60.30

Calculating the overall chain length - RSP e-chains®

ø		Bend radius <i>R</i>		e-chain® length*		Number of e-chains® links	Total e-chain® length (mm)
		in.	(mm)	in.	(mm)		
30.	▶	-	-	-	-	-	-
40.	▶	-	-	-	-	-	-
50.	▶	-	-	-	-	-	-
60.	▶	3.43	087	58.62	1489	73	LLLL + 58.62 (1489)
65.	▶	3.94	100	56.38	1432	62	LLLL + 56.38 (1432)
70.	▶	4.33	110	58.43	1484	58	LLLL + 58.43 (1484)
85.	▶	5.31	135	63.86	1622	53	LLLL + 63.86 (1622)
85. (<i>R 240</i>)	▶	-	-	-	-	-	-
100.	▶	5.71	145	65.20	1656	48	LLLL + 65.20 (1656)
125.	▶	7.17	182	77.24	1962	44	LLLL + 77.24 (1962)

*Values are related to the e-chain® length within the system

Please add the e-chain® length within the system to the standard length **LLLL** (measured from the gliding feed-through) to get the **overall chain length**

triflex® RSE Wheel retraction system

Up to 19.69" (500mm) retraction
length possible with triflex® RSE

For TRC and TRE with ø index 1.57 and 1.97" (40 and 50mm)

Delivered with left or right
fixed end already assembled

Custom connection possibilities
using adapter consoles

Maintenance-free igus®
drylin® W linear unit

Adjustable mounting position

Open system, low profile design

Also for high accelerations
(due to low weight)

Specially developed for robots with small to medium cable and hose filling, the igus® triflex® RSE retraction system offers a way to prevent loop formation in the workspace of the robot, even in highly dynamic applications.

- For series TRC-TRE sizes 40 and 50mm
- Extremely fast response, even in highly dynamic robot programs
- Low weight, very little reduction in robot handling capacity
- Universal adjustable installation brackets
- Maintenance and lubrication-free igus® drylin® W linear unit
- For maximum degrees of freedom
- For cable diameters up to .74" (18.8mm)

Optional accessories - RSE Wheel Retraction System



Adapter brackets for
customized mounting options



Mounting brackets - for
installing directly on the tool



Clamps - axis 6 - for triflex® R
mounting bracket



Cover - for additional mounting
space and complex movements

triflex® R - triflex® RSE Wheel - Application example
For Series TRC / TRE
RSE - (R)etraction (S)ystem (E)lastic



triflex®
RSE



Even in confined space - reliable and defined energy supply system



triflex® R is guided closely to the
arm with a low profile

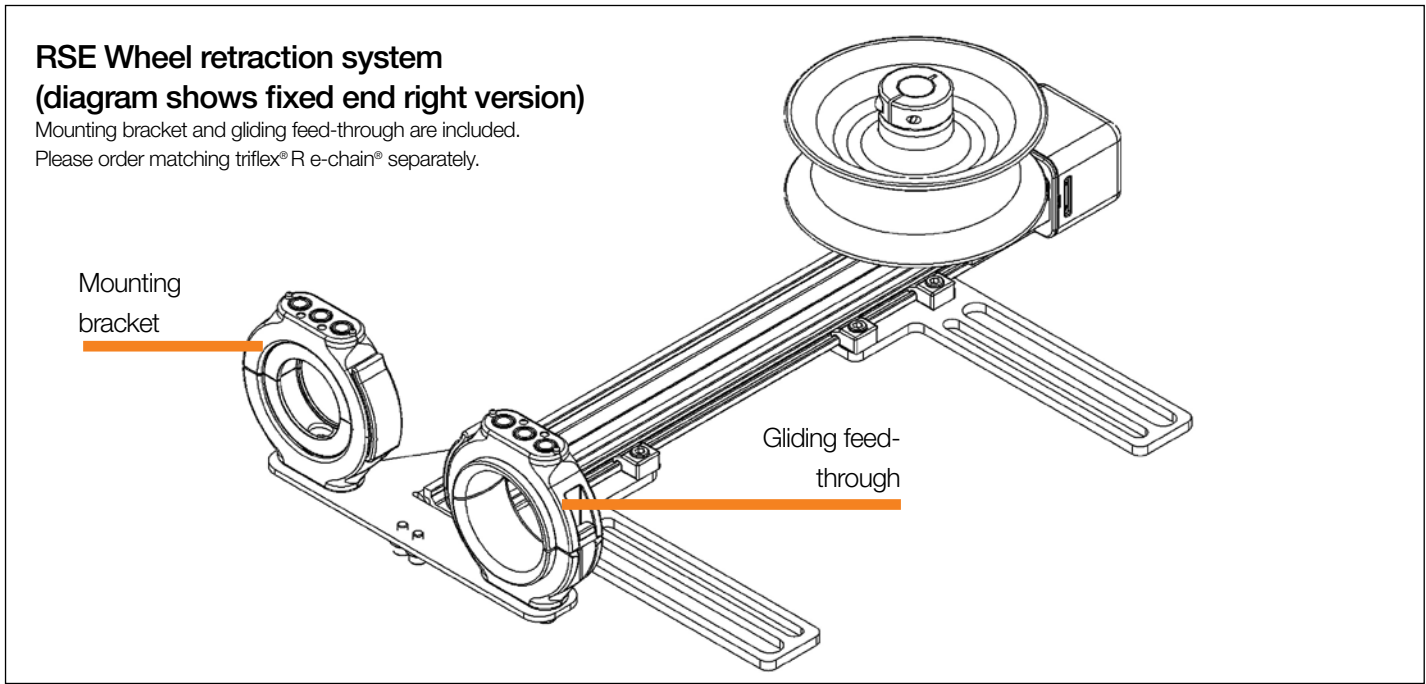
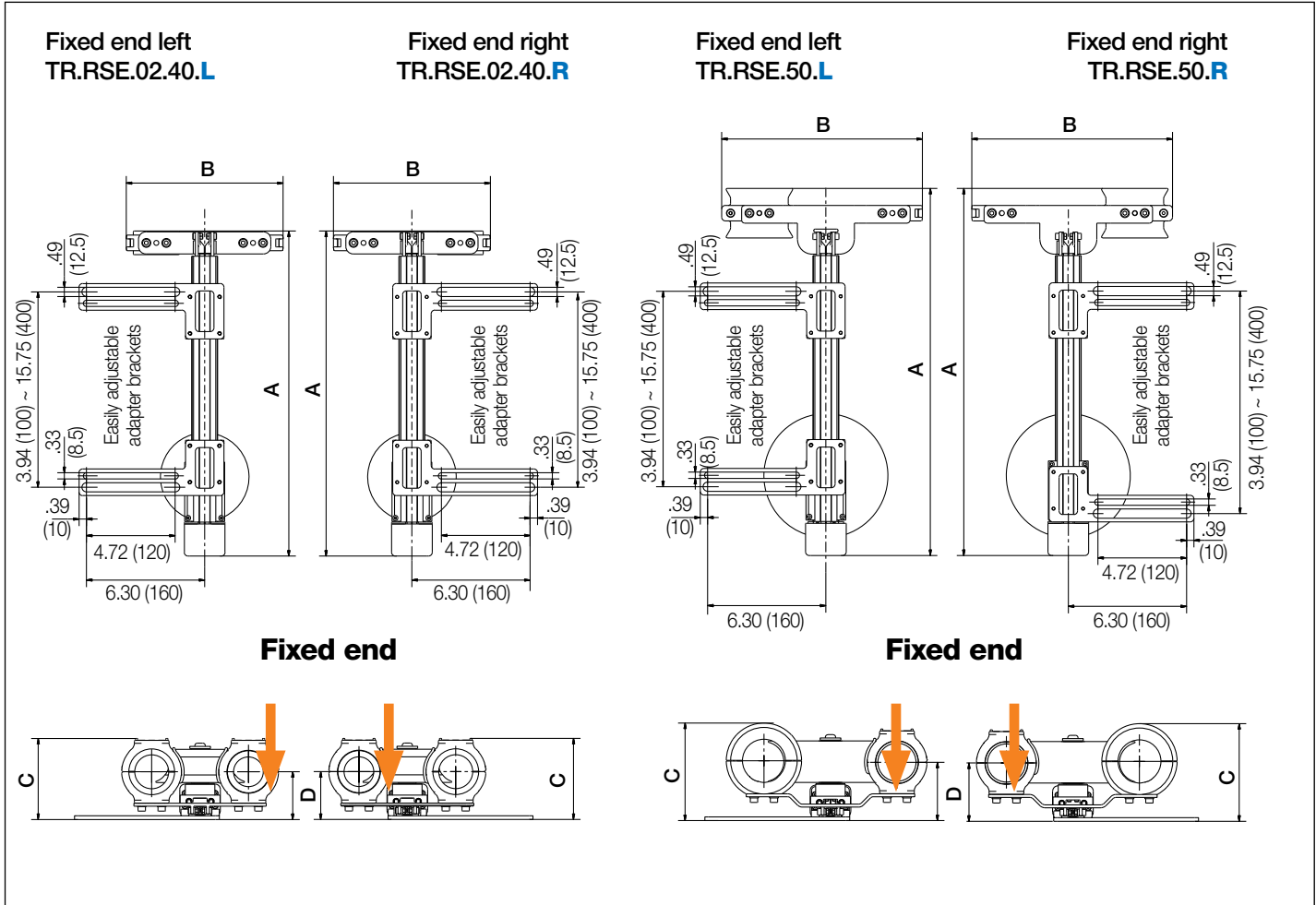

Product range for RSE

triflex® RSE - Fastening point, right			Retraction Length ¹⁾											
ø	Part No. For Series TRC		A		B		C		D		Weight			
			≤ in.	≤ (mm)	in.	(mm)	in.	(mm)	in.	(mm)	in.	(mm)	lb	(kg)
40.	TR.RSE.40.R	▶	19.69	(500)	17.32	(440)	8.66	(220)	4.33	(110)	2.55	(64.7)	3.53	(1.6)
50.	TR.RSE.50.R	▶	19.69	(500)	19.57	(497)	10.83	(275)	5.20	(132)	3.11	(79)	4.63	(2.1)
triflex® RS - Fastening point, left			Retraction Length ¹⁾											
ø	Part No. For Series TRC		A		B		C		D		Weight			
			≤ in.	≤ (mm)	in.	(mm)	in.	(mm)	in.	(mm)	in.	(mm)	lb	(kg)
40.	TR.RSE.40.L	▶	19.69	(500)	17.32	(440)	8.66	(220)	4.33	(110)	2.55	(64.7)	3.53	(1.6)
50.	TR.RSE.50.L	▶	19.69	(500)	19.57	(497)	10.83	(275)	5.20	(132)	3.11	(79)	4.63	(2.1)
Optional cover			Retraction Length ¹⁾											
ø	Part No. For Series TRC		A		B		C		D		Weight			
			≤ in.	≤ (mm)	in.	(mm)	in.	(mm)	in.	(mm)	in.	(mm)	lb	(kg)
40.	TR.RSE.40.COV	▶	19.69	(500)	17.32	(440)	8.66	(220)	4.33	(110)	2.55	(64.7)	3.53	(1.6)
50.	TR.RSE.50.COV	▶	19.69	(500)	19.57	(497)	10.83	(275)	5.20	(132)	3.11	(79)	4.63	(2.1)

1) These are the maximum values. In normal operation a filling of no more than 70% is advised.

Please order matching triflex® R e-chain® separately.

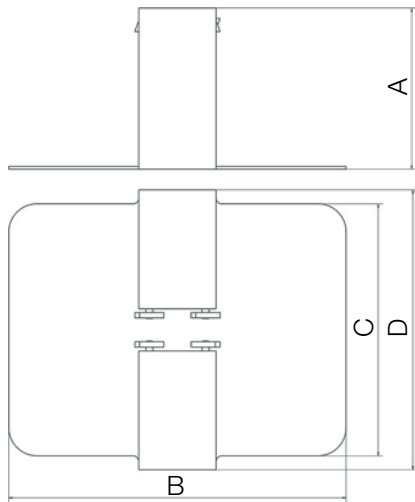

Standard chain length
found in chart below



Additional length from guide through bracket
to end of arm tool.

IMPORTANT - Ball end of
triflex® must run in direction of
the end of arm tool

RSE system (e-chain® not included)
+ Mounting bracket
+ Feed-through guide =
TR-RSE-40-L or **TR-RSE-40-R**

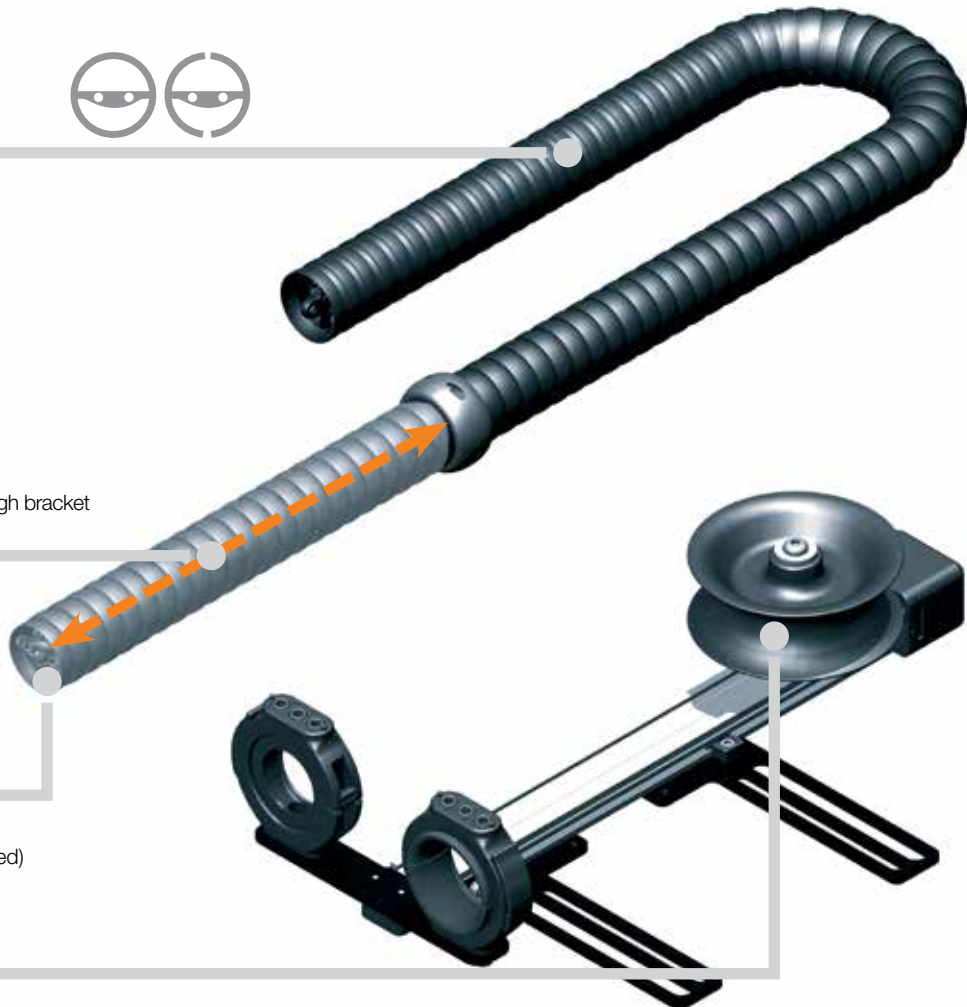

Sample order of a complete TR.RSE system, Ø Index 40, fixed end on the left,
including cover and e-chain® (standard length: 500mm)

System	Insert Ø index XX / select fixed end .L / .R	TR.RSE.40.L
+ e-chain®	Standard Length TRE-40-058-0-B x 904mm + Additional Length TRE-40-058-0-B x 1500mm = 2404mm	
+ protector		TR.40.30
+ cover:	Optional	TR.RSE.40.COV

Calculating the overall chain length - RSE e-chains®

ø Index	Bend radius <i>R</i>		e-chain® length*		Number of e-chains® links	Total e-chain® length (mm)
	in.	<i>R</i> (mm)	in.	(mm)		
40. ▶	2.28	(058)	35.59	(904)	65	LLLL + 904
50. ▶	3.15	(080)	41.10	(1044)	60	LLLL + 1044

*Values are related to the e-chain® length within the system

Please add the e-chain® length within the system to the standard length **LLLL** (measured from the gliding feed-through) to get the **overall chain length**

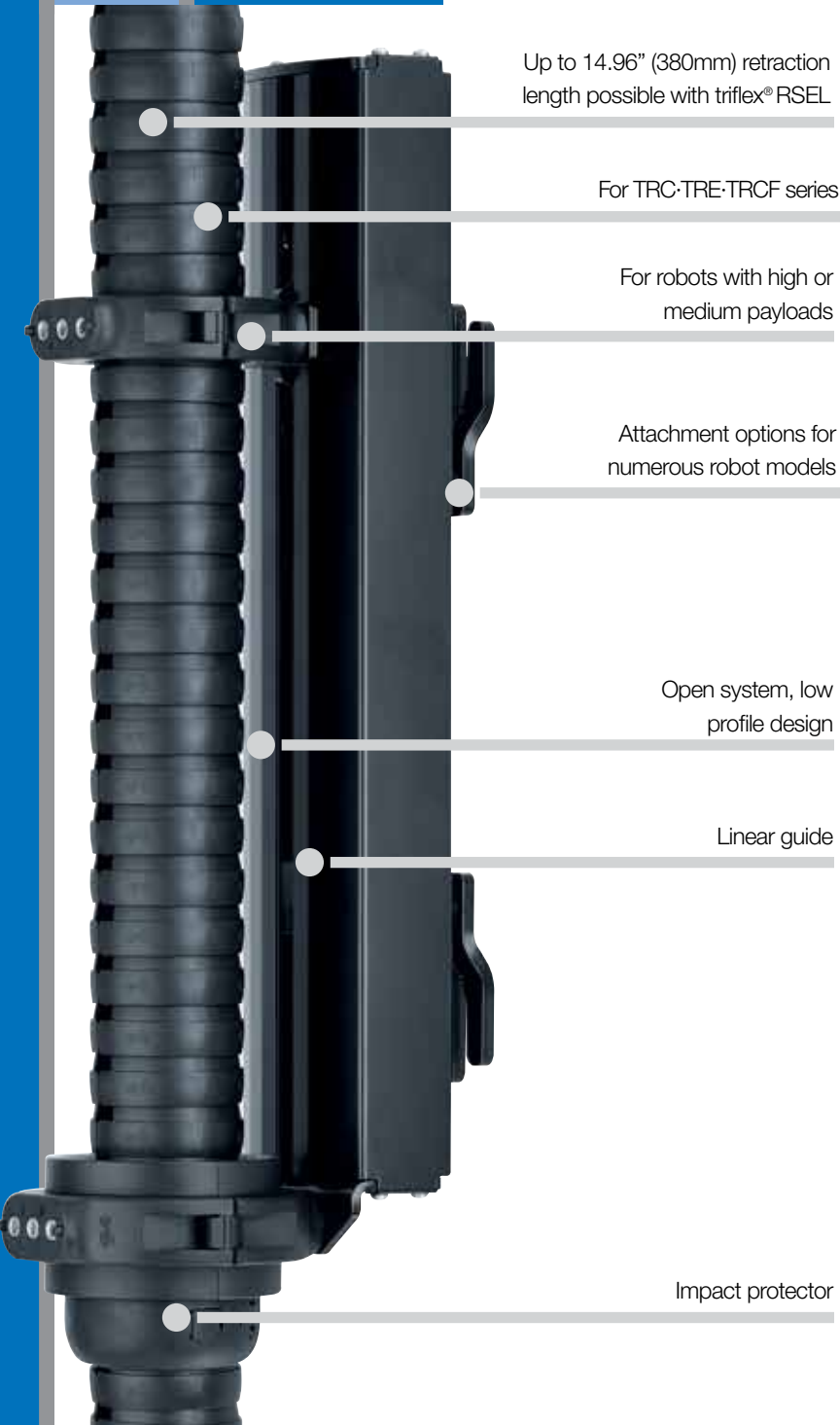

Up to 14.96" (380mm) retraction length possible with triflex® RSEL

For TRC·TRE·TRCF series

For robots with high or medium payloads

Attachment options for numerous robot models

Open system, low profile design

Linear guide

Impact protector

triflex® RSEL linear retraction system

Avoid looping on the robot head - even more cost-effective and even for corrugated tubes, with the RSEL retraction system. Especially designed for robots with medium to high payload, the igus® triflex® RSEL retraction system offers an option to actively avoid looping in the working area of the robot by keeping the e-chain® as close as possible to the robot arm.

- Cost-optimized retraction system, easy to retrofit
- Due to its standard dimensions and the very compact design, the RSEL retraction system can be mounted directly on the 3rd axis of all common types of robots
- Retraction element with elastomer band
- Prevents the e-chain® from looping or blocking the motion, even in highly dynamic applications
- Short type
- Attachment options for numerous robot models
- For robots with high and medium payloads
- The fixed end of the e-chain® can be freely selected due to the linear design of the RSE retraction system

Optional accessories - RSEL Linear retraction system



Adapter brackets for customized mounting options



Clamps - axis 6 - for triflex® R mounting bracket

triflex® R - RSEL - Application example
For Series TRC / TRE / TRCF
RSEL - **(R)**etraction **(S)**ystem **(E)**lastic **(L)**ow-cost



triflex®
RSEL



triflex® RSEL - cost-effective and space-saving
guidance of the e-chain®

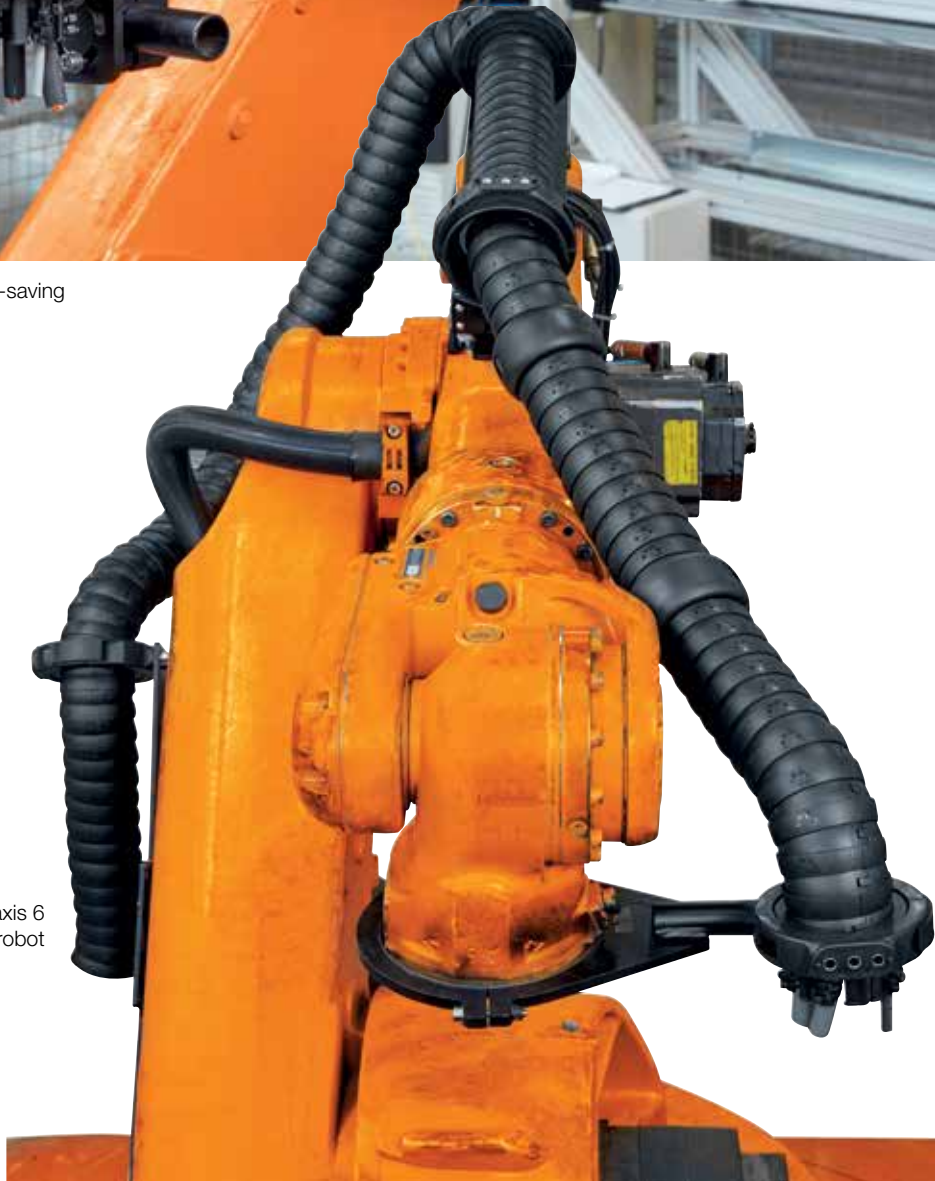

Cable routing from axis 2 to axis 6
on a robot

Matching triflex® R e-chains® for RSEL

- TRC .XX.R.0
- TRE .XX.R.0.B
- TRCF.XX.R.0



Overall e-chain® length* =
Excess length in direction **A1** +
Dimension **A** +
Excess length in direction **A6**

Limit protector

IMPORTANT - Ball end of triflex® must run in direction of the end of arm tool

RSEL system
(without e-chain®) +
mounting bracket +
gliding feed-through =
TR.RSEL.XX

*For calculation of the overall e-chain® length: Please add the desired excess length in direction **A1** and the excess length in direction **A6** and the dimension **A**.

Complete retraction system RSEL and triflex® R e-chain® TRC series. Mounting bracket and gliding feed-through are included. Please order triflex® R e-chains®, limiting protectors separately!

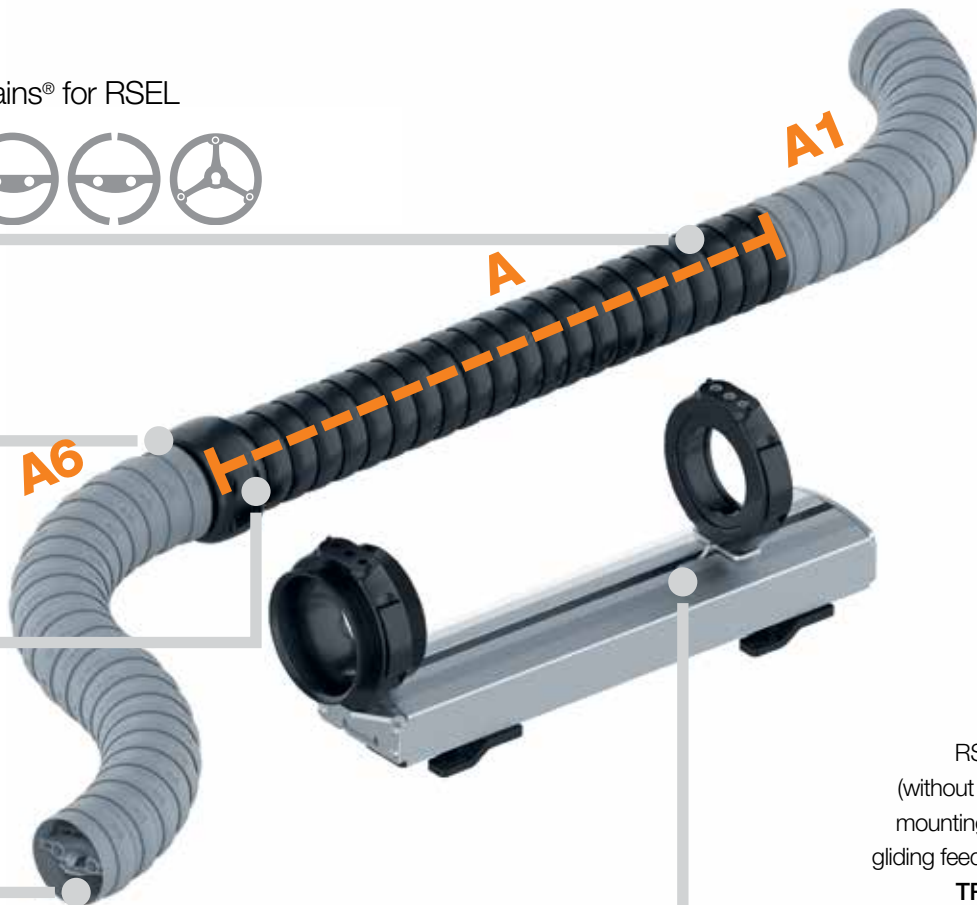

Sample order of a complete TR.RSEL system,
 Ø index 85, and e-chain® (length: 2m)

System	Select Ø index	TR.RSEL.85
+ e-chain®	Insert Ø index / Insert bend radius <i>R</i> / Insert standard length in meters	6.56ft (2m) TRCF.85.135.0
+ protector	Select protector option / specify Ø index	TR.85.30
Order text:	TR.RSEL.85. + 6.56ft (2 m) TRCF.85.135.0 + TR.85.30	

Order key
 retraction system

TR.RSEL.85



Order key
 e-chains®

TRC .85.135.0
 TRE .85.135.0.B
 TRCF.85.135.0



More optional accessories - RSEL retraction system



Protectors
 with screw connections
 or quick release



Adapter brackets
 For custom
 mounting options



Axis 6 clamp
 For triflex® R mounting
 brackets



Product range - RSEL retraction system

Ø Index	Part Number RSEL	Retraction length ¹⁾		A		B		C		Weight	
		≤ in.	≤ [mm]	in.	(mm)	in.	(mm)	in.	(mm)	lbs	(kg)
70.	▶ TR.RSEL.70	14.96	(380)	24.84	(631)	6.10	(155)	10.59	(239)	19.4	(8.8)
85.	▶ TR.RSEL.85	14.96	(380)	25.12	(638)	6.10	(155)	9.88	(251)	19.6	(8.9)

Please order matching triflex® R e-chain® separately. 1) Maximum retraction length

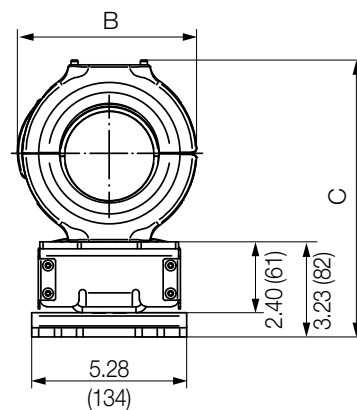
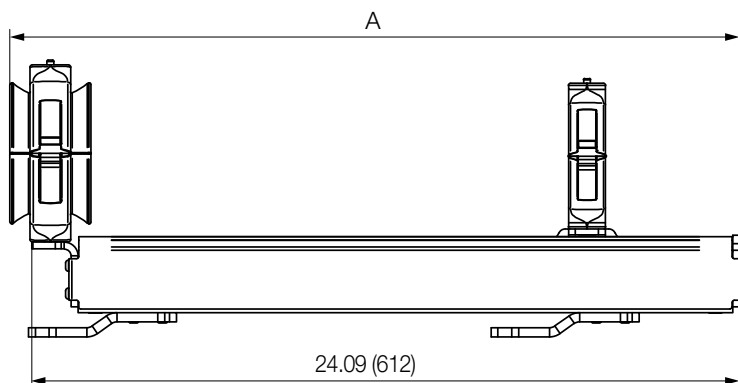

Installation height RSEL
Series TR.RSEL.70 - TR.RSEL.85

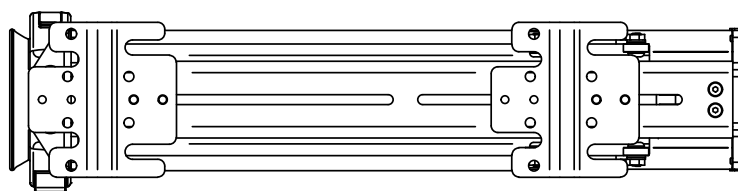

Gliding feed-through

Mounting bracket



RSEL retraction system

Mounting bracket and gliding feed-through are included.
Please order matching triflex® R e-chain® separately.



Product range - Matching e-chains® for RSEL

∅ Index	Part No. TRC enclosed	Part No. TRE "easy" design	Part No. TRCF with snap lock mechanism
70.	▶ TRC.70.110.0	TRE.70.110.B	-
85.	▶ TRC.85.135.0	TRE.85.135.B	TRCF.85.135.0

1) Available for B- and C-versions

Please note that all triflex® R e-chains can be lengthened and shortened individually and can be customized to meet the needs of your application.

Please order e-chains® as piece parts and purchase a protector for each one.

Product range - Matching protectors for RSEL

∅	① Part No. protector with screw fastener	② Part No. protector with quick-lock fastener	General image protector options
70.	▶ TR.70.10	TR.70.30	
85.	▶ TR.85.10	TR.85.30	

*Available upon request. Please consult igus® for delivery time.

Please order protectors with screw connections or quick release as limit protectors.

More information
 on protectors page X.XX

∅ Index	Bend radius <i>R</i>		Dimension <i>A</i>		General image overall e-chain® length
	in.	(mm)	in.	(mm)	
70.	▶ 4.33	(110)	20.87	(530)	
85.	▶ 5.31	(135)	20.87	(530)	

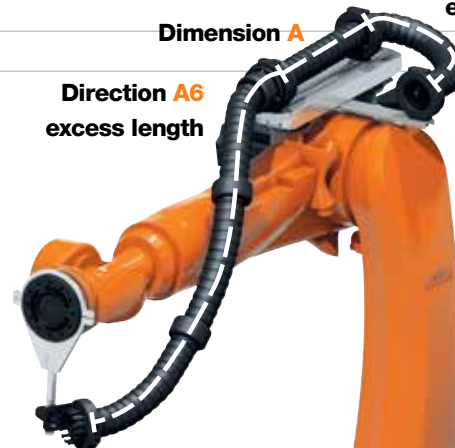
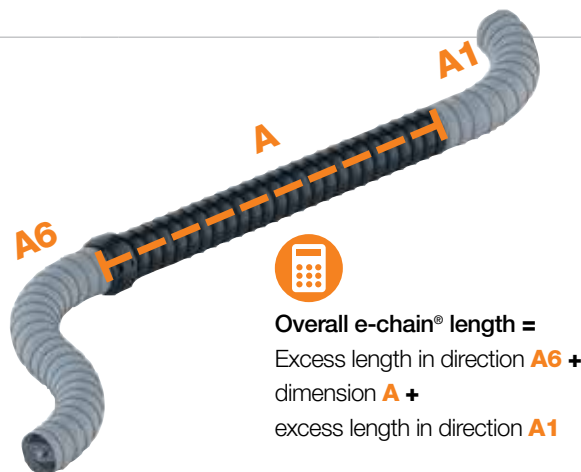

Direction A1
 excess length

Direction A6
 excess length

For calculation of the overall e-chain® length: Please add the desired excess length in direction **A1** and the excess length in direction **A6** and the dimension **A**. Additionally, at least 1 limit protector must be ordered.

Compensates relative motion of the integrated fiber rods
with five rigidly connected chain links

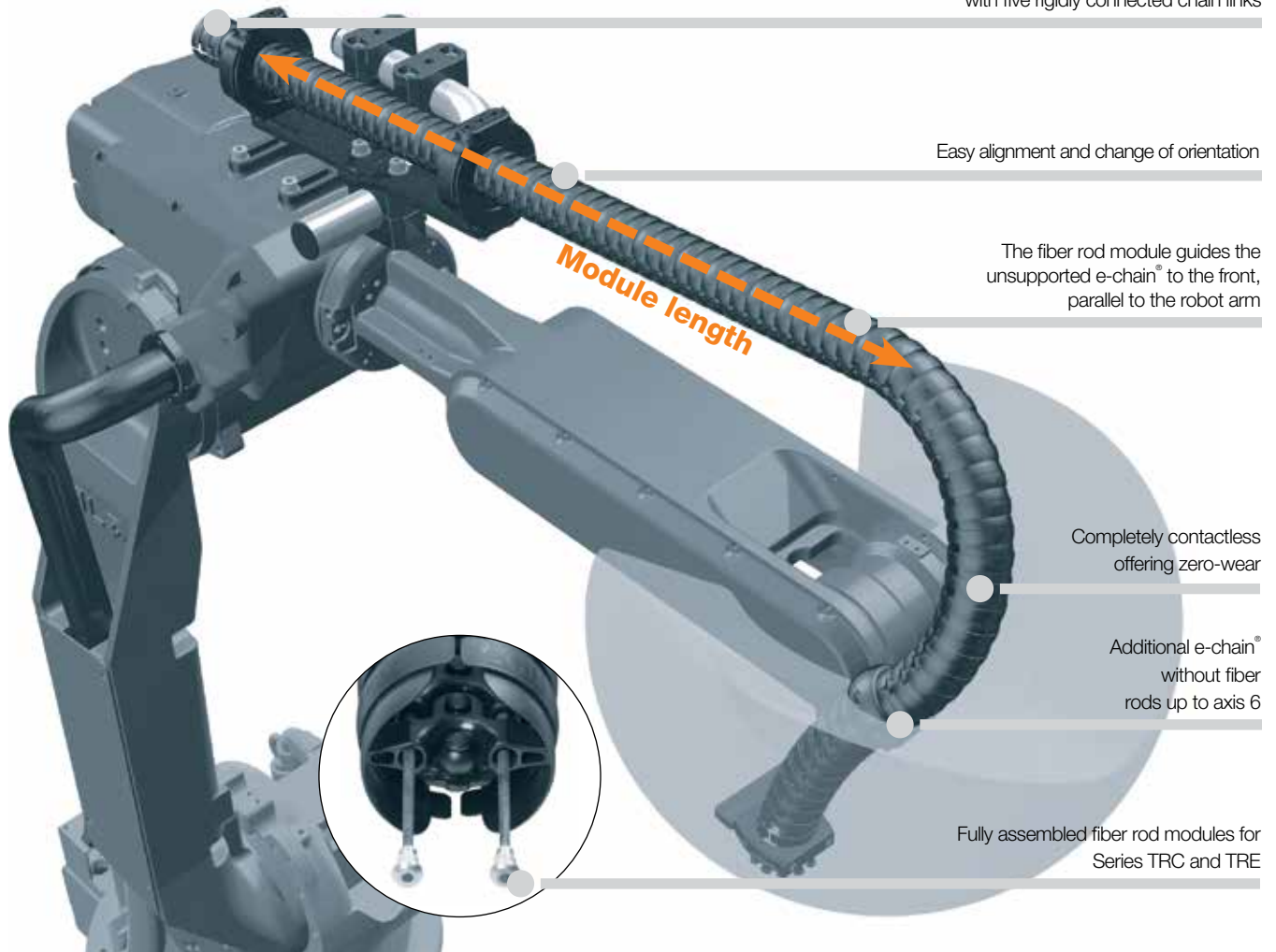

Fiber rod modules for a directional camber of the e-chain® - for TRC & TRE

We supply fully assembled fiber rod modules for triflex® R e-chain® Series TRC and TRE. The integrated fiber rods generate a directional camber of the e-chain®. This system creates a unique choice of combinations for the energy supply system on manual axis of industrial robots. The fiber rod module guides the unsupported e-chain® to the front, parallel to the robot arm. The bending properties of the modules depends on the installation orientation: only the front area is designed for flexible movement (accordingly, align with moving tool during assembly). The five rear chain links are rigidly connected and compensate the relative movement of the integrated fiber rods. A fully contactless and therefore zero-wear energy supply system can be realized, particularly for moderate movements with limited pivot motion of the axis. An additional e-chain® without fiber rods for the hand area needs to be ordered separately.



Part. No. fiber rod modules for TRC / TRE		Approx. length ft. (m)	
TRC-40	TRE-40		
TRC.F.40.1000.1.0	TRE.F.40.1000.1.0.B	3.28	1.0
TRC.F.40.0900.1.0	TRE.F.40.0900.1.0.B	2.95	0.9
TRC.F.40.0800.1.0*	TRE.F.40.0800.1.0.B*	2.62	0.8
TRC.F.40.0700.1.0	TRE.F.40.0700.1.0.B	2.30	0.7
TRC.F.40.0600.1.0	TRE.F.40.0600.1.0.B	1.97	0.6
TRC.F.40.0500.1.0	TRE.F.40.0500.1.0.B	1.64	0.5
TRC.F.40.0400.1.0	TRE.F.40.0400.1.0.B	1.31	0.4
TRC-50	TRE-50		
TRC.F.50.1400.1.0	TRE.F.50.1400.1.0.B	4.59	1.4
TRC.F.50.1200.1.0	TRE.F.50.1200.1.0.B	3.94	1.2
TRC.F.50.1000.1.0*	TRE.F.50.1000.1.0.B*	3.28	1.0
TRC.F.50.0800.1.0	TRE.F.50.0800.1.0.B	2.62	0.8
TRC.F.50.0600.1.0	TRE.F.50.0600.1.0.B	1.97	0.6
TRC.F.50.0400.1.0	TRE.F.50.0400.1.0.B	1.31	0.4
TRC-60	TRE-60		
TRC.F.60.1400.1.0	TRE.F.60.1400.1.0.B	4.59	1.4
TRC.F.60.1200.1.0	TRE.F.60.1200.1.0.B	3.94	1.2
TRC.F.60.1000.1.0*	TRE.F.60.1000.1.0.B*	3.28	1.0
TRC.F.60.0800.1.0	TRE.F.60.0800.1.0.B	2.62	0.8
TRC.F.60.0600.1.0	TRE.F.60.0600.1.0.B	1.97	0.6
TRC.F.60.0400.1.0	TRE.F.60.0400.1.0.B	1.31	0.4
TRC-70	TRE-70		
TRC.F.70.1800.1.0	TRE.F.70.1800.1.0.B	5.91	1.8
TRC.F.70.1600.1.0	TRE.F.70.1600.1.0.B	5.25	1.6
TRC.F.70.1400.1.0	TRE.F.70.1400.1.0.B	4.59	1.4
TRC.F.70.1200.1.0*	TRE.F.70.1200.1.0.B*	3.94	1.2
TRC.F.70.1000.1.0	TRE.F.70.1000.1.0.B	3.28	1.0
TRC.F.70.0800.1.0	TRE.F.70.0800.1.0.B	2.62	0.8

Part. No. fiber rod modules for TRC / TRE		Approx. length ft. (m)	
TRC-85	TRE-85		
TRC.F.85.2000.1.0	TRE.F.85.2000.1.0.B	6.56	2.0
TRC.F.85.1800.1.0	TRE.F.85.1800.1.0.B	5.91	1.8
TRC.F.85.1600.1.0	TRE.F.85.1600.1.0.B*	5.25	1.6
TRC.F.85.1400.1.0*	TRE.F.85.1400.1.0.B*	4.59	1.4
TRC.F.85.1200.1.0	TRE.F.85.1200.1.0.B	3.94	1.2
TRC.F.85.1000.1.0	TRE.F.85.1000.1.0.B	3.28	1.0
TRC.F.85.0800.1.0	TRE.F.85.0800.1.0.B	2.62	0.8
TRC-100	TRE-100		
TRC.F.100.2000.1.0	TRE.F.100.2000.1.0.B /C	6.56	2.0
TRC.F.100.1800.1.0	TRE.F.100.1800.1.0.B /C	5.91	1.8
TRC.F.100.1600.1.0	TRE.F.100.1600.1.0.B /C	5.25	1.6
TRC.F.100.1400.1.0*	TRE.F.100.1400.1.0.B /C*	4.59	1.4
TRC.F.100.1200.1.0	TRE.F.100.1200.1.0.B /C	3.94	1.2
TRC.F.100.1000.1.0	TRE.F.100.1000.1.0.B /C	3.28	1.0
TRC-125	TRE-125		
TRC.F.125.2000.1.0	TRE.F.125.2000.1.0	6.56	2.0
TRC.F.125.1800.1.0*	TRE.F.125.1800.1.0*	5.91	1.8
TRC.F.125.1600.1.0	TRE.F.125.1600.1.0	5.25	1.6
TRC.F.125.1400.1.0	TRE.F.125.1400.1.0	4.59	1.4
TRC.F.125.1200.1.0	TRE.F.125.1200.1.0	3.94	1.2
TRC.F.125.1000.1.0	TRE.F.125.1000.1.0	3.28	1.0

*Maximum recommended length for fiber rod modules
For the C version, please add the index .C

Universal assembly kit - for TRC, TRE

- Stainless steel angle tube with attachment brackets
- Freely positionable
- The energy supply system can be quickly and easily adapted to the new programming sequences of the robot
- With 2 mounting brackets for sizes 40 and 60 - with 3 mounting brackets starting at size 70

Product range - Universal mounting kit

For Series ø	Part No.	A		B		C		D		E		Weight	
		in.	(mm)	in.	(mm)	in.	(mm)	in.	(mm)	in.	(mm)	lb	(kg)
40- ▶	TR-40-80	2.91	(74)	1.57	(40)	.33	(8.4)	18.70	(475)	12.80	(325)	7.9	(3.6)
50- ▶	TR-50-80	2.91	(74)	1.57	(40)	.33	(8.4)	18.70	(475)	12.80	(325)	7.9	(3.6)
60- ▶	TR-60-80	2.91	(74)	1.57	(40)	.33	(8.4)	24.61	(625)	12.80	(325)	10.4	(4.7)
70- ▶	TR-70-80	2.95	(75)	3.15	(80)	.50	(12.6)	34.45	(875)	22.64	(575)	13.0	(5.9)
85- ▶	TR-85-80	2.95	(75)	3.15	(80)	.50	(12.6)	34.45	(875)	22.64	(575)	13.9	(6.3)
100- ▶	TR-100-80	2.95	(75)	3.15	(80)	.50	(12.6)	34.45	(875)	22.64	(575)	13.9	(6.3)
125- ▶	TR-125-80	2.95	(75)	3.15	(80)	.50	(12.6)	34.45	(875)	22.64	(575)	18.74	(8.5)

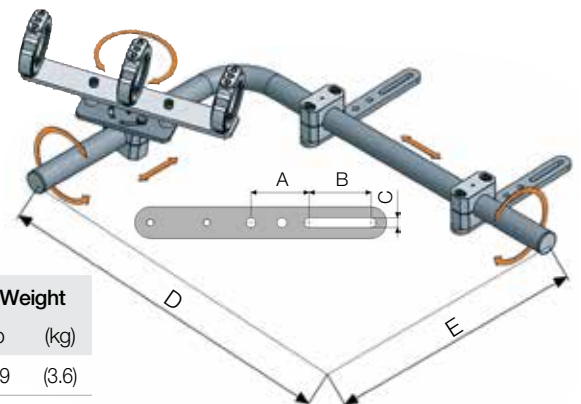

Adjustment unit for RSP and RS retraction systems

The optionally available adjustment unit is installed between the robot arm and the retraction system, and supports accurate adjustments of the assembly position of our igus® retraction systems on the robot arm. Particularly recommended when various large robots will be equipped with a uniform cable package.

Wide adjustment range
of $\pm 250\text{mm}$

Can be combined with
igus® adapter brackets

Simplifies alignment for robot
cells with restricted space

Part No. TR.907.595
weight: 11 lb.

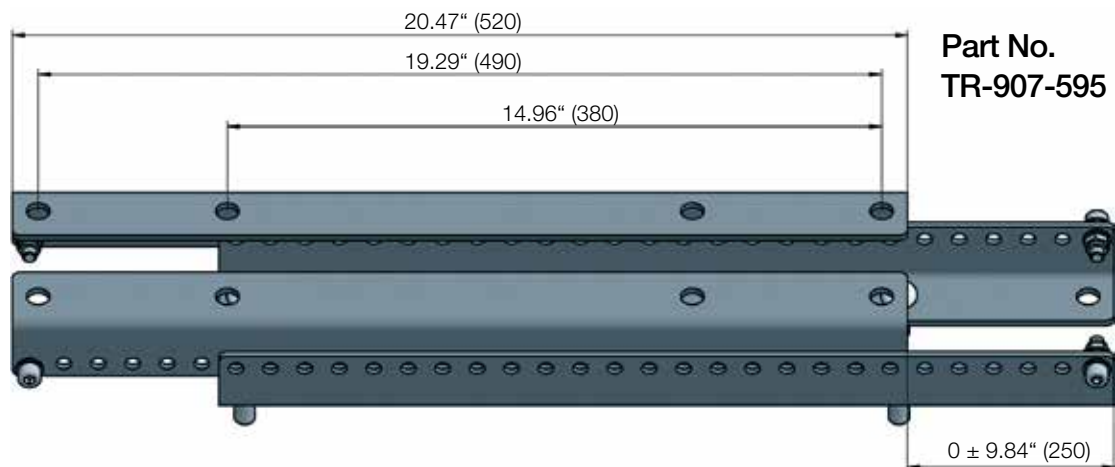
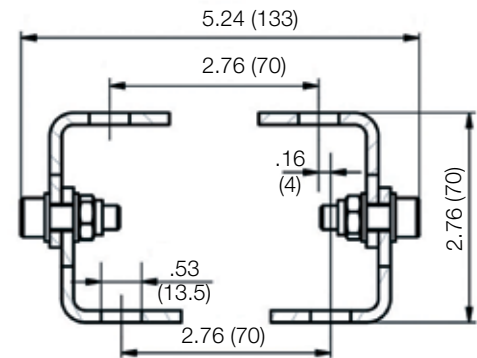

Adjustment unit to easily change the position of the retraction system

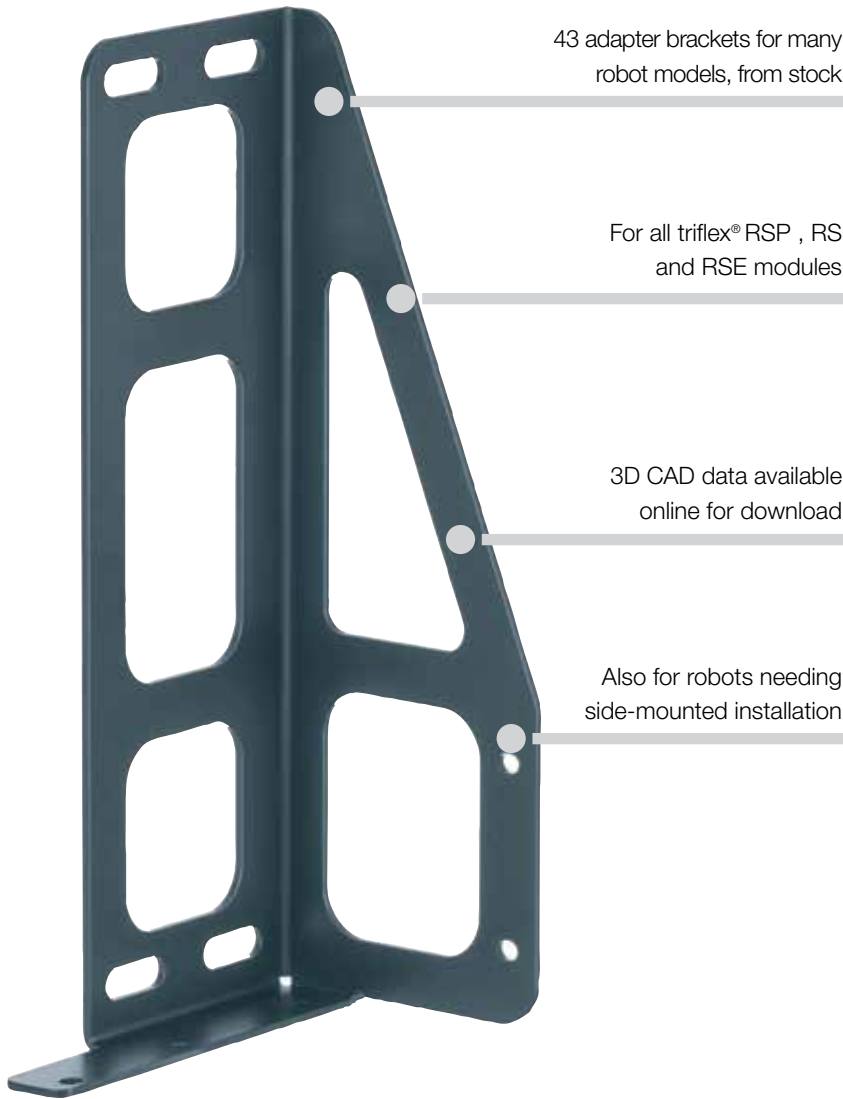

43 adapter brackets for many robot models, from stock

For all triflex® RSP , RS and RSE modules

3D CAD data available online for download

Also for robots needing side-mounted installation

Adapter brackets for RSP, RS and RSE retraction systems

The RS and RSP retraction systems provide all widely used drill patterns for attachment: 380 x 70 mm and 490 x 90 mm (in Ø12.5 mm). We also supply a wide range of manufacturer and model-dependent adapters from stock, in order to adapt to other robot variations. For example, many robot models are equipped from the factory with only side-mounted mounting options - in these cases, our adapter product range also supports simple installation of the retraction systems without additional engineering. **Adapter brackets for many robot models, from stock.**



Application example with RS system on ABB Series 6600

Adapter bracket product range - for RSE, RS & RSP

igus®
e-chain system®

Telephone 1-800-521-2747

Internet: igus.com
email: sales@igus.com
QuickSpec: igus.com/quickspec

Adapter bracket	Part No.	For manufacturer	Example for robot type		Weight (lb)		
	TR-907-347	ABB	IRB 6600 IRB 6640 IRB 6650		8.8		
	TR-907-468	ABB	IRB 6400		21.6		
	TR-907-448	ABB	IRB 4400		11		
	TR-907-381	ABB	IRB 2400/10 IRB 2400/16		11.5		
	TR-907-905	ABB	IRB 6620		6.2		
	TR-908-494	ABB	IRB 4600 IRB 2600		6.4		
	TR-907-374	Comau	NH1 130-2.6 NH3 165-2.7 NH3 220-2.7	NJ 110-3.0 NJ 110-2.6 SMART5 NJ 165 3.0	10.4		
	TR-907-447	Comau	NM 45-2.0 NM 16-3.1		7.5		
	TR-908-493	Comau	Smart six		4.9		
	TR-907-327	Motomann	UP 20 UP 50 UP 130	UP 165 ES 165 ES 200	ES 280 HP 20 HP 50	MH6 HP 165	1.9
	TR-909-641	Motomann	MH50		4.4		

More adapter brackets on request. CAD data online.

From stock for many robot types

Adapter bracket	Part No.	For manufacturer	Example for robot type		Weight (lb)
	TR-911-220	Fanuc	M-710iC 50 M-710iC 70		4.4
	TR-908-973	Fanuc	M-710iB 45		2.4
	TR-907-270	Fanuc	R-2000iB R-2000iA R-1000iA	S 430 S 420	9.9
	TR-907-470-12	Fanuc	M-900iA 260L M-900iA 350		15.0
	TR-907-902-12	Fanuc	M-900iA 600		19.6
	TR-910-876	Fanuc	M900-IB700		10.1
	TR-907-599	Kuka	KR5 KR5arc	KR6 KR16	5.5
	TR-908-113	Kuka	KR-1000		11.5
	TR-908-014	Kuka	KR 60 (HA) KR 30 (HA)		9.5
	TR-907-706	Reis	RV30-26 RV10-16 RV20-16 RV60-16	RV60-26 RV60-40 RV60-60 RV130	9.5
	Spacer pin TR-911-223	Kuka Series	Series Quantec (4 piece kit)		1.3

PDF: igus.com/e-chain-pdfs
Product information: igus.com/e-chains



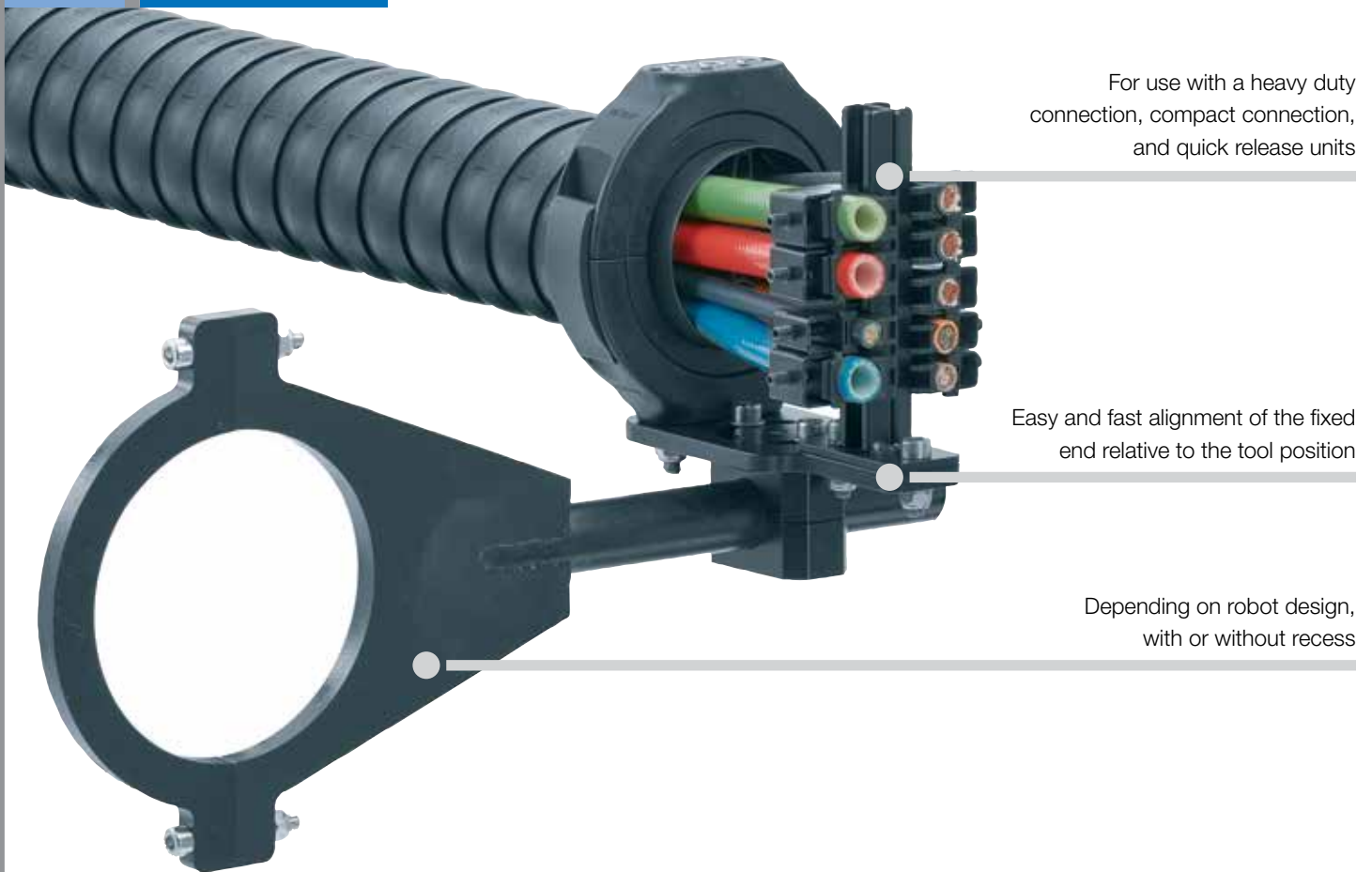

For use with a heavy duty connection, compact connection, and quick release units

Easy and fast alignment of the fixed end relative to the tool position

Depending on robot design, with or without recess

Clamps for attachment to axis 6

The clamp is used to attach a mounting bracket to axis 6, with a bar (Ø 30mm) for all robots. They are easy and quick to assemble.

- For use with heavy duty connection TR.XX.20 / TR.XX.23
- For use with compact connection TR.XX.21.01 / TR.XX.21.02
- For use with quick exchange unit TR.XX.22

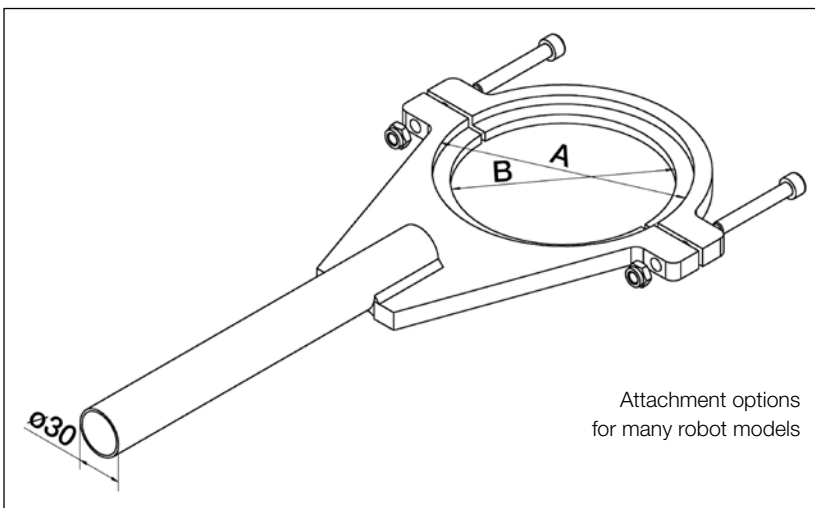

Attachment options
for many robot models



triflex® R - Accessories
triflex® RS & RSP Accessories
Axis 6 clamps - Product range



triflex®
R

Part No.	Example for robot type	Flange	Dim. A		Dim. B		Weight (lb)
			in.	(mm)	in.	(mm)	
TR-907-857	KUKA KR 30-3 (HA)	yes	5.12	(130)	4.53	(115)	4.2
	KUKA KR 60-3 (HA)	yes	5.12	(130)	4.53	(115)	4.2
	KUKA KR 60 L45-3 (HA)	yes	5.12	(130)	4.53	(115)	4.2
	KUKA KR 60 L30-3 (HA)	yes	5.12	(130)	4.53	(115)	4.2
TR-907-901	KUKA Quantec, large flange	yes	8.07	(205)	7.48	(190)	5.5
	KUKA KR 125/3	yes	8.07	(205)	7.48	(190)	5.5
	KUKA KR 150/3	yes	8.07	(205)	7.48	(190)	5.5
	KUKA KR 200/3	yes	8.07	(205)	7.48	(190)	5.5
	KUKA KR 360/1	yes	8.07	(205)	7.48	(190)	5.5
	KUKA KR 500/1	yes	8.07	(205)	7.48	(190)	5.5
	KUKA KR 150/2 Series 2000	yes	8.07	(205)	7.48	(190)	5.5
	KUKA KR 180/2 Series 2000	yes	8.07	(205)	7.48	(190)	5.5
	KUKA KR 210/2 Series 2000	yes	8.07	(205)	7.48	(190)	5.5
TR-908-115	KUKA KR 1000 Titan	yes	9.84	(250)	9.53	(242)	6.7
TR-907-992	Fanuc R-2000iB	yes	6.50	(165)	6.30	(160)	5.3
	Fanuc R-2000iA	yes	6.50	(165)	6.30	(160)	5.3
	Reis RV 130	yes	6.50	(165)	6.30	(160)	5.3
TR-908-065	Fanuc M-710iC 50	yes	5.12	(130)	4.88	(124)	4.9
	Fanuc M-710iC 70	yes	5.12	(130)	4.88	(124)	4.9
TR-909-387	Motoman UP 50	yes	4.92	(125)	3.94	(100)	4.2
	Motoman HP 50	yes	4.92	(125)	3.94	(100)	4.2
	Motoman MH 50	yes	4.92	(125)	3.94	(100)	4.2
TR-910-544	Reis RV60-60	yes	5.71	(145)	4.92	(125)	4.2
	Reis RV60-40	yes	5.71	(145)	4.92	(125)	4.2
	Fanuc R-1000	yes	5.71	(145)	4.92	(125)	4.2
TR-908-347	Stäubli TX200	yes	5.71	(145)	4.92	(125)	4.2
TR-907-667-125	for custom flange	no	4.92	(125)	= A	= A	4.6
TR-907-667-140	KUKA Quantec small flange	no	5.51	(140)	= A	= A	10.8
TR-907-667-142	Hyundai HX 165	no	5.59	(142)	= A	= A	5.0
TR-907-667-150	Comau NJ 130	no	5.91	(150)	= A	= A	5.3
TR-907-667-160	ABB IRB 6400	no	6.30	(160)	= A	= A	5.4
	Fanuc S420	no	6.30	(160)	= A	= A	5.4
TR-907-667-180	for custom flange	no	7.09	(180)	= A	= A	5.6
TR-907-667-190	Comau NH3	no	7.48	(190)	= A	= A	5.7
TR-907-667-200	KUKA KR 125/1	no	7.87	(200)	= A	= A	6.0
	KUKA KR 150/1	no	7.87	(200)	= A	= A	6.0
	KUKA KR 200/1	no	7.87	(200)	= A	= A	6.0
	ABB IRB 6640	no	7.87	(200)	= A	= A	6.0
	ABB IRB 6620	no	7.87	(200)	= A	= A	6.0
	ABB IRB 6650	no	7.87	(200)	= A	= A	6.0
TR-907-667-220	KUKA KR 360-2	no	8.66	(220)	= A	= A	6.2
	KUKA KR 500-2	no	8.66	(220)	= A	= A	6.2
	KUKA KR 360-3	no	8.66	(220)	= A	= A	6.2
	KUKA KR 500-3	no	8.66	(220)	= A	= A	6.2
TR-907-667-223	ABB IRB 7600-340	no	8.78	(223)	= A	= A	7.7
	ABB IRB 7600-500	no	8.78	(223)	= A	= A	7.7
TR-907-667-250	Fanuc M900iA 350	no	9.84	(250)	= A	= A	7.1
	Fanuc M900iA 260L	no	9.84	(250)	= A	= A	7.1
TR-907-667-275	Fanuc M900iA 200P	no	10.83	(275)	= A	= A	7.5
TR-907-667-315	Fanuc M900iA 600	no	12.40	(315)	= A	= A	7.9
	Fanuc M900iA 400L	no	12.40	(315)	= A	= A	7.9

Other sizes available on request!



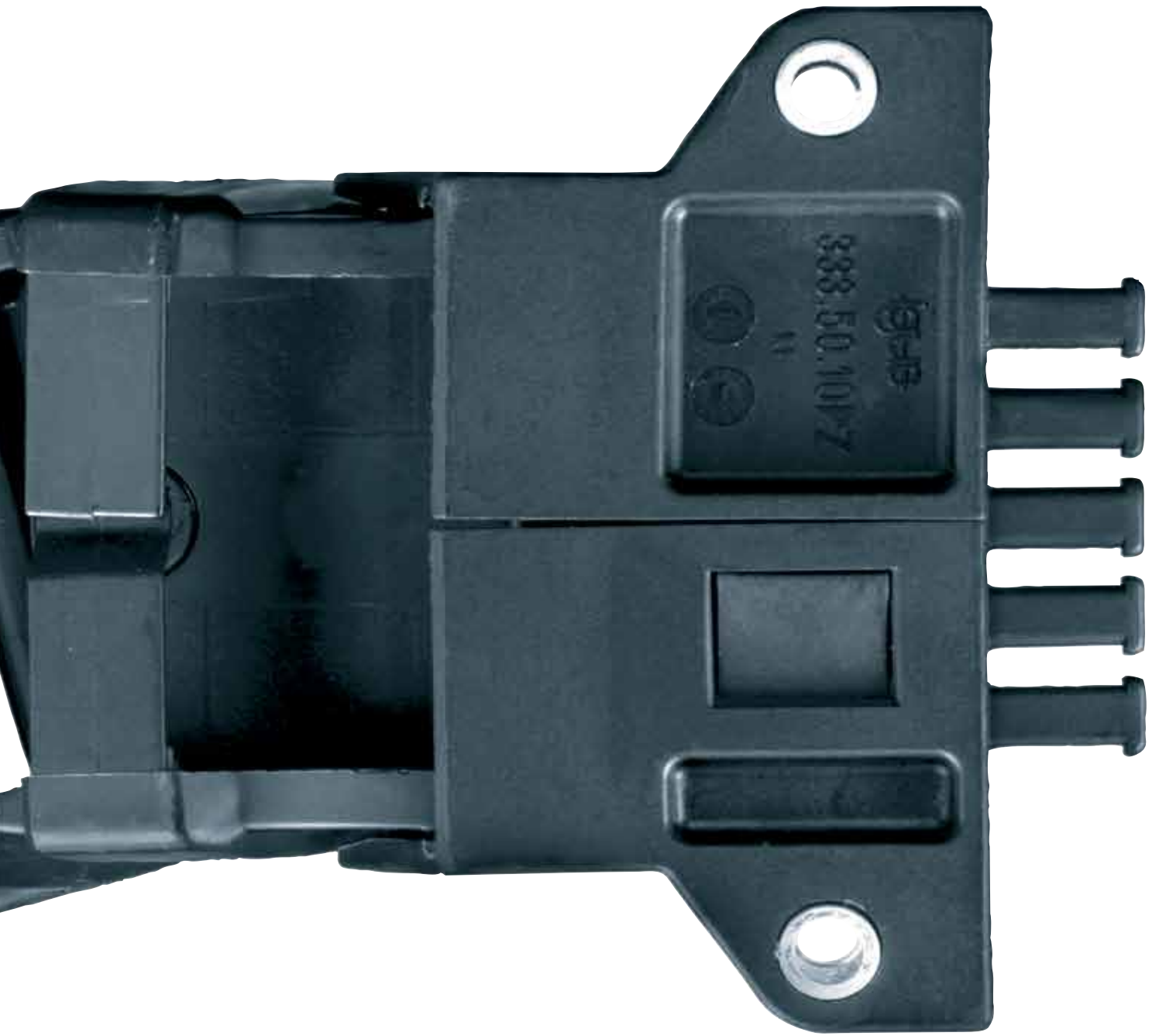

igus[®]
E-Z triflex[®]

E-Z triflex® - for 2D and 3D movements, easy access to cable from both sides

The triflex® series has been developed to safely guide cables through a 3D movement. With E-Z triflex®, the installation of cables and hoses is easy. Cables can be inserted into the e-chain® from the top or bottom through an opening along the length of the chain. The unique modular design of triflex® enables very complex movements through all three axes.

Typical industries and applications

- Machine Tools
- Robots
- Material handling
- Plastics machinery
- Construction machines
- Vehicles
- General machinery
- Medical equipment



iF-Design awards for
Easy triflex®-design



Torsional motion
possible



UL94-V2
classifications



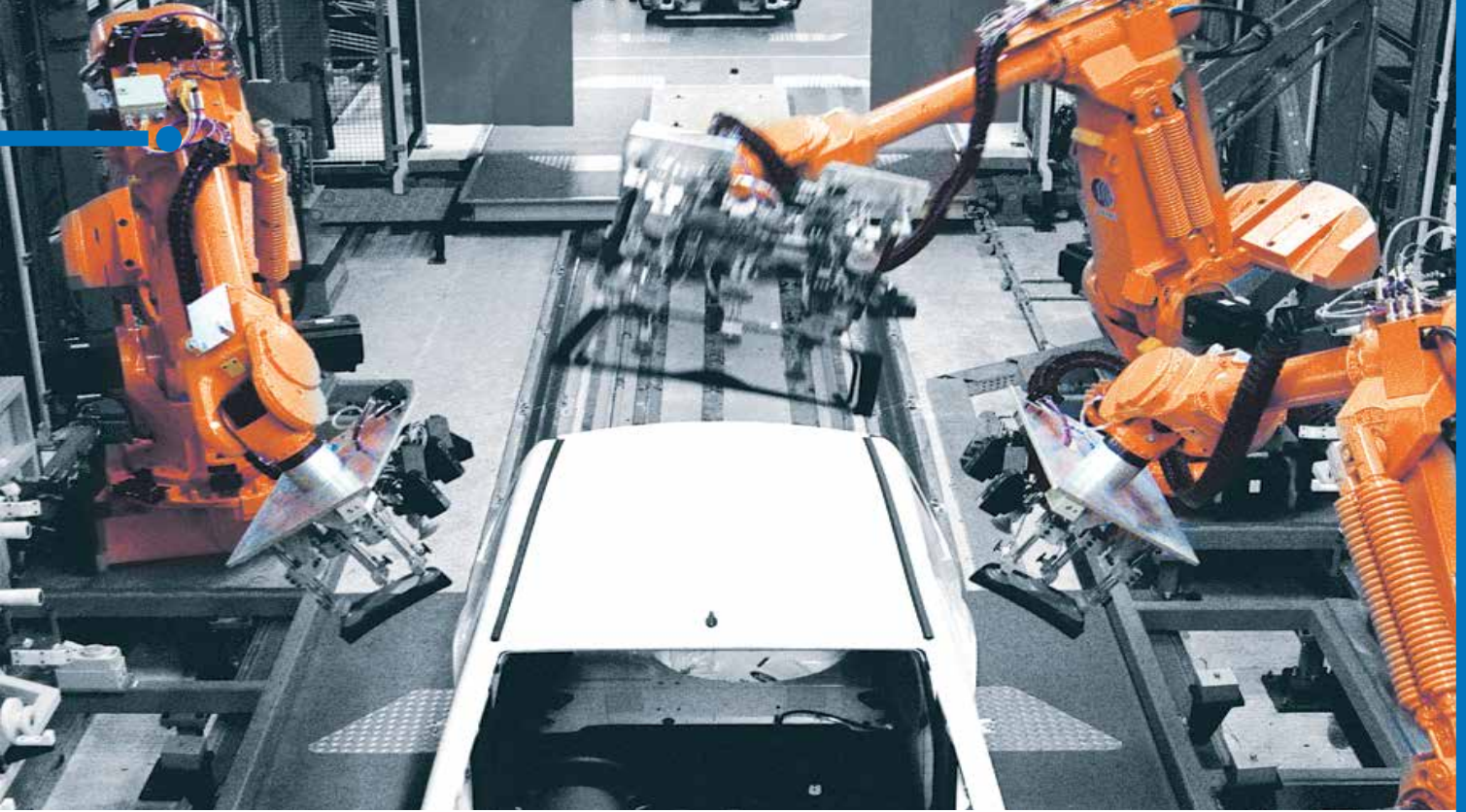

Robots with igus® E-Z triflex® e-chains® on an assembly line



E-Z triflex® e-chains® for multi-dimensional movements on a production line



E-Z triflex® e-chains® also for easy applications - here an aesthetic application

E-Z triflex® - The Solution for Your Office

Dangling lines are risky and unaesthetic. The new solution: E-Z triflex® and triflex® e-chains® with special connector elements for your desk. They offer reliable, movable and elegant protection for lines, are quickly installed and are available in many variations. Naturally they can be installed at any time as retrofits. Simply press the lines from two sides. This is possible at any point desired.

e-chain system® E-Z triflex® Series

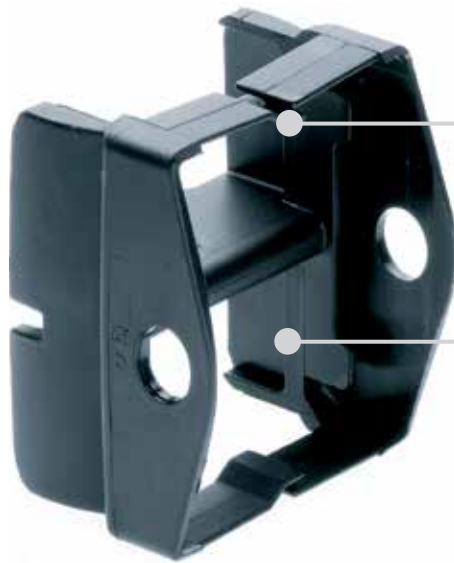

E-Z Chain®
design -
simply press
cables in

Material
igumid NB -
UL94-V2
classification

Select this modular e-chain system® for:

- 3-axis motions in all kinds of machinery
- Some robotics applications
- Very fast cable assembly with “E-Z” design
- Simple filling from two sides
- Where rectangular shapes fit better
- Combination of different bending radii and movement directions
- Lengthen and shorten anywhere
- KMA mounting brackets with integrated strain relief
- You can find more technical data about the material, chemical resistance, temperatures ► **Design, Chapter 1**

Selection table

Single-axis and double-axis movement:

Series	Inner Height		Inner Width		Outer height/Outer Width		Bending Radii	
	<i>Bi 1/Bi 2</i>		<i>Bi 3</i>		<i>Ba</i>		<i>R</i>	
	in.	(mm)	in.	(mm)	in.	(mm)	in.	(mm)
E331-25	.51	(13)	.98	(25)	1.34	(34)	1.89 - 7.87	(048 - 200)
E331-32	.69	(17.5)	1.26	(32)	1.97	(50)	2.95 - 9.84	(075 - 250)
E331-50	1.02	(26)	1.97	(50)	2.68	(68)	3.94 - 9.84	(100 - 250)
E331-75	1.52	(38.5)	2.95	(75)	3.78	(96)	5.51 - 11.81	(140 - 300)

Single-axis and double-axis movement:

Series	Inner Height		Inner Width		Outer height/Outer Width		Bending Radii	
	<i>Bi 1/Bi 2</i>		<i>Bi 3</i>		<i>Ba</i>		<i>R</i>	
	in.	(mm)	in.	(mm)	in.	(mm)	in.	(mm)
E332-25	.51	(13)	.98	(25)	1.34	(34)	1.89 - 7.87	(048 - 200)
E332-32	.69	(17.5)	1.26	(32)	1.97	(50)	2.95 - 9.84	(075 - 250)
E332-50	1.02	(26)	1.97	(50)	2.68	(68)	3.94 - 9.84	(100 - 250)
E332-75	1.52	(38.5)	2.95	(75)	3.78	(96)	5.51 - 11.81	(140 - 300)

Triple-axis movement

Series	Inner Height		Inner Width		Outer height/Outer Width		Bending Radii	
	<i>Bi 1/Bi 2</i>		<i>Bi 3</i>		<i>Ba</i>		<i>R</i>	
	in.	(mm)	in.	(mm)	in.	(mm)	in.	(mm)
E333-25	.51	(13)	.98	(25)	1.34	(34)	1.89 - 7.87	(048 - 200)
E333-32	.69	(17.5)	1.26	(32)	1.97	(50)	2.95 - 9.84	(075 - 250)
E333-50	1.02	(26)	1.97	(50)	2.68	(68)	3.94 - 9.84	(100 - 250)
E333-75	1.52	(38.5)	2.95	(75)	3.78	(96)	5.51 - 11.81	(140 - 300)



Available from stock. Orders ship as early as today.*

*On average 90% of orders ship the same day..

e-chain system® E-Z triflex® Series

E-Z triflex® Series - Assembling



1
Twist and snap in

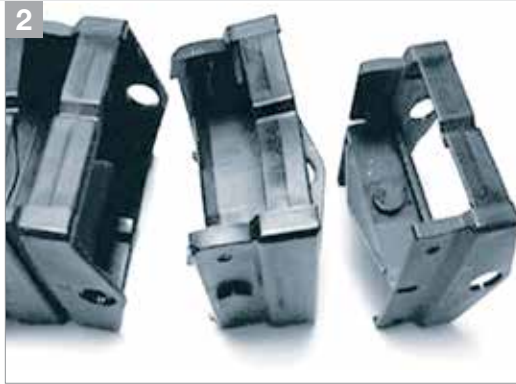

2
Shorten and lengthen
at any given point

E-Z triflex® Series - Separating



1
Lever the E-Z triflex®
side link with screwdriver



2
Twist and separate - For Series E333
you have to separate the "middle" pin

E-Z triflex® Series - Filling



1
Easy to fill - simply press cables in...



2
...and easy to take the cables out

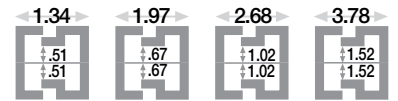

Price Index

Flammability Class
VDE 0304 IIC UL94 V2

Torsion motion possible



iF-Design Award Winner

Assembly Tips



Easy to fill - simply press cables in



- If simple cable installation is required with complex movements
- If simple cable installation from both sides with complex movements is required
- For repair and supplementation of existing triflex® Systems



- For circular movements with high loads
 - twisterchain® System, from **Chapter 8**
- If chip protection is necessary
 - triflex® System, from **Chapter 8**

Features & Benefits

- 1 KMA split-open mounting bracket with integrated strain relief
- 2 Patented "push-button-design"
- 3 iF-Design Award Winner
- 4 Different bending radii and directions can be combined
- 5 Robotics applications possible
- 6 Shorten and lengthen at any given point
- 7 3-Axis motions in machinery of all kinds
- 8 Simple filling from 2 sides "E-Z Chain®"-design - simply press in cable along the inner radius or the outer radius

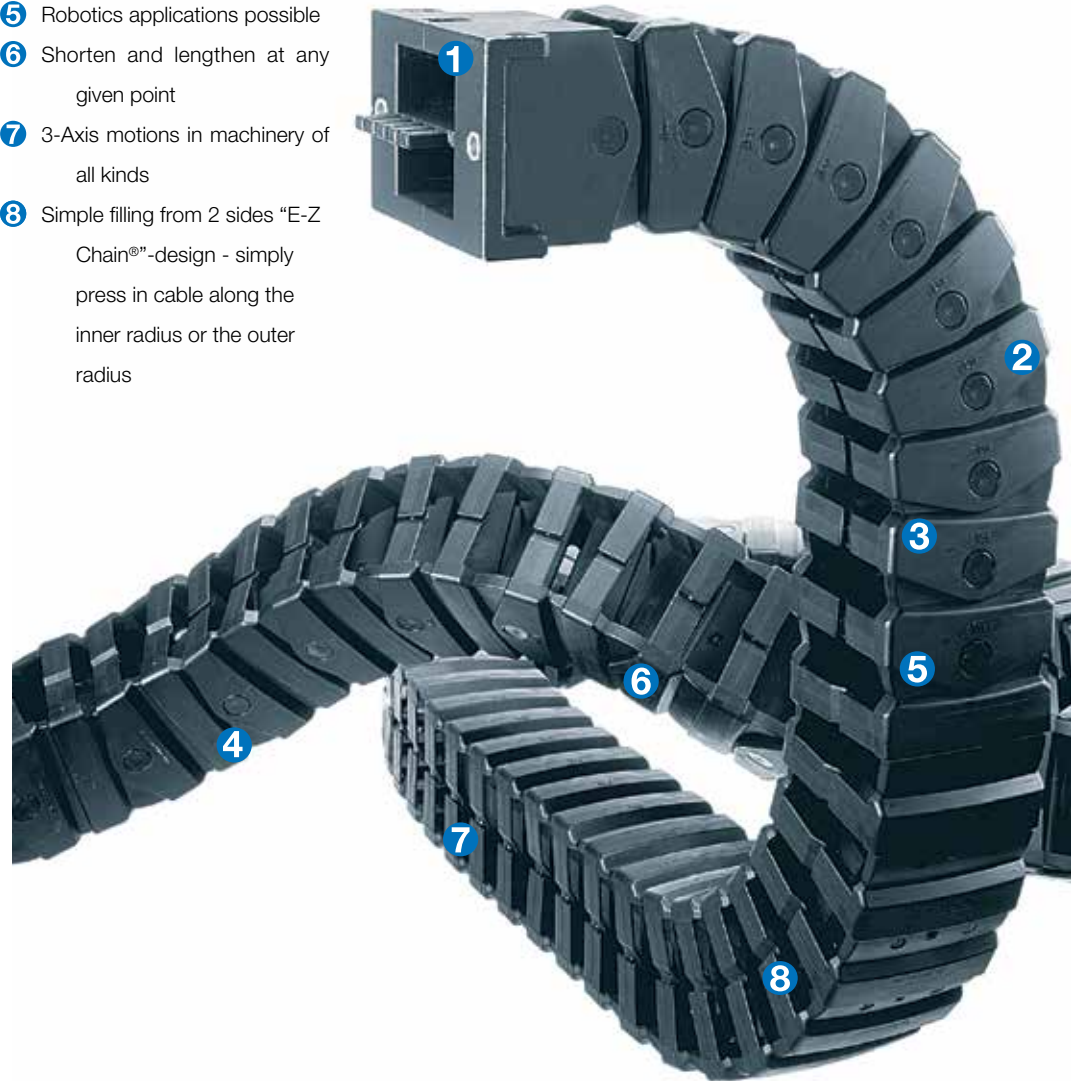

Order Example: Complete e-chain®

Please indicate chain length or number of links. Example:

6.56 ft (2 m) **E333-50-100/100-0**

e-chain®

1 Set **333-50-12PZ**

Mounting Bracket

Technical Data



Details of material properties

➤ **Chapter 1**

Material - permitted temperature

igumid NB / -40°F (-40°C) up to +176°F (+80° C)

Flammability Class, igumid NB

VDE 0304 IIC UL94 V2

Single Axis Movement, Series E331

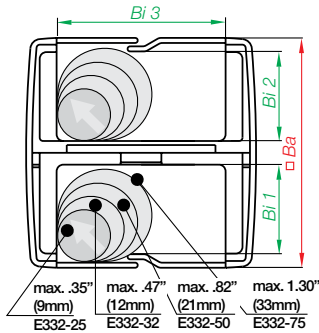

Part No. structure

E331-	50-2-	100-	0
-------	-------	------	---

- Color - black
- Bending radius
- Width
- Series

Part No.	Bi 1	Bi 2	Bi 3	Ba
E331-25-2- <input type="text"/> -0	.51 (13)	.51 (13)	.98 (25)	1.34 (34)
E331-32-2- <input type="text"/> -0	.69 (17.5)	.69 (17.5)	1.26 (32)	1.97 (50)
E331-50-2- <input type="text"/> -0	1.02 (26)	1.02 (26)	1.97 (50)	2.68 (68)
E331-75-2- <input type="text"/> -0	1.52 (38.5)	1.52 (38.5)	2.95 (75)	3.78 (96)

Supplement part number with required radius from below
for example E331-50-2--0

Installation dimensions for single-axis movement

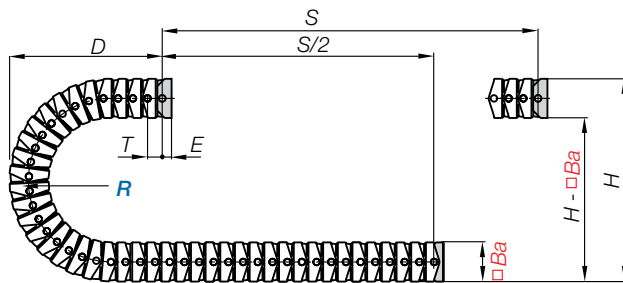

For center mount applications:
Chain length = $\frac{S}{2} + K$

Legend

- S = Length of travel
- R = Bending radius
- H = Nominal clearance height
- D = Overlength e-chain® radius in final position
- K = $\pi \cdot R +$ "safety buffer"

Series E331-25-2--0

R	1.89 (048)	2.95 (075)	3.94 (100)	4.92 (125)	5.91 (150)	6.89 (175)	7.87 (200)
H	5.12 (130)	7.28 (185)	9.25 (235)	11.22 (285)	13.19 (335)	15.15 (385)	17.13 (435)
D	3.74 (95)	4.92 (125)	5.91 (150)	6.89 (175)	7.87 (200)	8.86 (225)	9.84 (250)
K	7.68 (195)	11.02 (280)	14.17 (360)	17.32 (440)	20.28 (515)	23.43 (595)	26.57 (675)

Pitch = .57 (14.5 mm)
Links/ft (m) = 21.03 (69)
Dimensions E = .39 (10 mm)
Ba = 1.34 (34 mm)

Series E331-32-2--0

R	2.95 (075)	3.94 (100)	4.92 (125)	5.91 (150)	7.87 (200)	9.84 (250)
H	7.87 (200)	9.84 (250)	11.81 (300)	13.78 (350)	17.72 (450)	21.65 (550)
D	5.12 (130)	6.10 (155)	7.09 (180)	8.07 (205)	10.04 (255)	12.01 (305)
K	12.01 (305)	15.15 (385)	18.30 (465)	21.46 (545)	27.56 (700)	34.06 (865)

Pitch = .98 (25 mm)
Links/ft (m) = 12.24 (40)
Dimensions E = .79 (20 mm)
Ba = 1.97 (50 mm)

Series E331-50-2--0

R	3.94 (100)	4.92 (125)	5.91 (150)	7.87 (200)	9.84 (250)
H	10.63 (270)	12.60 (320)	14.76 (375)	18.50 (470)	22.44 (570)
D	7.68 (195)	8.66 (220)	9.65 (245)	11.61 (295)	13.58 (345)
K	17.13 (435)	20.47 (520)	23.23 (590)	29.53 (750)	35.83 (910)

Pitch = 1.18 (30 mm)
Links/ft (m) = 10.17 (34)
Dimensions E = .98 (25 mm)
Ba = 2.68 (68 mm)

Series E331-75-2--0

R	5.51 (140)	6.89 (175)	7.87 (200)	9.84 (250)	11.81 (300)
H	14.96 (380)	17.71 (450)	19.69 (500)	23.62 (600)	27.56 (700)
D	9.45 (240)	10.83 (275)	11.81 (300)	13.78 (350)	15.75 (400)
K	21.65 (550)	25.98 (660)	29.13 (740)	35.43 (900)	41.73 (1060)

Pitch = 1.42 (36 mm)
Links/ft (m) = 8.45 (28)
Dimensions E = .98 (25 mm)
Ba = 3.78 (96 mm)



Double Axis Movement, Series E332

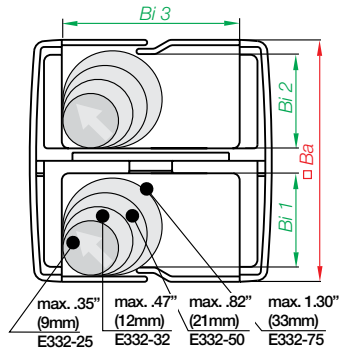

Part No. structure

E332-	75-2-	200-	0
-------	-------	------	---

- Color - black
- Bending radius
- Width
- Series

Part No.	Bi 1	Bi 2	Bi 3	Ba
E332-25-2- <input type="text"/> -0	.51 (13)	.51 (13)	.98 (25)	1.34 (34)
E332-32-2- <input type="text"/> -0	.69 (17.5)	.69 (17.5)	1.26 (32)	1.97 (50)
E332-50-2- <input type="text"/> -0	1.02 (26)	1.02 (26)	1.97 (50)	2.68 (68)
E332-75-2- <input type="text"/> -0	1.52 (38.5)	1.52 (38.5)	2.95 (75)	3.78 (96)

Supplement part number with required radius from below
for example, E332-75-2--0

Installation dimensions for double-axis movement

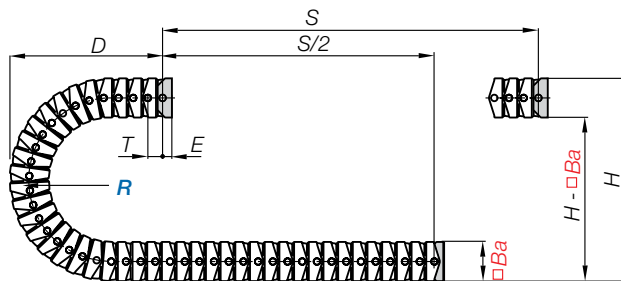

Legend

- S = Length of travel
- R = Bending radius
- H = Nominal clearance height
- D = Overlength e-chain® radius in final position
- K = $\pi \cdot R$ + "safety buffer"

Series E332-25-2--0

R	1.89 (048)	2.95 (075)	3.94 (100)	4.92 (125)	5.91 (150)	6.89 (175)	7.87 (200)
H	5.12 (130)	7.28 (185)	9.25 (235)	11.22 (285)	13.19 (335)	15.15 (385)	17.13 (435)
D	3.74 (95)	4.92 (125)	5.91 (150)	6.89 (175)	7.87 (200)	8.86 (225)	9.84 (250)
K	7.68 (195)	11.02 (280)	14.17 (360)	17.32 (440)	20.28 (515)	23.43 (595)	26.57 (675)

Pitch = .57 (14.5 mm)
Links/ft (m) = 21.03 (69)
Dimensions E = .39 (10 mm)
Ba = 1.34 (34 mm)

Series E332-32-2--0

R	2.95 (075)	3.94 (100)	4.92 (125)	5.91 (150)	7.87 (200)	9.84 (250)
H	7.87 (200)	9.84 (250)	11.81 (300)	13.78 (350)	17.72 (450)	21.65 (550)
D	5.12 (130)	6.10 (155)	7.09 (180)	8.07 (205)	10.04 (255)	12.01 (305)
K	12.01 (305)	15.15 (385)	18.30 (465)	21.46 (545)	27.56 (700)	34.06 (865)

Pitch = .98 (25 mm)
Links/ft (m) = 12.24 (40)
Dimensions E = .79 (20 mm)
Ba = 1.97 (50 mm)

Series E332-50-2--0

R	3.94 (100)	4.92 (125)	5.91 (150)	7.87 (200)	9.84 (250)
H	10.63 (270)	12.60 (320)	14.76 (375)	18.50 (470)	22.44 (570)
D	7.68 (195)	8.66 (220)	9.65 (245)	11.61 (295)	13.58 (345)
K	17.13 (435)	20.47 (520)	23.23 (590)	29.53 (750)	35.83 (910)

Pitch = 1.18 (30 mm)
Links/ft (m) = 10.17 (34)
Dimensions E = .98 (25 mm)
Ba = 2.68 (68 mm)

Series E332-75-2--0

R	5.51 (140)	6.89 (175)	7.87 (200)	9.84 (250)	11.81 (300)
H	14.96 (380)	17.71 (450)	19.69 (500)	23.62 (600)	27.56 (700)
D	9.45 (240)	10.83 (275)	11.81 (300)	13.78 (350)	15.75 (400)
K	21.65 (550)	25.98 (660)	29.13 (740)	35.43 (900)	41.73 (1060)

Pitch = 1.42 (36 mm)
Links/ft (m) = 8.45 (28)
Dimensions E = .98 (25 mm)
Ba = 3.78 (96 mm)

Triple Axis Movement, Series E333

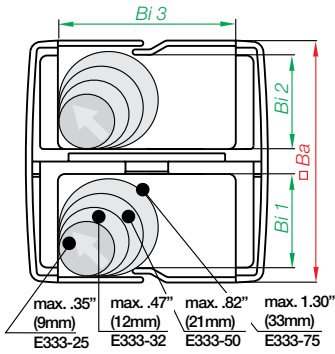

Part No. structure

E333-	50-	100-	0
-------	-----	------	---

- Color - black
- Bending radius
- Width
- Series

Part No.	Bi 1	Bi 2	Bi 3	Ba
E333-25- <input type="text"/> -0	.51 (13)	.51 (13)	.98 (25)	1.34 (34)
E333-32- <input type="text"/> -0	.69 (17.5)	.69 (17.5)	1.26 (32)	1.97 (50)
E333-50- <input type="text"/> -0	1.02 (26)	1.02 (26)	1.97 (50)	2.68 (68)
E333-75- <input type="text"/> -0	1.52 (38.5)	1.52 (38.5)	2.95 (75)	3.78 (96)

Supplement part number with required radius from above
for example, E333-32-100-0

Installation dimensions for triple-axis movement

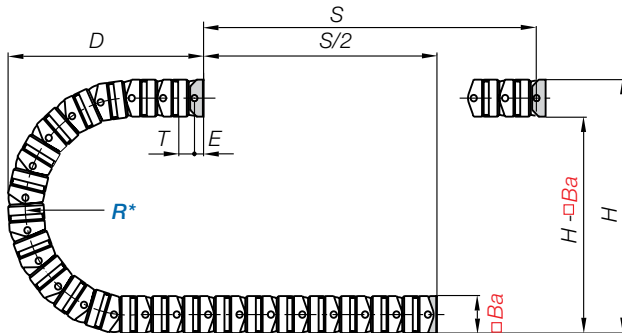

For center mount applications:
Chain length = $S/2 + K$

* The bending radii are doubled in the case of the Series E333 e-chain®

Legend

- S = Length of travel
- R = Bending radius
- H = Nominal clearance height
- D = Overlength e-chain® radius in final position
- $K = \pi \cdot R + \text{"safety buffer"}$

Series E333-25--0

R	3.78 (96)	5.91 (150)	7.87 (200)	9.84 (250)	11.81 (300)	13.78 (350)	15.75 (400)
H	9.06 (230)	13.19 (335)	17.13 (435)	21.06 (535)	25.00 (635)	28.94 (735)	32.87 (835)
D	5.71 (145)	7.87 (200)	9.84 (250)	11.81 (300)	13.78 (350)	15.75 (400)	17.72 (450)
K	13.78 (350)	20.28 (515)	26.57 (675)	32.68 (830)	38.98 (990)	45.28 (1150)	51.18 (1300)

Pitch = .57 (14.5 mm)
Links/ft (m) = 21.03 (69)
Dimensions E = .39 (10 mm)
Ba = 1.34 (34 mm)

Series E333-32--0

R	5.91 (150)	7.87 (200)	9.84 (250)	11.81 (300)	15.75 (400)	19.69 (500)
H	13.78 (350)	17.72 (450)	21.65 (550)	25.59 (650)	33.46 (850)	41.33 (1050)
D	8.07 (205)	10.04 (255)	12.01 (305)	13.98 (355)	17.91 (455)	21.85 (555)
K	21.46 (545)	27.56 (700)	33.86 (860)	40.16 (1020)	51.18 (1300)	63.19 (1605)

Pitch = .98 (25 mm)
Links/ft (m) = 12.24 (40)
Dimensions E = .79 (20 mm)
Ba = 1.97 (50 mm)

Series E333-50--0

R	7.87 (200)	9.84 (250)	11.81 (300)	15.75 (400)	19.69 (500)
H	18.50 (470)	22.44 (570)	26.38 (670)	34.25 (870)	42.13 (1070)
D	11.61 (295)	13.58 (345)	15.55 (395)	19.49 (495)	23.42 (595)
K	29.53 (750)	35.83 (910)	42.13 (1070)	54.33 (1380)	66.54 (1690)

Pitch = 1.18 (30 mm)
Links/ft (m) = 10.17 (34)
Dimensions E = .98 (25 mm)
Ba = 2.68 (68 mm)

Series E333-75--0

R	11.02 (280)	13.78 (350)	15.75 (400)	19.69 (500)	23.62 (600)
H	25.98 (660)	31.50 (800)	35.43 (900)	43.31 (1100)	51.18 (1300)
D	14.96 (380)	17.72 (450)	19.69 (500)	23.62 (600)	27.56 (700)
K	38.98 (990)	47.64 (1210)	55.12 (1400)	66.93 (1700)	78.74 (2000)

Pitch = 1.42 (36 mm)
Links/ft (m) = 8.45 (28)
Dimensions E = .98 (25 mm)
Ba = 3.78 (96 mm)



Mounting Brackets

Option 1: KMA

- Corrosion resistant
- Strain relief with tie-wrap plate

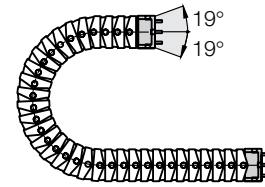

333-50-1PZB
Moving end
with tie-wrap plate

333-50-2PZB
Fixed end
(with tie-wrap plate
333-50-ZB)

333-50-1PZ

333-50-2PZB

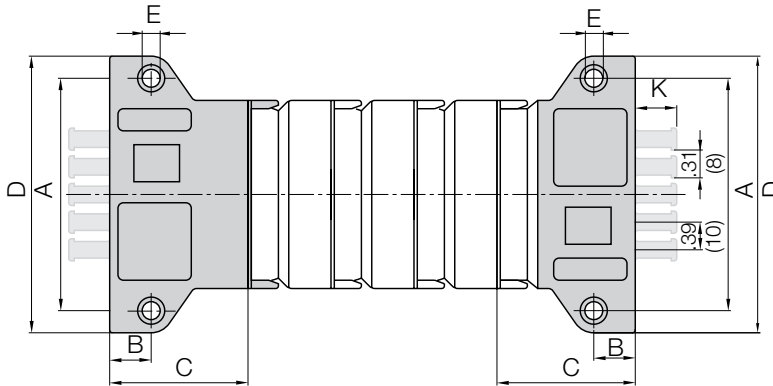

For high loads we recommend screwing the mounting brackets to the chain. If you have any questions, please give us a call.

Part No. structure

333-32-12 PZB

With assembled strain relief tie-wrap plates

Full set = 12

Mounting brackets for selected chain type

Full set, for both ends:

333-32-12 PZB + tie-wrap plate

Single-part order:

333-32-1 PZB + tie-wrap plate

Mounting bracket with bore

333-32-2 PZB + tie-wrap plate

Mounting bracket with pin

Series	Part No. without tie-wrap plate	Part No. with tie-wrap plate	A	B	C	D	E	K	N No. of Teeth
E331-25/E332-25-2/E333-25	333-25-12PZ	333-25-12PZB	1.69 (43)	.28 (7)	.87 (22)	2.04 (52)	.18 (4.5)	—	—
E331-32/E332-32-2/E333-32	333-32-12PZ	333-32-12PZB	2.60 (66)	.59 (15)	1.81 (46)	3.23 (82)	.26 (6.5)	.59 (15)	3
E331-50/E332-50-2/E333-50	333-50-12PZ	333-50-12PZB	3.31 (84)	.59 (15)	1.97 (50)	3.94 (100)	.26 (6.5)	.59 (15)	5
E331-75/E332-75-2/E333-75	333-75-12PZ	333-75-12PZB	4.29 (109)	.59 (15)	2.17 (55)	4.92 (125)	.26 (6.5)	.59 (15)	7

Mounting Brackets

Option 2: flange

- Galvanized steel
- Electrically conductive
- Flush mounting



330-25-1 – 330-75-1

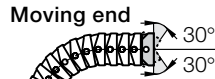

330-25-2 – 330-75-2

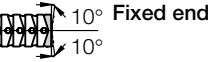

Part No. structure

330-	25-	12
------	-----	----

Full set = 12

Width

Mounting brackets for selected chain type

330-25-2 – 330-75-2



330-25-1 – 330-75-1

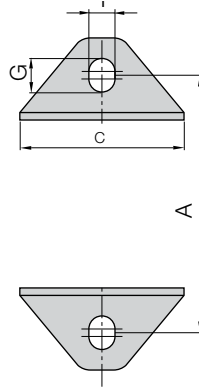

Full set, 4 parts

2 with pin / 2 with bore:

330-25-12

Single-part order:

330-25-1

Mounting bracket with bore

330-25-2

Mounting bracket with pin

Series	Part No.	A	M	C	L	T	E	F	G
E331-25/E332-25-2/E333-25	330-25-12	1.73 (44)	2.17 (55)	1.14 (29)	2.17 (55)	.06 (1.5)	.41 (10.5)	.26 (6.5)	.35 (9)
E331-32/E332-32-2/E333-32	330-32-12	2.60 (66)	3.31 (84)	1.73 (44)	3.46 (88)	.08 (2)	.79 (20)	.28 (7)	.35 (9)
E332-50/E332-50-2/E333-50	330-50-12	3.31 (84)	4.02 (102)	2.44 (62)	4.17 (106)	.08 (2)	.98 (25)	.28 (7)	.35 (9)
E331-75/E332-75-2/E333-75	330-75-12	4.29 (109)	5.00 (127)	3.54 (90)	5.16 (131)	.08 (2)	.98 (25)	.28 (7)	.35 (9)

Option 3: angle

- Galvanized steel
- Electrically conductive
- Can be attached to top or bottom of the machine



338-25-1/ 338-75-1

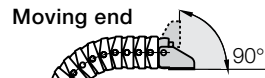

338-25-2 / 338-75-2

Fixed end

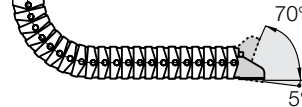

Part No. structure

338-	25-	12
------	-----	----

Full set = 12

Width

Mounting brackets for selected chain type

338-25-2 / 338-75-2

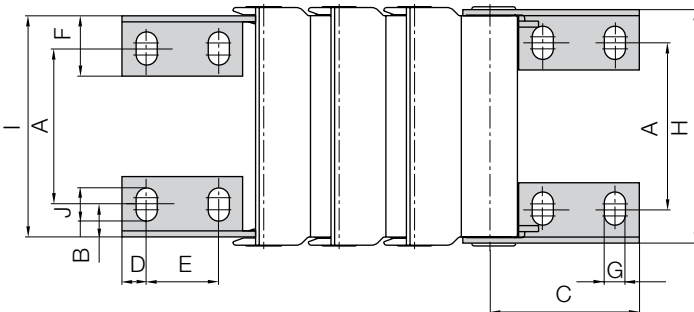

338-25-1 / 338-75-1

Full set, 4 parts

2 with pin / 2 with bore:

338-25-12

Single-part order:

338-25-1

Mounting bracket with bore

338-25-2

Mounting bracket with pin

Series	Part No.	A	B	C	D	E	F	G	H	I	J
E331-25/E332-25-2/E333-25	338-25-12	.67 (17)	.25 (6.25)	1.10 (28)	.24 (6)	.63 (16)	.55 (14)	.22 (5.5)	1.33 (33.8)	1.22 (31)	.33 (8.5)
E331-32/E332-32-2/E333-32	338-32-12	.94 (24)	.22 (5.5)	1.85 (47)	.31 (8)	.94 (24)	.79 (20)	.28 (7)	1.93 (49)	1.77 (45)	.43 (11)
E331-50/E332-50-2/E333-50	338-50-12	1.65 (42)	.22 (5.5)	3.03 (77)	.47 (12)	1.38 (35)	.94 (24)	.35 (9)	2.64 (67)	2.44 (62)	.59 (15)
E331-75/E332-75-2/E333-75	338-75-12	2.56 (65)	.22 (5.5)	3.03 (77)	.47 (12)	1.38 (35)	.94 (24)	.35 (9)	3.74 (95)	3.54 (90)	.59 (15)





igus[®] triflex[®]



triflex® - fully enclosed, for 2D and 3D applications

The triflex® series has been developed to safely guide cables during a 3D movement. In this case, the flexibility of a hose is combined with the stability of an e-chain® with a fixed, defined radius. This unique modular range enables very complex movements. As example: Combination of chain links moving in single, double and triple axes in an e-chain®.

Typical industries and applications

- Machine tools
- Robots
- Handling equipment
- Material handling
- Plastics machinery
- Construction machines
- Vehicles
- Machinery of all kinds
- Medical equipment



iF-Design awards for
1992 igus® series triflex®



Torsional motion
possible

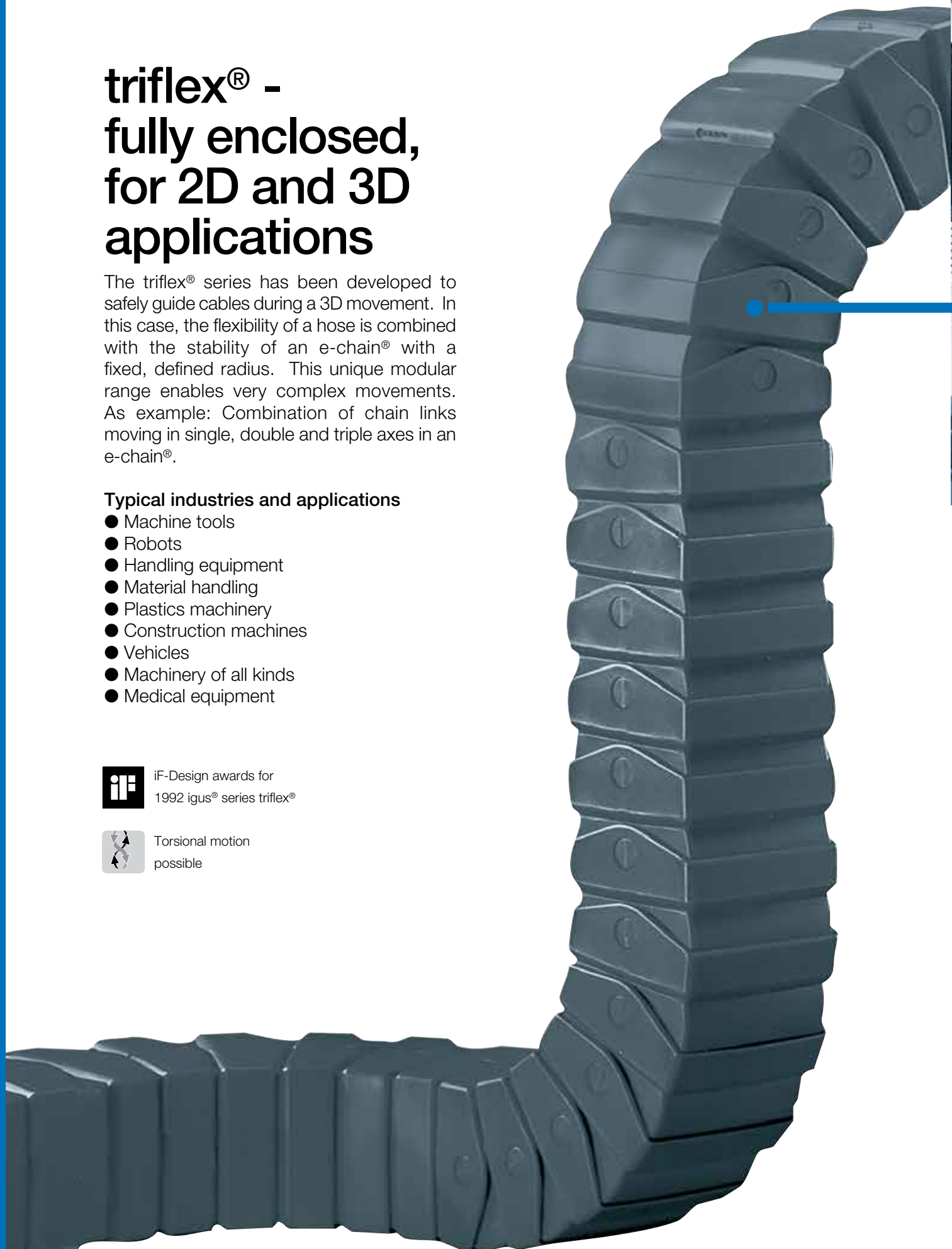

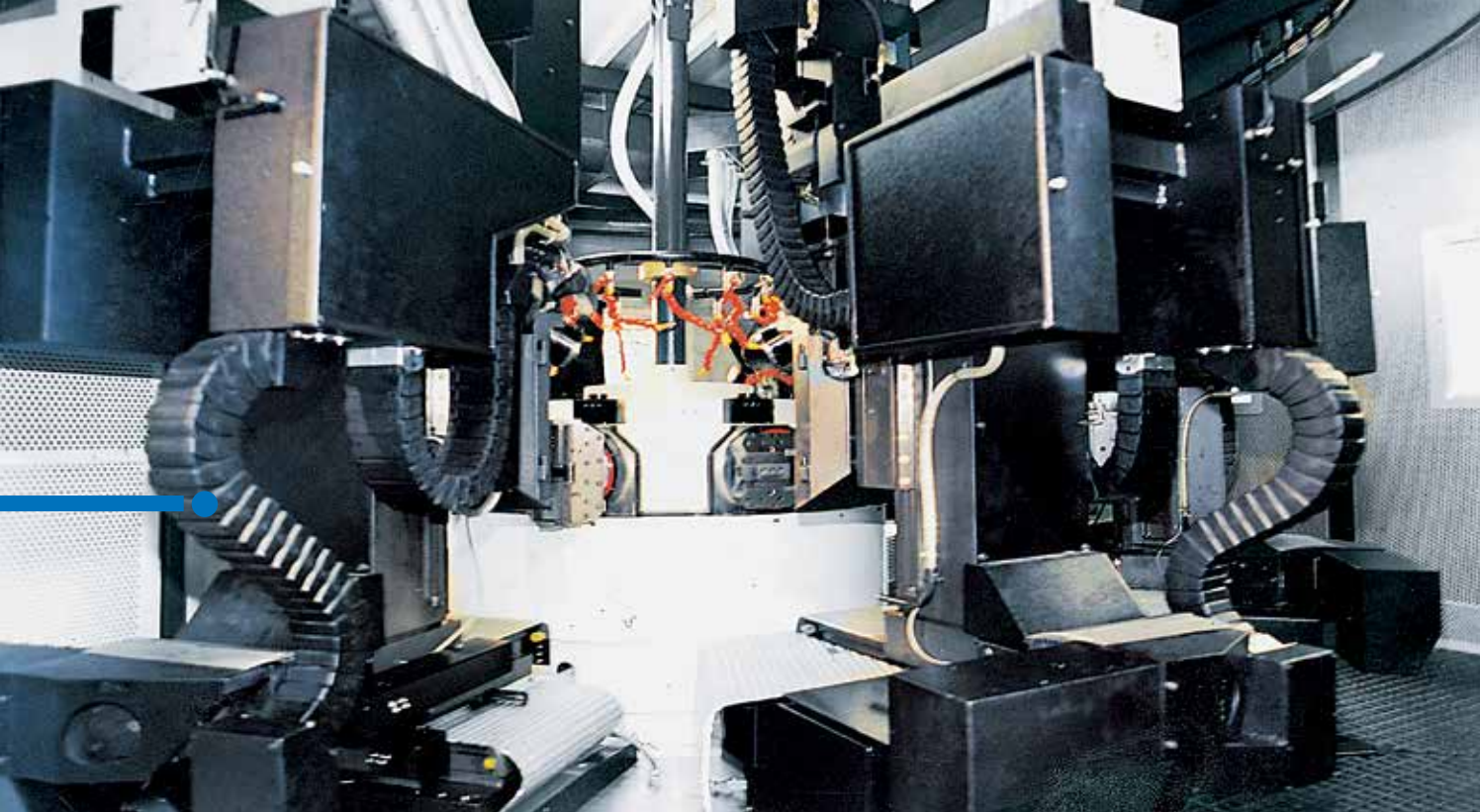

Various triflex® tubes on the inside of a machining center



triflex® for 3 movement directions combined with triflex® for 1 movement direction



triflex® 332 as unsupported link from machines to control desk

e-chain system® triflex® Series Selection Guide

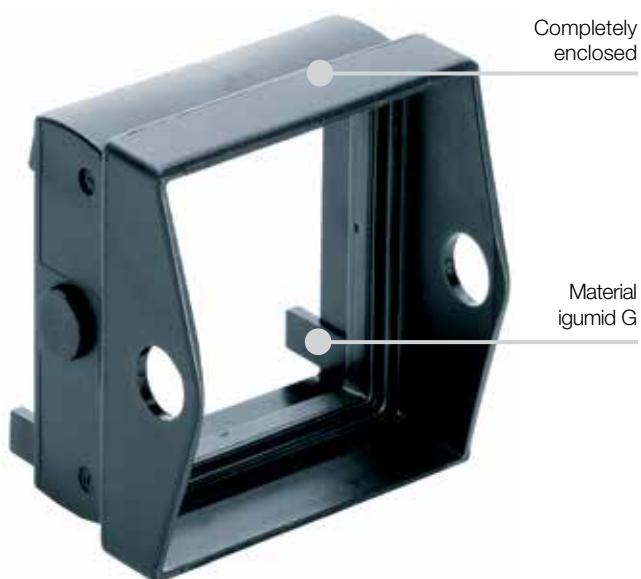

Select this modular, robust, Energy chain system® for:

- 3-axis motions in machinery of all kinds
- Dirty environments
- High tensile strength
- Where rectangular shapes fit better
- Side-mounted unsupported
- Completely enclosed - protection against dirt and chips
- Combinations of varying bending radii and moving axes
- Connecting and separating possible at every link
- Flanged mounting brackets or mounting brackets angle, galvanized steel
- Series 352 and 353 snap-open
- Combination Series 353/333 possible
- Cost-effective design for complex movements
- You can find more technical data about the material, chemical resistance, temperatures ► **Design, Chapter 1**

Selection table

Single-axis movement:

Series	Inner height/Inner width □ Bi		Outer width/Outer height □ Ba		Bending radii R	
	in.	(mm)	in.	(mm)	in.	(mm)
331-16	.63	(16)	1.02	(26)	1.50 - 3.94	(038 - 100)
331-32	1.26	(32)	1.97	(50)	2.95 - 9.84	(075 - 250)
331-50	1.97	(50)	2.68	(68)	3.94 - 9.84	(100 - 250)
331-75	2.95	(75)	3.78	(96)	5.51 - 11.81	(140 - 300)

Double-axis movement:

Series	Inner height/Inner width □ Bi		Outer width/Outer height □ Ba		Bending radii R	
	in.	(mm)	in.	(mm)	in.	(mm)
332-16	.63	(16)	1.02	(26)	1.50 - 3.94	(038 - 100)
332-32	1.26	(32)	1.97	(50)	2.95 - 9.84	(075 - 250)
332-50	1.97	(50)	2.68	(68)	3.94 - 9.84	(100 - 250)
332-75	2.95	(75)	3.78	(96)	5.51 - 11.81	(140 - 300)

Triple-axis movement:

Series	Inner height/Inner width □ Bi		Outer width/Outer height □ Ba		Bending radii R	
	in.	(mm)	in.	(mm)	in.	(mm)
333-16	.63	(16)	1.02	(26)	1.50 - 3.94	(038 - 100)
333-32	1.26	(32)	1.97	(50)	2.95 - 9.84	(075 - 250)
333-50	1.97	(50)	2.68	(68)	3.94 - 9.84	(100 - 250)
333-75	2.95	(75)	3.78	(96)	5.51 - 11.81	(140 - 300)

Snap-open Series:

Series	Inner height/Inner width □ Bi		Outer width/Outer height □ Ba		Bending radii R	
	in.	(mm)	in.	(mm)	in.	(mm)
351-50 Single	1.97	(50)	2.68	(68)	3.94 - 9.84	(100 - 250)
352-50 Double	1.97	(50)	2.68	(68)	3.94 - 9.84	(100 - 250)
353-50 Triple	1.97	(50)	2.68	(68)	3.94 - 9.84	(100 - 250)



Available from stock. Orders ship as early as today.*

*On average 90% of orders ship the same day..

e-chain system®

triflex® Series

Assembly Instructions

triflex® Series - Assembling



Twist and snap in



Snap in pin "push-button-design"

triflex® Series - Separating



Release side link



Twist and separate

triflex® Series 352 and 353 - Filling



To open Series 352 and Series 353 only - Insert screwdriver into slot on top of lid and push down

Price Index



Series 332/333 Series 352/353

Special Options Available



Assembly Tips

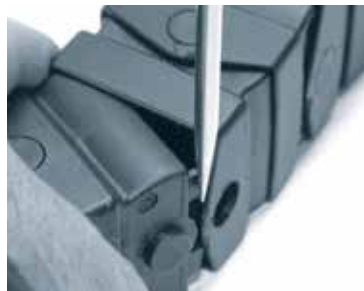

Release side link, twist and separate



To open Series 352 and Series 353 only
- Insert screwdriver into slot on top of lid and push down

Usage Guidelines



- For applications that move within two or three axes (combined rotary and circular movements)
- If chip protection is required



- If every link must open on both sides

➤ TwisterChain® system,

Chapter 8

- For gliding applications
 - System E4, Chapter 6
- For rotary movements only
 - TwisterChain® system, Chapter 8

Features & Benefits

- 1 KMA, flanged and angled mounting brackets available
- 2 Combinations of varying bending radii and moving axes
- 3 Completely enclosed
- 4 Combination of Series 353 and Series 333 possible
- 5 Series 352 and 353 snap-open
- 6 Protection against dirt and chips
- 7 High tensile strength
- 8 Cost-effective design for complex movements
- 9 Assembling and separating at any given point



Order Example: Complete e-chain®

Please indicate chain length or number of links. Example:

6.56 ft (2 m) **332-50-100/100-0**

e-chain®

With 2 separators **351** assembled every 2nd link

Interior Separation

1 Set **338-50-12**

Mounting Bracket

e-chain system® triflex® Series
 Series 331/332/333
 Series 351/352/353 (Snap-Open)



triflex®

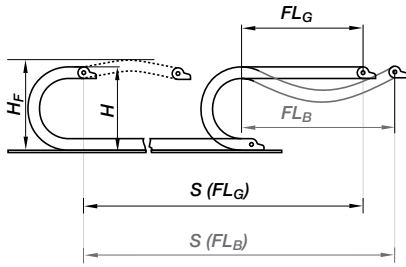

Short travel, unsupported length

- FL_B = unsupported with permitted sag
 - FL_G = unsupported with straight upper run
- Further information ► Design, Chapter 1

Legend

- S = Length of travel
- R = Bending radius
- H = Nominal clearance height
- D = Overlength e-chain® radius in final position
- $K = \pi \cdot R + \text{"safety buffer"}$
- H_F = Required clearance height

Unsupported length 331/332-16

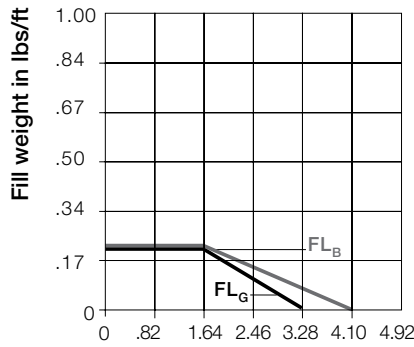

Unsupported length in ft FL_B/FL_G

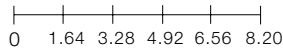

Total Length of travel S in ft

Unsupported length 331/332-32

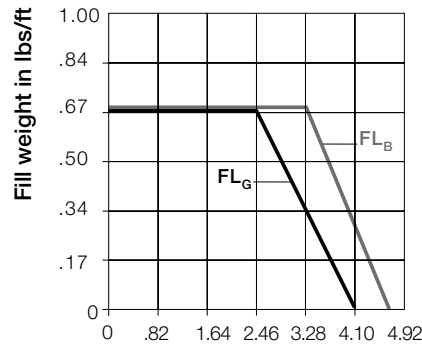

Single Axis Movement, Series 331/351

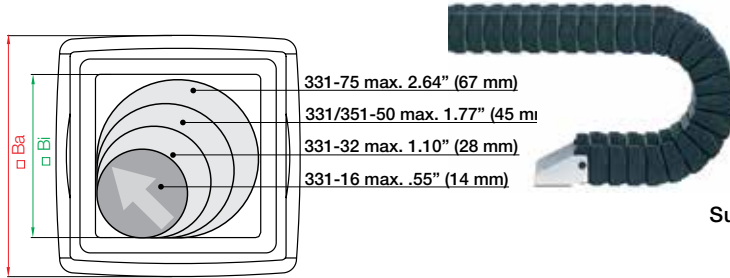

Part No.	Bi	Ba	Weight
	in. (mm)	in. (mm)	lbs/ft (kg/m)
331-16-	.63 (16)	1.02 (26)	≈ 0.22 (.33)
331-32-	1.26 (32)	1.97 (50)	≈ 0.60 (.90)
331-50-	1.97 (50)	2.68 (68)	≈ 0.94 (1.40)
331-75-	2.95 (75)	3.78 (96)	≈ 1.58 (2.35)
Snap-open			
351-50-	1.97 (50)	2.68 (68)	≈ 0.94 (1.40)

Supplement part number with required radius from below.
for example 331-50-100-0

Installation dimensions for single-axis movement

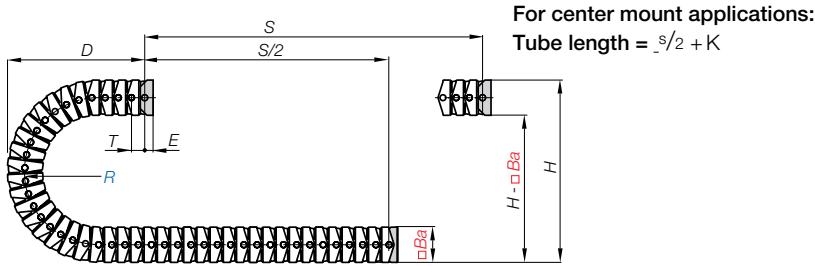

Part No. structure

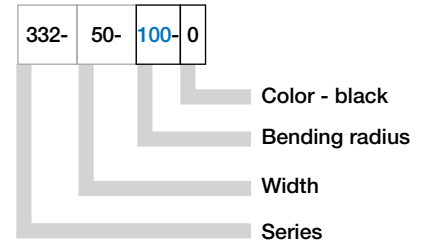

Series 331-16

R	1.50 (038)	1.89 (048)	2.95 (075)	3.94 (100)
H	4.13 (105)	4.92 (125)	7.09 (180)	9.06 (230)
D	2.76 (70)	3.15 (80)	4.13 (105)	5.12 (130)
K	7.87 (200)	9.06 (230)	12.40 (315)	15.75 (400)

Pitch = .52 (13.3 mm)
Links/ft (m) = 23.08 (76)
Dimensions E = .39 (10 mm)
Ba = 1.02 (26 mm)

Series 331-32

R	2.95 (075)	3.94 (100)	4.92 (125)	5.91 (150)	7.87 (200)	9.84 (250)
H	7.87 (200)	9.84 (250)	11.81 (300)	13.78 (350)	17.72 (450)	21.65 (550)
D	5.12 (130)	6.10 (155)	7.09 (180)	8.07 (205)	10.04 (255)	12.01 (305)
K	12.01 (305)	15.15 (385)	18.30 (465)	21.46 (545)	27.56 (700)	34.06 (865)

Pitch = .98 (25 mm)
Links/ft (m) = 12.24 (40)
Dimensions E = .79 (20 mm)
Ba = 1.97 (50 mm)

Series 331-50

R	3.94 (100)	4.92 (125)	5.91 (150)	7.87 (200)	9.84 (250)
H	10.63 (270)	12.60 (320)	14.76 (375)	18.50 (470)	22.44 (570)
D	7.68 (195)	8.66 (220)	9.65 (245)	11.61 (295)	13.58 (345)
K	17.13 (435)	20.47 (520)	23.23 (590)	29.53 (750)	35.83 (910)

Pitch = 1.18 (30 mm)
Links/ft (m) = 10.17 (34)
Dimensions E = .98 (25 mm)
Ba = 2.68 (68 mm)

Series 331-75

R	5.51 (140)	6.89 (175)	7.87 (200)	9.84 (250)	11.81 (300)
H	14.96 (380)	17.71 (450)	19.69 (500)	23.62 (600)	27.56 (700)
D	9.45 (240)	10.83 (275)	11.81 (300)	13.78 (350)	15.75 (400)
K	21.65 (550)	25.98 (660)	29.13 (740)	35.43 (900)	41.73 (1060)

Pitch = 1.42 (36 mm)
Links/ft (m) = 8.45 (28)
Dimensions E = .98 (25 mm)
Ba = 3.78 (96 mm)

Series 351-50 (Snap-Open)

R	3.94 (100)	4.92 (125)	5.91 (150)	7.87 (200)	9.84 (250)
H	10.63 (270)	12.60 (320)	14.76 (375)	18.50 (470)	22.44 (570)
D	7.68 (195)	8.66 (220)	9.65 (245)	11.61 (295)	13.58 (345)
K	17.13 (435)	20.47 (520)	23.23 (590)	29.53 (750)	35.83 (910)

Pitch = 1.18 (30 mm)
Links/ft (m) = 10.17 (34)
Dimensions E = .98 (25 mm)
Ba = 2.68 (68 mm)

Double Axis Movement, Series 332/352

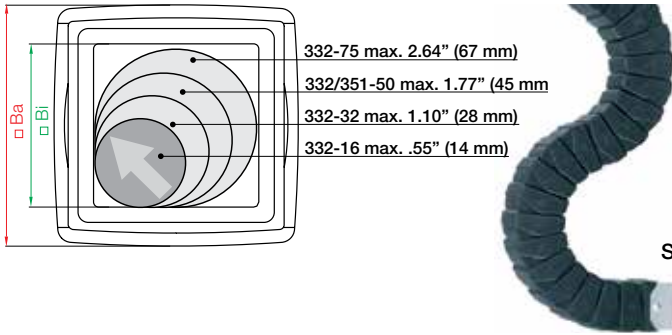

Part No.	Bi in. (mm)	Ba in. (mm)	Weight lbs/ft (kg/m)
332-16-	.63 (16)	1.02 (26)	≈ 0.22 (.33)
332-32-	1.26 (32)	1.97 (50)	≈ 0.60 (.90)
332-50-	1.97 (50)	2.68 (68)	≈ 0.94 (1.40)
332-75-	2.95 (75)	3.78 (96)	≈ 1.58 (2.35)
Snap-open			
352-50-	1.97 (50)	2.68 (68)	≈ 0.94 (1.40)

Supplement part number with required radius from below
for example, 332-75-2-200-0

Installation dimensions for double-axis movement

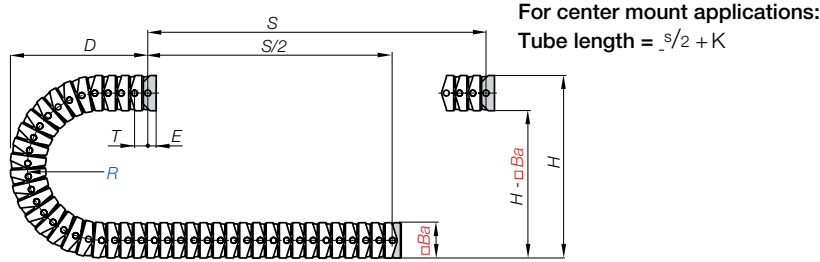

Part No. structure

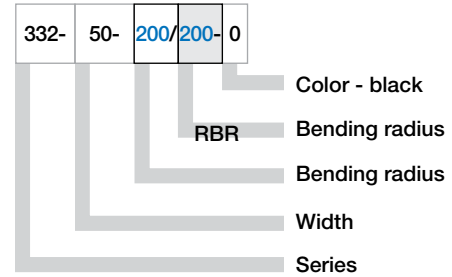

Series 332-16

R	1.50 (038)	1.89 (048)	2.95 (075)	3.94 (100)
H	4.13 (105)	4.92 (125)	7.09 (180)	9.06 (230)
D	2.76 (70)	3.15 (80)	4.13 (105)	5.12 (130)
K	7.87 (200)	9.06 (230)	12.40 (315)	15.75 (400)

Pitch = .52 (13.3 mm)
Links/ft (m) = 23.08 (76)
Dimensions E = .39 (10 mm)
Ba = 1.02 (26 mm)

Series 332-32

R	2.95 (075)	3.94 (100)	4.92 (125)	5.91 (150)	7.87 (200)	9.84 (250)
H	7.87 (200)	9.84 (250)	11.81 (300)	13.78 (350)	17.72 (450)	21.65 (550)
D	5.12 (130)	6.10 (155)	7.09 (180)	8.07 (205)	10.04 (255)	12.01 (305)
K	12.01 (305)	15.15 (385)	18.30 (465)	21.46 (545)	27.56 (700)	34.06 (865)

Pitch = .98 (25 mm)
Links/ft (m) = 12.24 (40)
Dimensions E = .79 (20 mm)
Ba = 1.97 (50 mm)

Series 332-50

R	3.94 (100)	4.92 (125)	5.91 (150)	7.87 (200)	9.84 (250)
H	10.63 (270)	12.60 (320)	14.76 (375)	18.50 (470)	22.44 (570)
D	7.68 (195)	8.66 (220)	9.65 (245)	11.61 (295)	13.58 (345)
K	17.13 (435)	20.47 (520)	23.23 (590)	29.53 (750)	35.83 (910)

Pitch = 1.18 (30 mm)
Links/ft (m) = 10.17 (34)
Dimensions E = .98 (25 mm)
Ba = 2.68 (68 mm)

Series 332-75

R	5.51 (140)	6.89 (175)	7.87 (200)	9.84 (250)	11.81 (300)
H	14.96 (380)	17.71 (450)	19.69 (500)	23.62 (600)	27.56 (700)
D	9.45 (240)	10.83 (275)	11.81 (300)	13.78 (350)	15.75 (400)
K	21.65 (550)	25.98 (660)	29.13 (740)	35.43 (900)	41.73 (1060)

Pitch = 1.42 (36 mm)
Links/ft (m) = 8.45 (28)
Dimensions E = .98 (25 mm)
Ba = 3.78 (96 mm)

Series 352-50 (Snap-Open)

R	3.94 (100)	4.92 (125)	5.91 (150)	7.87 (200)	9.84 (250)
H	14.96 (380)	12.60 (320)	14.76 (375)	18.50 (470)	22.44 (570)
D	9.45 (240)	8.66 (220)	9.65 (245)	11.61 (295)	13.58 (345)
K	21.65 (550)	20.47 (520)	23.23 (590)	29.53 (750)	35.83 (910)

Pitch = 1.18 (30 mm)
Links/ft (m) = 10.17 (34)
Dimensions E = .98 (25 mm)
Ba = 2.68 (68 mm)



Triple Axis Movement, Series 333/353 (Snap-Open)

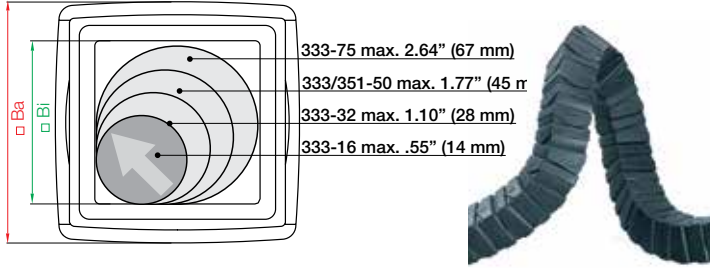

Part No.	Bi in. (mm)	Ba in. (mm)	Weight lbs/ft (kg/m)
333-16-	.63 (16)	1.02 (26)	≈ 0.22 (.33)
333-32-	1.26 (32)	1.97 (50)	≈ 0.60 (.90)
333-50-	1.97 (50)	2.68 (68)	≈ 0.94 (1.40)
333-75-	2.95 (75)	3.78 (96)	≈ 1.58 (2.35)
Snap-open			
353-50-	1.97 (50)	2.68 (68)	≈ 0.94 (1.40)

Supplement part number with required radius from above
for example, 333-32-100-0

Installation dimensions for triple-axis movement

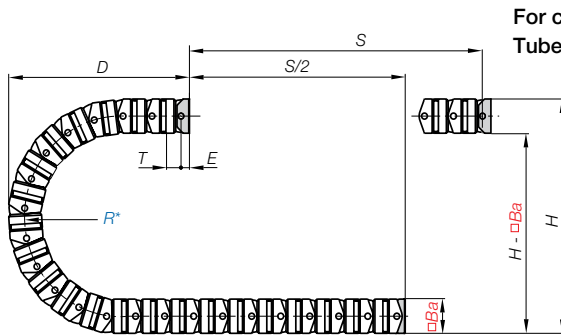

Part No. structure

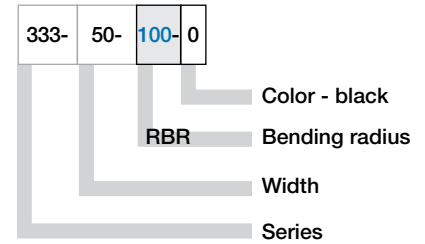

* The bending radii are doubled in the case of the **Series 333** e-chain®

Series 333-16

R	(076)	3.78 (096)	5.91 (150)	7.87 (200)
H	7.09 (180)	8.66 (220)	12.99 (330)	16.93 (430)
D	4.13 (105)	4.92 (125)	7.09 (180)	9.06 (230)
K	12.60 (320)	14.96 (380)	21.65 (550)	27.95 (710)

Pitch = .52 (13.3 mm)
Links/ft (m) = 23.08 (76)
Dimensions E = .39 (10 mm)
Ba = 1.02 (26 mm)

Series 333-32

R	5.91 (150)	7.87 (200)	9.84 (250)	11.81 (300)	15.75 (400)	19.69 (500)
H	13.78 (350)	17.72 (450)	21.65 (550)	25.59 (650)	33.46 (850)	41.33 (1050)
D	8.07 (205)	10.04 (255)	12.01 (305)	13.98 (355)	17.91 (455)	21.85 (555)
K	21.46 (545)	27.56 (700)	33.86 (860)	40.16 (1020)	51.18 (1300)	63.19 (1605)

Pitch = .98 (25 mm)
Links/ft (m) = 12.24 (40)
Dimensions E = .79 (20 mm)
Ba = 1.97 (50 mm)

Series 333-50

R	7.87 (200)	9.84 (250)	11.81 (300)	15.75 (400)	19.69 (500)
H	18.50 (470)	22.44 (570)	26.38 (670)	34.25 (870)	42.13 (1070)
D	11.61 (295)	13.58 (345)	15.55 (395)	19.49 (495)	23.43 (595)
K	29.53 (750)	35.83 (910)	42.13 (1070)	54.33 (1380)	66.54 (1690)

Pitch = 1.18 (30 mm)
Links/ft (m) = 10.17 (34)
Dimensions E = .98 (25 mm)
Ba = 2.68 (68 mm)

Series 333-75

R	11.02 (280)	13.78 (350)	15.75 (400)	19.69 (500)	23.62 (600)
H	25.98 (660)	31.50 (800)	35.43 (900)	43.31 (1100)	51.18 (1300)
D	14.96 (380)	17.72 (450)	19.69 (500)	23.62 (600)	27.56 (700)
K	38.98 (990)	47.64 (1210)	55.12 (1400)	66.93 (1700)	78.74 (2000)

Pitch = 1.42 (36 mm)
Links/ft (m) = 8.45 (28)
Dimensions E = .98 (25 mm)
Ba = 3.78 (96 mm)

Series 353-50 (Snap-Open)

R	7.87 (200)	9.84 (250)	11.81 (300)	15.75 (400)	19.69 (500)
H	18.50 (470)	22.44 (570)	26.38 (670)	34.25 (870)	42.13 (1070)
D	11.61 (295)	13.58 (345)	15.55 (395)	19.49 (495)	23.43 (595)
K	29.53 (750)	35.83 (910)	42.13 (1070)	54.33 (1380)	66.54 (1690)

Pitch = 1.18 (30 mm)
Links/ft (m) = 10.17 (34)
Dimensions E = .98 (25 mm)
Ba = 2.68 (68 mm)

Interior Separation

Modular separators are available as interior shelving for the igus® triflex® System. They can be used for both vertical and horizontal sub-division. If the separators are assembled every other link and turned 90°, the tube can be sub-divided into four segments. We recommend ordering the tube pre-assembled, as subsequent assembly of separators is only possible after dismantling the tube. Please note that assembled separators have a different part number than unassembled separators.



Horizontal sub-division



Vertical sub-division

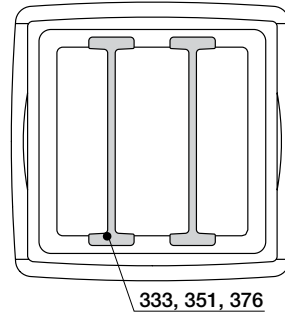

331/332/333-75

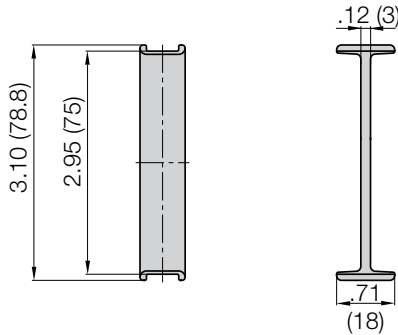

Separator

Unassembled	Part No. 375
Assembled	Part No. 376

331/332/333-50 351/352/353-50

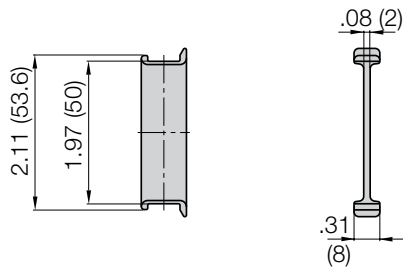

Separator

Unassembled	Part No. 350
Assembled	Part No. 351

331/332/333-32

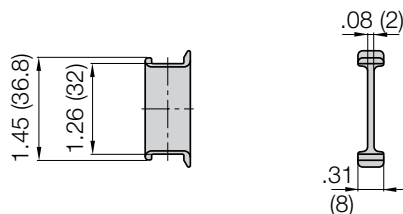

Separator

Unassembled	Part No. 332
Assembled	Part No. 333





Standard

Option 1: KMA

- Corrosion resistant
- Strain relief with tiwrap plate

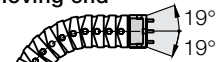
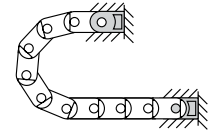
333-50-1PZ
Moving end333-50-2PZB
Fixed end
(with tiwrap plate 333-50-ZB)

Possible installation configurations -

333...1PZ(B)

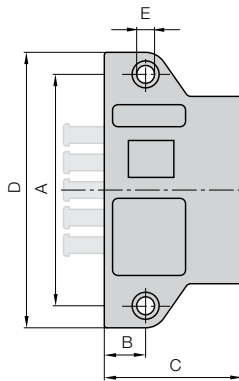

333...2PZ(B)

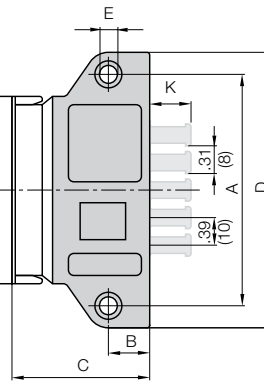

For high loads we recommend screwing the mounting brackets to the chain. If you have any questions, please give us a call.

Part No. structure

333-32-12-PZB

With assembled strain relief tiwrap plates

Full set = 12

Mounting brackets for selected chain type

Full set, for both ends:

333-32-12PZB +tiwrap plate

Single-part order:

333-32-1PZB +tiwrap plate

Mounting bracket with bore

333-32-2PZB +tiwrap plate

Mounting bracket with pin

Series	Part No. Full Set with tiwrap plate	Part No. Full Set without tiwrap plate	A	B	C	D	E	K	N
			in. (mm)	in. (mm)	in. (mm)	in. (mm)	in. (mm)	in. (mm)	No. of Teeth
331/332/333-32	333-32-12PZB	333-32-12-PZ	2.60 (66)	.59 (15)	1.81 (46)	3.23 (82)	.26 (6.5)	.59 (15)	3
331/332/333-50	333-50-12PZB	333-50-12-PZ	3.31 (84)	.59 (15)	1.97 (50)	3.94 (100)	.26 (6.5)	.59 (15)	5
331/332/333-75	333-75-12PZB	333-75-12-PZ	4.29 (109)	.59 (15)	2.17 (55)	4.92 (125)	.26 (6.5)	.59 (15)	7
Snap-open series									
351/352/353-50	333-50-12PZB	333-50-12-PZ	3.31 (84)	.59 (15)	1.97 (50)	3.94 (100)	.26 (6.5)	.59 (15)	5

Tiwrap plate as individual part

Special tiwrap plates for triflex® e-chains®

- Single-piece for installation inside switch cabinets or machine assembly
- Accessory for igus® e-chain systems®
- Easy to assemble, no need for screws

Part No.	Width	Number	For Series
Tiwrap plate	in. (mm)	of teeth	
333-32-ZB	1.57 (40)	3	331/332/333-32
333-50-ZB	2.28 (58)	5	331/332/333-50 351/352/353-50
333-75-ZB	3.27 (83)	7	331/332/333-75

e-chain system® triflex® Series Mounting Brackets



triflex®



Option 2: pivoting steel flange

- Galvanized steel
- Electrically conductive
- Flush mounting

330-16-1 / 330-75-1

Moving end

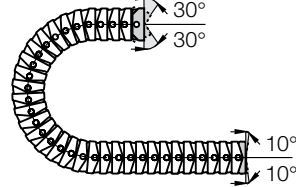

330-16-2 / 330-75-2

Fixed end

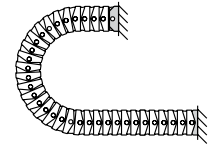

Possible installation configurations -

Full set, 4 parts

2 with pin / 2 with bore:

330- 32-12

Single-part order:

330- 32-1

Mounting bracket with bore

330- 32-2

Mounting bracket with pin

Part No. structure

330- 32- 12

Full set = 12

Width

Mounting brackets for selected chain type

330-26-2 / 330-75-2

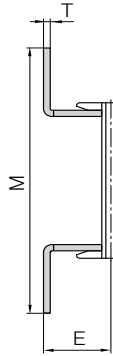

330-16-1 / 330-75-1

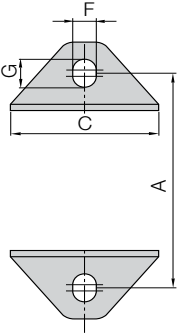

Series	Part No.	A	M	C	L	T	E	F	G
331/332/333-16	330-16-12	1.38 (35)	2.09 (53)	.83 (21)	2.24 (57)	.04 (1)	.39 (10)	.18 (4.5)	.24 (6)
331/332/333-32	330-32-12	2.60 (66)	3.31 (84)	1.73 (44)	3.46 (88)	.08 (2)	.79 (20)	.28 (7)	.35 (9)
331/332/333-50	330-50-12	3.31 (84)	4.02 (102)	2.44 (62)	4.17 (106)	.08 (2)	.98 (25)	.28 (7)	.35 (9)
331/332/333-75	330-75-12	4.29 (109)	5.00 (127)	3.54 (90)	5.16(131)	.08 (2)	.98 (25)	.28 (7)	.35 (9)



Option 3: angle

- Galvanized steel
- Electrically conductive
- Can be attached to top or bottom of the machine

338-16-1/ 338-75-1

Moving end

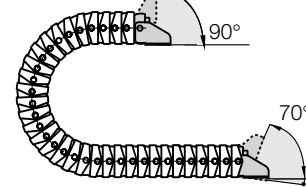

338-16-2 / 338-75-2

Fixed end

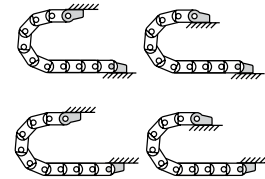

Possible installation configurations -

Full set, 4 parts

2 with pin / 2 with bore:

338- 32-12

Single-part order:

338- 32-1

Mounting bracket with bore

338- 32-2

Mounting bracket with pin

Part No. structure

338- 32- 12

Full set = 12

Width

Mounting brackets for selected chain type

338-16-2 / 338-75-2

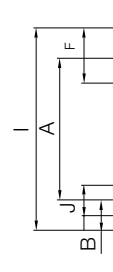

338-16-1 / 338-75-1

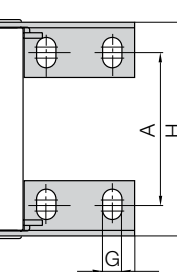

Series	Part No.	A	B	C	D	E	F	G	H	I	J
331/332/333-16	338-16-12	.47 (12)	.12 (3)	.98 (25)	.20 (5)	.39 (10)	.43 (11)	18 (4,5)	.98 (25)	.91 (23)	.24 (6)
331/332/333-32	338-32-12	.94 (24)	.22 (5.5)	1.85 (47)	.31 (8)	.94 (24)	.79 (20)	.28 (7)	1.93 (49)	1.77 (45)	.43 (11)
331/332/333-50	338-50-12	1.65 (42)	.22 (5.5)	3.03 (77)	.47 (12)	1.38 (35)	.94 (24)	.35 (9)	2.64 (67)	2.44 (62)	.59 (15)
331/332/333-75	338-75-12	2.56 (65)	.22 (5.5)	3.03 (77)	.47 (12)	1.38 (35)	.94 (24)	.35 (9)	3.74 (95)	3.54 (90)	.59 (15)
Snap-open											
351/352/353-50	338-50-12	1.65 (42)	.22 (5.5)	3.03 (77)	.47 (12)	1.38 (35)	.94 (24)	.35 (9)	2.64 (67)	2.44 (62)	.59 (15)

PDF: igus.com/e-chain-pdfs
Product information: igus.com/e-chains



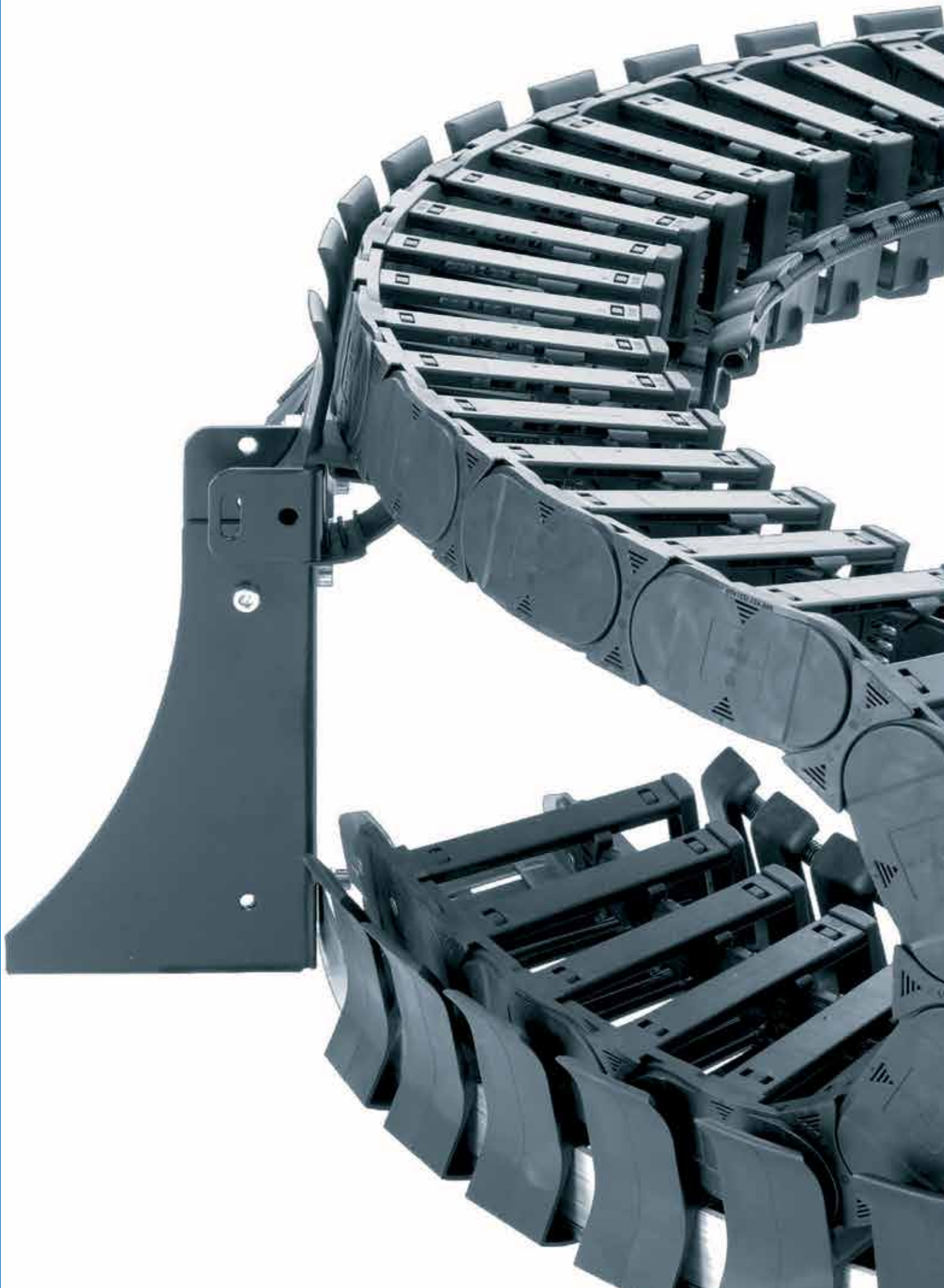

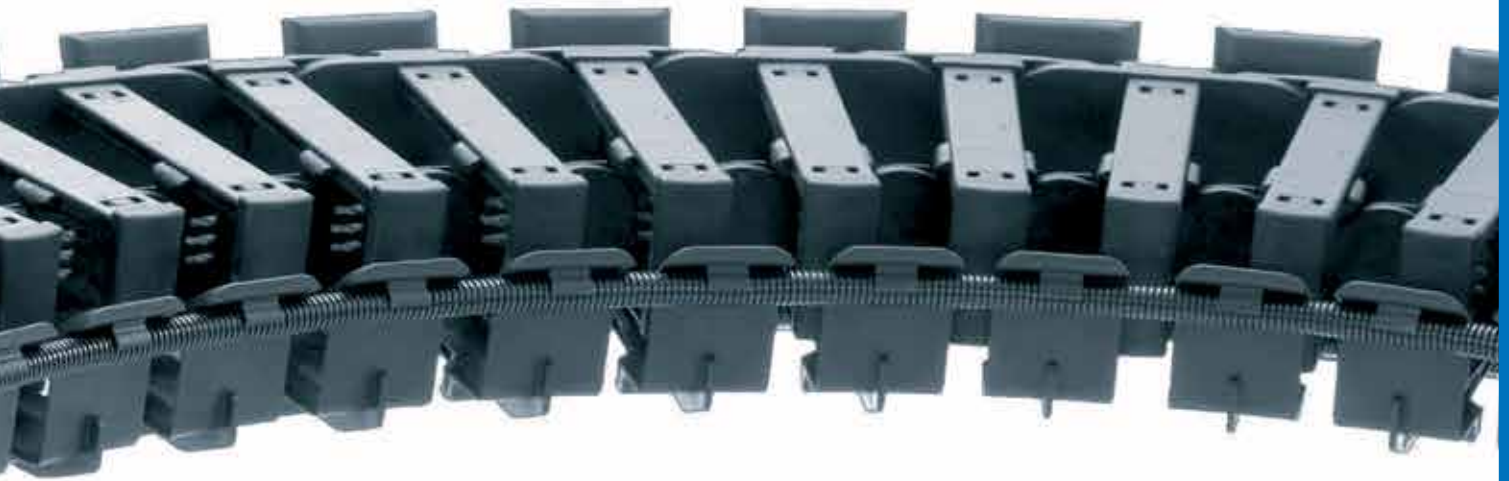

twisterchain

Circular and spiral movements



twisterchain advantages:

- e-chains® for circular and spiral movements up to 360°* available from stock
- Tough, quiet and high dynamics, suitable for high fill weights
- Rotary speeds up to 1m/s and more
- Modular interior separation
- Smooth cable-friendly interior
- Openable from both sides - crossbars removable along the inner and outer radius



When to use another igus® solution:

- For large rotary movements, igus® *RBR* solutions
 - ▶ **Designing**
- In case of rotary movements in the most confined spaces up to 7,000°
 - ▶ **twisterband**
- For angle of rotation >360° please contact us.

*Up to 540° upon request



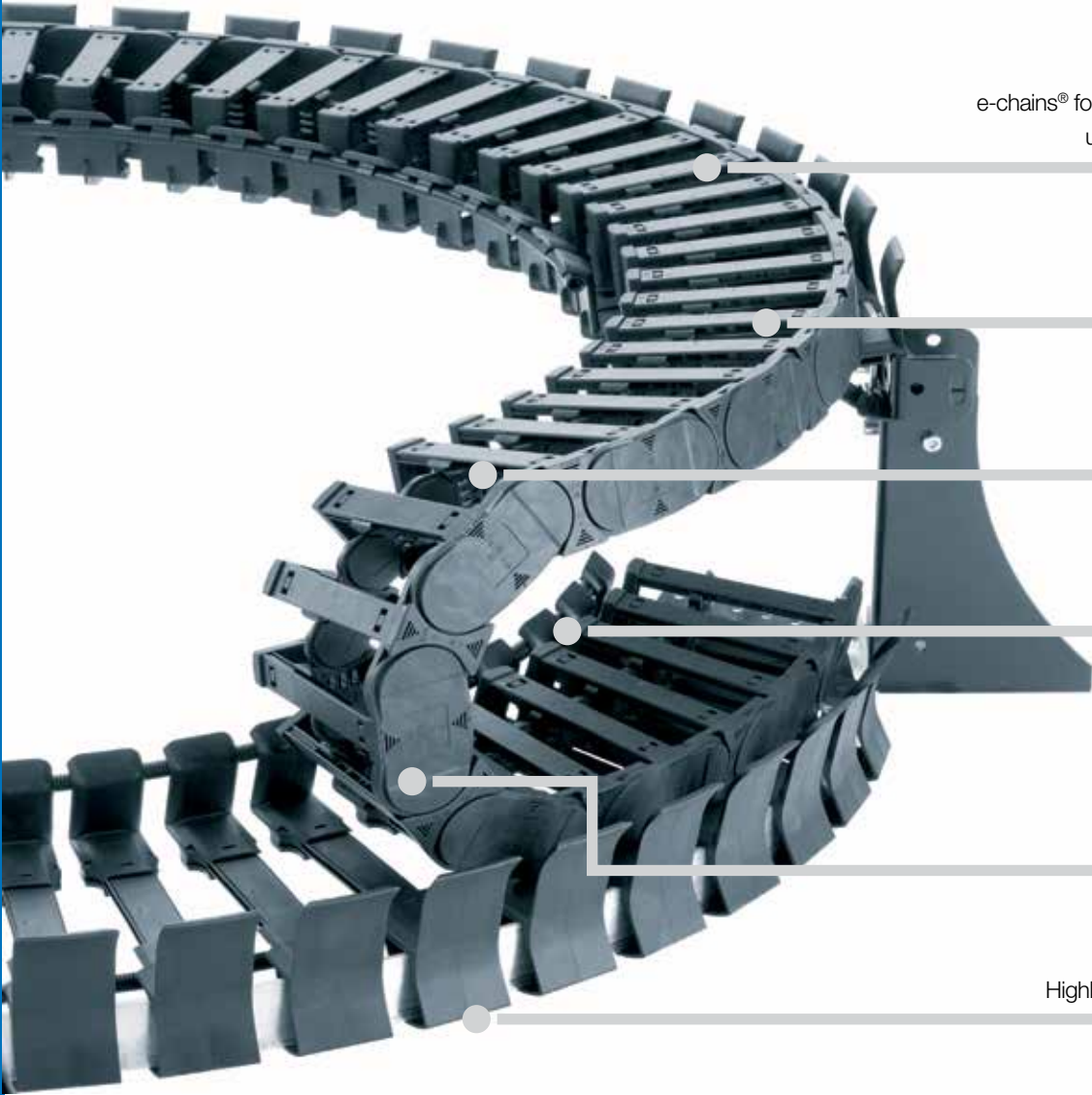

e-chains® for circular and spiral movements
up to 360°* available from stock

Smooth cable-friendly interior

Crossbars openable
along inner and outer radius

Modular; variable width,
height and bend radius

Stronger, higher fill weights
possible with intermediate link

Highly dynamic and smooth running

Strong, quiet and up to 360°* - circular and spiral movements with twisterchain

The igus® twisterchain product line offers an extensive range of products for circular movement and is available in four sizes. Its modular width and radius design ensures it can be used flexibly in applications with rotary and spiral movements up to 360° and more, with high fill weights and where smooth operation is required. twisterchain applications are available with modular guide troughs which offer: e-chain® guidance, reduced e-chain® wear, optimal levels of smooth operation, angle of rotations up to 360°* from stock.

- Strong, high fill weights, smooth running
- Rotary speeds up to 1m/s and more
- e-chains® for circular and spiral movements up to 360°*available from stock
- Cable-friendly, smooth interior
- Crossbars openable along the inner and outer radius
- Successfully tested for over 1 million cycles in the igus® laboratory

*Up to 540° upon request

Typical industries and applications

- Robots, Handling machines
- Packaging machines
- Glass machines
- General machinery, etc.



Circular movements up to 540° possible (with special attachments)



UL94-V0 classifications upon request

Series	Inner height h_i in. (mm)	Inner width B_i in. (mm)	Outer width B_a in. (mm)	Outer height h_a in. (mm)	Bend radius R in. (mm)	Circular radii AR in. (mm)
--------	--------------------------------	-------------------------------	-------------------------------	--------------------------------	-----------------------------	---------------------------------

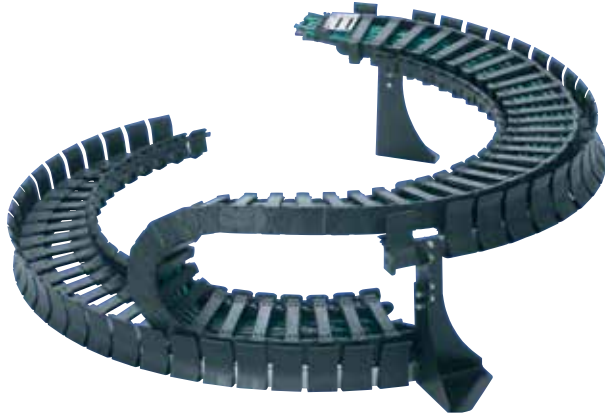

twisterchain

For circular movements up to 360° available from stock; for angle of rotation >360° please contact us.
 Crossbars removable along the inner and outer radius

2208	1.10 (28)	2.07-4.43 (52.5-112.5)	3.15-5.51 (80-140)	1.65 (42)	2.17-5.91 (055-150)	11.81 (300)
TC32	1.26 (32)	3.44-5.91 (87.5-150)	4.27-6.73 (108.5-171)	2.13 (54)	3.94-9.84 (100-250)	15.75-23.62 (400 - 600)
TC42	1.65 (42)	3.44-7.87 (87.5-200)	4.35-8.78 (110.5-223)	2.52 (64)	3.94-9.84 (100-250)	15.75-33.46 (400 - 850)
TC56	2.20 (56)	4.92-7.87 (125-200)	6.10-9.06 (155-230)	3.31 (84)	5.91-15.75 (150-400)	25.59-33.46 (650 - 850)

Available from stock. Orders ship as early as today.*

*On average 90% of orders ship the same day..

Quickly generate complete twisterchain 3D CAD models

- Get complete 3D models just by inputting the angle of rotation and basic dimensions
- Free positioning of the e-chain® moving end along the travel length
- Optional generation of twisterchain as an individual part or complete with guide trough and base support
- Fast download of the CAD files without registration
- 11 different 3D formats and 8 different 2D formats available

More information ► www.igus.com/twister-configurator

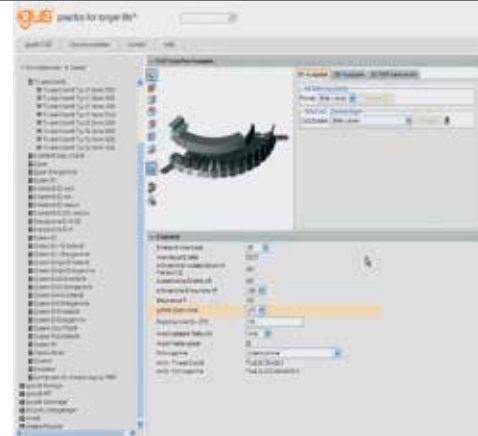

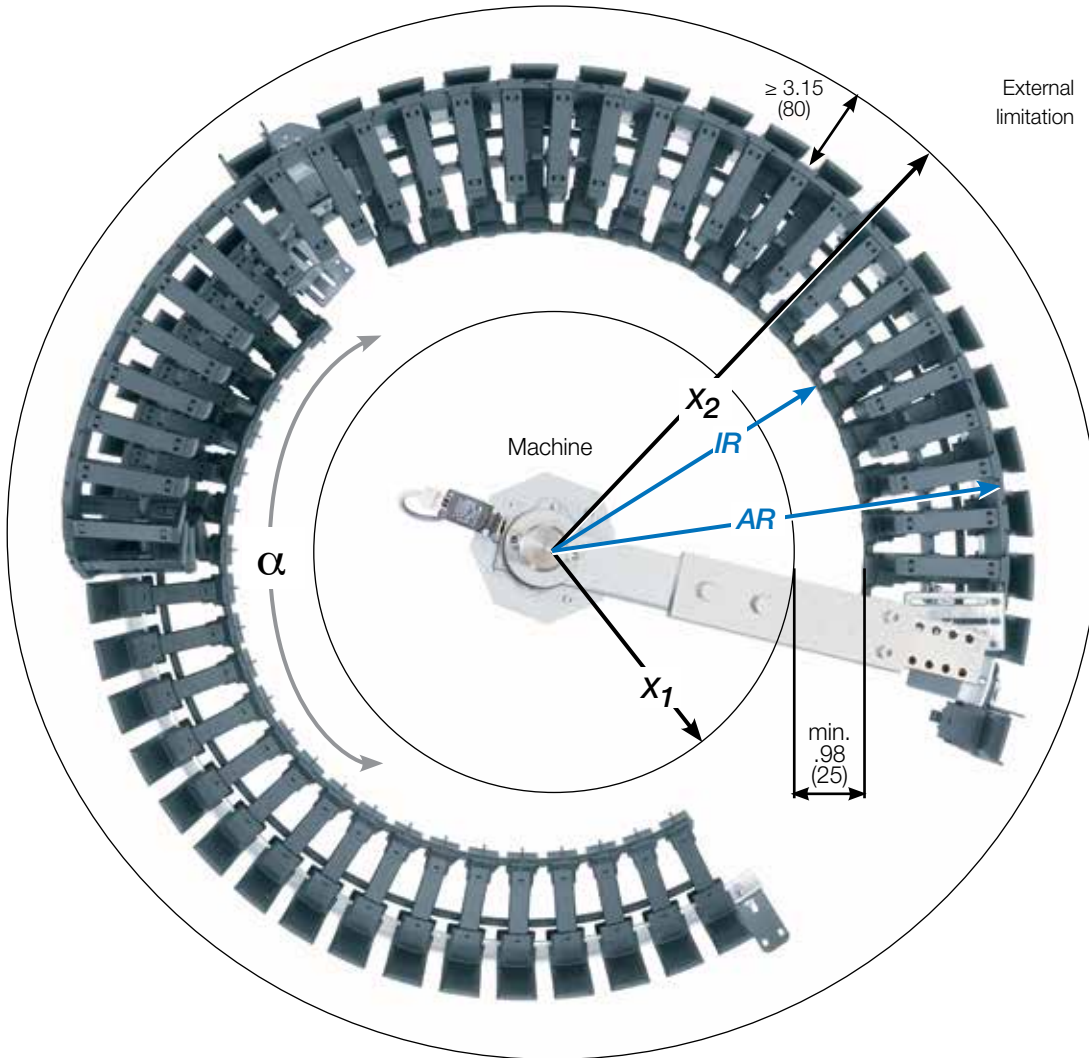

twisterchain definition

In the case of machine elements which both move to the left and to the right following a circular path, the rotation angle can be determined by adding the two angles

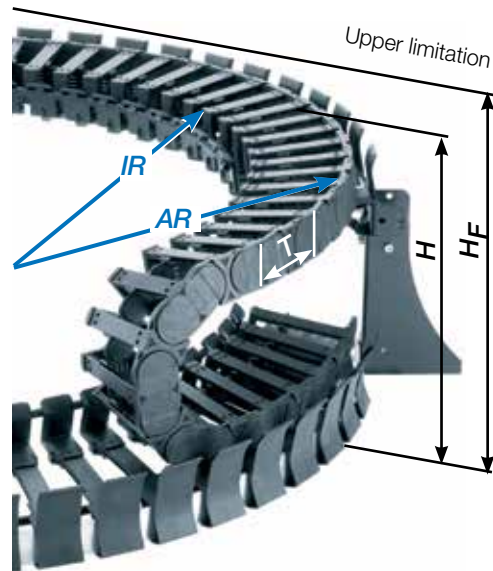
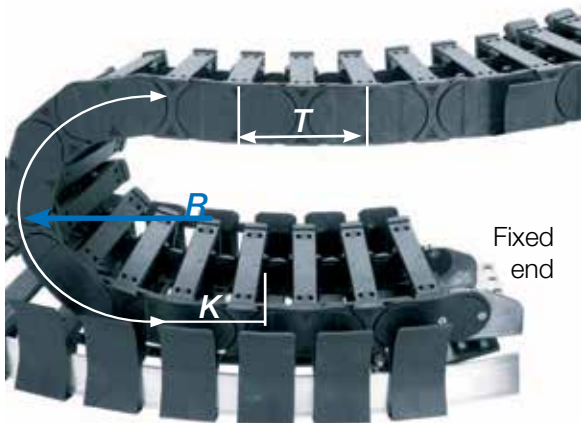

i AR = Outer radius, e-chain®
IR = Inner radius, e-chain®
R = Bending radius

X₁ = Inner machine construction space
X₂ = Outer radius AR, including clearance
T = Pitch
H_F = Height including 1.97" (50 mm) clearance

H = Nominal clearance height
K = Add-on for bending radius
hi = Inner height e-chain®
ha = Outer height e-chain®
α = Rotation angle

	Speed / acceleration	max. 3.28 ft/s (1.0 m/s) / max. 6.56 ft/s ² (2.0 m/s ²)
	Material - permitted temperature	igumid G / -40°F (-40°C) up to +248°F (+120° C)
	Flammability class, igumid G	VDE 0304 IIC UL94 HB

Order example | Order key

Order example for complete e-chain® 3.28 ft. (1.0m), color black, with mounting brackets:

e-chain® 3.28 ft. (1m)	Please indicate e-chain® length or number of links: 1m or 11 links	TC56.12.250/650.0
+ Mounting brackets	1 set	TC5600.34.VS.E

Order text: 1m TC56.12.250/650.0 + TC5600.34.VS.E

Order key

TC56.12.250/650.0

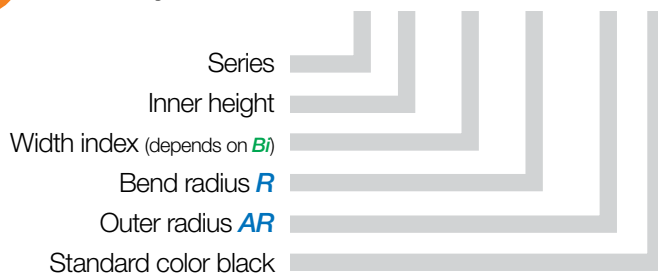

TC56.12.250/650.0 =
 e-chain® openable along the inner radius, from both sides
Bi 12mm inner width, *R* 250mm bend radius /
AR 650mm outer radius, color black

Series 2208 - Crossbars removable along the inner and outer radius

AR	IR	Bi	Ba	R Bend radius						Weight lbs/ft. (kg/m)
				2.17 (055) 2208-	2.48 (063) 2208-	2.95 (075) 2208-	3.94 (100) 2208-	4.92 (125) 2208-	5.91 (150) 2208-	
11.81 (300)	8.94 (227)	2.07 (52.5)	3.15 (80)	-052-063/300	-052-063/300	-052-075/300	-052-100/300	-052-125/300	-052-150/300	≈ 0.806 (1.20)
11.81 (300)	8.54 (217)	2.46 (62.5)	3.54 (90)			-062-075/300	-062-100/300	-062-125/300	-062-150/300	≈ 0.833 (1.24)
11.81 (300)	8.07 (205)	2.93 (74.5)	4.02 (102)				-074-100/300	-074-125/300	-074-150/300	≈ 0.867 (1.29)
11.81 (300)	7.56 (192)	3.44 (87.5)	4.53 (115)				-087-100/300	-087-125/300	-087-150/300	≈ 0.907 (1.35)
11.81 (300)	6.57 (167)	4.43 (112.5)	5.51 (140)					-112-125/300	-112-150/300	≈ 0.981 (1.46)

*twisterchain classic (1st generation),

Dimensions in mm

R	2.17 (55)	2.48 (63)	2.95 (75)	3.94 (100)	4.92 (125)	5.91 (150)
K	10.43 (265)	11.42 (290)	12.99 (330)	16.14 (410)	19.09 (485)	22.24 (565)

Pitch T per link = 1.73" (44mm)

Links per ft. (m) = 6.9 (23)

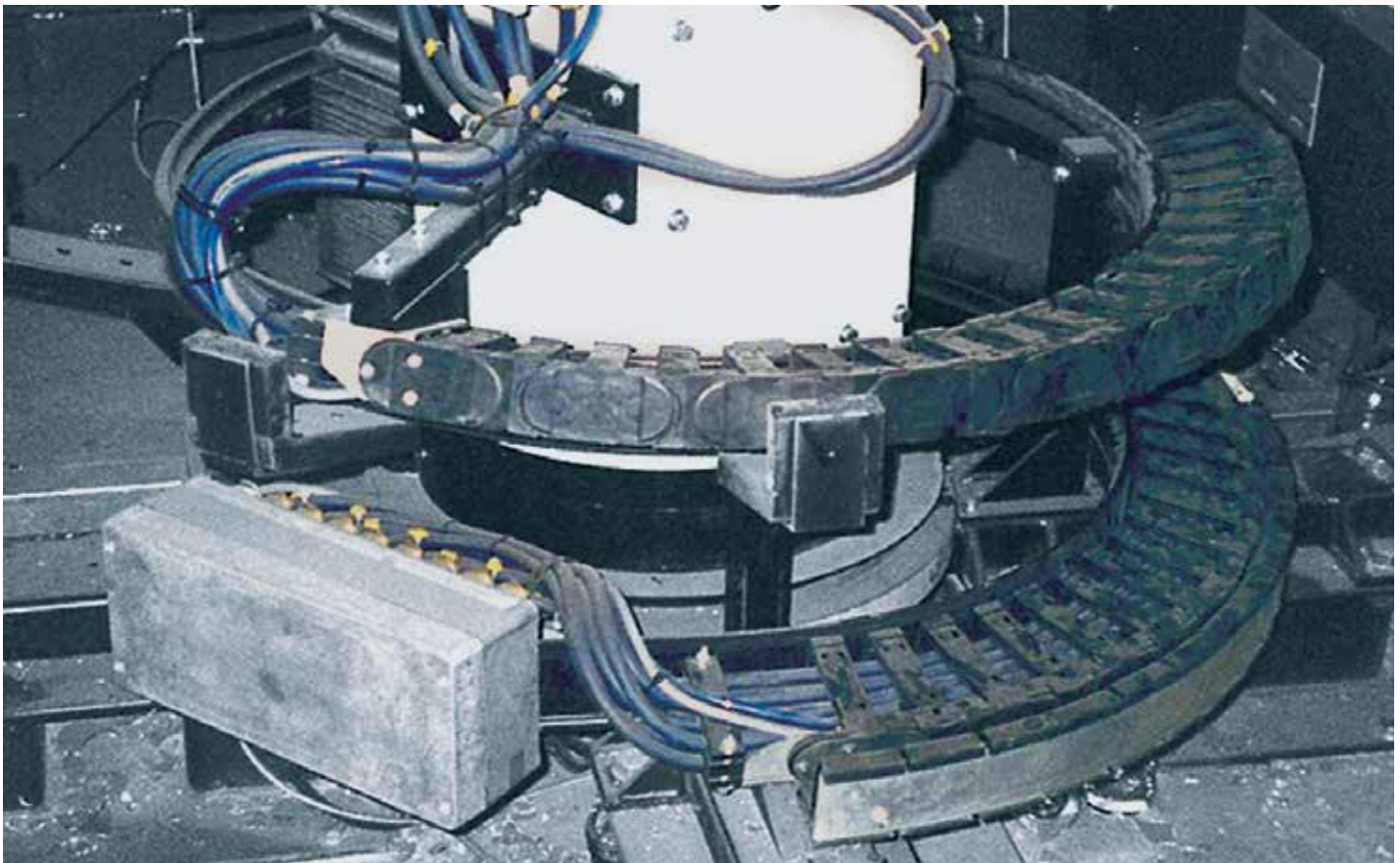
Combined spiral and circular movement - igus® twisterchain classic (1st generation)

Dimensions

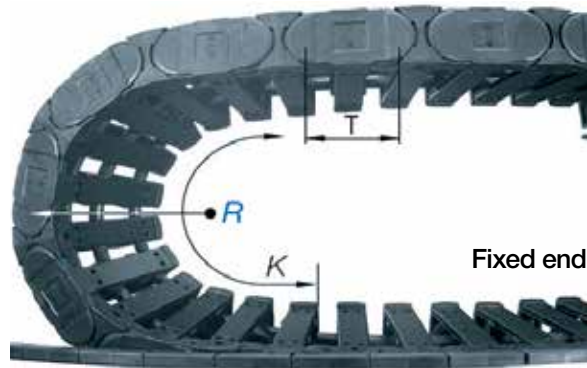
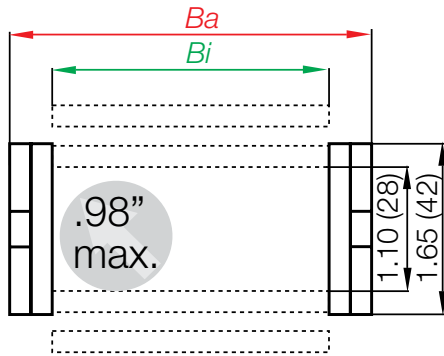

Series 2208 | interior separation

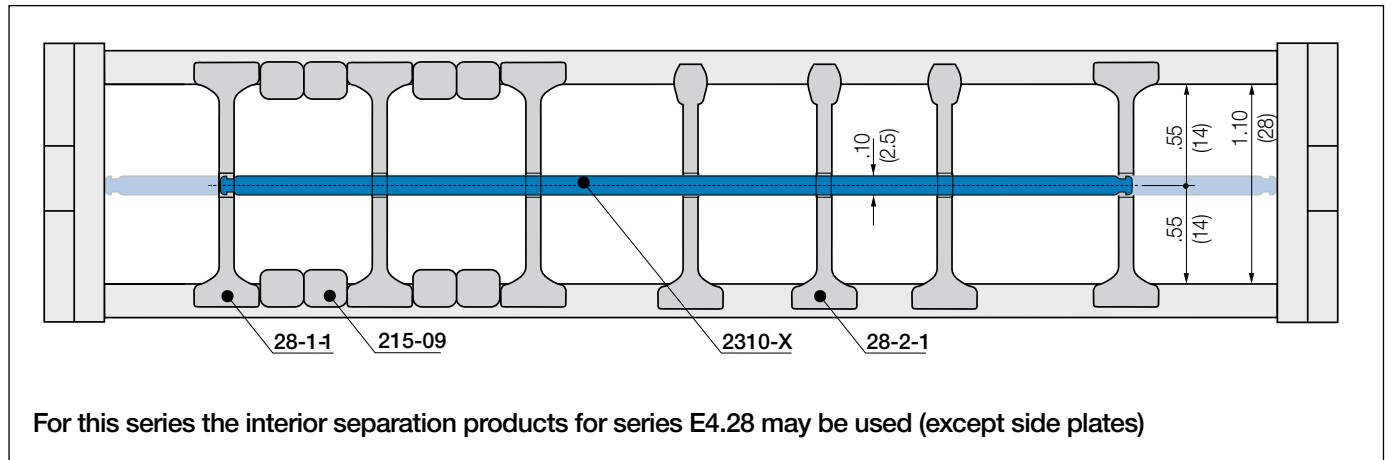

For this series the interior separation products for series E4.28 may be used (except side plates)



AR = Outer radius of e-chain®
 IR = Inner radius e-chain®
 R = Bend radius e-chain®

X_1 = Inner machine limit
 X_2 = Outer machine limit
 $A1$ = Intermediate link position

H = Nominal clearance height
 K = Add-on for bend radius
 T = Pitch

Series TC32 - Snap-open along inner radius from both sides

AR	Bi	Ba	X ₂	X ₁	R Bend radius						Weight lbs/ft (kg/m)
					3.94 (100) TC32-	4.92 (125) TC32-	5.91 (150) TC32-	6.89 (175) TC32-	7.87 (200) TC32-	9.84 (250) TC32-	
15.75 (400)	3.44 (87.5)	4.27 (108.5)	18.90 (480)	10.63 (270)	087-100/400	087-125/400	087-150/400	087-175/400	087-200/400	087-250/400	≈ 1.22 (1.82)
15.75 (400)	3.94 (100)	4.76 (121)	18.90 (480)	9.84 (250)	—	—	10-150/400	10-175/400	10-200/400	10-250/400	≈ 1.28 (1.90)
15.75 (400)	4.25 (108)	5.08 (129)	18.90 (480)	9.84 (250)	—	—	—	11-175/400	11-200/400	11-250/400	≈ 1.31 (1.95)
15.75 (400)	4.92 (125)	5.75 (146)	18.90 (480)	8.66 (220)	—	—	—	12-175/400	12-200/400	12-250/400	≈ 1.38 (2.05)
15.75 (400)	5.41 (137.5)	6.24 (158.5)	18.90 (480)	8.27 (210)	—	—	—	—	—	137-250/400	≈ 1.43 (2.13)
15.75 (400)	5.91 (150)	6.73 (171)	18.90 (480)	7.87 (200)	—	—	—	—	—	15-250/400	≈ 1.49 (2.21)
19.69 (500)	3.94 (100)	4.76 (121)	22.83 (580)	13.78 (350)	10-100/500	10-125/500	10-150/500	10-175/500	10-200/500	10-250/500	≈ 1.28 (1.90)
19.69 (500)	4.25 (108)	5.08 (129)	22.83 (580)	13.78 (350)	—	11-125/500	11-150/500	11-175/500	11-200/500	11-250/500	≈ 1.31 (1.95)
19.69 (500)	4.92 (125)	5.75 (146)	22.83 (580)	12.60 (320)	—	12-125/500	12-150/500	12-175/500	12-200/500	12-250/500	≈ 1.38 (2.05)
19.69 (500)	5.41 (137.5)	6.24 (158.5)	22.83 (580)	12.20 (310)	—	—	137-150/500	137-175/500	137-200/500	137-250/500	≈ 1.43 (2.13)
19.69 (500)	5.91 (150)	6.73 (171)	22.83 (580)	11.81 (300)	—	—	15-150/500	15-175/500	15-200/500	15-250/500	≈ 1.49 (2.21)
23.62 (600)	4.25 (108)	5.08 (129)	26.77 (680)	17.72 (450)	11-100/600	11-125/600	11-150/600	—	—	—	≈ 1.31 (1.95)
23.62 (600)	4.92 (125)	5.75 (146)	26.77 (680)	16.54 (420)	—	12-125/600	12-150/600	12-175/600	12-200/600	12-250/600	≈ 1.38 (2.05)
23.62 (600)	5.41 (137.5)	6.24 (158.5)	26.77 (680)	16.14 (410)	—	137-125/600	137-150/600	137-175/600	137-200/600	137-250/600	≈ 1.43 (2.13)
23.62 (600)	5.91 (150)	6.73 (171)	26.77 (680)	15.75 (400)	—	—	15-150/600	15-175/600	15-200/600	15-250/600	≈ 1.49 (2.21)

R	3.94 (100)	4.92 (125)	5.91 (150)	6.89 (175)	7.87 (200)	9.84 (250)
H ^{+90°}	10.00 (254)	11.97 (304)	13.94 (354)	15.91 (404)	17.87 (454)	21.81 (554)
K	18.31 (465)	21.65 (550)	24.41 (620)	27.56 (700)	30.71 (780)	37.01 (940)

Pitch T per link = 2.20" (56mm)

Links per ft. (m) = 5.4 (18)

 twisterchain 2nd generation from igus® - successfully tested for over 1 million cycles in the igus® laboratory

AR	R Bend radius					
	A1	A1	A1	A1	A1	A1
in. (mm)	in. (mm)	in. (mm)	in. (mm)	in. (mm)	in. (mm)	in. (mm)
400	2.01 (51)	2.01 (51)	2.05 (52)	2.09 (53)	2.09 (53)	2.28 (58)
500	2.56 (65)	2.56 (65)	2.60 (66)	2.64 (67)	2.72 (69)	2.80 (71)
600	3.11 (79)	3.15 (80)	3.19 (81)	3.19 (81)	3.23 (82)	3.35 (85)

Dimension A1 always with tolerance of $\pm .10"$ (2.5 mm) mm

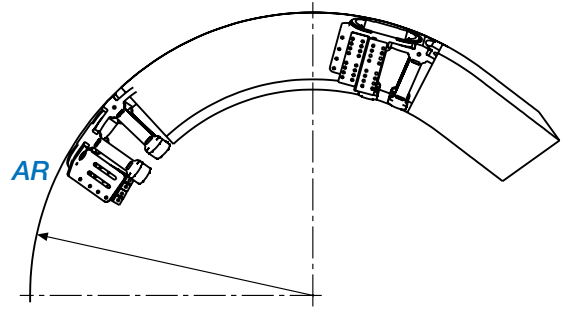

Note: Outer radius *AR* (see drawing) determines dimension *A1*!

Dimensions

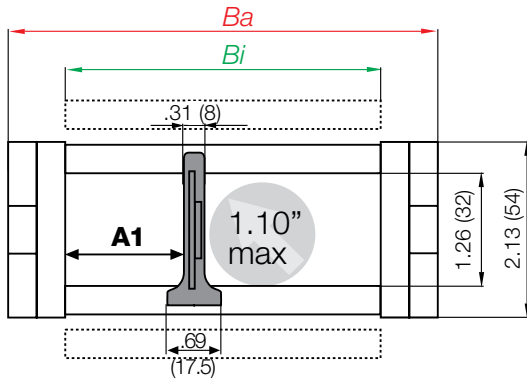

Part No. structure

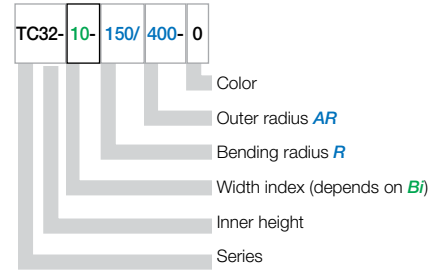

TC32-10-150/400-0 = e-chain® snap-open along inner radius from both sides
Bi 87.5 mm inner width, *R* 150 mm bending radius / *AR* 400 mm outer radius, color black

Interior Separation

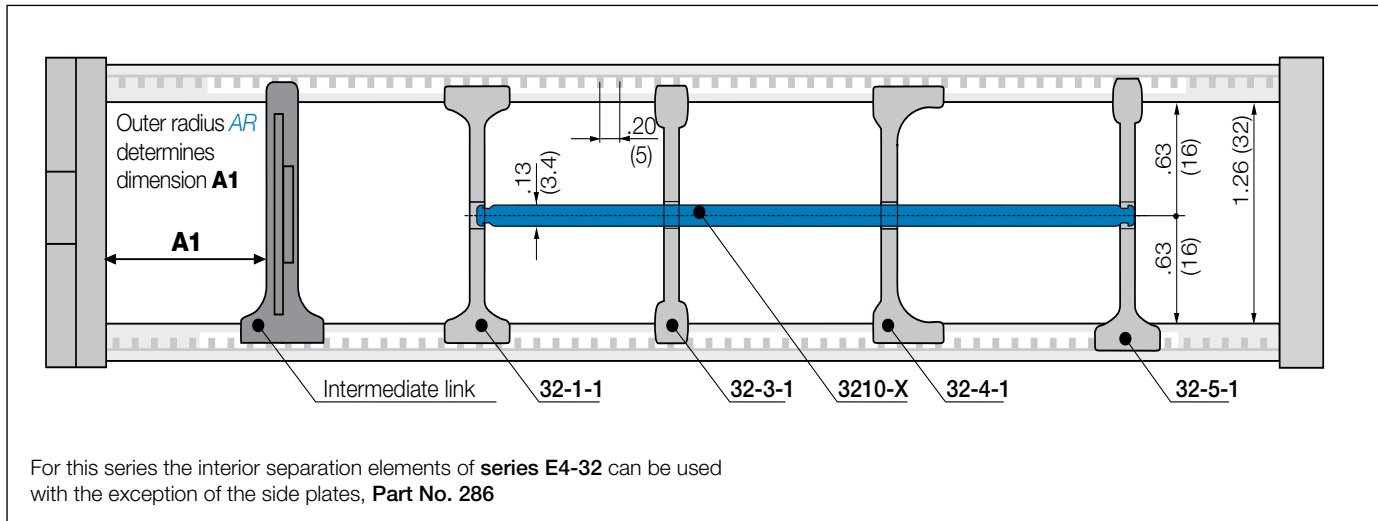

For this series the interior separation elements of series E4-32 can be used with the exception of the side plates, Part No. 286

AR = Outer radius
R = Bending radius
X₁ = Inner machine construction space
X₂ = Outer radius *AR*, including clearance

Ba = Outer width
Bi = Inner width
H = Nominal clearance height
K = Add-on for bending radius

A1 = Distance intermediate link
T = Pitch



twisterchain - Series TC42
Series TC42 - Snap-open along inner radius from both sides

AR	Bi	Ba	X ₂	X ₁	R Bend radius						Weight lbs/ft (kg/m)
					3.94 (100) TC42-	4.92 (125) TC42-	5.91 (150) TC42-	6.89 (175) TC42-	7.87 (200) TC42-	9.84 (250) TC42-	
15.75 (400)	3.44 (87.5)	4.35 (110.5)	18.90 (480)	10.63 (270)	087-100/400	087-125/400	087-150/400	087-175/400	087-200/400	087-250/400	≈ 1.32 (1.97)
15.75 (400)	3.94 (100)	4.84 (123)	18.90 (480)	9.84 (250)	10-100/400	10-125/400	10-150/400	10-175/400	10-200/400	10-250/400	≈ 1.36 (2.03)
15.75 (400)	4.25 (108)	5.16 (131)	18.90 (480)	9.84 (250)	—	11-125/400	11-150/400	11-175/400	11-200/400	11-250/400	≈ 1.39 (2.07)
15.75 (400)	4.92 (125)	5.83 (148)	18.90 (480)	8.66 (220)	—	12-125/400	12-150/400	12-175/400	12-200/400	12-250/400	≈ 1.45 (2.16)
15.75 (400)	5.41 (137.5)	6.32 (160.5)	18.90 (480)	8.27 (210)	—	137-125/400	137-150/400	137-175/400	137-200/400	137-250/400	≈ 1.49 (2.22)
15.75 (400)	5.91 (150)	6.81 (173)	18.90 (480)	7.87 (200)	—	—	—	15-175/400	15-200/400	15-250/400	≈ 1.54 (2.29)
15.75 (400)	6.40 (162.5)	7.30 (185.5)	18.90 (480)	7.48 (190)	—	—	—	—	162-200/400	162-250/400	≈ 1.60 (2.35)
15.75 (400)	6.61 (168)	7.52 (191)	18.90 (480)	7.48 (190)	—	—	—	—	—	17-250/400	≈ 1.60 (2.38)
15.75 (400)	6.89 (175)	7.80 (198)	18.90 (480)	7.09 (180)	—	—	—	—	—	18-250/400	≈ 1.62 (2.41)
19.69 (500)	3.94 (100)	4.84 (123)	22.83 (580)	13.78 (350)	10-100/500	10-125/500	10-150/500	10-175/500	10-200/500	10-250/500	≈ 1.36 (2.03)
19.69 (500)	4.25 (108)	5.16 (131)	22.83 (580)	13.78 (350)	—	11-125/500	11-150/500	11-175/500	11-200/500	11-250/500	≈ 1.39 (2.07)
19.69 (500)	4.92 (125)	5.83 (148)	22.83 (580)	12.60 (320)	—	12-125/500	12-150/500	12-175/500	12-200/500	12-250/500	≈ 1.45 (2.16)
19.69 (500)	5.41 (137.5)	6.32 (160.5)	22.83 (580)	12.20 (310)	—	—	137-150/500	137-175/500	137-200/500	137-250/500	≈ 1.49 (2.22)
19.69 (500)	5.91 (150)	6.81 (173)	22.83 (580)	11.81 (300)	—	—	15-150/500	15-175/500	15-200/500	15-250/500	≈ 1.54 (2.29)
19.69 (500)	6.40 (162.5)	7.30 (185.5)	22.83 (580)	11.42 (290)	—	—	162-150/500	162-175/500	162-200/500	162-250/500	≈ 1.60 (2.35)
19.69 (500)	6.61 (168)	7.52 (191)	22.83 (580)	11.42 (290)	—	—	—	17-175/500	17-200/500	17-250/500	≈ 1.60 (2.38)
19.69 (500)	6.89 (175)	7.80 (198)	22.83 (580)	11.02 (280)	—	—	—	—	18-200/500	18-250/500	≈ 1.62 (2.41)
19.69 (500)	7.38 (187.5)	8.29 (210.5)	22.83 (580)	11.02 (280)	—	—	—	—	187-200/500	187-250/500	≈ 1.67 (2.48)
19.69 (500)	7.87 (200)	8.78 (223)	22.83 (580)	9.84 (250)	—	—	—	—	20-200/500	20-250/500	≈ 1.71 (2.54)
23.62 (600)	4.25 (108)	5.16 (131)	26.77 (680)	17.72 (450)	11-100/600	11-125/600	11-150/600	11-175/600	11-200/600	—	≈ 1.39 (2.07)
23.62 (600)	4.92 (125)	5.83 (148)	26.77 (680)	16.54 (420)	12-100/600	12-125/600	12-150/600	12-175/600	12-200/600	12-250/600	≈ 1.45 (2.16)
23.62 (600)	5.41 (137.5)	6.32 (160.5)	26.77 (680)	16.14 (410)	137-100/600	137-125/600	137-150/600	137-175/600	137-200/600	137-250/600	≈ 1.49 (2.22)
23.62 (600)	5.91 (150)	6.81 (173)	26.77 (680)	15.75 (400)	15-100/600	15-125/600	15-150/600	15-175/600	15-200/600	15-250/600	≈ 1.54 (2.29)
23.62 (600)	6.40 (162.5)	7.30 (185.5)	26.77 (680)	15.35 (390)	—	162-125/600	162-150/600	162-175/600	162-200/600	162-250/600	≈ 1.60 (2.35)
23.62 (600)	6.61 (168)	7.52 (191)	26.77 (680)	15.35 (390)	—	—	17-150/600	17-175/600	17-200/600	17-250/600	≈ 1.60 (2.38)
23.62 (600)	6.89 (175)	7.80 (198)	26.77 (680)	14.96 (380)	—	—	18-150/600	18-175/600	18-200/600	18-250/600	≈ 1.62 (2.41)
23.62 (600)	7.38 (187.5)	8.29 (210.5)	26.77 (680)	14.96 (380)	—	—	187-150/600	187-175/600	187-200/600	187-250/600	≈ 1.67 (2.48)
23.62 (600)	7.87 (200)	8.78 (223)	26.77 (680)	13.78 (350)	—	—	20-150/600	20-175/600	20-200/600	20-250/600	≈ 1.71 (2.54)
25.59 (650)	4.92 (125)	5.83 (148)	28.74 (730)	18.50 (470)	12-100/650	12-125/650	12-150/650	12-175/650	12-200/650	12-250/650	≈ 1.45 (2.16)
25.59 (650)	5.41 (137.5)	6.32 (160.5)	28.74 (730)	18.11 (460)	137-100/650	137-125/650	137-150/650	137-175/650	137-200/650	137-250/650	≈ 1.49 (2.22)
25.59 (650)	5.91 (150)	6.81 (173)	28.74 (730)	17.72 (450)	15-100/650	15-125/650	15-150/650	15-175/650	15-200/650	15-250/650	≈ 1.54 (2.29)
25.59 (650)	6.40 (162.5)	7.30 (185.5)	28.74 (730)	17.32 (440)	—	162-125/650	162-150/650	162-175/650	162-200/650	162-250/650	≈ 1.60 (2.35)
25.59 (650)	6.61 (168)	7.52 (191)	28.74 (730)	16.93 (430)	—	17-125/650	17-150/650	17-175/650	17-200/650	17-250/650	≈ 1.60 (2.38)
25.59 (650)	6.89 (175)	7.80 (198)	28.74 (730)	16.93 (430)	—	—	18-150/650	18-175/650	18-200/650	18-250/650	≈ 1.62 (2.41)
25.59 (650)	7.38 (187.5)	8.29 (210.5)	28.74 (730)	16.54 (420)	—	—	187-150/650	187-175/650	187-200/650	187-250/650	≈ 1.67 (2.48)
25.59 (650)	7.87 (200)	8.78 (223)	28.74 (730)	15.75 (400)	—	—	20-150/650	20-175/650	20-200/650	20-250/650	≈ 1.71 (2.54)
29.52 (750)	5.41 (137.5)	6.32 (160.5)	32.67 (830)	22.05 (560)	137-100/750	137-125/750	137-150/750	137-175/750	137-200/750	137-250/750	≈ 1.49 (2.22)
29.52 (750)	5.91 (150)	6.81 (173)	32.67 (830)	21.65 (550)	15-100/750	15-125/750	15-150/750	15-175/750	15-200/750	15-250/750	≈ 1.54 (2.29)
29.52 (750)	6.40 (162.5)	7.30 (185.5)	32.67 (830)	21.26 (540)	—	162-125/750	162-150/750	162-175/750	162-200/750	162-250/750	≈ 1.60 (2.35)
29.52 (750)	6.61 (168)	7.52 (191)	32.67 (830)	21.26 (540)	—	17-125/750	17-150/750	17-175/750	17-200/750	17-250/750	≈ 1.60 (2.38)
29.52 (750)	6.89 (175)	7.80 (198)	32.67 (830)	20.87 (530)	—	18-125/750	18-150/750	18-175/750	18-200/750	18-250/750	≈ 1.62 (2.41)
29.52 (750)	7.38 (187.5)	8.29 (210.5)	32.67 (830)	20.47 (520)	—	187-125/750	187-150/750	187-175/750	187-200/750	187-250/750	≈ 1.67 (2.48)
29.52 (750)	7.87 (200)	8.78 (223)	32.67 (830)	19.69 (500)	—	20-125/750	20-150/750	20-175/750	20-200/750	20-250/750	≈ 1.71 (2.54)
33.46 (850)	5.91 (150)	6.81 (173)	36.61 (930)	25.59 (650)	15-100/850	15-125/850	15-150/850	15-175/850	15-200/850	15-250/850	≈ 1.54 (2.29)
33.46 (850)	6.40 (162.5)	7.30 (185.5)	36.61 (930)	25.20 (640)	162-100/850	162-125/850	162-150/850	162-175/850	162-200/850	162-250/850	≈ 1.60 (2.35)
33.46 (850)	6.61 (168)	7.52 (191)	36.61 (930)	24.80 (630)	17-100/850	17-125/850	17-150/850	17-175/850	17-200/850	17-250/850	≈ 1.60 (2.38)
33.46 (850)	6.89 (175)	7.80 (198)	36.61 (930)	24.80 (630)	—	18-125/850	18-150/850	18-175/850	18-200/850	18-250/850	≈ 1.62 (2.41)
33.46 (850)	7.38 (187.5)	8.29 (210.5)	36.61 (930)	24.41 (620)	—	187-125/850	187-150/850	187-175/850	187-200/850	187-250/850	≈ 1.67 (2.48)
33.46 (850)	7.87 (200)	8.78 (223)	36.61 (930)	23.62 (600)	—	20-125/850	20-150/850	20-175/850	20-200/850	20-250/850	≈ 1.71 (2.54)

R	3.94 (100)	4.92 (125)	5.91 (150)	6.89 (175)	7.87 (200)	9.84 (250)
H ^{-0.25}	10.51 (267)	12.48 (317)	14.45 (367)	16.42 (417)	18.39 (467)	22.32 (567)
K	19.69 (500)	25.59 (650)	28.54 (725)	31.50 (800)	34.45 (875)	41.34 (1050)

Pitch T per link = 2.64" (67mm)
Links per ft. (m) = 4.5 (15)

AR	R Bend radius					
	3.94 (100)	4.92 (125)	5.91 (150)	6.89 (175)	7.87 (200)	9.84 (250)
in. (mm)	A1	A1	A1	A1	A1	A1
400	1.93 (49)	1.97 (50)	2.01 (51)	2.09 (53)	2.09 (53)	2.09 (53)
500	2.52 (64)	2.56 (65)	2.60 (66)	2.64 (67)	2.68 (68)	2.80 (71)
600	3.11 (79)	3.11 (79)	3.15 (80)	3.19 (81)	3.23 (82)	3.35 (85)
650	3.39 (86)	3.43 (87)	3.43 (87)	3.46 (88)	3.50 (89)	3.62 (92)
750	3.98 (101)	3.98 (101)	4.02 (102)	4.06 (103)	4.09 (104)	4.17 (106)
850	4.57 (116)	4.57 (116)	4.61 (117)	4.65 (118)	4.65 (118)	4.72 (120)

Dimension A1 always with tolerance of $\pm .10"$ (2.5 mm)

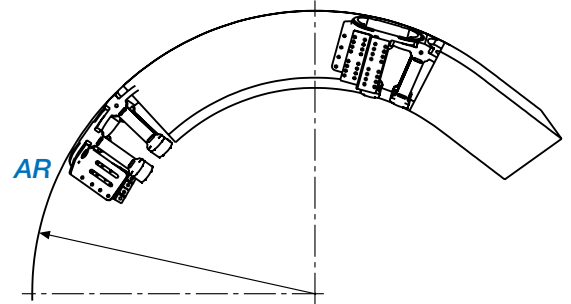

Note: Outer radius *AR* (see drawing) determines dimension *A1*!

Dimensions

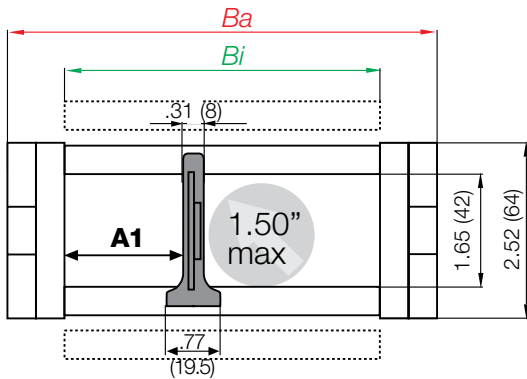

Part No. structure

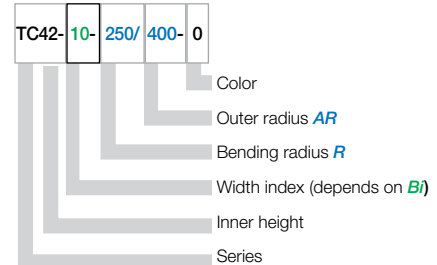

TC42-10-250/400-0 = e-chain® snap-open along inner radius from both sides
Bi 87.5 mm inner width, *R* 250 mm bending radius / *AR* 400 mm outer radius, color black

Interior Separation

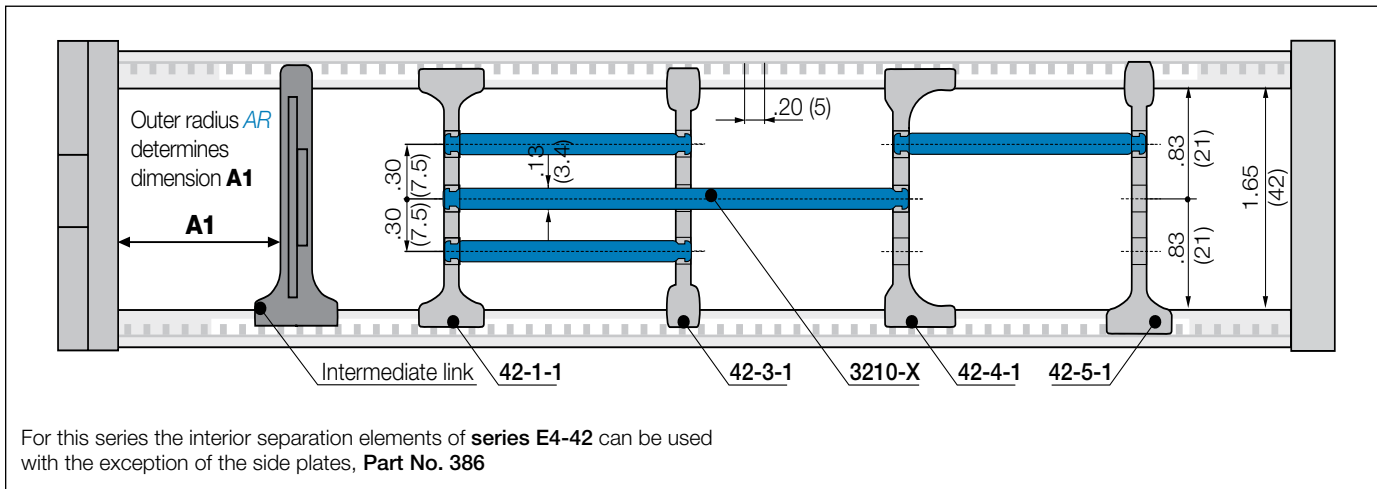

For this series the interior separation elements of series E4-42 can be used with the exception of the side plates, Part No. 386

- AR* = Outer radius
- R* = Bending radius
- X*₁ = Inner machine construction space
- X*₂ = Outer radius *AR*, including clearance
- Ba* = Outer width
- Bi* = Inner width
- H* = Nominal clearance height
- K* = Add-on for bending radius
- A1* = Distance intermediate link
- T* = Pitch

Dimensions

AR	Bi	Ba	X ₂	X ₁	R Bend radius					Weight lbs/ft (kg/m)
					5.91 (150) TC56-	7.87 (200) TC56-	9.84 (250) TC56-	11.81 (300) TC56-	15.75 (400) TC56-	
25.59 (650)	4.92 (125)	6.10 (155)	28.74 (730)	18.50 (470)	12-150/650	12-200/650	12-250/650	12-300/650	—	≈ 2.32 (3.45)
25.59 (650)	5.41 (137.5)	6.61 (168)	28.74 (730)	18.11 (460)	—	13-200/650	13-250/650	13-300/650	13-400/650	≈ 2.38 (3.54)
25.59 (650)	5.91 (150)	7.09 (180)	28.74 (730)	17.72 (450)	—	—	15-250/650	15-300/650	15-400/650	≈ 2.43 (3.62)
25.59 (650)	6.40 (162.5)	7.60 (193)	28.74 (730)	17.32 (440)	—	—	16-250/650	16-300/650	16-400/650	≈ 2.49 (3.70)
25.59 (650)	6.89 (175)	8.07 (205)	28.74 (730)	16.93 (430)	—	—	—	17-300/650	17-400/650	≈ 2.54 (3.78)
25.59 (650)	7.38 (187.5)	8.58 (218)	28.74 (730)	16.54 (420)	—	—	—	18-300/650	18-400/650	≈ 2.60 (3.87)
25.59 (650)	7.87 (200)	9.06 (230)	28.74 (730)	15.75 (400)	—	—	—	—	20-400/650	≈ 2.65 (3.95)
29.53 (750)	5.41 (137.5)	6.61 (168)	32.68 (830)	22.05 (560)	13-150/750	13-200/750	13-250/750	13-300/750	—	≈ 2.38 (3.54)
29.53 (750)	5.91 (150)	7.09 (180)	32.68 (830)	21.65 (550)	—	15-200/750	15-250/750	15-300/750	15-400/750	≈ 2.43 (3.62)
29.53 (750)	6.40 (162.5)	7.60 (193)	32.68 (830)	21.26 (540)	—	16-200/750	16-250/750	16-300/750	16-400/750	≈ 2.49 (3.70)
29.53 (750)	6.89 (175)	8.07 (205)	32.68 (830)	20.87 (530)	—	—	17-250/750	17-300/750	17-400/750	≈ 2.54 (3.78)
29.53 (750)	7.38 (187.5)	8.58 (218)	32.68 (830)	20.47 (520)	—	—	18-250/750	18-300/750	18-400/750	≈ 2.60 (3.87)
29.53 (750)	7.87 (200)	9.06 (230)	32.68 (830)	19.69 (500)	—	—	20-250/750	20-300/750	20-400/750	≈ 2.65 (3.95)
33.46 (850)	5.91 (150)	7.09 (180)	36.61 (930)	25.59 (650)	15-150/850	15-200/850	15-250/850	15-300/850	15-400/850	≈ 2.43 (3.62)
33.46 (850)	6.40 (162.5)	7.60 (193)	36.61 (930)	25.20 (640)	16-150/850	16-200/850	16-250/850	16-300/850	16-400/850	≈ 2.49 (3.70)
33.46 (850)	6.89 (175)	8.07 (205)	36.61 (930)	24.80 (630)	17-150/850	17-200/850	17-250/850	17-300/850	17-400/850	≈ 2.54 (3.78)
33.46 (850)	7.38 (187.5)	8.58 (218)	36.61 (930)	24.41 (620)	—	18-200/850	18-250/850	18-300/850	18-400/850	≈ 2.60 (3.87)
33.46 (850)	7.87 (200)	9.06 (230)	36.61 (930)	23.62 (600)	—	—	20-250/850	20-300/850	20-400/850	≈ 2.65 (3.95)

R	5.91 (150)	7.87 (200)	9.84 (250)	11.81 (300)	15.75 (400)
H ⁰ / ₂₅	15.12 (384)	19.06 (484)	22.99 (584)	26.93 (684)	34.80 (884)
K	29.53 (750)	35.43 (900)	41.34 (1050)	48.23 (1225)	57.09 (1450)

Pitch T per link = 3.58" (91mm)

Links per ft. (m) = 3.4 (11)



twisterchain in a guide trough type 01 for rotary movement on an articulated robot - long service life and robust: tested successfully for more than 1,000,000 cycles

AR	R Bend radius				
	5.91 (150)	7.87 (200)	9.84 (250)	11.81 (300)	15.75 (400)
in. (mm)	A1 in. (mm)	A1 in. (mm)	A1 in. (mm)	A1 in. (mm)	A1 in. (mm)
650	3.27 (83)	3.35 (85)	3.46 (88)	3.54 (90)	3.82 (97)
750	3.86 (98)	3.98 (101)	4.02 (102)	4.06 (103)	4.33 (110)
850	4.45 (113)	4.57 (116)	4.61 (117)	4.65 (118)	4.88 (124)

Dimension A1 always with tolerance of $\pm .10"$ (2.5 mm)

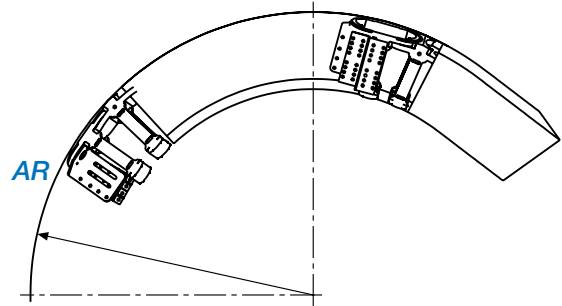

Note: Outer radius *AR* (see drawing) determines dimension *A1*!

Dimensions

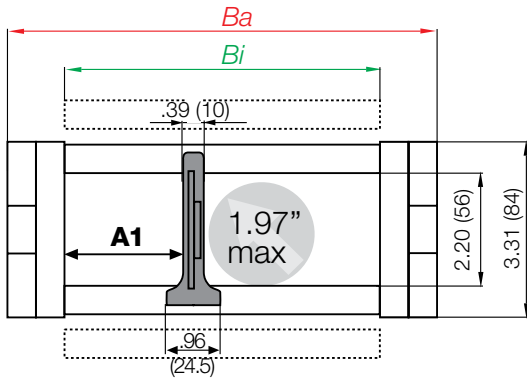

Part No. structure

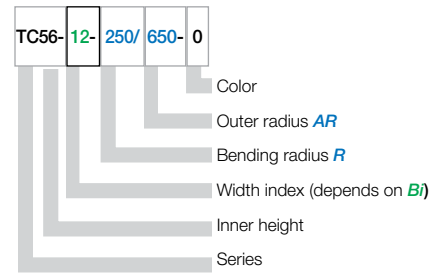

TC56-12-250/650-0 = e-chain® snap-open along inner radius from both sides
Bi 125 mm inner width, *R* 250 mm bending radius / *AR* 650 mm outer radius, color black

Interior Separation

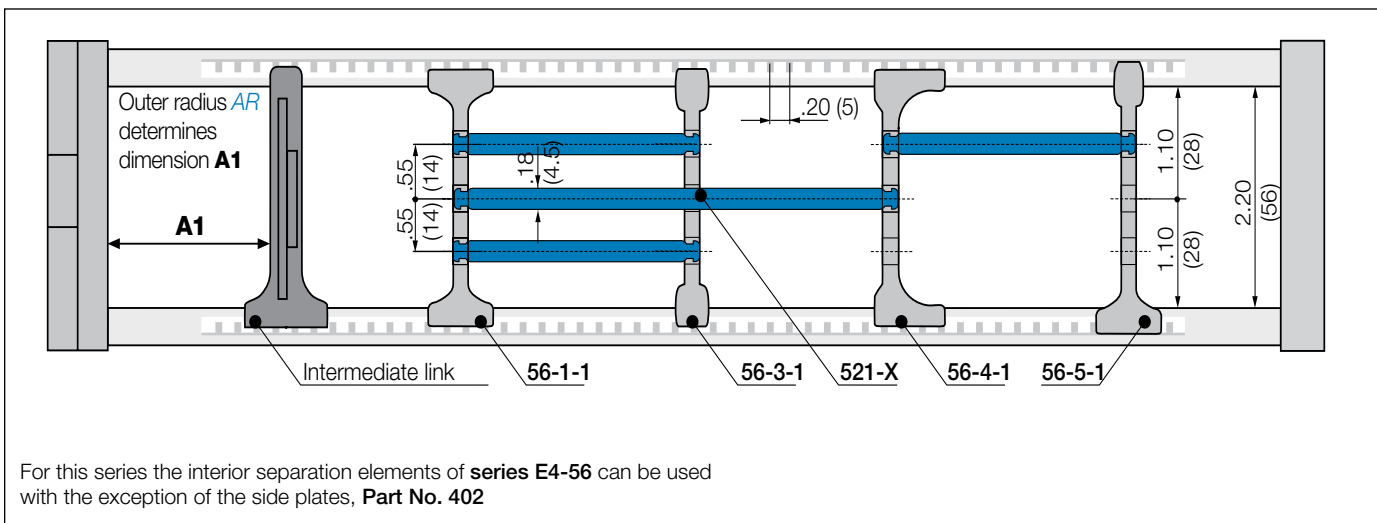

For this series the interior separation elements of series E4-56 can be used with the exception of the side plates, Part No. 402

- AR* = Outer radius
- R* = Bending radius
- X1* = Inner machine construction space
- X2* = Outer radius *AR*, including clearance
- Ba* = Outer width
- Bi* = Inner width
- H* = Nominal clearance height
- K* = Add-on for bending radius
- A1* = Distance intermediate link
- T* = Pitch

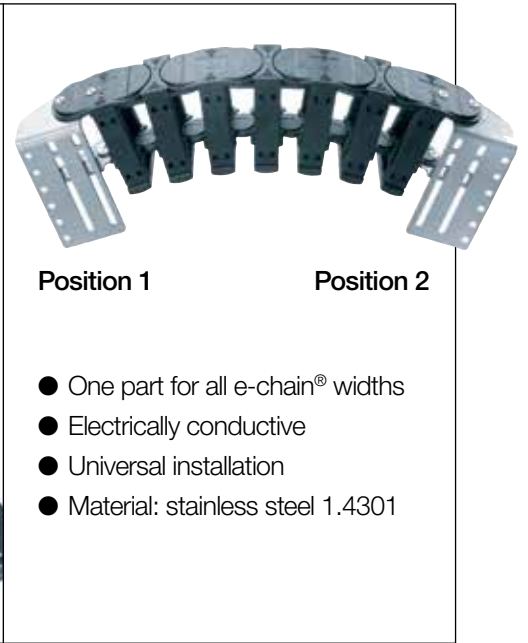
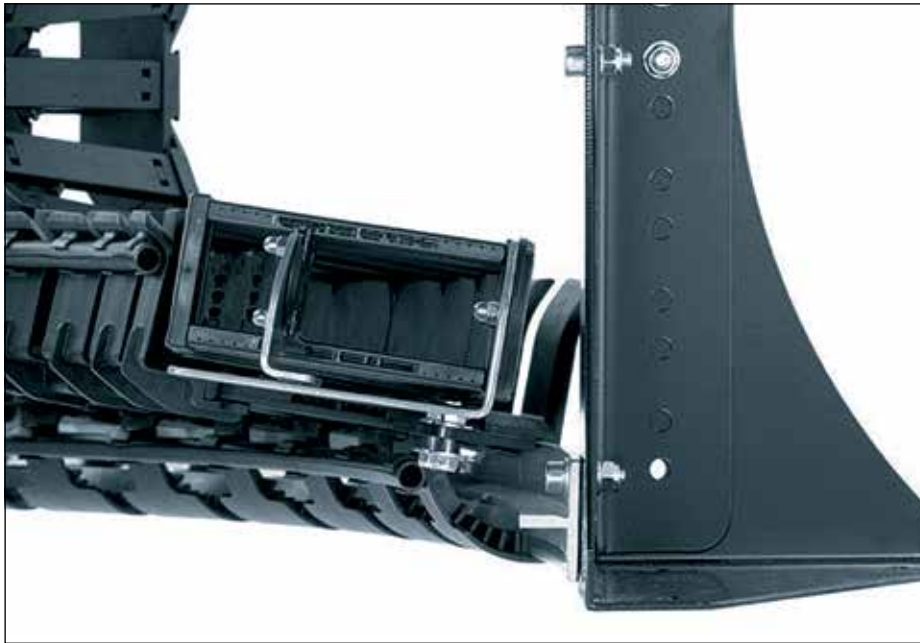

Steel, one-piece design for twisterchain (2nd generation) |
Recommended for unsupported and circular applications

For series	Part No. full set	Part No. position 1	Part No. position 2
TC32	▶ TC3200-34	TC3200-30	TC3200-40
TC42	▶ TC4200-34	TC4200-30	TC4200-40
TC56	▶ TC5600-34	TC5600-30	TC5600-40

The guide trough must be mounted at the fixed point of the twisterchain.

The following bolted connections are permitted:

- Bore Hole: 4 x Ø 6.6 - 7 mm
- Mounting only with bolts: 4 x bolts M6

Other connection dimensions for mounting the guide trough Type 01

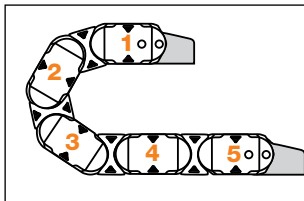

Note: twisterchain e-chains® must always start and end on an outer side-link. There must always be an odd number of links. At the moving end an outer side link always forms the first e-chain® link. Please note when calculating!

Part No. structure

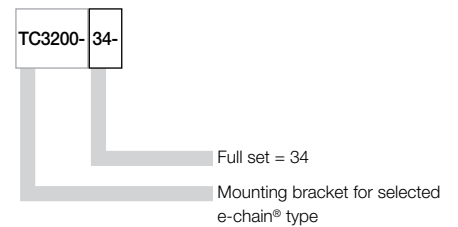

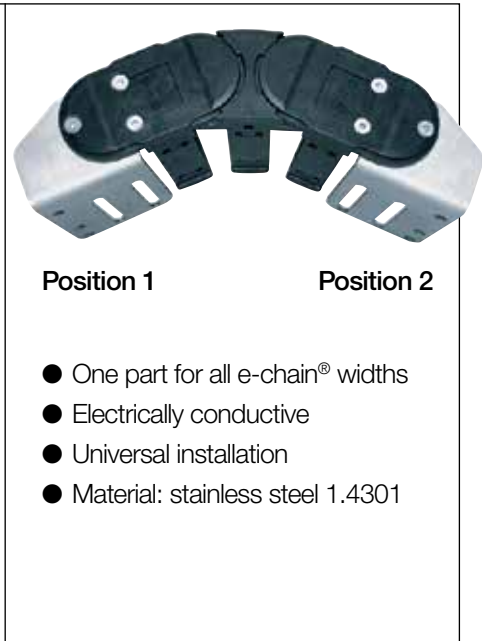
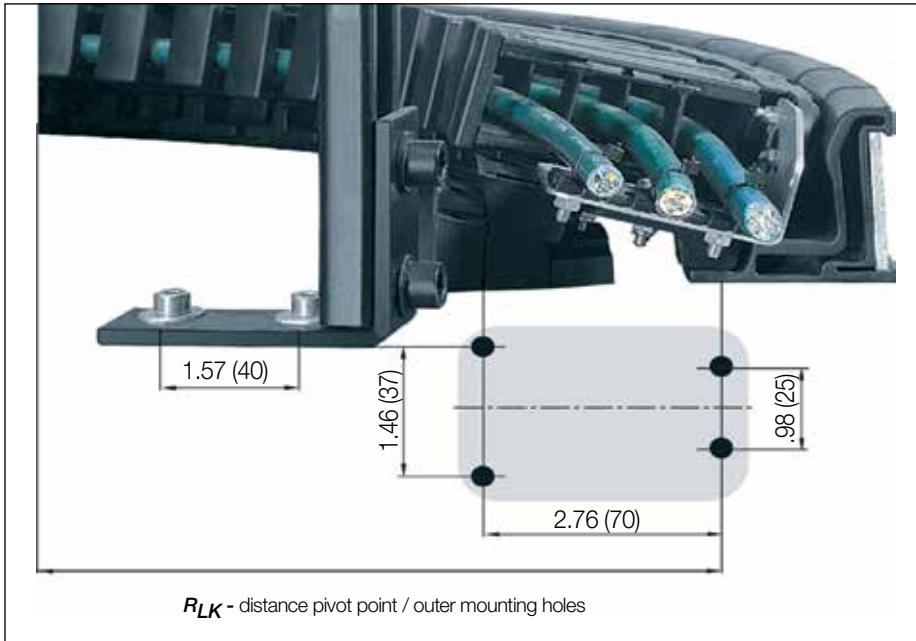

Steel, one-piece design for twisterchain (1st generation) | Recommended for unsupported and circular applications

For series	Part No. full set	Part No. position 1	Part No. position 2
2208	▶ 22080-34	22080-30	22080-40

The guide trough must be mounted at the fixed point of the twisterchain as shown by the drilling template in the illustration. The following bolted connections are permitted:

- Through-hole: 4 x Ø .26 - .28" (6.6 - 7 mm)
- Mounting only with bolts: 4 x M6 bolts

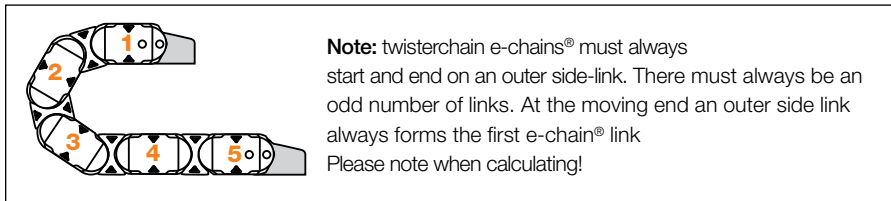

Part No. structure

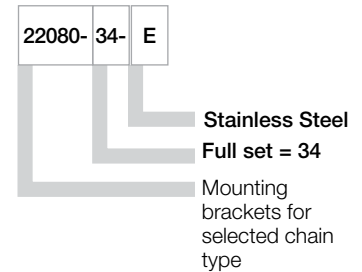

Full set, for both ends

22080- 34

Single-part order - Part 1:

22080- 3

Single-part order - Part 2:

22080- 4

Save installation time and cost - better guidance for circular movement - increase service life!

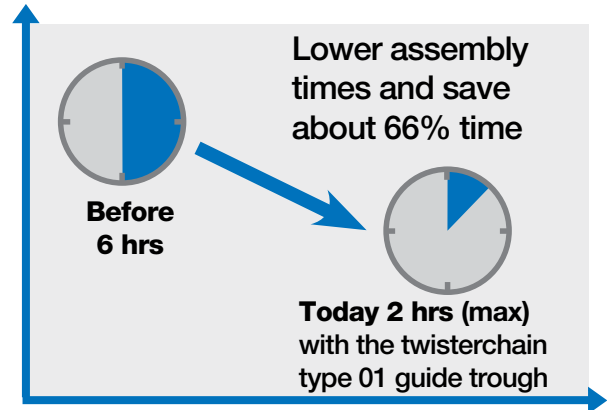
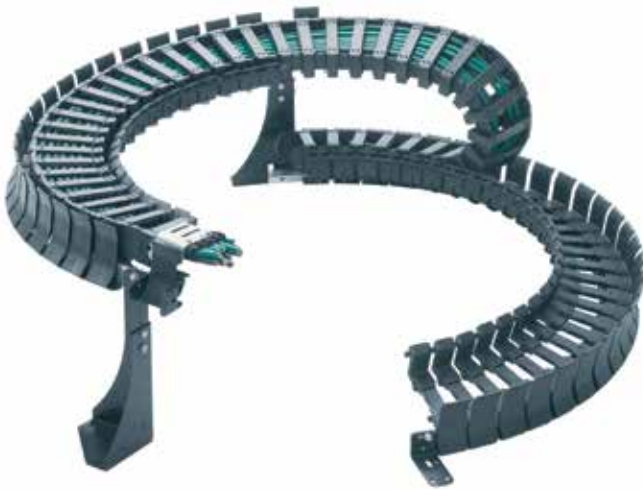

With the new twisterchain trough type 01, the previously complex adjustment work is clearly minimized. Assembly time is reduced from 6 hours to 2 hours. While reducing noise levels, travel speed and service life can be increased, thanks to an almost all-plastic design. Available for all twisterchain of the new and previous range.

- Suitable for high dynamics, because of the full and all-side guidance of the twisterchain
- Much smoother and quieter motion of the twisterchain in the trough due to continuous guidance of upper run
- Upper run guided in the new polymer trough over the full width
- Preassembled delivery possible
- Easy adjustment and alignment and handling
- Assembly time reduced from 6 hours to 2 hours

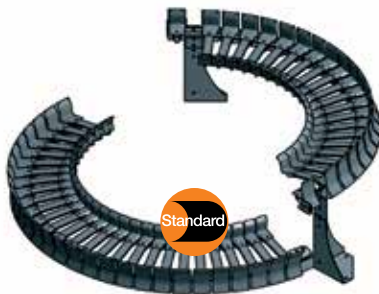

9XXX-31 Complete troughs
(with base support, height adjustment and attachment angles)



9XXX-32 Upper and lower run trough
without base support and height adjustment
Special variant: Customer builds base support



9XXX-30 Lower run trough
with attachment angles
Special option:
Customer builds upper run trough

Product Range - twisterchain Guide Troughs Type 01

For Series	Outer radius AR [mm]	Rotation angle from-up to α (°)	Part No. Trough complete	Part No. Trough upper/lower run	Part No. Trough lower run
TC32 / TC42	400	0 - 90°	9XXXX-31-90-400/ <i>Bi-R</i>	9XXXX-32-90-400/ <i>Bi-R</i>	9XXXX-30-90-750/ <i>Bi-R</i>
		90° - 180°	9XXXX-31-180-400/ <i>Bi-R</i>	9XXXX-32-180-400/ <i>Bi-R</i>	9XXXX-30-180-400/ <i>Bi-R</i>
		180° - 270°	9XXXX-31-270-400/ <i>Bi-R</i>	9XXXX-32-270-400/ <i>Bi-R</i>	9XXXX-30-270-400/ <i>Bi-R</i>
		270° - 360°	9XXXX-31-360-400/ <i>Bi-R</i>	9XXXX-32-360-400/ <i>Bi-R</i>	9XXXX-30-360-400/ <i>Bi-R</i>
	500	0 - 90°	9XXXX-31-90-500/ <i>Bi-R</i>	9XXXX-32-90-500/ <i>Bi-R</i>	9XXXX-30-90-500/ <i>Bi-R</i>
		90° - 180°	9XXXX-31-180-500/ <i>Bi-R</i>	9XXXX-32-180-500/ <i>Bi-R</i>	9XXXX-30-180-500/ <i>Bi-R</i>
		180° - 270°	9XXXX-31-270-500/ <i>Bi-R</i>	9XXXX-32-270-500/ <i>Bi-R</i>	9XXXX-30-270-500/ <i>Bi-R</i>
		270° - 360°	9XXXX-31-360-500/ <i>Bi-R</i>	9XXXX-32-360-500/ <i>Bi-R</i>	9XXXX-30-360-500/ <i>Bi-R</i>
	600	0 - 90°	9XXXX-31-90-600/ <i>Bi-R</i>	9XXXX-32-90-600/ <i>Bi-R</i>	9XXXX-30-90-600/ <i>Bi-R</i>
		90° - 180°	9XXXX-31-180-600/ <i>Bi-R</i>	9XXXX-32-180-600/ <i>Bi-R</i>	9XXXX-30-180-600/ <i>Bi-R</i>
		180° - 270°	9XXXX-31-270-600/ <i>Bi-R</i>	9XXXX-32-270-600/ <i>Bi-R</i>	9XXXX-30-270-600/ <i>Bi-R</i>
		270° - 360°	9XXXX-31-360-600/ <i>Bi-R</i>	9XXXX-32-360-600/ <i>Bi-R</i>	9XXXX-30-360-600/ <i>Bi-R</i>
TC56	650	0 - 90°	9XXXX-31-90-650/ <i>Bi-R</i>	9XXXX-32-90-650/ <i>Bi-R</i>	9XXXX-30-90-650/ <i>Bi-R</i>
		90° - 180°	9XXXX-31-180-650/ <i>Bi-R</i>	9XXXX-32-180-650/ <i>Bi-R</i>	9XXXX-30-180-650/ <i>Bi-R</i>
		180° - 270°	9XXXX-31-270-650/ <i>Bi-R</i>	9XXXX-32-270-650/ <i>Bi-R</i>	9XXXX-30-270-650/ <i>Bi-R</i>
		270° - 360°	9XXXX-31-360-650/ <i>Bi-R</i>	9XXXX-32-360-650/ <i>Bi-R</i>	9XXXX-30-360-650/ <i>Bi-R</i>
	750	0 - 90°	9XXXX-31-90-750/ <i>Bi-R</i>	9XXXX-32-90-750/ <i>Bi-R</i>	9XXXX-30-90-750/ <i>Bi-R</i>
		90° - 180°	9XXXX-31-180-750/ <i>Bi-R</i>	9XXXX-32-180-750/ <i>Bi-R</i>	9XXXX-30-180-750/ <i>Bi-R</i>
		180° - 270°	9XXXX-31-270-750/ <i>Bi-R</i>	9XXXX-32-270-750/ <i>Bi-R</i>	9XXXX-30-270-750/ <i>Bi-R</i>
		270° - 360°	9XXXX-31-360-750/ <i>Bi-R</i>	9XXXX-32-360-750/ <i>Bi-R</i>	9XXXX-30-360-750/ <i>Bi-R</i>
	850	0 - 90°	9XXXX-31-90-850/ <i>Bi-R</i>	9XXXX-32-90-850/ <i>Bi-R</i>	9XXXX-30-90-850/ <i>Bi-R</i>
		90° - 180°	9XXXX-31-180-850/ <i>Bi-R</i>	9XXXX-32-180-850/ <i>Bi-R</i>	9XXXX-30-180-850/ <i>Bi-R</i>
		180° - 270°	9XXXX-31-270-850/ <i>Bi-R</i>	9XXXX-32-270-850/ <i>Bi-R</i>	9XXXX-30-270-850/ <i>Bi-R</i>
		270° - 360°	9XXXX-31-360-850/ <i>Bi-R</i>	9XXXX-32-360-850/ <i>Bi-R</i>	9XXXX-30-360-850/ <i>Bi-R</i>

Supplement Part No. 9XXXX with required series (TC32, TC42 or TC56), *Bi* and bending radius *R* ▶ 9TC32-31-180-600/12-250

9TC32-31-180-600/12.250



Order key
Guide trough

9XXXX-31-180-600/*Bi*. *R*



R - Bending radius, please add appropriate value

Bi - Width index, please add appropriate value

Outer radius e-chain®

Rotation angle of application (90°, 180°, 270°, 360°)

Trough version

Guide Trough of selected series

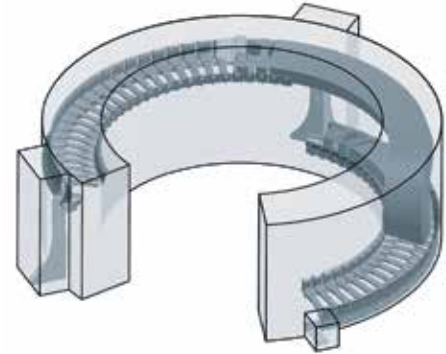
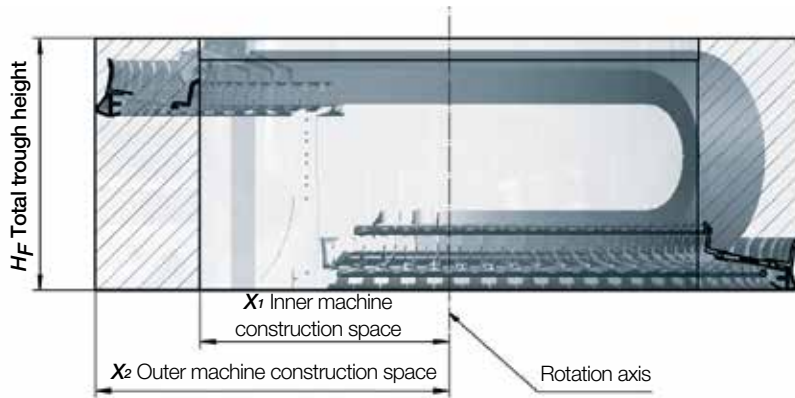

Minimum required construction space of twisterchain Guide Trough system

Installation Dimensions

X_1 Inner machine construction space and
 X_2 Outer machine construction space of Guide Trough

AR in. (mm)	X_2 mm	X_1 (mm) depending on Bi in. (mm)											
TC32		3.44 (87.5)	3.94 (100)	4.25 (108)	4.92 (125)	5.41 (137.5)	5.91 (150)						
15.75 (400)	18.90 (480)	10.63 (270)	9.84 (250)	9.84 (250)	8.66 (220)	8.27 (210)	7.87 (200)						
19.69 (500)	22.83 (580)	-	13.78 (350)	13.78 (350)	12.60 (320)	12.20 (310)	11.81 (300)						
23.62 (600)	26.77 (680)	-	-	17.72 (450)	16.54 (420)	16.14 (410)	15.75 (400)						
TC42		3.44 (87.5)	3.94 (100)	4.25 (108)	4.92 (125)	5.41 (137.5)	5.91 (150)	162.5	168	175	187.5	200	
15.75 (400)	18.90 (480)	10.63 (270)	9.84 (250)	9.84 (250)	8.66 (220)	8.27 (210)	7.87 (200)	7.48 (190)	7.48 (190)	7.09 (180)	-	-	
19.69 (500)	22.83 (580)	-	13.78 (350)	13.78 (350)	12.60 (320)	12.20 (310)	11.81 (300)	11.42 (290)	11.42 (290)	11.02 (280)	11.02 (280)	9.84 (250)	
23.62 (600)	26.77 (680)	-	-	17.72 (450)	16.54 (420)	16.14 (410)	15.75 (400)	15.35 (390)	15.35 (390)	14.96 (380)	14.96 (380)	13.78 (350)	
TC56		-	-	-	125	137.5	150	162.5	-	175	187.5	200	
25.59 (650)	28.74 (730)	-	-	-	18.50 (470)	18.11 (460)	17.72 (450)	17.32 (440)	-	16.93 (430)	16.54 (420)	15.75 (400)	
29.53 (750)	32.68 (830)	-	-	-	-	22.05 (560)	21.65 (550)	21.26 (540)	-	20.87 (530)	20.47 (520)	19.69 (500)	
33.46 (850)	36.61 (930)	-	-	-	-	-	25.59 (650)	25.20 (640)	-	24.80 (630)	24.41 (620)	23.62 (600)	

Construction height H_F depending on bending radius of twisterchain Guide Trough

R in. (mm)	3.94 (100)	4.92 (125)	5.91 (150)	6.89 (175)	7.87 (200)	9.84 (250)	11.81 (300)	15.75 (400)
Series	H_F Construction height in. (mm)							
TC32	14.57 (370)	16.54 (420)	18.50 (470)	20.47 (520)	22.44 (570)	26.38 (670)	-	-
TC42	14.96 (380)	16.93 (430)	18.90 (480)	20.87 (530)	22.83 (580)	26.77 (680)	-	-
TC56	-	-	19.69 (500)	-	23.62 (600)	27.56 (700)	31.50 (800)	39.37 (1000)

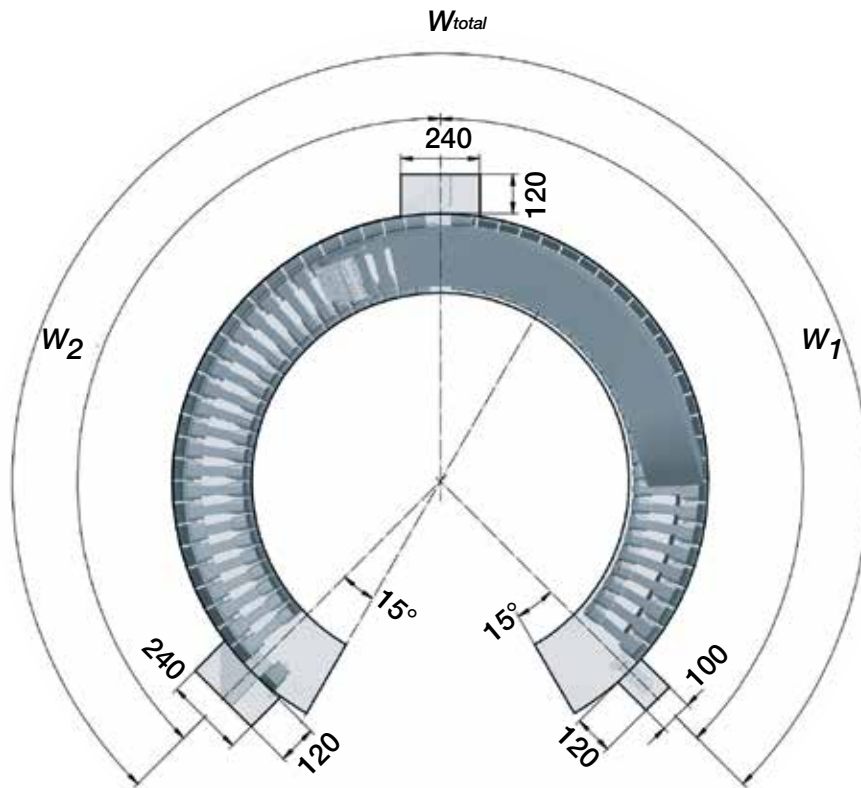

Rotation angle | $W_1 + W_{total}$

W_{total} rotation angle System	W_1 rotation angle of lower run trough
90°	45°
180°	90°
270°	135°
360°	180°

Rotation angle for 360° - W_2 angle of upper run (°) twisterchain Guide Trough

AR (mm)	Series	R [mm]	100	125	150	175	200	250	300	400
W_2 Rotation angle										
400	TC32/TC42		90°	90°	90°	90°	90°	90°	90°	90°
500	TC32/TC42		90°	90°	90°	90°	90°	90°	90°	90°
600	TC32/TC42		135°	135°	135°	135°	90°	90°	90°	90°
650	TC56		135°	135°	135°	135°	90°	90°	90°	90°
750	TC56		135°	135°	135°	135°	135°	135°	90°	90°
850	TC56		135°	135°	135°	135°	135°	135°	135°	135°



AR= Outer radius e-chain®
IR = Inner radius e-chain®
R = Bending radius

X_1 = Inner machine construction space
 X_2 = Outer radius AR, including clearance
 H_F = Total trough height

W_1 = Angle of lower run
 W_2 = Angle of upper run
 W_{total} = Rotation angle of system

Type 02 guide trough for twisterchain classic (1st generation) series 2208

- Support for the upper run and guidance of twisterchain classic series 2208
- Angle of rotation up to 360° possible, 400° upon request
- The modular design of the guide trough makes it possible to connect a large number of e-chains®, radii, circle and bend radii by using the same trough sections
- If the chain radius changes, the trough can simply be adapted without purchasing a completely new trough
- The specified part number shown below includes the complete trough system



This bottom stanchion (pictured above in red) is required only if the support for the upper run (from a 180° rotation angle) cannot be mounted on the machine.

Product range - Guide trough Type 02 for twisterchain classic (1st generation)

Part No. Series	Outer radius AR	Rotation angle α [°]	Trough assembly Standard	Trough assembly with bottom support	Number of support
2208	11.81" (300 mm)	45 - 100	92208 -4-45-300/ <i>Bi</i> - <i>R</i>	Not necessary	
		>100 - 180	92208 -4-90-300/ <i>Bi</i> - <i>R</i>	Not necessary	
		>180 - 270	92208 -4-135-300/ <i>Bi</i> - <i>R</i> *	92208-5-135-300/ <i>Bi</i> - <i>R</i>	1
		>270 - 360	92208 -4-180-300/ <i>Bi</i> - <i>R</i> **	92208-5-180-300/ <i>Bi</i> - <i>R</i>	2

Supplement Part No. with required *Bi* and bend radius *R* ► 92208-5-180-600/112-150

* These troughs feature **one support** for the upper run, without bottom stanchion (See red portion of above photo)

** These troughs feature **two supports** for the upper run, without bottom stanchion (See red portion of above photo)

Order Example

9	2208-	5-	180-	600/	112-	150
---	-------	----	------	------	------	-----

Part No. structure - guide trough
94008-5-180-600/06-250

R - Bend radius, please add appropriate value

Bi - width index, please add appropriate value

Outer radius (AR)

Trough angle (Standard 180°, 135°, 90°, 45°)

Trough version (-5- with and -4- without bottom support)

Selected series 2208

Support for the upper run (from a 180° rotational angle)
 Lower edge of the carrier

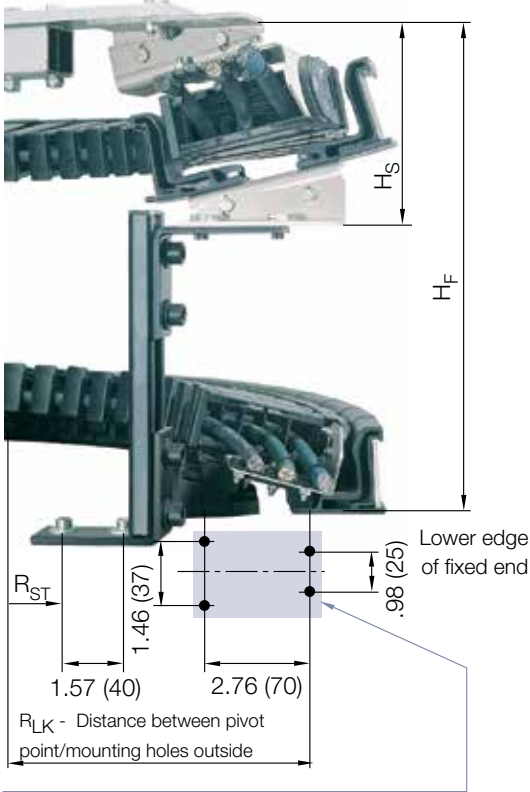

The guide trough must be mounted at the fixed end of the twisterchain, as shown by the drilling template.
 The following bolted connections are permitted.

- Through-hole: 4 x $\text{Ø } .26'' - .28''$ (6.6 - 7 mm)
- Mounting only with bolts: 4 x M6 bolts

Mounting position for one support

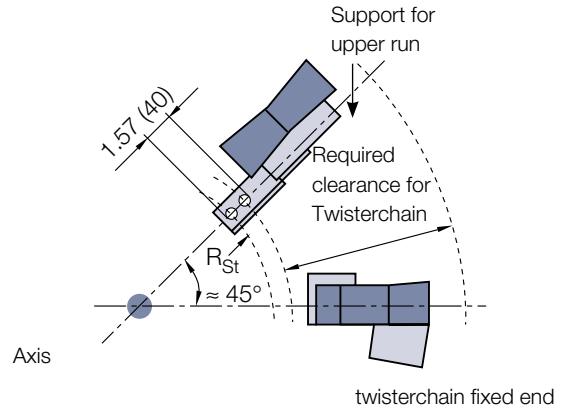

Mounting position for two supports

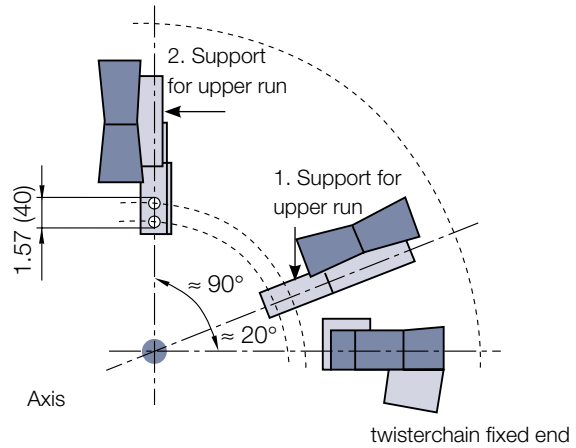

Installation dimensions

Series	R_{LK} in. (mm)	H_s in. (mm)	Part No. Guide Trough	R_{ST} in. (mm)	R in. (mm)											
					H_f for e-chain Bending Radius											
2208...300	10.43 (265)	5.12 (130)	92208...300	5.71 (145)	2.16 (55)	2.48 (63)	2.95 (75)	3.94 (100)	4.92 (125)	5.91 (150)	7.68 (195)	8.31 (211)	9.25 (235)	11.22 (285)	13.19 (335)	15.16 (385)

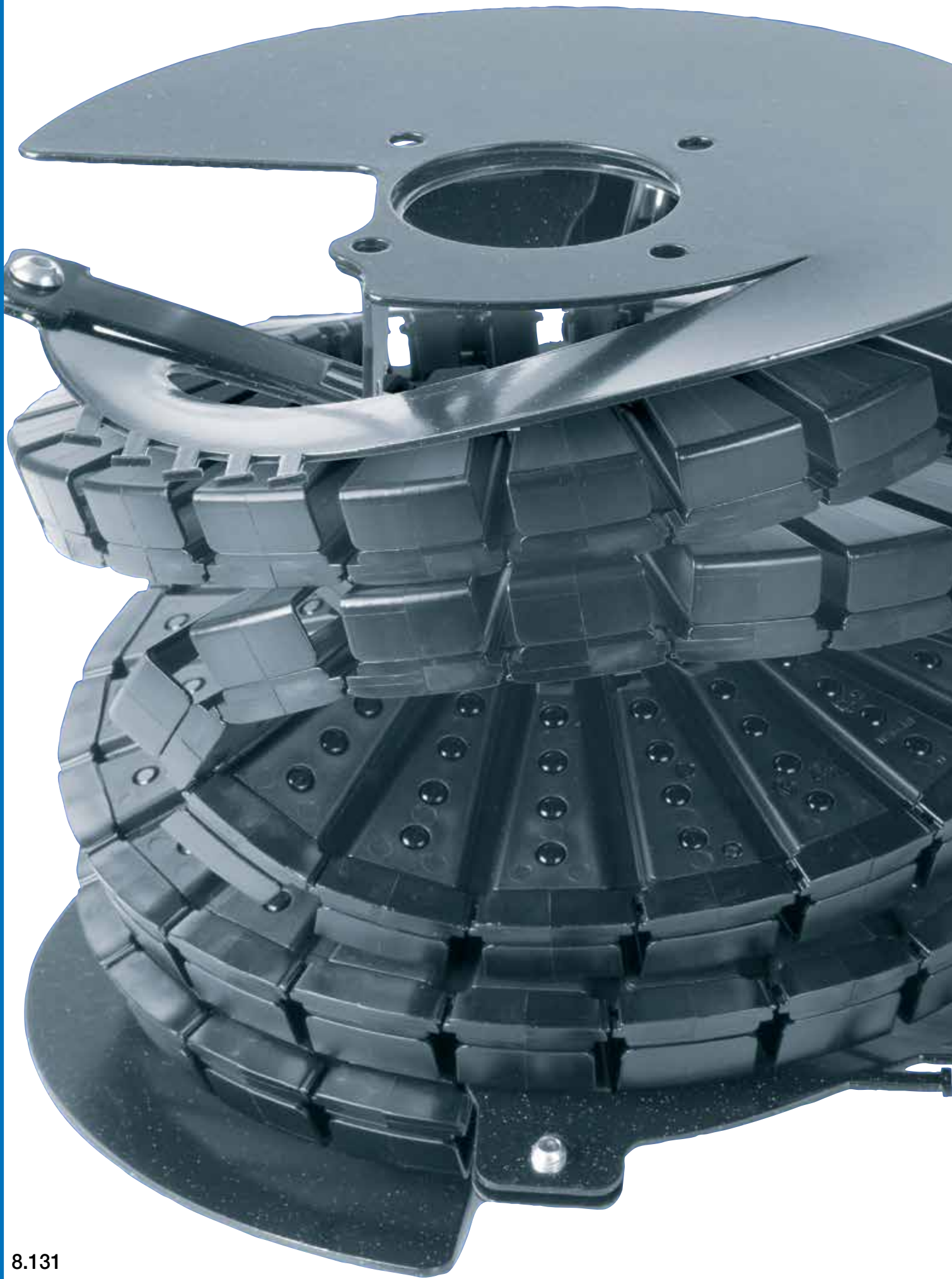



twisterband

up to 7000° rotary movement
in the smallest spaces

twisterband: compact, modular and cost-effective



twisterband advantages:

- Rotary movements up to 7,000°
- Rotary speeds up to 180°/s possible
- Openable with film hinge or openable "easy" design
- HD version with strong pin and hook connection for an even longer service life
- Compact, modular and lightweight
- Bands can be lengthened and shortened as required
- Minimum installation space, fits very closely around the rotary axis
- Cost-effective and easy to fill



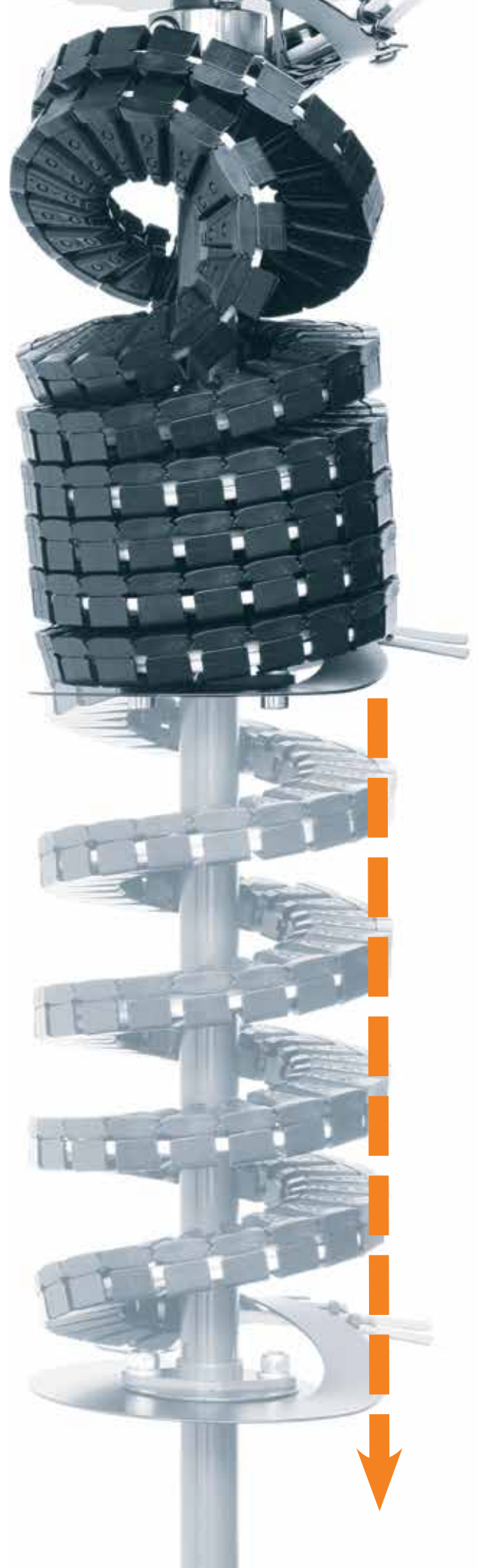

When to use another igus® solution:

- For applications with a high fill weight
 - ▶ **twisterchain system**
- For applications with multi-axis movements
 - ▶ **triflex® R**
- **RBR** versions with a high fill weight
 - ▶ **Designing**
- If a lubrication and maintenance-free slewing ring bearing for "endless" rotation is required
 - ▶ **iglide® slewing ring bearings, www.igus.com/PRT**
- If shielded cables are necessary
 - ▶ **Please contact us**

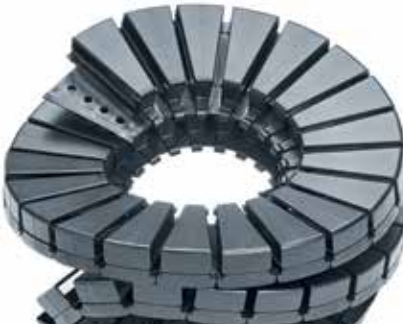

twisterband - 7000° rotation - Selection table

Series	Inner height hi in. (mm)	Inner width Bi in. (mm)	$\varnothing X_1$ in. (mm)	$\varnothing X_2$ in. (mm)	$\geq R$ in. (mm)	$\leq R$ in. (mm)	$\leq d1$  in. (mm)	Interior separation	Opening principle
									twisterband e-chain® links on a strip. Openable with film hinge or openable "easy" design
TB12.23.9	.35 (9)	.91 (23)	1.57 (40)	5.51 (140)	.94 (024)	1.38 (035)	.28 (7)	–	"easy" design
TB20.44.12	.47 (12)	1.73 (44)	1.97 (50)	8.66 (220)	1.34 (034)	2.24 (057)	.35 (9)	–	"easy" design
TB20.44.18	.71 (18)	1.73 (44)	1.97 (50)	8.66 (220)	1.34 (034)	2.24 (057)	.55 (14)	yes	film-hinge
TB29.27.22	.87 (22)	1.06 (27)	7.87 (200)	12.60 (320)	2.72 (069)	3.22 (082)	.67 (17)	yes	film-hinge
TB30.75.22	.87 (22)	2.95 (75)	3.54 (90)	12.99 (330)	1.73 (044)	3.03 (077)	.67 (17)	yes	film-hinge

									twisterband HD e-chain® links with strong pin and hook connection. Openable with film-hinge
TBHD30.75.22	.87 (22)	2.95 (75)	3.54 (90)	12.99 (330)	1.73 (044)	3.03 (077)	.67 (17)	yes	film-hinge
TBHD42.135.30	1.18 (30)	5.31 (135)	3.54 (90)	19.69 (500)	2.20 (056)	4.69 (119)	.79 (20)	yes	film-hinge

Other sizes available upon request. X_1 = inner machine limit X_2 = outer machine limit



Available from stock. Orders ship as early as today.*

*On average 90% of orders ship the same day..



Bi = Inner width e-chain®
 hi = Inner height e-chain®

X_1 = Inner machine limit
 X_2 = Outer machine limit

$\geq R$ = Minimum bend radius e-chain®
 $\leq R$ = Max. bend radius e-chain®

$d1$ = Max. cable diameter
 XX = Number of strips

twisterband (7000°) rotation

Features - Accessories



A central shaft must be installed for horizontal orientation angles of rotation above 1,500°



Max. angle of rotation: as a rule of thumb: each segment gives 180° = 360° more rotation

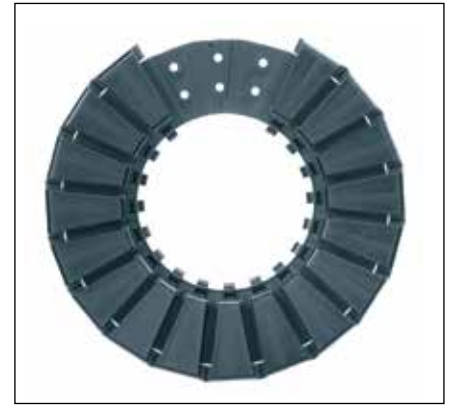

Minimum installation space, fits very closely around the rotary axis



Film hinge: easy access and quick filling with cables and hoses



Compact, modular, cost-effective - up to 7,000° rotary movement* in the most confined spaces

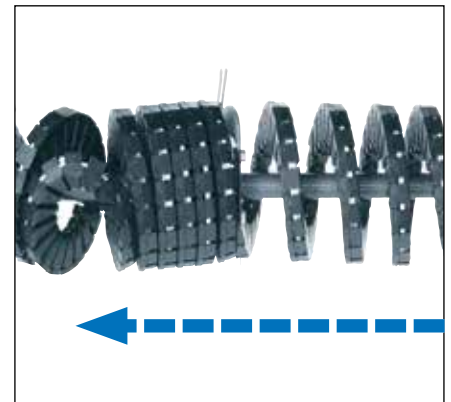

Can be reliably used in various installation positions (horizontal: 7,000° and more). Limited length compensation possible

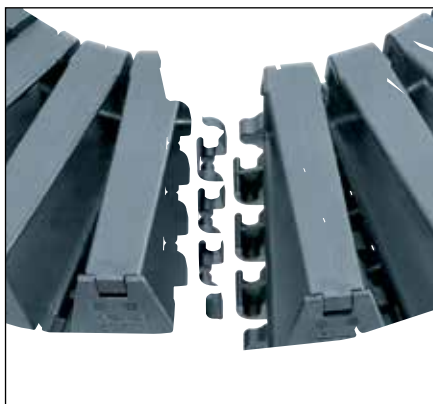

The twisterband HD is an advanced version of the standard twisterband ...



... instead of bands with integral hinges, the twisterband HD version is composed of separate e-chain® links with the pin/hook connecting system ...



... the advantage is a defined radius with higher strength.



iF product design award
2011 igus® twisterband





reddot design award
winner 2011

twisterband (7000°) rotation

Technical data - Size overview

Technical data

	Speed / acceleration*	180°/s
	twisterband - material - permitted temperature, igumid TE	+32°F / +158°F (0°C / +70°C)
	twisterband HD - material - permitted temperature, igumid G	-40°F / +248°F (-40°C / +120°C)
	Flammability class, igumid G	VDE 0304 IIC UL94-HB
	Flammability class, igumid TE	VDE 0304 IIC UL94-HB

*Speed / acceleration for TB29.27. upon request

Size overview

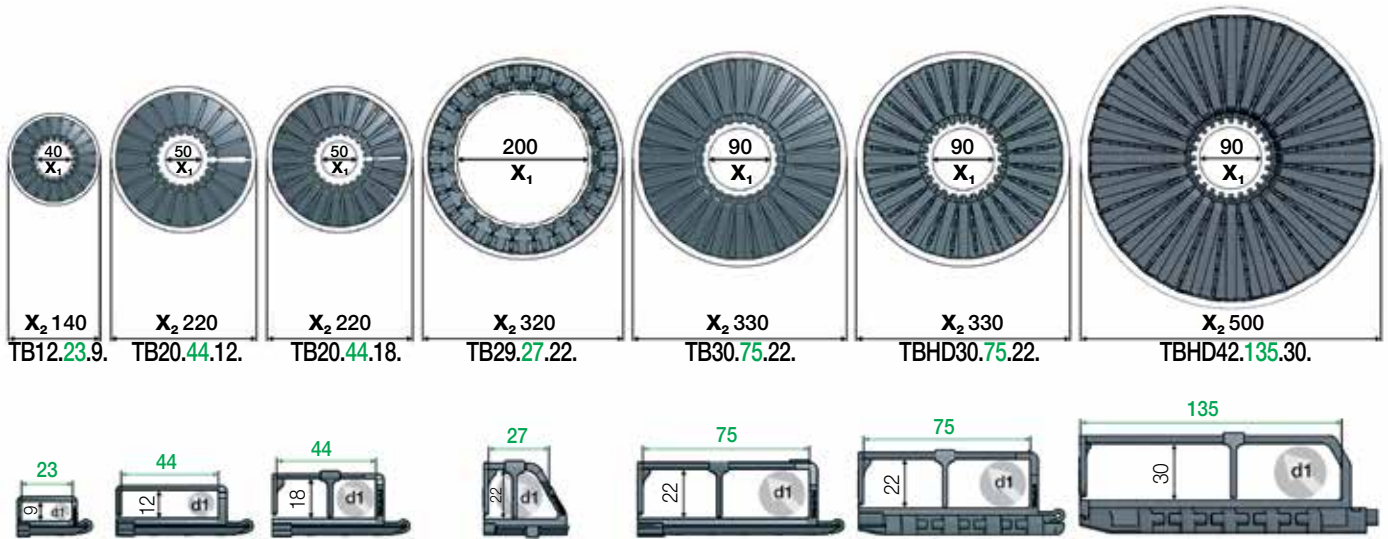

Bi = Inner width e-chain®
hi = Inner height e-chain®

X₁ = Inner machine limit
X₂ = Outer machine limit

$\geq R$ = Minimum bend radius e-chain®
 $\leq R$ = Max. bend radius e-chain®

d1 = Max. cable diameter
XX = Number of strips

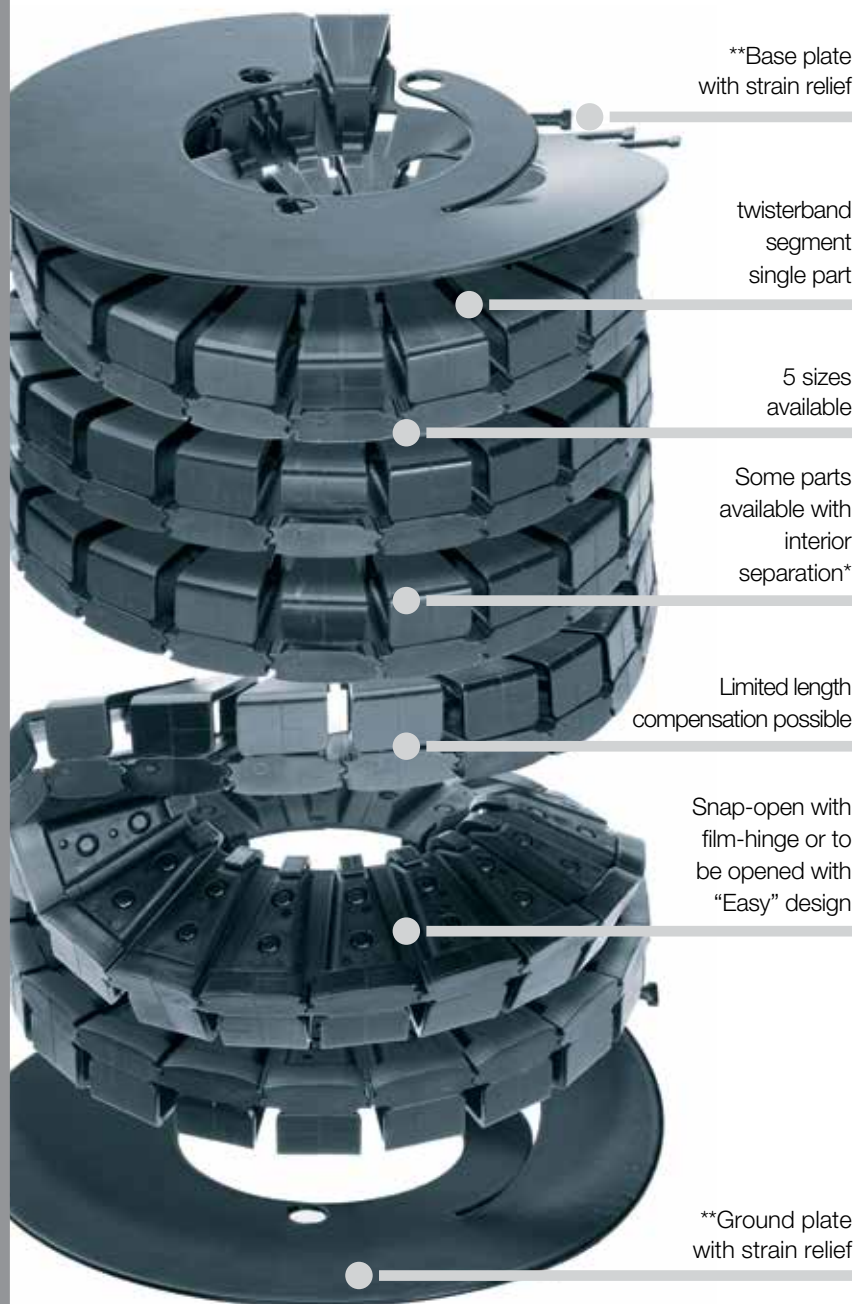

**Base plate
with strain relief

twisterband
segment
single part

5 sizes
available

Some parts
available with
interior
separation*

Limited length
compensation possible

Snap-open with
film-hinge or to
be opened with
“Easy” design

**Ground plate
with strain relief

**Ground- and base plates are
delivered standard. They are
part of the twisterband module!

Up to 7,000° rotary movement in the smallest spaces - twisterband

With the compact igus® twisterband rotations can be achieved cost-effectively and with low wear and low maintenance, even in a confined space. Energy, data and media are securely guided. Available in 5 sizes.

- Rotary movements up to 7,000°*
- Rotary speeds up to 180°/s possible
- Compact, modular and lightweight
- Bands can be lengthened and shortened as required
- Minimum installation space, fits very closely around the rotary axis
- Can be reliably used in various installation positions (horizontal or vertical)
- Cost-effective
- Easy filling
- Ideal in combination with igus® chainflex® cables for rotary movements in very limited installation spaces

Typical industries and applications

- Cable reels ● Robots (robot arms, axis1/6, SCARA robots)
- Machine tools ● Leisure rides ● Medical equipment
- Radar and telescope equipment ● Aerospace, test, measurement, handling, lifting and installation equipment ● Wind turbines (e.g. blade adjustment) ● Wherever rotary unions are used

twisterband
 Product range - Installation dimensions
 e-chain® links on a strip



twister-
band



twisterband - Openable with film hinge or with "easy" design

Part No.	h_i	$Bi1$	$X_1 \varnothing$	$X_2 \varnothing$	$\geq R$	$\leq R$	$\leq d1$	Opening principle
twisterband	in. (mm)	in. (mm)	in. (mm)	in. (mm)	in. (mm)	in. (mm)	in. (mm)	
TB12. 23 .9. XX .01.0	.35 (9)	.91 (23)	1.57 (40)	5.51 (140)	.94 (024)	1.38 (035)	.28 (7)	"easy" design
TB20. 44 .12. XX .01.0	.47 (12)	1.73 (44)	1.97 (50)	8.66 (220)	1.34 (034)	2.24 (057)	.35 (9)	"easy" design
TB20. 44 .18. XX .01.0	.71 (18)	1.73 (44)	1.97 (50)	8.66 (220)	1.34 (034)	2.24 (057)	.55 (14)	film-hinge
TB29. 27 .22. XX .01.0*	.87 (22)	1.06 (27)	7.87 (200)	12.60 (320)	2.72 (069)	3.22 (082)	.67 (17)	film-hinge
TB30. 75 .22. XX .01.0	.87 (22)	2.95 (75)	3.54 (90)	12.99 (330)	1.73 (044)	3.03 (077)	.67 (17)	film-hinge

More twisterband sizes upon request! **Note:** Series TB29.27.22. Rotary movement up to max. 720°

Base plates are delivered as standard as part of the twisterband module!

$X_1 = \varnothing$ inner machine installation space $X_2 = \varnothing$ outer machine installation space

Complete Part No. with required number of strips **XX**. Example: TB20.44.12.6.01.0

Installation dimensions

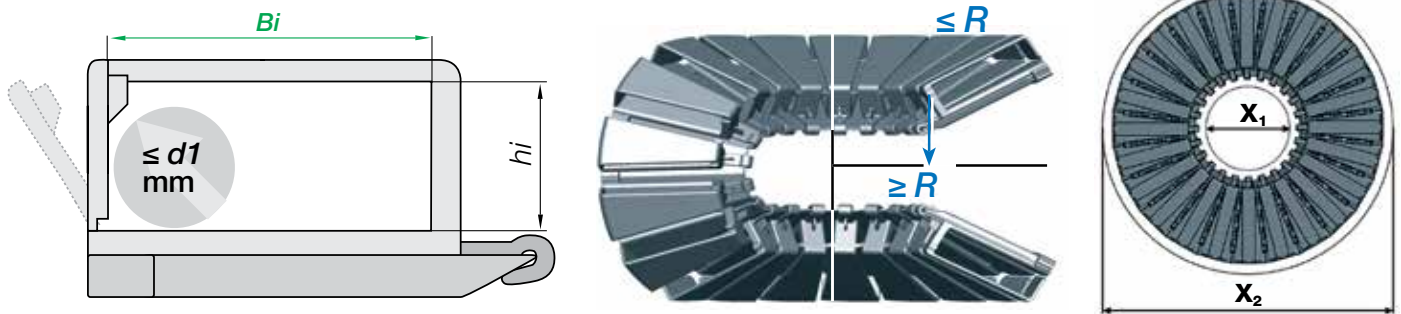

Calculation: number of strips depends on angle of rotation
 (please always round up number of strips)

TB12: $XX \approx \frac{XXXX^\circ}{360} + 2 =$ Example: $XX \approx \frac{1200^\circ}{360} + 2 =$ Result: $XX \approx 6$ strips

TB20: $XX \approx \frac{XXXX^\circ}{340} + 2 =$ Example: $XX \approx \frac{1200^\circ}{340} + 2 =$ Result: $XX \approx 6$ strips

TB29: $XX \approx \frac{XXXX^\circ}{180} + 2 =$ Example: $XX \approx \frac{720^\circ}{180} + 2 =$ Result: $XX \approx 6$ strips

TB30: $XX \approx \frac{XXXX^\circ}{180} + 6 =$ Example: $XX \approx \frac{1200^\circ}{180} + 6 =$ Result: $XX \approx 13$ strips

XXXX° = Angle of rotation

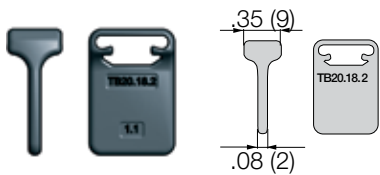
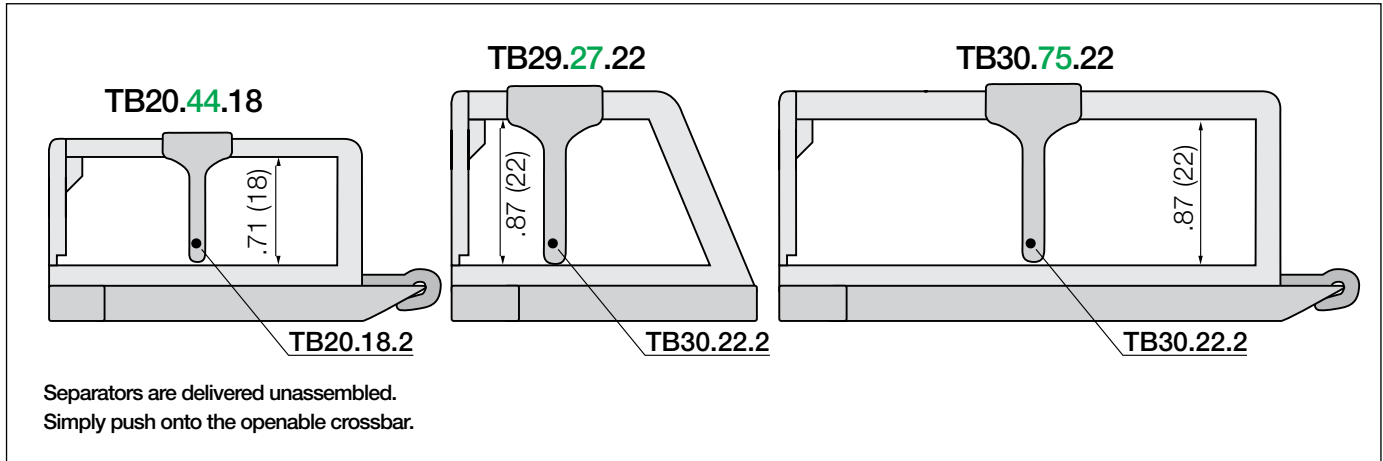

Separators

To fit, simply open the e-chain®, insert a cable and press the separator onto the crossbar. Then add more cables. The separators provide a clear, cable-friendly interior separation.

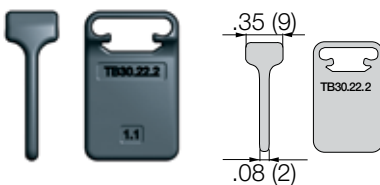

Easy opening and filling of the twisterband with a click or with the "easy" design. Simply press separators on and add more cables. The separators provide a clear, cable-friendly interior separation.



igus® twisterband TB30 for circular movements up to 360°, E2 mini and E2/000 e-chains® are used in this loading and unloading unit

twisterband (7000°) rotation

Accessories

Base plates with strain relief for twisterband

Steel base plate dimensions for twisterband HD
(for TB29.27.22 upon request)

TB12.23.9

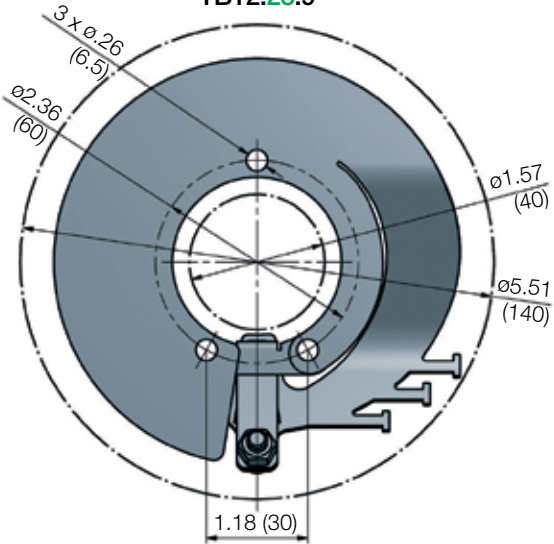

TB20.44.12 / TB20.44.18

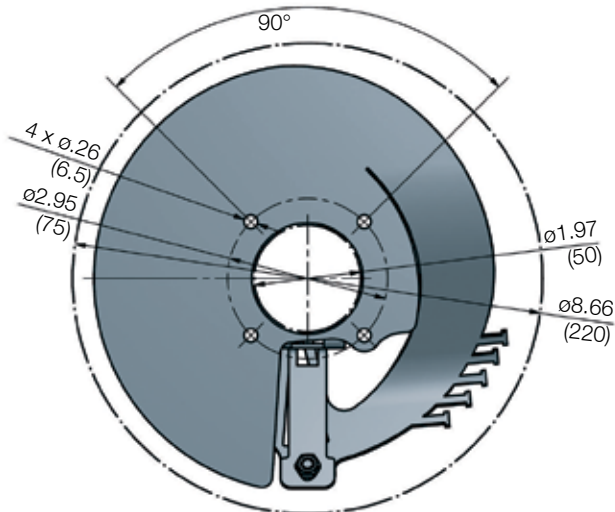

TB30.75.22

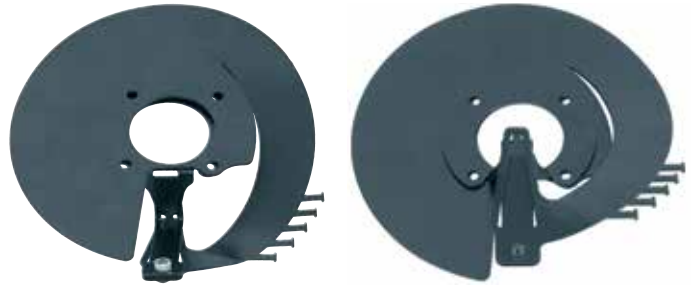
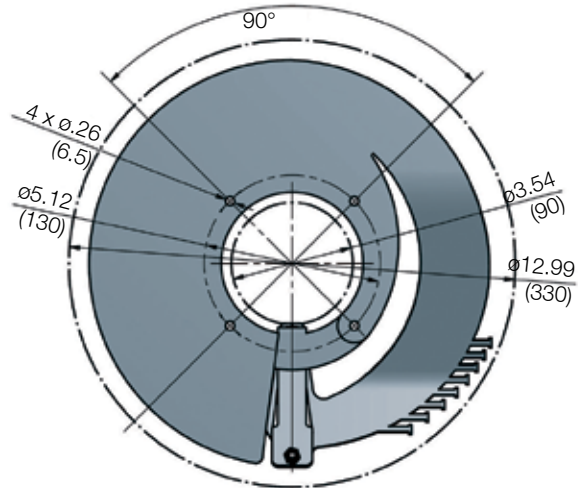

Base plates are delivered as standard as part of the twisterband module



twisterband application of two systems mounted above one another. This space-saving solution allows double filling space with a constant outer diameter of the system

Rotary movement in the most confined spaces, now even stronger - twisterband HD

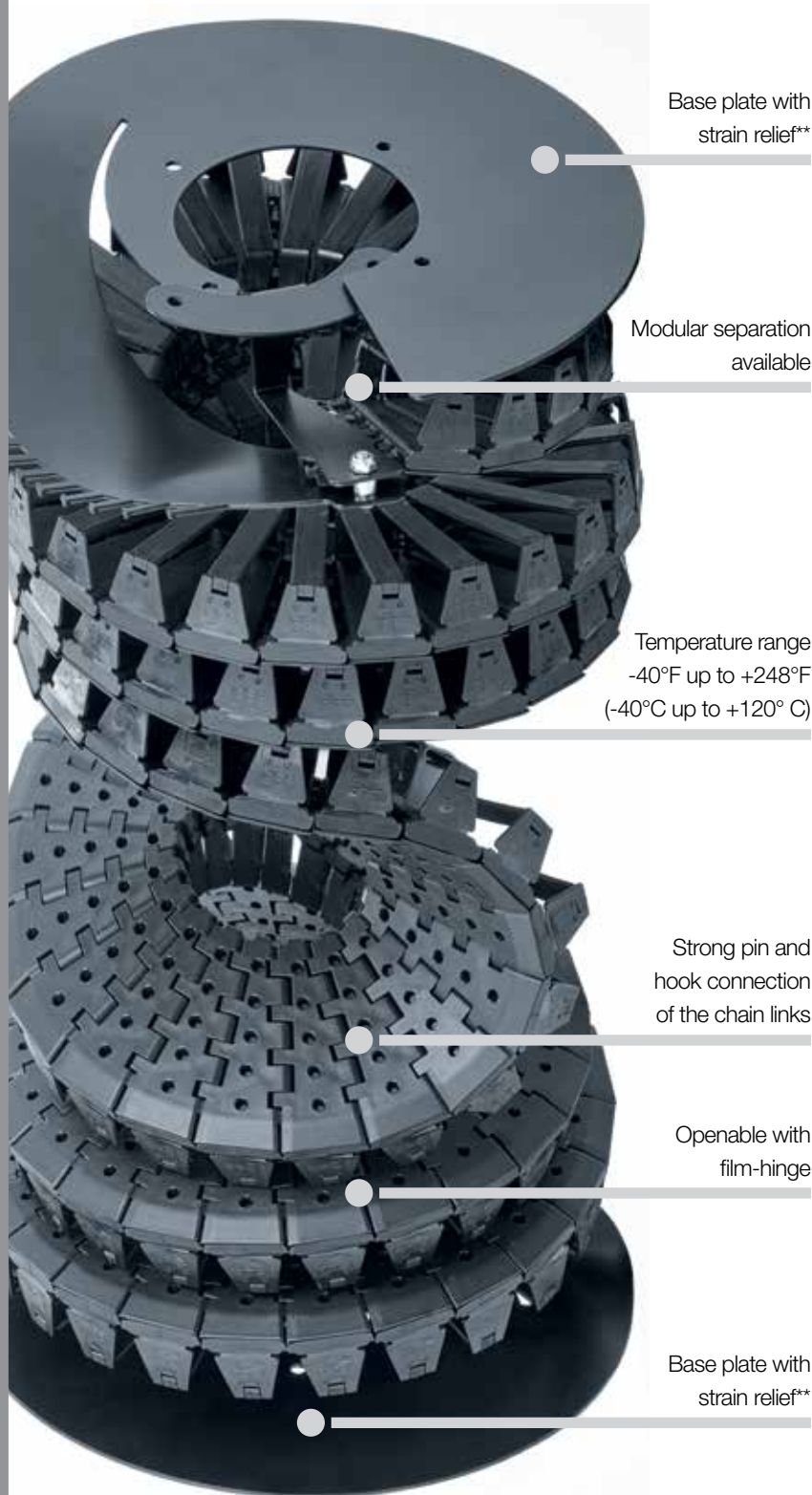

Instead of strips, the twisterband HD has a strong pin/hook connection between the chain links. Longer service life and higher filling are possible.

- Continuous cable guidance in rotational movements
- Strong pin/hook connection for high load and long service life
- For routing of electrical, fiber optic and pneumatic cables in one system
- Stop-dogs for defined bend radius
- Cable-friendly due to defined radius stop
- Max. rotating speed: 180°/s

Typical industries and applications

- Machining heads on machine tools
- Rotary tables
- Axis 6 on robots
- Generally all applications that currently work with slip rings

**Base plates are delivered as standard as part of the twisterband module!

twisterband
 Product range - Installation dimensions
 Chain links with strong pin and hook connection



twister-
band



twisterband - Openable with film hinge

Part No.		h_i	$Bi1$	$X_1 \varnothing$	$X_2 \varnothing$	$\geq R$	$\leq R$	$\leq d1$	Opening principle
twisterband		in. (mm)	in. (mm)	in. (mm)	in. (mm)	in. (mm)	in. (mm)	in. (mm)	
TBHD30.	75 .22. XXX .01.0	.87 (22)	2.95 (75)	3.54 (90)	12.99 (330)	1.73 (044)	3.03 (077)	.67 (17)	film-hinge
TBHD42.	135 .30. XXX .01.0	1.18 (30)	5.31 (135)	3.54 (90)	19.69 (500)	2.20 (056)	4.69 (119)	.79 (20)	film-hinge

Base plates are delivered as standard as part of the twisterband module!

$X_1 = \varnothing$ inner machine installation space $X_2 = \varnothing$ outer machine installation space

Complete Part No. with required number of strips **XXX**. Example: TBHD30.75.22.180.01.0

Installation dimensions

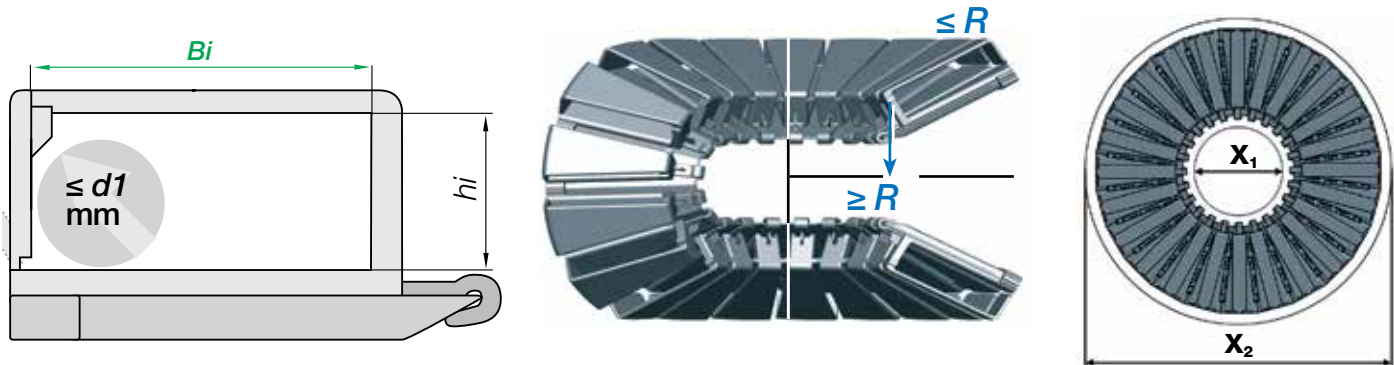

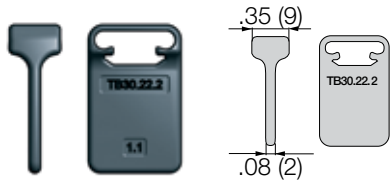
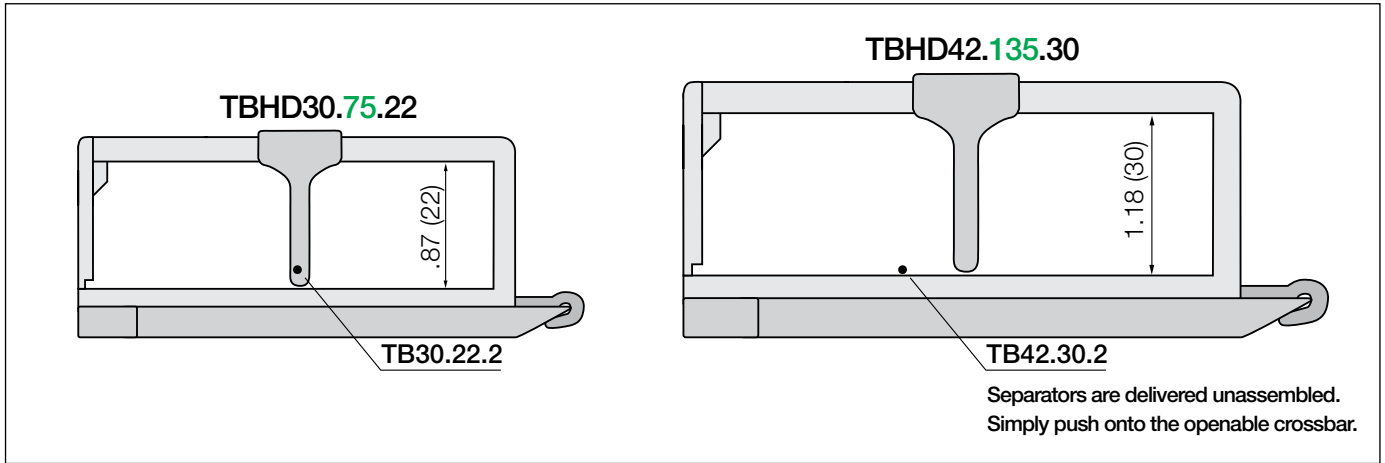

Separator, wide base

Unassembled	Part No. TB30.22.2
Assembled	Part No. TB30.22.2.1

Separators

To fit, simply open the e-chain®, insert a cable and press the separator onto the crossbar. Then add more cables. The separators provide a clear, cable-friendly interior separation.

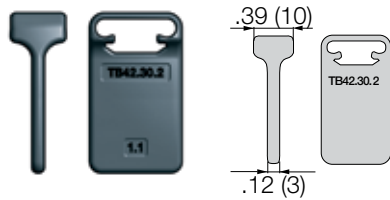

Separator, wide base

Unassembled	Part No. TB42.30.2
-------------	--------------------



Easy opening and filling of the twisterband with a click or with the "easy" design. Simply press separators on and add more cables. The separators provide a clear, cable-friendly interior separation.



igus® twisterband and other e-chains® in a wood working machine

Steel base plate dimensions for twisterband HD
(for TB29.27.22 upon request)

TBHD30.75.22

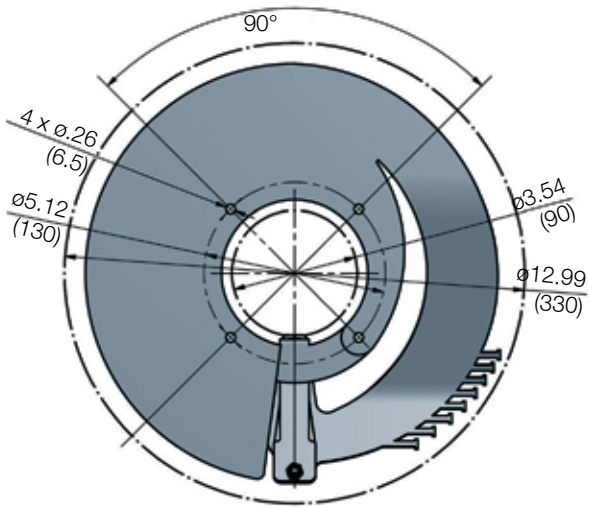

TBHD42.135.30

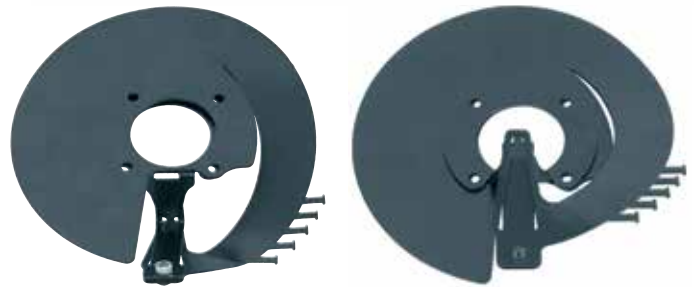
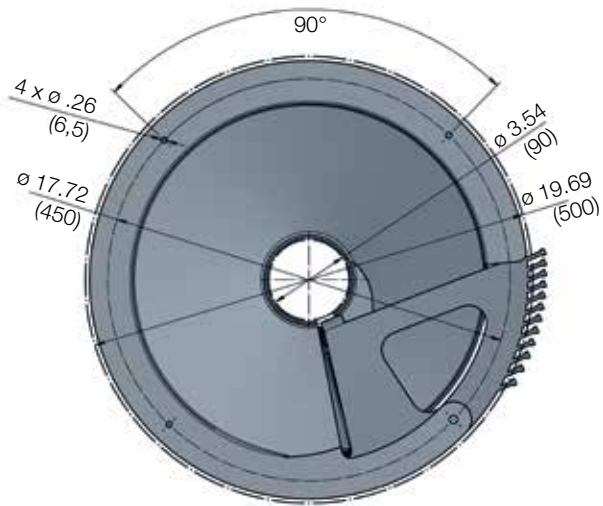

Base plates are delivered as standard as part of the twisterband module!

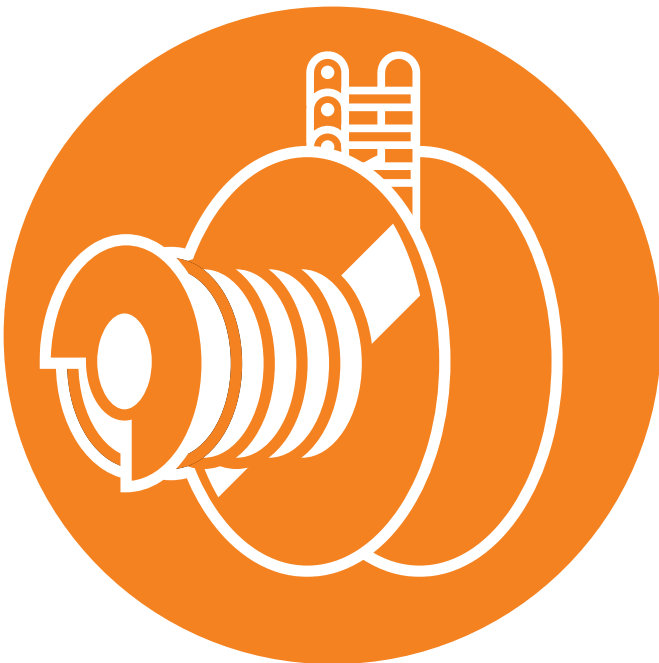

**Solutions for
multi-axis motion**



**Solutions for
vertical motion**

igus[®] solutions for:

- Multi-axis motion
- Vertical motion
- Horizontal motion
- Predictive maintenance, condition monitoring and engineered projects



Solutions for
horizontal motion



Predictive maintenance,
condition monitoring
and engineered projects



Multi-axis motion

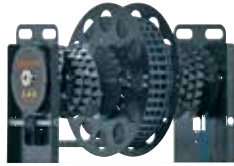

e-spool standard and HD - flexible use

- Telescopic/retractable applications
- Theater, stage and lighting technology
- Space-saving alternative to zig-zag solutions



e-spool compact - space-saving, spring driven

- Retractable applications - linear or rotary
- Small circular movements



e-spool for manual operation - reliable and space-saving

- Robot teach pendants
- Workstations
- Assembly lines



e-spool power - motor driven for long extension lengths

- Theater, stage and lighting technology
- Indoor and outdoors cranes

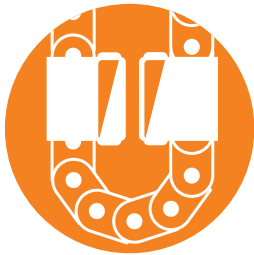

Vertical motion



liftband - cable guidance up to 13m height with limited installation space

- Theatre and stage technology
- Indoor cranes
- Mobile telescopic antennas



guidelok slimline P - safe vertical guidance

- Storage and retrieval units for high-bay warehouses
- Lifts
- Elevators
- Construction and crane lifts
- Hoists
- Automatic mini-load system



guidelok slimline P.S - lightweight plastic construction, cost-effective

- Storage and retrieval units for high-bay warehouses
- Lifts
- Construction and crane lifts
- Automated car parks
- Ship lifts



guidelite GLV - lighter, lower noise, simpler and less cost

- Shuttle systems
- High bay warehouse
- Lifts
- Hoists

More information

► www.igus.eu/gisl-ps

More information

► www.igus.eu/GLV



Horizontal motion



guidelok horizontal - upper run guide for long travels

- Machine tools
- Heavy chip environments
- Wherever a gliding application is not recommended



basic flizz® - enclosed solution for long travels

- Wastewater and sewage treatment works (longitudinal scrapers, sand/grease traps)
- Electroplating facilities
- Cranes
- River locks



micro flizz® - safe guidance of energy, data and air

- Storage and retrieval units for high-bay warehouses
- Indoor cranes
- Industrial gates
- Workplace equipment
- Wastewater and sewage treatment plants
- Camera systems
- Sliding doors



Condition monitoring and engineered projects



isense smart plastics for predictive maintenance **New**

- Wherever predictive maintenance is required
- Harbor installations
- Cranes
- Car plants
- Gantries



PPDS - Push/Pull Detection System

- Downtime sensitive plants, such as conveyor systems in power plants
- Waste incineration systems
- Chemical plants
- Cranes

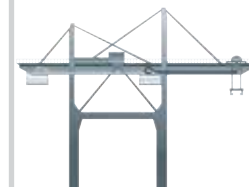

Modular projects - special solutions from stock

- Cranes
- Offshore
- And many other industries





Solutions for multi-axis motion

e-spool

The alternative to cable reeling drums - reduce cable wear and reliably guide different media together in one system



e-spool advantages:

- Energy supply is possible in all directions (horizontal, vertical, diagonal)
- More versatile and flexible to use than cable reeling drums
- Different media (power, data and fluids) can be routed together in one system
- If travels must be kept free
- If the technical system is to be hidden behind false ceilings/floors
- Very well suited for use in theatre and stage technology



When to use another system:

- With very high loads that have to be guided vertically
 - ▶ zig-zag applications,
- For high dynamics with lateral accelerations
 - ▶ guidelok slimline P



The cable reel without a slip ring - igus[®] e-spool

Route many different cables in very narrow spaces. e-spool uniquely combines two different energy supply systems: one standard e-chain[®] is guided by one roller and always provides the precisely correct length and tension of the energy supply system through an integrated retaining spring. In the starting position, the e-chain[®] is rolled up to save space. The twisterband connects the roller with the shaft block, which serves as an interface to the supply side. With twisterband no slip ring is needed. This makes data transmission highly reliable, while enabling a high degree of flexibility at the same time. Different media and cable/hose diameters can be carried side by side in one drum - diameters up to .67" (17mm)

- No tensile load of the cables
- Energy supply in all possible directions (horizontal, vertical, diagonal)
- Space-saving, no "e-chain[®] junction" - e-chain[®] rolled into the home position, the paths remain free
- Cables can be retroactively added or changed
- Alternative to zig-zag solutions
- Max. extension and retraction speed: 3.28 ft. (1 m/s)
- Large standard product range and special projects available

Typical industries and applications

- Telescopic/retractable applications
- Theater, stage and lighting technology
- Space-saving alternative to zig-zag applications



Available from stock. Orders ship as early as today.*

*On average 90% of orders ship the same day.



iF product design award
2013 igus[®] e-spool

2013 ■

Special solutions - Movements in all directions

e-spool

Product Range



Part No. with 1 twisterband	Part No. with 2 twisterbands	Travel length ≤ ft. (m)	Drum ø in. (mm)	Cable length ft. (m)
--------------------------------	---------------------------------	----------------------------	--------------------	-------------------------



e-spool standard

flexible use

(Illustration shows e-spool with 1 twisterband)

SP1-600-	SP2-600-	13.12 (4)	23.62 (600)	28.22 (8.6)
SP1-700-	SP2-700-	22.97 (7)	27.56 (700)	38.39 (11.7)
SP1-850-	SP2-850-	45.93 (14)	33.46 (850)	65.29 (19.9)



e-spool HD

flexible use, with increased retraction force

(Illustration shows e-spool with 1 twisterband HD)

SPHD1-600-	SPHD2-600-	13.12 (4)	23.62 (600)	28.22 (8.6)
SPHD1-700-	SPHD2-700-	22.97 (7)	27.56 (700)	38.39 (11.7)
SPHD1-850-	SPHD2-850-	45.93 (14)	33.46 (850)	65.29 (19.9)



e-spool compact

compact, space-saving

SP1-240-	-	6.56 (2)	9.45 (240)	13.12 (4.0)
SP1-400-	-	13.12 (4)	15.75 (400)	21.65 (6.6)



e-spool for manual operation

for applications where only one cable or hose is pulled out manually

SPC1-300-		16.41 (5)	11.81 (300)	10.83 - 27.23 (3.3 - 8.3)
-----------	--	-----------	-------------	---------------------------



e-spool power

motor-driven, for long extension lengths

e-spool power		1.38 (35)	upon request	upon request
---------------	--	-----------	--------------	--------------

Part number structure



SP1-600-4000-02-R-0



Standard-System with a single twisterband with 23.62" (600 mm) drum diameter, and 157.5" (4000 mm) maximum extension length, extension right

Part number structure



SPHD1-700-7000-02-L-0

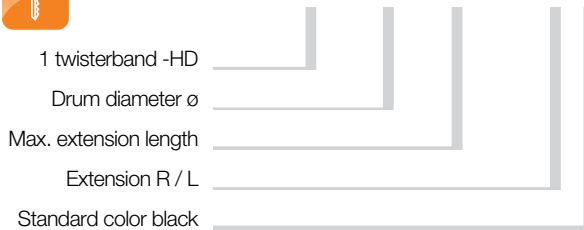

HD-Version with a single twisterband with 27.56" (700 mm) drum diameter, and 275.6" (7000 mm) maximum extension length, extension left

Part number structure



SP2-600-4000-02-R-0

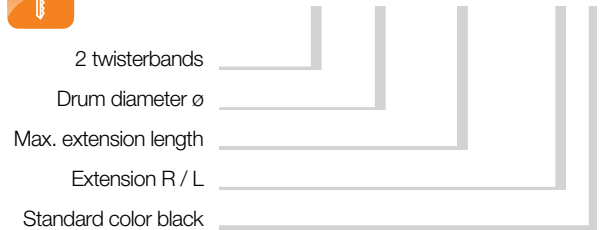

Standard-System with two twisterbands with 23.62" (600 mm) drum diameter, and 157.5" (4000 mm) maximum extension length, extension right

Part number structure



SPHD2-700-7000-02-L-0

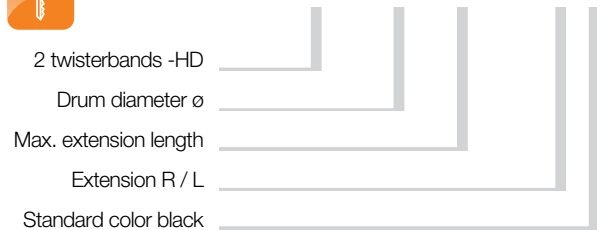

HD-Version with two twisterbands with 27.56" (700 mm) drum diameter, and 275.6" (7000 mm) maximum extension length, extension left

Speed	max. 4.92 ft/s (1.5 m/s)
Acceleration	max. 6.56 ft/s ² (2 m/s ²)
Lateral speed	max. 3.28 ft/s (1 m/s)
Lateral acceleration (radial / axial)	max. 3.28 ft/s ² (1 m/s ²) max.0.82 ft/s ² (0.25 m/s ²)

Technical Data



Details of material properties

► Chapter 1

Filling guidelines for the e-spool

In view of the special mechanical stress in an e-spool, we recommend using igus® chainflex® cables. We also recommend that you observe the following filling rules:

1. Only put cables side by side in the linear chain - never stack them!
2. Where possible, cables with a TPE outer jacket should be used for unshielded cables.
3. Shielded cables should be from the CFROBOT range
4. The maximum bend radius of the twisterband must be accounted for
5. Where possible, use separators to protect cables against cross-over and abrasion against other cables. To save space, install the separators alternately in segments positioned one behind the other. Repeat the separators in every 4th segment.
6. Insert cables sorted by diameter and/or bend radius - insert, small ones in the center then increasingly larger ones towards the outside
7. Apply strain relief to both ends of the cable - when using a cable tie for strain relief, please ensure the head of the cable tie is underneath to avoid cable damage
8. Always install cables in the twisterband close to the axis of rotation with space on the outside.
9. Always install cables in the twisterband with a slight gap from the axis of rotation

Installation instructions

For applications that move horizontally, a smooth surface is needed for the e-chain® to travel over.

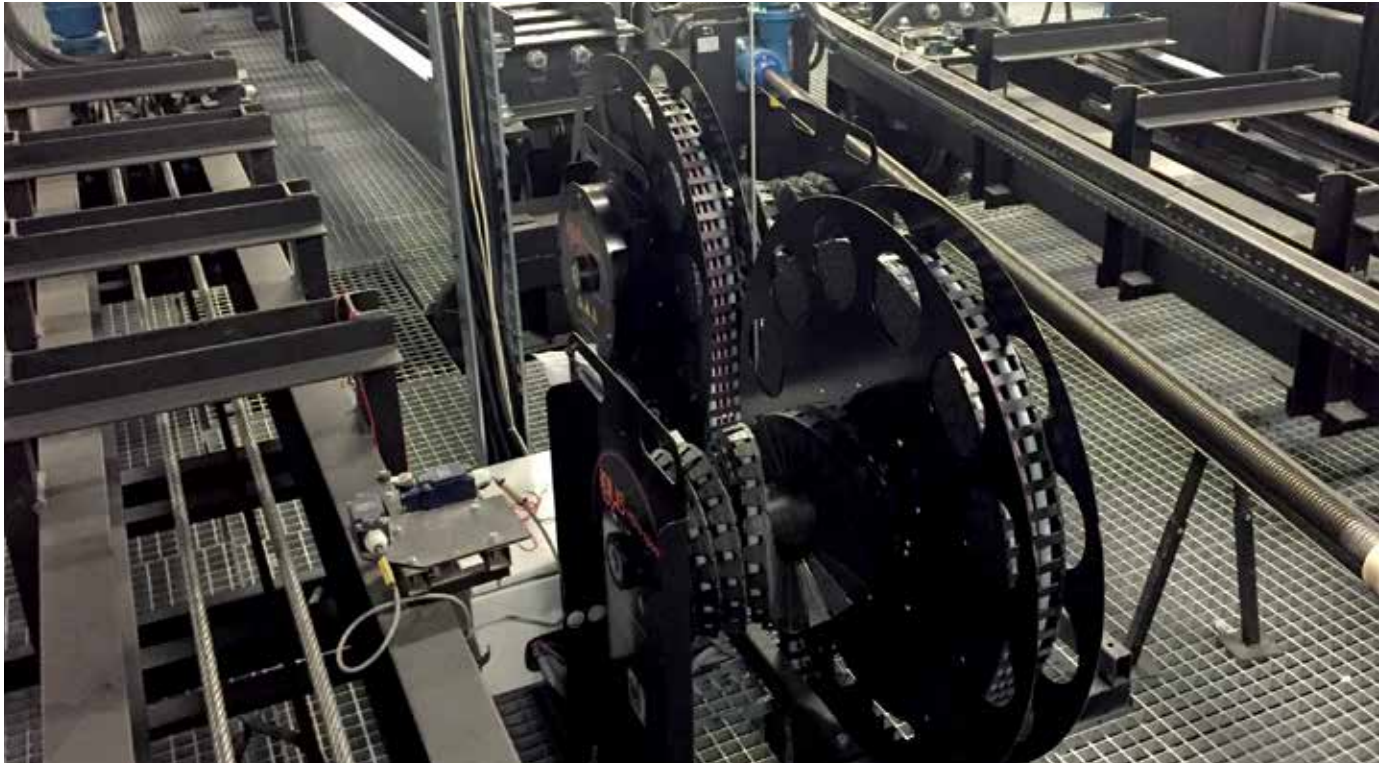

e-spool - the solution for stage and theater technology. Supplying energy, data and fluids without interruption. As shown here, at the Cultural and Congress Centre in Toruń (Poland). A total of ten igus® HD e-spool systems have been installed

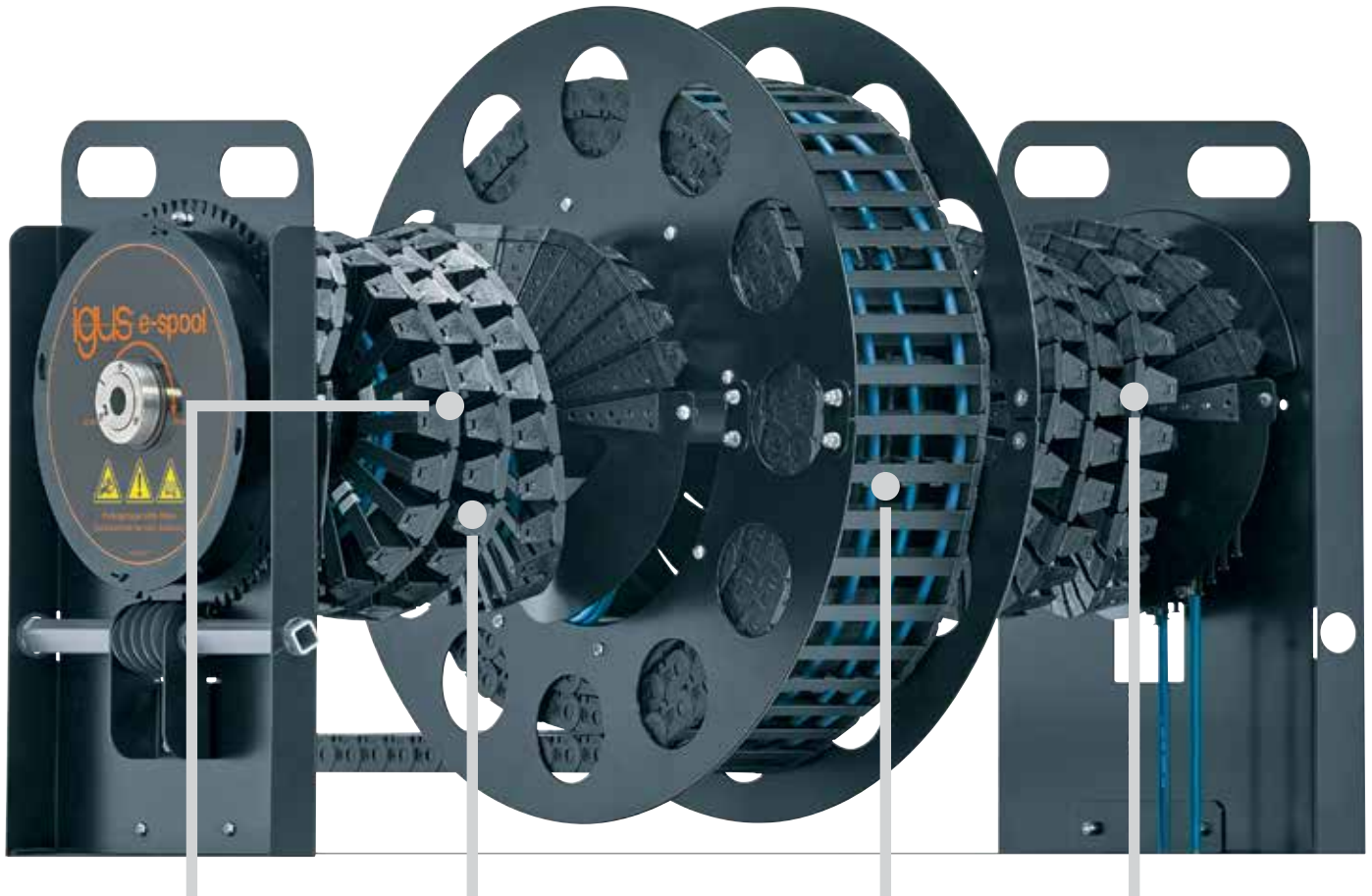

Flexible use:
 Energy supply possible in all directions

Cost-effective:
 twisterband enables rotary movement

Flexible energy supply:
 guidance of all media in one system

Space-saving:
 e-chain® rolled into the home position, the paths remain free

Flexible use - igus® e-spool standard and HD

With igus® e-spools, cables are wound up in an e-chain® to save space. Various media can be supplied without interruption by the use of the twisterband. Adjustments and extensions of the filling are also possible at any time afterwards.

- Flexible energy supply - guidance of different media in one system
- Flexible use - energy supply in any direction is possible
- Cost-effective - twisterband enables rotary movement
- Space-saving - e-chain® retracts into a compact unit
- No tensile load on the cables
- Cables can be retrospectively added or changed

Typical industries and applications

- Telescopic/retractable applications
- Theater, stage and lighting technology
- Space-saving alternative to zig-zag applications



iF product design award
 2013 igus® e-spool

2013 ■

Reduce cable wear and reliably guide different media together

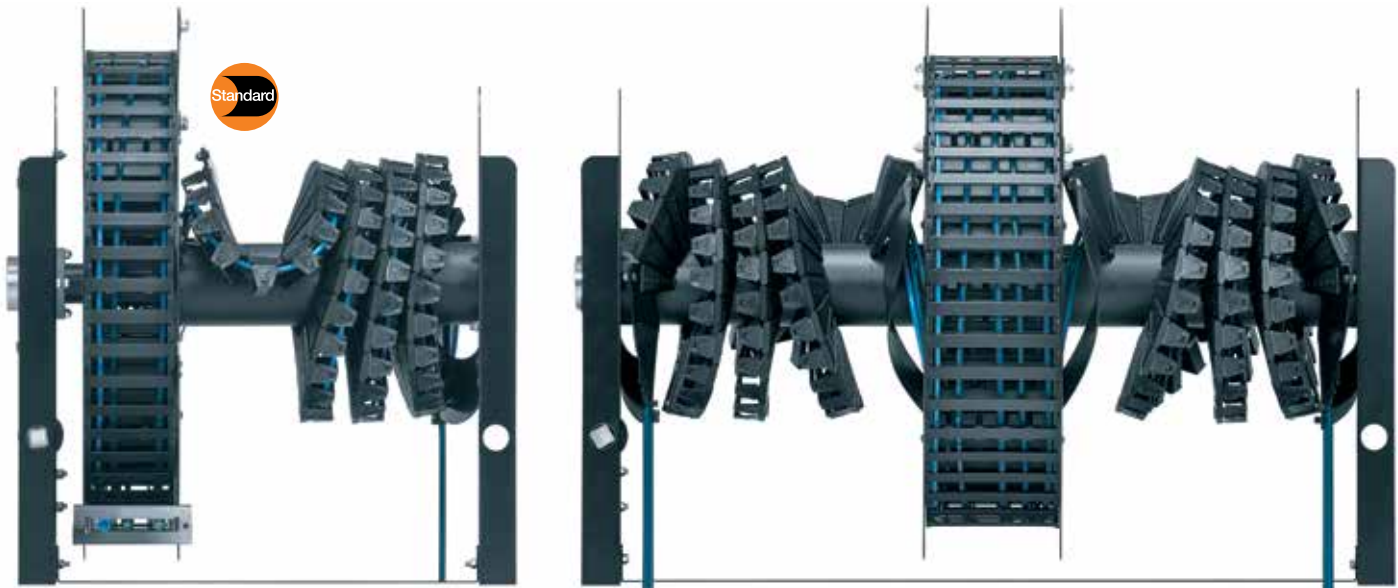

Illustration shows e-spool standard with 1 and 2 twisterbands

e-spool standard - With e-chain® and 1 or 2 twisterbands

Part No. e-spool with 1 twisterband, extension right	Part No. e-spool with 1 twisterband, extension left	<i>Bi</i> in. (mm)	<i>hi</i> in. (mm)	Travel length ≤ ft. (m)	SP1 lbs. (kg)
SP1-600-4000-03-R-0	SP1-600-4000-03-L-0	2.95 (75)	.83 (21)	13.12 (4)	≈ 72.75 (33.0)
SP1-700-7000-03-R-0	SP1-700-7000-03-L-0	2.95 (75)	.83 (21)	22.9 (7)	≈ 83.78 (38.0)
SP1-850-14000-03-R-0	SP1-850-14000-03-L-0	2.95 (75)	.83 (21)	45.9 (14)	≈ 105.84 (48.0)

Maximum cable and hose diameters: .67 (17mm)

The max. bend radii of 1.73 (44mm) in the inner radius and 3.03 (77mm) in the outer radius should be observed.

Part No. e-spool with 2 twisterbands, extension right	Part No. e-spool with 2 twisterbands, extension left	<i>Bi</i> in. (mm)	<i>hi</i> in. (mm)	Travel length ≤ ft. (m)	SP2 lbs. (kg)
SP2-600-4000-03-R-0	SP2-600-4000-03-L-0	4.92 (125)	.83 (21)	13.12 (4)	≈ 88.20 (40.0)
SP2-700-7000-03-R-0	SP2-700-7000-03-L-0	4.92 (125)	.83 (21)	22.9 (7)	≈ 99.23 (45.0)
SP2-850-14000-03-R-0	SP2-850-14000-03-L-0	4.92 (125)	.83 (21)	45.9 (14)	≈ 121.28 (55.0)

Maximum cable and hose diameters: .67 (17mm)

The max. bend radii of 1.73 (44mm) in the inner radius and 3.03 (77mm) in the outer radius should be observed

i **Note:** If the e-chain® extension is upwards, igus® recommends the standard e-spool. If the e-chain® extension is vertical or horizontal, the application should be discussed with your igus® engineer. The HD version with greater retraction force may be required.

Reduce cable wear and reliably guide different media together

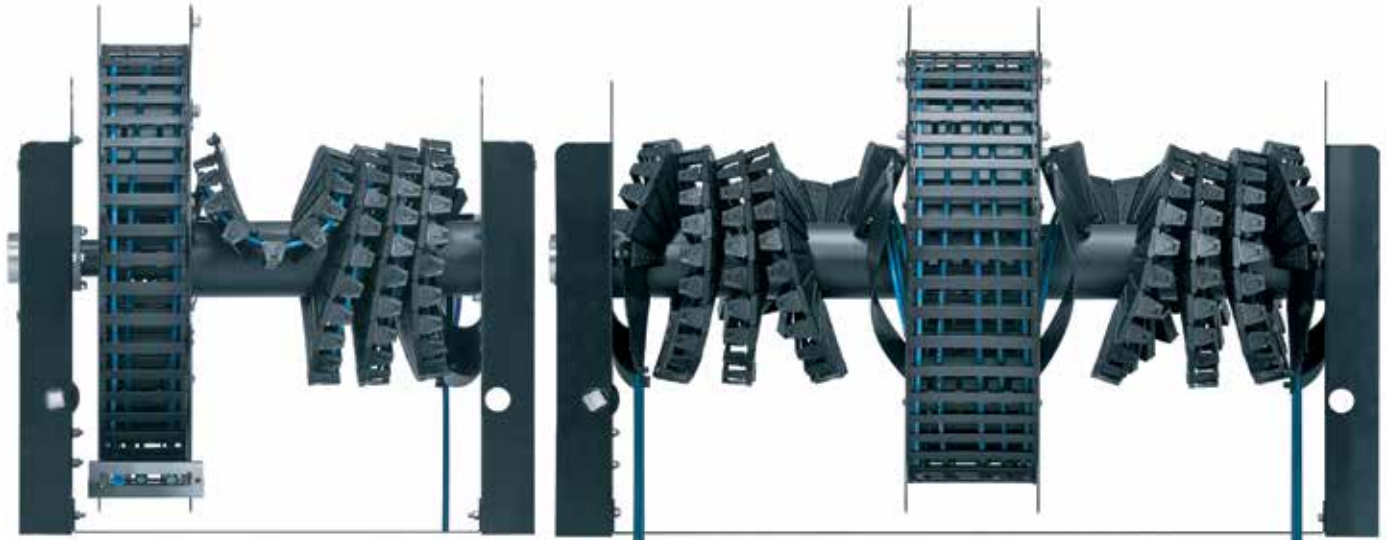

Illustration shows e-spool standard with 1 and 2 twisterbands

e-spool HD - With e-chain® and 1 or 2 twisterbands

Part No. e-spool with 1 twisterband, extension right	Part No. e-spool with 1 twisterband, extension left	<i>Bi</i>	<i>hi</i>	Travel length	SP1
		in. (mm)	in. (mm)	≤ ft. (m)	lbs. (kg)
SPHD1-600-4000-03-R-0	SPHD1-600-4000-03-L-0	2.95 (75)	.83 (21)	13.12 (4)	≈ 72.75 (33.0)
SPHD1-700-7000-03-R-0	SPHD1-700-7000-03-L-0	2.95 (75)	.83 (21)	22.9 (7)	≈ 83.78 (38.0)
SPHD1-850-14000-03-R-0	SPHD1-850-14000-03-L-0	2.95 (75)	.83 (21)	45.9 (14)	≈ 105.84 (48.0)

Maximum cable and hose diameters: .67 (17mm)

The max. bend radii of 1.73 (44mm) in the inner radius and 3.03 (77mm) in the outer radius should be observed.

Part No. e-spool with 2 twisterbands, extension right	Part No. e-spool with 2 twisterbands, extension left	<i>Bi</i>	<i>hi</i>	Travel length	SP2
		in. (mm)	in. (mm)	≤ ft. (m)	lbs. (kg)
SPHD2-600-4000-03-R-0	SPHD2-600-4000-03-L-0	4.92 (125)	.83 (21)	13.12 (4)	≈ 88.20 (40.0)
SPHD2-700-7000-03-R-0	SPHD2-700-7000-03-L-0	4.92 (125)	.83 (21)	22.9 (7)	≈ 99.23 (45.0)
SPHD2-850-14000-03-R-0	SPHD2-850-14000-03-L-0	4.92 (125)	.83 (21)	45.9 (14)	≈ 121.28 (55.0)

Maximum cable and hose diameters: .67 (17mm)

The max. bend radii of 1.73 (44mm) in the inner radius and 3.03 (77mm) in the outer radius should be observed



Note: If the e-chain® extension is upwards, igus® recommends the standard e-spool. If the e-chain® extension is vertical or horizontal, the application should be discussed with your igus® engineer. The HD version with greater retraction force may be required.

Special solutions - Movements in all directions
 e-spool - Standard and HD
 Overview - Advantages

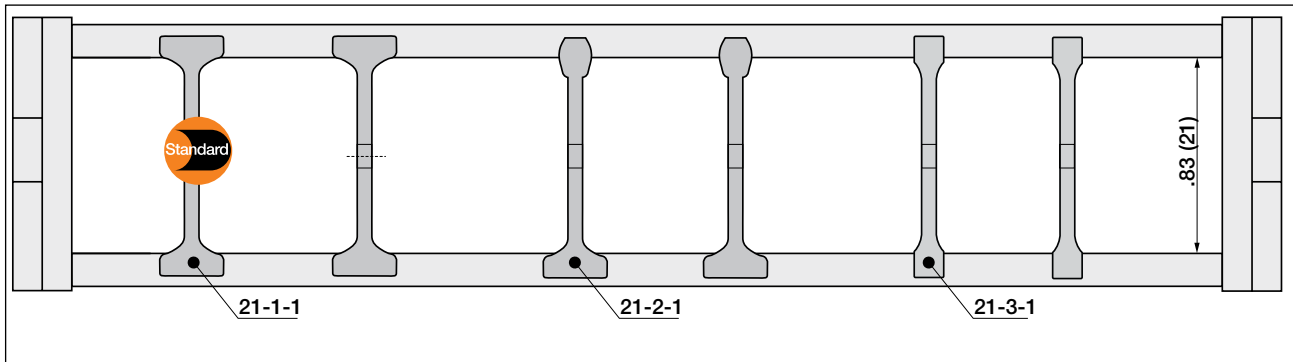

In the standard configuration separators are assembled every 5th e-chain® link
Note: No lateral spacing to side link is necessary

Separator, wide base
 Unassembled **Part No. 21-1**
 Assembled **Part No. 21-1-1**

- **Standard separator 21-1**
for all applications
 Separator with wide base for maximum locking strength and safe standing in e-chains®.

Separator, narrow head
 Unassembled **Part No. 21-2**
 Assembled **Part No. 21-2-1**

- **Separator 21-2**
For even faster installation
 is used when vertical and horizontal separation is required. Due to its slot, it allows basic vertical/horizontal shelving arrangements.

Separator, narrow base
 Unassembled **Part No. 21-3**
 Assembled **Part No. 21-3-1**

- **Separator 21-3**
For many thin cables
 is used when vertical and horizontal separation is required. Due to its slot, it allows basic vertical/horizontal shelving arrangements.

twisterband interior separation - separators are delivered unassembled.
 Simply pushed onto the openable crossbar. Separators are assembled every 4th e-chain® link.

Separators are delivered unassembled. Simply push them onto the crossbar!

Separator for TB30-75-22
 Unassembled **Part No. TB30-22-2**

- **Separator TB30-75-22**
For twisterband
 Separators - For installation simply open the e-chain®, insert a cable and push the separator onto the crossbar. Then add more cables. The separators provide a clear, cable-friendly interior separation.

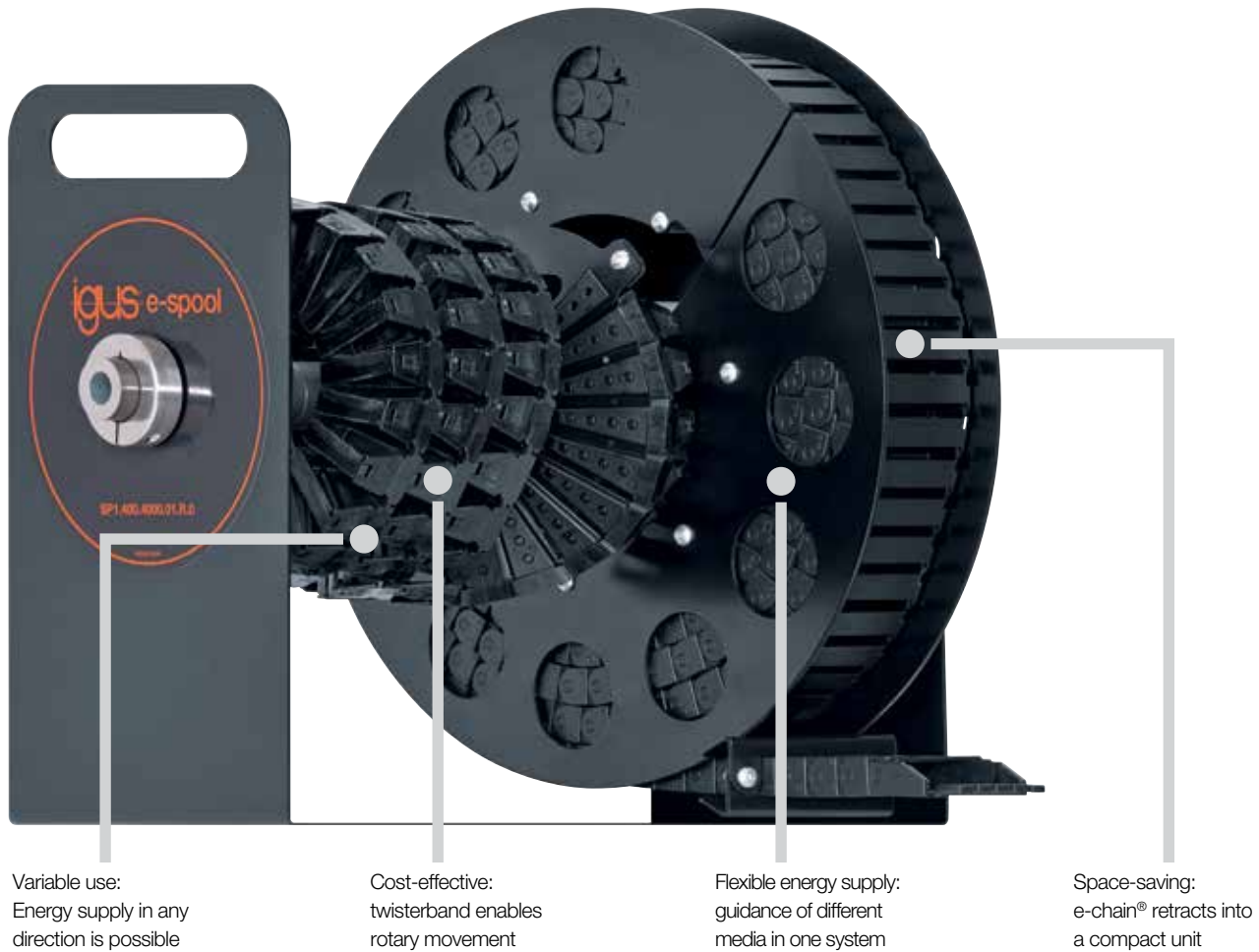

Variable use:
Energy supply in any
direction is possible

Cost-effective:
twisterband enables
rotary movement

Flexible energy supply:
guidance of different
media in one system

Space-saving:
e-chain® retracts into
a compact unit

Compact, space saving cable reel without a slip ring - e-spool compact

The compact e-spools for 6.56 ft.(2m) and 13.12 ft. (4m) extension are optimized for small installation spaces with smaller linear chains and twisterbands for a wide range of applications. As with the larger standard and HD systems, the compact e-spool systems enable trouble-free guidance and flexible filling.

- Compact, space-saving cable reel without slip ring
- Different media (power, air data and fluids) can be routed together in one system
- Energy supply in all directions
- Space-saving and virtually "invisible"
- Very lightweight design (SP1-240 series made from aluminium)
- Extension lengths up to 6.56 and 13.12 ft. (2 and 4m)
- Cables can be retrospectively added or changed

Typical industries and applications

- Small circular movements
- Retractable applications - linear or rotary

Special solutions - Movements in all directions
 e-spool Compact - SP1
 Product Range



Route various media in a space-saving and flexible way

e-spool compact - With e-chain® and 1 twisterbands

Part No. e-spool with 1 twisterband, extension right	Part No. e-spool with 1 twisterband, extension left	<i>Bi</i> in. (mm)	<i>hi</i> in. (mm)	Travel length ≤ ft. (m)	SP1 lbs. (kg)	Max Cable/hose diameter in. (mm)
SP1-240-2000-01-R-0		2.95 (75)	.83 (21)	13.12 (4)	≈ 72.75 (33.0)	.67 (17)
SP1-400-4000-01-R-0		2.95 (75)	.83 (21)	22.9(7)	≈ 83.78 (38.0)	.47 (12)

The max. bend radii of .94 (24 mm) in the inner radius and 1.38 (35 mm) in the outer radius should be observed.
 The max. bend radii of 1.34 (34 mm) in the inner radius and 2.24 (57 mm) in the outer radius should be observed.



Note: The compact e-spools for 6.56 ft (2 m) and 13.12 ft (4 m) extension are optimized for small installation spaces with smaller linear chains and twisterbands for a wide range of applications. As with the larger standard and HD systems, the compact e-spool systems enable trouble-free guidance and flexible filling.



Separators are delivered unassembled. Simply push them onto the crossbar!

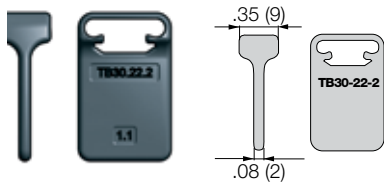

Separator for TB20-44-18

Unassembled Part No. TB20-18-2

- Separator TB20-44-18
 For twisterband

Separators - For installation simply open the e-chain®, insert a cable and push the separator onto the crossbar. Then add more cables. The separators provide a clear, cable-friendly interior separation.



Space-saving solution for a secure vertical movement. igus® e-spool with 11.48 ft. (3,500mm) extension length in this handling unit. Fitted with igus® chainflex® CF9 control and CF30 motor cables as well as CF-Robot torsion cable and CA-PU pneumatic hose

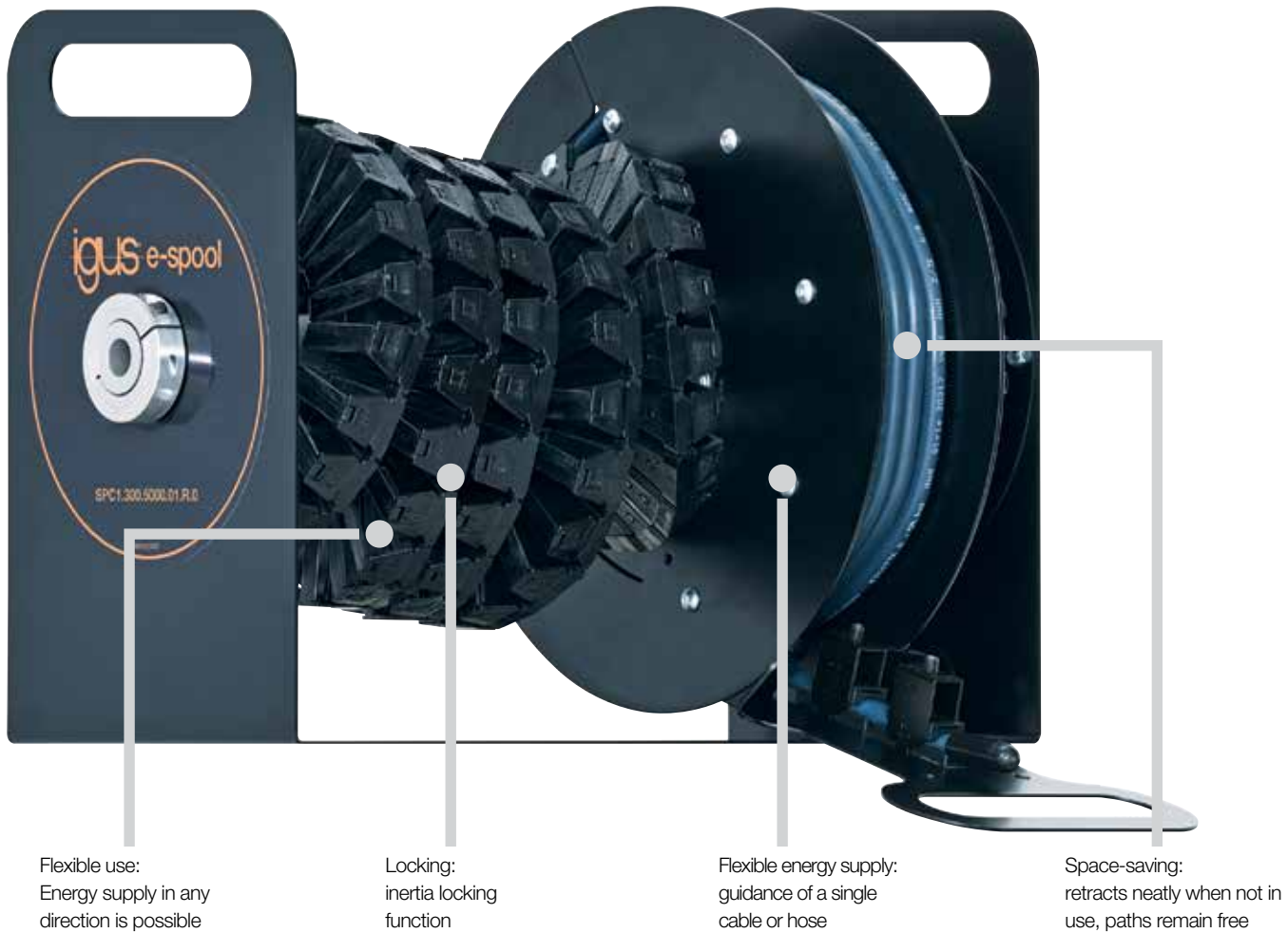

Flexible use:
 Energy supply in any
 direction is possible

Locking:
 inertia locking
 function

Flexible energy supply:
 guidance of a single
 cable or hose

Space-saving:
 retracts neatly when not in
 use, paths remain free

For applications where only one cable or hose is pulled out manually - e-spool for manual operation

The manually operated e-spool is designed for applications where only one cable or hose is pulled out by hand. The operator pulls out the cable to the required length for a control pendant or tool and can be retracted again after use. To prevent the cable from being under tension all the time, an inertia reel is fitted. In this way, the extension length can be locked. An extension length of up to 5m can be achieved.

- For applications where only one cable or hose is pulled out manually
- Compact, space-saving cable reel without slip ring
- Integrated locking mechanism against "unwanted" reverse winding (very similar to a vacuum cleaner cable)
- Also suitable for media and air hoses
- Handle with mounting option and strain relief

Typical industries and applications

- Robot teach pendants
- Workstations
- Assembly lines

Special solutions - Movements in all directions

e-spool for Manual Operation

Product Range

Part No. e-spool with 1 twisterband, extension right	<i>hi</i>	Travel length	SP1
	in. (mm)	≤ ft. (m)	(kg)
SPC1-300-5000-01-R-0	.71 (18)	16.41 (5)	≈ 27.56 (12.5)

Maximum cable or hose diameter: .47 (12mm)

The max. bend radii of 2.24 (57mm) should be observed.



The igus® e-spool in an extendable fan system made by Becker Electric Forklift Service in Ertstadt. Vertically extendable up to 10m. The e-spool supplies the motor with media and energy cables



Separators are delivered unassembled. Simply push them onto the crossbar!

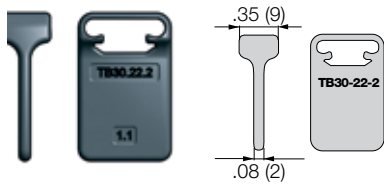

Separator for TB20-44-18

Unassembled Part No. TB20-18-2

- Separator TB20-44-18
For twisterband

Separators - For installation simply open the e-chain®, insert a cable and push the separator onto the crossbar. Then add more cables. The separators provide a clear, cable-friendly interior separation.



At Liverpool University (UK), e-spools supply power and data to arrays of height-adjustable speakers. End to end cables ensure the best possible transmission reliability and sound quality

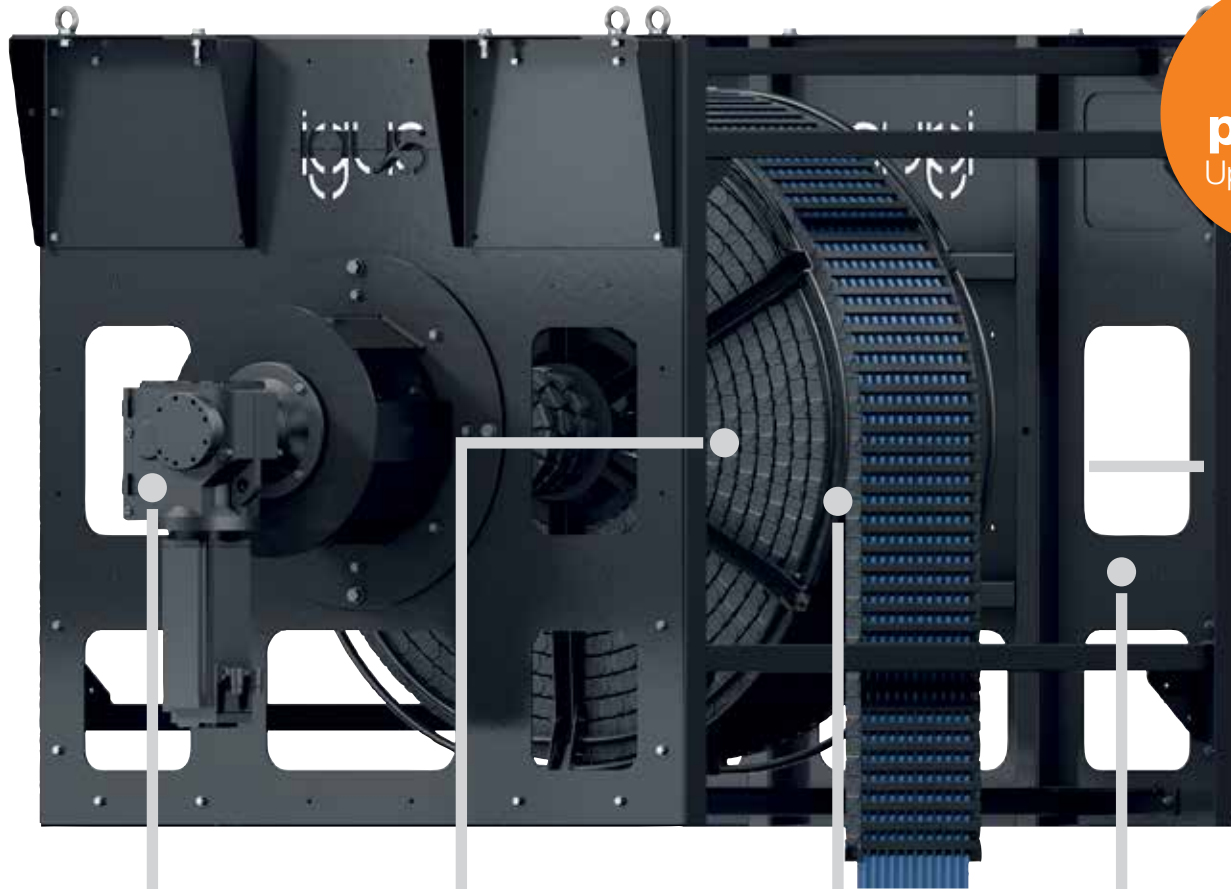

Flexible use:
 for extension lengths
 up to 114.8 ft. (35 m)

Flexible energy supply:
 guidance of different
 media in one system

Space-saving:
 retracts into a compact
 unit

Optional control system:
 plug & play controller,
 developed by igus®

Motor driven for long extension lengths - e-spool power

The e-spool power is a motor-driven e-spool for travels up to 35m. Like all e-spool systems, it can be filled with various cables and hoses and ensures reliable transmission with no breaks or slip rings. An igus® controller, which adapts dynamically to the travel speed, was specially developed for vertically hanging applications in theatres and opera houses and can be ordered as an option.

- Travel distances up to 35m
- Solid tubular steel construction
- Flexible filling with electrical and fibre optic cables, and pneumatic hoses
- Future-proof, additions and upgrades possible
- No tensile load on the cables

Typical industries and applications

- Theater, stage and lighting technology
- Indoor and outdoor cranes



Solutions for vertical motion liftband

Cable guidance up to 13m height with limited installation space



Advantages of liftband:

- For high vertical applications that need a compact solution
- Modular, silent, space-saving; vertical guidance for energy, data and media
- Max. extension length 13m
- Available in 2 sizes
- Alternative to zig-zag solutions, but lighter and requires less installation space
- Vertical applications implemented with ease



When to use another system:

- With very high loads that have to be guided vertically
 - ▶ Zig-zag applications
- For high dynamics with lateral accelerations
 - ▶ guidelok slimline P





Extended:
secure cable supply up to 42.65 ft. (13m)

Robust drive plate:
for easy attachment to your application

Safe and strong:
nylon straps for secure guidance and high fill weight

Tough:
even with lateral system movements through "push-button" joint

Light:
lightweight, compact design

Available in 2 sizes:
easy triflex® for easy fitting of cables

Chamfered basket:
for safe operation

Retracted:
safe storage in a solid steel basket

Optimized for space:
compact steel basket for best use of space

Cable guidance up to 42.65 ft. (13m) height with limited installation space - liftband

liftband - modular, silent, space-saving - igus® vertical guidance for energy, data and media.

High vertical applications that need a compact solution can be achieved with liftband.

- 2 sizes: inner width .98" (25mm) and 1.26" (32mm)
- 2 bend radii: 6.89" (175mm) and 9.84" (250mm)
- Alternative to zig-zag solutions
- Lighter and smaller installation space
- Vertical applications implemented with ease
- Max. extension length 42.65 ft. (13m)

Typical industries and applications

- Theater and stage technology
- Indoor cranes
- Mobile telescopic antennas

Series	Extension height ft. (m)	Inner height <i>hi</i> in. (mm)	Inner width <i>Bi</i> in. (mm)	Bend radius $\leq R$ in. (mm)	Cable $\leq \varnothing$ in. (mm)
--------	-----------------------------	------------------------------------	-----------------------------------	----------------------------------	--------------------------------------

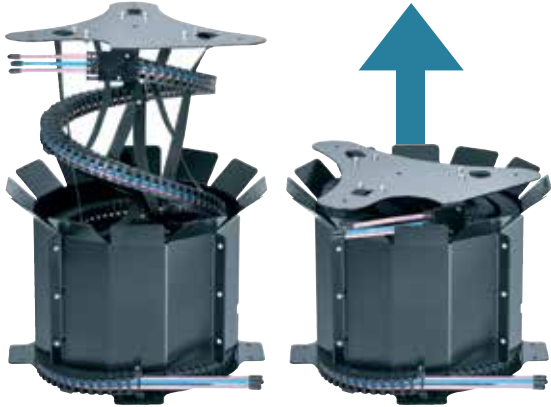

liftband -

cable guidance up to .51" (13mm) height with limited installation space

LB.E332.25 ¹⁾	3.28 - 42.65 (1 - 13)	.08 x .51 (2 x 13)	.98 (25)	6.89 (175)	\varnothing .35 (9)
LB.E332.32 ²⁾	3.28 - 42.65 (1 - 13)	.08 x .67 (2 x 17)	1.26 (32)	9.84 (250)	\varnothing .47 (12)

1) Simply press cables up to a diameter of .35" (9mm) into the e-chain®/pull cables up to a diameter of .43" (11mm) into the e-chain®

2) Simply press cables up to a diameter of .47" (12mm) into the e-chain®/pull cables up to a diameter of .59" (15mm) into the e-chain®



liftband - delivery time* 3-5 business days

*The delivery times indicated correspond to the average time until the ordered goods are dispatched.

Technical Data

Speed vertical	max. 3.28 ft/s (1 m/s)
Acceleration	max. 6.56 ft/s ² (2 m/s ²)
Lateral speed	max. 3.28 ft/s (1 m/s)
Lateral acceleration	max. 6.56 ft/s ² (2 m/s ²)



Details of material properties

► Chapter 1

liftband Series LB-E332-25 - e-chain® with "easy" design - inner width .98" (25 mm)

Part No. liftband	Extension Height ft (m)	Inner Width <i>Bi</i> in. (mm)	Inner Height <i>hi</i> in. (mm)	Bending Radius Max. <i>R</i> in. (mm)	Cable Max. Ø in. (mm)
LB-E332-25-2-175-1-01-0	3.28 (1)	.98 (25)	.08 x .51 (2 x 13)	6.89 (175)	Ø .35 (9)
LB-E332-25-2-175-2-01-0	6.56 (2)	.98 (25)	.08 x .51 (2 x 13)	6.89 (175)	Ø .35 (9)
LB-E332-25-2-175-3-01-0	9.84 (3)	.98 (25)	.08 x .51 (2 x 13)	6.89 (175)	Ø .35 (9)
LB-E332-25-2-175-4-01-0	13.12 (4)	.98 (25)	.08 x .51 (2 x 13)	6.89 (175)	Ø .35 (9)
LB-E332-25-2-175-5-01-0	16.41 (5)	.98 (25)	.08 x .51 (2 x 13)	6.89 (175)	Ø .35 (9)
LB-E332-25-2-175-6-01-0	19.69 (6)	.98 (25)	.08 x .51 (2 x 13)	6.89 (175)	Ø .35 (9)
LB-E332-25-2-175-7-01-0	22.97 (7)	.98 (25)	.08 x .51 (2 x 13)	6.89 (175)	Ø .35 (9)
LB-E332-25-2-175-8-01-0	26.25 (8)	.98 (25)	.08 x .51 (2 x 13)	6.89 (175)	Ø .35 (9)
LB-E332-25-2-175-9-01-0	29.53 (9)	.98 (25)	.08 x .51 (2 x 13)	6.89 (175)	Ø .35 (9)
LB-E332-25-2-175-10-01-0	32.81 (10)	.98 (25)	.08 x .51 (2 x 13)	6.89 (175)	Ø .35 (9)
LB-E332-25-2-175-11-01-0	36.10 (11)	.98 (25)	.08 x .51 (2 x 13)	6.89 (175)	Ø .35 (9)
LB-E332-25-2-175-12-01-0	39.37 (12)	.98 (25)	.08 x .51 (2 x 13)	6.89 (175)	Ø .35 (9)
LB-E332-25-2-175-13-01-0	42.65 (13)	.98 (25)	.08 x .51 (2 x 13)	6.89 (175)	Ø .35 (9)

*Simply press cables up to a diameter of .35" (9 mm) into the e-chain® / pull cables up to .43" (11 mm) into the e-chain®

liftband Series LB-E332-25 - e-chain® with "easy" design - inner width .98" (25 mm)

Part No. liftband	Extension Height ft (m)	Inner Width <i>Bi</i> in. (mm)	Inner Height <i>hi</i> in. (mm)	Bending Radius Max. <i>R</i> in. (mm)	Cable Max. Ø in. (mm)
LB-E332-32-2-250-1-01-0	3.28 (1)	1.26 (32)	.08 x .67 (2 x 17)	9.84 (250)	Ø .47 (12)
LB-E332-32-2-250-2-01-0	6.56 (2)	1.26 (32)	.08 x .67 (2 x 17)	9.84 (250)	Ø .47 (12)
LB-E332-32-2-250-3-01-0	9.84 (3)	1.26 (32)	.08 x .67 (2 x 17)	9.84 (250)	Ø .47 (12)
LB-E332-32-2-250-4-01-0	13.12 (4)	1.26 (32)	.08 x .67 (2 x 17)	9.84 (250)	Ø .47 (12)
LB-E332-32-2-250-5-01-0	16.41 (5)	1.26 (32)	.08 x .67 (2 x 17)	9.84 (250)	Ø .47 (12)
LB-E332-32-2-250-6-01-0	19.69 (6)	1.26 (32)	.08 x .67 (2 x 17)	9.84 (250)	Ø .47 (12)
LB-E332-32-2-250-7-01-0	22.97 (7)	1.26 (32)	.08 x .67 (2 x 17)	9.84 (250)	Ø .47 (12)
LB-E332-32-2-250-8-01-0	26.25 (8)	1.26 (32)	.08 x .67 (2 x 17)	9.84 (250)	Ø .47 (12)
LB-E332-32-2-250-9-01-0	29.53 (9)	1.26 (32)	.08 x .67 (2 x 17)	9.84 (250)	Ø .47 (12)
LB-E332-32-2-250-10-01-0	32.81 (10)	1.26 (32)	.08 x .67 (2 x 17)	9.84 (250)	Ø .47 (12)
LB-E332-32-2-250-11-01-0	36.10 (11)	1.26 (32)	.08 x .67 (2 x 17)	9.84 (250)	Ø .47 (12)
LB-E332-32-2-250-12-01-0	39.37 (12)	1.26 (32)	.08 x .67 (2 x 17)	9.84 (250)	Ø .47 (12)
LB-E332-32-2-250-13-01-0	42.65 (13)	1.26 (32)	.08 x .67 (2 x 17)	9.84 (250)	Ø .47 (12)

*Simply press cables up to a diameter of .47" (12 mm) into the e-chain® / pull cables up to .59" (15 mm) into the e-chain®

Special solutions - Movements in all directions
liftband
Product Range - Dimensions



liftband test setup in the igus® test lab



Solutions for vertical motion

guidelok slimline P

Safe vertical guidance



Advantages of guidelok slimline P:

- Up to 23 ft/s (7m/s) and 32.8 ft/s² (10m/s²)
- Up to 80% less trough required, saving costs and weight
- For hanging systems up to 164 ft. (50m)
- No swinging of the e-chain®, high reliability due to the lock mechanism and guiding rails
- Faster and easier installation
- Reduced noise
- Easy access for servicing
- Energy, data and all kinds of media can be safely guided



When to use another system:

- With very high loads that have to be guided vertically
 - ▶ Zig-zag applications
- For high vertical applications with limited space
 - ▶ liftband



Safe guidance:
Also at high travel speeds

Quick assembly:
lightweight glass-fiber reinforced plastic
profiles ensure easy and quick installation

Long travels:
Travels up to 164 ft. (50 m) in 4.92 ft. (1.5 m)
or 6.56 ft. (2 m) field length possible

No swinging out of the e-chain®:
guidelok safety catches to guide the
e-chain® even at high lateral accelerations

Safe vertical guidance - guidelok slimline P

In highly dynamic rack feeder a speed for the horizontal movement exceeding in 23 ft. (7 m/s) is not uncommon. The advanced igus® guidelok slimline P guides e-chains® even at the fastest speeds or accelerations.

NOTE: Systems of this type should be designed with our engineering team. We can provide a quote quickly – please contact us.

- Up to 23 ft. (7 m/s) and 32.8 ft. (10 m/s²)
- Up to 80% less trough required, saving costs and weight
- For hanging systems up to 164 ft. (50 m)
- No swinging of the e-chain®, high reliability due to the lever mechanism and guiding rails
- Faster and easier installation
- Reduced noise
- Easy access for servicing
- Energy and data and all kinds of media are safely

Typical industries and applications

- Storage and retrieval units
- Lifts
- Elevators
- Construction and crane lifts
- Hoists

Special solutions - Movements in all directions

guidelok slimline P

Selection



Series	For e-chains® series	Inner height <i>hi</i> in. (mm)	Inner width <i>Bi</i> in. (mm)	Bend radius <i>R</i> in. (mm)
--------	----------------------	------------------------------------	-----------------------------------	----------------------------------

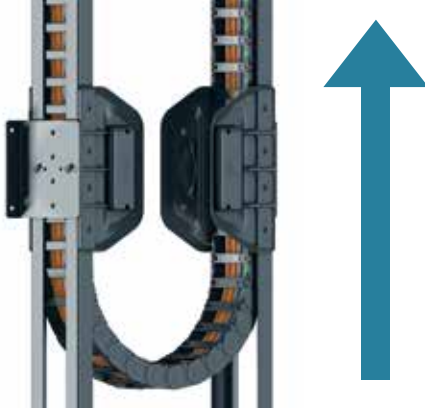

guidelok slimline P -
safe vertical guidance

GLSL-P-255-10	255	.94 (24)	3.94 (100)	5.91 - 9.84 (150 - 250)
GLSL-P-2700-10	2700	1.38 (35)	3.94 (100)	5.91 - 9.84 (150 - 250)

Special versions with different widths, radii and channel section lengths possible. Please consult igus® for delivery time.



Available from stock. Ready to ship in 24 - 48hrs.*

*The delivery times indicated correspond to the average time until the ordered goods are dispatched.



Find a video online

► www.igus.com/glslp-movie

Made completely from plastic, cost-effective, light and easy to assemble - guidelok slimline P.S

- Significant savings in costs and weight
- Fast, safe and easy assembly with clip-on guide rails
- Reduced noise
- Easy access for servicing
- Energy, data and all kinds of media can be safely guided
- For hanging systems up to 164 ft. (50m)
- Speed up to 22.97 ft/s (7m/s) and acceleration up to 32.81 ft/s (10m/s²)
- **More information** ► www.igus.com/gsls-ps



Part No.	For series	<i>Bi</i> in. (mm)	<i>R</i> in. (mm)
guidelok P			
GLSL-P-255- 10-R-LLLL/FFFF	255	4.06 (103)	150 175 200 225 250
GLSL-P-2700-10-R-LLLL/FFFF	2700	3.94 (100)	150 175 200 - 250

LLLL = Total length FFFF = Channel section length

Special versions with different widths, radii and channel section lengths possible. Please consult igus® for delivery time.

Complete Part No. with required radius (*R*) and required value for total length and channel section length

Example: GLSL-P-2700-10-150-9000/1500

Installation dimensions

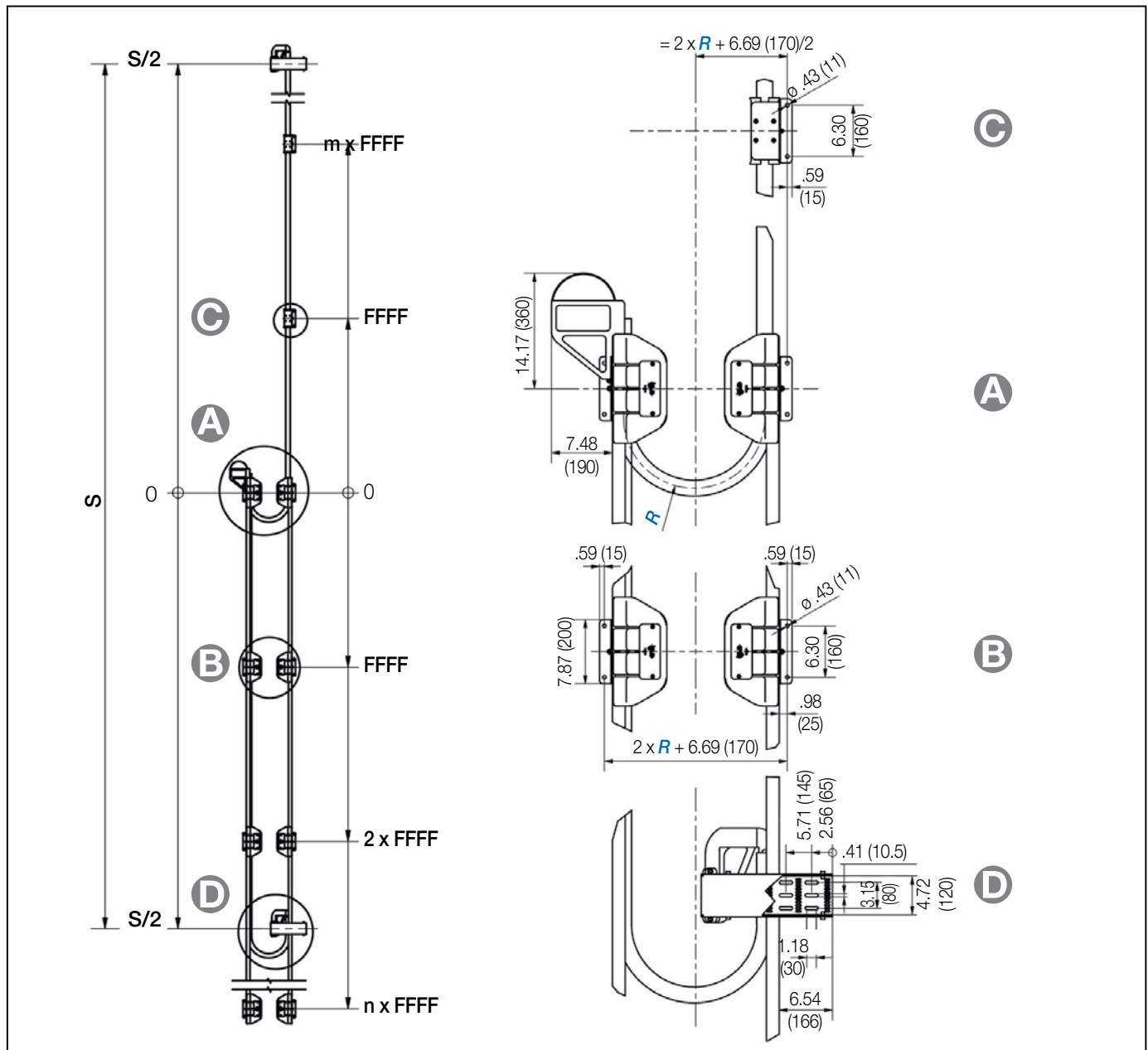



guidelok slimline P in a high-bay warehouse

Cable guidance for vertical applications: lighter, low-noise, easier - lower costs - guidelite GLV - New

- The "guidelite vertical" (GLV) guide trough guides e-chains® and cables for vertical applications such as high bay warehouse safely in one system
- Segmental design and lightweight components reduce weight and noise
- Open design and self-locking screws facilitate easy assembly
- Significant savings in costs and weight when compared with a complete housing
- Easy access for servicing

More information ► www.igus.com/GLV

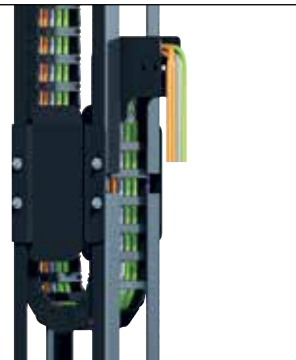

Technical Data



Speed vertical

max. 23 ft/s (7 m/s)

Acceleration

max. 32.8 ft/s² (10 m/s²)

Details of material
properties

► Chapter 1



Solutions for horizontal motion

guidelok horizontal

Upper run guide for long travels, unsupported in chip areas



Advantages of guidelok horizontal:

- Chips cannot get stuck between upper and lower run
- Modular system with few parts
(also possible without lateral trough)
- Lower cost than most steel chains or gliding systems
- Open guide trough design, chips can fall through



When to use another system:

- For a cost-effective and fully enclosed complete solution
 - ▶ **basic flizz**®
- For a compact, quiet and cost-effective complete system as a maintenance-free alternative to a busbar
 - ▶ **micro flizz**®

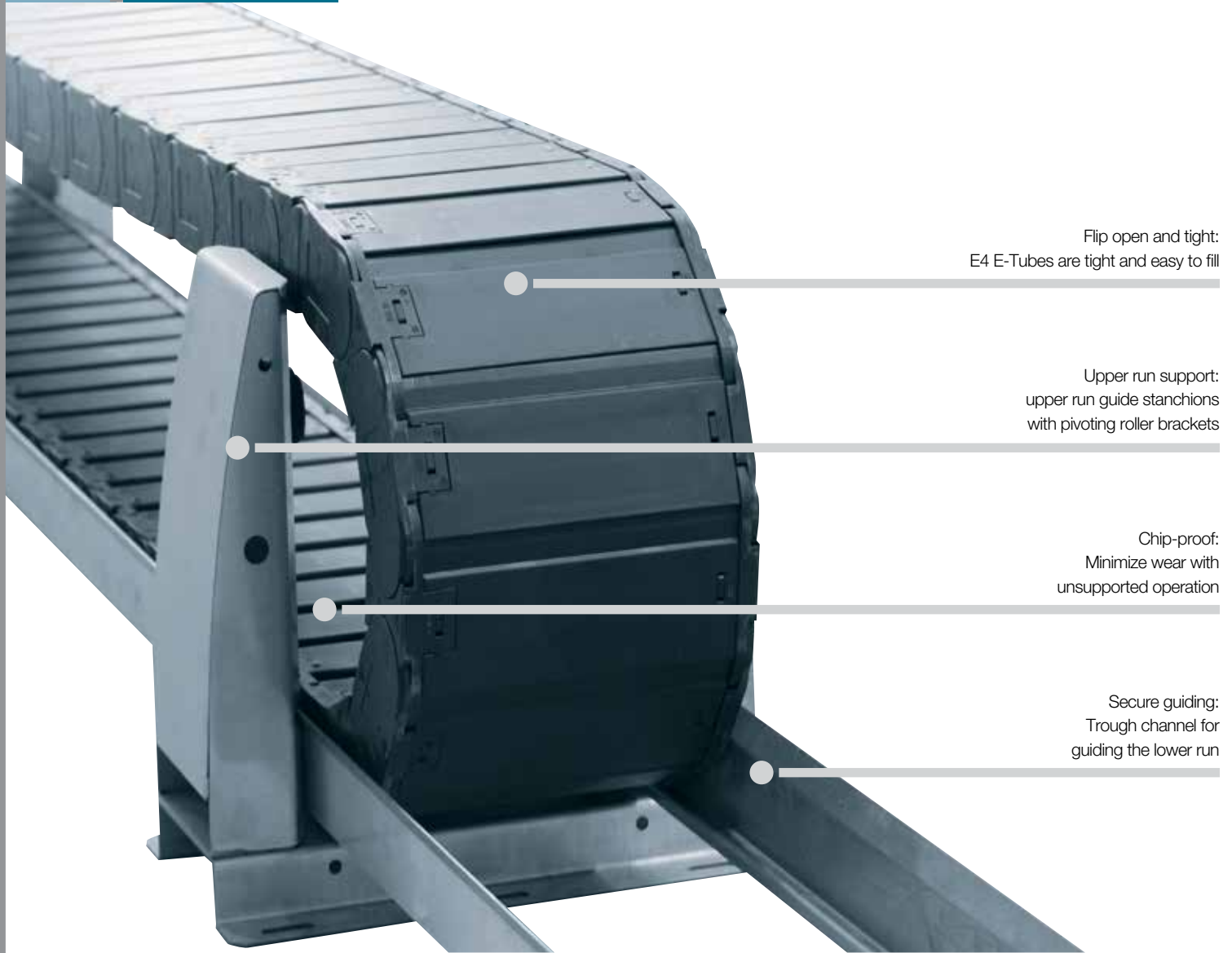

Flip open and tight:
 E4 E-Tubes are tight and easy to fill

Upper run support:
 upper run guide stanchions
 with pivoting roller brackets

Chip-proof:
 Minimize wear with
 unsupported operation

Secure guiding:
 Trough channel for
 guiding the lower run

Self-supporting in chip areas - guidelok horizontal

Especially for long travels on machine tools, when the e-chain® has to be gliding, metallic chips are a problem. guidelok horizontal is a cost-effective solution.

- Travels, unsupported up to 164 ft. (50 m) possible
- Chips cannot get stuck between upper and lower run
- Modular system with few parts (also possible without sideways trough)
- Enormous increase of "self-supporting" length of e-chains®
- Lower push-/pull forces (smaller e-chains®, self-supporting and rollers = energy efficient)
- Lower cost than most steel chains or ambitions gliding systems
- Open guide trough design, chips can fall through

Typical industries and applications

- Machine tools
- Applications in chip areas
- Wherever a gliding application is not recommended

More solutions for long travel

guidelok Horizontal - Upper run guide for long travels

Dimensions

Design-principle - horizontal guidelok guides the e-chain® on special spring loaded roller supports that are pushed back by the e-chain® radius, clearing its path



The e-chain® is guided in the trough channel, pushing back the spring loaded roller support with its radius...



...which snaps back out after the e-chain® radius has passed...



...the upper run then lays on the roller support.

LLLL = S

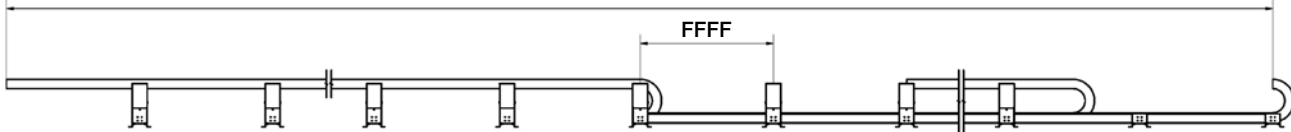

Design sketch - guidelok horizontal

Selection table

For Series	Part Number	<i>Bi</i> (mm)	<i>R</i> (mm)
E4-56/R4-56	907-645- <i>Bi</i> - <i>R</i> - LLLL/FFFF	(150 - 600)	150, 175, 200, 250, 300
E4-80/R4-80	907-645- <i>Bi</i> - <i>R</i> - LLLL/FFFF	(50 - 600)	150, 175, 200, 250, 300
E4-112	907-645- <i>Bi</i> - <i>R</i> - LLLL/FFFF	(200 - 600)	150, 175, 200, 250, 300
E4-56/R4-56	907-837- <i>Bi</i> - <i>R</i> - LLLL/FFFF	(50 - 600)	350, 400, 450, 500
E4-80/R4-80	907-837- <i>Bi</i> - <i>R</i> - LLLL/FFFF	(50 - 600)	350, 400, 450, 500
E4-112	907-837- <i>Bi</i> - <i>R</i> - LLLL/FFFF	(200 - 600)	350, 400, 450, 500

LLLL = Total Length

FFFF = Field Length

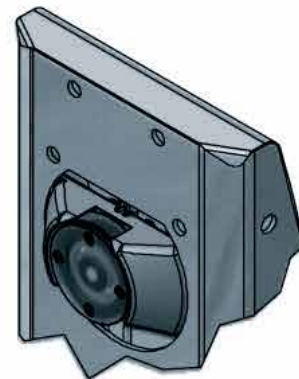
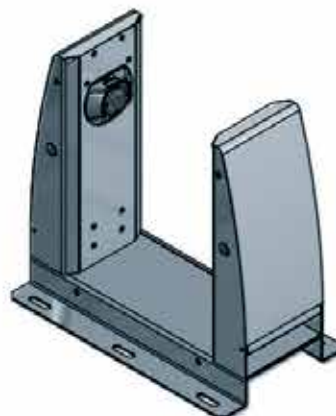
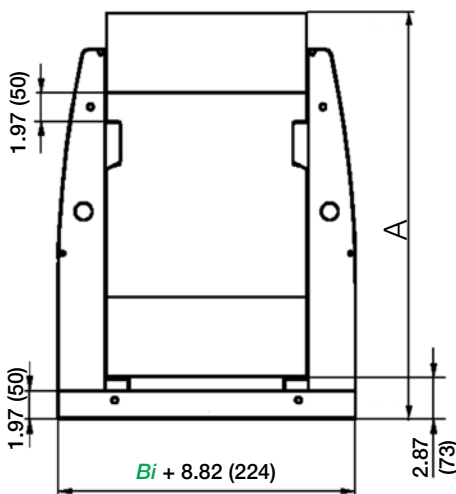

Lateral supports with pivoting rollers for the upper run support of the e-chain®





Solutions for horizontal motion

basic flizz®

Cost-effective, enclosed solution for long travels, e.g. wastewater treatment plants



Advantages of basic flizz®:

- Protection against weather and dirt exposure
- Low-maintenance system
- Cost-effective and fully enclosed complete system
- Standardized and modular design
- Easy wall, floor or ceiling mounting options
- Cables or hoses can be easily retrofitted
- Reduce power costs - directly driven by the scraper. No additional drives needed (as is the case on cable reels)



When to use another system:

- For an upper run guide for long travels, unsupported in chip areas
 - ▶ **guidelok horizontal**
- For a compact, quiet and cost-effective complete system as a maintenance-free alternative to a busbar
 - ▶ **micro flizz®**



Wall mounting



Floor attachment

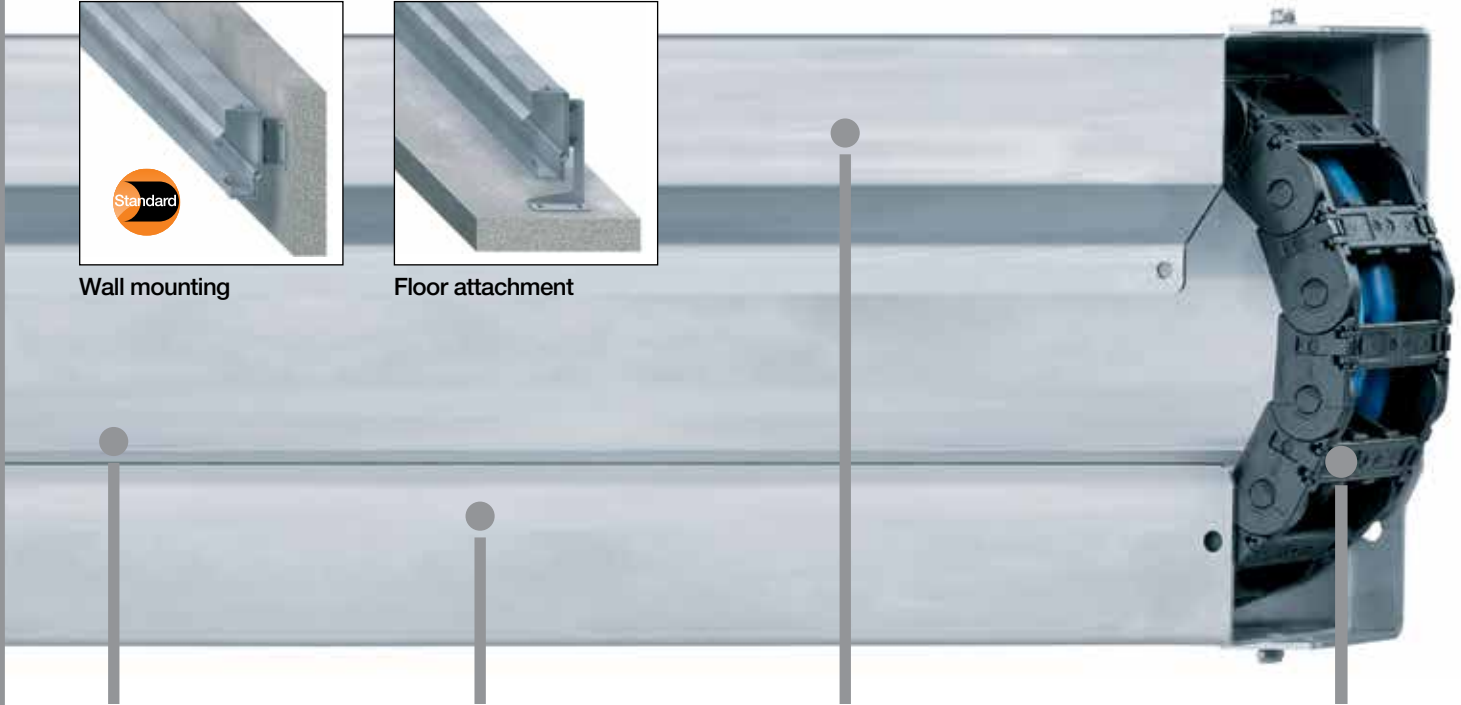

Protected:
Weather-resistant,
enclosure

Reliable guide:
Guide rail integrated into the
profile

Modular design:
Easy assembly,
compact construction

Fast assembly: Snap-open
along the outer radius

Cost-effective, enclosed solution for long travels - basic flizz®

- Low-maintenance system for travels up to 328 ft. (100 m)
- Other sizes and versions available, up to 200 travel with E2 rol e-chains® and more
- Protection against weather and dirt exposure - Cost-effective and fully enclosed complete solution
- Standardized and modular design
- Easy wall mounting or optionally as floor attachment
- Cable lengths up to 50 % shorter than festooning, low-profile installation and no cable salad
- Cables are always guided with a defined bending radius
an tension forces will be supported by the e-chain®
- Cables cannot entangle, hang, or tear
- No slip-ring contact (as is the case on motor drums)
- Cables or hoses can be easily retrofitted on demand
- Reduce power costs - directly driven by scraper.
No additional drives needed (as is the case on motor drums)
- Optionally available moving end arm (e.g. as mechanical connection for scraper trolley -
we will document the local situation and will provide a tailored solution

Typical industries and applications

- Sludge scrapers
- Longitudinal scrapers
- Sand catchers
- Grease trap
- Waste-water treatment
- Plating facilities
- Cranes
- Plant construction
- Locks

More solutions for long travel

basic flizz® - Enclosed solution for long travels

Dimensions



basic
flizz®

Part Number	Specification	Support gap in. (mm)
basic flizz®		
IE92-31-75-260-3000-01-E	basic flizz® - With glide bar	118 (3000)
IE92-31-75-260-3000-F-01-E	basic flizz® - Fixed-end module	118 (3000)
IE92-30-75-260-3000-01-E	basic flizz® - Without glide bar	118 (3000)

Standard material stainless steel V2A: material 1.4301 (AISI 304).

Optional: galvanized steel or stainless steel V4A: material 1.4404 (AISI 316L)

More lengths available upon request, please consult igus® for delivery time.



basic flizz® - enclosed
total solution



igus® basic flizz® - ideal for
waste-water treatment plants



Cost-effective,
maintenance-free system

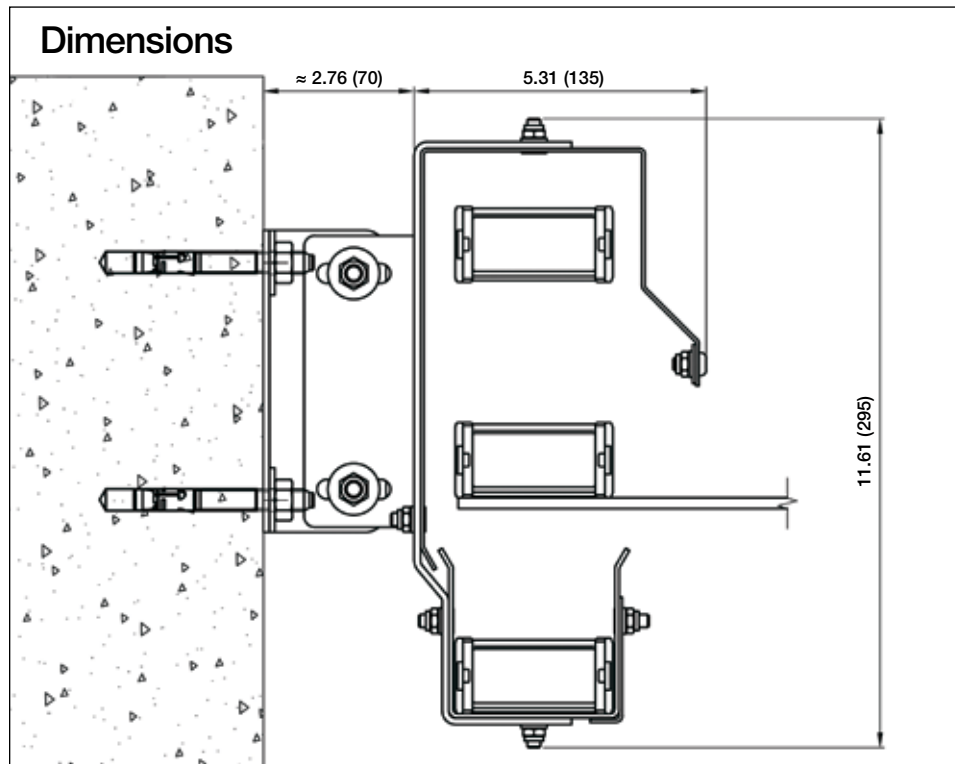

Simple assembly (wall-mounted or floor-mounted assembly), standardized, modular construction

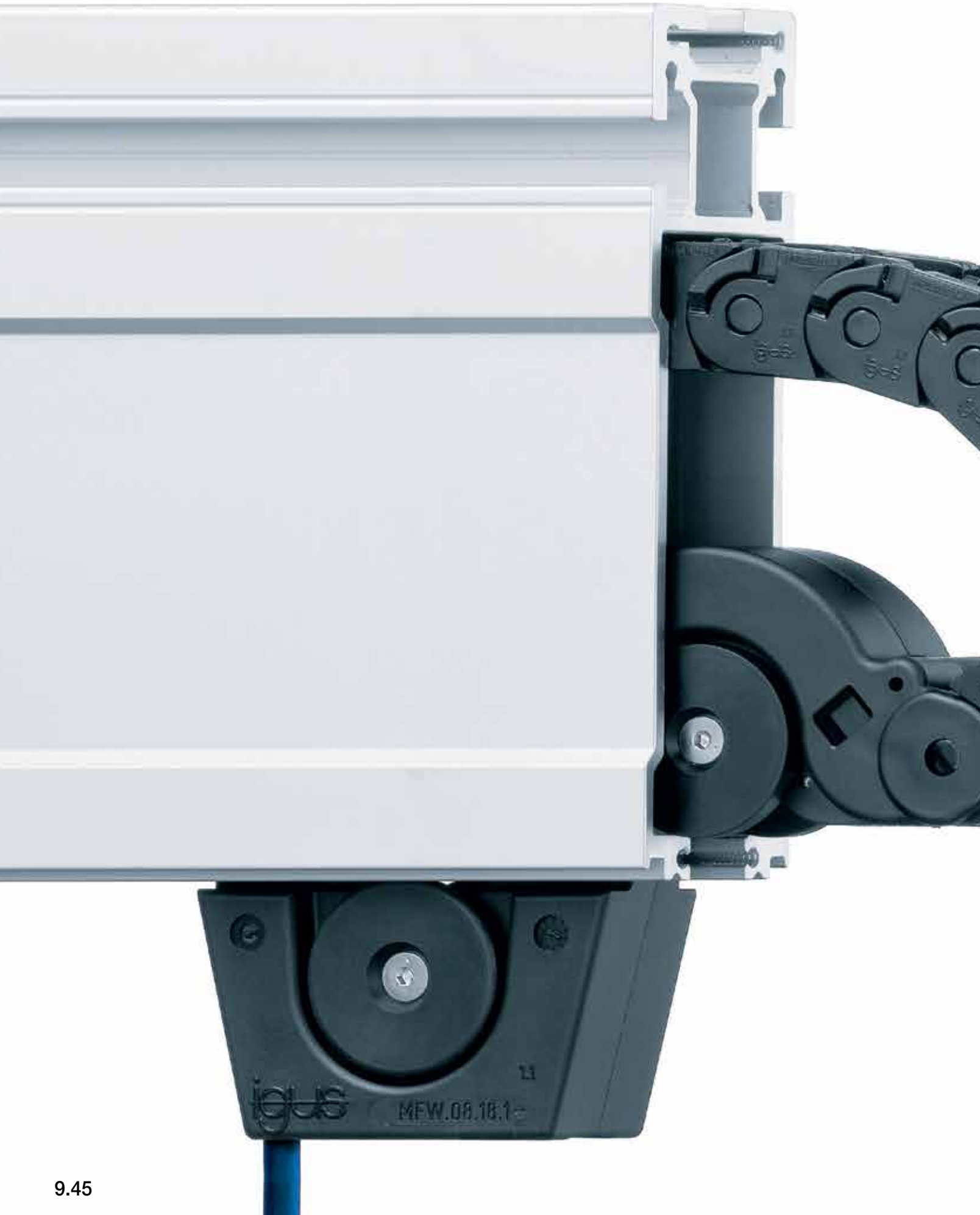



Solutions for horizontal motion

micro flizz®

A system for the safe guidance of energy, data and air



Advantages of micro flizz®:

- Compact, quiet, cost-effective complete system as a maintenance-free alternative to a busbar
- e-chain® is guided in special slots, no gliding
- Smooth running due to ball bearings in the guide carriages
- Fast assembly due to pre-configured, modular system
- Less space required
- Also available as pre-assembled system
- Control option via stationary switch cabinet



When to use another system:

- For an upper run guide for long travels, unsupported in chip areas
 - ▶ **guidelok horizontal**
- For a cost-effective and fully enclosed complete solution
 - ▶ **basic flizz®**

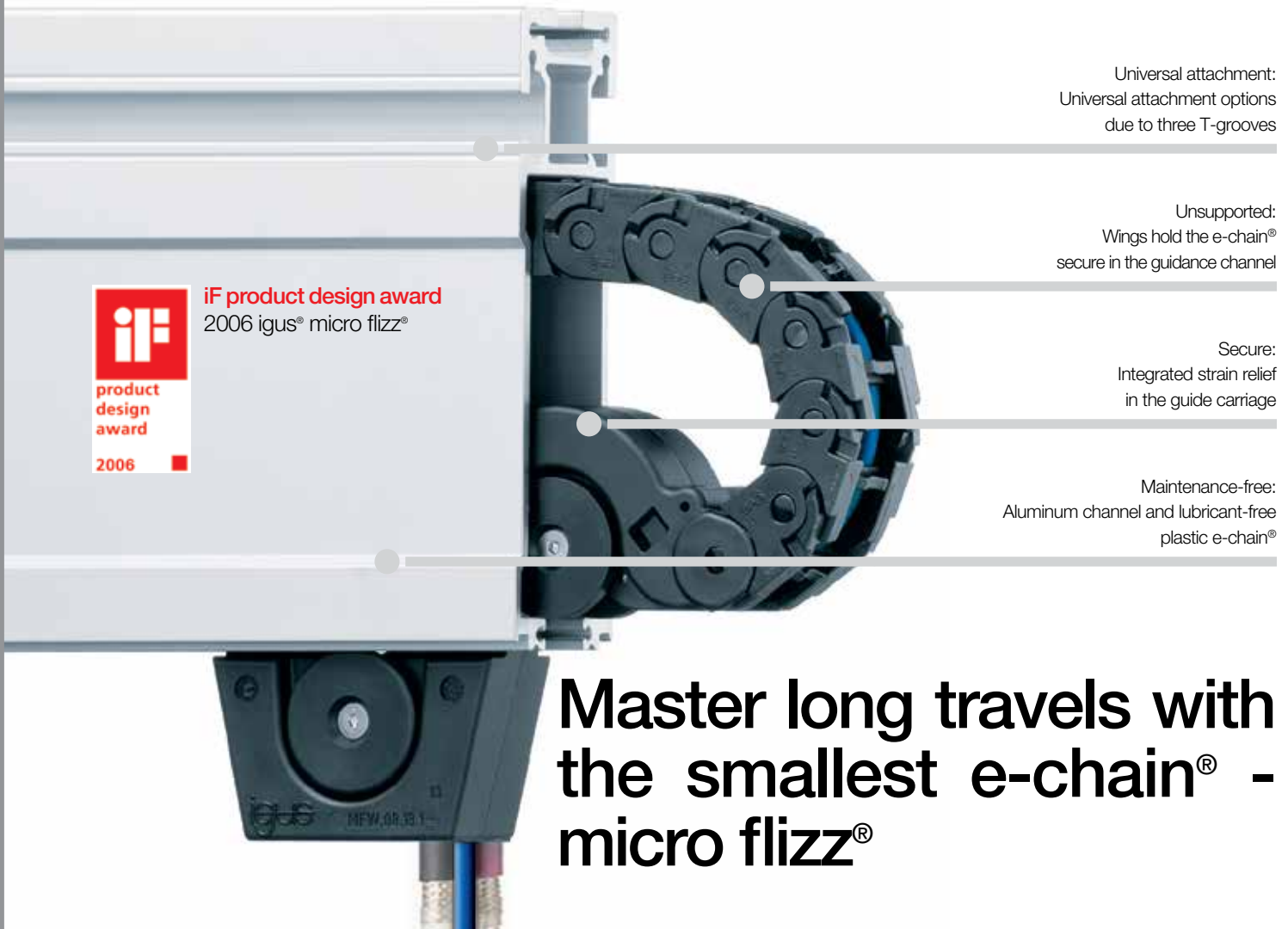

Universal attachment:
Universal attachment options
due to three T-grooves

Unsupported:
Wings hold the e-chain®
secure in the guidance channel

Secure:
Integrated strain relief
in the guide carriage

Maintenance-free:
Aluminum channel and lubricant-free
plastic e-chain®



iF product design award
2006 igus® micro flizz®

Master long travels with the smallest e-chain® - micro flizz®

Compact system for a secure guidance of power, data and air
as a maintenance-free alternative for busbar

- e-chain® is guided in special slot, no sliding against each other
- Control via stationary switch cabinet possible
- Accelerations up to 164 ft/s² (50 m/s²) and speeds up to 19.69 ft. (6 m/s)
- Fast assembly due to pre-configured, modular system
- Less space required
- Available also as pre-assembled
- Smooth running due to ball bearings in the guide carriages
- Also with EX tested e-chain® available (on request)
- 3 sizes available: cable diameters **MF06**: max. Ø .31" (8.0 mm), **MF08**: max. Ø .37" (9.5 mm), **MF10**: max. Ø .63" (16 mm)

Typical industries and applications

- Rack feeder
- Indoor cranes
- Industrial gates
- Working stations
- Sewage treatment plants
- Camera systems
- Sliding doors
- Operator panels
- Measure systems
- Studio equipment
- Conveyor technique

More solutions for long travel
 micro flizz® - Small e-chains® in aluminum profile
 Overview



Separated upper and lower run: Running trough the radius, integrated wings fold in



In the extended position, the wings fold out and safely hold the upper run in the elevated position

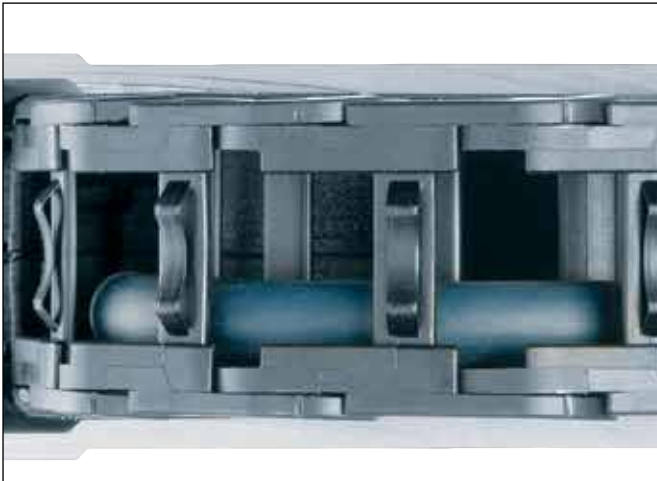

A polymer spring element cushions the motion inside the trough and lower noise

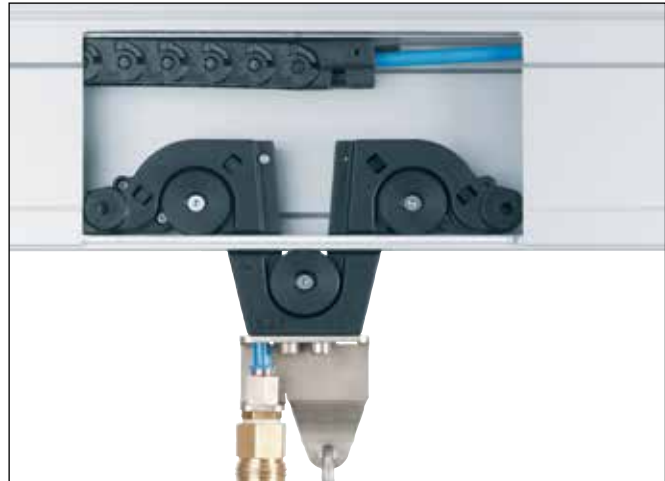

micro flizz® accessory: Connection for compressed air coupling

Special feature: micro flizz® construction

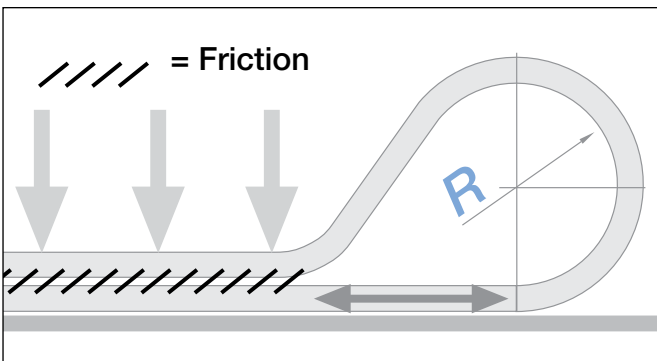

Yesterday: Moving lower run, sliding function.
 Long travels need stable e-chains®

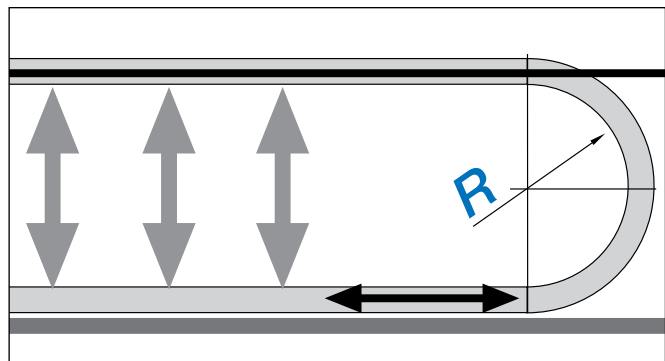

Today: micro flizz® - Small e-chains®, self-guiding in guiding channel - Friction is reduced by factor 3 over the conventional system.

Technical data micro flizz®

- ① Universal attachment options due to three T-grooves
- ② Wings hold the e-chain® secure in the guidance channel
- ③ Separated upper and lower run of the Flizz® e-chain®, thus less friction and reduced push/pull forces
- ④ Polymer springs for a soft unrolling of the e-chain® in the Flizz® channel effect a substantial noise reduction
- ⑤ Opposed e-chains® can be used, that means a double filling or two independent travels are possible
- ⑥ Attachment of the e-chain® by roller cart on the moving end, gliding or locking possible
- ⑦ Integrated strain relief in the guide carriage for the safe fixing of cables

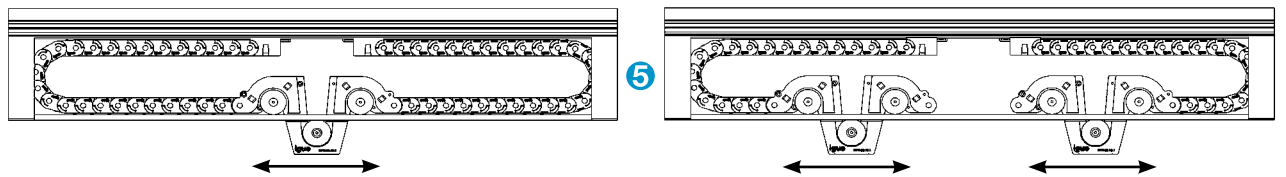
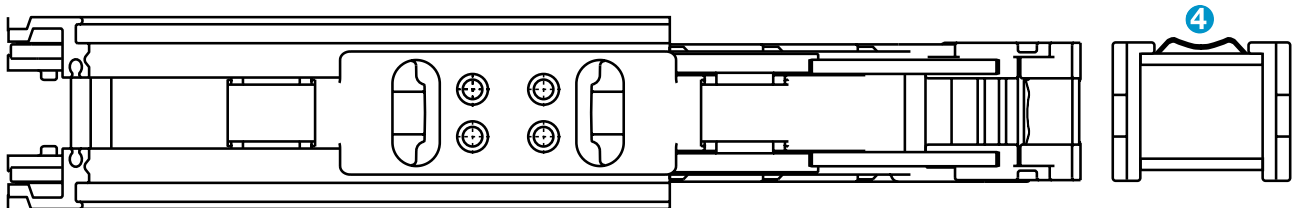
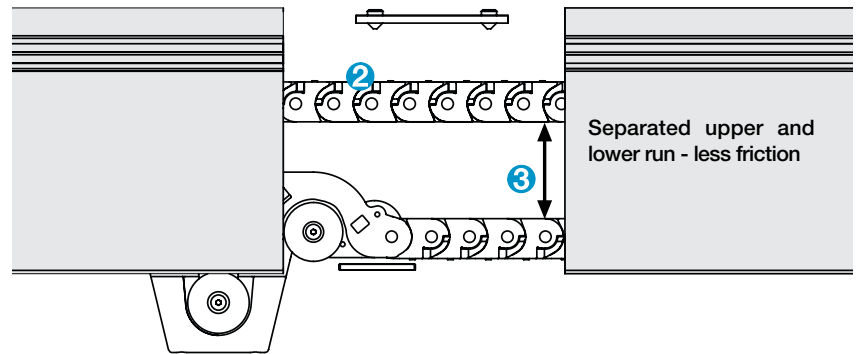
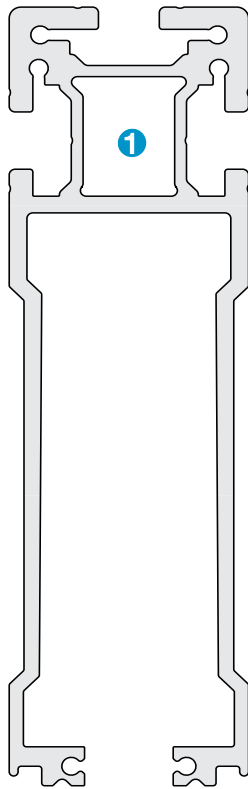

Details micro flizz®

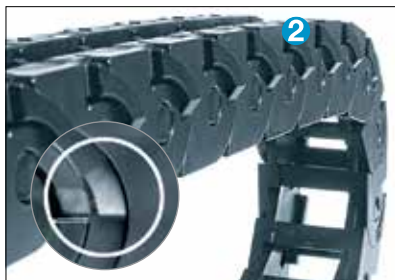

In the extended position, the wings fold out and safely hold the upper run in the elevated position

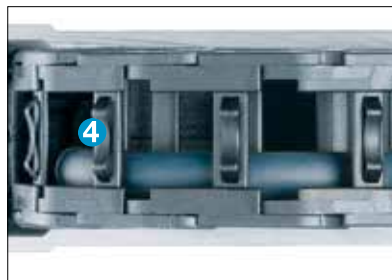

A polymer spring element cushions the motion inside the trough and lower noise



Power, data, pneumatics in confined areas. chainflex® cables are specifically designed for this challenge

micro flizz® Series MF06 - Part No. MF-06-10-018

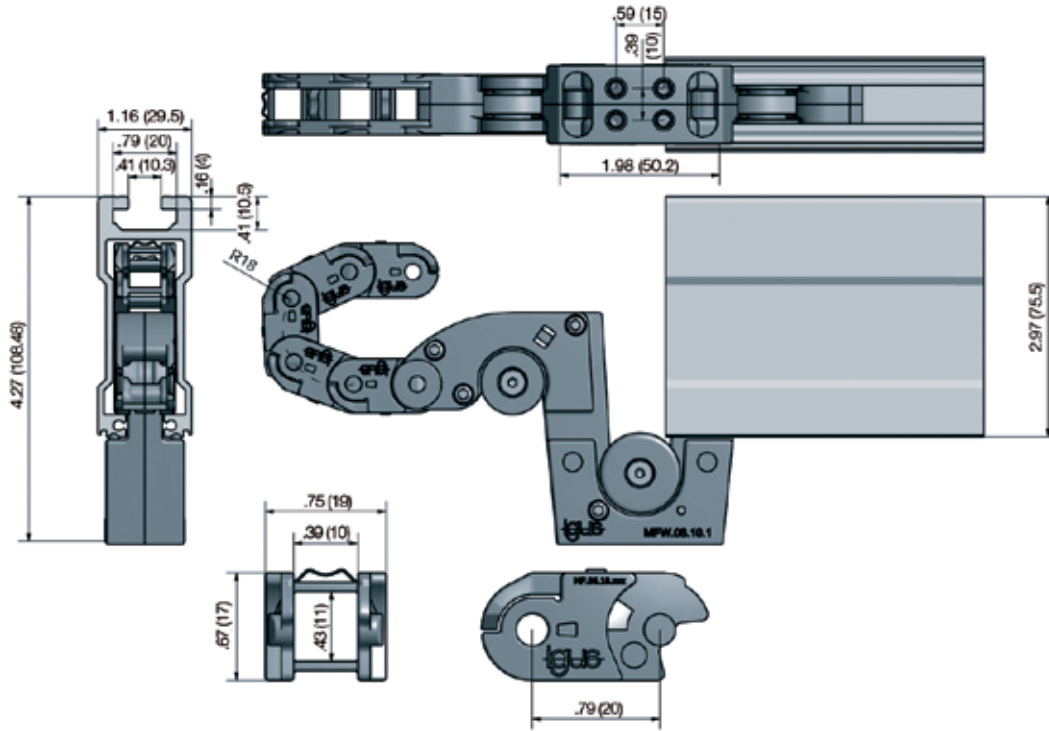

micro flizz® Series MF06 - Dimensions

Part No.	<i>Bi</i>	<i>Ba</i>	<i>hi</i>	<i>ha</i>	<i>R</i> Bending radius
	in. (mm)	in. (mm)	in. (mm)	in. (mm)	(mm)
MF-06-10-018	.39 (10)	.75 (19)	.43 (11)	.67 (17)	018

More dimensions

Installation height complete system:	108.48 mm
Installation width complete system:	29.5 mm
Recommended length channel pieces:	2.0 m, 3.0 m and 6.0 m - Die-cast aluminum material
Cable diameter max.:	8 mm

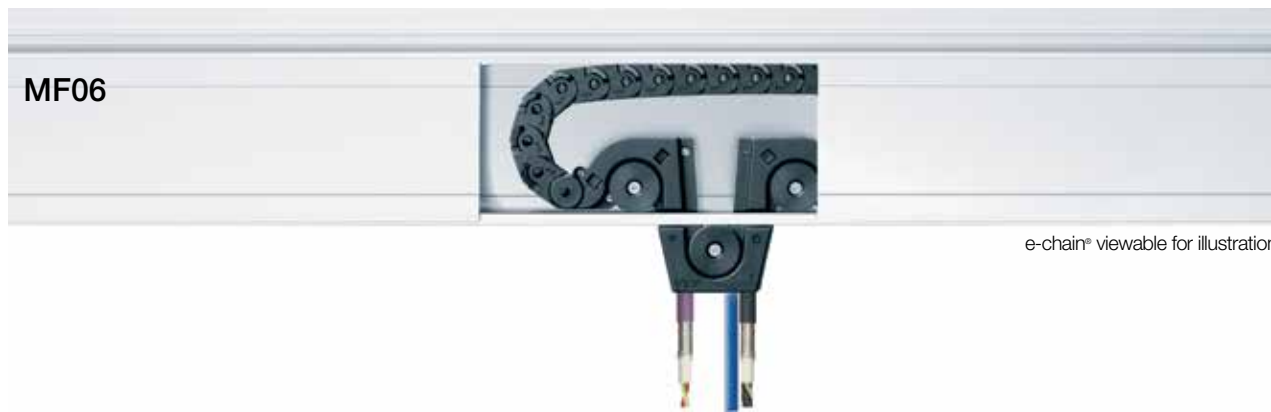

e-chain® viewable for illustration

PDF: igus.com/e-chain-pdfs
 Product information: igus.com/e-chains

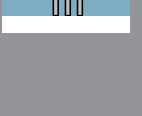
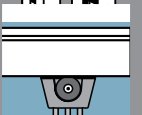
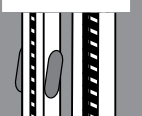
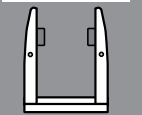
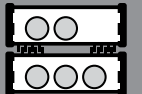

micro flizz® Series MF08 - Part No. MF-08-18-035

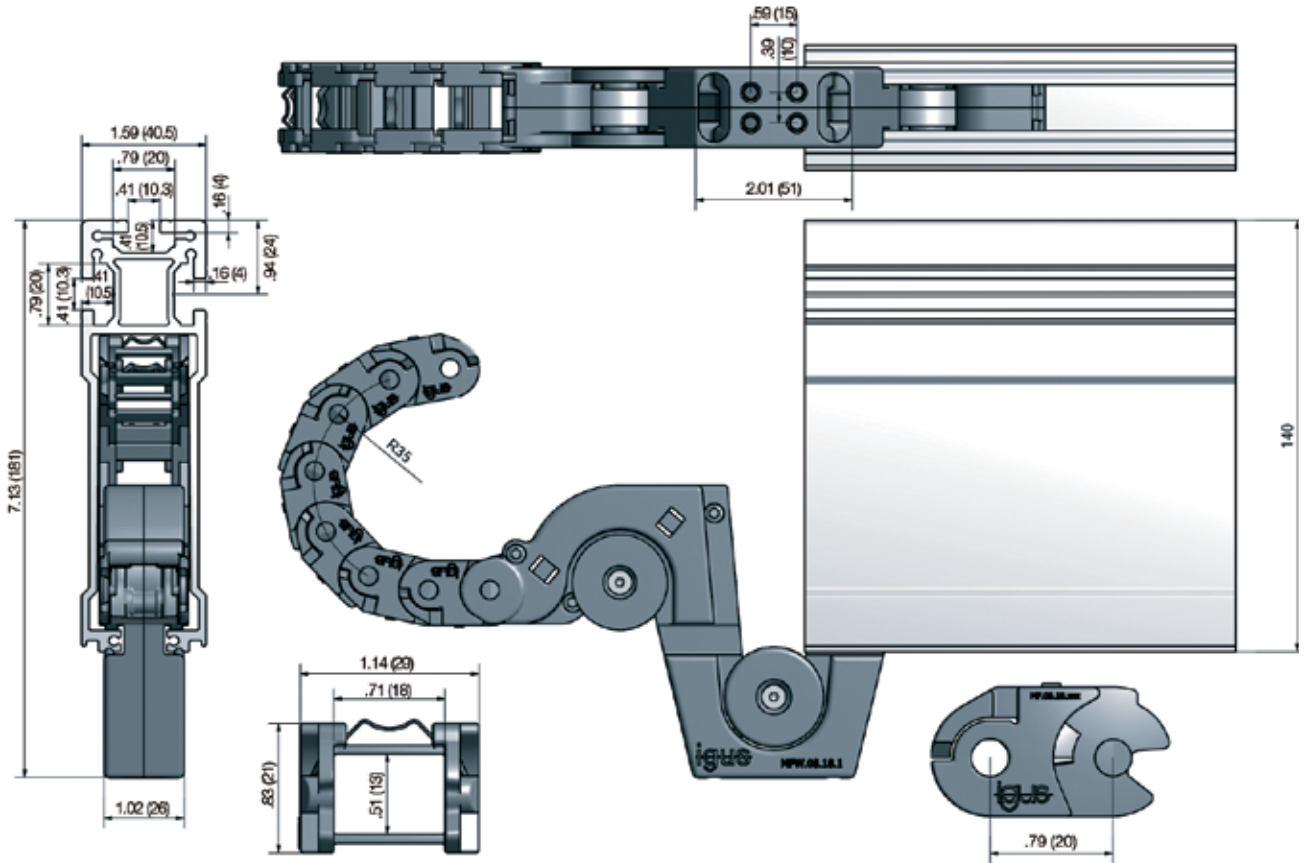

micro flizz® Series MF08 - Dimensions

Part No.	<i>Bi</i>	<i>Ba</i>	<i>hi</i>	<i>ha</i>	<i>R</i> Bending radius
	in. (mm)	in. (mm)	in. (mm)	in. (mm)	(mm)
MF-08-18-035	.71 (18)	1.14 (29)	.51 (13)	.83 (21)	035

Order example ▶ Page 9.179

More dimensions

Installation height complete system:	161 mm
Installation width complete system:	40.5 mm
Recommended length channel pieces:	2.0 m, 3.0 m and 6.0 m - Die-cast aluminum material
Cable diameter max.:	9.5 mm

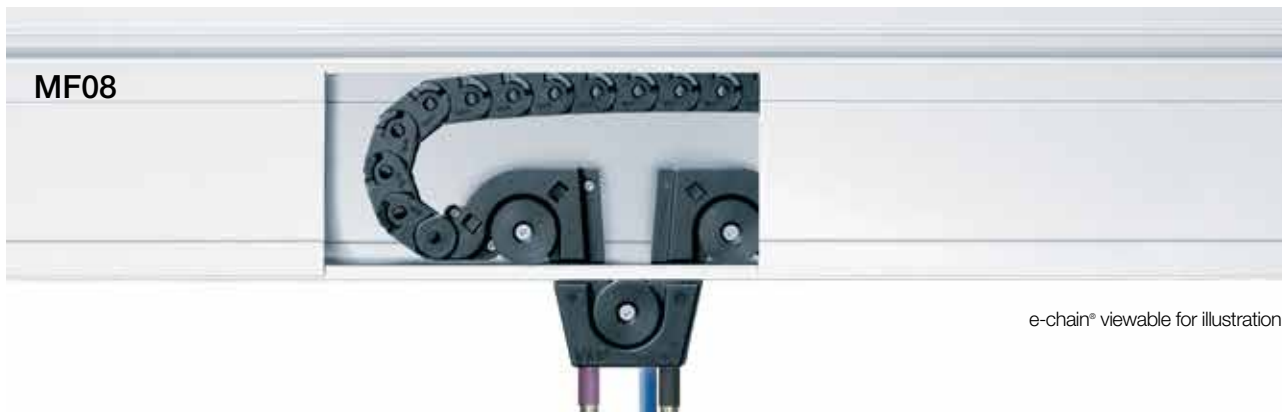

e-chain® viewable for illustration

micro flizz® Series MF10 - Part No. MF-10-50-075

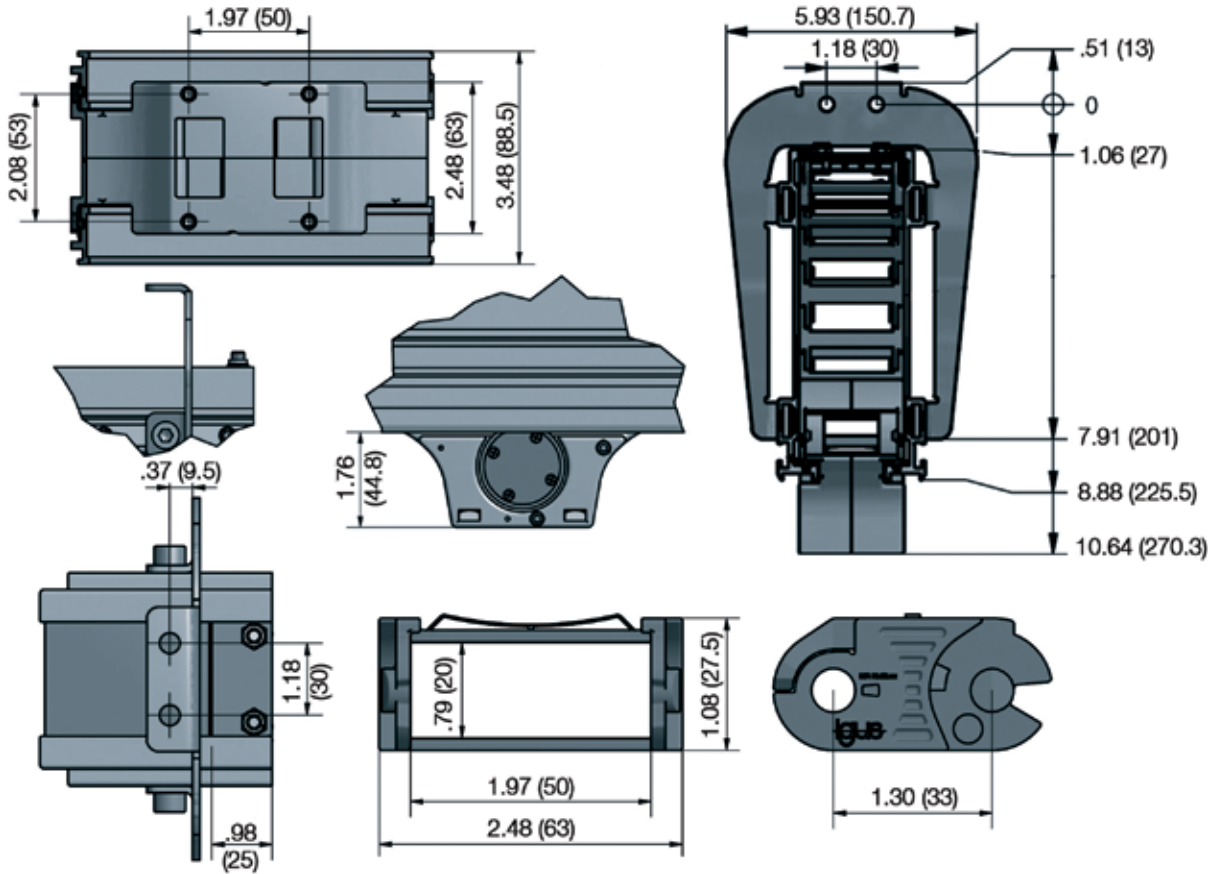

micro flizz® Series MF08 - Dimensions

Part No.	<i>Bi</i>	<i>Ba</i>	<i>hi</i>	<i>ha</i>	<i>R</i> Bending radius
	in. (mm)	in. (mm)	in. (mm)	in. (mm)	(mm)
MF-10-50-075	1.97 (50)	2.48 (63)	.79 (20)	1.08 (27.5)	075

Order example ▶ Page 9.179

More dimensions	
Installation height complete system:	275 mm
Installation width complete system:	107.6 mm
Recommended length channel pieces:	2.0 m, 3.0 m and 6.0 m - Die-cast aluminum material
Cable diameter max.:	16 mm



PDF: igus.com/e-chain-pdfs
 Product information: igus.com/e-chains

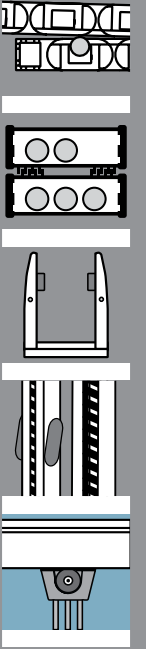

Order example - End feed

MF	06-	10-	018-	L / F
MF	08-	18-	035-	L / F
MF	10-	50-	075-	L / F

MF-06-10-018-5000/2000 Series MF06

MF-08-18-035-5000/2000 Series MF08

MF-08-18-035-5000/2000 Series MF10

F = Field length (mm)
L = Total length (mm)
R = Bending radius (mm)
Bi = Inner e-chain® width
Type (Series)

micro flizz® end feed

micro flizz® as end feed option with a total length of 5000 mm, split into 2 channels each 2000 mm and 1 channel with a residual length of 1000 mm

Bi = Inner e-chain® width (mm)
R = Bending radius (mm)
n = Number of channel pieces
S = travel = L - 300 (mm)
F = Field length (mm)
L = Total length (mm)
X = residual length (mm)

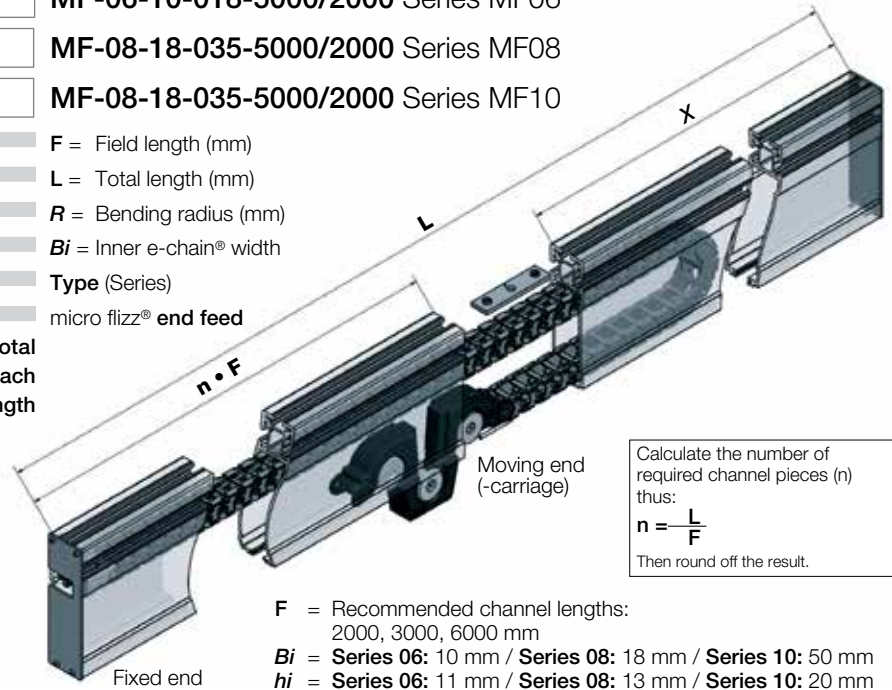

Calculate the number of required channel pieces (n) thus:
$$n = \frac{L}{F}$$

Then round off the result.

F = Recommended channel lengths:
2000, 3000, 6000 mm
Bi = Series 06: 10 mm / Series 08: 18 mm / Series 10: 50 mm
hi = Series 06: 11 mm / Series 08: 13 mm / Series 10: 20 mm

Order example - 2 carriages in opposite directions

MFG2	06-	10-	018-	L / F
MFG2	08-	18-	035-	L / F
MFG2	10-	50-	075-	L / F

MFG2-06-10-018-10000/3000 Series MF06

MFG2-08-18-035-10000/3000 Series MF08

MFG2-08-18-035-10000/3000 Series MF10

F = Field length [mm]
L = Total length [mm]
R = Bending radius [mm]
Bi = Inner e-chain® width
Type (Series)

micro flizz® 2 carriages
in opposite directions

micro flizz® mounted with 2 carriages in opposite directions - Total length 10000 mm, split into 2 channels each 3000 mm, the feed module (200 mm) and 2 channels each 1900 mm residual length.

Bi = Inner e-chain® width [mm]
R = Bending radius [mm]
n = Number of channel pieces
S = travel = L - 300 [mm]
F = Field length [mm]
L = Total length [mm]
X = residual length [mm]

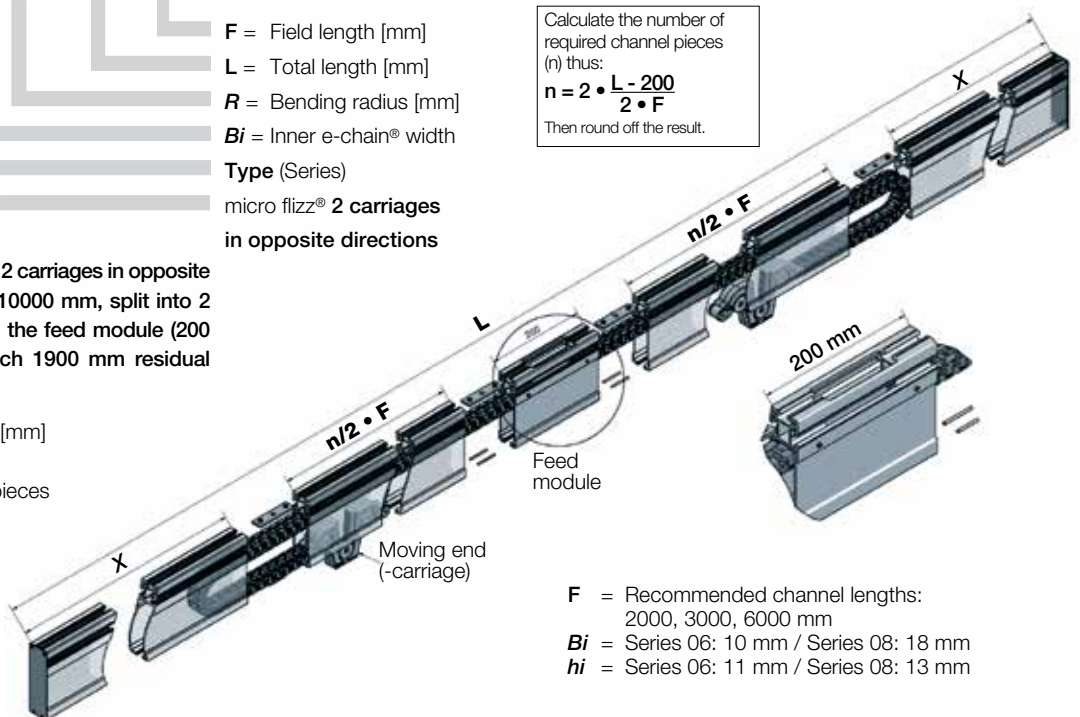

Calculate the number of required channel pieces (n) thus:
$$n = 2 \cdot \frac{L - 200}{2 \cdot F}$$

Then round off the result.



F = Recommended channel lengths:
2000, 3000, 6000 mm
Bi = Series 06: 10 mm / Series 08: 18 mm
hi = Series 06: 11 mm / Series 08: 13 mm

e-chain systems®
 micro flizz® - Small e-chains® in aluminum profile

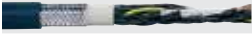

micro
flizz®

Highly flexible chainflex® special cables for dynamic applications

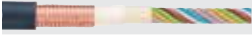
chainflex®	Temp.	v max. unsupported		v max. gliding		a max.		Number of cores	AWG Range
		ft/s	(m/s)	ft/s	(m/s)	ft/s²	(m/s²)		
 CF9	-31°F - +212°F	32.8	(10)	19.7	(6)	328	(100)	2 - 36	24-2
 CF10	-31°F - +212°F	32.8	(10)	16.4	(5)	328	(100)	2 - 25	26-12
 CF98	-31°F - +194°F	32.8	(10)	19.7	(6)	328	(100)	2 - 8	26-22
 CF99	-31°F - +194°F	32.8	(10)	19.7	(6)	328	(100)	2 - 8	26-22

chainflex® cables suitable for micro flizz® are available from stock at igus®!

MF06 - max. cable outer diameter ø 8.0 mm, MF08 - max. cable outer diameter ø 9.5 mm



micro flizz® in an outdoor application with 98.4 ft. (30 m) travel



Safe energy supply under strong dust
and dirt accumulation with igus® micro flizz®



micro flizz® as “energy supplying rail guide”
for a scale to weigh chemicals, etc.

igus®
e-chain system®

Telephone 1-800-521-2747

Internet: igus.com
 email: sales@igus.com
 QuickSpec: igus.com/quickspec



Solutions for predictive maintenance

isense smart plastics

For greater plant availability

- Make maintenance and repair of your machines more efficient and cost-effective with smart plastics
- smart plastics reduce failures
- Intelligent products predict the maintenance date in good time and can be integrated into your processes and systems
- Wherever predictive maintenance is required



Moving energy made smart - smart plastics make smart factories - igus[®] isense

As a manufacturer and supplier of plastic components such as energy chains, cables and bearings, igus[®] is also going through a digital development process and is increasingly orienting its products towards use in smart factories. The aim is to make the maintenance and repair of its plastics more efficient and cost-effective. Thanks to the newly developed igus[®] isense products, maintenance and repair are not only being focused on more in industrial production; they also benefit from digitization and its advantages.

- Reduce maintenance costs
- Eliminate unplanned downtime
- Increase service life
- Increase equipment efficiency
- Save time - faster detection of faults
- Reduce energy consumption

Typical industries and applications

- Wherever predictive maintenance is required
- Harbor installations
- Cranes
- Car plants
- Gantries

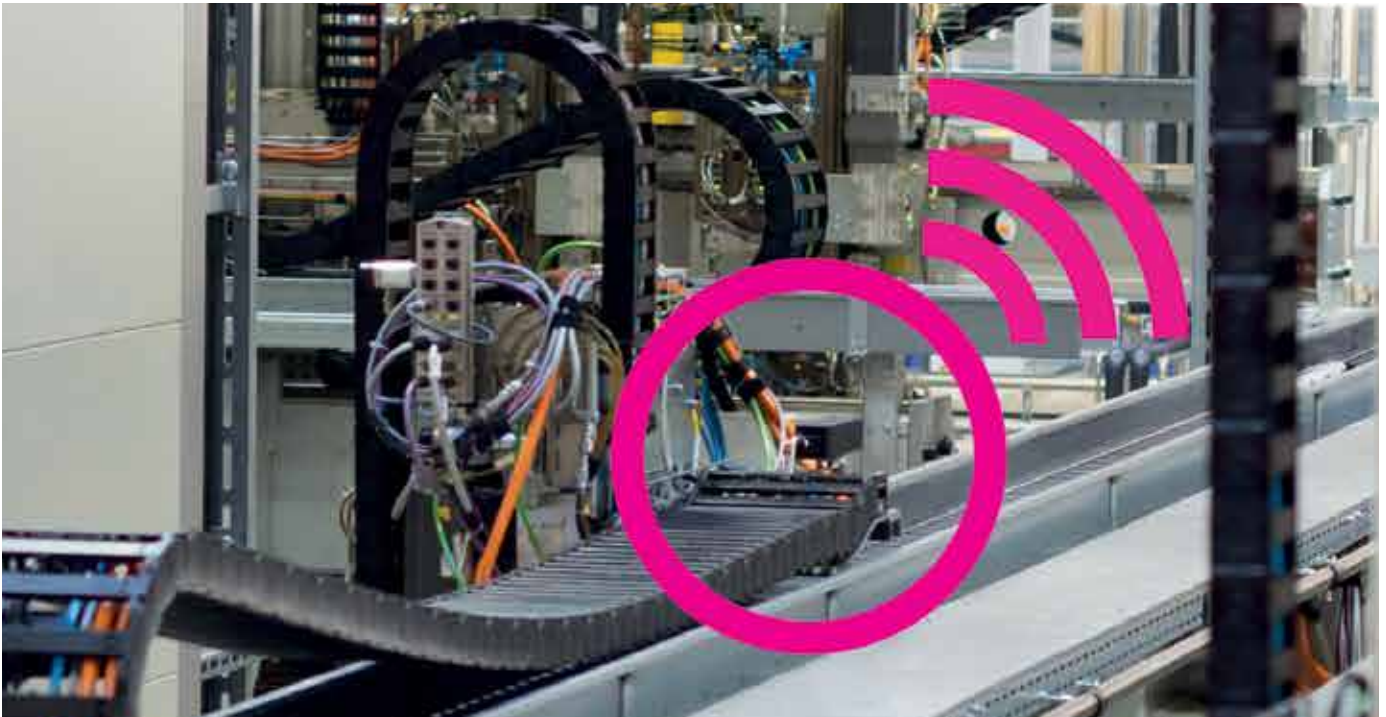

Making maintenance and repair of machines and systems more efficient and cost-effective

Many new sensors and monitoring systems have been developed for the **isense** product family, making igus® plastic solutions into intelligent products. The result is that igus® components do not simply develop a defect unexpectedly but predict the defect and indicate the need for maintenance in advance. With this new development, igus® has added predictive maintenance - intelligent production meets equally intelligent maintenance.

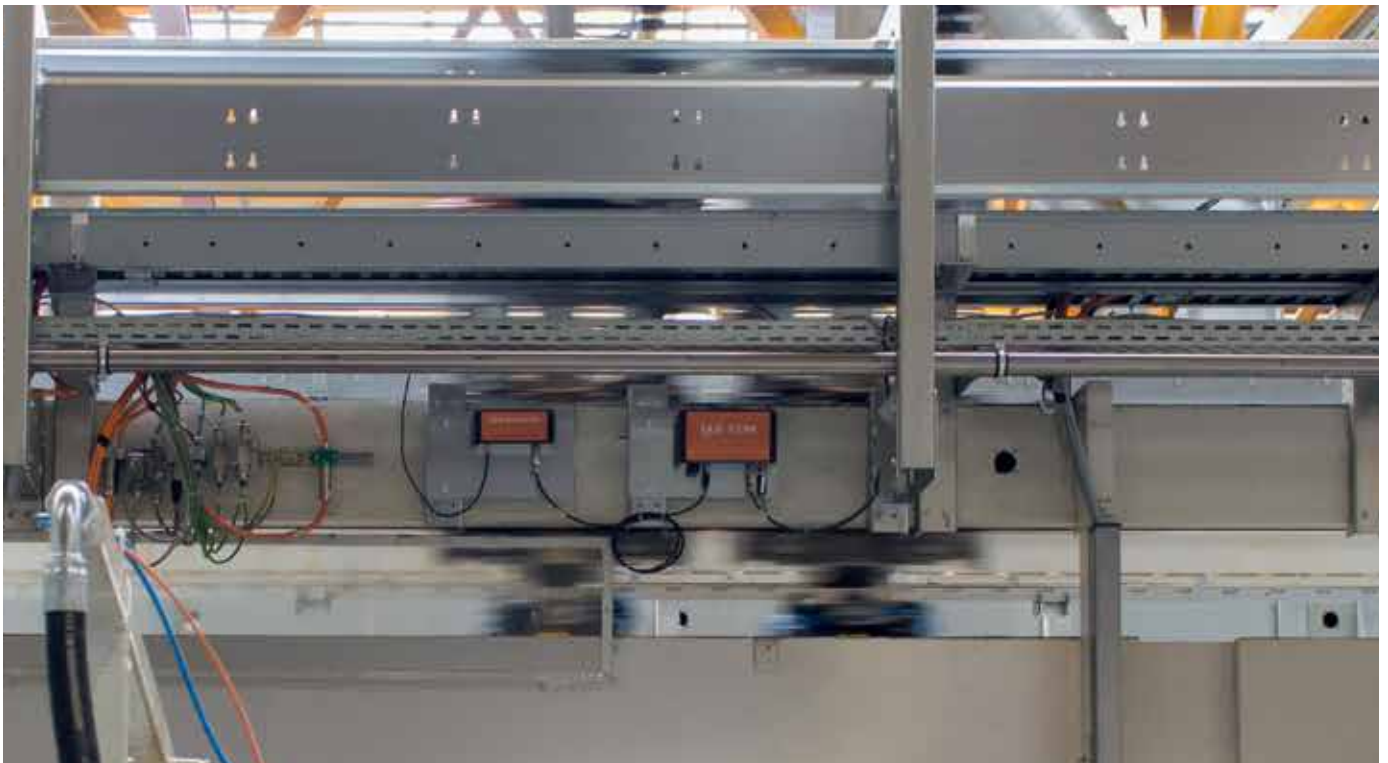

smart plastics in action - **isense** EC-B modules from igus® monitor the condition of the chain by means of a polymer wire inside the e-chain® and a sensor unit

igus® isense modules, which use sensors to collect data from energy chains, cables, linear guides or slewing ring bearings, are equipped with an interface and can be easily integrated into a control cabinet. A data logger allows values to be stored on an SD card. The data measured by the various isense modules is then sent wirelessly to the icom module, summarized and processed.

EC-M — e-chain® cycle monitoring / EC-W - e-chain® wear monitoring

Always moving - EC.M sensor / wear detection - EC.W sensor



EC-I — integrated

Non-contact wear measurement

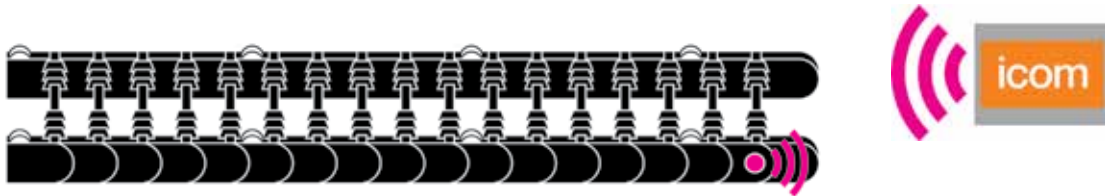

EC-P — Push/Pull force monitoring

When forces are critical: EC.P sensor measures push/pull forces

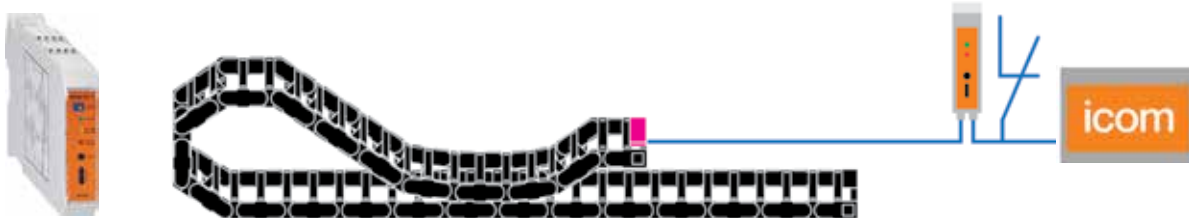

EC-B — e-chains® breakage detection

Detect e-chain® breakages automatically with the EC.B sensor



EC-RC — run control

Monitoring the operating status of the e-chains®, especially in guide troughs



The EC-M sensor is mounted on the moving end of the e-chain® in order to record the application data. It detects values such as acceleration, velocity, temperature and number of cycles, and determines the distances completed as well as the remaining service life of the system.

The EC-W sensor measures the wear on the crossbar, on the pin/bore connection or on the liners depending on the product and sends a signal when the limit is reached.

For rol e-chains®, such as series P4-1, the pin/bore connection is the most mechanically stressed component. Directly integrated in the e-chain® link, the EC-I sensor contactlessly measures the wear in the pin/bore connection for maintenance planning.

Use of the EC-P sensor saves maintenance personnel from having to inspect long travel distances - information is always available and can automatically be passed on to the isense system.

The EC-B break detection sensor reduces the amount of work of maintenance technicians responsible for looking after crane installations and gantries. The EC-B sensor can detect breakage of a chain link caused by parts or debris falling into the system. In the past, this problem played a part in the failure of a crane, as breakage of an e-chain® link automatically leads to overloading and failure of the opposite side.

Sensors measure and check the position of the e-chain®. In this way, the machine is prevented from continuing to operate if mechanical faults occur; meaning that total loss of the e-chain® or an electrical shutdown due to cable damage are avoided.

CF-Q – chainflex® cable service life

Detect hidden cable damage early

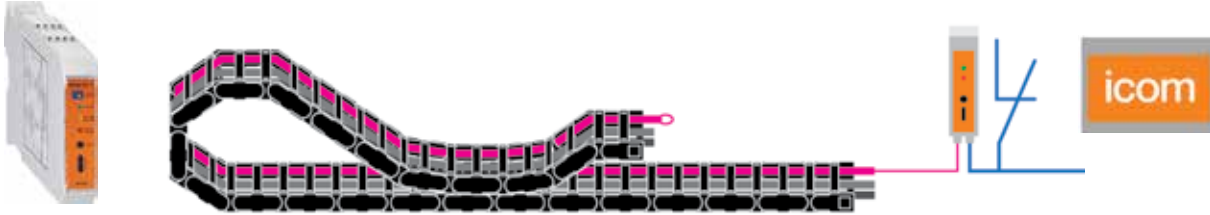

CF-P – Push/Pull force monitoring

Prolong cable life



DLT-W – drylin® T wear monitoring

Monitor wear status of drylin® linear units



PRT-W – iglide® PRT wear monitoring

Monitor wear status of iglide® slewing ring bearings



icom – data concentrator

Data collection and transmission



The CF-Q sensor indicates changes in the electrical properties; and allows detection of impending cable failure in advance. The engineer then decides what priority the replacement of a cable has and what the consequences of a defect might be.

Tensile forces acting on the cables of an e-chain system® can significantly reduce the service life. The CF-P system measures the forces directly at the strain relief and indicates the need for action.

Used to detect when the wear of a drylin® linear guide has reached a level normally associated with the end of the guide's service life. A plastic element that has an integrated sensor and can be retrofitted, signals the need for replacement in good time.

To determine the wear limit of iglide® slewing ring bearings. Mounted in a milled slot below the sliding elements of the PRT, the PRT-W sensor measures the abrasion and can indicate the required replacement promptly via the icom communication module before a failure.

These sensors become even more useful when linked to the icom module - a data concentrator - that can transfer the measured values to an isense system. How the sensor data can be further processed depends on the respective system chosen. igus® currently offers four different variants.

A choice of four different isense smart plastics concepts makes integration into existing infrastructure seamless

The icom module sends the data gathered by the sensors to a PC or integrates it via a computer into the existing software environment or IT infrastructure. In addition, connection to the igus® Data Centre is possible. By comparing live data with data collected from many existing test applications conducted at the igus® 29,600 ft² test facility using machine learning techniques and AI algorithms, maintenance recommendations can be provided.

Due to the numerous test findings that are fed into the online service life calculators, igus® is able to predict precisely how long an e-chain® will work reliably in a particular application. The isense modules provide live service life updates of the system, improving overall safety. This is because it includes the current ambient conditions of the actual application. Predictive maintenance ensures that repair or replace tasks are planned only when it is really necessary. This saves time and maintenance cost.

**isense
online**



Connected solution

Plan maintenance and service activities efficiently with isense online and only carry out the work that is really necessary. Efficient work prioritization after the alert, and supply of the appropriate replacement part from stock.

**isense
integration**



**Early ordering
of replacement parts**

Thanks to a wide range of options (Profinet, Ethernet, EtherCat, CC-Link IE Field), integration into existing IT infrastructure is possible with trained igus® specialists.

**isense
stand-alone**



**Added value for
service technicians in
specialized production**

The isense standalone system lends itself to those businesses that are only concerned about maximizing production uptime.

**isense
offline**



**Keep track of
things at all times
in large factories**

isense offline is the best solution when the service technician has to monitor a large number of e-chains®, cables and bearings.

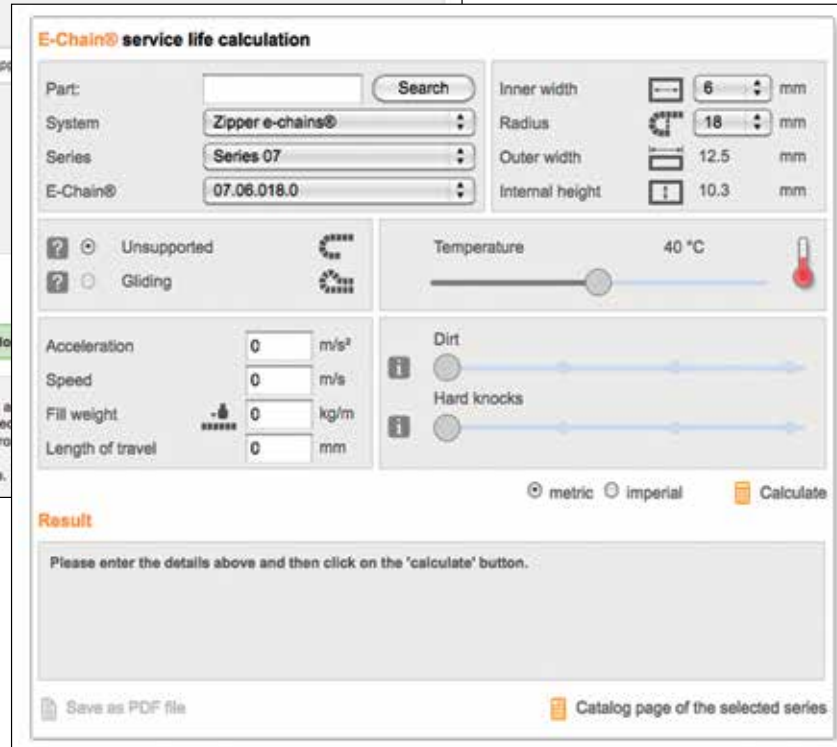
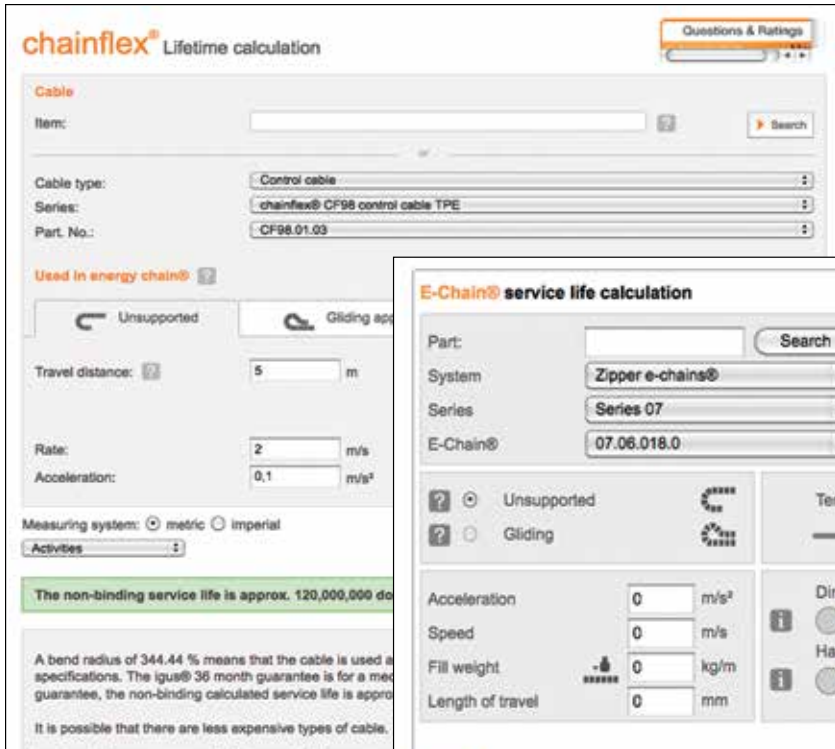

When the **isense** online system is used, the time shown until the next maintenance is based on the algorithms of the service life calculators for e-chain systems® and chainflex® cables, which have been available on the Internet for many years: The service life calculator combines the results of many thousands of tests and applications in the field into a predicted life in double strokes or kilometers. In the **isense** system, the starting values are compared with the real application and a constant comparison takes place with the online models based on AI and machine learning algorithms.

Through numerous tests, the results of which are incorporated into the online service life calculator, igus® can predict very accurately how long an e-chain® will reliably work in the respective application.

More information ► www.igus.com/lifetime



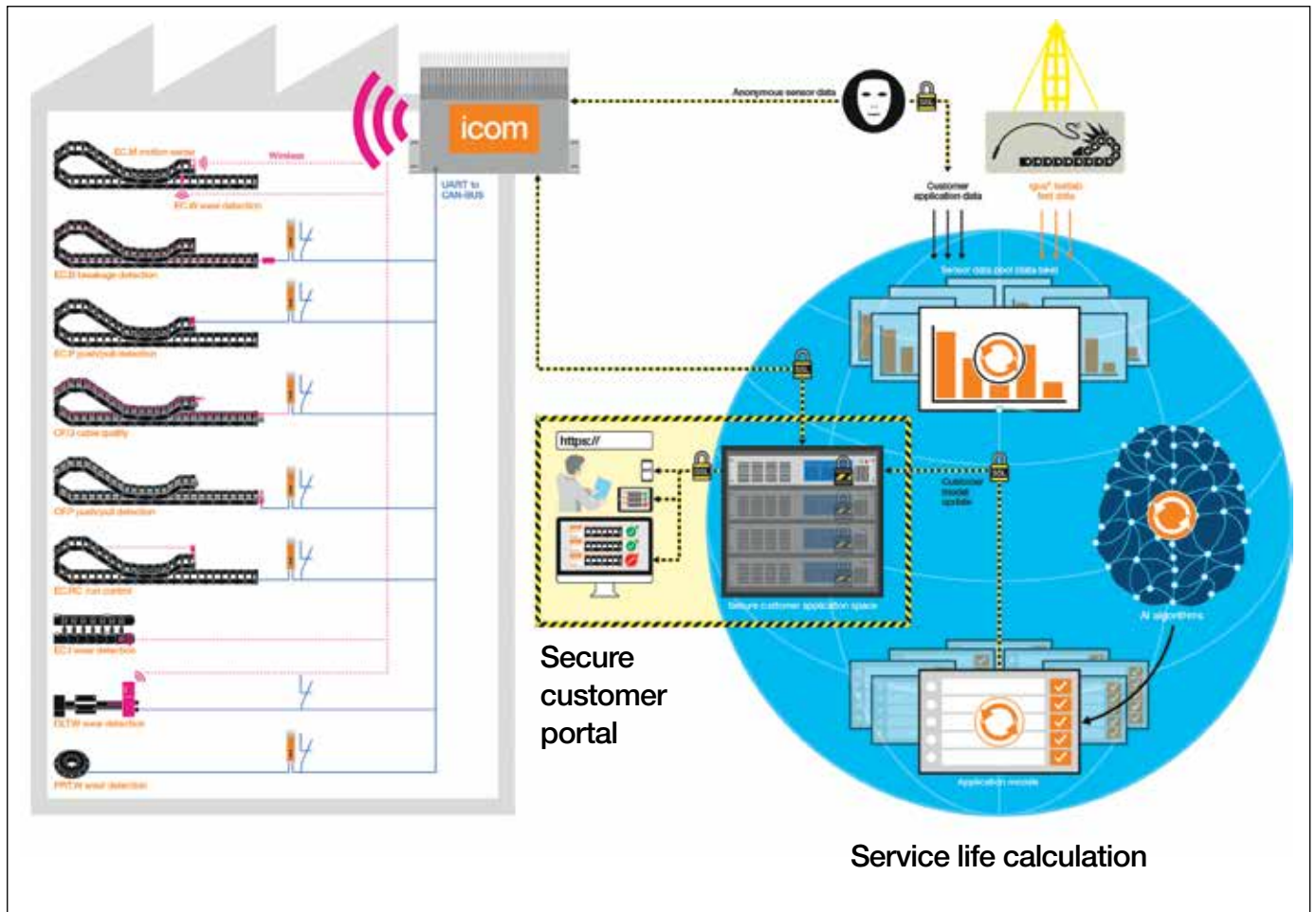

isense online benefits at a glance

- The best method to plan maintenance and minimize inspection work
- Efficient maintenance organization according to priority and, thanks to integration into the ERP, with appropriate replacement parts from stock provided after the sensor alert
- Predictive and plannable maintenance due to early information on necessary service or replacement
- Data from the igus® laboratory is processed on a server with anonymized customer data and also with open data from other customer applications in order to create a full data model
- Service life predictions from the protected customer area are regularly compared with the data model
- Benefits from all of the test data in the igus® database and keeps learning every day

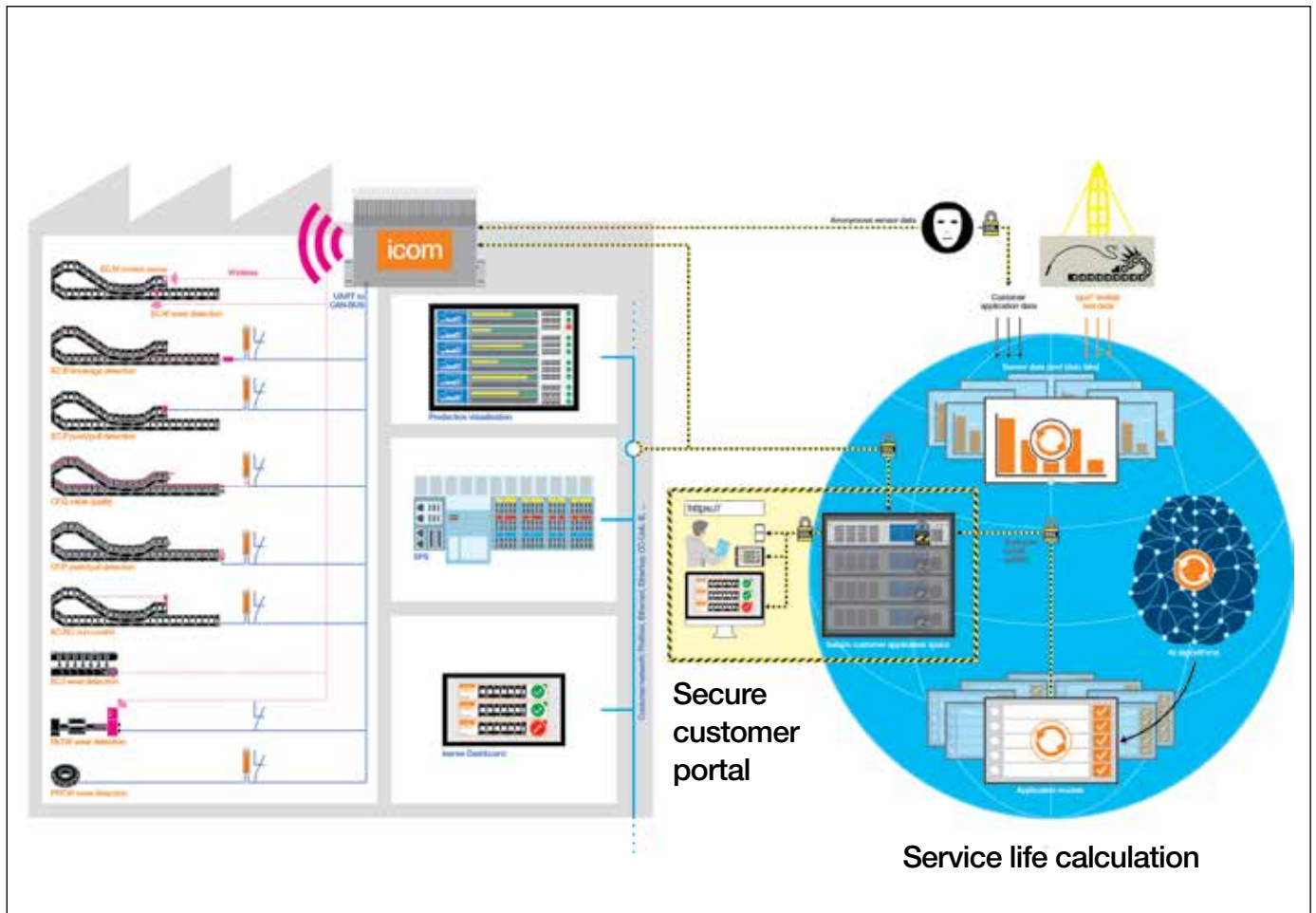

isense integration benefits at a glance

- Wide variety of protocols and standards (Profinet, Ethernet, EtherCat, CC-Link IE Field), OPC-UA, MQTT
- Integration into the existing software environment and the IT infrastructure
- Integration into the customer's production visualization software
- Operating states of different igus® components visible at a click of the mouse
- Ordering of replacement parts via a connected ERP system
- Connection to control software via customer's infrastructure (Ethernet, Profinet, CC-Link IE Field etc.)
- Machine shutdown or acoustic / visual warnings

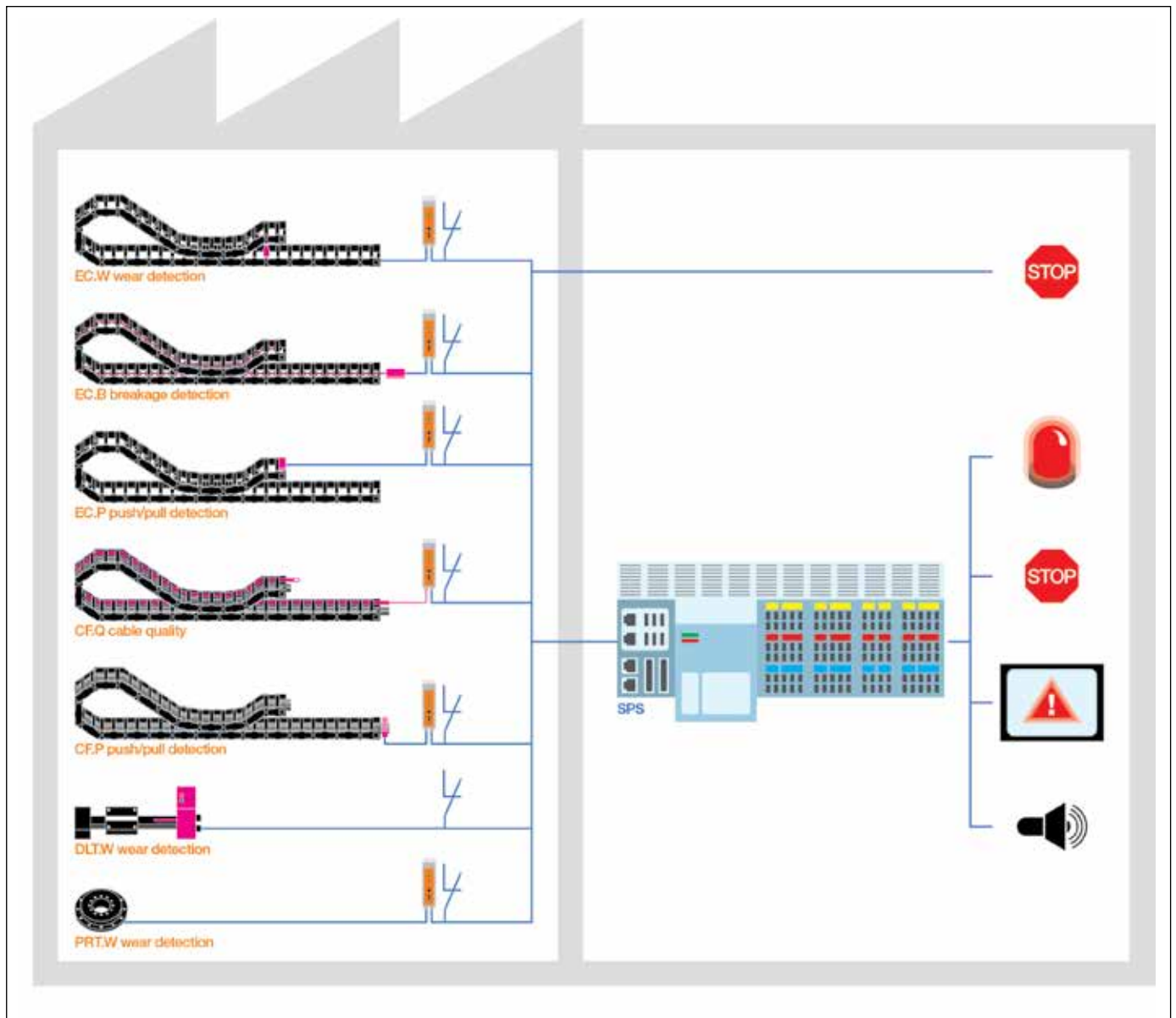

isense standalone benefits at a glance

- Easily integrated by a machine programmer
- Sensors (EC.B - break, CF.Q - cable monitoring) on e-chains® and cables gather the measured values
- The machinery can be switched off in two ways: directly by means of the normally closed (NC) contact switch or through evaluation via an I/O interface on the customer's PLC
- The data can be sent to the maintenance team via a serial interface (RS2322/UART) to allow in-house evaluation of the data

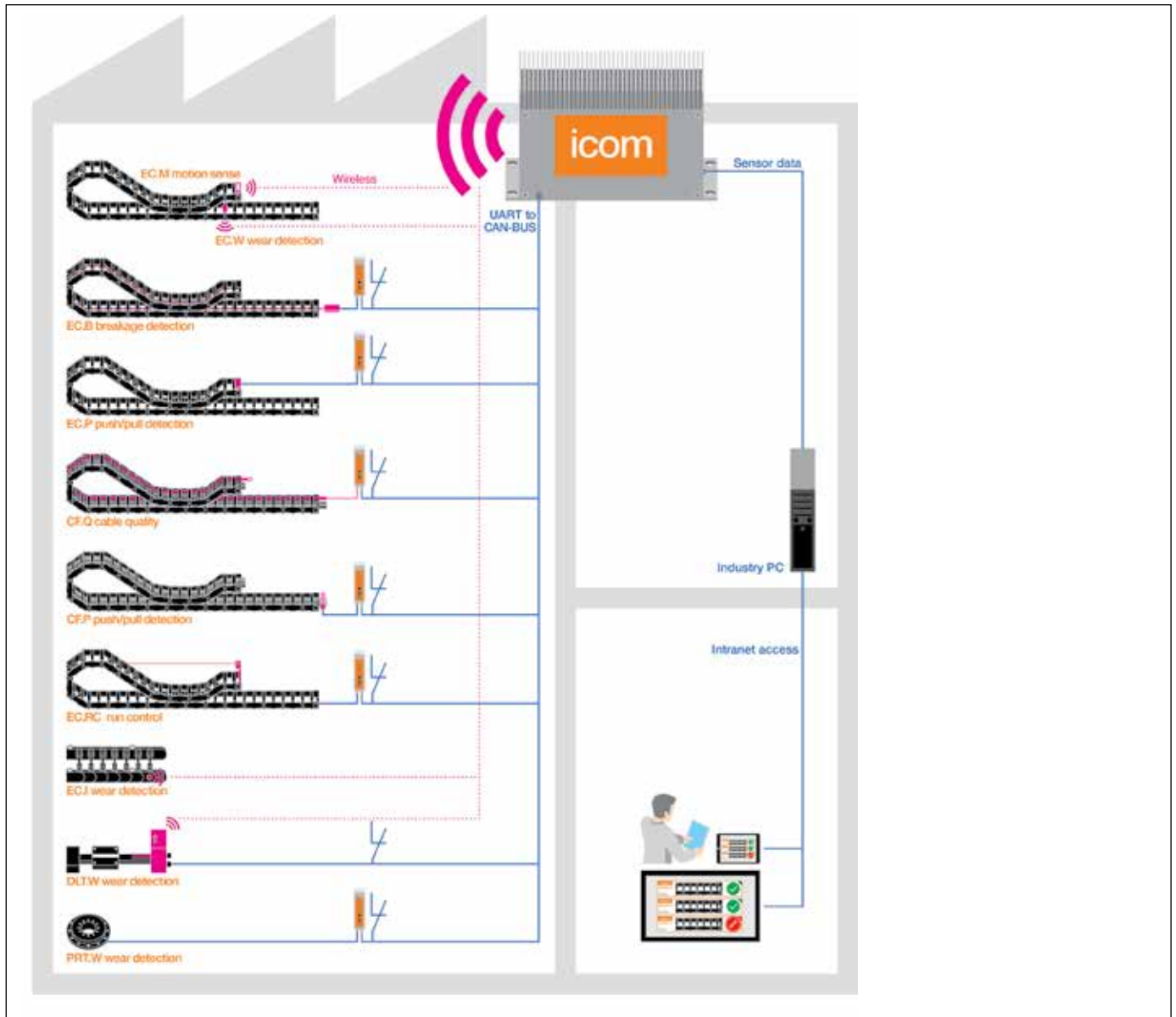

isense offline benefits at a glance

- An additional industrial PC is required to display all messages via the customer's IT infrastructure.
- No connection to the Internet therefore no comparison of the maintenance recommendations with an online database
- Manual update of service life information through comparison with the igus® database is necessary
- Good overview on the Industrial PC: all impending failures in the production environment are displayed
- Ideal for production managers and shift supervisors who are interested in facilitating smooth day-to-day work in component manufacturing or service provision and want to efficiently deploy their maintenance technicians
- Quickly and easily installed lean software solution
- All messages are displayed on an additional industrial PC

Type	Description	Recommended Maintenance	Status	Details
E4.32.137.100.0	Number of links: 54; Length: 3024mm; Chain length including mounting brackets: 3170mm; Installation type: Gliding	3613 days	■	View
Sensor (EC.M)	Movement & condition monitoring			
Sensor (EC.W)	Wear detection			
CF9.15.02	chainflex® CF9 control cable TPE; Cable diameter: 6.5mm; Number of cores and nominal conductor cross-section: 2x1,5	3341 days	■	View
Sensor (CF.Q)	chainflex® condition monitoring		Not installed	
CF9.03.04.INI	chainflex® CF9 control cable TPE; Cable diameter: 5mm; Number of cores and nominal conductor cross-section: 4x0,34	4499 days	■	
Sensor (CF.Q)	chainflex® condition monitoring		Not installed	
CF9.03.04.INI	chainflex® CF9 control cable TPE; Cable diameter: 5mm; Number of cores and nominal conductor cross-section: 4x0,34	4499 days	■	
Sensor (CF.Q)	chainflex® condition monitoring		Not installed	

Online condition monitoring from anywhere in the world - daily maintenance recommendations

In addition to the maintenance recommendation alerts, all measured sensor values can be displayed with history on a detailed page. In this way, exceptional operating conditions or creeping mechanical changes can be detected early on and corresponding measures initiated in good time.

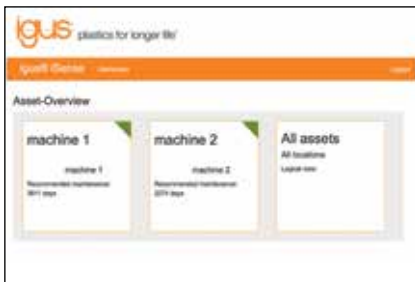

Control dashboard



History

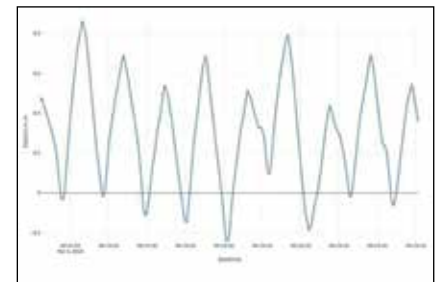

Each sensor can be called up individually

icom online

	icom data concentrator central unit	IS.ICOM.03.14.0.BETA
	EC-M sensor dynamics & temperature measurement	IS.EC.M.02.15.BETA
	EC-W sensor crossbar type 385, wireless, battery-operated	IS.EC.W.03.385.BETA
	EC-W sensor crossbar type 450, wireless, battery-operated	IS.EC.W.03.450.BETA
	3G modem DIN rail with external antenna	IS.ZB.M.01.15.0

EC-P

	EC-P module push/pull force detection	IS.EC.P.03.01.0
	PPDS diagnostic tool SMD	IS.EC.P.02.15.0
	Load cell for FTA installation 1t	IS.EC.P.Z3.020
	Load cell for FTA installation 2t	IS.EC.P.Z3.021
	Load cell for KMA installation	IS.EC.P.Z3.XX.XX

EC-B

	EC-B module ECS breakage detection	IS.EC.B.03.01.0
	EC-B sensor type .A	IS.EC.B.SU.02.A
	EC-B sensor type .B	IS.EC.B.SU.02.B
	EC-B polymer sensor cable 1.75mm assembled	IS.EC.B.00.Z2.001.1
	EC-B polymer sensor cable 1.75mm roll, to 45m	IS.EC.B.00.Z2.001.0
	EC-B special separator E4.32	IS.EC.B.S.E4.32
	EC-B special separator E4.42	IS.EC.B.S.E4.42
	EC-B special separator E4.56	IS.EC.B.S.E4.56
	EC-B special separator 4040HD	IS.EC.B.S.4040HD
	EC-B special separator E4.32 assembled	IS.EC.B.S.E4.32.1
	EC-B special separator E4.42 assembled	IS.EC.B.S.E4.42.1
	EC-B special separator E4.56 assembled	IS.EC.B.S.E4.56.1
	EC-B special separator 4040HD assembled	IS.EC.B.S.4040HD.1

CF-Q

	CF-Q module for core breakage monitoring BETA version	IS.CF.Q.03.01.0.BETA
	CF-Q temperature sensor	IS.CF.Q.00.008.0



Solutions for predictive maintenance

PPDS

Push/Pull force monitoring

- Easy installation, non-interchangeable connectors
- Easy programming using the keypad directly at the device
- Compact housing, corrosion-resistant and with EMC protection
- The force limit is programmed in tensile and compression directions
- The plant shuts down when the force is exceeded
- Custom programmable
- Event logging in the data memory
- igus® smart plastics - intelligent products forecast maintenance date in good time

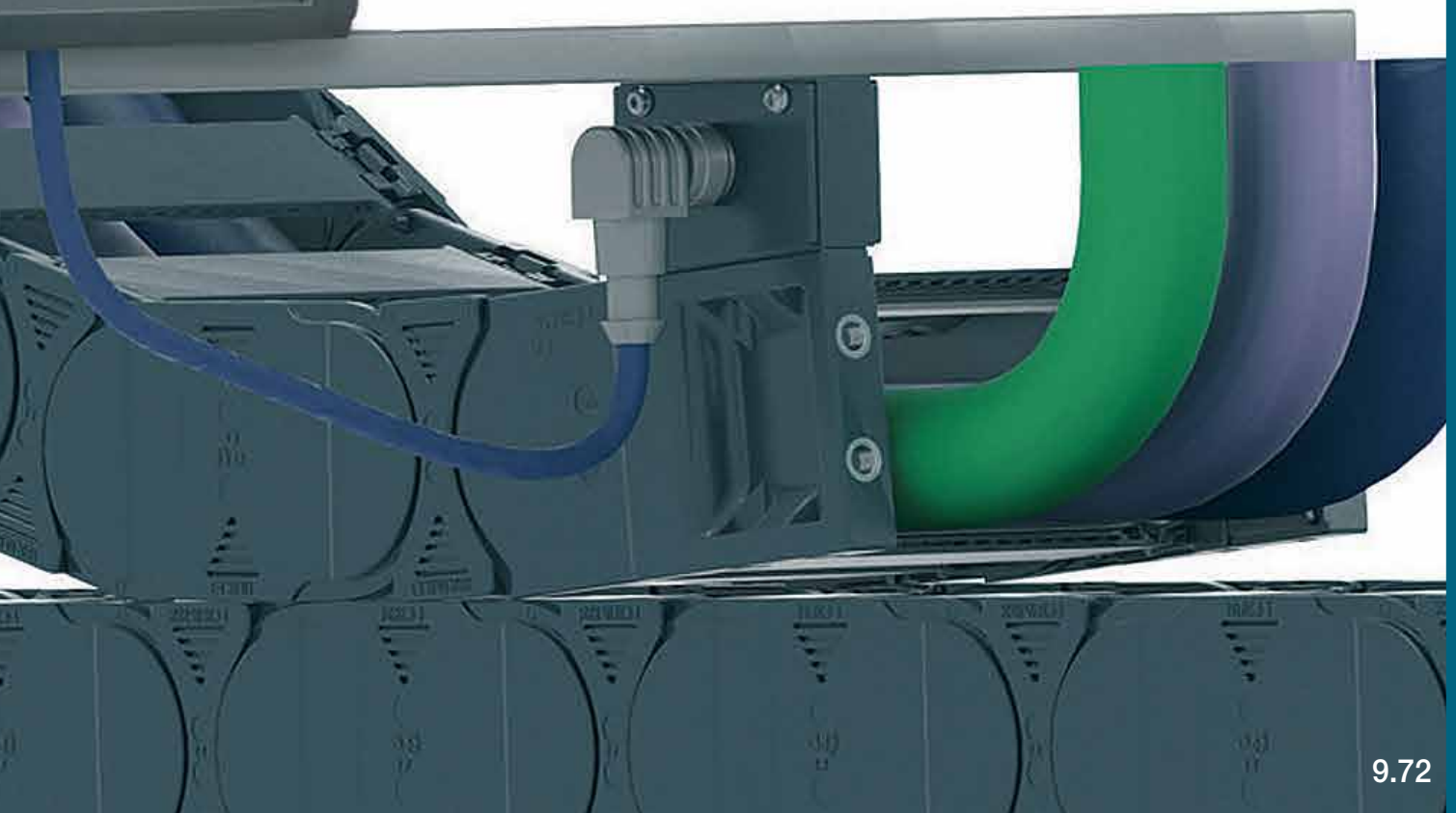



Condition monitoring: Push Pull Force Detection System - PPDS

The PPDS System is an electronic diagnostics tool that performs online monitoring of the displacement forces on the e-chains® in order to avoid system damage and stoppages. Excessive dirt, ice, and snow and foreign objects that fall into the e-chain® can block the system, causing the e-chain® to ascend and break. The PPDS system measures the displacement forces on the e-chain® several times per second, and compares the information with the calculated specification. If a variance occurs the plant can be automatically stopped with the help of the PPDS system.

- 3 PPDS systems are available
- Easy installation by means of non-interchangeable connectors
- Easy programming using the membrane keypad directly at the device
- Compact housing, stable, corrosion resistant, sealed in accordance with IP 65
- The force limit is programmed in tensile and compression direction
- The plant stops when the force is exceeded
- Custom programmable and event logging in the data memory

Typical industries and applications

- Malfunction-sensitive plants, such as conveyor systems in power plants
- Waste incineration systems
- Chemical plants
- Crane building
- Generally with long travel distances that have high fail-safe requirements
- For long travel applications, if tensile and compressive force monitoring is needed

**PPDS basic -
 as safety standard**

So far the realization of Condition Monitoring Systems was limited to large-scale projects, e.g. ship-to-shore cranes. PPDS basic now makes this technology available for all standard industrial appliances. The simple force measuring function conducted at the mounting bracket of the e-chain® new also provides an emergency stop function for e-chains® in gliding applications under 328 ft. (100 m) stroke at a reasonable price

- Low-cost system protection
- Emergency Shutdown or alarming in case of system overload
- Space - saving design
- New floating moving end available for PPDS basic.

**PPDS advanced -
 for long gliding applications**

The system for very long gliding applications with an igus® floating moving arm (used to compensate lateral movements). The force sensor is integrated in the floating moving arm and works in connection with the PPDS evaluation unit. We recommend to realize the engineering of such a plant by our technicians, please consult igus®.

**PPDS pro -
 for extreme operational reliability requirements**

The system for long travels when extreme operational reliability is essential. The PPDS pro analysis unit can analyze force thresholds by position. Here as well, a load cell is installed in the floating moving end. We recommend to realize the engineering of such a plant by our technicians, please consult igus®.



Electronic pull-push force monitor with the igus® PPDS system



PPDS system test facility in the igus® lab

Floating moving end as separate component

- Compensates parallel errors - compensates lateral offset tolerances between moving end and e-chain system® horizontal ± 82 ft. (25 m)
- Easy assembly, small, light, and affordable
- Compatible with PPDS basic
- Max. acceleration: 2 m/s² (speed depends on e-chain® type)



Delivery program

Part No. floating moving end as separate component	For e-chain® Series
FTA-B-01-2500-XX	2500, System E2/000
FTA-B-01-2700-XX	2700, System E2/000
FTA-B-01-3400-XX	2500, System E2/000
FTA-B-01-E4-28-XX	E4.28, System E4-1
FTA-B-01-E4-32-XX	E4.32, System E4-1
FTA-B-01-E4-42-XX	E4.42, System E4-1

More series available upon request, please consult igus® for delivery time. Supplement Part No. with the required e-chain® width-index.

Example: FTA-B-01-2500-05

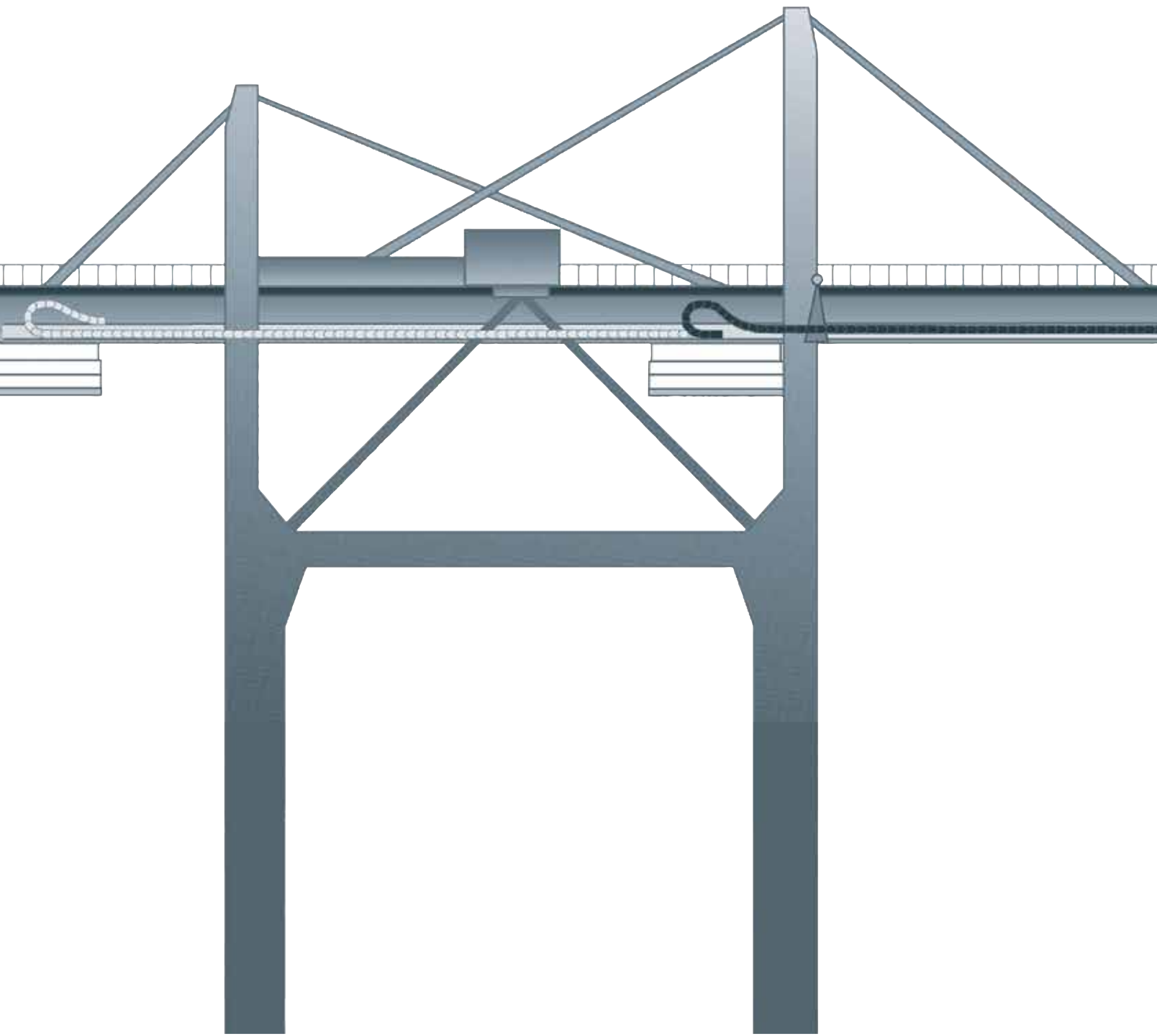

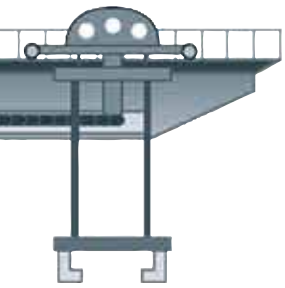

Modular projects

Special solutions from stock

- Faster quotations, faster project planning
- Detailed service manuals and documentation
- Time and cost savings
- Absolute functional reliability
- System guarantee available upon request and depending on the application
- PPDS moving end - electronic Push/Pull Detection System
- Fixed end modules for easy attachment of the e-chain® inside the guide trough, with no drilling required
- Extreme gliding - gliding elements for even longer service life of e-chains® where long travels are involved
- HD trough systems with different installation set designs, matching the respective application and duty levels

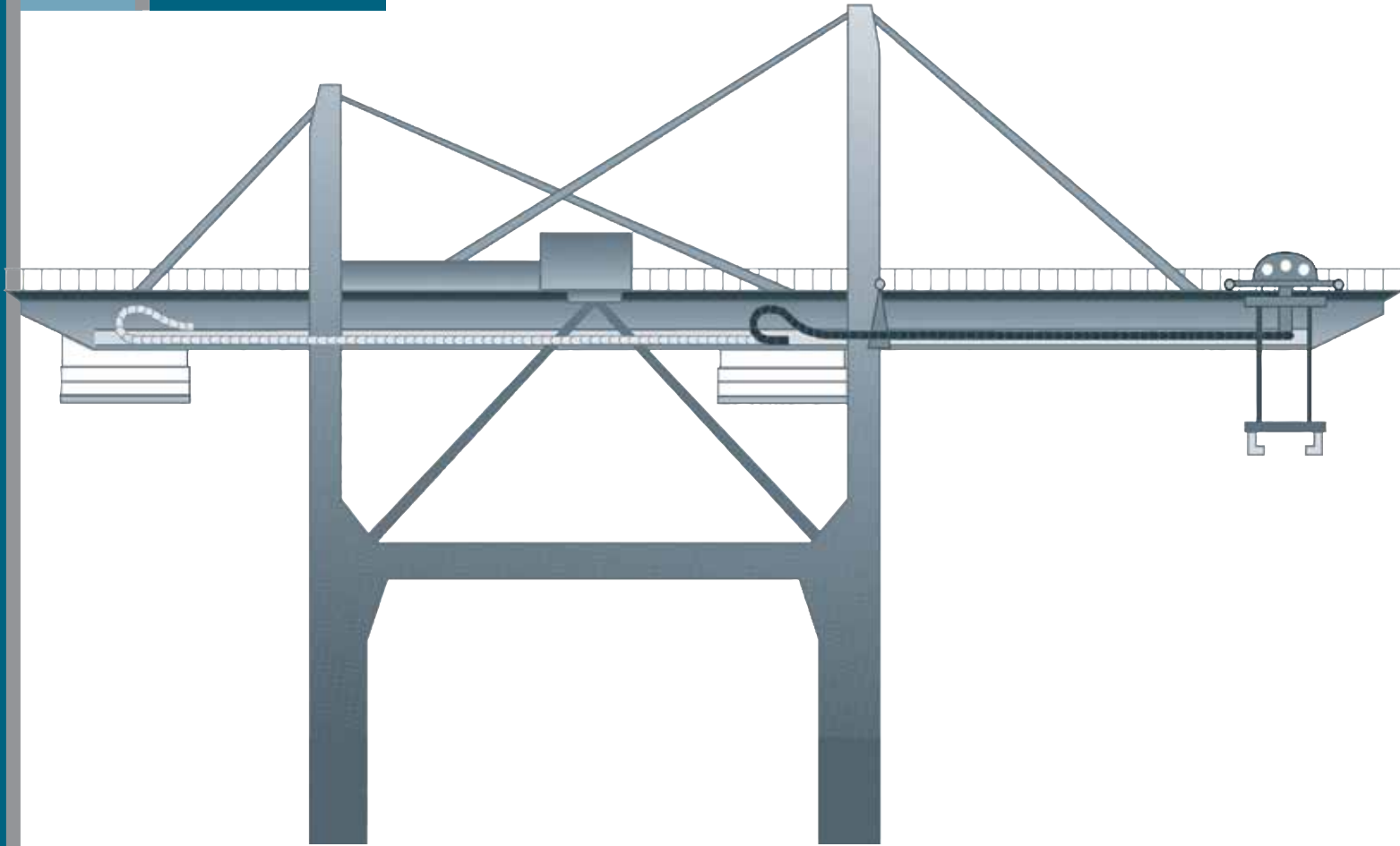

For extremely heavy-duty applications and special solutions from stock

The igus® modular system for projects ...tested and time-proven in numerous projects, have now become available as a modular standard system.

- Faster quotations, faster project planning
- Detailed service manuals and documentation
- Time and cost savings
- Safe function
- System warranty available upon request, for individual applications
- PPDS tow arm with electronic push/pull force monitoring
- Fixed end-modules for easy attachment of the e-chain® inside the guide trough, with no drilling required
- Extreme gliders gliding elements for even longer cycle life of e-chains® on long travels
- HD trough systems with different assembly kit designs, matching the respective application and stress levels

Typical industries and applications

- Cranes
- Offshore
- Cranes, offshore



Long travels with electronics Push/Pull-force monitoring with the igus® PPDS System



igus® supervisors plan projects worldwide

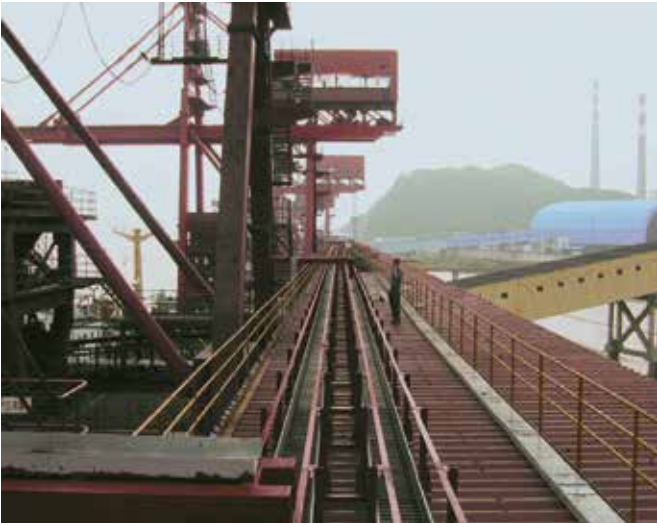

Series 4040R on a coal unloading system - travel 623.4 ft. (190 m), speed 1.64 ft/ s (0.5 m/s), fill weight 5.41 lbs/ft (8.05 kg/m)



Series 4040HD on (180 m) travel lengths with housing. -40°F/+104°F (-40°C to +40°C) temperature range and high dirt pollution



Crane system designed by igus®

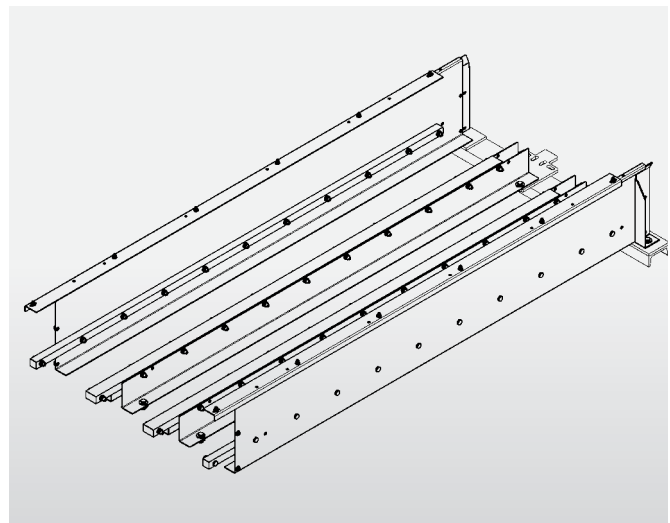

igus® project planning example, here: guide trough modules

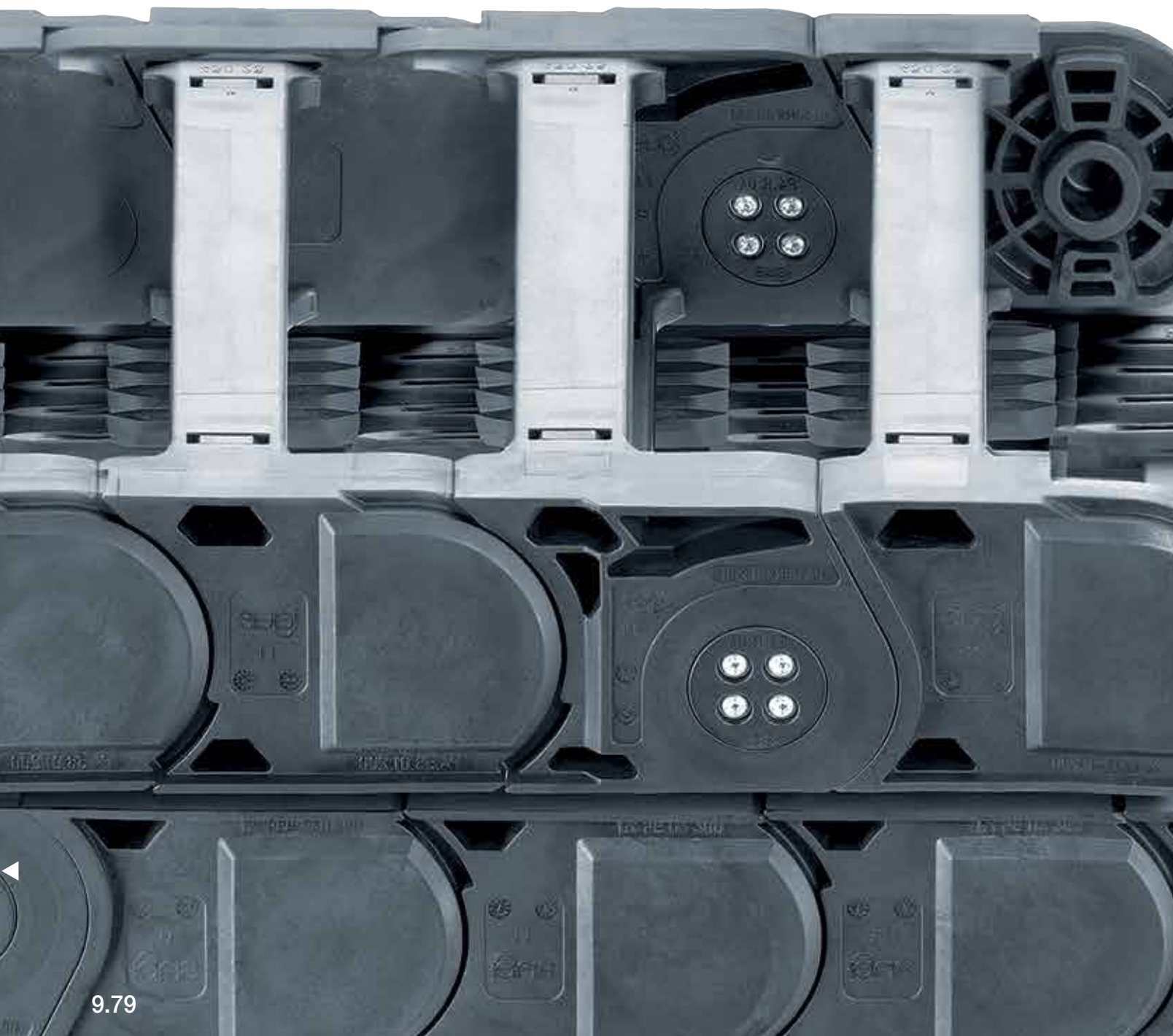

e-chains[®] for long travels

E4/4HD - System P4 -
rol e-chains[®] - autoglide



Advantages of igus[®] e-chains[®] for long travels

- Travel lengths of 2,625 ft. (800m) and more are possible
- Very space-saving and energy-efficient
- For speeds up to 32.8 ft/s (10m/s)
- For fill weights up to 20.16 lbs/ft. (30kg/m)
- Weather and dirt-resistant
- Suitable chainflex[®] cables
- Optional Condition Monitoring Systems

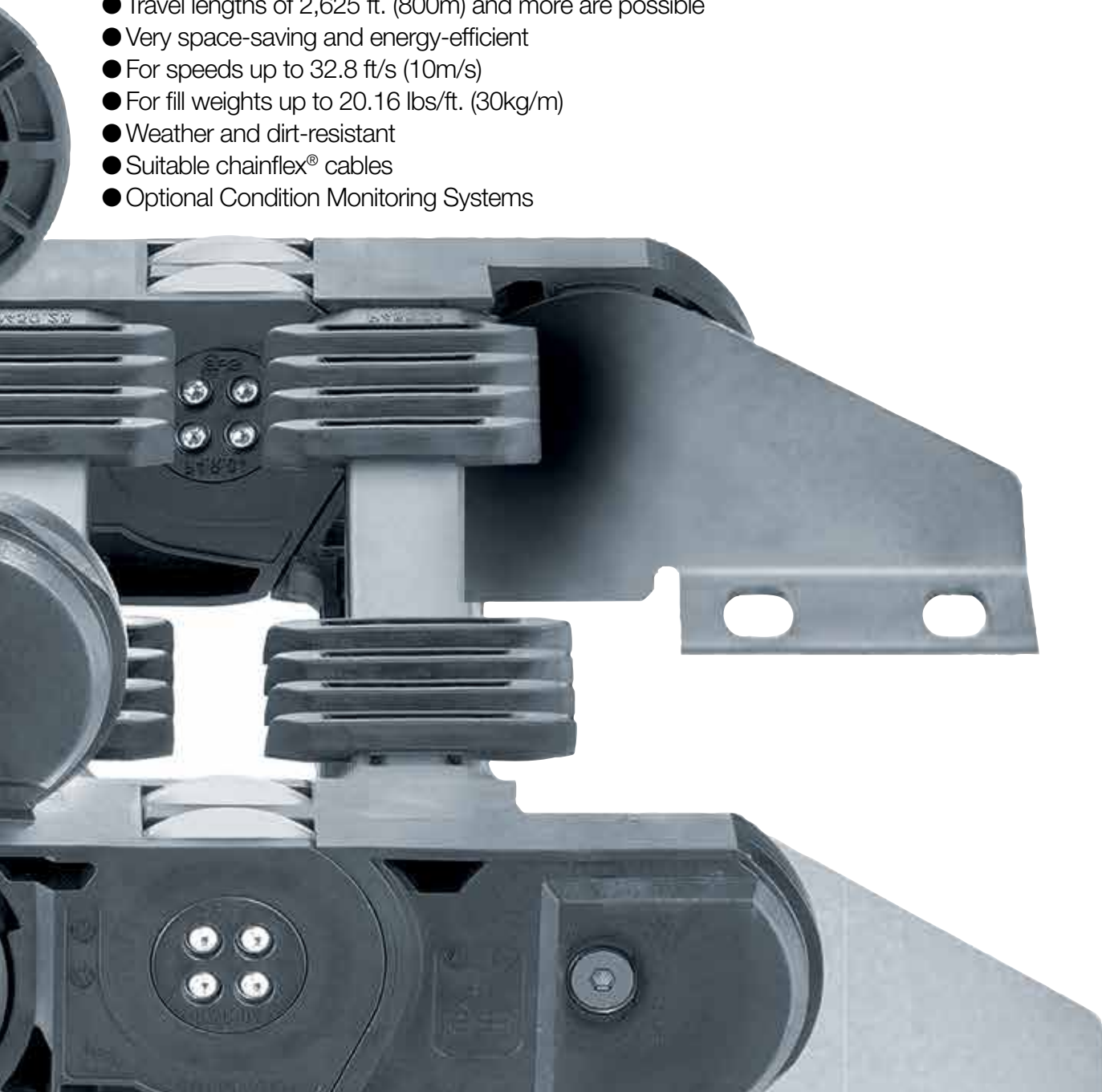

e-chain system® E4/4HD - P4 - rol e-chains® e-chains® for long travels



Very high fill weights for long travels - E4/4HD "Heavy-Duty"

- For very heavy fill weights and long travels
- Strong, even when used in very dirty or humid environments
- High torsional rigidity
- Long service life
- Recommended for heavy-duty applications



Reduce energy consumption by 57% - P4 profile-rol e-chain®

- Safe, low-noise, abrasion-resistant energy supply system for long travels
- Long travels up to 2,625 ft. (800m) and more, high fill weights up to 20.16 lbs/ft.(30kg/m)
- For very long travels and high travel speeds up to 32.8 ft/s (10m/s)
- autoglide crossbars for safe guidance



Rolling instead of gliding, long travels up to 800m - E4/4 rol e-chain®

- 75% reduction of drive power needed to move the e-chain®
- Long travels up to 2,625 ft. (800m) with E4/4 rol e-chain®
- Speeds up to 19.69 ft. (6m/s) possible
- Can be used in dirty environments

e-chain system® autoglide self-guiding e-chain systems®, without the need for guide troughs

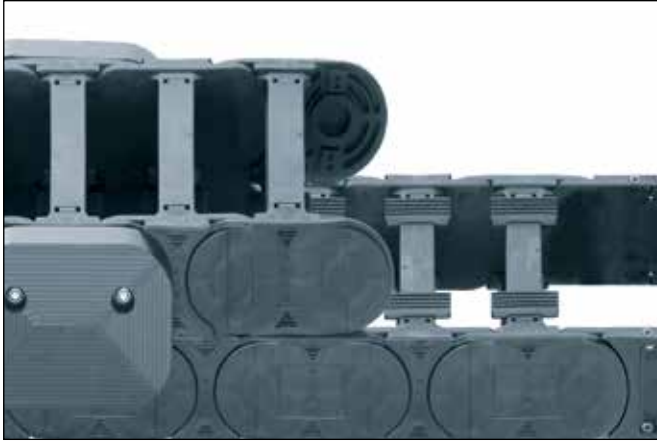

Self-guiding e-chains® for system E4.1 - autoglide version 01

- For the larger E4-1 e-chains®
- Simple guide elements for quick installation
- The autoglide crossbars safely guide the e-chain® replacing the need for a guide trough
- For travels over (32.8 ft. (10m))
- Floor guides can be driven over



Self-guiding e-chains® for system E2/000 - autoglide version 02

- Travel distance up to 229.7 ft. (70m) and speed up to 6.56 ft/s (2.0m/s)
- Very compact, removes troughs forming an obstacle in the working area
- Quick installation for long travels
- Openable along the inner radius
- Clip-on glide wings, secure movement of the e-chain®

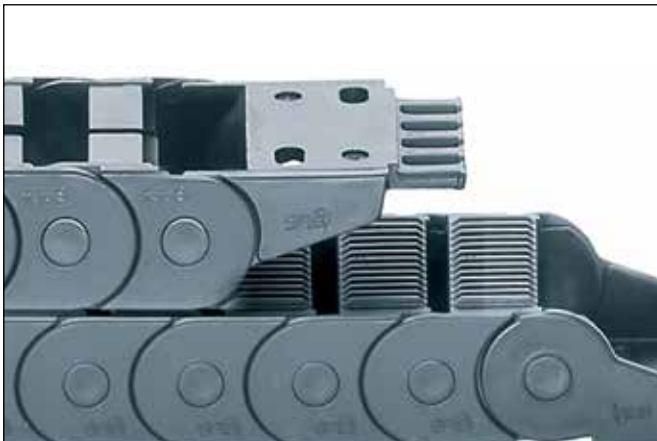

E-Z chain® openable along the outer radius, fitted with molded autoglide grooves along the inner radius - autoglide Version 03

- Doubly cost-effective due to elimination of guide troughs and economical, one-piece e-chain®
- Very quick assembly time - "easy" design
- Small width, quiet operation
- UL94-V2 classification



Special glide shoes provide a safe guiding for the E2/000 - autoglide version 04

- Reliable and precise guidance due to special plastic glide shoes
- Long travels with easier filling
- Provides precise lateral guidance and a smooth gliding of the e-chain®
- e-chains® openable along the outer radius

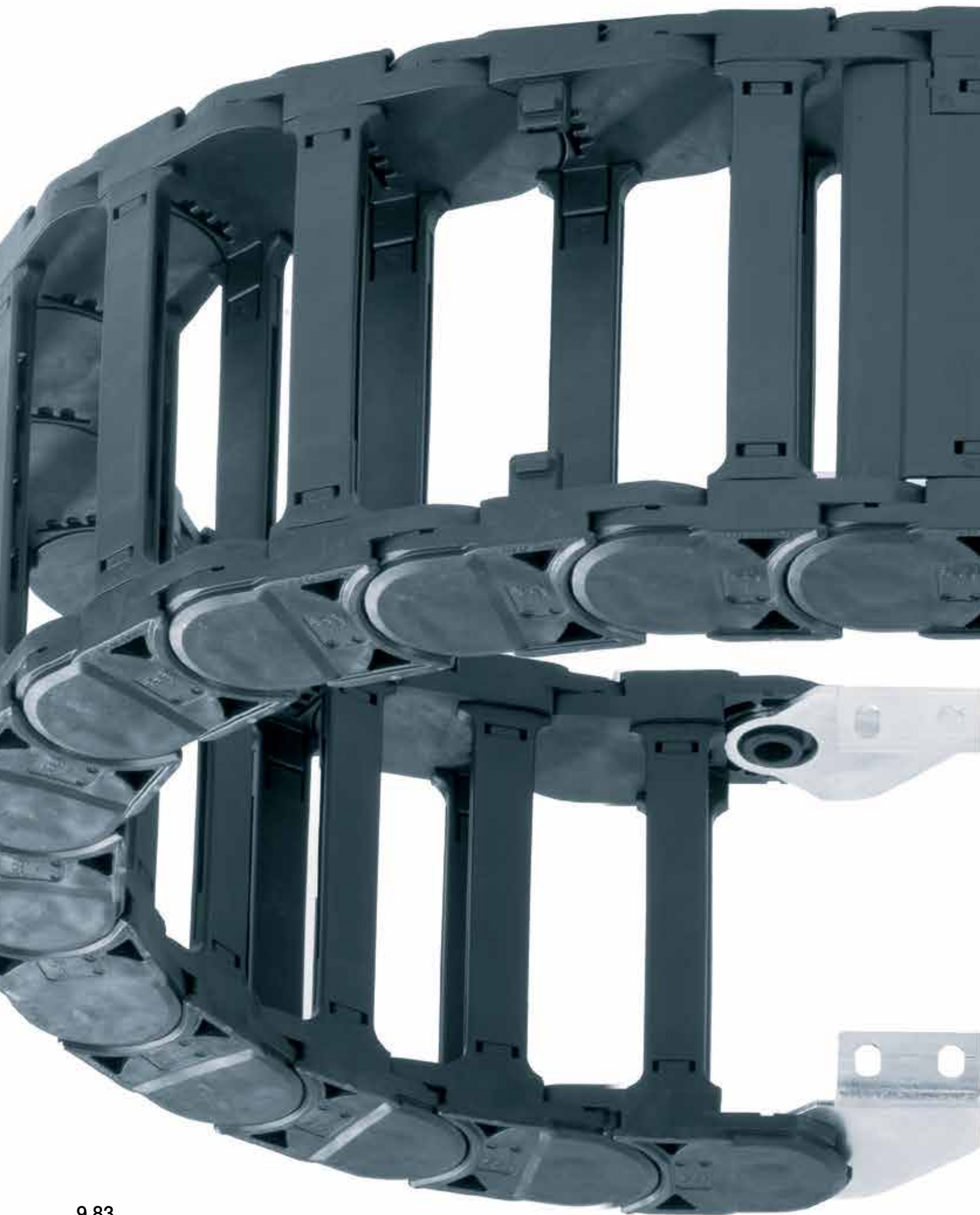



E4/4HD

Very high fill weights for long travels



E4/4HD advantages:

- For heavy-duty applications
- For very heavy fill weights and long travels
- The E4/4HD offers the required strength for long travels, dirty environments or with high humidity
- The undercut design provides extremely high torsional rigidity
- Extended service life is facilitated by particularly large glide surfaces
- Recommended for heavy-duty applications



When to use another e-chain® series:

- When you want a profile-rol e-chain® with which you can reduce energy consumption by up to 57%
 - ▶ **P4 system**
- When you want a strong E4/4 rol e-chain® requiring 75% less drive power
 - ▶ **E4/4 rol e-chain®**
- When you want a self-guiding e-chain system® without any guide troughs
 - ▶ **autoglide**

E4/4 HD - for extremely high additional fill weights on long travels

The E4/4HD system was designed for the most demanding tasks. It provides the required stability in long travels with high additional weights, heavy pollution or high humidity. The extremely sturdy side plates allow high loads, the stable tongue and groove ensures extremely high torsional stiffness. A longer service life is due to the particularly large glide surfaces.

- For extremely high additional fill weights and long travels
- Ideal for heavy duty applications

Typical industries and applications

- Cranes: RTG, Quay cranes, many more
- Compost plants
- Heavy machinery
- Steel plants
- Shipyards
- Farm machinery
- General machinery



ESD classification: Electrically conductive ESD/
ATEX version upon request



High torsional rigidity



System E4/4 approved with long travel



E-Tubes available as a special design with HT material
for hot chips





The maintenance-free Series 4040HD protects the igus® chainflex® motor and signal cables during the lifting and lowering movements of the tidal turbine and also protects them against aggressive ambient conditions. The travel distance amounts to approximately 65.6 ft. (20 m) in vertical direction above and under water.

Crossbars every link for particularly demanding applications



Series	Inner height <i>hi</i> in. (mm)	Inner width <i>Bi</i> in. (mm)	Outer width <i>Ba</i> in. (mm)	Outer height <i>ha</i> in. (mm)	Bending radius <i>R</i> in. (mm)
4040HD	2.20 (56)	1.97-23.62 (50-600)	4.09-25.75 (104-654)	3.31 (84)	5.31-15.75 (135-400)
5050HD	3.15 (80)	1.97-23.62 (50-600)	4.33-25.98 (110-660)	4.25 (108)	5.91-19.69 (150-500)

E-Tubes fully enclosed, excellent cable protection against hot chips



Series	Inner height <i>hi</i> in. (mm)	Inner width <i>Bi</i> in. (mm)	Outer width <i>Ba</i> in. (mm)	Outer height <i>ha</i> in. (mm)	Bending radius <i>R</i> in. (mm)
R8840HD	2.20 (56)	2.95-18.19 (75-462)	5.08-20.31 (129-516)	3.31 (84)	5.91-15.75 (150-400)
R9850HD	3.15 (80)	2.95-18.19 (75-462)	5.31-20.55 (135-522)	4.25 (108)	5.91-19.69 (150-500)

4040HD
R8840HD



e-chain system® E4/4 Series 4040HD/R8840HD

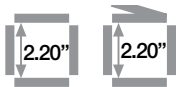

Price Index



Series 4040HD Series R8840HD

Special Features / Options

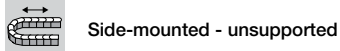

Side-mounted - unsupported



ESD classification:
Electrically conductive ESD/
ATEX version upon request



High torsional rigidity

Assembly Tips



Opening e-chains®: Remove crossbars and clips - Insert screwdriver into the slot, push down, release by lever action



Remove lids/bottoms (E-Tubes) - Insert screwdriver into the slot, release by lever action

Other Installation Methods

- Vertical, hanging ≤ 328 ft (100 m)
- Vertical, standing ≤ 19.69 ft (6 m)
- Side-mounted, un supp. ≤ 9.84 ft (3 m)
- Rotary requires further calculation

Usage Guidelines



- When high torsional forces are expected
- For side-mounted applications
- For long-term operation in very moist environments



- If a quieter version is required
➤ Series E4-56
- If a simple and low-cost solution is required
➤ Series 14040/R18840

Features & Benefits

- Robust steel-mounting brackets
- Wide, rounded plastic crossbars - cable friendly
- High tensile stability (20% higher tensile force than Series 4040)
- Very wide glide surface, less wear
- Closed and open styles can be combine
- High torsional rigidity
- Hinged snap-open removable lids along outer radius of Energy Tub
- High side-mount stability due to undercut
- Crossbars on e-chains® are removable along both radii
- Numerous interior separation possibilities



Rol-e-chain® Series 4040RHD/8840RHD available upon request

Order Example: Complete e-chain®

Please indicate chain length or number of links. Example:

16.4 ft (5 m) 4040HD-30-300-0

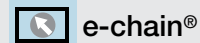

With 2 separators 56-1 assembled every 2nd link

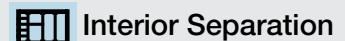

1 Set 4040HD-12-E

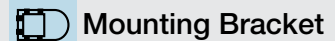

e-chain system® E4/4 Series 4040HD/R8840HD Installation Dimensions



4040HD
R8840HD

For long travels with lowered mounting height

Long travel lengths from 32.8 ft. (10m) to max. 1,148 ft. (350m)

Chain length: $= \frac{S}{2} + K_2$

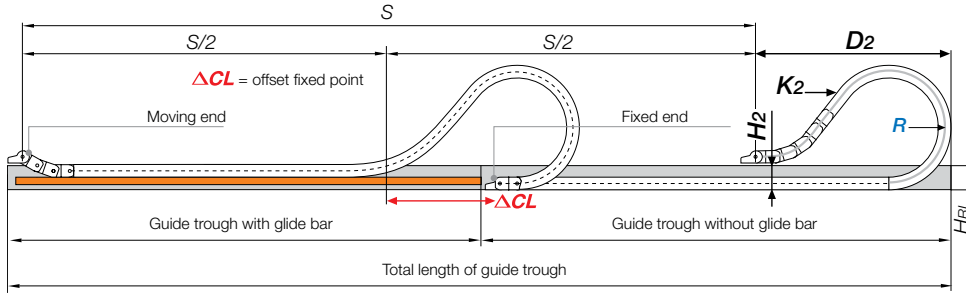

In case of travels between 13 ft. (4m) and 32.8 ft. (10m) we recommend a longer unsupported length.

R	5.31 (135)	5.91 (150)	7.87 (200)	9.84 (250)	11.81 (300)	13.78 (350)	15.75 (400)
H₂	10.47 (266)	10.47 (266)	10.47 (266)	10.47 (266)	10.47 (266)	10.47 (266)	10.47 (266)
D₂	15.35 (390)	17.72 (450)	27.95 (710)	36.22 (920)	46.46 (1180)	56.69 (1440)	60.24 (1530)
K₂	28.66 (728)	32.24 (819)	50.16 (1274)	64.49 (1638)	78.82 (2002)	93.15 (2366)	100.31(2548)
ΔCL	4.88 (124)	6.26 (159)	14.13 (359)	20.04 (509)	27.91 (709)	35.79 (909)	37.76 (959)

Legend

- S = Length of travel
- H₂ = Required clearance height
- HRI = Trough inner height
- H = *Mounting height
- D₂ = Over length - long travels, gliding
- K₂ = *Further add-on

*If the mounting bracket location is set lower

Long Travels - Gliding



If the unsupported length is exceeded, the e-chain®/ Tube must glide on itself. This requires a guide trough.

Design, Chapter 1



PDF: igus.com/e-chain-pdfs
Product information: igus.com/e-chains



Technical Data



Details of material properties

► Chapter 1

Speed / acceleration FL _G	max. 6.56 ft/s (20 m/s) / max. 656 ft/s ² (200 m/s ²)
Speed / acceleration FL _B	max. 9.84 ft/s (3 m/s) / max. 19.69 ft/s ² (6 m/s ²)
Gliding speed / acceleration (maximum)	max. 32.8 ft/s (10 m/s) / max. 164 ft/s ² (50 m/s ²)
Material - permitted temperature	igumid G / -40°F (-40°C) up to +248°F (+120° C)
Flammability Class, igumid G	VDE 0304 IIC UL94 HB

Series 4040HD - e-chain® with crossbars every link

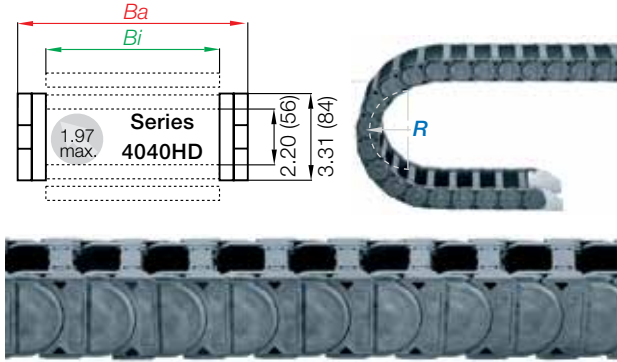

- Crossbars every link
- For use with rigid hydraulic hoses
- For particularly demanding applications
- Can be opened from both sides

Part Number Structure

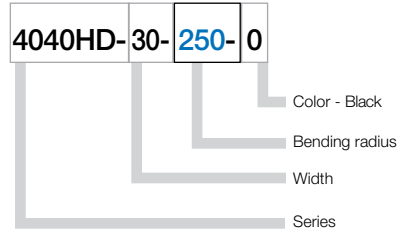

Series R8840HD - fully enclosed E-Tube

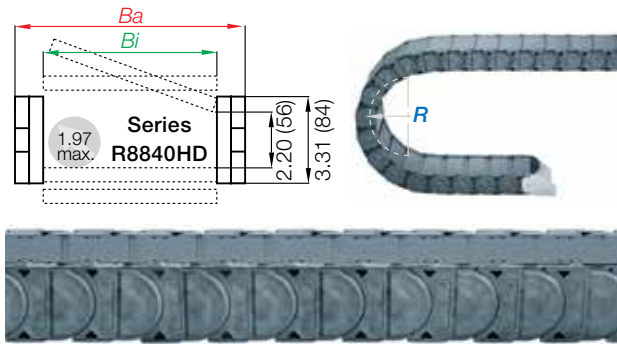

- Fully enclosed
- Excellent cable and hose protection against dirt
- Protection against hot chips up to 1652°F (900°C)
- Lids along inner radius are completely removable
- Lids along the outer radius are single-sided, snap open, hinged on one side as well as completely removable

Part Number Structure

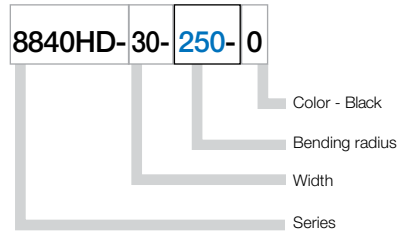

e-chain® as separate parts, links and side plates

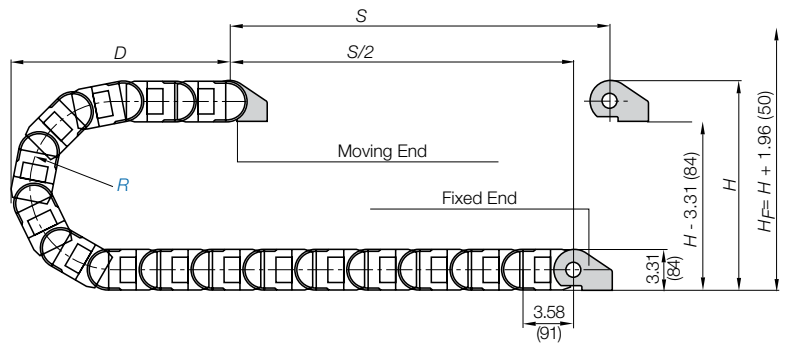
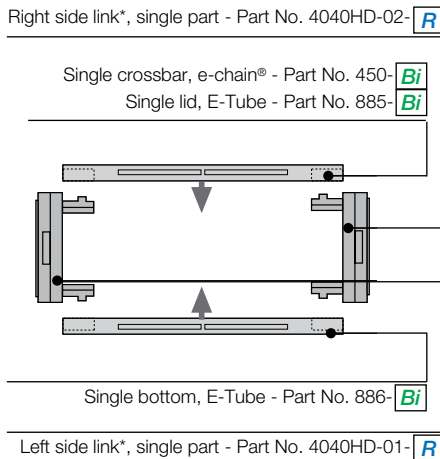

*View from the fixed point of the e-chain®/E-Tube

e-chain system® E4/4

Series 4040HD/R8840HD

Product Range



4040HD
R8840HD

Supplement part number with required radius. Example: 4040HD-30--0
Pitch: 3.58 in. (91mm) per link links/ft (m) = 3.35 (11)

Part Number			Weight			
Crossbars	Tube		<i>Bi</i>	<i>Ba</i>	4040R	8840HD
Every Link	Version		in. (mm)	in. (mm)	lbs/ft (kg/m)	lbs/ft (kg/m)
4040HD-05-		<input type="text" value="0"/> -0	1.97 (50)	4.09 (104)	≈ 3.38 (5.03)	-
4040HD-06-		<input type="text" value="0"/> -0	2.56 (65)	4.69 (119)	≈ 3.44 (5.12)	-
4040HD-07-	8840HD-07-	<input type="text" value="0"/> -0*	2.95 (75)	5.08 (129)	≈ 3.49 (5.19)	≈ 3.79 (5.64)
4040HD-08-		<input type="text" value="0"/> -0	3.43 (87)	5.55 (141)	≈ 3.54 (5.27)	-
4040HD-10-	8840HD-10-	<input type="text" value="0"/> -0	3.94 (100)	6.06 (154)	≈ 3.60 (5.36)	≈ 3.98 (5.93)
4040HD-11-		<input type="text" value="0"/> -0	4.41 (112)	6.54 (166)	≈ 3.68 (5.48)	-
4040HD-12-	8840HD-12-	<input type="text" value="0"/> -0	4.92 (125)	7.05 (179)	≈ 3.74 (5.56)	≈ 4.23 (6.29)
4040HD-13-		<input type="text" value="0"/> -0	5.39 (137)	7.52 (191)	≈ 3.82 (5.69)	-
4040HD-15-	8840HD-15-	<input type="text" value="0"/> -0	5.91 (150)	8.03 (204)	≈ 3.85 (5.73)	≈ 4.48 (6.67)
4040HD-16-		<input type="text" value="0"/> -0	6.38 (162)	8.50 (216)	≈ 3.92 (5.84)	-
4040HD-17-	8840HD-17-	<input type="text" value="0"/> -0	6.89 (175)	9.02 (229)	≈ 4.01 (5.97)	≈ 4.69 (6.98)
4040HD-18-		<input type="text" value="0"/> -0	7.36 (187)	9.49 (241)	≈ 4.09 (6.09)	-
4040HD-20-	8840HD-20-	<input type="text" value="0"/> -0	7.87 (200)	10.00 (254)	≈ 4.13 (6.14)	≈ 4.90 (7.29)
4040HD-21-		<input type="text" value="0"/> -0	8.35 (212)	10.47 (266)	≈ 4.17 (6.21)	-
4040HD-22-		<input type="text" value="0"/> -0	8.86 (225)	10.98 (279)	≈ 4.22 (6.28)	-
4040HD-23-		<input type="text" value="0"/> -0	9.33 (237)	11.46 (291)	≈ 4.29 (6.39)	-
4040HD-25-	8840HD-25-	<input type="text" value="0"/> -0	9.84 (250)	11.97 (304)	≈ 4.37 (6.50)	≈ 5.39 (8.02)
4040HD-26-		<input type="text" value="0"/> -0	10.31 (262)	12.44 (316)	≈ 4.43 (6.59)	-
4040HD-27-	8840HD-27-	<input type="text" value="0"/> -0	10.83 (275)	12.95 (329)	≈ 4.50 (6.70)	≈ 5.63 (8.38)
4040HD-28-		<input type="text" value="0"/> -0	11.30 (287)	13.43 (341)	≈ 4.54 (6.75)	-
4040HD-30-	8840HD-30-	<input type="text" value="0"/> -0	11.81 (300)	13.94 (354)	≈ 4.64 (6.91)	≈ 5.83 (8.68)
4040HD-31-		<input type="text" value="0"/> -0	12.28 (312)	14.41 (366)	≈ 4.66 (6.94)	-
4040HD-32-		<input type="text" value="0"/> -0	12.79 (325)	14.92 (379)	≈ 4.74 (7.05)	-
4040HD-33-		<input type="text" value="0"/> -0	13.27 (337)	15.39 (391)	≈ 4.82 (7.17)	-
4040HD-35-	8840HD-35-	<input type="text" value="0"/> -0	13.78 (350)	15.91 (404)	≈ 4.95 (7.37)	≈ 6.30 (9.38)
4040HD-36-		<input type="text" value="0"/> -0	14.25 (362)	16.38 (416)	≈ 4.89 (7.28)	-
4040HD-37-		<input type="text" value="0"/> -0	14.76 (375)	16.89 (429)	≈ 4.96 (7.38)	-
4040HD-38-		<input type="text" value="0"/> -0	15.24 (387)	17.36 (441)	≈ 5.03 (7.49)	-
4040HD-40-	8840HD-40-	<input type="text" value="0"/> -0	15.75 (400)	17.87 (454)	≈ 5.21 (7.76)	≈ 6.98 (10.38)
4040HD-41-		<input type="text" value="0"/> -0	16.22 (412)	18.35 (466)	≈ 5.16 (7.68)	-
4040HD-42-		<input type="text" value="0"/> -0	16.73 (425)	18.86 (479)	≈ 5.36 (7.98)	-
4040HD-43-		<input type="text" value="0"/> -0	17.20 (437)	19.33 (491)	≈ 5.25 (7.82)	-
4040HD-45-		<input type="text" value="0"/> -0	17.72 (450)	19.84 (504)	≈ 5.48 (8.15)	-
4040HD-46-	8840HD-46-	<input type="text" value="0"/> -0	18.19 (462)	20.31 (516)	≈ 5.44 (8.10)	≈ 7.29 (10.85)
4040HD-47-		<input type="text" value="0"/> -0	18.70 (475)	20.83 (529)	≈ 5.47 (8.14)	-
4040HD-48-		<input type="text" value="0"/> -0	19.17 (487)	21.30 (541)	≈ 5.64 (8.39)	-
4040HD-50-		<input type="text" value="0"/> -0	19.69 (500)	21.81 (554)	≈ 5.64 (8.40)	-
4040HD-51-		<input type="text" value="0"/> -0	20.16 (512)	22.28 (566)	≈ 5.70 (8.48)	-
4040HD-52-		<input type="text" value="0"/> -0	20.67 (525)	22.80 (579)	≈ 5.76 (8.57)	-
4040HD-53-		<input type="text" value="0"/> -0	21.14 (537)	23.27 (591)	≈ 5.82 (8.66)	-
4040HD-55-		<input type="text" value="0"/> -0	21.65 (550)	23.78 (604)	≈ 6.10 (9.08)	-
4040HD-60-		<input type="text" value="0"/> -0	23.62 (600)	25.75 (654)	≈ 6.26 (9.31)	-

Choose from the radii below for all of the above sizes
Radius (mm) Example: 4040HD-30--0

	135**	150	200	250	300	350	400
R	5.31 (135)	5.91 (150)	7.87 (200)	9.84 (250)	11.81 (300)	13.78 (350)	15.75 (400)
H* _{max}	13.94 (354)	15.12 (384)	19.06 (484)	22.99 (584)	26.93 (684)	30.87 (784)	34.80 (884)
D	12.36 (314)	12.95 (329)	14.92 (379)	16.88 (429)	18.86 (479)	20.83 (529)	22.79 (579)
K	24.02 (610)	25.79 (655)	32.09 (815)	38.19 (970)	44.29 (1125)	50.59 (1285)	56.69 (1440)

** This radius is not available for the R8840HD Series *Removable lid only, no hinged option

PDF: igus.com/e-chain-pdfs
Product information: igus.com/e-chains



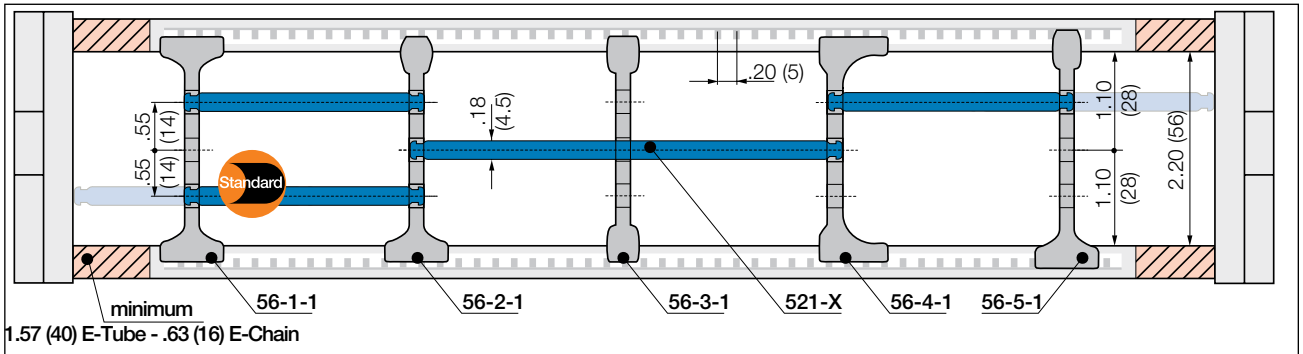

Note Please maintain a lateral spacing of 1.57" (40 mm) for E-Tube and .63" (16 mm) for e-chains® between the separators and the side links. In the standard configuration separators are assembled every 2nd e-chain® link

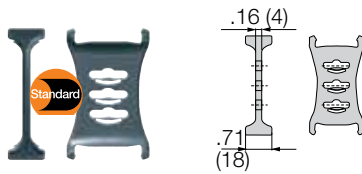

Separator, wide base

Unassembled	Part No. 56-1
Assembled	Part No. 56-1-1

- **Standard separator 56-1 for all applications**

Separator with wide base for maximum locking strength and safe standing in e-chains®.

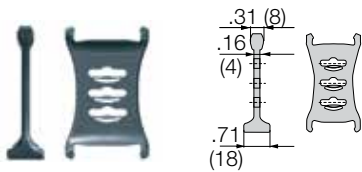

Separator, narrow head

Unassembled	Part No. 56-2
Assembled	Part No. 56-2-1

- **Separator 56-2 For even faster installation**

is used when vertical and horizontal separation is required. Due to its slot, it allows basic vertical/horizontal shelving arrangements.

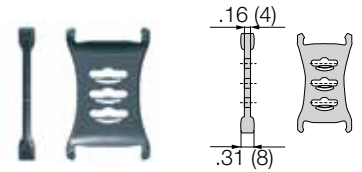

Separator, narrow base

Unassembled	Part No. 56-3
Assembled	Part No. 56-3-1

- **Separator 56-3 For many thin cables**

is used when vertical and horizontal separation is required. Due to its slot, it allows basic vertical/horizontal shelving arrangements.

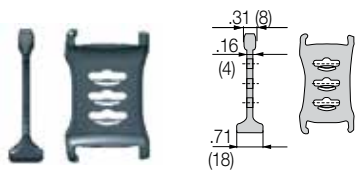

Separator, asymmetrical

Unassembled	Part No. 56-5
Assembled	Part No. 56-5-1

- **Separator 56-5 Locks safely in .30" (7.5 mm) increments**

Notch separator for exact positioning in e-chains®. Recommended for side-mounted applications.

Lockable full-width shelves - for the standard interior separation

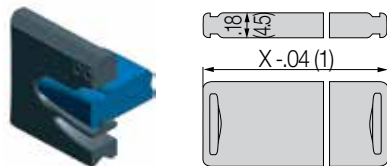

Full width shelf, lockable

Unassembled	Part No. 520-X
Assembled	Part No. 521-X

- **Full width shelf, lockable**

Shelf locks safely into separators on both ends, fixed width possible. Separators can be moved freely over the shelf in horizontal direction. Can be arranged at 3 different heights.

Width X in. (mm)	Part No. Unassembled	Part No. Assembled	Width X in. (mm)	Part No. Unassembled	Part No. Assembled	Width X in. (mm)	Part No. Unassembled	Part No. Assembled
1.97 (050)	520-050	521-050	5.91 (150)	520-150	521-150	11.81 (300)	520-300	521-300
2.56 (065)	520-065	521-065	6.89 (175)	520-175	521-175	13.78 (350)	520-350	521-350
2.95 (075)	520-075	521-075	7.87 (200)	520-200	521-200	14.76 (375)	520-375	521-375
3.94 (100)	520-100	521-100	8.86 (225)	520-225	521-225	15.24 (387)	520-387	521-387
4.92 (125)	520-125	521-125	9.84 (250)	520-250	521-250	17.723 (450)	520-450	521-450

e-chain system® E4/4
 Series 4040HD/R8840HD
 Interior Separation - New Generation



4040HD
 R8840HD

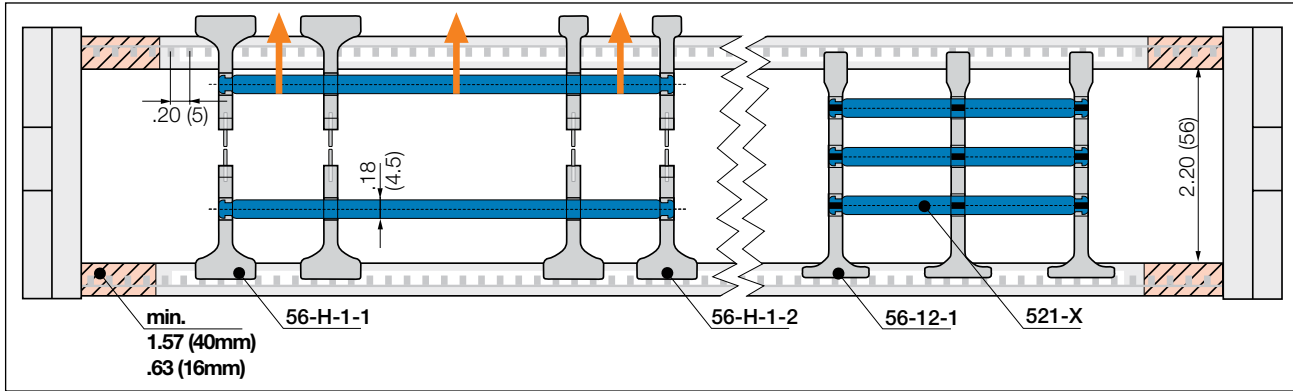

 Note Please maintain a lateral spacing of 1.57" (40 mm) for e-tube and .63" (16 mm) for e-chains® between the separators and the side links. In the standard configuration separators are assembled every 2nd e-chain® link

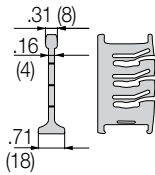

Lean separator

Unassembled	Part No. 56-12
Assembled	Part No. 56-12-1

• **Lean separators 56-12**

New design allows extremely fast fitting of shelves in several layers, which significantly reduces assembly time. Enables extremely fast replacement of individual cables in a very full e-chain®.



• **Lean separator design - several layers of cables fitted quickly, save up to 50%* assembly time**

(*Lean separator vs. standard separator - measured on a 4m long e-chain® fitted with 12 cables in the igus® harnessing factory)

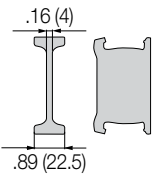

Notch locking separator

Unassembled	Part No. 56-6
Assembled	Part No. 56-6-1

• **Notch locking separator for increased holding force**

Notch locking separators offer higher crossbar opening forces for high humidity and/or large hydraulic hoses. They can be positioned precisely and then locked in position.

PDF: igus.com/e-chain-pdfs
 Product information: igus.com/e-chains





Vertical separators and spacers

Vertical separators are used if a vertical subdivision of the e-chain® interior is required. In standard configuration, a separator is installed every second chain link.

NOTE: Observe a lateral spacing of at least 1.26 in. (32mm) for E-Tubes and .63 in. (16mm) for e-chain®. There is no minimum spacing needed for side plates

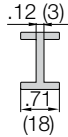
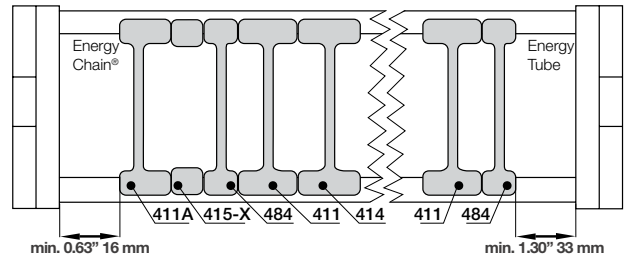

Vertical separator

Unassembled **Part No. 401**

Assembled **Part No. 411**

- **Standard separator 401 for e-chains® and E-Tubes**

This separator offers safe stability due to its wide base design.

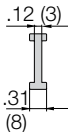

Vertical separator

Unassembled **Part No. 483**

Assembled **Part No. 484**

- **Vertical separator 483 for e-chains® and E-Tubes**

This separator offers a narrow base for applications where a large number of small cables need to be individually separated.

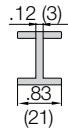

Locking separator (chain only)

Unassembled **Part No. 404**

Assembled **Part No. 414**

- **Locking separator 404 for e-chains®**

This separator features increased retention force for applications exposed to very high humidity and extreme loads. The extra retention force is achieved by asymmetric claws for the crossbar. Take care to ensure proper alignment.

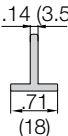

Locking separator (tube only)

Unassembled **Part No. 406**

Assembled **Part No. 416**

- **Locking separator 406 for E-Tubes**

It features a single sided, secure fit, and can be placed on the lid or the bottom of the E-Tube. The single side locking design helps to eliminate difficulties in assembling the opposite cover or crossbar

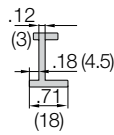

Asymmetrical separator (chain only)

Unassembled **Part No. 401A**

Assembled **Part No. 411A**

- **Asymmetrical separator 401A for e-chains®**

This separator features an .71" (18mm) base. It can be used in combinations between spacers of different widths and vertical separators in side mounted applications.



Spacer (chain only)

Unassembled **Part No. 405-XX**

Assembled **Part No. 415-XX**

XX = width of the spacer

- **NOTE ON SPACERS**

Vertical separators are adjustable, but can be fixed in position by means of a spacer. Spacers are most often necessary for side mounted applications.

The available inner height is reduced by .08" (2mm) **per spacer** (for example if one spacer is placed on either side of the separator, the overall inner height is reduced by .16" (4mm). To avoid this, place the spacers on the **outside** of the opening crossbar (**not for long travels**).

Spacers available in the following sizes:

Part No. Unassembled	Part No. Assembled	in. (mm)	Part No. Unassembled	Part No. Assembled	in. (mm)	Part No. Unassembled	Part No. Assembled	in. (mm)
405 -10	415 -10	.39 (10)	405 -20	415 -20	.79 (20)	405 -40	415 -40	1.57 (40)
405 -15	415 -15	.59 (15)	405 -30	415 -30	1.18 (30)			

Center crossbar - for applications involving a very large number of thin cables This offers the option of subdividing the e-chain® into upper and lower halves

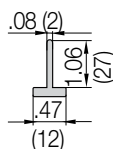

Center crossbar

Unassembled **Part No. 405**

Assembled **Part No. 415**

Rollclip - minimizes abrasion of particularly sensitive hoses or cables. The integrated rollers compensate for relative movement between the chain and the hose or cable.

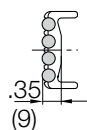

Rollclip

Unassembled **Part No. 489-27**

Assembled **Part No. 490-27**

Roller separator - performs a similar function to the Rollclip, but doubles as a separator.

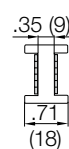

Center crossbar

Unassembled **Part No. 429**

Assembled **Part No. 430**

e-chain system® E4/4

Series 4040HD/R8840HD

Interior Separation - Previous Generation



4040HD
R8840HD



Shelves and separators

e-chains® and E-Tubes can be subdivided both vertically and horizontally using the various interior separation elements.

► Design, Chapter 1 for layout recommendations.

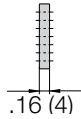
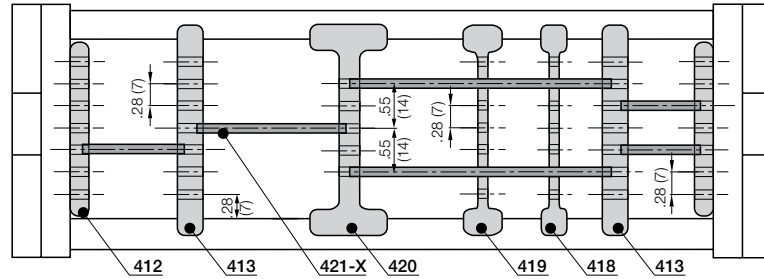

Side plate

Unassembled	Part No. 402
Assembled	Part No. 412

• Side plates 402

This component is used to form the basic pattern of a shelf system.

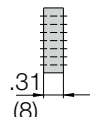

Vertical separator

Unassembled	Part No. 403
Assembled	Part No. 413

• Vertical separator 403

This component is used to form the basic pattern of a shelf system.

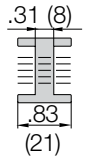

Locking vertical separator

Unassembled	Part No. 410
Assembled	Part No. 420

• Locking vertical separator 410

This separator is slotted and able to be combined with shelves. For e-chains® only

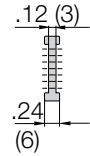
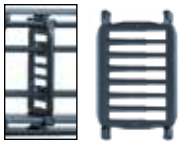

Slotted separators, closed

Unassembled	Part No. 408
Assembled	Part No. 418

• Slotted separators 408

These are used for very complex subdivisions. However, they cannot be retrofitted into an existing separation system without removing the shelves first.

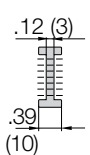

Slotted separators, open

Unassembled	Part No. 409
Assembled	Part No. 419

• Slotted separator 409

This separator can be retrofitted into an existing interior separation system without removing the shelves, as long as these shelves fit into any of the 3 middle slots

Shelves 420-XX

These components form the basic pattern of a shelf system. Shelves of various widths can be arranged at 7 different heights in .28" (7mm) increments

Width X in. (mm)	Usable Width in. (mm)	Part No. Unassembled	Part No. Assembled	Width X in. (mm)	Usable Width in. (mm)	Part No. Unassembled	Part No. Assembled
.71 (18)	.39 (10)	420-18	421-18	2.95 (75)	2.64 (67)	420-75	421-75
.91 (23)	.59 (15)	420-23	421-23	3.46 (88)	3.15 (80)	420-88	421-88
.98 (25)	.67 (17)	420-25	421-25	3.94 (100)	3.62 (92)	420-100	421-100
1.10 (28)	.79 (20)	420-28	421-28	4.92 (125)	4.61(117)	420-125	421-125
1.30 (33)	.98 (25)	420-33	421-33	5.91 (150)	5.59(142)	420-150	421-150
1.69 (43)	1.38 (35)	420-43	421-43	6.89 (175)	6.57(167)	420-175	421-175
1.97 (50)	1.65 (42)	420-50	421-50	7.36 (187)	7.05(179)	420-187	421-187
2.44 (62)	2.13 (54)	420-62	421-62	7.87 (200)	7.56(192)	420-200	421-200

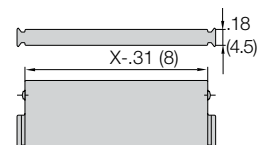

PDF: igus.com/e-chain-pdfs
Product information: igus.com/e-chains



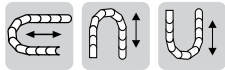

Option 1: pivoting

- For pivoting connections
- One part for all chain widths
- Electrically conductive

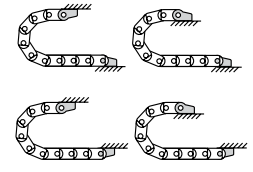
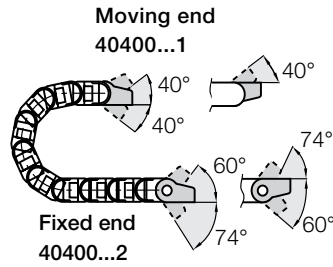

Possible installation configurations -

Part No. Mounting Brackets Full Set

4 parts, 2 with pin, 2 with bore
Series 4040HD or R8840HD
40400HD-12-SS

Part No. Mounting Bracket Moving End

2 parts, 1 left & 1 right with bore
Series 4040HD or R8840HD
40400HD-1-SS

Part No. Mounting Bracket Fixed End

2 parts, 1 left & 1 right with pin
Series 4040HD or R8840HD
40400HD-2-SS

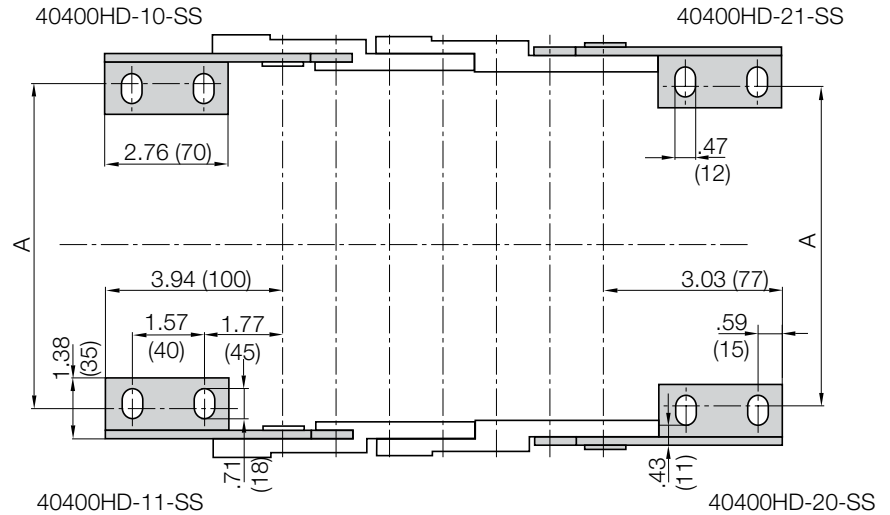

Bracket Mounting dimensions

Width of Chain <i>Bi</i>	Part Number	Mounting Brackets			A in. (mm)	Width of Chain <i>Bi</i>	Part Number	Mounting Brackets			A in. (mm)
		Full Set	Moving End Only	Fixed End Only				Full Set	Moving End Only	Fixed End Only	
1.97 (50)	40400HD	-12	-1	-2	1.18 (30)	12.28 (312)	40400HD	-12	-1	-2	11.49 (292)
2.56 (65)	40400HD	-12	-1	-2	1.77 (45)	12.79 (325)	40400HD	-12	-1	-2	12.00 (305)
2.95 (75)	40400HD	-12	-1	-2	2.16 (55)	13.27 (337)	40400HD	-12	-1	-2	12.48 (317)
3.43 (87)	40400HD	-12	-1	-2	2.64 (67)	13.78 (350)	40400HD	-12	-1	-2	12.99 (330)
3.94 (100)	40400HD	-12	-1	-2	3.15 (80)	14.25 (362)	40400HD	-12	-1	-2	13.46 (342)
4.41 (112)	40400HD	-12	-1	-2	3.62 (92)	14.76 (375)	40400HD	-12	-1	-2	13.97 (355)
4.92 (125)	40400HD	-12	-1	-2	4.13 (105)	15.24 (387)	40400HD	-12	-1	-2	14.45 (367)
5.39 (137)	40400HD	-12	-1	-2	4.61 (117)	15.75 (400)	40400HD	-12	-1	-2	14.96 (380)
5.91 (150)	40400HD	-12	-1	-2	5.12 (130)	16.22 (412)	40400HD	-12	-1	-2	15.43 (392)
6.38 (162)	40400HD	-12	-1	-2	5.59 (142)	16.73 (425)	40400HD	-12	-1	-2	15.94 (405)
6.89 (175)	40400HD	-12	-1	-2	6.10 (155)	17.20 (437)	40400HD	-12	-1	-2	16.42 (417)
7.36 (187)	40400HD	-12	-1	-2	6.57 (167)	17.72 (450)	40400HD	-12	-1	-2	16.93 (430)
7.87 (200)	40400HD	-12	-1	-2	7.09 (180)	18.19 (462)	40400HD	-12	-1	-2	17.40 (442)
8.35 (212)	40400HD	-12	-1	-2	7.56 (192)	18.70 (475)	40400HD	-12	-1	-2	17.91 (455)
8.86 (225)	40400HD	-12	-1	-2	8.07 (205)	19.17 (487)	40400HD	-12	-1	-2	18.39 (467)
9.33 (237)	40400HD	-12	-1	-2	8.54 (217)	19.69 (500)	40400HD	-12	-1	-2	18.90 (480)
9.84 (250)	40400HD	-12	-1	-2	9.05 (230)	20.16 (512)	40400HD	-12	-1	-2	19.37 (492)
10.31 (262)	40400HD	-12	-1	-2	9.53 (242)	20.67 (525)	40400HD	-12	-1	-2	19.88 (505)
10.83 (275)	40400HD	-12	-1	-2	10.04 (255)	21.14 (537)	40400HD	-12	-1	-2	20.35 (517)
11.30 (287)	40400HD	-12	-1	-2	10.51 (267)	21.65 (550)	40400HD	-12	-1	-2	20.87 (530)
11.81 (300)	40400HD	-12	-1	-2	11.02 (280)	23.62 (600)	40400HD	-12	-1	-2	22.83 (580)

e-chain system® E4/4

Series 4040HD/R8840HD

Strain Relief



4040HD
R8840HD

Tiewrap plates as an individual part

Available as an individual component, can be fixed onto a mounting bracket with the use of a profile rail.



For more information please refer to strain relief section of Chapter 10

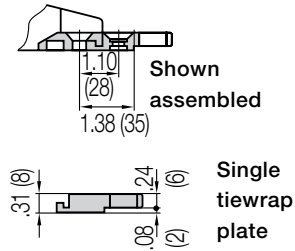
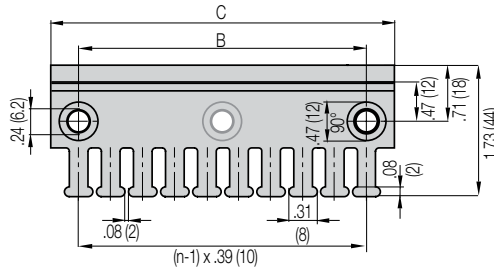

Tiewrap Plate	n Number of Teeth	C Overall Width in. (mm)	B Bore Width in. (mm)	Center Bore
3050-ZB	5	1.97 (50)	1.18 (30)	no
3075-ZB	7	2.95 (75)	2.16 (55)	no
3100-ZB	10	3.94 (100)	3.15 (80)	no
3115-ZB	11	4.53 (115)	3.74 (95)	no
3125-ZB	12	4.92 (125)	4.13 (105)	no
3150-ZB	15	5.91 (150)	5.12 (130)	no
3175-ZB	17	6.89 (175)	6.10 (155)	no
3200-ZB	20	7.87 (200)	7.09 (180)	yes
3225-ZB	22	8.86 (225)	8.07 (205)	yes
3250-ZB	25	9.84 (250)	9.06 (230)	yes

PDF: igus.com/e-chain-pdfs
Product information: igus.com/e-chains



Width of Crossbar
4040HD-05-200-0

	B_{Ri}	Installation Part No.
-05	4.29 (109)	*
-06	4.88 (124)	94-50-225
-07	5.28 (134)	94-50-225
-08	5.75 (146)	94-50-250
-10	6.26 (159)	94-50-250
-11	6.73 (171)	94-50-275
-12	7.24 (184)	94-50-275
-13	7.72 (196)	94-50-300
-15	8.23 (209)	94-50-300
-16	8.70 (221)	94-50-325
-17	9.21 (234)	94-50-325
-18	9.69 (246)	94-50-350
-20	10.20 (259)	94-50-350
-21	10.67 (271)	94-50-375
-22	11.18 (284)	94-50-375
-23	11.65 (296)	94-50-400
-25	12.17 (309)	94-50-400
-26	12.64 (321)	94-50-425
-27	13.15 (334)	94-50-425
-28	13.62 (346)	94-50-450
-30	14.13 (359)	94-50-450
-31	14.61 (371)	94-50-475
-32	15.12 (384)	94-50-475
-33	15.59 (396)	94-50-500
-35	16.10 (409)	94-50-500
-36	16.57 (421)	94-50-525
-37	17.09 (434)	94-50-525
-38	17.56 (446)	94-50-550
-40	18.07 (459)	94-50-550
-41	18.54 (471)	94-50-575
-42	19.06 (484)	94-50-575
-43	19.53 (496)	94-50-600
-45	20.04 (509)	94-50-600
-46	20.51 (521)	94-50-625
-47	21.02 (534)	94-50-625
-48	21.50 (546)	94-50-650
-50	22.01 (559)	94-50-650
-51	22.48 (571)	94-50-675
-52	22.99 (584)	94-50-675
-53	23.46 (596)	94-50-700
-55	23.98 (609)	94-50-700
-60	25.94 (659)	94-50-750

Guide troughs are used with applications where the upper run of the e-chain® glides on the lower run. If using igus® steel guide troughs, the following components are required.

- Full travel length of guide trough
Part No. 94-30
- 1/2 travel length glide bars
Part No. 93-01
- Installation sets as end connectors
Part No. 94-50-XX

.XX indicates the length of the profile rails on which the guide trough is mounted. The values and part numbers are specified in the table on the left. The standard length of the trough components and glide bars is 6.56 ft (2 m). The required overall length of the guide trough directly correlates to the length of travel.

Example:

Length of travel 164 ft (50 m)
Center mounted

Required guide troughs:

164 ft (50 m) guide trough
82 ft (25 m) glide bars
= 25 sections of 6.56 ft (2 m) guide trough
Part No. 94-30
= 13 sections of 6.56 ft (2 m) glide bars
Part No. 93-01

Required number of installation sets:

= Number of guide trough components + 1
= 25 + 1 = 26

Part number of the installation sets

94-50-XXX

Example:

94-50-400 for 15.75 (400 mm) long profile rail



Left: Guide trough with glide bars
Right: Guide troughs without glide bars



Installation sets as section connectors

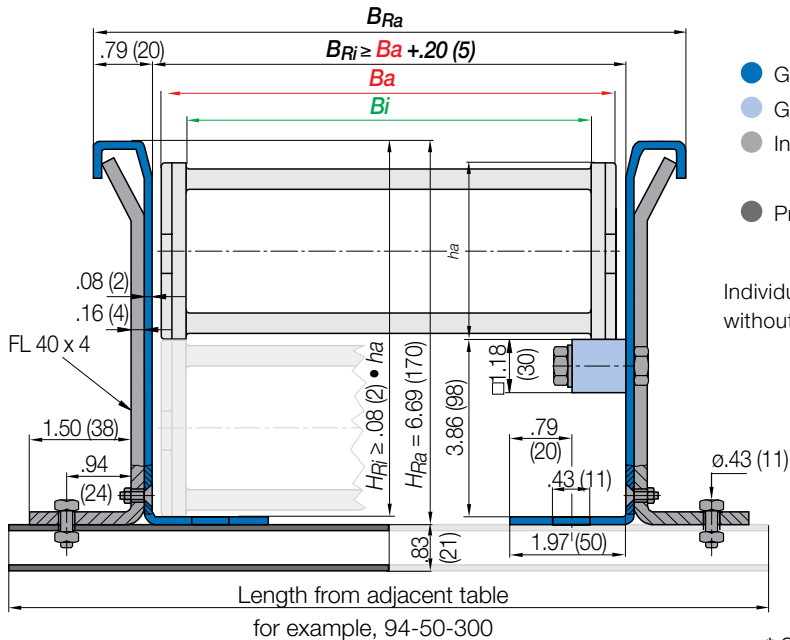

- Guide trough
- Glide bars
- Installation set "Basic"
- Profile rail

Individual attachment without profile rail

* Specialized guide trough available upon request

Standard length profile rail

For further technical information on guide troughs
► Chapter 9

PDF: igus.com/e-chain-pdfs
Product information: igus.com/e-chains



5050HD
R9850HD



e-chain system® E4/4 Series 5050HD/R9850HD

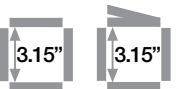

Price Index



Features & Benefits

- 1 Robust steel-mounting brackets
- 2 Wide, rounded plastic crossbars - cable friendly
- 3 Very wide glide surface, less wear
- 4 High tensile stability (20% higher tensile force than Series 5050)
- 5 Hinged snap-open removable lids along outer radius of E-Tube
- 6 High torsional rigidity
- 7 Closed and open styles can be combine
- 8 Numerous interior separation possibilities
- 9 High side-mount stability due to undercut
- 10 Crossbars on e-chains® are removable along both radii

Special Features / Options



Side-mounted - unsupported



ESD classification:
Electrically conductive ESD/
ATEX version upon request



High torsional rigidity

Assembly Tips



Opening e-chains®: Remove crossbars and clips - Insert screwdriver into the slot, push down, release by lever action



Remove lids/bottoms (E-Tubes) - Insert screwdriver into the slot, release by lever action

Other Installation Methods

- Vertical, hanging ≤ 394 ft (120 m)
- Vertical, standing ≤ 19.69 ft (6 m)
- Side-mounted, un supp. ≤ 9.84 ft (3 m)
- Rotary requires further calculation

Usage Guidelines



- When high torsional forces are expected
- For side-mounted applications
- For long-term operation in very moist environments



- When short travels or medium additional loads are involved
 - Series E4-80
- If a simpler low-cost solution is required
 - Series 15050/15150/R19850



rol e-chain® Series 5050RHD/9850RHD available upon request



Order Example: Complete e-chain®

Please indicate chain length or number of links. Example:

16.4 ft (5 m) 5050HD-30-300-0

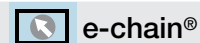

e-chain®

With 2 separators 80-1 assembled every 2nd link



Interior Separation

1 Set 50500HD-12-E



Mounting Bracket

For long travels with lowered mounting height
Long travel lengths from 32.8 ft.(10m) to max. 1,640 ft. (500m)

Chain length: $= \frac{S}{2} + K_2$

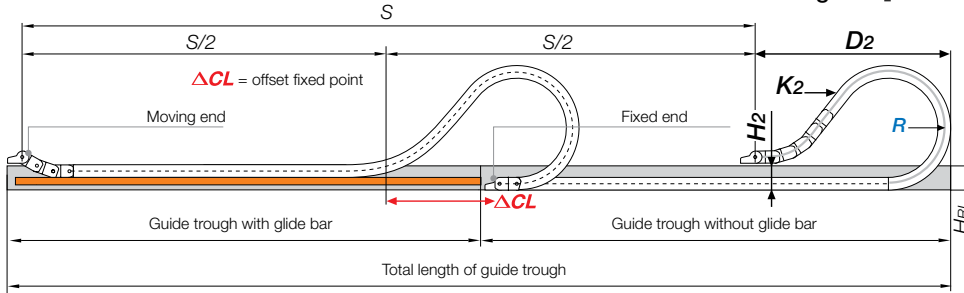

In case of travels between 13 ft. (4m) and 32.8 ft. (10m) we recommend a longer unsupported length.

R	5.91 (150)	7.87 (200)	9.84 (250)	11.81 (300)	13.78 (350)	15.75 (400)	19.69 (500)
H	9.53 (242)	9.53 (242)	9.53 (242)	9.53 (242)	9.53 (242)	9.53 (242)	9.53 (242)
D	21.65 (550)	31.50 (800)	37.40 (950)	47.24 (1200)	61.02 (1550)	66.93 (1700)	85.63 (2175)
K	35.83 (910)	50.16 (1274)	64.49 (1638)	78.82 (2002)	97.44 (2475)	107.48 (2730)	136.14 (3458)
ΔCL	8.23 (209)	16.10 (409)	20.04 (509)	27.91 (709)	39.72 (1009)	43.66 (1109)	58.43 (1484)

Legend

- S = Length of travel
- H = Required clearance height
- HRI = Trough inner height
- H₂ = *Mounting height
- D₂ = Over length - long travels, gliding
- K₂ = *Further add-on

*If the mounting bracket location is set lower

Long Travels - Gliding



If the unsupported length is exceeded, the e-chain®/ Tube must glide on itself. This requires a guide trough.

Design, Chapter 1

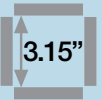

PDF: igus.com/e-chain-pdfs
Product information: igus.com/e-chains



Technical Data

Speed / acceleration FL _G	max. 6.56 ft/s (20 m/s) / max. 656 ft/s ² (200 m/s ²)
Speed / acceleration FL _B	max. 9.84 ft/s (3 m/s) / max. 19.69 ft/s ² (6 m/s ²)
Gliding speed / acceleration (maximum)	max. 32.8 ft/s (10 m/s) / max. 164 ft/s ² (50 m/s ²)
Material - permitted temperature	igumid G / -40°F (-40°C) up to +248°F (+120° C)
Flammability Class, igumid G	VDE 0304 IIC UL94 HB



Details of material properties

► Chapter 1

Series 5050HD - e-chain® with crossbars every link

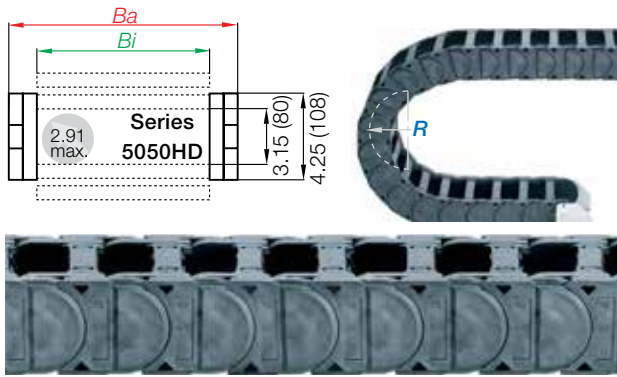

- Crossbars every link
- For use with rigid hydraulic hoses
- For particularly demanding applications
- Can be opened from both sides

Part Number Structure

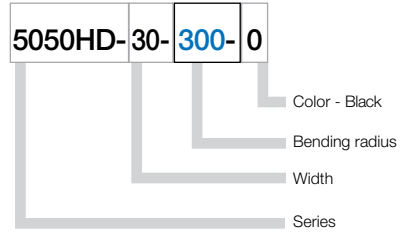

Series R9850HD - fully enclosed E-Tube

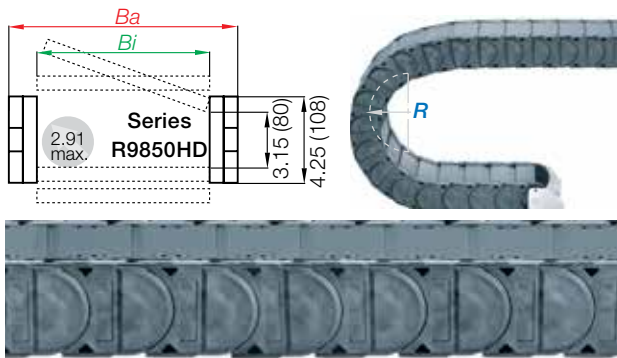

- Fully enclosed
- Excellent cable and hose protection against dirt
- Protection against hot chips up to 1562°F (850°C)
- Lids along inner radius are completely removable
- Lids along the outer radius are single-sided, snap open, hinged on one side as well as completely removable

Part Number Structure

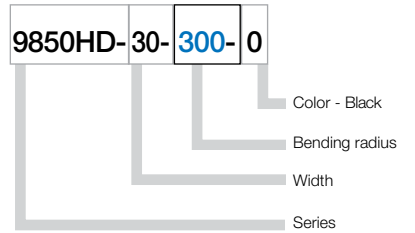

e-chain® as separate parts, links and side plates

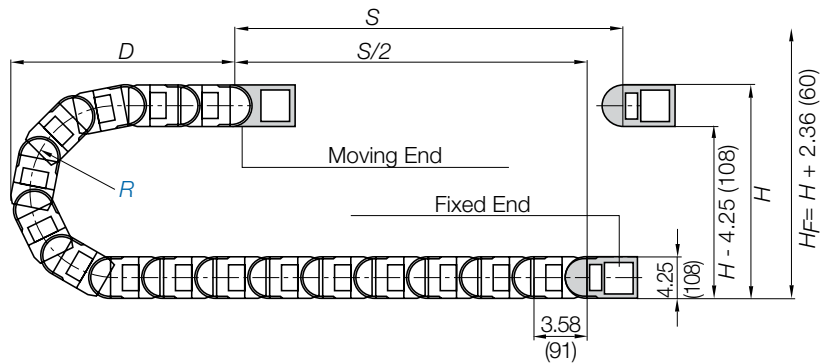
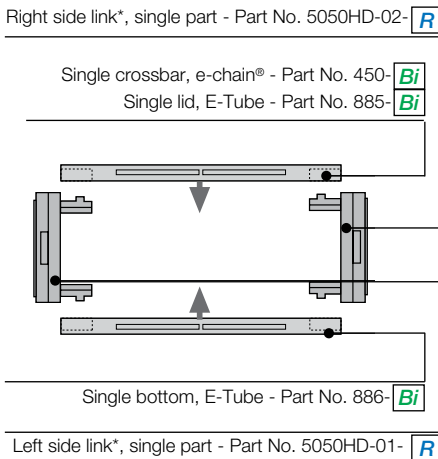

*View from the fixed point of the e-chain®/E-Tube

e-chain system® E4/4

Series 5050HD/R9850HD



5050HD
R9850HD

Supplement part number with required radius. Example: 5050HD-30-300-0

Pitch: 3.58 in. (91mm) per link links/ft(m) = 3.35 (11)

Part Number.			<i>Bi</i>	<i>Ba</i>	5050HD	R9850HD
Crossbars	Tube		in. (mm)	in. (mm)	lbs/ft (kg/m)	lbs/ft (kg/m)
Every link	Version					
5050HD-05-		<input type="text"/> -0	1.97 (50)	4.33 (110)	≈ 4.47 (6.65)	–
5050HD-06-		<input type="text"/> -0	2.56 (65)	4.92 (125)	≈ 4.53 (6.74)	–
5050HD-07-	9850HD-07-	<input type="text"/> -0*	2.95 (75)	5.31 (135)	≈ 4.58 (6.81)	≈ 4.87 (7.25)
5050HD-08-		<input type="text"/> -0	3.43 (87)	5.79 (147)	≈ 4.63 (6.89)	–
5050HD-10-	9850HD-10-	<input type="text"/> -0	3.94 (100)	6.30 (160)	≈ 4.70 (6.99)	≈ 5.07 (7.55)
5050HD-11-		<input type="text"/> -0	4.41 (112)	6.77 (172)	≈ 4.77 (7.10)	–
5050HD-12-	9850HD-12-	<input type="text"/> -0	4.92 (125)	7.28 (185)	≈ 4.82 (7.18)	≈ 5.32 (7.91)
5050HD-13-		<input type="text"/> -0	5.39 (137)	7.76 (197)	≈ 4.92 (7.32)	–
5050HD-15-	9850HD-15-	<input type="text"/> -0	5.91 (150)	8.27 (210)	≈ 4.94 (7.35)	≈ 5.57 (8.29)
5050HD-16-		<input type="text"/> -0	6.38 (162)	8.74 (222)	≈ 5.02 (7.47)	–
5050HD-17-	9850HD-17	<input type="text"/> -0	6.89 (175)	9.25 (235)	≈ 5.11 (7.60)	≈ 5.78 (8.60)
5050HD-18-		<input type="text"/> -0	7.36 (187)	9.72 (247)	≈ 5.18 (7.71)	–
5050HD-20-	9850HD-20-	<input type="text"/> -0	7.87 (200)	10.24 (260)	≈ 5.22 (7.77)	≈ 5.99 (8.91)
5050HD-21-		<input type="text"/> -0	8.35 (212)	10.71 (272)	≈ 5.27 (7.84)	–
5050HD-22-		<input type="text"/> -0	8.86 (225)	11.22 (285)	≈ 5.32 (7.91)	–
5050HD-23-		<input type="text"/> -0	9.33 (237)	11.69 (297)	≈ 5.39 (8.02)	–
5050HD-25-	9850HD-25-	<input type="text"/> -0	9.84 (250)	12.20 (310)	≈ 5.46 (8.13)	≈ 6.48 (9.64)
5050HD-26-		<input type="text"/> -0	10.31 (262)	12.68 (322)	≈ 5.52 (8.22)	–
5050HD-27-	9850HD-27	<input type="text"/> -0	10.83 (275)	13.19 (335)	≈ 5.59 (8.32)	≈ 6.72 (10.00)
5050HD-28-		<input type="text"/> -0	11.30 (287)	13.66 (347)	≈ 5.63 (8.38)	–
5050HD-30-	9850HD-30-	<input type="text"/> -0	11.81 (300)	14.17 (360)	≈ 5.73 (8.53)	≈ 6.92 (10.30)
5050HD-31-		<input type="text"/> -0	12.28 (312)	14.65 (372)	≈ 5.76 (8.57)	–
5050HD-32-		<input type="text"/> -0	12.79 (325)	15.16 (385)	≈ 5.83 (8.67)	–
5050HD-33-		<input type="text"/> -0	13.27 (337)	15.63 (397)	≈ 5.91 (8.79)	–
5050HD-35-	9850HD-35-	<input type="text"/> -0	13.78 (350)	16.14 (410)	≈ 6.04 (8.99)	≈ 7.39 (11.00)
5050HD-36-		<input type="text"/> -0	14.25 (362)	16.61 (422)	≈ 5.98 (8.90)	–
5050HD-37-		<input type="text"/> -0	14.76 (375)	17.12 (435)	≈ 6.04 (9.00)	–
5050HD-38-		<input type="text"/> -0	15.24 (387)	17.60 (447)	≈ 6.12 (9.11)	–
5050HD-40-	9850HD-40-	<input type="text"/> -0	15.75 (400)	18.11 (460)	≈ 6.30 (9.38)	≈ 8.06 (12.00)
5050HD-41-		<input type="text"/> -0	16.22 (412)	18.58 (472)	≈ 6.26 (9.31)	–
5050HD-42-		<input type="text"/> -0	16.73 (425)	19.09 (485)	≈ 6.45 (9.60)	–
5050HD-43-		<input type="text"/> -0	17.20 (437)	19.57 (497)	≈ 6.34 (9.44)	–
5050HD-45-		<input type="text"/> -0	17.72 (450)	20.08 (510)	≈ 6.42 (9.55)	–
5050HD-46-	9850HD-46-	<input type="text"/> -0	18.19 (462)	20.55 (522)	≈ 6.53 (9.72)	≈ 8.38 (12.47)
5050HD-47-		<input type="text"/> -0	18.70 (475)	21.06 (535)	≈ 6.56 (9.76)	–
5050HD-48-		<input type="text"/> -0	19.17 (487)	21.54 (547)	≈ 6.73 (10.01)	–
5050HD-50-		<input type="text"/> -0	19.69 (500)	22.05 (560)	≈ 6.79 (10.11)	–
5050HD-51-		<input type="text"/> -0	20.16 (512)	22.52 (572)	≈ 6.73 (10.02)	–
5050HD-52-		<input type="text"/> -0	20.67 (525)	23.03 (585)	≈ 6.85 (10.19)	–
5050HD-53-		<input type="text"/> -0	21.14 (537)	23.50 (597)	≈ 6.91 (10.29)	–
5050HD-55-		<input type="text"/> -0	21.65 (550)	24.02 (610)	≈ 7.20 (10.71)	–
5050HD-60-		<input type="text"/> -0	23.62 (600)	25.98 (660)	≈ 7.35 (10.94)	–

Choose from the radii below for all of the above sizes

Radius (mm) Example: 5050HD-30-300-0

	150	200	250	300	350	400	500
R	5.91 (150)	7.87 (200)	9.84 (250)	11.81 (300)	13.78 (350)	15.75 (400)	19.69 (500)
H** _{as}	16.06 (408)	20.00 (508)	23.94 (608)	27.87 (708)	31.81 (808)	35.75 (908)	43.62 (1108)
D	13.43 (341)	15.39 (391)	17.36 (441)	19.33 (491)	21.30 (541)	23.27 (591)	27.20 (691)
K	25.79 (655)	32.09 (815)	38.19 (970)	44.29 (1125)	50.59 (1285)	56.69 (1440)	69.09 (1755)

** This radius is not available for the R9850HD Series *Removable lid only, no hinged option

PDF: igus.com/e-chain-pdfs
Product information: igus.com/e-chains



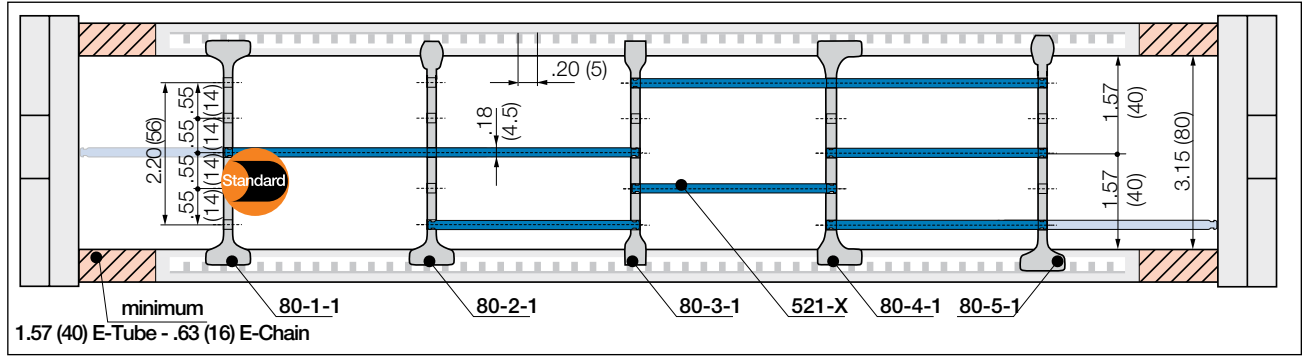

Note Please maintain a lateral spacing of 1.57" (40 mm) for E-Tube and .63" (16 mm) for e-chains® between the separators and the side links. In the standard configuration separators are assembled every 2nd e-chain® link

Telephone 1-800-521-2747

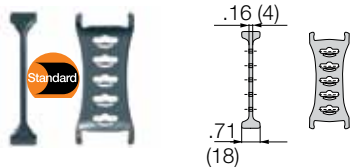

Separator, wide base

Unassembled	Part No. 80-1
Assembled	Part No. 80-1-1

- **Standard separator 80-1 for all applications**

Separator with wide base for maximum locking strength and safe standing in e-chains®.

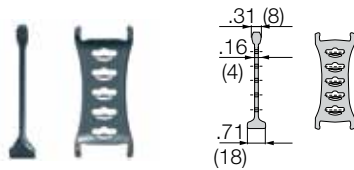

Separator, narrow head

Unassembled	Part No. 80-2
Assembled	Part No. 80-2-1

- **Separator 80-2**

For even faster installation
is used when vertical and horizontal separation is required. Due to its slot, it allows basic vertical/horizontal shelving arrangements.

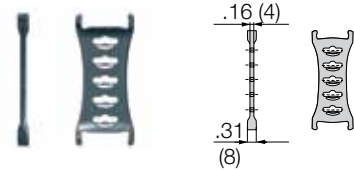

Separator, narrow base

Unassembled	Part No. 80-3
Assembled	Part No. 80-3-1

- **Separator 80-3**

For many thin cables
is used when vertical and horizontal separation is required. Due to its slot, it allows basic vertical/horizontal shelving arrangements.

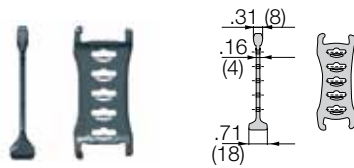

Separator, asymmetrical

Unassembled	Part No. 80-5
Assembled	Part No. 80-5-1

- **Separator 80-5**

Locks safely in .30" (7.5 mm) increments
Notch separator for exact positioning in e-chains®. Recommended for side-mounted applications.

Lockable full-width shelves - for the standard interior separation

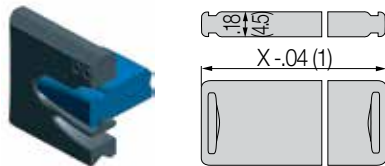

Full width shelf, lockable

Unassembled	Part No. 520-X
Assembled	Part No. 521-X

- **Full width shelf, lockable**

Shelf locks safely into separators on both ends, fixed width possible. Separators can be moved freely over the shelf in horizontal direction. Can be arranged at 5 different heights.

Internet: igus.com
email: sales@igus.com
QuickSpec: igus.com/quickspec

Width X in. (mm)	Part No. Unassembled	Part No. Assembled	Width X in. (mm)	Part No. Unassembled	Part No. Assembled	Width X in. (mm)	Part No. Unassembled	Part No. Assembled
1.97 (050)	520-050	521-050	5.91 (150)	520-150	521-150	11.81 (300)	520-300	521-300
2.56 (065)	520-065	521-065	6.89 (175)	520-175	521-175	17.723 (450)	520-450	521-125
2.95 (075)	520-075	521-075	7.87 (200)	520-200	521-200			
3.94 (100)	520-100	521-100	8.86 (225)	520-225	521-225			
4.92 (125)	520-125	521-125	9.84 (250)	520-250	521-250			

e-chain system® E4/4
 Series 5050HD/R9850HD
 Interior Separation - Previous Generation



5050HD
 R9850HD

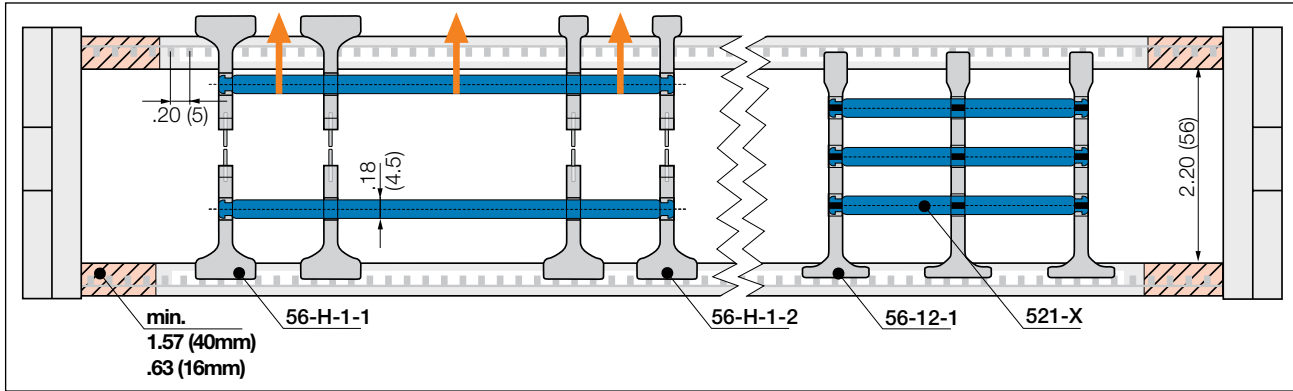

Note Please maintain a lateral spacing of 1.57" (40 mm) for e-tube and .63" (16 mm) for e-chains® between the separators and the side links. In the standard configuration separators are assembled every 2nd e-chain® link

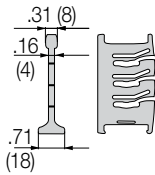

Lean separator

Unassembled	Part No. 56-12
Assembled	Part No. 56-12-1

- **Lean separators 56-12**
 New design allows extremely fast fitting of shelves in several layers, which significantly reduces assembly time. Enables extremely fast replacement of individual cables in a very full e-chain®.



- **Lean separator design - several layers of cables fitted quickly, save up to 50%* assembly time**
 (*Lean separator vs. standard separator - measured on a 4m long e-chain® fitted with 12 cables in the igus® harnessing factory)

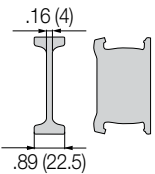

Notch locking separator

Unassembled	Part No. 56-6
Assembled	Part No. 56-6-1

- **Notch locking separator for increased holding force**
 Notch locking separators offer higher crossbar opening forces for high humidity and/or large hydraulic hoses. They can be positioned precisely and then locked in position.

PDF: igus.com/e-chain-pdfs
 Product information: igus.com/e-chains





Vertical separators and spacers

Vertical separators are used if a vertical subdivision of the e-chain® interior is required. By standard, vertical separators are assembled every other e-chain® link.

NOTE: Observe a lateral spacing of at least 1.30 in. (33mm) for E-Tubes and .63 in. (16mm) for e-chain®. There is no minimum spacing needed for side plates

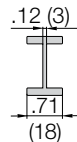
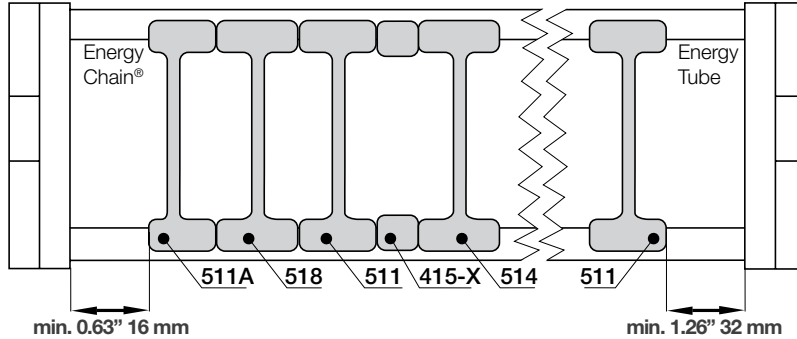

Vertical separator

Unassembled	Part No. 501
Assembled	Part No. 511

- **Standard separator 501 for e-chains® and E-Tubes**
This separator offers safe stability due to its wide base design, also when used with thick cables or hoses.

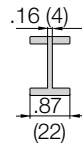

Locking separator (for e-chains®)

Unassembled	Part No. 504
Assembled	Part No. 514

- **Locking separator 504 for e-chains®**
This separator features increased retention force for applications exposed to very high humidity and extreme loads. If locking separators are used, the e-chain® is more difficult to open.

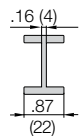

Locking separator (for E-Tubes)

Unassembled	Part No. 508
Assembled	Part No. 518

- **Locking separator 508 for E-Tubes**
This separator is used for applications that are exposed to extremely high humidity. The clamp at the side serves to uniformly align the separators. In order to avoid destroying the separators when opening the e-chain®, make sure all separators are identically aligned.

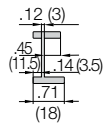

Asymmetrical separator (for e-chains®)

Unassembled	Part No. 501A
Assembled	Part No. 511A

- **Asymmetrical separator 501A for e-chains®**
This separator is NOT for E-Tubes. It features an (18mm) base and can be used in combinations between spacers of different widths and vertical separators in side mounted applications.



Spacer (for e-chains®)

Unassembled	Part No. 405-XX
Assembled	Part No. 415-XX

XX = width of the spacer

- **NOTE ON SPACERS**
Vertical separators are adjustable, but can be fixed in position by means of a spacer. Spacers are most often necessary for side mounted applications. The available inner height is reduced by .08" (2mm) **per spacer** (for example if one spacer is placed on either side of the separator, the overall inner height is reduced by .16" (4mm). To avoid this, place the spacers on the **outside** of the opening crossbar (**not for long travels**).

Spacers available in the following sizes:

Part No. Unassembled	Part No. Assembled	in.	(mm)	Part No. Unassembled	Part No. Assembled	in.	(mm)
405 -10	415 -10	.39"	(10)	405 -30	415 -30	1.18"	(30)
405 -15	415 -15	.59"	(15)	405 -40	415 -40	1.57"	(40)
405 -20	415 -20	.79"	(20)				



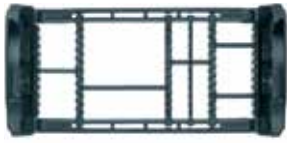

Shelves

e-chains® and E-Tubes can be subdivided both vertically and horizontally using the various interior separation elements.

► **Design, Chapter 1** for layout recommendations.

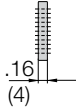
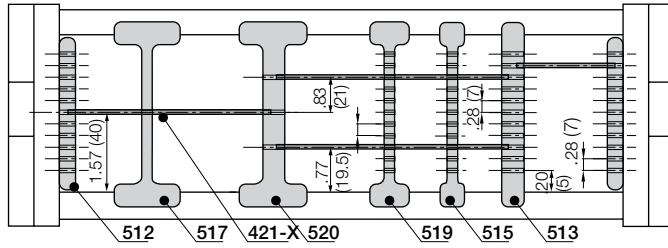

Side plate

Unassembled	Part No. 502
Assembled	Part No. 512

- **Side plates 502**
This component is used to form the basic pattern of a shelf system.

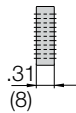

Vertical separator

Unassembled	Part No. 503
Assembled	Part No. 513

- **Vertical separator 503**
This component is used to form the basic pattern of a shelf system.

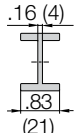

Locking vertical separator

Unassembled	Part No. 507
Assembled	Part No. 517

- **Locking vertical separator 507**
This separator features increased retention force for applications exposed to very high humidity and extreme loads. The extra retention force is achieved by asymmetric claws for the crossbar. Take care to ensure proper alignment.

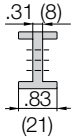

Locking vertical separator

Unassembled	Part No. 510
Assembled	Part No. 520

- **Locking vertical separator 510**
This separator is slotted and able to be combined with shelves. For e-chains® only

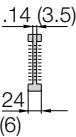

Slotted separators, closed

Unassembled	Part No. 505
Assembled	Part No. 515

- **Slotted separators 505**
These are used for very complex subdivisions. However, they cannot be retrofitted into an existing separation system without removing the shelves first.

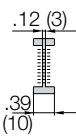

Slotted separators, open

Unassembled	Part No. 509
Assembled	Part No. 519

- **Slotted separator 509**
This separator can be retrofitted into an existing interior separation system without removing the shelves, as long as these shelves fit into any of the 7 middle slots

Shelves 420-XX

These components form the basic pattern of a shelf system. Shelves of various widths can be arranged at 7 different heights in .28" (7mm) increments

Usable Width X in. (mm)	Part No. Width in. (mm)	Part No. Shelf only	Assembled	Usable Width X in. (mm)	Part No. Width in. (mm)	Part No. Shelf only	Assembled
.71 (18)	.39 (10)	420-18	421-18	2.95 (75)	2.64 (67)	420-75	421-75
.91 (23)	.59 (15)	420-23	421-23	3.46 (88)	3.15 (80)	420-88	421-88
.98 (25)	.67 (17)	420-25	421-25	3.94 (100)	3.62 (92)	420-100	421-100
1.10 (28)	.79 (20)	420-28	421-28	4.92 (125)	4.61(117)	420-125	421-125
1.30 (33)	.98 (25)	420-33	421-33	5.91 (150)	5.59(142)	420-150	421-150
1.69 (43)	1.38 (35)	420-43	421-43	6.89 (175)	6.57(167)	420-175	421-175
1.97 (50)	1.65 (42)	420-50	421-50	7.36 (187)	7.05(179)	420-187	421-187
2.44 (62)	2.13 (54)	420-62	421-62	7.87 (200)	7.56(192)	420-200	421-200

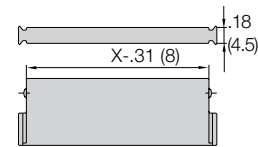

Rollclip - minimizes abrasion of particularly sensitive hoses or cables in an e-chain®. The integrated rollers compensate for relative movement between the chain and the hose or cable. This reduces the abrasion of the hoses or cables

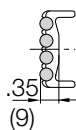

Rollclip

Unassembled	Part No. 489-27
Assembled	Part No. 490-27



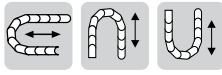

pivoting

- For pivoting connections
- One part for all chain widths
- Electrically conductive

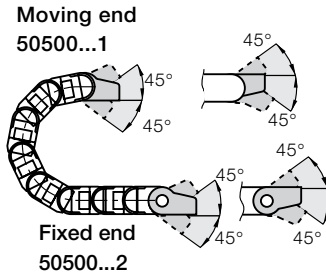

Possible installation configurations -

Part No. Mounting Brackets Full Set

4 parts, 2 with pin, 2 with bore
Series 5050HD or R9850HD:
50500HD-12-SS

Part No. Mounting Bracket Moving End

2 parts, 1 left & 1 right with bore
Series 5050HD or R9850HD:
50500HD-1-SS

Part No. Mounting Bracket Fixed End

2 parts, 1 left & 1 right with pin
Series 5050HD or R9850HD:
50500HD-2-SS

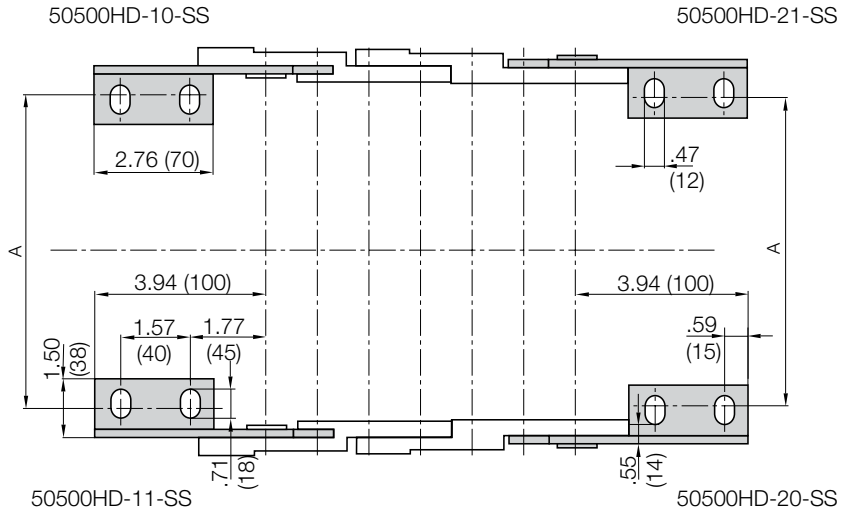

Bracket mounting dimensions

Width of Chain <i>Bi</i>	Part Number	Mounting Brackets			A in. (mm)	Width of Chain <i>Bi</i>	Part Number	Mounting Brackets			A in. (mm)
		Full Set	Moving End Only	Fixed End Only				Full Set	Moving End Only	Fixed End Only	
1.97 (50)	50500HD	-12	-1	-2	1.18 (30)	12.28 (312)	50500HD	-12	-1	-2	11.49 (292)
2.56 (65)	50500HD	-12	-1	-2	1.77 (45)	12.79 (325)	50500HD	-12	-1	-2	12.00 (305)
2.95 (75)	50500HD	-12	-1	-2	2.16 (55)	13.27 (337)	50500HD	-12	-1	-2	12.48 (317)
3.43 (87)	50500HD	-12	-1	-2	2.64 (67)	13.78 (350)	50500HD	-12	-1	-2	12.99 (330)
3.94 (100)	50500HD	-12	-1	-2	3.15 (80)	14.25 (362)	50500HD	-12	-1	-2	13.46 (342)
4.41 (112)	50500HD	-12	-1	-2	3.62 (92)	14.76 (375)	50500HD	-12	-1	-2	13.97 (355)
4.92 (125)	50500HD	-12	-1	-2	4.13 (105)	15.24 (387)	50500HD	-12	-1	-2	14.45 (367)
5.39 (137)	50500HD	-12	-1	-2	4.61 (117)	15.75 (400)	50500HD	-12	-1	-2	14.96 (380)
5.91 (150)	50500HD	-12	-1	-2	5.12 (130)	16.22 (412)	50500HD	-12	-1	-2	15.43 (392)
6.38 (162)	50500HD	-12	-1	-2	5.59 (142)	16.73 (425)	50500HD	-12	-1	-2	15.94 (405)
6.89 (175)	50500HD	-12	-1	-2	6.10 (155)	17.20 (437)	50500HD	-12	-1	-2	16.42 (417)
7.36 (187)	50500HD	-12	-1	-2	6.57 (167)	17.72 (450)	50500HD	-12	-1	-2	16.93 (430)
7.87 (200)	50500HD	-12	-1	-2	7.09 (180)	18.19 (462)	50500HD	-12	-1	-2	17.40 (442)
8.35 (212)	50500HD	-12	-1	-2	7.56 (192)	18.70 (475)	50500HD	-12	-1	-2	17.91 (455)
8.86 (225)	50500HD	-12	-1	-2	8.07 (205)	19.17 (487)	50500HD	-12	-1	-2	18.39 (467)
9.33 (237)	50500HD	-12	-1	-2	8.54 (217)	19.69 (500)	50500HD	-12	-1	-2	18.90 (480)
9.84 (250)	50500HD	-12	-1	-2	9.05 (230)	20.16 (512)	50500HD	-12	-1	-2	19.37 (492)
10.31 (262)	50500HD	-12	-1	-2	9.53 (242)	20.67 (525)	50500HD	-12	-1	-2	19.88 (505)
10.83 (275)	50500HD	-12	-1	-2	10.04 (255)	21.14 (537)	50500HD	-12	-1	-2	20.35 (517)
11.30 (287)	50500HD	-12	-1	-2	10.51 (267)	21.65 (550)	50500HD	-12	-1	-2	20.87 (530)
11.81 (300)	50500HD	-12	-1	-2	11.02 (280)	23.62 (600)	50500HD	-12	-1	-2	22.83 (580)

e-chain system® E4/4

Series 5050HD/R9850HD

Strain Relief



5050HD
R9850HD

Tiewrap plates as an individual part

Available as an individual component, can be fixed onto a mounting bracket with the use of a profile rail.



For more information please refer to strain relief section of Chapter 10

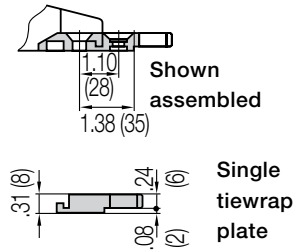
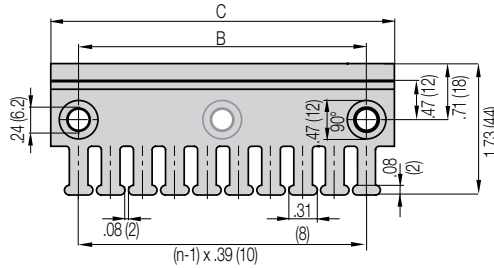

Tiewrap Plate	n Number of Teeth	C Overall Width in. (mm)	B Bore Width in. (mm)	Center Bore
3050-ZB	5	1.97 (50)	1.18 (30)	no
3075-ZB	7	2.95 (75)	2.16 (55)	no
3100-ZB	10	3.94 (100)	3.15 (80)	no
3115-ZB	11	4.53 (115)	3.74 (95)	no
3125-ZB	12	4.92 (125)	4.13 (105)	no
3150-ZB	15	5.91 (150)	5.12 (130)	no
3175-ZB	17	6.89 (175)	6.10 (155)	no
3200-ZB	20	7.87 (200)	7.09 (180)	yes
3225-ZB	22	8.86 (225)	8.07 (205)	yes
3250-ZB	25	9.84 (250)	9.06 (230)	yes

PDF: igus.com/e-chain-pdfs
Product information: igus.com/e-chains

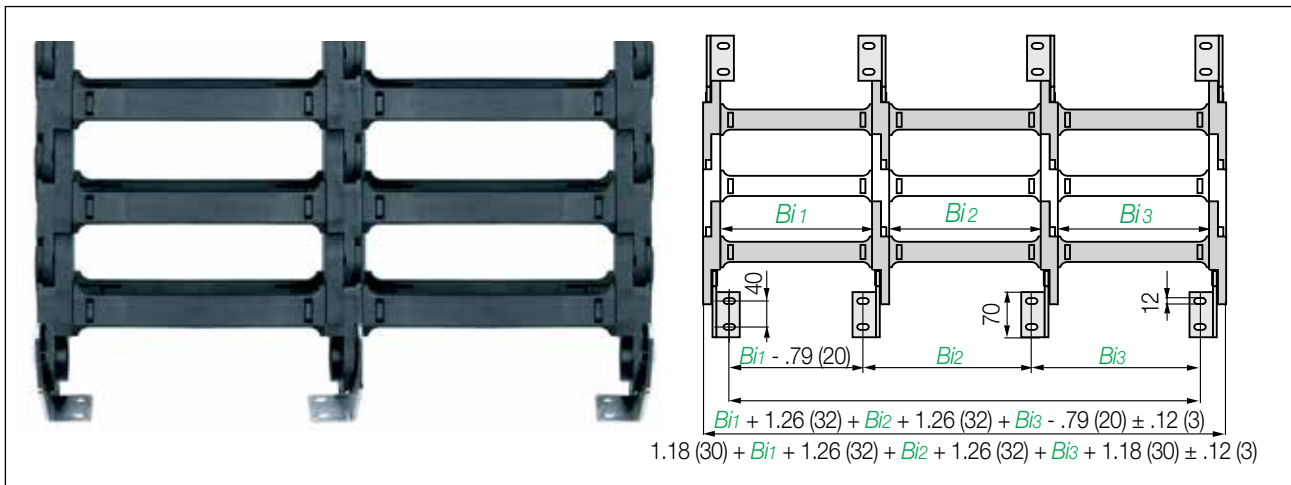

Extension links | For extremely wide e-chains® up to 9.84 ft. (3 m)

- Virtually unlimited side-by-side attachment when high fill weights necessitate extremely wide e-chains® (up to 118" (3,000mm))
- The unsupported length FL_g max. can be increased when high fill weights are required



Width of Crossbar
5050HD-05-200-0

	B_{Ri}	Installation Part No.
-05	4.13 (105)	96-50-225
-06	4.72 (120)	96-50-250
-07	5.12 (130)	96-50-250
-08	5.59 (142)	96-50-275
-10	6.10 (155)	96-50-275
-11	6.61 (168)	96-50-300
-12	7.09 (180)	96-50-300
-13	7.60 (193)	96-50-325
-15	8.07 (205)	96-50-325
-16	8.58 (218)	96-50-350
-17	9.06 (230)	96-50-350
-18	9.57 (243)	96-50-375
-20	10.04 (255)	96-50-375
-21	10.55 (268)	96-50-400
-22	11.02 (280)	96-50-400
-23	11.54 (293)	96-50-425
-25	12.01 (305)	96-50-425
-26	12.52 (318)	96-50-450
-27	12.99 (330)	96-50-450
-28	13.50 (343)	96-50-475
-30	13.98 (355)	96-50-475
-31	14.49 (368)	96-50-500
-32	14.96 (380)	96-50-500
-33	15.47 (393)	96-50-525
-35	15.94 (405)	96-50-525
-36	16.46 (418)	96-50-550
-37	16.93 (430)	96-50-550
-38	17.44 (443)	96-50-575
-40	17.91 (455)	96-50-575
-41	18.43 (468)	96-50-600
-42	18.90 (480)	96-50-600
-43	19.41 (493)	96-50-625
-45	19.88 (505)	96-50-625
-46	20.39 (518)	96-50-650
-47	20.87 (530)	96-50-650
-48	21.38 (543)	96-50-675
-50	21.85 (555)	96-50-675
-51	22.36 (568)	96-50-700
-52	22.83 (580)	96-50-700
-53	23.35 (593)	96-50-725
-55	23.82 (605)	96-50-725
-60	25.79 (655)	96-50-775

Guide troughs are used with applications where the upper run of the e-chain® glides on the lower run. If using igus® steel guide troughs, the following components are required:

- Full travel length of guide trough
Part No. 99-30
- 1/2 travel length glide bars
Part No. 93-01
- Installation sets as end connectors
Part No. 96-50-XX

-XX indicates the length of the profile rails on which the guide trough is mounted. The values and part numbers are specified in the table on the right. The standard length of the trough components and glide bars is 6.56 ft (2 m). The overall length of the guide trough directly correlates to the length of travel.

Example:

Length of travel 164 ft (50 m)
Center-mounted

Required guide troughs:

164 ft (50 m) guide trough, 82 ft. (25 m) glide bar
= 25 sections of 6.56 ft (2 m) guide trough

Part No. 99-30

= 13 sections of 6.56 ft (2 m) glide bar

Part No. 93-01

Required number of installation set:

= Number of guide trough components + 1
= 25 + 1 = 26

Part No. of the installation sets **96-50-XXX**

Example: 96-50-400 for 15.75 (400 mm) long profile rail



Left: Guide trough with glide bars
Right: Guide troughs without glide bars



Installation sets as section connectors

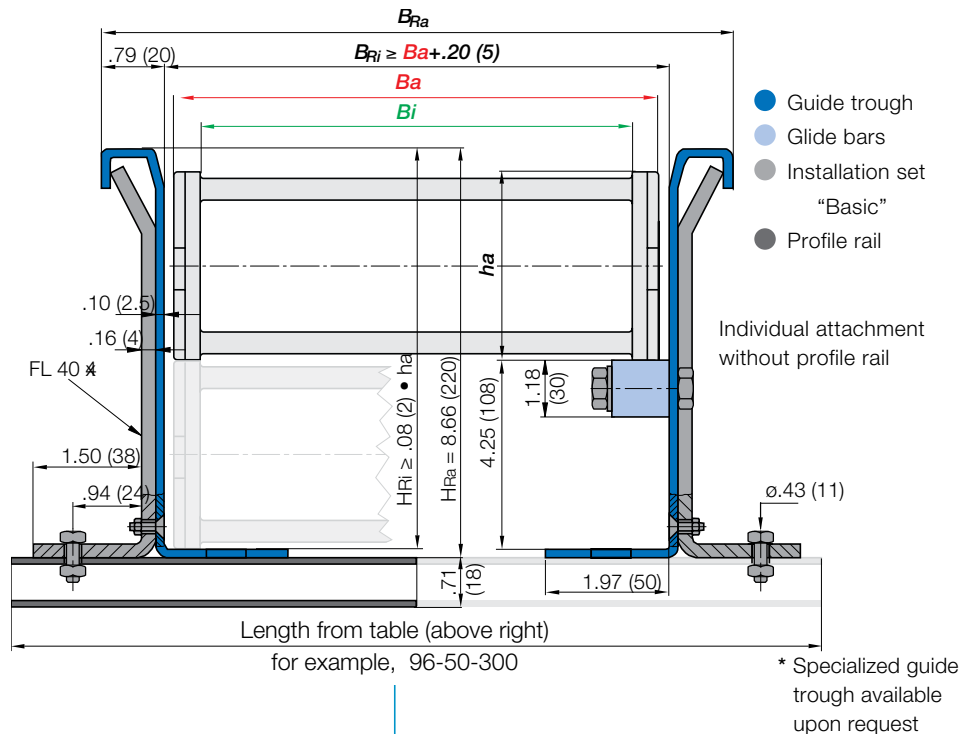

Standard length profile rail

For further technical information on guide troughs
► Chapter 9

PDF: igus.com/e-chain-pdfs
Product information: igus.com/e-chains





igus

P4.42R.04

P4.42R.04

igus

igus

igus

P4

Reduce energy consumption by up to 57% - with profile-rol e-chain®



Advantages of P4:

- Reduce energy consumption by up to 57% - P4 profile-rol e-chain system®
- Safe, low-noise, abrasion-resistant energy supply system for long travels
- Long travels up to 2,625 ft. (800m) and more, high fill weights up to 20.16 lbs/ft. (30kg/m)
- For very long travels and high travel speeds up to 32.8 ft. (10m/s)
- Identical pitch of the e-chain® link with or without roller
- Extremely quiet - considerable reduction of operating noise
- autoglide crossbars for safe guidance
- P4 modular system with interior separation for the system E4-1



When to use another e-chain® series:

- For very high fill weights for long travels
 - ▶ **E4/4HD heavy-duty**
- When you want a strong rol e-chain® requiring 75% less drive power
 - ▶ **E4/4 rol e-chain®**
- When you want a self-guiding e-chain system® without any guide troughs
 - ▶ **autoglide**

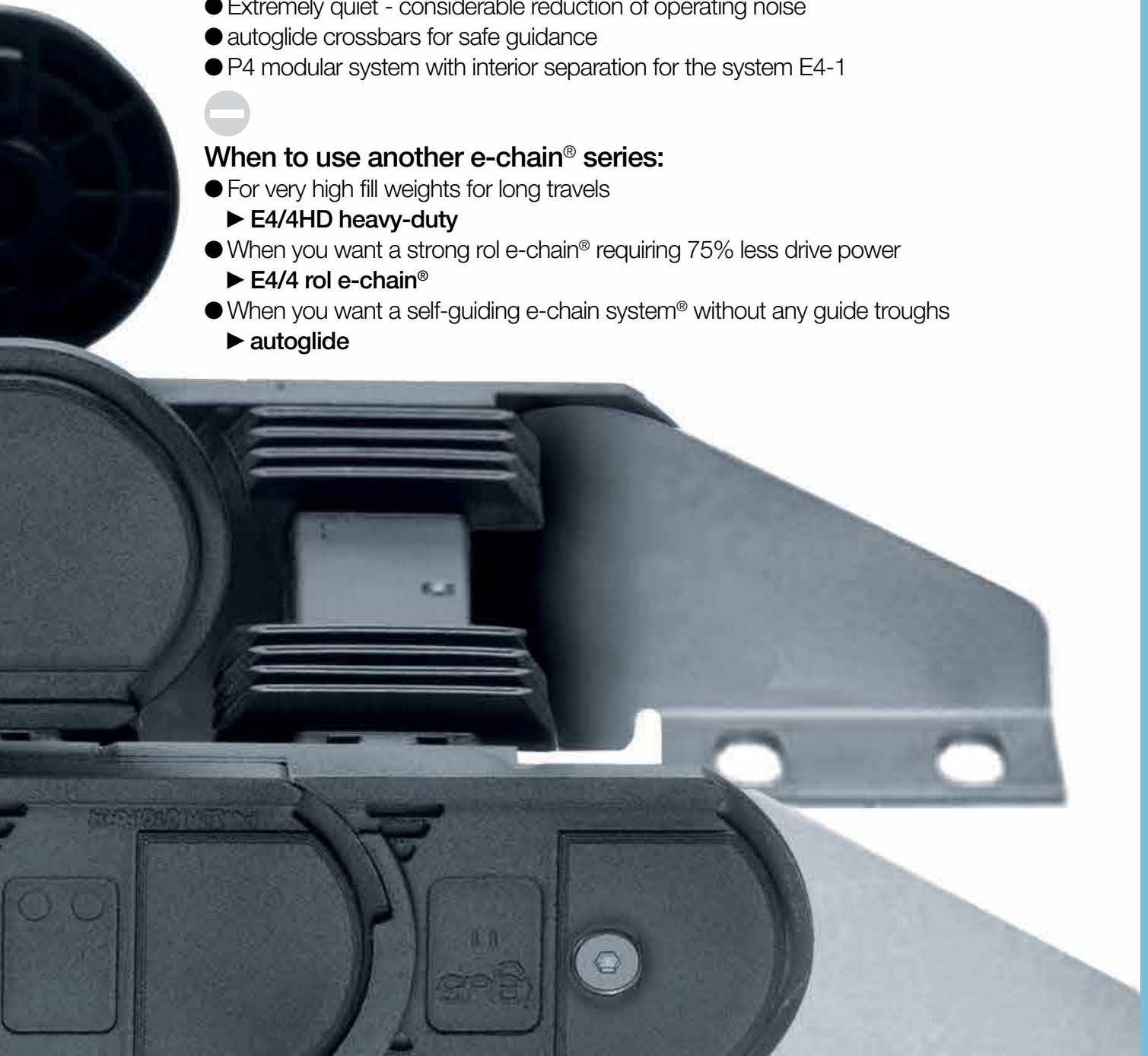

Special solutions for long travel System P4 - Profile rol e-chain®

For very long travels, speed up to 32.8 f/s (10 m/s)

Low vibration:
Offset operation of upper
and lower run

Low maintenance:
Tribo-optimized plastic
rollers

Low noise:
Special roller- /
e-chain® links -design

Secure guidance:
comb style autoglide
crossbars

Robust:
Steel mounting brackets

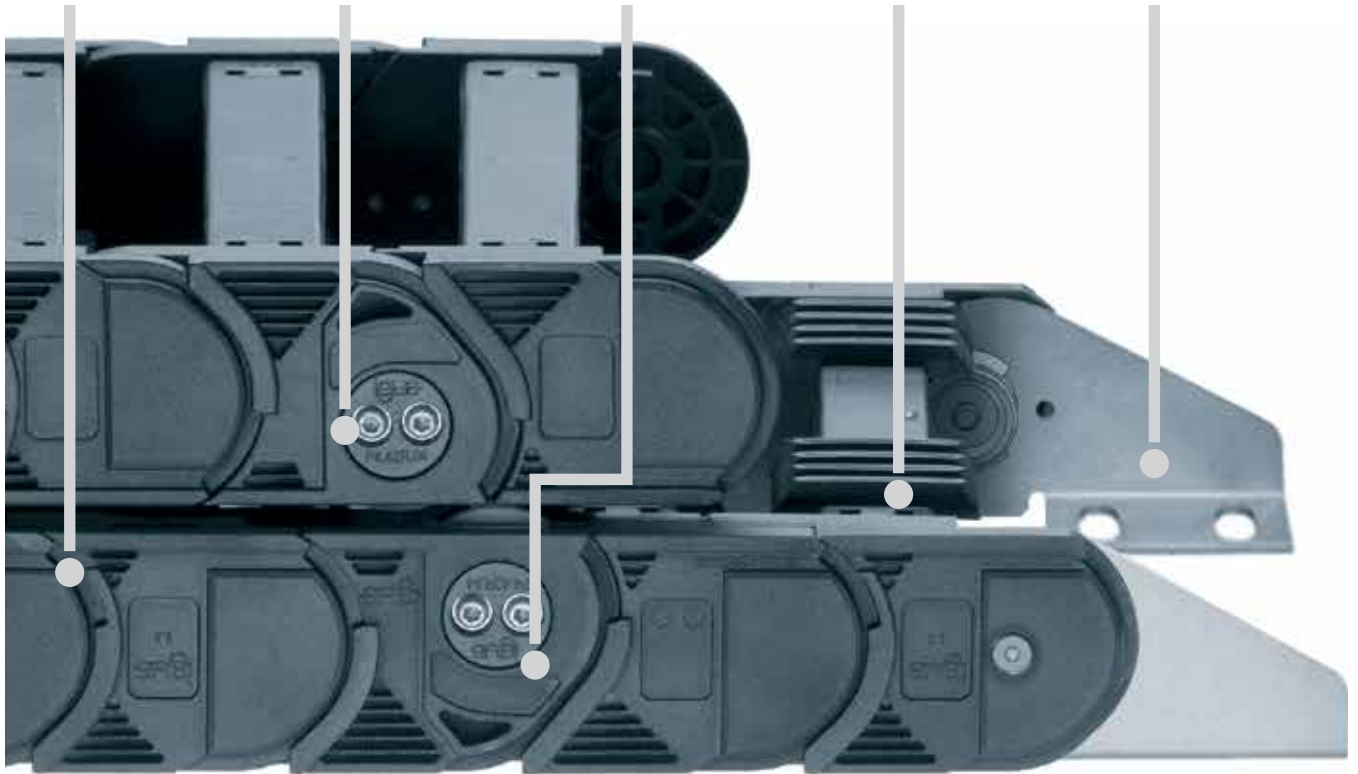

57% less energy consumption - System P4, profile rol e-chain®

Safe, low-noise, abrasion-resistant energy supply system on long travels up to 2,625 ft. (800 m) and more

Standard rol e-chain® has been used in over 1000 installations worldwide. Some industries - cranes, for example - have ever-increasing demands for length of travel, fill weight and speed. **Systems of this type should be designed by our system design engineers. We will be more than willing to submit an offer to you. Please contact us about this.**

- Identical pitch of the chain link with or without roller
- Smooth, low noise operation through identical pitch length for links with and without rollers
- Integrated "captive" roller in the side part
- Long travels (up to 2,625 ft. (800 m), high additional loads up to 20.2 lbs/ ft (30 kg/m)
- For very long travels and high speeds >32.8 ft/s (10 m/s) travel speed
- autoglide crossbars provide for a safe guiding in very long travels
- 4 different inner heights: 1.26" (32mm), 1.65" (42mm), 2.20" (56mm), 3.15" (80 mm) available
- Large modular tool box system with interior separations of the System E4

Typical industries and applications

- Cranes
- Warehousing
- Equipment manufacturing
- Gantry robots
- Material handling



iF product design award
2007 igus® System P4

2007 ■

Special solutions for long travel System P4 - Profile rol e-chain® Efficiency



Energy efficient polymer e-chains® and cables reduce consumption by up to 57%

With the right materials and clever design, the energy consumption can be drastically reduced, as now proven by current tests and sample calculations in the e-chain® and cable laboratory at igus®. igus® e-chains® and chainflex® cables reduce the required drive power and extend the application's service life.

Better cables, stronger and rolling e-chains®	System P4 -57%	
Rolling instead of gliding	rol e-chain® -37%	
Stronger e-chains®	E4-1 -17%	
Optimized cables	chainflex® -17%	
Gliding application	Standard 100%	

System P4



chainflex®



= 57%

Saving

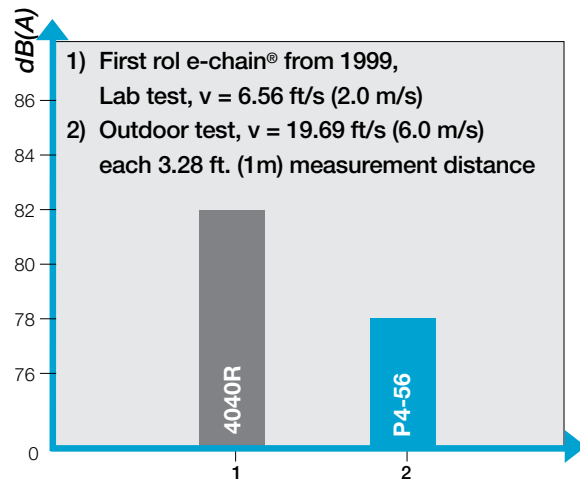
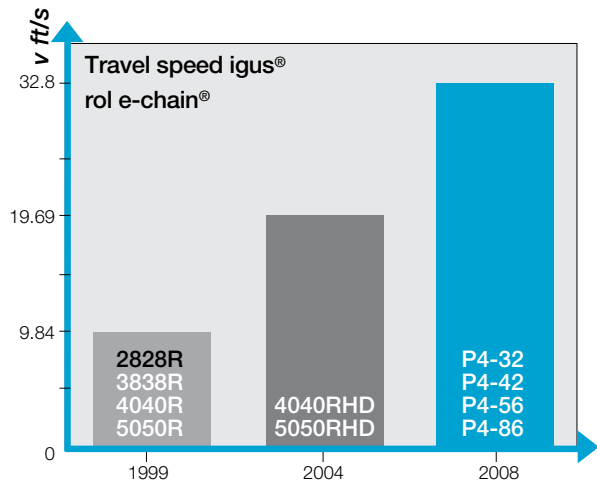

**System P4 -
 Profile rol e-chain®**
 Safe, low noise, abrasion-
 resistant on long travels



Series	Inner height <i>hi</i> in. (mm)	Inner width <i>Bi</i> in. (mm)	Outer width <i>Ba</i> in. (mm)	Outer height <i>ha</i> in. (mm)	Bending radius <i>R</i> in. (mm)	Maximum Travel ft. (m)
P4-32	1.26 (32)	3.94-7.87 (100-200)	5.20-9.13 (132-232)	2.13 (54)	5.91-9.84 (150-250)	1,641 (500)
P4-42	1.65 (42)	3.94-7.87 (100-200)	6.06-10.00 (154-254)	2.52 (64)	3.94-13.78 (100-350)	1,969 (600)
P4-56	2.20 (56)	7.36-15.75 (187-400)	10.12-18.50 (257-470)	3.31 (84)	9.84-13.78 (250-350)	2,625 (800)
P4-80	3.15 (80)	7.36-15.75 (187-400)	10.35-18.74 (263-476)	4.25 (108)	9.84-13.78 (250-350)	2,625 (800)



Optimized interior separation program, cables last up to 4 times longer

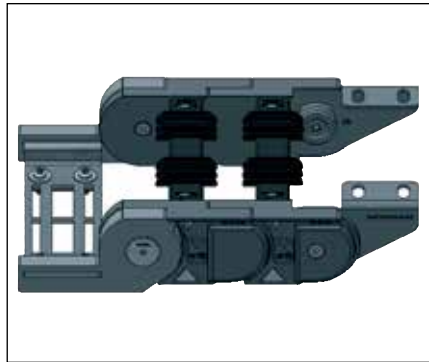

Robust pivoting mounting brackets available

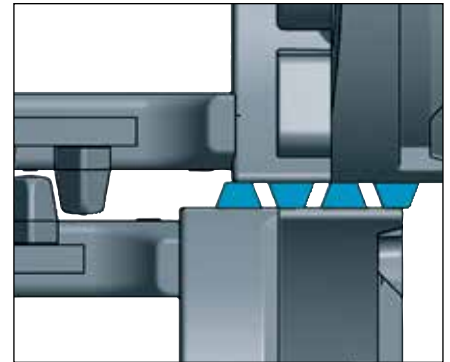

Offset operation of upper and lower run, resulting in continuous roll-through surface



- Extension link for heavy fill weights
- 2 inner heights available (56, 80 mm)
- 50% higher fill weight possible
- Maximum rigidity
- Divides cross section into compartments (electric/hydraulic)



- Tribo-optimized plastic rollers for all P4 systems
- Wear optimized
- Long cycle life
- Improved rolling
- Lower noise and vibration
- Same pitch for roller links / e-chain® links



- Aluminum guide trough system
- Special geometry in combination with autoglide cross bars allows for offset upper and lower run
- Strong installation kits for long cycle life
- Aluminum trough segments resist corrosion

Special solutions for long travel
System P4 - Profile rol e-chain®



igus® P4 rol e-chain® in suitable aluminum SuperTrough. High speeds, longest travels, smooth running - thereby longest lifetime

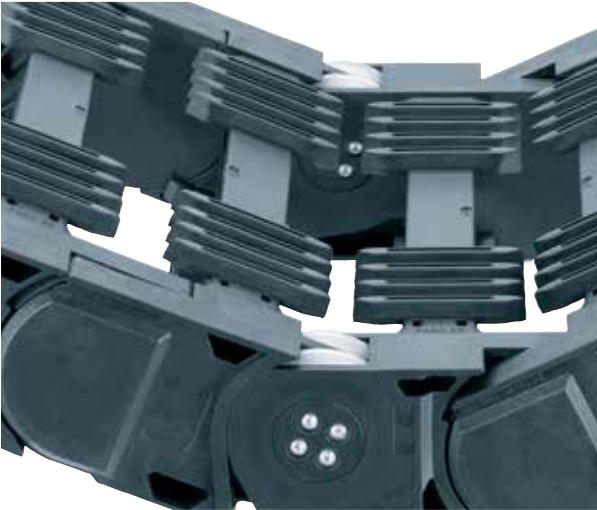

System P4 - Very quiet operation through identical pitch of all chain links. autoglide crossbars offer a safe guidance in very long travels

P4-32 - openable along both radii, crossbars every link - comb style autoglide crossbars



P4-32 crossbars every link

Telephone 1-800-521-2747

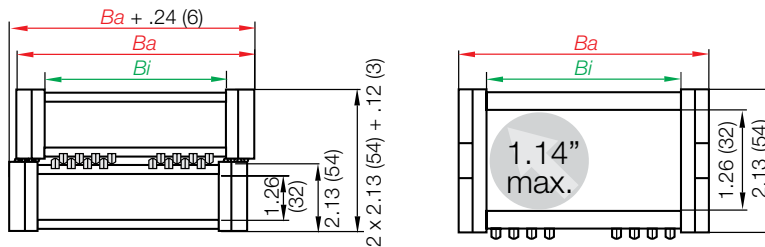

Part Number Structure

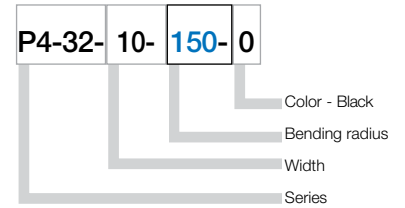

Part Number	<i>Bi</i> in. (mm)	<i>Ba</i> in. (mm)	Weight lbs/ft (kg/m)
P4-32-10- <input type="text"/> -0	3.94 (100)	5.20 (132)	≈ 1.82 (2.71)
P4-32-15- <input type="text"/> -0	5.91 (150)	7.17 (182)	≈ 2.04 (3.04)
P4-32-20- <input type="text"/> -0	7.87 (200)	9.13 (232)	≈ 2.24 (3.34)

Choose from the radii below for all of the above sizes
 Radius (mm) Example: P4-32-20- -0

	<input type="text"/> 150	<input type="text"/> 200	<input type="text"/> 250
R	5.91 (150)	7.87 (200)	9.84 (250)
H₂	4.92 (125)	4.92 (125)	4.92 (125)
D₂	29.92 (760)	39.96 (1015)	55.12 (1400)
K	48.50 (1232)	63.94 (1624)	81.57 (2072)

The bending radii 075 100 125 300 are available upon request.
 Please contact technical sales for approximate delivery times.

Note: We recommend contacting our technical experts when planning your P4 application.
 For distances below 32.8 ft. (10 m) we recommend a self-supporting e-chain®.

Additional Features



Interior separation available
 ➤ Series E4-32



Robust steel mounting brackets
 available ➤ Upon request



Special P4 guide trough system
 available ➤ Upon request

Special solutions for long travel

System P4 - rol e-chain® - Series P4-32

Installation Dimensions



P4-32

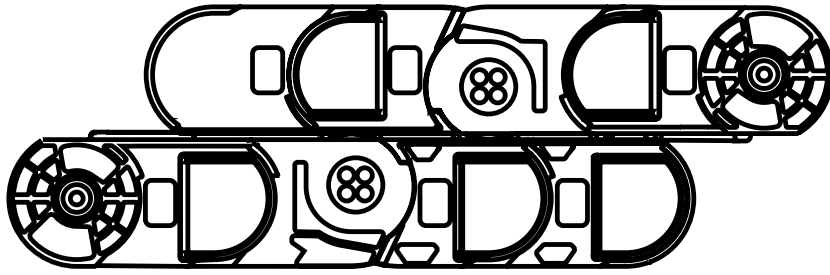

Legend

- S = Length of travel
- R = Bending radius
- H = Mounting height
- D = Overlength - long travels, gliding
- K = Add-on
- H_{in} = Trough inner height

The required clearance height: $H_r = H + 1.57$ in. (40 mm) with 4.03 lbs/ft (6 kg/m) fill weight. Please consult igus® if space is particularly restricted.

Sliding applications

Long travel lengths up to 1,641 ft. (500 m)

In case of travels below 32.8 ft. (10m) we recommend a self-supporting e-chain®.

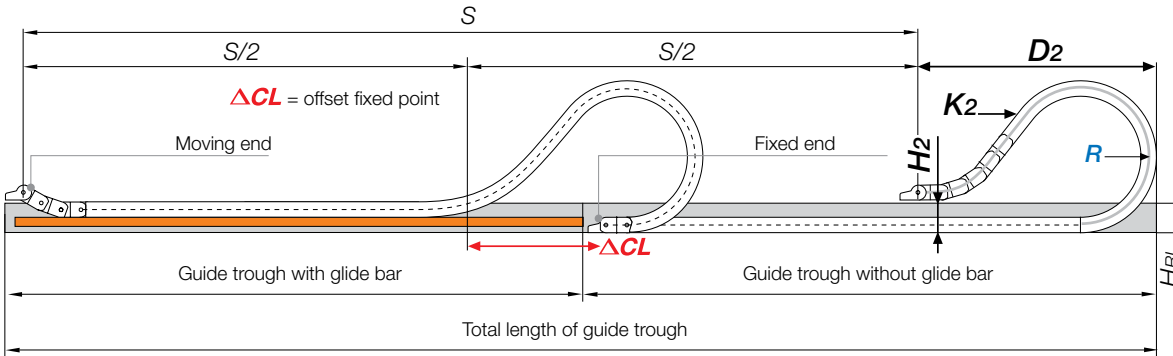

R	5.91 (150)	7.87 (200)	9.84 (250)
H	4.92 (125)	4.92 (125)	4.92 (125)
D	29.92 (760)	39.96 (1015)	55.12 (1400)
K	48.50 (1232)	63.94 (1624)	81.57 (2072)
ΔCL	14.80 (376)	23.46 (596)	32.87 (835)

Pitch per link: = 2.20" (56 mm)
 Links per ft (m): = 5.49 (18)
 Chain length: = $\frac{S}{2} + K$

PDF: igus.com/e-chain-pdfs
 Product information: igus.com/e-chains

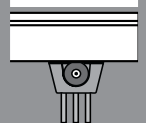
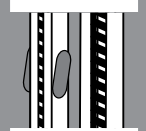
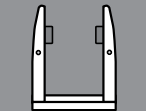
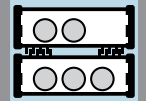

Long travels	from 32.8 ft. (10 m) up to max. 1,641 ft. (500 m)
Speed max. rolling / acceleration max. rolling	max. 32.8 ft/s (10 m/s) / max. 164 ft/s ² (50 m/s ²)
Fill weight	max. 4.03 lbs/ft. (6 kg/m)
Material - permitted temperature	igumid G / -40°F (-40°C) up to +248°F (+120°C)
Flammability Class, igumid G	VDE 0304 IIC UL94 HB

Technical Data



Details of material properties

► Chapter 1

9.118

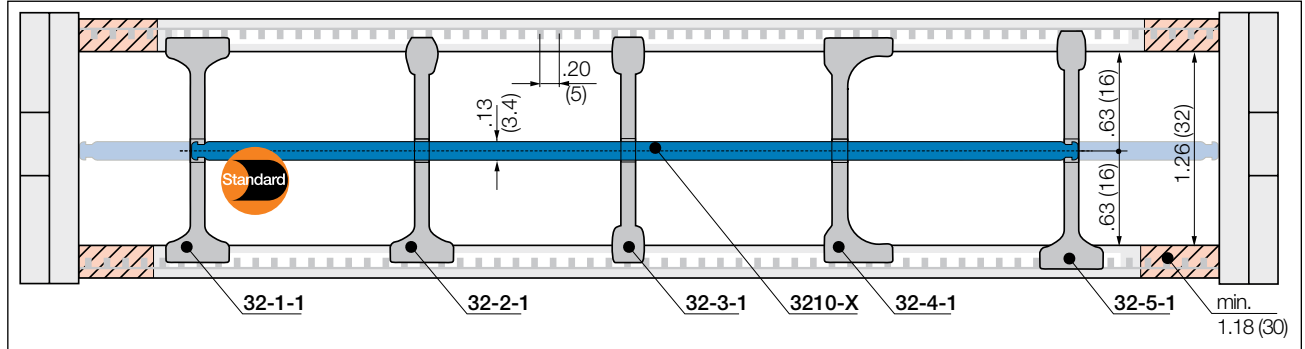

Note E-Tube: Please maintain a lateral spacing of 1.18" (30 mm) between the separators and the side links. In the standard configuration separators are assembled every 2nd e-chain® link

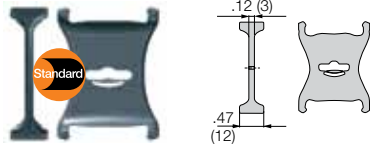

Separator, wide base

Unassembled **Part No. 32-1**

Assembled **Part No. 32-1-1**

- **Standard separator 32-1 for all applications**

Separator with wide base for maximum locking strength and safe standing in e-chains®.

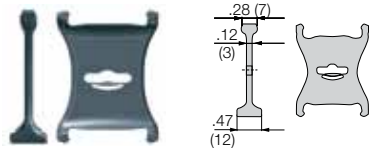

Separator, narrow head

Unassembled **Part No. 32-2**

Assembled **Part No. 32-2-1**

- **Separator 32-2 For even faster installation**

is used when vertical and horizontal separation is required. Due to its slot, it allows basic vertical/horizontal shelving arrangements.

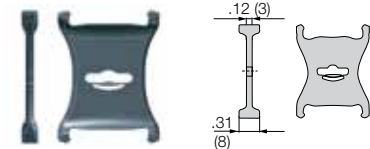

Separator, narrow base

Unassembled **Part No. 32-3**

Assembled **Part No. 32-3-1**

- **Separator 32-3 For many thin cables**

is used when vertical and horizontal separation is required. Due to its slot, it allows basic vertical/horizontal shelving arrangements.

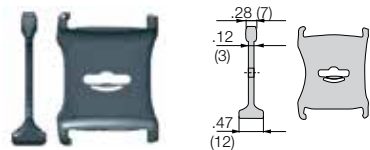

Separator, asymmetrical

Unassembled **Part No. 32-5**

Assembled **Part No. 32-5-1**

- **Separator 32-5 Locks safely in .20" (5 mm) increments**

Notch separator for exact positioning in e-chains®. Recommended for side-mounted applications.

Lockable full-width shelves - for the standard interior separation

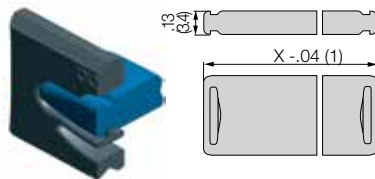

Full width shelf, lockable

Unassembled **Part No. 3200-X**

Assembled **Part No. 3210-X**

- **Full width shelf, lockable**

Shelf locks safely into separators on both ends, fixed width possible. Separators can be moved freely over the shelf in horizontal direction. Can be used at one height.

Width X in. (mm)	Part No. Unassembled	Part No. Assembled	Width X in. (mm)	Part No. Unassembled	Part No. Assembled	Width X in. (mm)	Part No. Unassembled	Part No. Assembled
1.97 (050)	3200-050	3210-050	4.92 (125)	3200-125	3210-125	8.86 (225)	3200-225	3210-225
2.95 (075)	3200-075	3210-075	5.91 (150)	3200-150	3210-150	9.84 (250)	3200-250	3210-250
3.94 (100)	3200-100	3210-100	6.89 (175)	3200-175	3210-175			
4.53 (115)	3200-115	3210-115	7.87 (200)	3200-200	3210-200			

Special solutions for long travel

System P4 - rol e-chain® - Series P4-32

Installation Dimensions

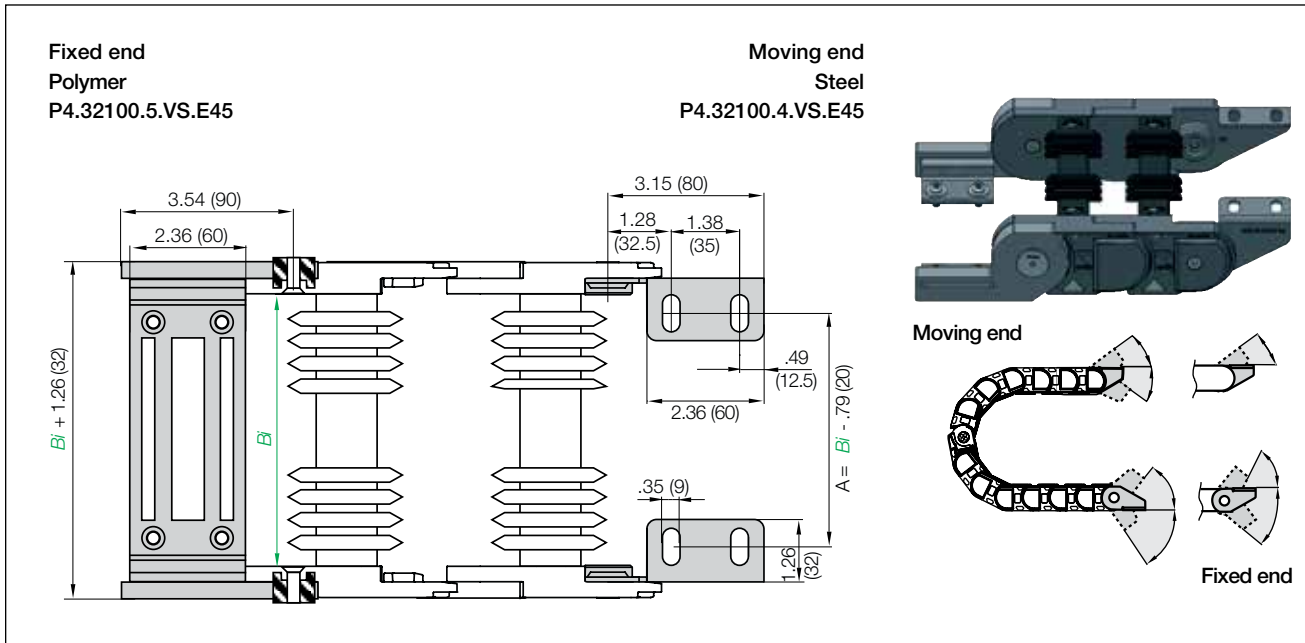

Mounting brackets pivoting - Recommended for rolling applications on long travels

Width Index	Part No. full set for Fixed end and moving end	<i>Bi</i> in. (mm)	Dim. A in. (mm)
10- ▶	P4-32100-54-10-VS-E45	3.94 (100)	3.15 (80)
15- ▶	P4-32100-54-15-VS-E45	5.91 (150)	5.12 (130)
20- ▶	P4-32100-54-20-VS-E45	7.87 (200)	7.09 (180)

The mounting brackets for P4 e-chains® consist of a steel mounting bracket at the moving end and a polymer mounting bracket at the fixed end. This ensure that the rollers move over a plain surface at the fixed end.

Strain relief, clamps, tiwrap plates, and clip-on solutions are available from stock.

For the complete Chainfix range refer to ▶ Chapter 10

PDF: igus.com/e-chain-pdfs
 Product information: igus.com/e-chains

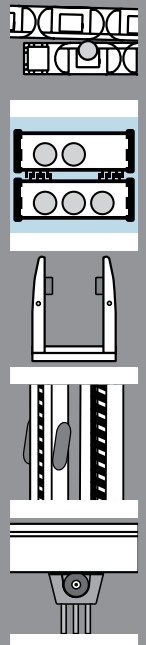

P4-42 - openable along both radii, crossbars every link - comb style autoglide crossbars

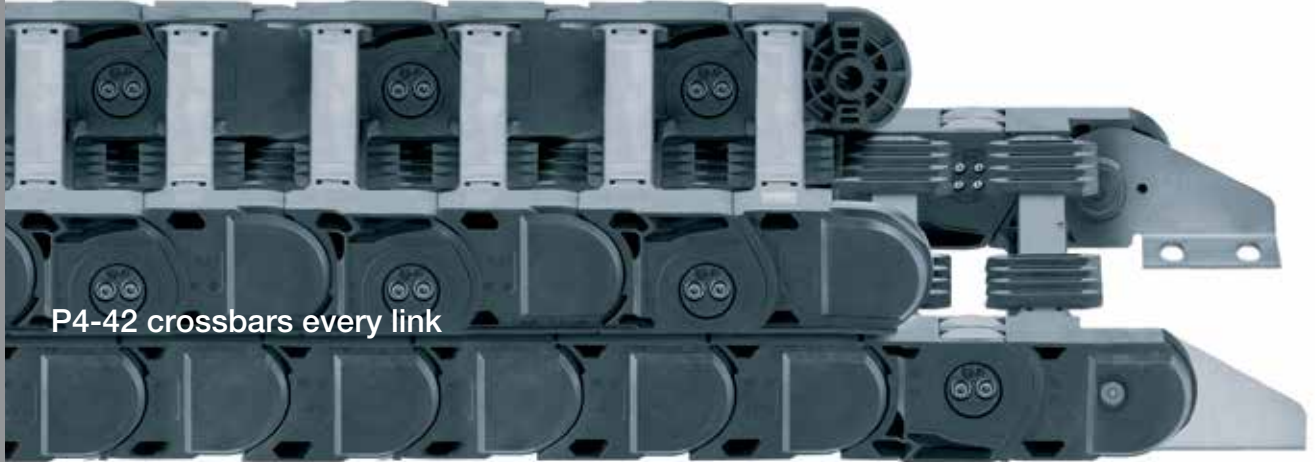

P4-42 crossbars every link

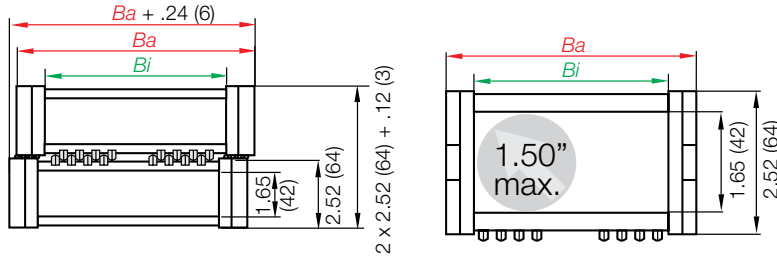

Part Number Structure

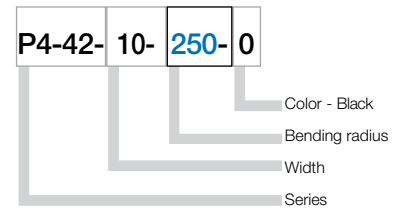

Part Number	Bi in. (mm)	Ba in. (mm)	Weight lbs/ft (kg/m)
P4-42-10-□-0	3.94 (100)	6.06 (154)	≈ 1.82 (2.71)
P4-42-15-□-0	5.91 (150)	8.03 (204)	≈ 2.04 (3.04)
P4-42-20-□-0	7.87 (200)	10.00 (254)	≈ 2.24 (3.34)

Choose from the radii below for all of the above sizes
Radius (mm) Example: P4-42-20-250-0

	100	125	150	200	250	300	350
R	3.94 (100)	4.92 (125)	5.91 (150)	7.87 (200)	9.84 (250)	11.81 (300)	13.78 (350)
H.	5.51 (140)	5.51 (140)	5.51 (140)	5.51 (140)	5.51 (140)	5.51 (140)	5.51 (140)
D.	20.47 (520)	30.91 (785)	37.01 (940)	50.39 (1280)	63.78 (1620)	77.17 (1960)	89.17 (2265)
K.	36.61 (930)	47.48 (1206)	55.39 (1407)	73.86 (1876)	92.32 (2345)	110.79 (2814)	126.61 (3216)

Note: We recommend contacting our technical experts when planning your P4 application.
For distances below 32.8 ft. (10 m) we recommend a self-supporting e-chain®.

Additional Features



Interior separation available
► Series E4-42



Robust steel mounting brackets
available ► Upon request



Special P4 guide trough system
available ► Upon request

Special solutions for long travel

System P4 - rol e-chain® - Series P4-42

Installation Dimensions



P4-42

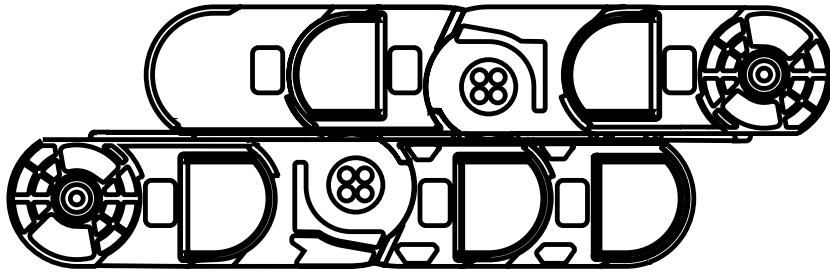

Legend

- S = Length of travel
- R = Bending radius
- H = Mounting height
- D = Overlength - long travels, gliding
- K = Add-on
- H_{ri} = Trough inner height

The required clearance height: $H_r = H + 1.57$ in. (40 mm) with 4.70 lbs/ft (7 kg/m) fill weight. Please consult igus® if space is particularly restricted.

Sliding applications

Long travel lengths up to 1,969 ft. (600 m)

In case of travels less than 32.8 ft. (10m) we recommend an self-supporting e-chain®.

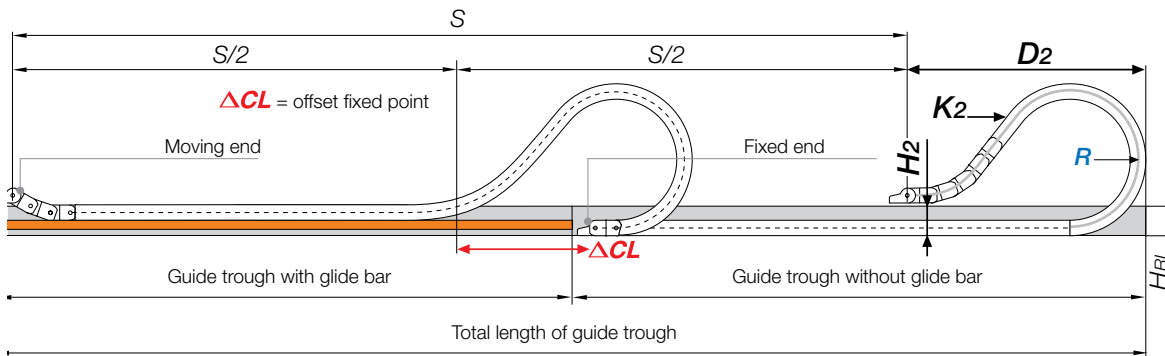

Pitch per link: = 2.64" (67 mm)
 Links per ft (m): = 4.57 (15)
 Chain length: = $\frac{S}{2} + K_2$

R	3.94 (100)	4.92 (125)	5.91 (150)	7.87 (200)	9.84 (250)	11.81 (300)	13.78 (350)
H _i	5.51 (140)	5.51 (140)	5.51 (140)	5.51 (140)	5.51 (140)	5.51 (140)	5.51 (140)
D	20.47 (520)	30.91 (785)	37.01 (940)	50.39 (1280)	63.78 (1620)	77.17 (1960)	89.17 (2265)
K	36.61 (930)	47.48 (1206)	55.39 (1407)	73.86 (1876)	92.32 (2345)	110.79 (2814)	126.61 (3216)
ΔCL	7.68 (195)	130.19 (335)	18.50 (470)	30.12 (765)	41.14 (1045)	52.36 (1330)	63.58 (1615)

PDF: igus.com/e-chain-pdfs
 Product information: igus.com/e-chains

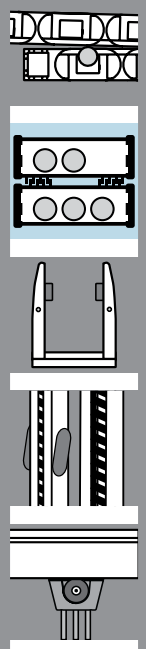

Long travels	from 32.8 ft. (10 m) up to max. 1,969 ft. (600 m)
Speed max. rolling / acceleration max. rolling	max. 32.8 ft/s (10 m/s) / max. 164 ft/s ² (50 m/s ²)
Fill weight	max. 4.70 lbs/ft. (7 kg/m)
Material - permitted temperature	igumid G / -40°F (-40°C) up to +248°F (+120°C)
Flammability Class, igumid G	VDE 0304 IIC UL94 HB

Technical Data



Details of material properties

► Chapter 1

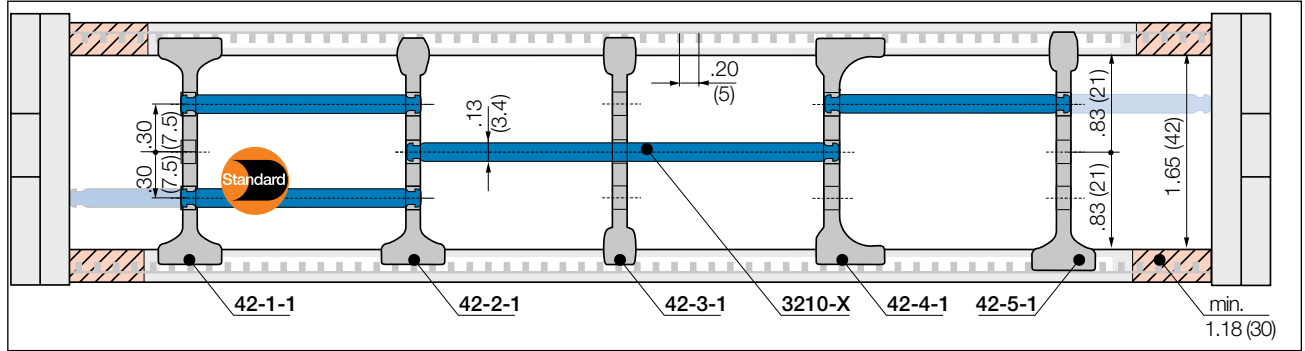

Note E-Tube: Please maintain a lateral spacing of 1.18" (30 mm) between the separators and the side links. In the standard configuration separators are assembled every 2nd e-chain® link

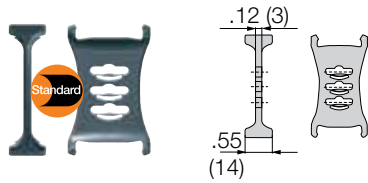

Separator, wide base

Unassembled	Part No. 42-1
Assembled	Part No. 42-1-1

- **Standard separator 42-1 for all applications**

Separator with wide base for maximum locking strength and safe standing in e-chains®.

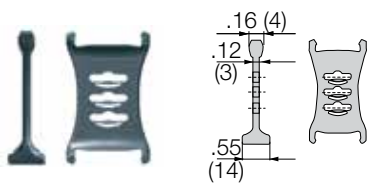

Separator, narrow head

Unassembled	Part No. 42-2
Assembled	Part No. 42-2-1

- **Separator 42-2 For even faster installation**

is used when vertical and horizontal separation is required. Due to its slot, it allows basic vertical/horizontal shelving arrangements.

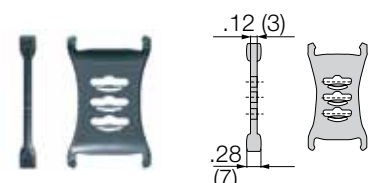

Separator, narrow base

Unassembled	Part No. 42-3
Assembled	Part No. 42-3-1

- **Separator 42-3 For many thin cables**

is used when vertical and horizontal separation is required. Due to its slot, it allows basic vertical/horizontal shelving arrangements.

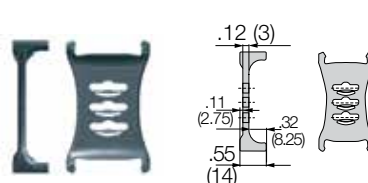

Separator, asymmetrical

Unassembled	Part No. 42-4
Assembled	Part No. 42-4-1

- **Separator 42-4 For side mounted applications**

is used when vertical and horizontal separation is required. Due to its slot, it allows basic vertical/horizontal shelving arrangements.

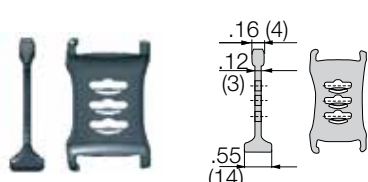

Separator, asymmetrical

Unassembled	Part No. 42-5
Assembled	Part No. 42-5-1

- **Separator 42-5 Locks safely in .30" (7.5 mm) increments**

Notch separator for exact positioning in e-chains®. Recommended for side-mounted applications.

Lockable full-width shelves - for the standard interior separation

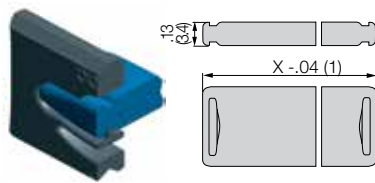

Full width shelf, lockable

Unassembled	Part No. 3200-X
Assembled	Part No. 3210-X

- **Full width shelf, lockable**

Shelf locks safely into separators on both ends, fixed width possible. Separators can be moved freely over the shelf in horizontal direction. Can be used at one height.

Width X in. (mm)	Part No. Unassembled	Part No. Assembled	Width X in. (mm)	Part No. Unassembled	Part No. Assembled	Width X in. (mm)	Part No. Unassembled	Part No. Assembled
1.97 (050)	3200-050	3210-050	4.92 (125)	3200-125	3210-125	8.86 (225)	3200-225	3210-225
2.95 (075)	3200-075	3210-075	5.91 (150)	3200-150	3210-150	9.84 (250)	3200-250	3210-250
3.94 (100)	3200-100	3210-100	6.89 (175)	3200-175	3210-175			
4.53 (115)	3200-115	3210-115	7.87 (200)	3200-200	3210-200			

Special solutions for long travel
 System P4 - rol e-chain® - Series P4-42
 Installation Dimensions

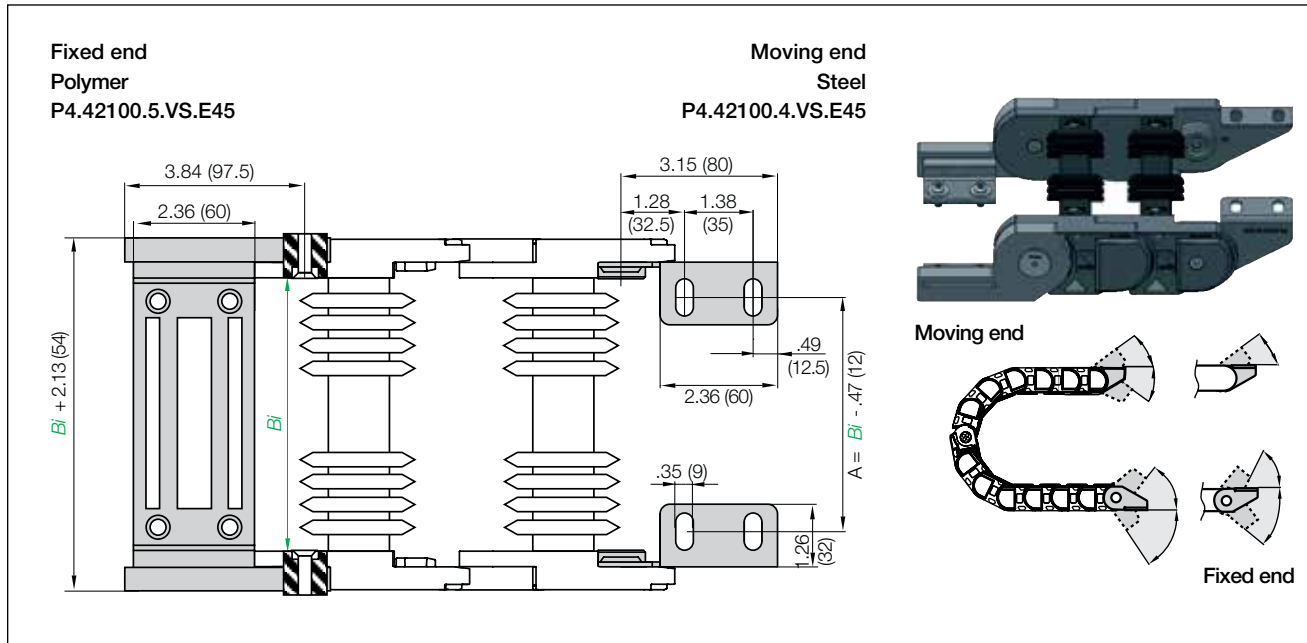

Mounting brackets pivoting - Recommended for rolling applications on long travels

Width Index	Part No. full set for Fixed end and moving end	B_i in. (mm)	Dim. A in. (mm)
10- ▶	P4-42100-54-10-VS-E45	3.94 (100)	3.15 (80)
15- ▶	P4-42100-54-15-VS-E45	5.91 (150)	5.12 (130)
20- ▶	P4-42100-54-20-VS-E45	7.87 (200)	7.09 (180)

The mounting brackets for P4 e-chains® consist of a steel mounting bracket at the moving end and a polymer mounting bracket at the fixed end. This ensure that the rollers move over a plain surface at the fixed end.

Strain relief, clamps, tiwrap plates, and clip-on solutions are available from stock.

For the complete Chainfix range refer to ▶ Chapter 10

PDF: igus.com/e-chain-pdfs
 Product information: igus.com/e-chains

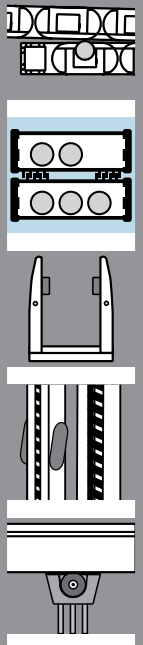

P4-56 - openable along both radii, crossbars every link - comb style autoglide crossbars



P4-56 crossbars every link

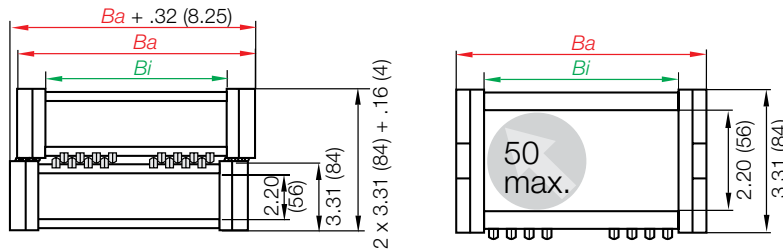

Part Number Structure

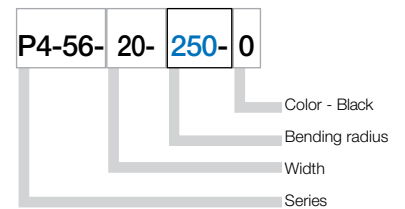

Part Number	Bi in. (mm)	Ba in. (mm)	Weight lbs/ft (kg/m)
P4-56-18- [] -0	7.36 (187)	9.84 (250)	≈ 4.52 (6.72)
P4-56-20- [] -0	7.87 (200)	10.63 (270)	≈ 4.72 (7.03)
P4-56-25- [] -0	9.84 (250)	12.60 (320)	≈ 4.97 (7.39)
P4-56-30- [] -0	11.81 (300)	14.57 (370)	≈ 5.23 (7.79)
P4-56-35- [] -0	13.78 (350)	16.54 (420)	≈ 5.45 (8.11)
P4-56-40- [] -0	15.75 (400)	18.50 (470)	≈ 5.71 (8.50)

Choose from the radii below for all of the above sizes

Radius (mm) Example: P4-56-20-250-0

	200	250	300	350
R	7.87 (200)	9.84 (250)	11.81 (300)	13.78 (350)
H	7.09 (180)	7.09 (180)	7.09 (180)	7.09 (180)
D	44.88 (1140)	57.87 (1470)	66.93 (1700)	76.77 (1950)
K	71.65 (1820)	89.57 (2275)	103.90 (2639)	118.23 (3003)

The bending radii 150 400 450 500 are available upon request. Please contact technical sales for approximate delivery times.

Note: We recommend contacting our technical experts when planning your P4 application. For distances below 32.8 ft. (10 m) we recommend a self-supporting e-chain®.

Additional Features

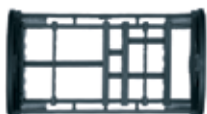

Interior separation available
► Series E4-56



Robust steel mounting brackets available ► Upon request



Special P4 guide trough system available ► Upon request



Extension link for heavy fill weights available ► upon request

Special solutions for long travel

System P4 - rol e-chain® - Series P4-56

Installation Dimensions



P4-56

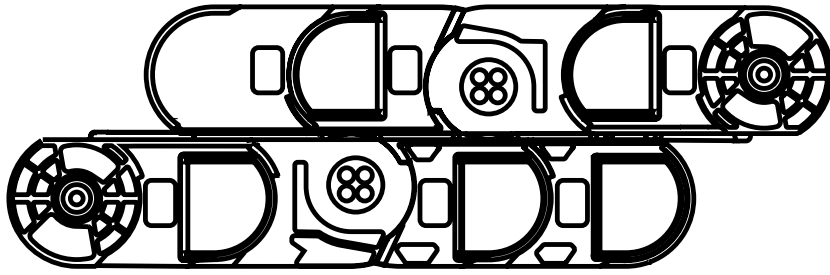

Legend

- S = Length of travel
- R = Bending radius
- H = Mounting height
- D = Overlength - long travels, gliding
- K = Add-on
- H_{in} = Trough inner height

The required clearance height: $H_r = H + 1.97$ in. (50 mm) with 8.74 lbs/ft (13 kg/m) fill weight. Please consult igus® if space is particularly restricted.

Sliding applications

Long travel lengths up to 2,625 ft. (800 m)

In case of travels less than 32.8 ft. (10m) we recommend an self-supporting e-chain®.

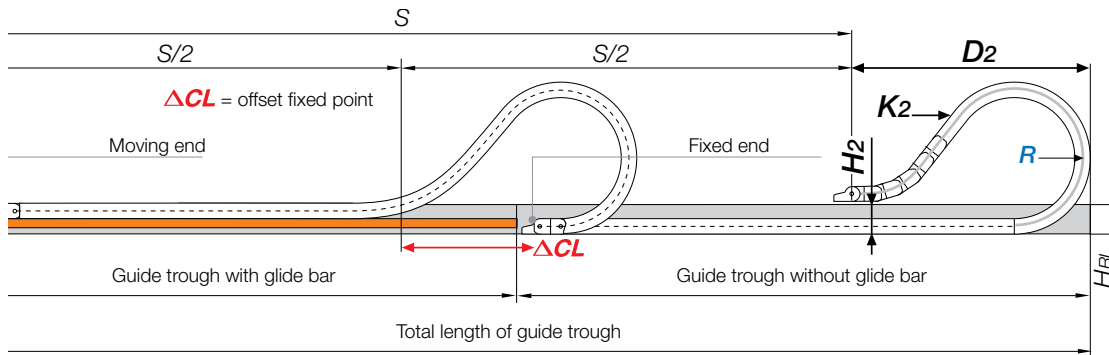

Pitch per link = 3.58" (91 mm)
 Links per ft (m) = 3.35 (11)
 Chain length = $\frac{S}{2} + K_2$

R	7.87 (200)	9.84 (250)	11.81 (300)	13.78 (350)
H	7.09 (180)	7.09 (180)	7.09 (180)	7.09 (180)
D	44.88 (1140)	57.87 (1470)	66.93 (1700)	76.77 (1950)
K	71.65 (1820)	89.57 (2275)	103.90 (2639)	118.23 (3003)
ΔACL	21.65 (550)	31.50 (800)	39.37 (1000)	47.24 (1200)

PDF: igus.com/e-chain-pdfs
 Product information: igus.com/e-chains

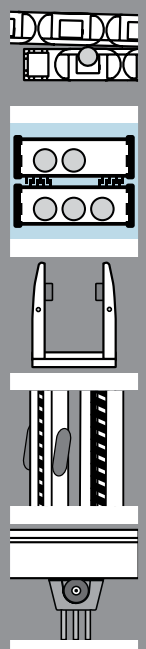

Long travels	from 32.8 ft. (10 m) up to max. 2,625 ft. (800 m)
Speed max. rolling / acceleration max. rolling	max. 32.8 ft/s (10 m/s) / max. 164 ft/s ² (50 m/s ²)
Fill weight	max. 8.74 lbs/ft. (13 kg/m)
Material - permitted temperature	igumid G / -40°F (-40°C) up to +248°F (+120° C)
Flammability Class, igumid G	VDE 0304 IIC UL94 HB

Technical Data



Details of material properties

► Chapter 1

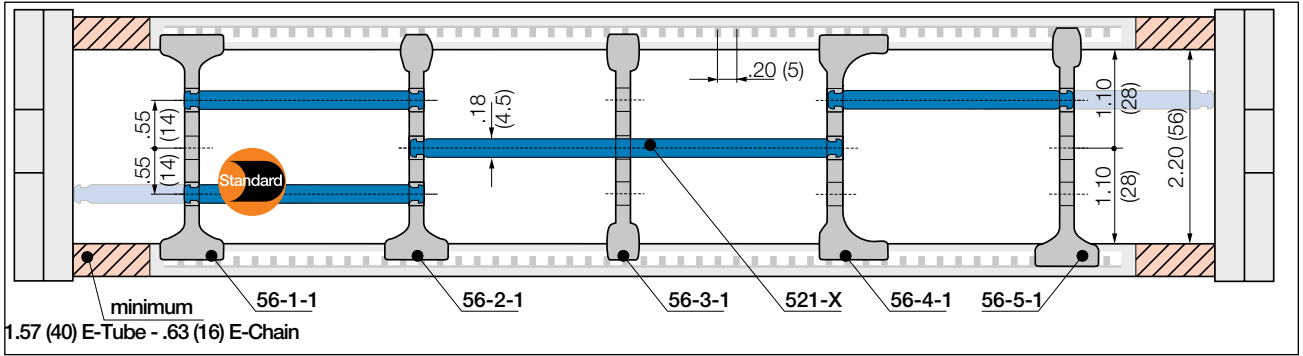

Note Please maintain a lateral spacing of 1.57" (40 mm) for E-Tube and .63" (16 mm) for e-chains® between the separators and the side links. In the standard configuration separators are assembled every 2nd e-chain® link

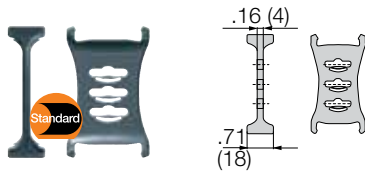

Separator, wide base

Unassembled	Part No. 56-1
Assembled	Part No. 56-1-1

- **Standard separator 56-1 for all applications**
Separator with wide base for maximum locking strength and safe standing in e-chains®.

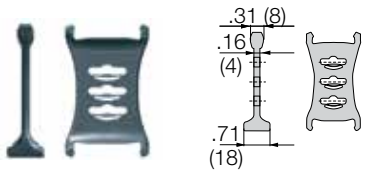

Separator, narrow head

Unassembled	Part No. 56-2
Assembled	Part No. 56-2-1

- **Separator 56-2 For even faster installation**
is used when vertical and horizontal separation is required. Due to its slot, it allows basic vertical/horizontal shelving arrangements.

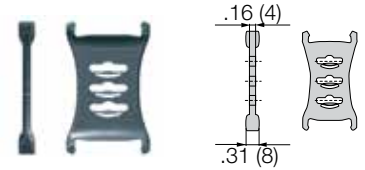

Separator, narrow base

Unassembled	Part No. 56-3
Assembled	Part No. 56-3-1

- **Separator 56-3 For many thin cables**
is used when vertical and horizontal separation is required. Due to its slot, it allows basic vertical/horizontal shelving arrangements.

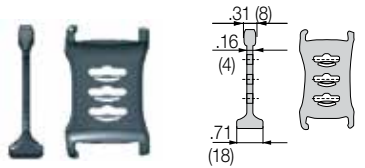

Separator, asymmetrical

Unassembled	Part No. 56-5
Assembled	Part No. 56-5-1

- **Separator 56-5 Locks safely in .30" (7.5 mm) increments**
Notch separator for exact positioning in e-chains®. Recommended for side-mounted applications.

Lockable full-width shelves - for the standard interior separation

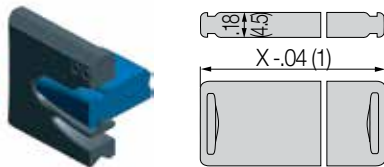

Full width shelf, lockable

Unassembled	Part No. 520-X
Assembled	Part No. 521-X

- **Full width shelf, lockable**
Shelf locks safely into separators on both ends, fixed width possible. Separators can be moved freely over the shelf in horizontal direction. Can be arranged at 3 different heights.

Width X	Part No.	Part No.	Width X	Part No.	Part No.	Width X	Part No.	Part No.
in. (mm)	Unassembled	Assembled	in. (mm)	Unassembled	Assembled	in. (mm)	Unassembled	Assembled
1.97 (050)	520-050	521-050	5.91 (150)	520-150	521-150	11.81 (300)	520-300	521-300
2.56 (065)	520-065	521-065	6.89 (175)	520-175	521-175	17.723 (450)	520-450	521-450
2.95 (075)	520-075	521-075	7.87 (200)	520-200	521-200			
3.94 (100)	520-100	521-100	8.86 (225)	520-225	521-225			
4.92 (125)	520-125	521-125	9.84 (250)	520-250	521-250			

Special solutions for long travel
 System P4 - rol e-chain® - Series P4-56
 Installation Dimensions

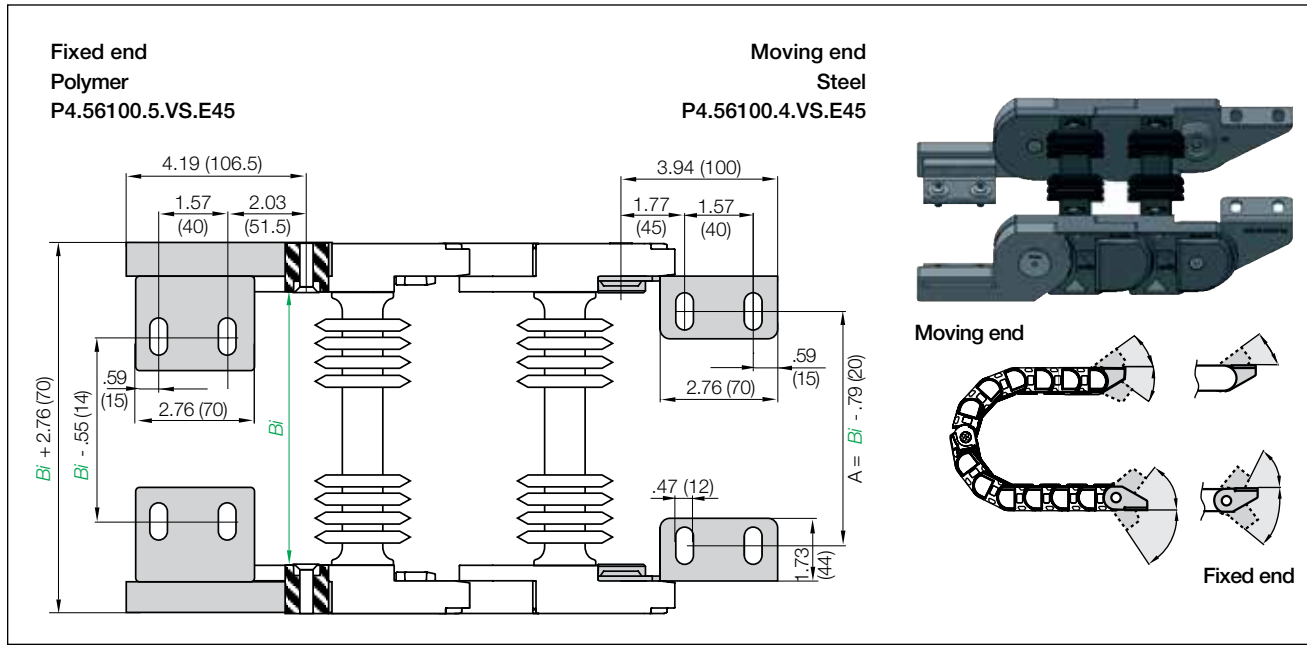

Mounting brackets pivoting - Recommended for rolling applications on long travels

Width Index	Part No. full set for Fixed end and moving end	Bi in. (mm)	Dim. A in. (mm)
18- ▶	P4-56100-54-VS-E45	7.09 (180)	6.30 (160)
20- ▶	P4-56100-54-VS-E45	7.87 (200)	7.09 (180)
25- ▶	P4-56100-54-VS-E45	9.84 (250)	9.06 (230)
30- ▶	P4-56100-54-VS-E45	11.81 (300)	11.02 (280)
35- ▶	P4-56100-54-VS-E45	13.78 (350)	12.99 (330)
40- ▶	P4-56100-54-VS-E45	15.75 (400)	14.96 (380)

The mounting brackets for P4 e-chains® consist of a steel mounting bracket at the moving end and a polymer mounting bracket at the fixed end. This ensure that the rollers move over a plain surface at the fixed end.

Strain relief, clamps, tiwrap plates, and clip-on solutions are available from stock.

For the complete Chainfix range refer to ▶ Chapter 10

PDF: igus.com/e-chain-pdfs
 Product information: igus.com/e-chains

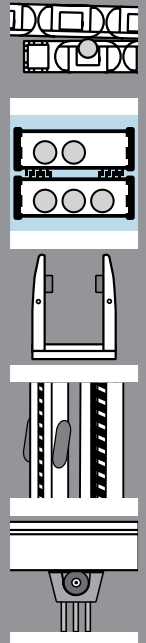

P4-80 - openable along both radii, crossbars every link - comb style autoglide crossbars



P4-56 crossbars every link

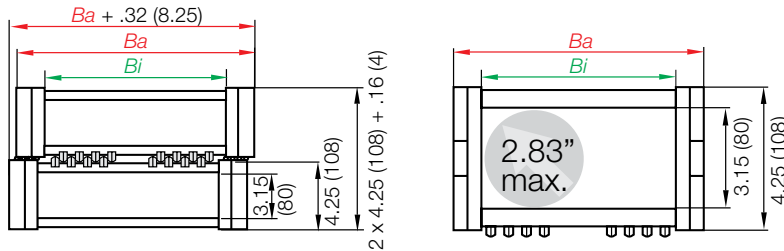

Part Number Structure

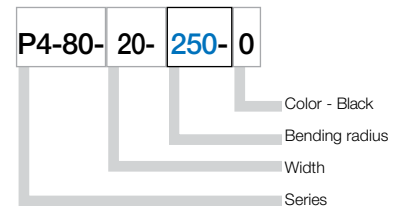

Part Number	<i>Bi</i> in. (mm)	<i>Ba</i> in. (mm)	Weight lbs/ft (kg/m)
P4-80-18-□-0	7.36 (187)	10.35 (263)	≈ 5.95 (8.85)
P4-80-20-□-0	7.87 (200)	10.87 (276)	≈ 6.14 (9.13)
P4-80-25-□-0	9.84 (250)	12.83 (326)	≈ 6.36 (9.46)
P4-80-30-□-0	11.81 (300)	14.80 (376)	≈ 6.61 (9.83)
P4-80-35-□-0	13.78 (350)	16.77 (426)	≈ 6.85 (10.19)
P4-80-40-□-0	15.75 (400)	18.74 (476)	≈ 7.03 (10.46)

Choose from the radii below for all of the above sizes
Radius (mm) Example: P4-80-20-250-0

	250	300	350	500
R	9.84 (250)	11.81 (300)	13.78 (350)	19.68 (500)
H	7.09 (180)	7.09 (180)	7.09 (180)	7.09 (180)
D	63.39 (1610)	77.72 (1974)	81.10 (2060)	128.94 (3275)
K	70.87 (1800)	90.55 (2300)	106.30 (2700)	161.42 (4100)

The bending radii 150 200 400 450 are available upon request.
Please contact technical sales for approximate delivery times.

Note: We recommend contacting our technical experts when planning your P4 application.
For distances below 32.8 ft. (10 m) we recommend a self-supporting e-chain®.

Additional Features

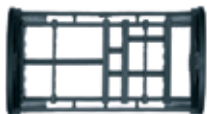

Interior separation available
► Series E4-80



Robust steel mounting brackets
available ► Upon request



Special P4 guide trough system
available ► Upon request



Extension link for heavy fill weights
available ► upon request

Special solutions for long travel

System P4 - rol e-chain® - Series P4-80

Installation Dimensions



P4-80

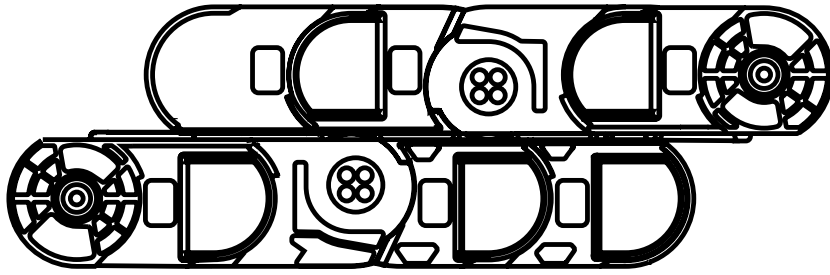

Legend

- S = Length of travel
- R = Bending radius
- H = Mounting height
- D = Overlength - long travels, gliding
- K = Add-on
- H_i = Trough inner height

The required clearance height: $H_i = H + 1.97$ in. (50 mm) with 20.16 lbs/ft (30 kg/m) fill weight. Please consult igus® if space is particularly restricted.

Sliding applications

Long travel lengths up to 2,625 ft. (800 m)

In case of travels less than 32.8 ft. (10m) we recommend an self-supporting e-chain®.

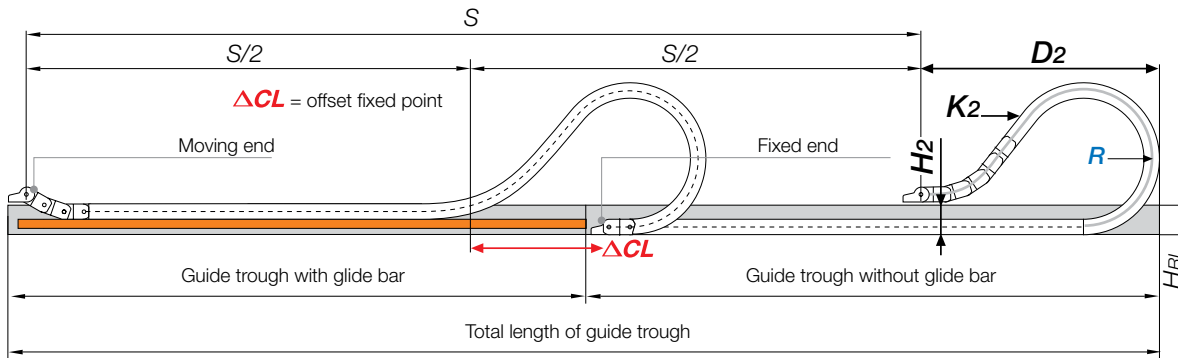

R	9.84 (250)	11.81 (300)	13.78 (350)	19.68 (500)
H _i	7.09 (180)	7.09 (180)	7.09 (180)	7.09 (180)
D ₂	63.39 (1610)	77.72 (1974)	81.10 (2060)	128.94 (3275)
K ₂	70.87 (1800)	90.55 (2300)	106.30 (2700)	161.42 (4100)
ΔCL	23.62 (600)	31.50 (800)	38.19 (970)	60.24 (1530)

Pitch per link: = 3.94" (100 mm)

Links per ft (m): = 3.05 (10)

Chain length: = $S/2 + K_2$

PDF: igus.com/e-chain-pdfs
Product information: igus.com/e-chains

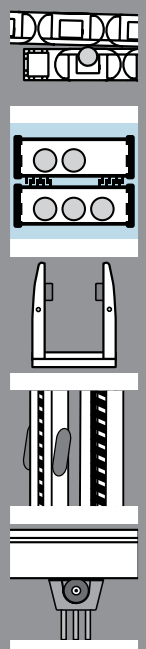

Long travels	from 32.8 ft. (10 m) up to max. 2,625 ft. (600 m)
Speed max. rolling / acceleration max. rolling	max. 32.8 ft/s (10 m/s) / max. 164 ft/s ² (50 m/s ²)
Fill weight	max. 20.16 lbs/ft. (30 kg/m)
Material - permitted temperature	igumid G / -40°F (-40°C) up to +248°F (+120°C)
Flammability Class, igumid G	VDE 0304 IIC UL94 HB

Technical Data



Details of material properties

► Chapter 1

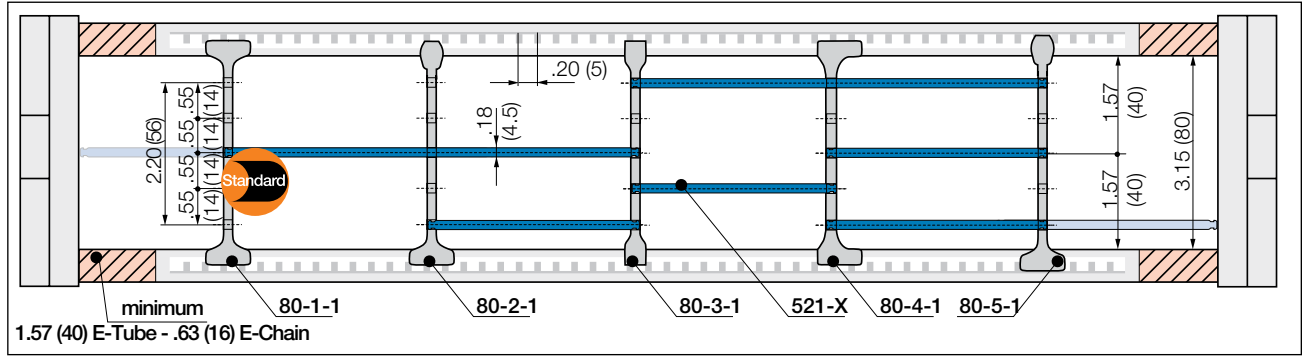

Note Please maintain a lateral spacing of 1.57" (40 mm) for E-Tube and .63" (16 mm) for e-chains® between the separators and the side links. In the standard configuration separators are assembled every 2nd e-chain® link

Telephone 1-800-521-2747

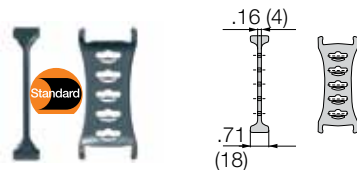

Separator, wide base

Unassembled	Part No. 80-1
Assembled	Part No. 80-1-1

- **Standard separator 80-1 for all applications**
Separator with wide base for maximum locking strength and safe standing in e-chains®.

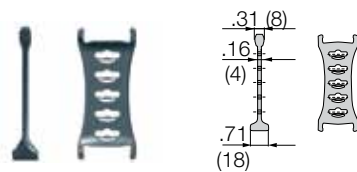

Separator, narrow head

Unassembled	Part No. 80-2
Assembled	Part No. 80-2-1

- **Separator 80-2 For even faster installation**
is used when vertical and horizontal separation is required. Due to its slot, it allows basic vertical/horizontal shelving arrangements.

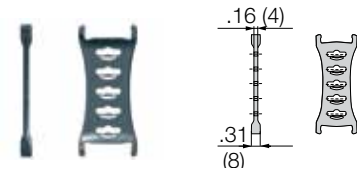

Separator, narrow base

Unassembled	Part No. 80-3
Assembled	Part No. 80-3-1

- **Separator 80-3 For many thin cables**
is used when vertical and horizontal separation is required. Due to its slot, it allows basic vertical/horizontal shelving arrangements.

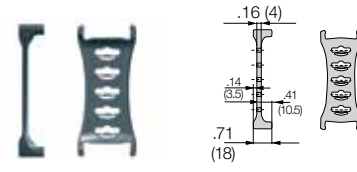

Separator, asymmetrical

Unassembled	Part No. 80-4
Assembled	Part No. 80-4-1

- **Separator 80-4 For side mounted applications**
is used when vertical and horizontal separation is required. Due to its slot, it allows basic vertical/horizontal shelving arrangements.

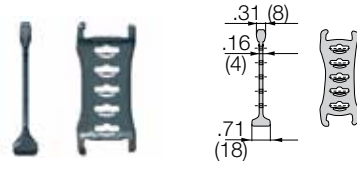

Separator, asymmetrical

Unassembled	Part No. 80-5
Assembled	Part No. 80-5-1

- **Separator 80-5 Locks safely in .30" (7.5 mm) increments**
Notch separator for exact positioning in e-chains®. Recommended for side-mounted applications.

Lockable full-width shelves - for the standard interior separation

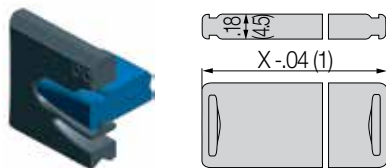

Full width shelf, lockable

Unassembled	Part No. 520-X
Assembled	Part No. 521-X

- **Full width shelf, lockable**
Shelf locks safely into separators on both ends, fixed width possible. Separators can be moved freely over the shelf in horizontal direction. Can be arranged at 5 different heights.

Width X in. (mm)	Part No. Unassembled	Part No. Assembled	Width X in. (mm)	Part No. Unassembled	Part No. Assembled	Width X in. (mm)	Part No. Unassembled	Part No. Assembled
1.97 (050)	520-50	521-50	5.91 (150)	520-125	521-125	11.81 (300)	520-125	521-125
2.56 (065)	520-65	521-65	6.89 (175)	520-125	521-125	13.78 (350)	520-125	521-125
2.95 (075)	520-75	521-75	7.87 (200)	520-125	521-125	14.76 (375)	520-125	521-125
3.94 (100)	520-100	521-100	8.86 (225)	520-125	521-125	15.24 (387)	520-125	521-125
4.92 (125)	520-125	521-125	9.84 (250)	520-125	521-125	17.723 (450)	520-125	521-125

Special solutions for long travel
 System P4 - rol e-chain® - Series P4-80
 Installation Dimensions

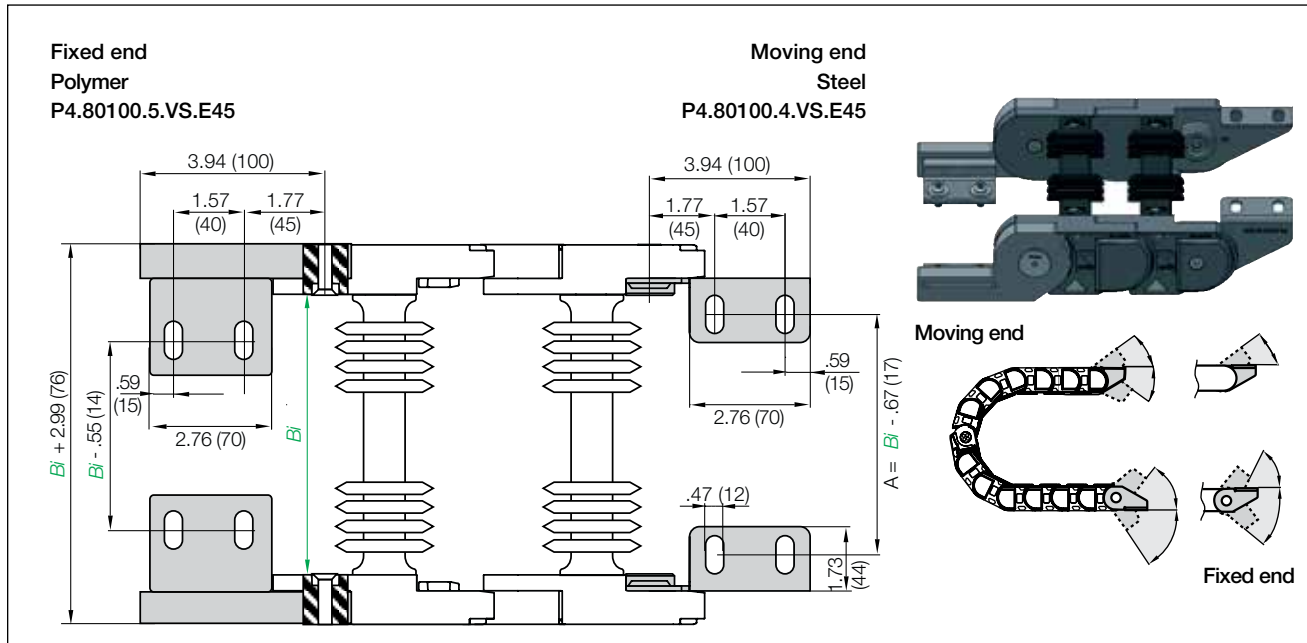

Mounting brackets pivoting - Recommended for rolling applications on long travels

Width Index	Part No. full set for Fixed end and moving end	<i>Bi</i> in. (mm)	Dim. A in. (mm)
18- ➤	P4-80100-54-VS-E45	7.09 (180)	6.30 (160)
20- ➤	P4-80100-54-VS-E45	7.87 (200)	7.09 (180)
25- ➤	P4-80100-54-VS-E45	9.84 (250)	9.06 (230)
30- ➤	P4-80100-54-VS-E45	11.81 (300)	11.02 (280)
35- ➤	P4-80100-54-VS-E45	13.78 (350)	12.99 (330)
40- ➤	P4-80100-54-VS-E45	15.75 (400)	14.96 (380)

The mounting brackets for P4 e-chains® consist of a steel mounting bracket at the moving end and a polymer mounting bracket at the fixed end. This ensure that the rollers move over a plain surface at the fixed end.

Strain relief, clamps, tiwrap plates, and clip-on solutions are available from stock.

For the complete Chainfix range refer to ➤ Chapter 10

PDF: igus.com/e-chain-pdfs
 Product information: igus.com/e-chains

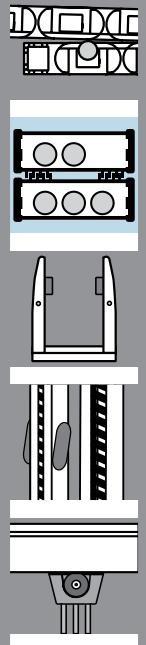



E4/4

rol e-chain®

Long travels up to 2,625 ft. (800m),
rolling instead of gliding



Advantages E4/4 rol e-chain®

- Special solution for long travels
- 75% less drive power, rolling
- Reduction of drive power needed to move the e-chain®
- Long travels up to 2,625 ft. (800m) with E4/4 rol e-chain®
- Speeds up to 19.69 ft/s (6m/s) possible
- Various roller types for optimum application adaption
- Can be used in dirty environments



When to use another e-chain® series:

- For very high fill weights for long travels
 - ▶ E4/4HD heavy-duty
- When you want a profile-rol e-chain® with which you can reduce energy consumption by up to 57%
 - ▶ P4 system
- When you want a self-guiding e-chain system® without any guide troughs
 - ▶ autoglide



Special solutions for long travel E4/4 rol e-chain® Rolling instead of gliding

High push/pull forces:
Large bolt connection

Quick to fill:
Lids open on both sides,
flip open in the outer
radius

Long life:
High-strength rollers,
quiet design, stainless
steel ball bearings

High stability:
Torsional stiffness
through undercut
design

Universal:
KMA with attachment
points on all sides

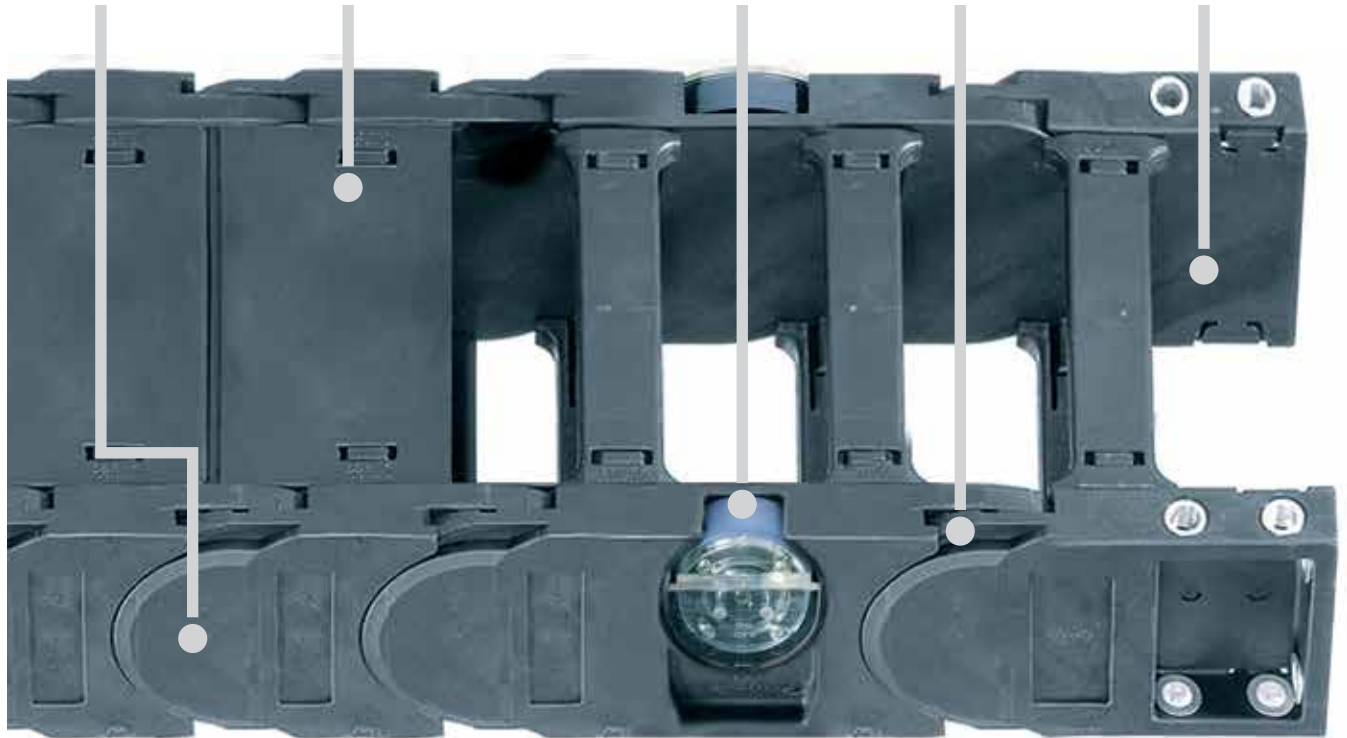

Long travels up to 2,625 ft. (800 m), rolling instead of gliding - rol e-chain®

Conventionally designed e-chains® are operated in the glide mode on long travels. The reason for developing the igus® rol e-chain® was the necessity to extend the technical limits of this operating mode. The demands on e-chains® for long travels have increased steadily in recent years. Travels of 2,625 ft. (800 m) also pose new challenges in crane building such as high travel speeds and low noise with extreme cable loads.

Please contact us if you have decided for this product. We'll assist you in the project planning!

- Major reduction in drive power for moving the e-chain®
- Travels up to 2,625 ft. (800 m) possible
- Speeds up to 19.69 ft/s (6 m/s) possible
- Various roller types for optimum application adaption
- Can be used even in dirty environments
- Available as ready-to-fit, made-to-specifications system with system guarantee

Typical industries and applications

- Cranes
- Warehousing
- Equipment manufacturing
- Gantry robots
- Material handling
- Mining
- Construction machinery

Special solutions for long travel

E4/4 rol e-chain®

Selection Table - Technical Data

Series	Inner height <i>hi</i> in. (mm)	Inner width <i>Bi</i> in. (mm)	Outer width <i>Ba</i> in. (mm)	Outer height <i>ha</i> in. (mm)	Bending radius <i>R</i> in. (mm)	Maximum Travel ft. (m)
--------	---------------------------------------	--------------------------------------	--------------------------------------	---------------------------------------	--	------------------------------



**rol e-chain® -
with crossbars every link
for the most demanding applications**

2828R	1.26 (32)	1.97-15.75 (50-400)	2.91-16.69 (74-424)	2.13 (54)	4.92-11.81 (125-300)**	820 (250)
3838R	1.65 (42)	1.97-15.75 (50-400)	3.03-16.81 (77-427)	2.52 (64)	5.91-13.78 (150-350)**	1,082 (330)
4040R	2.20 (56)	1.97-23.62 (50-600)	3.39-25.04 (86-636)	3.31 (84)	7.87-19.69 (200-500)**	1,641 (500)
5050R	3.15 (80)	1.97-23.62 (50-600)	3.94-25.59 (100-650)	4.25 (108)	9.84-19.69 (250-500)**	1,969 (600)



**rol e-chain® -
E-Tubes fully enclosed,
excellent cable protection**

7728R	1.26 (32)	1.97-11.81 (50-300)	2.91-16.69 (74-424)	2.13 (54)	9.84-11.81 (250-300)	820 (250)
7838R	1.65 (42)	1.97-11.81 (50-300)	3.03-16.81 (77-327)	2.52 (64)	4.92-13.78 (200-350)	1,082 (330)
8840R	2.20 (56)	2.95-18.19 (75-462)	4.37-19.65 (111-499)	3.31 (84)	11.81-19.69 (300-500)	1,641 (500)
9850R	3.15 (80)	2.95-18.19 (75-462)	4.92-20.20 (125-513)	4.25 (108)	11.81-39.37 (300-1000)	1,969 (600)



**rol e-chain® -
with crossbars every link, Heavy Duty
For very long travels with high additional
fill weights**

4040RHD*	2.20 (56)	1.97-23.62 (50-600)	4.09-25.75 (104-654)	3.31 (84)	7.87-15.75 (200-400)	1,969 (600)
5050RHD*	3.15 (80)	1.97-23.62 (50-600)	4.33-25.98 (110-660)	4.25 (108)	9.84-19.69 (250-500)	2,625 (800)

**Smaller bending radii (only For e-chains®) available upon request, please consult igus® for delivery time.

Product Range rol e-chain®

Interior heights of 1.26", 1.65", 2.20", and 3.15" (32, 42, 56, and 80 mm) can be supplied from stock. All interior separation and mounting bracket options of the igus® System E4 are available. The standard guide troughs of the various chains from stock can be used. rol e-chains® can be opened on both sides. The rol e-chain® is available as a made-to-spec e-chain systems®. chainflex® cables can be harnessed in rol e-chain to your specifications by igus® specialists and are packaged in an

installation-friendly manner. Depending on the rol e-chain length it can be delivered on a drum. If cables from the chainflex® product line are to be used, we will also be happy to provide a guarantee for the entire system. **Systems of this type should be designed by our system design engineers. We will be more than willing to submit an offer to you. Please contact igus®.**

Reduce push/pull forces by over 75% with igus® rol e-chain

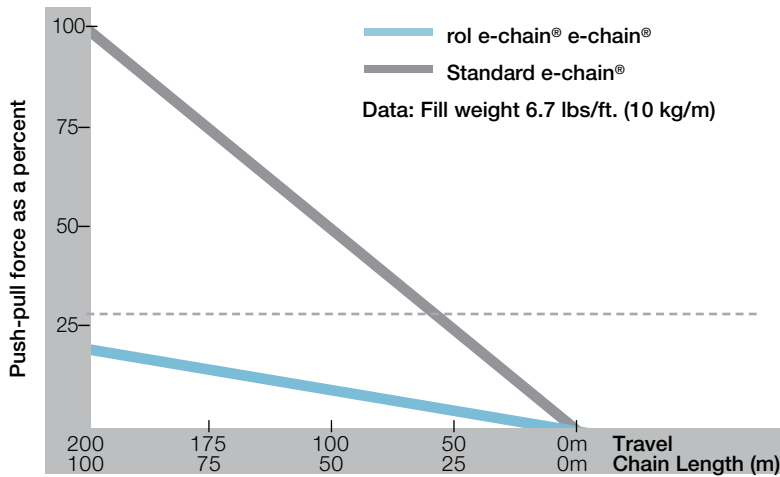

The rol e-chain® roller e-chain® compared with a conventional e-chain system®



Shipyard-Crane: 590.5 ft. (180 m) travel, 20.16 lbs/ft (30 kg/m) fill weight: No problems since installation in 2001 with igus® rol e-chain®



igus® rol e-chain® Series 5050R in a steel plant in India with highly corrosive atmosphere -
Travel = 72 ft. (22 m), $v = 3.28 \text{ ft/s}$ (1 m/s), $a = 3.28 \text{ ft/s}^2$ (1 m/s²)



Power plant application with igus® rol e-chain® 4040R -
Travel 151 ft. (46 m), Speed 4.92 ft/s (1.5 m/s), Fill weight 3.56 lbs/ft (5.3 kg/m)



Assembled system in a ship unloading crane with igus® 5050RHD - Travel 248 ft. (106 m), Speed 13.12 ft/s (4 m/s),
Fill weight 16.8 lbs/ft (25 kg/m)



Series 4040R on a coal unloading system -
Travel 623 ft. (190 m), Speed 1.6 ft/s (0.5 m/s),
Fill weight 5.41 lbs/ft (8.05 kg/m)



Series 4040R in steel works environment -
Travel 34.5 ft. (10.5 m), Speed 197 ft/min (60 m/min),
Fill weight 4.09 lbs/ft (6.084 kg/m)



igus® e-chains® 5050RHD rol e-chain® in an igus® Aluminum SuperTrough = 75% less driving power

PDF: igus.com/e-chain-pdfs
Product information: igus.com/e-chains

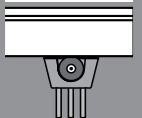
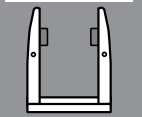
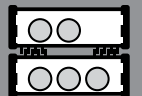
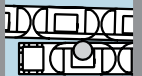

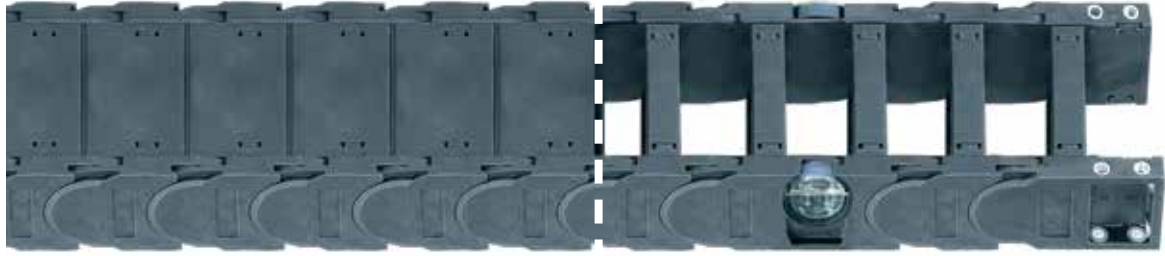

Series 2828R - crossbars every link, openable along both radii
Series 7728R - fully enclosed, hinged, snap-open removable lids

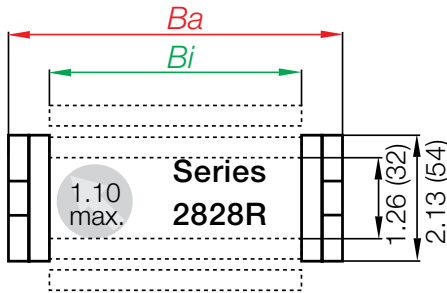

Sliding applications

Long travel lengths up to 820 ft. (250 m) fill weight up to 4.03 lbs/ft (6 kg/m)

In case of travels less than 32.8 ft. (10m) we recommend a self-supporting e-chain®.

NOTE: Systems of this type should be designed by our system design engineers. Please contact igus® for assistance with your application.

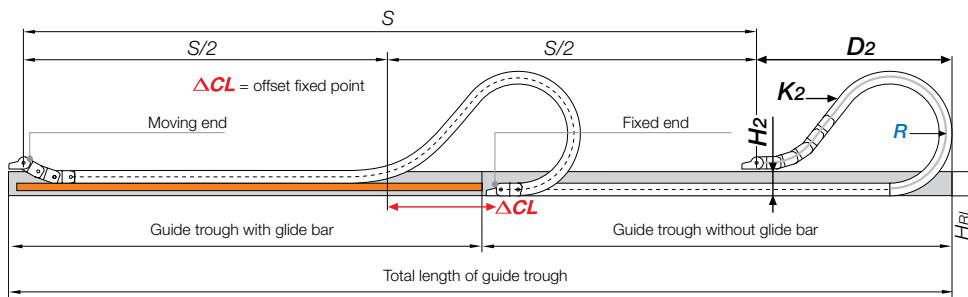

Legend

- S = Length of travel
- R = Bending radius
- H₁ = Trough inner height
- H₂ = *Mounting height
- D₂ = Overlength - long travels, gliding
- K₂ = *Add-on

R	4.92 (125**)	5.91 (150)	6.89 (175)	7.87 (200)	8.66 (220)	9.84 (250)	11.81 (300)
H ₂ +10	6.54 (166)	6.54 (166)	6.54 (166)	6.54 (166)	6.54 (166)	6.54 (166)	6.54 (166)
D ₂ +50	22.64 (575)	27.56 (700)	33.27 (845)	37.80 (960)	40.94 (1040)	50.00 (1270)	60.63 (1540)
K ₂	35.28 (896)	41.89 (1064)	50.71 (1288)	57.32 (1456)	63.94 (1624)	74.96 (1904)	90.39 (2296)
ΔCL	10.63 (270)	14.96 (380)	19.29 (490)	23.62 (600)	27.56 (700)	33.07 (840)	41.54 (1055)

Pitch per link: = 2.20" (56 mm)
Links per ft (m): = 5.48 (18)
For center mount applications:
Chain length: = $\frac{S}{2} + K_2$

** This radius not available for E-Tubes

Available Accessories



Optimized, cable-friendly interior separation program



Pivoting KMA mounting bracket with all-sides attachment



Steel mounting brackets, pivoting, robust and electrically conductive



Aluminum SuperTrough, Basic Version

Long travels	from 32.8 ft. (10 m) up to max. 820 ft. (250 m)
Speed max. rolling / acceleration max. rolling	max. 32.8 ft/s (10 m/s) / max. 164 ft/s ² (50 m/s ²)
Material - permitted temperature	igumid G / -40°F (-40°C) up to +248°F (+120° C)
Flammability Class, igumid G	VDE 0304 IIC UL94 HB

Technical Data



Details of material properties

► Chapter 1

Special solutions for long travel

E4/4 rol e-chain® - Series 2828R/7728R

Installation Dimensions



2828R
7728R

Supplement part number with required radius. Example: 2828R-30-300-0

Pitch: 2.20 in. (56mm) per link links/ft (m) = 5.49 (18)



Part Number				Weight		
Crossbars	Tube		<i>Bi</i>	<i>Ba</i>	2828R	7728R
Every Link	Version		in. (mm)	in. (mm)	lbs/ft (kg/m)	lbs/ft (kg/m)
2828R-05-	¹ 7728R-05-	<input type="checkbox"/> -0	1.97 (50)	2.91 (74)	≈ 1.16 (1.73)	≈ 1.76 (2.63)
2828R-06-		<input type="checkbox"/> -0	2.68 (68)	3.62 (92)	≈ 1.20 (1.79)	-
2828R-07-	7728R-07-	<input type="checkbox"/> -0	2.95 (75)	3.90 (99)	≈ 1.24 (1.84)	≈ 1.84 (2.75)
2828R-087-		<input type="checkbox"/> -0	3.43 (87)	4.37 (111)	≈ 1.30 (1.93)	-
2828R-097		<input type="checkbox"/> -0	3.82 (97)	4.72 (120)	≈ 1.34 (1.99)	-
2828R-10-	7728R-10-	<input type="checkbox"/> -0	3.94 (100)	4.88 (124)	≈ 1.36 (2.02)	≈ 1.90 (2.83)
2828R-11-	7728R-11-	<input type="checkbox"/> -0	4.25 (108)	5.20 (132)	≈ 1.40 (2.08)	≈ 1.98 (2.94)
2828R-112-		<input type="checkbox"/> -0	4.41 (112)	5.39 (137)	≈ 1.44 (2.15)	-
2828R-12-	7728R-12-	<input type="checkbox"/> -0	4.92 (125)	5.87 (149)	≈ 1.48 (2.20)	≈ 2.04 (3.03)
2828R-137-		<input type="checkbox"/> -0	5.39 (137)	6.38 (162)	≈ 1.54 (2.29)	-
2828R-15-	7728R-15-	<input type="checkbox"/> -0	5.91 (150)	6.85 (174)	≈ 1.60 (2.38)	≈ 2.14 (3.19)
2828R-162-		<input type="checkbox"/> -0	6.38 (162)	7.36 (187)	≈ 1.64 (2.44)	-
2828R-17-	7728R-17-	<input type="checkbox"/> -0	6.61 (168)	7.56 (192)	≈ 1.69 (2.51)	≈ 2.28 (3.39)
2828R-18-		<input type="checkbox"/> -0	6.89 (175)	7.83 (199)	≈ 1.72 (2.56)	-
2828R-187-		<input type="checkbox"/> -0	7.36 (187)	8.35 (212)	≈ 1.78 (2.65)	-
2828R-20-	7728R-20-	<input type="checkbox"/> -0	7.87 (200)	8.82 (224)	≈ 1.84 (2.74)	≈ 2.41 (3.59)
2828R-212-		<input type="checkbox"/> -0	8.35 (212)	9.33 (237)	≈ 1.93 (2.87)	-
2828R-23-		<input type="checkbox"/> -0	8.86 (225)	9.80 (249)	≈ 1.96 (2.92)	-
2828R-237-		<input type="checkbox"/> -0	9.33 (237)	10.31 (262)	≈ 2.05 (3.05)	-
2828R-25-	7728R-25-	<input type="checkbox"/> -0	9.84 (250)	10.79 (274)	≈ 2.08 (3.10)	≈ 2.72 (4.04)
2828R-262-		<input type="checkbox"/> -0	10.31 (262)	11.26 (286)	≈ 2.14 (3.19)	-
2828R-28		<input type="checkbox"/> -0	10.83 (275)	11.77 (299)	≈ 2.20 (3.28)	-
2828R-29-		<input type="checkbox"/> -0	11.30 (287)	12.28 (312)	≈ 2.26 (3.37)	-
2828R-30-	7728R-30-	<input type="checkbox"/> -0	11.81 (300)	12.76 (324)	≈ 2.33 (3.46)	≈ 2.98 (4.43)
2828R-312-		<input type="checkbox"/> -0	12.28 (312)	13.27 (337)	≈ 2.41 (3.59)	-
2828R-325-		<input type="checkbox"/> -0	12.79 (325)	13.74 (349)	≈ 2.47 (3.68)	-
2828R-337-		<input type="checkbox"/> -0	13.27 (337)	14.25 (362)	≈ 2.53 (3.77)	-
2828R-350-		<input type="checkbox"/> -0	13.78 (350)	14.72 (374)	≈ 2.59 (3.86)	-
2828R-362-		<input type="checkbox"/> -0	14.25 (362)	15.24 (387)	≈ 2.65 (3.95)	-
2828R-375-		<input type="checkbox"/> -0	14.76 (375)	15.71 (399)	≈ 2.72 (4.04)	-
2828R-387-		<input type="checkbox"/> -0	15.24 (387)	16.22 (412)	≈ 2.76 (4.11)	-
2828R-400		<input type="checkbox"/> -0	15.75 (400)	16.69 (424)	≈ 2.81 (4.18)	-

Choose from the radii below for all of the above sizes
Radius (mm) Example: 2828R-30-300-0

	125**	150	175	200	220	250	300
R	4.92 (125)	5.91 (150)	6.89 (175)	7.87 (200)	8.66 (220)	9.84 (250)	11.81 (300)
H: +10	6.54 (166)	6.54 (166)	6.54 (166)	6.54 (166)	6.54 (166)	6.54 (166)	6.54 (166)
D: +50	22.64 (575)	27.56 (700)	33.27 (845)	37.80 (960)	40.94 (1040)	50.00 (1270)	60.63 (1540)
K:	35.28 (896)	41.89 (1064)	50.71 (1288)	57.32 (1456)	63.94 (1624)	74.96 (1904)	90.39 (2296)

** This radius not available for E-Tubes

¹ Removable lid only, no hinged option

PDF: igus.com/e-chain-pdfs
Product information: igus.com/e-chains

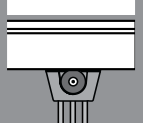
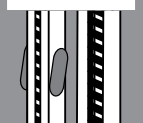
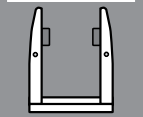
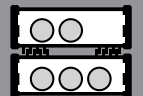
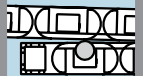



Series 3838R - crossbars every link, openable along both radii
Series 7838R - fully enclosed, hinged, snap-open removable lids

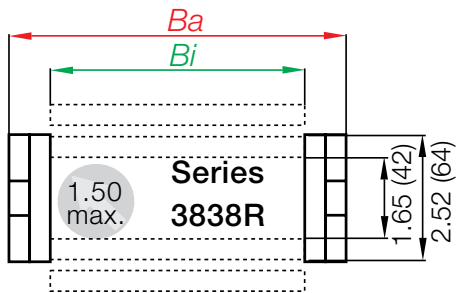

Sliding applications

Long travel lengths up to 1,083 ft. (330 m), Fill weights up to 4.70 lbs/ft (7 kg/m)

In case of travels less than 32.8 ft. (10m) we recommend a self-supporting e-chain®.

NOTE: Systems of this type should be designed by our system design engineers. Please contact igus® for assistance with your application.

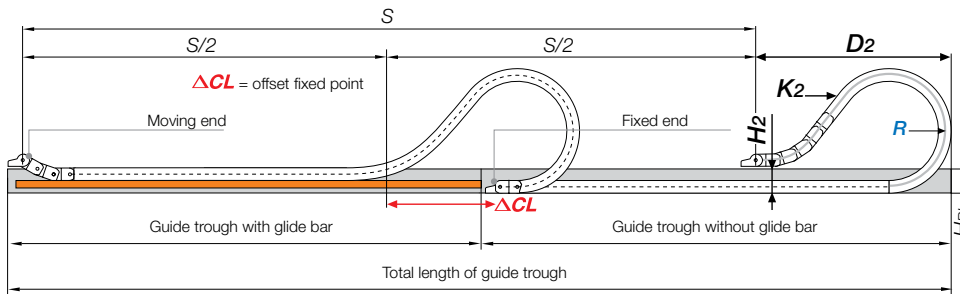

Legend

- S = Length of travel
- R = Bending radius
- H₂ = Trough inner height
- H = *Mounting height
- D₂ = Overlength - long travels, gliding
- K₂ = *Add-on

R	5.91 (150**)	6.69 (170**)	7.87 (200)	8.46 (215)	9.84 (250)	11.81 (300)	13.78 (350)
H ₂ +10	7.32 (186)	7.32 (186)	7.32 (186)	7.32 (186)	7.32 (186)	7.32 (186)	7.32 (186)
D ₂ +50	26.77 (680)	32.28 (820)	39.76 (1010)	40.55 (1030)	49.02 (1245)	64.17 (1630)	72.05 (1830)
K ₂	42.13 (107)	50.12 (1273)	60.67 (1541)	63.31 (1608)	73.86 (1876)	97.60 (2479)	108.15 (2747)
ΔCL	13.58 (345)	17.91 (455)	24.02 (610)	23.38 (670)	32.48 (825)	42.32 (1075)	50.59 (1285)

Pitch per link: = 2.64" (67 mm)
Links per ft (m): = 4.57 (15)
For center mount applications:
Chain length = $\frac{S}{2} + K$

** This radius not available for E-Tubes

Available Accessories



Optimized, cable-friendly interior separation program



Pivoting KMA mounting bracket with all-sides attachment



Steel mounting brackets, pivoting, robust and electrically conductive



Aluminum SuperTrough, Basic Version

Long travels	from 32.8 ft. (10 m) up to max. 1,083 ft. (330 m)
Speed max. rolling / acceleration max. rolling	max. 32.8 ft/s (10 m/s) / max. 164 ft/s ² (50 m/s ²)
Material - permitted temperature	igumid G / -40°F (-40°C) up to +248°F (+120° C)
Flammability Class, igumid G	VDE 0304 IIC UL94 HB

Technical Data



Details of material properties

► Chapter 1

Special solutions for long travel

E4/4 rol e-chain® - Series 3838R/R7838R

Installation Dimensions



3838R
7838R

Supplement part number with required radius. Example: 3838R-30--0
Pitch: 2.64 in. (67mm) per link, links/ft (m) = 4.57 (15)



Part Number			Weight			
Crossbars	Tube		<i>Bi</i>	<i>Ba</i>	3838R	7838R
Every Link	Version		in. (mm)	in. (mm)	lbs/ft (kg/m)	lbs/ft (kg/m)
3838R-05-	¹ 7838R-05-	<input type="text" value=""/> -0	1.97 (50)	3.03 (77)	≈ 1.38 (2.06)	≈ 1.51 (2.25)
3838R-06-		<input type="text" value=""/> -0	2.68 (68)	3.74 (95)	≈ 1.40 (2.09)	-
3838R-07-	7838R-07-	<input type="text" value=""/> -0	2.95 (75)	4.02 (102)	≈ 1.42 (2.12)	≈ 1.60 (2.38)
3838R-087-		<input type="text" value=""/> -0	3.43 (87)	4.53 (115)	≈ 1.47 (2.18)	-
3838R-097-		<input type="text" value=""/> -0	3.82 (97)	4.84 (123)	≈ 1.50 (2.23)	-
3838R-10-	7838R-10-	<input type="text" value=""/> -0	3.94 (100)	5.00 (127)	≈ 1.51 (2.25)	≈ 1.75 (2.60)
3838R-11-	7838R-11-	<input type="text" value=""/> -0	4.25 (108)	5.31 (135)	≈ 1.55 (2.30)	≈ 1.78 (2.65)
3838R-112-		<input type="text" value=""/> -0	4.41 (112)	5.51 (140)	≈ 1.55 (2.30)	-
3838R-12-	7838R-12-	<input type="text" value=""/> -0	4.92 (125)	5.98 (152)	≈ 1.61 (2.40)	≈ 1.89 (2.81)
3838R-137-		<input type="text" value=""/> -0	5.39 (137)	6.50 (165)	≈ 1.64 (2.44)	-
3838R-15-	7838R-15-	<input type="text" value=""/> -0	5.91 (150)	6.97 (177)	≈ 1.70 (2.53)	≈ 2.06 (3.07)
3838R-162-		<input type="text" value=""/> -0	6.38 (162)	7.48 (190)	≈ 1.71 (2.55)	-
3838R-17-	7838R-17-	<input type="text" value=""/> -0	6.61 (168)	7.68 (195)	≈ 1.76 (2.62)	≈ 2.18 (3.24)
3838R-18-		<input type="text" value=""/> -0	6.89 (175)	7.95 (202)	≈ 1.76 (2.62)	-
3838R-187-		<input type="text" value=""/> -0	7.36 (187)	8.46 (215)	≈ 1.81 (2.69)	-
3838R-20-	7838R-20-	<input type="text" value=""/> -0	7.87 (200)	8.94 (227)	≈ 1.86 (2.77)	≈ 2.37 (3.53)
3838R-212-		<input type="text" value=""/> -0	8.35 (212)	9.45 (240)	≈ 1.91 (2.84)	-
3838R-23-		<input type="text" value=""/> -0	8.86 (225)	9.92 (252)	≈ 1.96 (2.92)	-
3838R-237-		<input type="text" value=""/> -0	9.33 (237)	10.43 (265)	≈ 1.99 (2.96)	-
3838R-25-	7838R-25-	<input type="text" value=""/> -0	9.84 (250)	10.91 (277)	≈ 2.05 (3.05)	≈ 2.91 (4.33)
3838R-262-		<input type="text" value=""/> -0	10.31 (262)	11.42 (290)	≈ 2.06 (3.06)	-
3838R-28		<input type="text" value=""/> -0	10.83 (275)	11.89 (302)	≈ 2.13 (3.17)	-
3838R-29-		<input type="text" value=""/> -0	11.30 (287)	12.40 (315)	≈ 2.14 (3.19)	-
3838R-30-	7838R-30-	<input type="text" value=""/> -0	11.81 (300)	12.87 (327)	≈ 2.23 (3.32)	≈ 3.29 (4.89)
3838R-312-		<input type="text" value=""/> -0	12.28 (312)	13.39 (340)	≈ 2.24 (3.34)	-
3838R-325-		<input type="text" value=""/> -0	12.79 (325)	13.86 (352)	≈ 2.29 (3.41)	-
3838R-337-		<input type="text" value=""/> -0	13.27 (337)	14.37 (365)	≈ 2.33 (3.46)	-
3838R-350-		<input type="text" value=""/> -0	13.78 (350)	15.41 (377)	≈ 2.47 (3.68)	-
3838R-362-		<input type="text" value=""/> -0	14.25 (362)	15.36 (390)	≈ 2.51 (3.74)	-
3838R-375-		<input type="text" value=""/> -0	14.76 (375)	15.83 (402)	≈ 2.55 (3.79)	-
3838R-387-		<input type="text" value=""/> -0	15.24 (387)	16.34 (415)	≈ 2.59 (3.85)	-
3838R-400		<input type="text" value=""/> -0	15.75 (400)	16.81 (427)	≈ 2.62 (3.90)	-

Choose from the radii below for all of the above sizes

Radius (mm) Example: 3838R-30--0

	150**	170**	200	215	250	300	350
R	5.91 (150)	6.69 (170)	7.87 (200)	8.46 (215)	9.84 (250)	11.81 (300)	13.78 (350)
H: +10	7.32 (186)	7.32 (186)	7.32 (186)	7.32 (186)	7.32 (186)	7.32 (186)	7.32 (186)
D: +50	26.77 (680)	32.28 (820)	39.76 (1010)	40.55 (1030)	49.02 (1245)	64.17 (1630)	72.05 (1830)
K:	42.13 (107)	50.12 (1273)	60.67 (1541)	63.31 (1608)	73.86 (1876)	97.60 (2479)	108.15 (2747)

** This radius not available for E-Tubes

¹ Removable lid only, no hinged option

PDF: igus.com/e-chain-pdfs
Product information: igus.com/e-chains

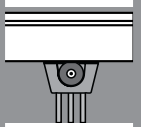
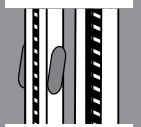
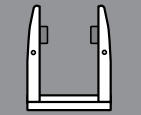
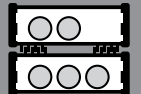



Series 4040R - crossbars every link, openable along both radii
Series 8840R - fully enclosed, hinged, snap-open removable lids

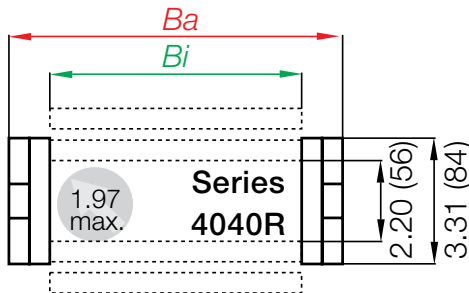

Sliding applications

Long travel lengths up to 1,641 ft. (500 m), Fill weights up to 8.74 lbs/ft (13 kg/m)

In case of travels less than 32.8 ft. (10m) we recommend a self-supporting e-chain®.

NOTE: Systems of this type should be designed by our system design engineers. Please contact igus® for assistance with your application.

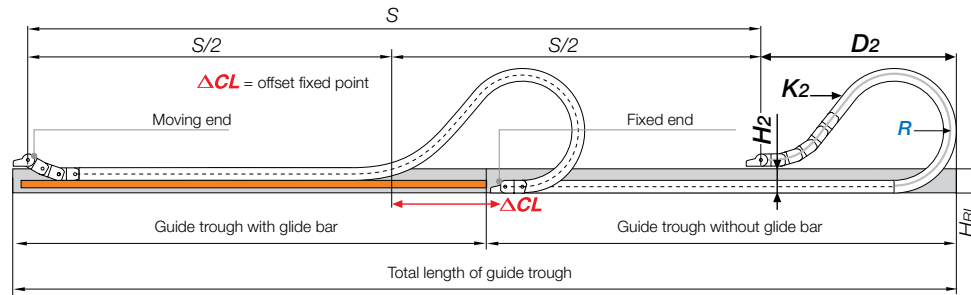

Legend

- S = Length of travel
- R = Bending radius
- H_i = Trough inner height
- H₂ = *Mounting height
- D₂ = Overlength - long travels, gliding
- K₂ = *Add-on

R	7.87 (200)	9.84 (250)	11.81 (300)	13.78 (350)	15.75 (400)
H _i +10	7.09 (180)	7.09 (180)	7.09 (180)	7.09 (180)	7.09 (180)
D ₂ +50	48.43 (1230)	53.94 (1370)	62.99 (1600)	72.83 (1850)	81.50 (2070)
K ₂	71.65 (1820)	85.98 (2184)	100.31 (2548)	114.65 (2912)	128.98 (3276)
ΔCL	20.67 (525)	27.95 (710)	35.43 (900)	42.91 (1090)	50.20 (1275)

Pitch per link = 3.58" (91 mm)
Links per ft (m) = 3.35 (11)
For center mount applications:
Chain length = $\frac{S}{2} + K$

Available Accessories



Optimized, cable-friendly interior separation program



Pivoting KMA mounting bracket with all-sides attachment



Steel mounting brackets, pivoting, robust and electrically conductive



Extension links - for extremely wide e-chains® up to 9.84 ft. (3.0 m)



Aluminum SuperTrough, Basic Version

Long travels	from 32.8 ft. (10 m) up to max. 1,641 ft. (500 m)
Speed max. rolling / acceleration max. rolling	max. 32.8 ft/s (10 m/s) / max. 164 ft/s ² (50 m/s ²)
Material - permitted temperature	igumid G / -40°F (-40°C) up to +248°F (+120° C)
Flammability Class, igumid G	VDE 0304 IIC UL94 HB

Technical Data



Details of material properties

► Chapter 1

E4/4 rol e-chain® - Series 4040R/R8840R

Installation Dimensions



4040R
8840R

Supplement part number with required radius. Example: 4040R-30-300-0
Pitch: 3.58 in. (91mm) per link links/ft (m) = 3.35 (11)



Part Number			<i>Bi</i>	<i>Ba</i>	Weight	
Crossbars	Tube		in. (mm)	in. (mm)	4040R	8840R
Every Link	Version				lbs/ft (kg/m)	lbs/ft (kg/m)
4040R-05-		<input type="checkbox"/> -0	1.97 (50)	3.39 (86)	≈ 2.45 (3.65)	–
4040R-06-		<input type="checkbox"/> -0	2.56 (65)	3.98 (101)	≈ 2.47 (3.67)	–
4040R-07-	¹ 8840R-07-	<input type="checkbox"/> -0	2.95 (75)	4.37 (111)	≈ 2.54 (3.78)	≈ 2.85 (4.24)
4040R-08-		<input type="checkbox"/> -0	3.43 (87)	4.84 (123)	≈ 2.57 (3.83)	–
4040R-10-	8840R-10-	<input type="checkbox"/> -0	3.94 (100)	5.35 (136)	≈ 2.66 (3.96)	≈ 3.04 (4.52)
4040R-11-		<input type="checkbox"/> -0	4.41 (112)	5.87 (149)	≈ 2.75 (4.09)	–
4040R-12-	8840R-12-	<input type="checkbox"/> -0	4.92 (125)	6.34 (161)	≈ 2.80 (4.16)	≈ 3.28 (4.88)
4040R-13-		<input type="checkbox"/> -0	5.39 (137)	6.85 (174)	≈ 2.88 (4.29)	–
4040R-15-	8840R-15-	<input type="checkbox"/> -0	5.91 (150)	7.32 (186)	≈ 2.93 (4.36)	≈ 3.57 (5.31)
4040R-16-		<input type="checkbox"/> -0	6.38 (162)	7.83 (199)	≈ 3.00 (4.47)	–
4040R-17-	8840R-17	<input type="checkbox"/> -0	6.89 (175)	8.31 (211)	≈ 3.08 (4.58)	≈ 3.74 (5.56)
4040R-18-		<input type="checkbox"/> -0	7.36 (187)	8.81 (224)	≈ 3.15 (4.69)	–
4040R-20-	8840R-20-	<input type="checkbox"/> -0	7.87 (200)	9.29 (236)	≈ 3.17 (4.71)	≈ 3.96 (5.89)
4040R-21-		<input type="checkbox"/> -0	8.35 (212)	9.80 (249)	≈ 3.24 (4.82)	–
4040R-22-		<input type="checkbox"/> -0	8.86 (225)	10.28 (261)	≈ 3.28 (4.88)	–
4040R-23-		<input type="checkbox"/> -0	9.33 (237)	10.79 (274)	≈ 3.37 (5.02)	–
4040R-25-	8840R-25-	<input type="checkbox"/> -0	9.84 (250)	11.26 (286)	≈ 3.43 (5.10)	≈ 4.44 (6.61)
4040R-26-		<input type="checkbox"/> -0	10.31 (262)	11.77 (299)	≈ 3.49 (5.19)	–
4040R-27-	8840R-27	<input type="checkbox"/> -0	10.83 (275)	12.24 (311)	≈ 3.56 (5.30)	≈ 4.63 (6.89)
4040R-28-		<input type="checkbox"/> -0	11.30 (287)	12.76 (324)	≈ 3.58 (5.32)	–
4040R-30-	8840R-30-	<input type="checkbox"/> -0	11.81 (300)	13.23 (336)	≈ 3.72 (5.54)	≈ 4.89 (7.27)
4040R-31-		<input type="checkbox"/> -0	12.28 (312)	13.74 (349)	≈ 3.75 (5.58)	–
4040R-32-		<input type="checkbox"/> -0	12.79 (325)	14.21 (361)	≈ 3.78 (5.63)	–
4040R-33-		<input type="checkbox"/> -0	13.27 (337)	14.72 (374)	≈ 3.90 (5.81)	–
4040R-35-	8840R-35-	<input type="checkbox"/> -0	13.78 (350)	15.20 (386)	≈ 4.01 (5.96)	≈ 5.39 (8.02)
4040R-36-		<input type="checkbox"/> -0	14.25 (362)	15.71 (399)	≈ 4.01 (5.96)	–
4040R-37-		<input type="checkbox"/> -0	14.76 (375)	16.18 (411)	≈ 4.02 (5.98)	–
4040R-38-		<input type="checkbox"/> -0	15.24 (387)	16.69 (424)	≈ 4.08 (6.07)	–
4040R-40-	8840R-40-	<input type="checkbox"/> -0	15.75 (400)	17.17 (436)	≈ 4.21 (6.27)	≈ 6.04 (8.98)
4040R-41-		<input type="checkbox"/> -0	16.22 (412)	17.68 (449)	≈ 4.31 (6.42)	–
4040R-42-		<input type="checkbox"/> -0	16.73 (425)	18.15 (461)	≈ 4.42 (6.58)	–
4040R-43-		<input type="checkbox"/> -0	17.20 (437)	18.66 (474)	≈ 4.46 (6.64)	–
4040R-45-		<input type="checkbox"/> -0	17.72 (450)	19.13 (486)	≈ 4.51 (6.71)	–
4040R-46-	8840R-46-	<input type="checkbox"/> -0	18.19 (462)	19.65 (499)	≈ 4.52 (6.73)	≈ 6.34 (9.44)
4040R-47-		<input type="checkbox"/> -0	18.70 (475)	20.12 (511)	≈ 4.61 (6.86)	–
4040R-48-		<input type="checkbox"/> -0	19.17 (487)	20.63 (524)	≈ 4.63 (6.88)	–
4040R-50-		<input type="checkbox"/> -0	19.69 (500)	21.10 (536)	≈ 4.70 (7.00)	–
4040R-51-		<input type="checkbox"/> -0	20.16 (512)	21.61 (549)	≈ 4.72 (7.02)	–
4040R-52-		<input type="checkbox"/> -0	20.67 (525)	22.09 (561)	≈ 4.74 (7.06)	–
4040R-53-		<input type="checkbox"/> -0	21.14 (537)	22.60 (574)	≈ 4.85 (7.22)	–
4040R-55-		<input type="checkbox"/> -0	21.65 (550)	23.07 (586)	≈ 5.17 (7.70)	–
4040R-60-		<input type="checkbox"/> -0	23.62 (600)	25.04 (636)	≈ 5.31 (7.90)	–

Choose from the radii below for all of the above sizes
Radius (mm) Example: 4040R-30-300-0

	200**	250**	300	350	400
R	7.87 (200)	9.84 (250)	11.81 (300)	13.78 (350)	15.75 (400)
H: ⁺¹⁰	7.09 (180)	7.09 (180)	7.09 (180)	7.09 (180)	7.09 (180)
D: ⁺⁵⁰	48.43 (1230)	53.94 (1370)	62.99 (1600)	72.83 (1850)	81.50 (2070)
K:	71.65 (1820)	85.98 (2184)	100.31 (2548)	114.65 (2912)	128.98 (3276)

** This radius not available for E-Tubes

¹ Removable lid only, no hinged option

PDF: igus.com/e-chain-pdfs
Product information: igus.com/e-chains

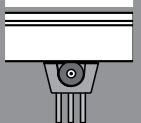
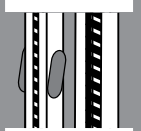
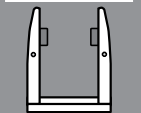
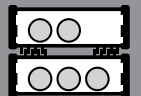
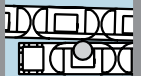



Series 4040RHD - crossbars every link, openable along both radii

Telephone 1-800-521-2747

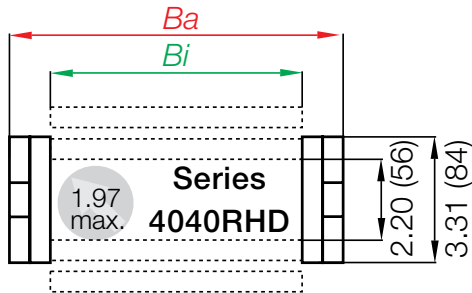

Sliding applications

Long travel lengths up to 1,969 ft. (600 m), Fill weights up to 10.75 lbs/ft (16 kg/m)
In case of travels less than 32.8 ft. (10m) we recommend a self-supporting e-chain®.
NOTE: Systems of this type should be designed by our system design engineers. Please contact igus® for assistance with your application.

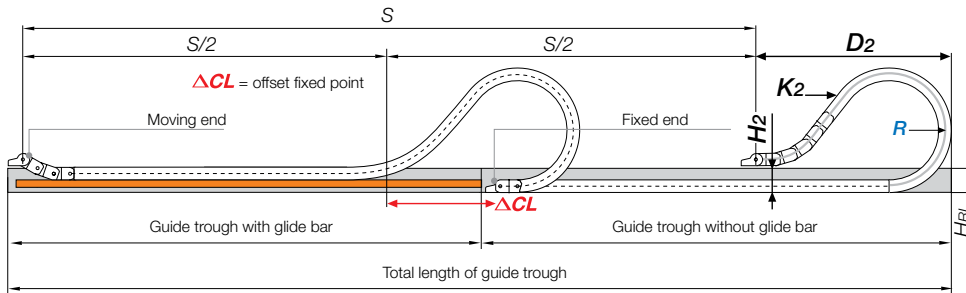

R	7.87 (200**)	9.84 (250**)	11.81 (300)	13.78 (350)	15.75 (400)
H ₁ +10	7.09 (180)	7.09 (180)	7.09 (180)	7.09 (180)	7.09 (180)
D ₂ +50	45.08 (1145)	54.72 (1390)	63.78 (1620)	73.62 (1870)	82.48 (2095)
K ₂	71.65 (1820)	85.98 (2184)	100.31 (2548)	114.65 (2912)	128.98 (3276)
ΔACL	20.67 (525)	27.95 (710)	35.43 (900)	42.91 (1090)	50.20 (1275)

Pitch per link: = 3.58" (91 mm)
Links per ft (m): = 3.35 (11)
For center mount applications:
Chain length = $S/2 + K$

Legend

- S = Length of travel
- R = Bending radius
- H₁ = Trough inner height
- H₂ = *Mounting height
- D₂ = Overlength - long travels, gliding
- K₂ = *Add-on

Available Accessories



Optimized, cable-friendly interior separation program



Steel mounting brackets, pivoting, robust and electrically conductive



Aluminum SuperTrough, Basic Version

Internet: igus.com
email: sales@igus.com
QuickSpec: igus.com/quickspec

Long travels	from 32.8 ft. (10 m) up to max. 1,969 ft. (600 m)
Speed max. rolling / acceleration max. rolling	max. 32.8 ft/s (10 m/s) / max. 164 ft/s ² (50 m/s ²)
Material - permitted temperature	igumid G / -40°F (-40°C) up to +248°F (+120° C)
Flammability Class, igumid G	VDE 0304 IIC UL94 HB

Technical Data



Details of material properties

► Chapter 1

E4/4 rol e-chain® - Series 4040RHD

Installation Dimensions



4040RHD

Supplement part number with required radius. Example: 4040RHD-30--0
Pitch: 3.58 in. (91 mm) per link links/ft (m) = 3.35 (11)



Part Number	<i>Bi</i> in. (mm)	<i>Ba</i> in. (mm)	Weight lbs/ft (kg/m)
4040RHD-05- <input type="text" value="05"/> -0	1.97 (50)	4.09 (104)	≈ 3.38 (5.03)
4040RHD-06- <input type="text" value="06"/> -0	2.56 (65)	4.69 (119)	≈ 3.44 (5.12)
4040RHD-07- <input type="text" value="07"/> -0	2.95 (75)	5.08 (129)	≈ 3.49 (5.19)
4040RHD-08- <input type="text" value="08"/> -0	3.43 (87)	5.55 (141)	≈ 3.54 (5.27)
4040RHD-10- <input type="text" value="10"/> -0	3.94 (100)	6.06 (154)	≈ 3.60 (5.36)
4040RHD-11- <input type="text" value="11"/> -0	4.41 (112)	6.54 (166)	≈ 3.68 (5.48)
4040RHD-12- <input type="text" value="12"/> -0	4.92 (125)	7.05 (179)	≈ 3.74 (5.56)
4040RHD-13- <input type="text" value="13"/> -0	5.39 (137)	7.52 (191)	≈ 3.82 (5.69)
4040RHD-15- <input type="text" value="15"/> -0	5.91 (150)	8.03 (204)	≈ 3.85 (5.73)
4040RHD-16- <input type="text" value="16"/> -0	6.38 (162)	8.50 (216)	≈ 3.92 (5.84)
4040RHD-17- <input type="text" value="17"/> -0	6.89 (175)	9.02 (229)	≈ 4.01 (5.97)
4040RHD-18- <input type="text" value="18"/> -0	7.36 (187)	9.49 (241)	≈ 4.09 (6.09)
4040RHD-20- <input type="text" value="20"/> -0	7.87 (200)	10.00 (254)	≈ 4.13 (6.14)
4040RHD-21- <input type="text" value="21"/> -0	8.35 (212)	10.47 (266)	≈ 4.17 (6.21)
4040RHD-22- <input type="text" value="22"/> -0	8.86 (225)	10.98 (279)	≈ 4.22 (6.28)
4040RHD-23- <input type="text" value="23"/> -0	9.33 (237)	11.46 (291)	≈ 4.29 (6.39)
4040RHD-25- <input type="text" value="25"/> -0	9.84 (250)	11.97 (304)	≈ 4.37 (6.50)
4040RHD-26- <input type="text" value="26"/> -0	10.31 (262)	12.44 (316)	≈ 4.43 (6.59)
4040RHD-27- <input type="text" value="27"/> -0	10.83 (275)	12.95 (329)	≈ 4.50 (6.70)
4040RHD-28- <input type="text" value="28"/> -0	11.30 (287)	13.43 (341)	≈ 4.54 (6.75)
4040RHD-30- <input type="text" value="30"/> -0	11.81 (300)	13.94 (354)	≈ 4.64 (6.91)
4040RHD-31- <input type="text" value="31"/> -0	12.28 (312)	14.41 (366)	≈ 4.66 (6.94)
4040RHD-32- <input type="text" value="32"/> -0	12.79 (325)	14.92 (379)	≈ 4.74 (7.05)
4040RHD-33- <input type="text" value="33"/> -0	13.27 (337)	15.39 (391)	≈ 4.82 (7.17)
4040RHD-35- <input type="text" value="35"/> -0	13.78 (350)	15.91 (404)	≈ 4.95 (7.37)
4040RHD-36- <input type="text" value="36"/> -0	14.25 (362)	16.38 (416)	≈ 4.96 (7.38)
4040RHD-37- <input type="text" value="37"/> -0	14.76 (375)	16.89 (429)	≈ 4.96 (7.38)
4040RHD-38- <input type="text" value="38"/> -0	15.24 (387)	17.36 (441)	≈ 5.03 (7.49)
4040RHD-40- <input type="text" value="40"/> -0	15.75 (400)	17.87 (454)	≈ 5.21 (7.76)
4040RHD-41- <input type="text" value="41"/> -0	16.22 (412)	18.35 (466)	≈ 5.16 (7.68)
4040RHD-42- <input type="text" value="42"/> -0	16.73 (425)	18.86 (479)	≈ 5.36 (7.98)
4040RHD-43- <input type="text" value="43"/> -0	17.20 (437)	19.33 (491)	≈ 5.25 (7.82)
4040RHD-45- <input type="text" value="45"/> -0	17.72 (450)	19.84 (504)	≈ 5.48 (8.15)
4040RHD-46- <input type="text" value="46"/> -0	18.19 (462)	20.31 (516)	≈ 5.44 (8.10)
4040RHD-47- <input type="text" value="47"/> -0	18.70 (475)	20.83 (529)	≈ 5.47 (8.14)
4040RHD-48- <input type="text" value="48"/> -0	19.17 (487)	21.30 (541)	≈ 5.64 (8.39)
4040RHD-50- <input type="text" value="50"/> -0	19.69 (500)	21.81 (554)	≈ 5.70 (8.48)
4040RHD-51- <input type="text" value="51"/> -0	20.16 (512)	22.28 (566)	≈ 5.64 (8.40)
4040RHD-52- <input type="text" value="52"/> -0	20.67 (525)	22.80 (579)	≈ 5.76 (8.57)
4040RHD-53- <input type="text" value="53"/> -0	21.14 (537)	23.27 (591)	≈ 5.82 (8.66)
4040RHD-55- <input type="text" value="55"/> -0	21.65 (550)	23.78 (604)	≈ 6.10 (9.08)
4040RHD-60- <input type="text" value="60"/> -0	23.62 (600)	25.75 (654)	≈ 6.26 (9.31)

Choose from the radii below for all of the above sizes

Radius (mm) Example: 4040RHD-30--0

	200	250	300	350	400
R	7.87 (200)	9.84 (250)	11.81 (300)	13.78 (350)	15.75 (400)
H:	7.09 (180)	7.09 (180)	7.09 (180)	7.09 (180)	7.09 (180)
D:	45.08 (1145)	54.72 (1390)	63.78 (1620)	73.62 (1870)	82.48 (2095)
K:	71.65 (1820)	85.98 (2184)	100.31 (2548)	114.65 (2912)	128.98 (3276)

PDF: igus.com/e-chain-pdfs
Product information: igus.com/e-chains

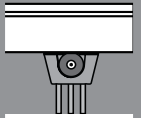
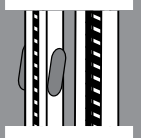
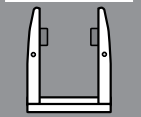
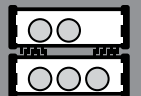
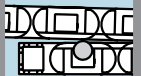



Series 5050R - crossbars every link, openable along both radii
Series 9850R - fully enclosed, hinged, snap-open removable lids

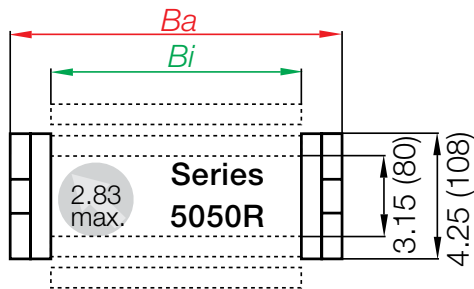

Sliding applications

Long travel lengths up to 1,969 ft. (600 m), Fill weights up to 16.80 lbs/ft (25 kg/m)

In case of travels less than 32.8 ft. (10m) we recommend a self-supporting e-chain®.

NOTE: Systems of this type should be designed by our system design engineers. Please contact igus® for assistance with your application.

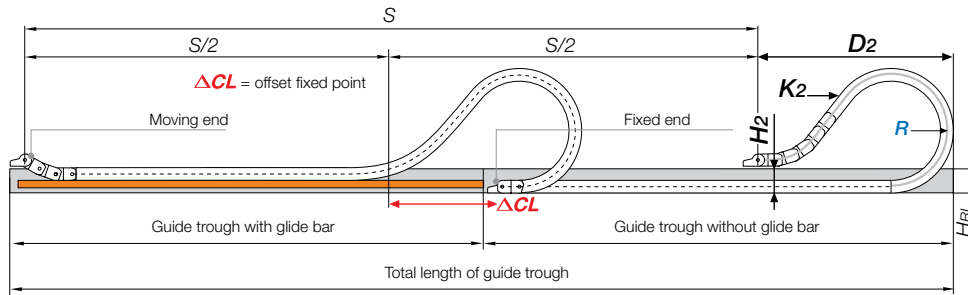

Legend

- S = Length of travel
- R = Bending radius
- H₂ = Trough inner height
- H = *Mounting height
- D = Overlength - long travels, gliding
- K = *Add-on

R	9.84 (250**)	11.81 (300)	13.78 (350)	15.75 (400)	19.69 (500)
H ₂ +10	9.53 (242)	9.53 (242)	9.53 (242)	9.53 (242)	9.53 (242)
D ₂ +50	49.21 (1250)	61.02 (1550)	67.72 (1720)	78.35 (1990)	96.85 (2460)
K ₂	78.82 (2002)	96.73 (2457)	107.48 (2730)	125.39 (3185)	154.06 (3913)
ΔCL	23.62 (600)	31.50 (800)	38.19 (970)	45.67 (1160)	60.24 (1530)

Pitch per link: = 3.58" (91 mm)
Links per ft (m): = 3.35 (11)
For center mount applications:
Chain length = $\frac{S}{2} + K$

Available Accessories



Optimized, cable-friendly interior separation program



Pivoting KMA mounting bracket with all-sides attachment



Steel mounting brackets, pivoting, robust and electrically conductive



Extension links - for extremely wide e-chains® up to 9.84 ft. (3.0 m)



Aluminum SuperTrough, Basic Version

Long travels	from 32.8 ft. (10 m) up to max. 1,969 ft. (600 m)
Speed max. rolling / acceleration max. rolling	max. 32.8 ft/s (10 m/s) / max. 164 ft/s ² (50 m/s ²)
Material - permitted temperature	igumid G / -40°F (-40°C) up to +248°F (+120° C)
Flammability Class, igumid G	VDE 0304 IIC UL94 HB

Technical Data



Details of material properties

► Chapter 1

E4/4 rol e-chain® - Series 5050R/9850R

Installation Dimensions



5050R
9850R

Supplement part number with required radius. Example: 5050R-30-300-0
Pitch: 3.58 in. (91mm) per link links/ft (m) = 3.35 (11)



Part Number			Weight			
Crossbars Every Link	Tube Version		<i>Bi</i> in. (mm)	<i>Ba</i> in. (mm)	5050R lbs/ft (kg/m)	9850R lbs/ft (kg/m)
5050R-05-		<input type="checkbox"/> -0	1.97 (50)	3.94 (100)	≈ 3.78 (5.62)	–
5050R-06-		<input type="checkbox"/> -0	2.56 (65)	4.53 (115)	≈ 3.82 (5.68)	–
5050R-07-	¹ 9850R-07-	<input type="checkbox"/> -0	2.95 (75)	4.92 (125)	≈ 3.83 (5.70)	≈ 4.19 (6.24)
5050R-08-		<input type="checkbox"/> -0	3.43 (87)	5.39 (137)	≈ 3.87 (5.76)	–
5050R-10-	9850R-10-	<input type="checkbox"/> -0	3.94 (100)	5.91 (150)	≈ 3.89 (5.79)	≈ 4.38 (6.52)
5050R-11-		<input type="checkbox"/> -0	4.41 (112)	6.42 (163)	≈ 3.93 (5.85)	–
5050R-12-	9850R-12-	<input type="checkbox"/> -0	4.92 (125)	6.89 (175)	≈ 3.96 (5.89)	≈ 4.63 (6.89)
5050R-13-		<input type="checkbox"/> -0	5.39 (137)	7.40 (188)	≈ 4.00 (5.95)	–
5050R-15-	9850R-15-	<input type="checkbox"/> -0	5.91 (150)	7.87 (200)	≈ 4.02 (5.98)	≈ 4.92 (7.32)
5050R-16-		<input type="checkbox"/> -0	6.38 (162)	8.39 (213)	≈ 4.06 (6.04)	–
5050R-17-	9850R-17	<input type="checkbox"/> -0	6.89 (175)	8.86 (225)	≈ 4.09 (6.09)	≈ 5.09 (7.58)
5050R-18-		<input type="checkbox"/> -0	7.36 (187)	9.37 (238)	≈ 4.13 (6.15)	–
5050R-20-	9850R-20-	<input type="checkbox"/> -0	7.87 (200)	9.84 (250)	≈ 4.14 (6.16)	≈ 5.30 (7.89)
5050R-21-		<input type="checkbox"/> -0	8.35 (212)	10.35 (263)	≈ 4.18 (6.22)	–
5050R-22-		<input type="checkbox"/> -0	8.86 (225)	10.83 (275)	≈ 4.20 (6.25)	–
5050R-23-		<input type="checkbox"/> -0	9.33 (237)	11.34 (288)	≈ 4.24 (6.31)	–
5050R-25-	9850R-25-	<input type="checkbox"/> -0	9.84 (250)	11.81 (300)	≈ 4.27 (6.36)	≈ 5.79 (8.61)
5050R-26-		<input type="checkbox"/> -0	10.31 (262)	12.32 (313)	≈ 4.30 (6.40)	–
5050R-27-	9850R-27	<input type="checkbox"/> -0	10.83 (275)	12.80 (325)	≈ 4.34 (6.46)	≈ 5.93 (8.82)
5050R-28-		<input type="checkbox"/> -0	11.30 (287)	13.31 (338)	≈ 4.35 (6.47)	–
5050R-30-	9850R-30-	<input type="checkbox"/> -0	11.81 (300)	13.78 (350)	≈ 4.42 (6.58)	≈ 6.23 (9.27)
5050R-31-		<input type="checkbox"/> -0	12.28 (312)	14.29 (363)	≈ 4.43 (6.60)	–
5050R-32-		<input type="checkbox"/> -0	12.79 (325)	14.76 (375)	≈ 4.45 (6.62)	–
5050R-33-		<input type="checkbox"/> -0	13.27 (337)	15.28 (388)	≈ 4.51 (6.71)	–
5050R-35-	9850R-35-	<input type="checkbox"/> -0	13.78 (350)	15.75 (400)	≈ 4.56 (6.79)	≈ 6.73 (10.02)
5050R-36-		<input type="checkbox"/> -0	14.25 (362)	16.26 (413)	≈ 4.57 (6.80)	–
5050R-37-		<input type="checkbox"/> -0	14.76 (375)	16.73 (425)	≈ 4.57 (6.80)	–
5050R-38-		<input type="checkbox"/> -0	15.24 (387)	17.24 (438)	≈ 4.60 (6.84)	–
5050R-40-	9850R-40-	<input type="checkbox"/> -0	15.75 (400)	17.72 (450)	≈ 4.66 (6.94)	≈ 7.38 (10.98)
5050R-41-		<input type="checkbox"/> -0	16.22 (412)	18.23 (463)	≈ 4.72 (7.02)	–
5050R-42-		<input type="checkbox"/> -0	16.73 (425)	18.70 (475)	≈ 4.77 (7.10)	–
5050R-43-		<input type="checkbox"/> -0	17.20 (437)	19.21 (488)	≈ 4.79 (7.13)	–
5050R-45-		<input type="checkbox"/> -0	17.72 (450)	19.69 (500)	≈ 4.81 (7.16)	–
5050R-46-	9850R-46-	<input type="checkbox"/> -0	18.19 (462)	20.20 (513)	≈ 4.82 (7.17)	≈ 7.69 (11.44)
5050R-47-		<input type="checkbox"/> -0	18.70 (475)	20.67 (525)	≈ 4.87 (7.24)	–
5050R-48-		<input type="checkbox"/> -0	19.17 (487)	21.99 (538)	≈ 4.88 (7.26)	–
5050R-50-		<input type="checkbox"/> -0	19.69 (500)	21.65 (550)	≈ 4.91 (7.30)	–
5050R-51-		<input type="checkbox"/> -0	20.16 (512)	22.16 (563)	≈ 4.92 (7.32)	–
5050R-52-		<input type="checkbox"/> -0	20.67 (525)	22.64 (575)	≈ 4.93 (7.34)	–
5050R-53-		<input type="checkbox"/> -0	21.14 (537)	23.15 (588)	≈ 4.98 (7.41)	–
5050R-55-		<input type="checkbox"/> -0	21.65 (550)	23.62 (600)	≈ 5.15 (7.66)	–
5050R-60-		<input type="checkbox"/> -0	23.62 (600)	25.59 (650)	≈ 5.21 (7.76)	–

Choose from the radii below for all of the above sizes
Radius (mm) Example: 5050R-30-300-0

	250**	300	350	400	500
R	9.84 (250)	11.81 (300)	13.78 (350)	15.75 (400)	19.69 (500)
H ⁺¹⁰	9.53 (242)	9.53 (242)	9.53 (242)	9.53 (242)	9.53 (242)
D ⁺⁵⁰	49.21 (1250)	61.02 (1550)	67.72 (1720)	78.35 (1990)	96.85 (2460)
K	78.82 (2002)	96.73 (2457)	107.48 (2730)	125.39 (3185)	154.06 (3913)

** This radius not available for E-Tubes
¹ Removable lid only, no hinged option

PDF: igus.com/e-chain-pdfs
Product information: igus.com/e-chains

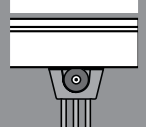
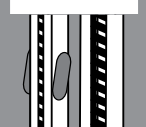
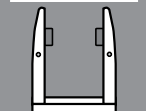
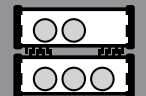



Series 5050RHD - crossbars every link, openable along both radii

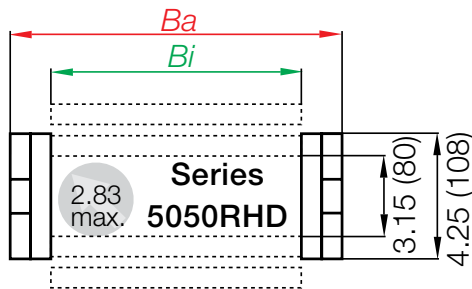

Sliding applications

Long travel lengths up to 2,625 ft. (800 m), Fill weights up to 20.16 lbs/ft (30 kg/m)

In case of travels less than 32.8 ft. (10m) we recommend an self-supporting e-chain®.

NOTE: Systems of this type should be designed by our system design engineers. Please contact igus® for assistance with your application.

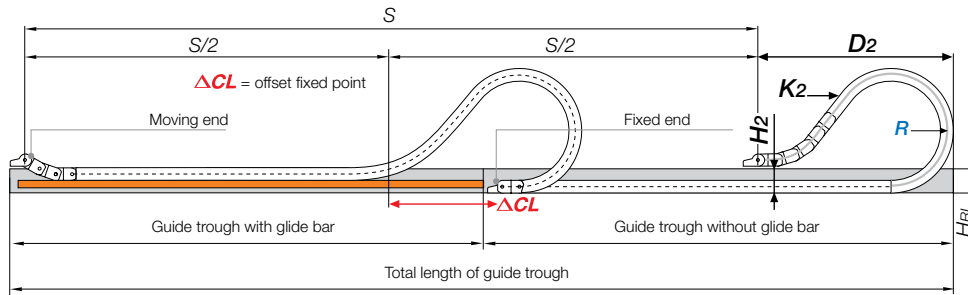

Legend

- S = Length of travel
- R = Bending radius
- H₂ = Trough inner height
- H = *Mounting height
- D₂ = Overlength - long travels, gliding
- K = *Add-on

R	9.84 (250**)	11.81 (300)	13.78 (350)	15.75 (400)	19.69 (500)
H ₂ +10	9.53 (242)	9.53 (242)	9.53 (242)	9.53 (242)	9.53 (242)
D ₂ +50	50.39 (1280)	61.81 (1570)	68.90 (1750)	79.13 (2010)	97.64 (2480)
K ₂	78.82 (2002)	96.73 (2457)	107.48 (2730)	125.39 (3185)	154.06 (3913)
ΔCL	23.62 (600)	31.50 (800)	38.19 (970)	45.67 (1160)	60.24 (1530)

Pitch per link = 3.58" (91 mm)

Links per ft (m) = 3.35 (11)

For center mount applications:

Chain length = $\frac{S}{2} + K$

Available Accessories



Optimized, cable-friendly interior separation program



Steel mounting brackets, pivoting, robust and electrically conductive



Extension links - for extremely wide e-chains® up to 9.84 ft. (3.0 m)



Aluminum SuperTrough, Basic Version

Long travels	from 32.8 ft. (10 m) up to max. 2,625 ft. (800 m)
Speed max. rolling / acceleration max. rolling	max. 32.8 ft/s (10 m/s) / max. 164 ft/s² (50 m/s²)
Material - permitted temperature	igumid G / -40°F (-40°C) up to +248°F (+120° C)
Flammability Class, igumid G	VDE 0304 IIC UL94 HB

Technical Data



Details of material properties

► Chapter 1

E4/4 rol e-chain® - Series 5050RHD

Installation Dimensions



5050RHD

Supplement part number with required radius. Example: 5050RHD-30-300-0
 Pitch: 3.58 in. (91mm) per link links/ft (m) = 3.35 (11)

Part Number	<i>Bi</i>		<i>Ba</i>		Weight lbs/ft (kg/m)
	in. (mm)	in. (mm)	in. (mm)	in. (mm)	
5050RHD-05- <input type="checkbox"/> -0	1.97 (50)	4.33 (110)	≈ 4.47 (6.65)		
5050RHD-06- <input type="checkbox"/> -0	2.56 (65)	4.92 (125)	≈ 4.53 (6.74)		
5050RHD-07- <input type="checkbox"/> -0	2.95 (75)	5.31 (135)	≈ 4.58 (6.81)		
5050RHD-08- <input type="checkbox"/> -0	3.43 (87)	5.79 (147)	≈ 4.63 (6.89)		
5050RHD-10- <input type="checkbox"/> -0	3.94 (100)	6.30 (160)	≈ 4.70 (6.99)		
5050RHD-11- <input type="checkbox"/> -0	4.41 (112)	6.77 (172)	≈ 4.77 (7.10)		
5050RHD-12- <input type="checkbox"/> -0	4.92 (125)	7.28 (185)	≈ 4.82 (7.18)		
5050RHD-13- <input type="checkbox"/> -0	5.39 (137)	7.76 (197)	≈ 4.92 (7.32)		
5050RHD-15- <input type="checkbox"/> -0	5.91 (150)	8.27 (210)	≈ 4.94 (7.35)		
5050RHD-16- <input type="checkbox"/> -0	6.38 (162)	8.74 (222)	≈ 5.02 (7.47)		
5050RHD-17- <input type="checkbox"/> -0	6.89 (175)	9.25 (235)	≈ 5.11 (7.60)		
5050RHD-18- <input type="checkbox"/> -0	7.36 (187)	9.72 (247)	≈ 5.18 (7.71)		
5050RHD-20- <input type="checkbox"/> -0	7.87 (200)	10.24 (260)	≈ 5.22 (7.77)		
5050RHD-21- <input type="checkbox"/> -0	8.35 (212)	10.71 (272)	≈ 5.27 (7.84)		
5050RHD-22- <input type="checkbox"/> -0	8.86 (225)	11.22 (285)	≈ 5.32 (7.91)		
5050RHD-23- <input type="checkbox"/> -0	9.33 (237)	11.69 (297)	≈ 5.39 (8.02)		
5050RHD-25- <input type="checkbox"/> -0	9.84 (250)	12.20 (310)	≈ 5.46 (8.13)		
5050RHD-26- <input type="checkbox"/> -0	10.31 (262)	12.68 (322)	≈ 5.52 (8.22)		
5050RHD-27- <input type="checkbox"/> -0	10.83 (275)	13.19 (335)	≈ 5.59 (8.32)		
5050RHD-28- <input type="checkbox"/> -0	11.30 (287)	13.66 (347)	≈ 5.63 (8.38)		
5050RHD-30- <input type="checkbox"/> -0	11.81 (300)	14.17 (360)	≈ 5.73 (8.53)		
5050RHD-31- <input type="checkbox"/> -0	12.28 (312)	14.65 (372)	≈ 5.76 (8.57)		
5050RHD-32- <input type="checkbox"/> -0	12.79 (325)	15.16 (385)	≈ 5.83 (8.67)		
5050RHD-33- <input type="checkbox"/> -0	13.27 (337)	15.63 (397)	≈ 5.91 (8.79)		
5050RHD-35- <input type="checkbox"/> -0	13.78 (350)	16.14 (410)	≈ 6.04 (8.99)		
5050RHD-36- <input type="checkbox"/> -0	14.25 (362)	16.61 (422)	≈ 5.98 (8.90)		
5050RHD-37- <input type="checkbox"/> -0	14.76 (375)	17.12 (435)	≈ 6.04 (9.00)		
5050RHD-38- <input type="checkbox"/> -0	15.24 (387)	17.60 (447)	≈ 6.12 (9.11)		
5050RHD-40- <input type="checkbox"/> -0	15.75 (400)	18.11 (460)	≈ 6.30 (9.38)		
5050RHD-41- <input type="checkbox"/> -0	16.22 (412)	18.58 (472)	≈ 6.26 (9.31)		
5050RHD-42- <input type="checkbox"/> -0	16.73 (425)	19.09 (485)	≈ 6.45 (9.60)		
5050RHD-43- <input type="checkbox"/> -0	17.20 (437)	19.57 (497)	≈ 6.34 (9.44)		
5050RHD-45- <input type="checkbox"/> -0	17.72 (450)	20.08 (510)	≈ 6.42 (9.55)		
5050RHD-46- <input type="checkbox"/> -0	18.19 (462)	20.55 (522)	≈ 6.53 (9.72)		
5050RHD-47- <input type="checkbox"/> -0	18.70 (475)	21.06 (535)	≈ 6.56 (9.76)		
5050RHD-48- <input type="checkbox"/> -0	19.17 (487)	21.54 (547)	≈ 6.73 (10.01)		
5050RHD-50- <input type="checkbox"/> -0	19.69 (500)	22.05 (560)	≈ 6.79 (10.11)		
5050RHD-51- <input type="checkbox"/> -0	20.16 (512)	22.52 (572)	≈ 6.73 (10.02)		
5050RHD-52- <input type="checkbox"/> -0	20.67 (525)	23.03 (585)	≈ 6.85 (10.19)		
5050RHD-53- <input type="checkbox"/> -0	21.14 (537)	23.50 (597)	≈ 6.91 (10.29)		
5050RHD-55- <input type="checkbox"/> -0	21.65 (550)	24.02 (610)	≈ 7.20 (10.71)		
5050RHD-60- <input type="checkbox"/> -0	23.62 (600)	25.98 (660)	≈ 7.35 (10.94)		

Choose from the radii below for all of the above sizes
Radius (mm) Example: 5050RHD-30-300-0

	250	300	350	400	500
R	9.84 (250)	11.81 (300)	13.78 (350)	15.75 (400)	19.69 (500)
H ⁺¹⁰	9.53 (242)	9.53 (242)	9.53 (242)	9.53 (242)	9.53 (242)
D ⁺⁵⁰	49.21 (1250)	61.02 (1550)	67.72 (1720)	78.35 (1990)	96.85 (2460)
K	78.82 (2002)	96.73 (2457)	107.48 (2730)	125.39 (3185)	154.06 (3913)



PDF: igus.com/e-chain-pdfs
 Product information: igus.com/e-chains

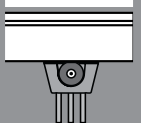
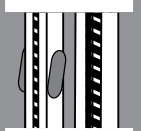
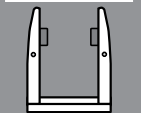
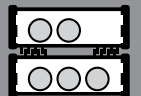
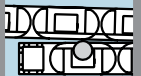

There are 4 options for the igus® autoglide system:



Version 01 - For igus® E4-1 e-chains®

Special crossbars in the inner radius of the e-chain® fitted with molded-on autoglide grooves

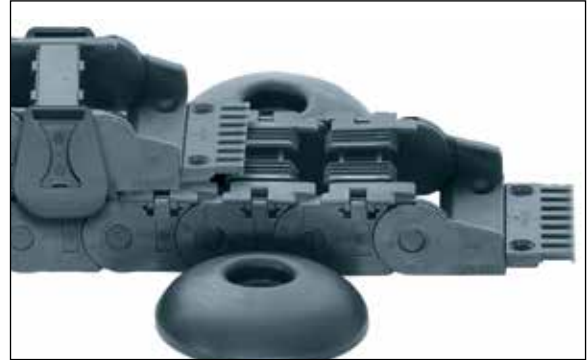

Version 02 - For igus® E2/000 e-chains®

Special crossbars with molded-on autoglide grooves. To be opened along the inner radius.

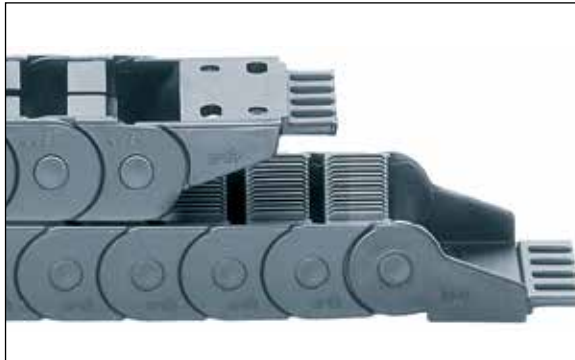

Version 03 - For igus® E-Z Chains

Combination of the easily fillable E-Z Chain and injection-molded autoglide grooves in the inner radius



Version 04 - For Series E2/000 e-chains®

Special plastic autoglide grooves side-mounted on the e-chain® hold the e-chain® "in the track"

Save on long travels, self-guiding e-chains® - autoglide

Long travels are always demanding for an e-chain system®. For much of the travel, the e-chain® must run on the lower run or on the glide bars. In addition the e-chain system® needs guides, in order to prevent a sideways movement. In most cases this is ensured through a guide trough. However, there are also applications where a guide trough is not desired for space reasons, whether this is due to optical considerations or spatial conditions. In order to cater for this possibility, igus® developed the autoglide system in 1995. autoglide is a self-aligning e-chain®, which can eliminate guide troughs for up to 262 ft. (80 m) travel.

- Travels up to 262 ft. (80 m) and travel speeds up to 8.20 ft/s (2.5 m/s)
- Cost-effective solution, guide troughs not required
- Very quick installation times for long travels
- Small installation width, quiet operation

Typical industries and applications

- Industrial vehicles
- Long travels with easier filling
- Simple outdoor applications

Special solutions for long travel autoglide - Self-guiding e-chain systems®

Selection Table - Technical Data

Series	Inner height <i>hi</i> in. (mm)	Inner width <i>Bi</i> in. (mm)	Outer width <i>Ba</i> in. (mm)	Outer height <i>ha</i> in. (mm)	Bending radius <i>R</i> in. (mm)	Maximum Travel ft. (m)
--------	---------------------------------------	--------------------------------------	--------------------------------------	---------------------------------------	--	------------------------------



**Version 01 autoglide -
Self-guiding e-chains® for system E4-1**
Crossbars in the inner radius of the e-chain®
fitted with molded-on autoglide grooves

E4-32AG	1.26 (32)	4.41-10.31 (112-262)	5.35-11.26 (136-286)	2.13 (54)	3.94-11.81 (100-300)	196.9 (60)
E4-42AG	1.65 (42)	4.41-10.31 (112-262)	5.47-11.38 (139-289)	2.52 (64)	4.92-13.78 (125-350)	229.7 (70)
E4-56AG	2.20 (56)	5.91-9.84 (150-250)	7.24-11.18 (184-284)	3.31 (84)	5.91-19.69 (150-500)	262.5 (80)



**Version 02 autoglide -
Self-guiding e-chains® for system E2/000**
Crossbars in the inner radius of the e-chain®
fitted with molded-on autoglide grooves

2400AG	.98 (25)	2.24-3.03 (57-77)	2.87-3.66 (73-93)	1.38 (35)	2.95-9.84 (075-250)	131.2 (40)
2600AG	1.38 (35)	1.97-2.95 (50-75)	2.60-3.58 (66-91)	1.97 (50)	2.95-9.84 (075-250)	196.9 (60)
3400AG	1.77 (45)	2.95-3.94 (75-100)	3.74-4.72 (95-120)	2.52 (64)	3.94-11.81 (100-300)	229.7 (70)



**Version 03 autoglide -
Easy filling - simply press cables in**
E-Z Chain Design in the outer radius, fitted with molded-on
autoglide grooves in the inner radius

EA16	1.26 (32)	1.89 (48)	2.36 (60)	1.54 (39)	2.56-3.94 (065-100)	65.6 (20)
EA25	.98 (25)	1.97 (50)	2.36 (60)	.99 (25.2)	2.95-3.94 (075-100)	65.6 (20)



**Version 04 autoglide -
Special glide elements provide a secure guidance**
on E2/000: e-chain®, half and full E-Tubes

2400/2500-AG	.98 (25)	2.24-4.92 (57-125)	2.87-5.55 (73-141)	1.38 (35)	2.17-9.84 (055-250)	65.6 (20)
2600/2700-AG	1.38 (35)	1.97-9.84 (50-250)	2.60-7.64 (66-194)	1.97(50)	2.95-9.84 (075-250)	98.4 (30)

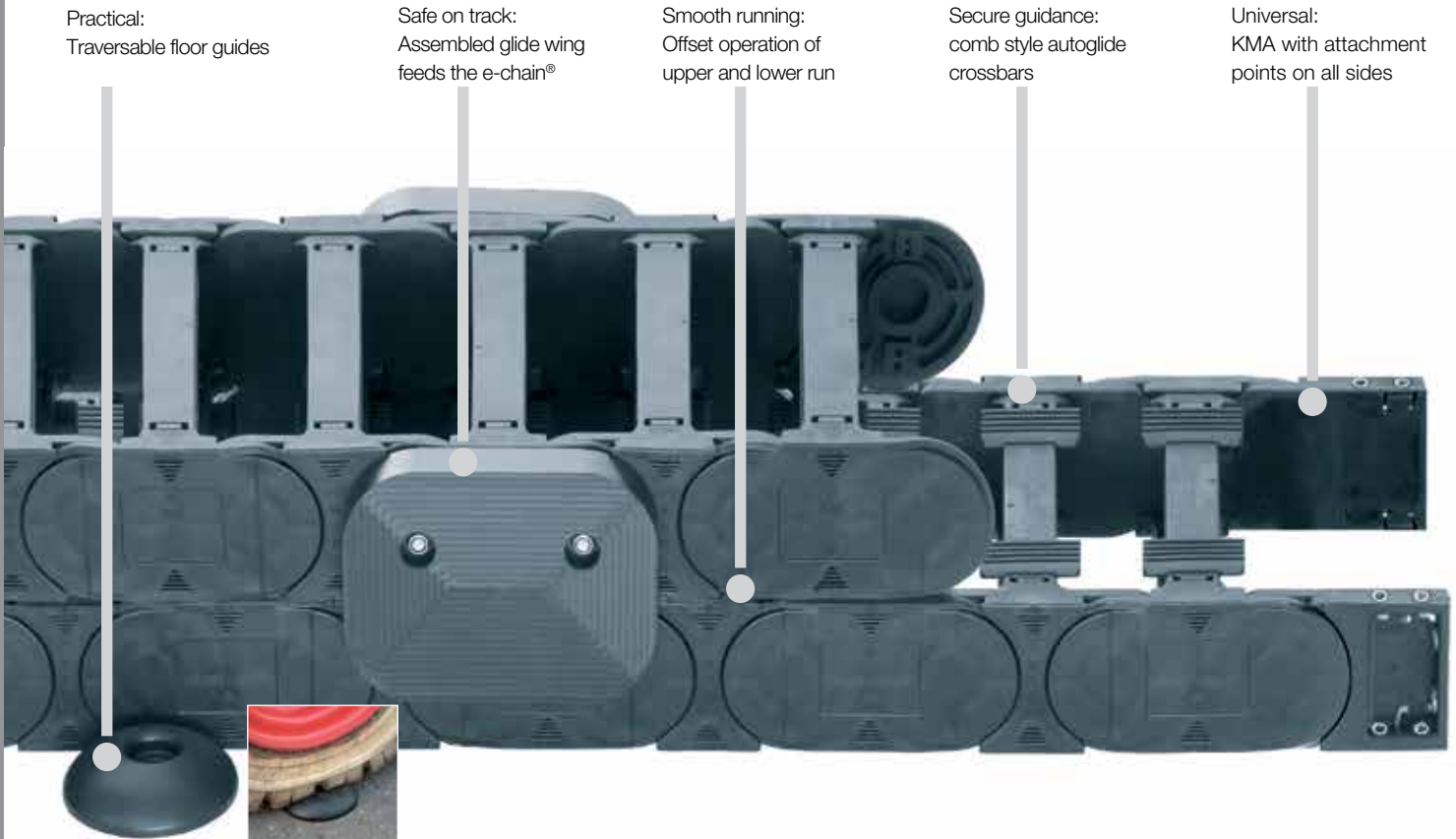

Practical:
Traversable floor guides

Safe on track:
Assembled glide wing
feeds the e-chain®

Smooth running:
Offset operation of
upper and lower run

Secure guidance:
comb style autoglide
crossbars

Universal:
KMA with attachment
points on all sides

Self-guiding e-chains® for System E4-1 autoglide Version 01

For the larger e-chains® of the E4-1 system - crossbars in the inner radius of the e-chains® are provided with injection-molded glide shoes. **Glide wings and floor guides** - Simple guide elements for quick installation on the subsurface are available for the autoglide system version 01. The traversable eccentric floor guides are fastened every 6.56 ft.(2 m) on the subsurface. The glide wing fastened on the moving end feeds the e-chains® and holds this securely in the track. The autoglide crossbars safely guide the e-chains® and replace the guide trough.

- Save purchase and installation costs with this system
- Traversable over floor guide for travel distances over 32.8 ft.(10 m).

Note: Only two glide wings **AG-XXX-OF** are required for the safe feeding of the e-chains®. The mounting of the glide wing is done on the outer link of the upper run, which is laid down first on the lower run.

Typical industries and applications

- Industrial vehicles
- Long travels with easier filling
- Simple outdoor applications

Special solutions for long travel autoglide - Self-guiding e-chain systems® Version 01 - Technical Data - Order Examples



autoglide with assembled glide wing. Module, containing 3 e-chain® links and 2 glide wings
Part No. E4-32-15-150-0-AG-OF-NC



autoglide self-guiding e-chains®
Part No. E4-32-15-150-0-AG-NC



Glide wing Part No. AG-280-OF and floor guide Part No. AG-380-BF as single parts



Part number structure E4-32-15-150-0-AG-OF-NC



Order example | Part number structure



Order example for complete e-chain® Series E4-32AG 49.2 ft. (15 m), color black, with mounting brackets and interior separation:

e-chain® 49.2 ft. (15 m)	Please indicate e-chain® length or number of links: 49.2 ft. (15 m) or 287 links	E4-32-15-150-0-AG-NC
e-chain® + glide wing	Module, containing 3 e-chain® links and 2 glide wings	E4-32-15-150-0-AG-OF-NC
+ Floor guides	8 pieces (2 pieces every 6.56 ft. (2 m) from the half of travel)	AG-380-BF

Order text: 49.2 ft. (15 m) E4-32-15-150-0-AG-NC + E4-32-15-150-0-AG-OF-NC + AG-380-BF + Mounting bracket + Interior separation (optional)

Note: We require one glide wing per e-chain® to the left and right at the position where the upper run first meets the lower run.

Long travels	from 32.8 ft. (10 m) up to max. 262 ft. (80 m)
Speed max. gliding / acceleration max. gliding	max. 8.20 ft/s (2.5 m/s) / max. 8.20 ft/s² (2.5 m/s²)
Material - permitted temperature	igumid G / -40°F (-40°C) up to +248°F (+120° C)
Flammability Class, igumid G	VDE 0304 IIC UL94 HB

Technical Data



Details of material properties

► Chapter 1



Series E4-32AG - openable along both radii, crossbars every link - autoglide crossbars along the inner radius

Supplement part number with required radius. Example: E4-32-15-150-0-AG-NC
 Pitch: 2.20 in. (56 mm) per link links/ft (m) = 5.49 (18)

Part Number			Weight	Glide Wing	Floor Guide
Crossbars	<i>Bi</i>	<i>Ba</i>		Single part	Single part
Every Link	in. (mm)	in. (mm)	lbs/ft (kg/m)		
E4-32-112- <input type="checkbox"/> -0-AG-NC	4.41 (112)	5.35 (136)	≈ 1.42 (2.106)	AG-380-OF	AG-380-BF
E4-32-12- <input type="checkbox"/> -0-AG-NC	4.92 (125)	5.83 (148)	≈ 1.46 (2.176)	AG-380-OF	AG-380-BF
E4-32-15- <input type="checkbox"/> -0-AG-NC	5.91 (150)	6.81 (173)	≈ 1.57 (2.343)	AG-380-OF	AG-380-BF
E4-32-17- <input type="checkbox"/> -0-AG-NC	6.61 (168)	7.52 (191)	≈ 1.64 (2.444)	AG-380-OF	AG-380-BF
E4-32-20- <input type="checkbox"/> -0-AG-NC	7.87 (200)	8.78 (223)	≈ 1.79 (2.657)	AG-380-OF	AG-380-BF
E4-32-262- <input type="checkbox"/> -0-AG-NC	10.31 (262)	11.26 (286)	≈ 2.05 (3.050)	AG-380-OF	AG-380-BF

Choose from the radii below for all of the above sizes

Radius (mm) Example: E4-32-15- 150 -0-AG-NC

	100	125	150	175	200	220	250	300
<i>R</i>	3.94 (100)	4.92 (125)	5.91 (150)	6.89 (175)	7.87 (200)	8.66 (220)	9.84 (250)	11.81 (300)
<i>H</i>	6.54 (166)	6.54 (166)	6.54 (166)	6.54 (166)	6.54 (166)	6.54 (166)	6.54 (166)	6.54 (166)
<i>D</i>	14.57 (370)	18.50 (470)	19.69 (500)	25.79 (655)	30.31 (770)	35.43 (900)	36.61 (930)	43.31 (1100)
<i>K</i>	33.07 (840)	40.71 (1064)	48.50 (1232)	61.73 (1568)	72.76 (1848)	81.57 (2072)	88.19 (2240)	105.83 (2688)

Special solutions for long travel

autoglide - Version 01 - Self-guiding e-chain systems®

E4-32AG - Installation Dimensions



autoglide

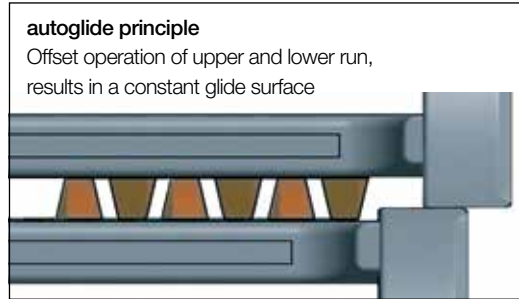
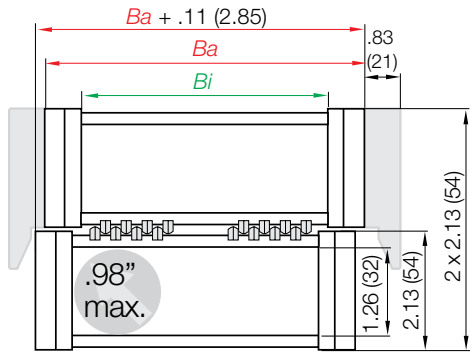
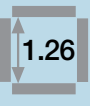

Gliding applications

Long travel lengths up to 197 ft. (60 m), Fill weights up to 3.36 to 4.70 lbs/ft (5.0 to 7.0 kg/m)

In case of travels less than 32.8 ft. (10m) we recommend a self-supporting e-chain®.

NOTE: Systems of this type should be designed by our system design engineers.

Please contact iglus® for assistance with your application.

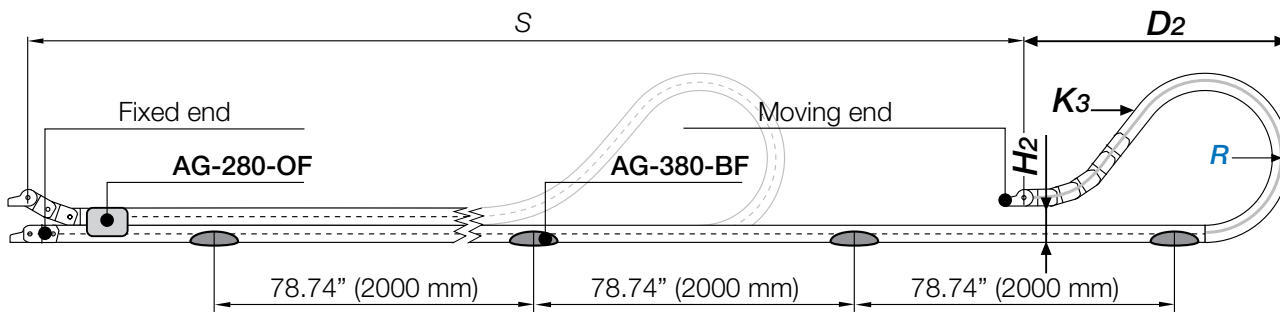

	3.94 (100)	4.92 (125)	5.91 (150)	6.89 (175)	7.87 (200)	8.66 (220)	9.84 (250)	11.81 (300)
R	3.94 (100)	4.92 (125)	5.91 (150)	6.89 (175)	7.87 (200)	8.66 (220)	9.84 (250)	11.81 (300)
H_i	6.54 (166)	6.54 (166)	6.54 (166)	6.54 (166)	6.54 (166)	6.54 (166)	6.54 (166)	6.54 (166)
D₂	14.57 (370)	18.50 (470)	19.69 (500)	25.79 (655)	30.31 (770)	35.43 (900)	36.61 (930)	43.31 (1100)
K₃	33.07 (840)	40.71 (1064)	48.50 (1232)	61.73 (1568)	72.76 (1848)	81.57 (2072)	88.19 (2240)	105.83 (2688)

Legend

- S = Length of travel
- R = Bending radius
- H_i = Trough inner height
- H = *Mounting height
- D₂ = Overlength - long travels, gliding

Pitch per link = 2.20" (56 mm)
 Links per ft (m) = 5.49 (18)
 For center mount applications:
 Chain length = S + K₃

Available Accessories



Optimized, cable-friendly interior separation program



Pivoting KMA mounting brackets with attachment points on all sides

PDF: igus.com/e-chain-pdfs
 Product information: igus.com/e-chains

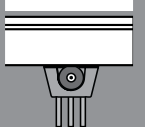
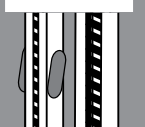
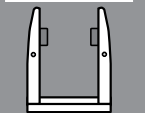
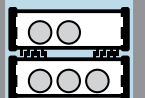
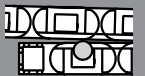



Series E4-42AG - openable along both radii, crossbars every link - autoglide crossbars along the inner radius

Supplement part number with required radius. Example: E4-42-15-150-0-AG-NC
 Pitch: 2.64 in. (67 mm) per link links/ft (m) = 4.57 (15)

Part Number		<i>Bi</i>	<i>Ba</i>	Weight	Glide Wing	Floor Guide
Crossbars		in. (mm)	in. (mm)	lbs/ft (kg/m)	Single part	Single part
Every Link						
E4-42-112-	<input type="checkbox"/> -0-AG-NC	4.41 (112)	5.47 (139)	≈ 1.59 (2.372)	AG-380-OF	AG-380-BF
E4-42-12-	<input type="checkbox"/> -0-AG-NC	4.92 (125)	5.94 (151)	≈ 1.63 (2.430)	AG-380-OF	AG-380-BF
E4-42-15-	<input type="checkbox"/> -0-AG-NC	5.91 (150)	6.93 (176)	≈ 1.73 (2.569)	AG-380-OF	AG-380-BF
E4-42-17-	<input type="checkbox"/> -0-AG-NC	6.61 (168)	7.64 (194)	≈ 1.78 (2.654)	AG-380-OF	AG-380-BF
E4-42-20-	<input type="checkbox"/> -0-AG-NC	7.87 (200)	8.90 (226)	≈ 1.90 (2.831)	AG-380-OF	AG-380-BF
E4-42-262-	<input type="checkbox"/> -0-AG-NC	10.31 (262)	11.38 (289)	≈ 2.12 (3.159)	AG-380-OF	AG-380-BF

Choose from the radii below for all of the above sizes

Radius (mm) Example: E4-42-15-150-0-AG-NC

	125	150	160	175	200	250	250	300
<i>R</i>	4.92 (125)	5.91 (150)	6.30 (160)	6.89 (175)	7.87 (200)	9.84 (250)	11.81 (300)	13.78 (350)
<i>H</i>	7.32 (186)	7.32 (186)	7.32 (186)	7.32 (186)	7.32 (186)	7.32 (186)	7.32 (186)	7.32 (186)
<i>D</i>	18.70 (475)	22.44 (570)	24.53 (623)	26.38 (670)	30.71 (780)	40.55 (1030)	45.28 (1150)	59.06 (1500)
<i>K</i>	44.84 (1139)	52.76 (1340)	58.03 (1474)	63.31 (1608)	73.86 (1876)	94.96 (2412)	111.89 (2747)	139.80 (3551)

Special solutions for long travel autoglide - Version 01- Self-guiding e-chain systems® E4-42AG - Installation Dimensions



autoglide

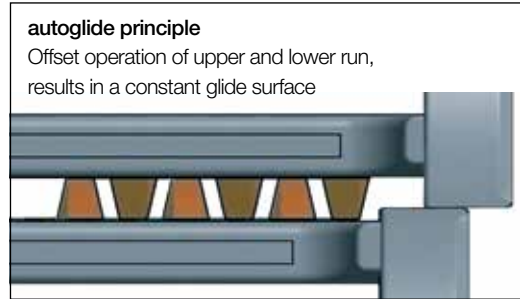
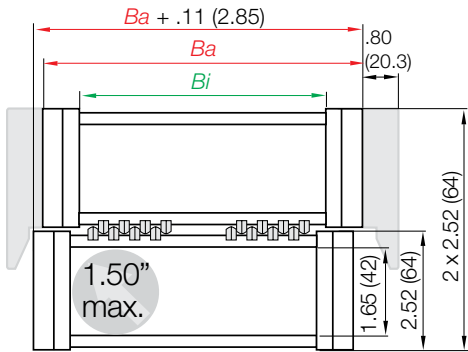

Gliding applications

Long travel lengths up to 230 ft. (70 m), Fill weights up to 2.69 to 6.45 lbs/ft (4.0 to 9.6 kg/m)

In case of travels less than 32.8 ft. (10m) we recommend a self-supporting e-chain®.

NOTE: Systems of this type should be designed by our system design engineers.

Please contact iglus® for assistance with your application.

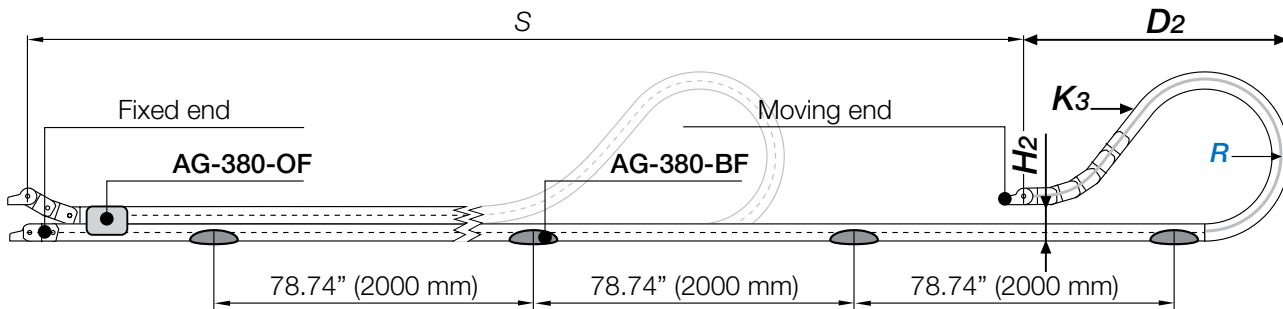

	4.92 (125)	5.91 (150)	6.30 (160)	6.89 (175)	7.87 (200)	9.84 (250)	11.81 (300)	13.78 (350)
R	4.92 (125)	5.91 (150)	6.30 (160)	6.89 (175)	7.87 (200)	9.84 (250)	11.81 (300)	13.78 (350)
H _i	7.32 (186)	7.32 (186)	7.32 (186)	7.32 (186)	7.32 (186)	7.32 (186)	7.32 (186)	7.32 (186)
D ₂	18.70 (475)	22.44 (570)	24.53 (623)	26.38 (670)	30.71 (780)	40.55 (1030)	45.28 (1150)	59.06 (1500)
K ₃	44.84 (1139)	52.76 (1340)	58.03 (1474)	63.31 (1608)	73.86 (1876)	94.96 (2412)	111.89 (2747)	139.80 (3551)

Legend

- S = Length of travel
- R = Bending radius
- H_i = Trough inner height
- H₂ = *Mounting height
- D₂ = Overlength - long travels, gliding

Pitch per link = 2.64" (67 mm)

Links per ft (m) = 4.57 (15)

For center mount applications:

Chain length = S + K₃

Available Accessories



Optimized, cable-friendly interior separation program



Pivoting KMA mounting brackets with attachment points on all sides

PDF: iglus.com/e-chain-pdfs
Product information: iglus.com/e-chains

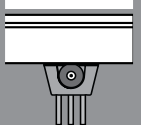
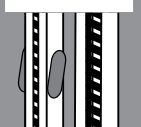
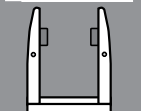
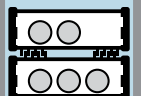
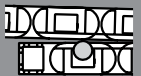



Series E4-56AG - openable along both radii, crossbars every link - autoglide crossbars along the inner radius

Supplement part number with required radius. Example: E4-56-15--0-AG-NC
 Pitch: 3.58 in. (91 mm) per link links/ft (m) = 3.35 (11)

Part Number			Weight	Glide Wing	Floor Guide
Crossbars	<i>Bi</i>	<i>Ba</i>		Single part	Single part
Every Link	in. (mm)	in. (mm)	lbs/ft (kg/m)		
E4-56-15- <input type="text" value="150"/> -0-AG-NC	5.91 (150)	7.24 (184)	≈2.76 (4.109)	AG-400-OF	AG-400-BF
E4-56-21- <input type="text" value="150"/> -0-AG-NC	8.35 (212)	9.72 (247)	≈3.07 (4.567)	AG-400-OF	AG-400-BF
E4-56-25- <input type="text" value="150"/> -0-AG-NC	9.84 (250)	11.18 (284)	≈3.29 (4.896)	AG-400-OF	AG-400-BF

Choose from the radii below for all of the above sizes
Radius (mm) Example: E4-56-15--0-AG-NC

	150	175	200	240	250	300	350	400	450	500
<i>R</i>	5.91 (150)	6.89 (175)	7.87 (200)	9.45 (240)	9.84 (250)	11.81 (300)	13.78 (350)	15.75 (400)	17.72 (450)	19.69 (500)
<i>H</i>	10.47 (266)	10.47 (266)	10.47 (266)	10.47 (266)	10.47 (266)	10.47 (266)	10.47 (266)	10.47 (266)	10.47 (266)	10.47 (266)
<i>D</i>	17.72 (450)	22.83 (580)	27.95 (710)	35.43 (900)	38.58 (980)	46.46 (1180)	56.69 (1440)	60.24 (1530)	66.93 (1700)	72.83 (1850)
<i>K</i>	42.99 (1092)	57.32 (1456)	68.07 (1729)	85.98 (2184)	93.15 (2366)	111.06 (2821)	128.98 (3276)	143.31 (3640)	161.22 (4095)	179.13 (4550)

Special solutions for long travel autoglide - Version 01 - Self-guiding e-chain systems® E4-56AG - Installation Dimensions



autoglide

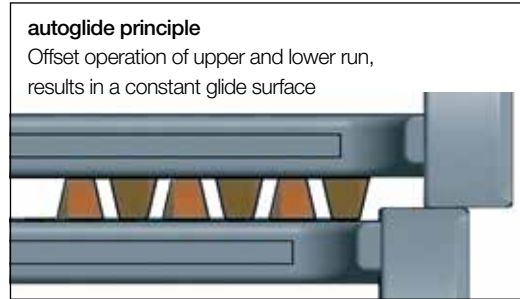
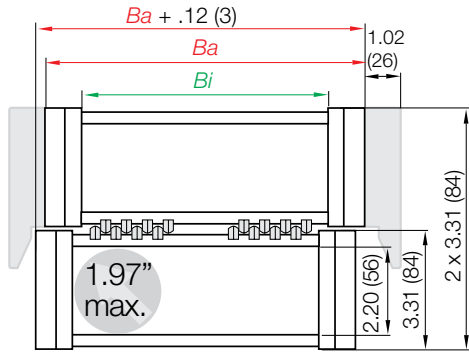

Gliding applications

Long travel lengths up to 262 ft. (80 m), Fill weights up to 4.30 to 8.06 lbs/ft (6.4 to 12.0 kg/m)

In case of travels less than 32.8 ft. (10m) we recommend a self-supporting e-chain®.

NOTE: Systems of this type should be designed by our system design engineers.

Please contact igus® for assistance with your application.

Pitch per link: = 3.58" (91 mm)

Links per ft (m): = 3.35 (11)

For center mount applications:

Chain length = $S + K_3$

Legend

- S = Length of travel
- R = Bending radius
- H_{in} = Trough inner height
- H_z = *Mounting height
- D = Overlength - long travels, gliding

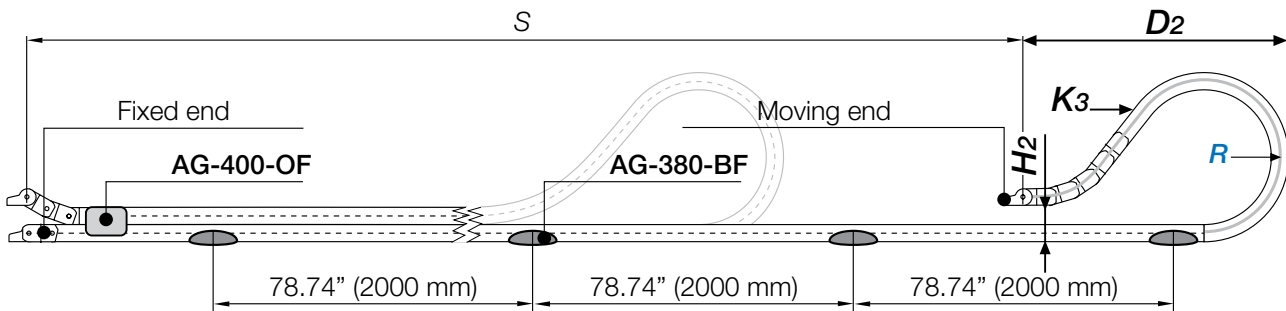

R	5.91 (150)	6.89 (175)	7.87 (200)	9.45 (240)	9.84 (250)	11.81 (300)	13.78 (350)	15.75 (400)	17.72 (450)	19.69 (500)
H _z	10.47 (266)	10.47 (266)	10.47 (266)	10.47 (266)	10.47 (266)	10.47 (266)	10.47 (266)	10.47 (266)	10.47 (266)	10.47 (266)
D	17.72 (450)	22.83 (580)	27.95 (710)	35.43 (900)	38.58 (980)	46.46 (1180)	56.69 (1440)	60.24 (1530)	66.93 (1700)	72.83 (1850)
K ₃	42.99 (1092)	57.32 (1456)	68.07 (1729)	85.98 (2184)	93.15 (2366)	111.06 (2821)	128.98 (3276)	143.31 (3640)	161.22 (4095)	179.13 (4550)

Available Accessories



Optimized, cable-friendly interior separation program



Pivoting KMA mounting brackets with attachment points on all sides

PDF: igus.com/e-chain-pdfs
Product information: igus.com/e-chains

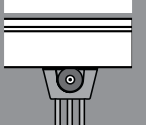
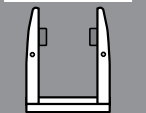
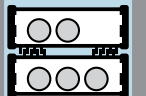

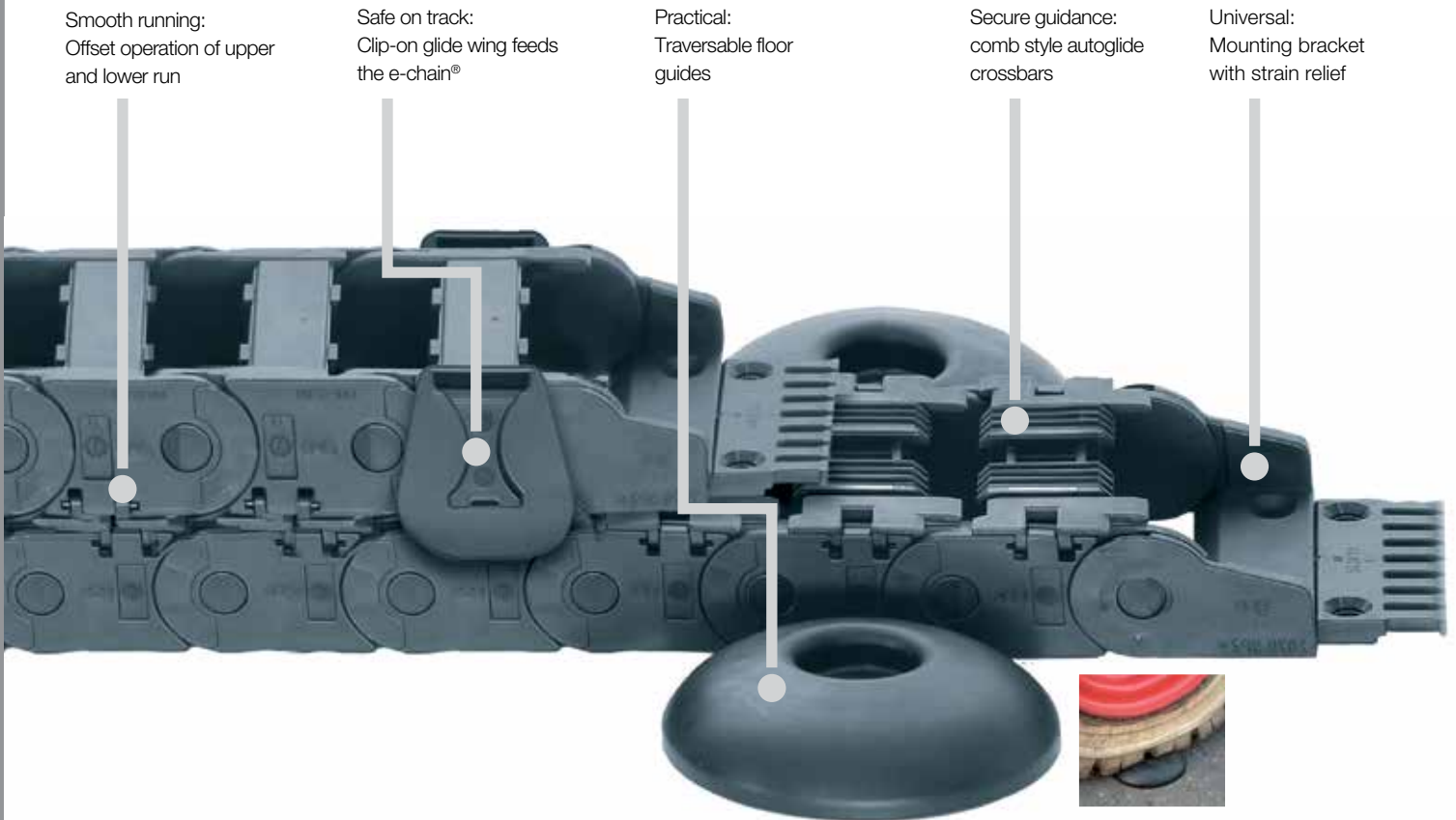

Self-guiding e-chains[®] for System E2/000 autoglide Version 02

Interfering guide troughs for long travels can be dispensed with when using the autoglide system. Self-guiding e-chains[®] glide safely on top of each other for up to 230 ft. (70 m). The system has now been extended to the igus[®] E2/000 and further improved. The autoglide crossbars ensure even longer life. A plug-in glide wing ensures safe e-chain[®] threading over the first few feet (meters) of travel. The traversable eccentric floor guides are fastened to the subsurface every 6.56 ft. (2 m).

- Travels up to 230 ft. (70 m) without guide trough at speeds up to 6.56 ft/s (2.0 m/s)
- Very compact, no interfering trough in the travel or work area
- Fast installation times for long travels
- Snap-open in the inner radius
- Also for "half tube" fully enclosed in the outer radius
- Clip-on glide wings, safe threading in of the e-chain[®]
- Drive-over floor guide

Typical industries and applications

- Greenhouses
- Storage and retrieval systems
- Conveyor systems
- Indoor cranes
- Handling
- And many other long travels

Special solutions for long travel autoglide - Version 02 - Self-guiding e-chain systems® Technical Data - Order Examples



Part number structure

2400-05AG-100-0



Order example | Part number structure



Order example for complete e-chain® Series E4-32AG 49.2 ft. (15 m), color black, with mounting brackets and interior separation:

e-chain® 49.2 ft. (15 m)	Please indicate e-chain® length or number of links: 49.2 ft. (15 m) or 347 links	2400-15AG-100-0
+ glide wing	2 glide wings are required per e-chain®	AG-2400-OF
+ Floor guides	8 pieces (2 pieces every 6.56 ft. (2 m) from the half of travel)	AG-380-BF

Order text: 49.2 ft. (15 m) 2400-05AG-100-0 + AG-2400-OF + AG-380-BF + Mounting bracket + Interior separation (optional)

Note: We require one glide wing per e-chain® to the left and right at the position where the upper run first meets the lower run.

Speed max. rolling	max. 6.56 ft/s (2 m/s)
Acceleration max. gliding	max. 3.28 ft/s ² (1 m/s ²)
Material - permitted temperature	igumid G / -40°F (-40°C) up to +248°F (+120° C)
Flammability Class, igumid G	VDE 0304 IIC UL94 HB

Technical Data



Details of material properties

► Chapter 1



Series 2400AG - snap-open along the inner radius - crossbars with molded-on autoglide grooves

Supplement part number with required radius. Example: 2400-05AG--0
 Pitch: 1.814 in. (46 mm) per link links/ft (m) = 6.63 (22)

Part Number	Radius		Weight	Glide Wing	Floor Guide			
Crossbars	<i>Bi</i>	<i>Ba</i>		Single part	Single part			
Every Link	in. (mm)	in. (mm)	lbs/ft (kg/m)					
2400-05AG- <input type="text" value="150"/> -0	2.24 (57)	2.87 (73)	≈0.67 (1.00)	AG-2400-OF	AG-380-BF			
2400-07AG- <input type="text" value="150"/> -0	3.03 (77)	3.66 (93)	≈0.74 (1.10)	AG-2400-OF	AG-380-BF			
Choose from the radii below for all of the above sizes								
<i>Radius</i> (mm) Example: 2400-05AG- <input type="text" value="150"/> -0								
	<input type="text" value="075"/>	<input type="text" value="100"/>	<input type="text" value="125"/>	<input type="text" value="150"/>	<input type="text" value="175"/>	<input type="text" value="200"/>	<input type="text" value="225"/>	<input type="text" value="250"/>
<i>R</i>	2.95 (75)	3.94 (100)	4.92 (125)	5.91 (150)	6.89 (175)	7.87 (200)	8.66 (220)	9.84 (250)
<i>H</i>	5.91 (150)	3.94 (100)	3.94 (100)	3.94 (100)	3.94 (100)	3.94 (100)	3.94 (100)	3.94 (100)
<i>D</i>	6.38 (162)	14.96 (380)	17.32 (440)	23.23 (590)	29.72 (755)	37.40 (950)	40.94 (1040)	44.49 (1130)
<i>K</i>	23.54 (598)	36.22 (920)	41.65 (1058)	56.14 (1426)	70.63 (1794)	86.93 (2208)	95.98 (2438)	105.04 (2668)

Special solutions for long travel autoglide - Version 02 - Self-guiding e-chain systems® 2400AG - Installation Dimensions



autoglide

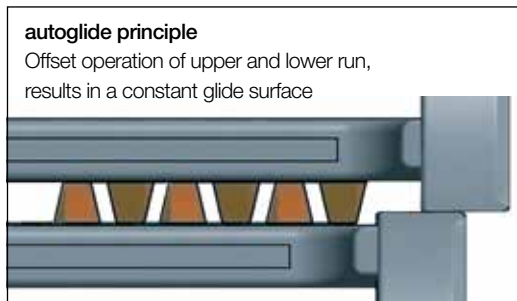
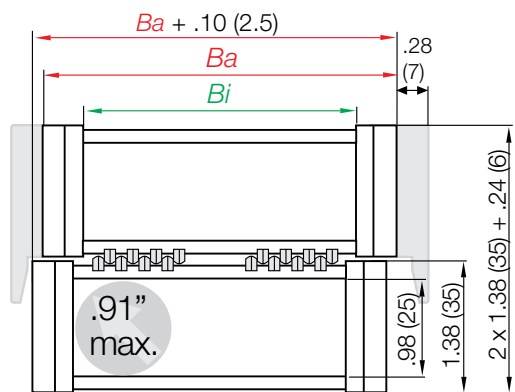

Gliding applications

Long travel lengths up to 131 ft. (40 m), Fill weights up to 1.34 lbs/ft (2.0 kg/m)

In case of travels between 13 ft. (4 m) and 32.8 ft. (10m) we recommend an self-supporting e-chain®.

NOTE: Systems of this type should be designed by our system design engineers.

Please contact igus® for assistance with your application.

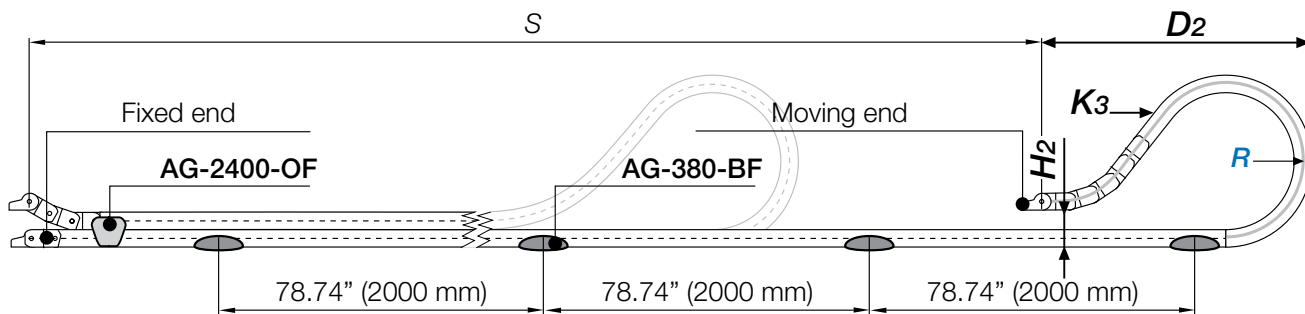

R	2.95 (075)	3.94 (100)	4.92 (125)	5.91 (150)	6.89 (175)	7.87 (200)	8.66 (220)	9.84 (250)
H _i	5.91 (150)	3.94 (100)	3.94 (100)	3.94 (100)	3.94 (100)	3.94 (100)	3.94 (100)	3.94 (100)
D ₂	6.38 (162)	14.96 (380)	17.32 (440)	23.23 (590)	29.72 (755)	37.40 (950)	40.94 (1040)	44.49 (1130)
K ₃	23.54 (598)	36.22 (920)	41.65 (1058)	56.14 (1426)	70.63 (1794)	86.93 (2208)	95.98 (2438)	105.04 (2668)

Legend

- S = Length of travel
- R = Bending radius
- H_i = Trough inner height
- H₂ = *Mounting height
- D₂ = Overlength - long travels, gliding

Pitch per link = 1.81" (46 mm)

Links per ft (m) = 6.63 (22)

For center mount applications:

Chain length = S + K₃

Available Accessories



Optimized, cable-friendly interior separation program



Pivoting mounting brackets for gliding applications



Pivoting KMA mounting brackets with attachment points on all sides

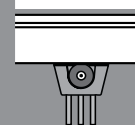
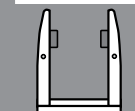
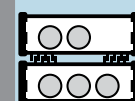



Series 2600AG - snap-open along the inner radius - crossbars with molded-on autoglide grooves

Supplement part number with required radius. Example: 2600-05AG--0

Pitch: 2.20 in. (56 mm) per link links/ft (m) = 5.45 (18)

Part Number		Weight	Glide Wing	Floor Guide
Crossbars			Single part	Single part
Every Link		lbs/ft (kg/m)		
2600-05AG- <input type="text" value="150"/> -0	<i>Bi</i> 1.97 (50) in. (mm)	<i>Ba</i> 2.60 (66) in. (mm)	≈ 0.85 (1.27)	AG-2600-OF AG-380-BF
2600-07AG- <input type="text" value="150"/> -0	2.95 (75)	3.58 (91)	≈ 0.94 (1.40)	AG-2600-OF AG-380-BF

Choose from the radii below for all of the above sizes

Radius (mm) Example: 2600-05AG--0

	075	100	125	150	175	200	250
<i>R</i>	2.95 (75)	3.94 (100)	4.92 (125)	5.91 (150)	6.89 (175)	7.87 (200)	9.84 (250)
<i>H</i>	5.91 (150)	6.54 (166)	6.54 (166)	6.54 (166)	6.54 (166)	6.54 (166)	6.54 (166)
<i>D</i>	5.91 (150)	13.78 (350)	18.70 (475)	19.69 (500)	25.79 (655)	30.31 (770)	37.40 (950)
<i>K</i>	24.25 (616)	33.07 (840)	44.09 (1120)	48.50 (1232)	61.73 (1568)	72.76 (1848)	90.39 (2296)

Special solutions for long travel autoglide - Version 02 - Self-guiding e-chain systems® 2600AG - Installation Dimensions



autoglide

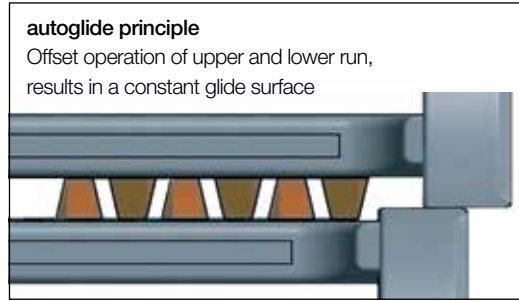
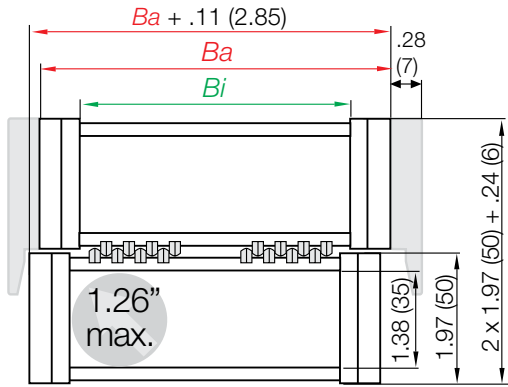

Gliding applications

Long travel lengths up to 197 ft. (60 m), Fill weights up to 1.68 lbs/ft (2.5 kg/m)

In case of travels between 16.4 ft. (5 m) and 32.8 ft. (10m) we recommend a self-supporting e-chain®.

NOTE: Systems of this type should be designed by our system design engineers.

Please contact igus® for assistance with your application.

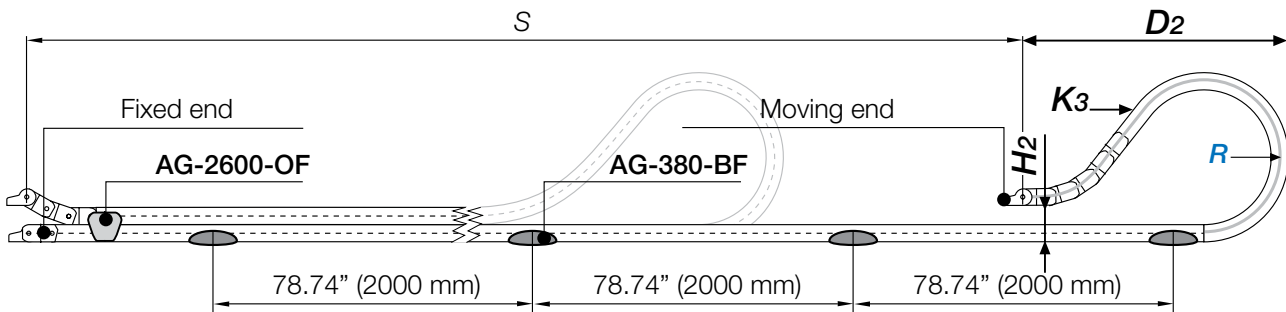

	2.95 (075)	3.94 (100)	4.92 (125)	5.91 (150)	6.89 (175)	7.87 (200)	9.84 (250)
R	2.95 (075)	3.94 (100)	4.92 (125)	5.91 (150)	6.89 (175)	7.87 (200)	9.84 (250)
H	5.91 (150)	6.54 (166)	6.54 (166)	6.54 (166)	6.54 (166)	6.54 (166)	6.54 (166)
D	5.91 (150)	13.78 (350)	18.70 (475)	19.69 (500)	25.79 (655)	30.31 (770)	37.40 (950)
K	24.25 (616)	33.07 (840)	44.09 (1120)	48.50 (1232)	61.73 (1568)	72.76 (1848)	90.39 (2296)

Legend

- S = Length of travel
- R = Bending radius
- H_{in} = Trough inner height
- H_o = Mounting height
- D_o = Overlength - long travels, gliding

Pitch per link: = 2.20" (56 mm)

Links per ft (m): = 5.49 (18)

For center mount applications:

Chain length = S + K₃

PDF: igus.com/e-chain-pdfs
Product information: igus.com/e-chains

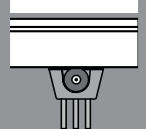
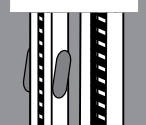
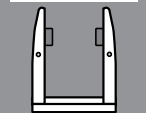
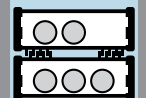

Available Accessories



Optimized,
cable-friendly interior
separation program



Pivoting mounting brackets
for gliding applications



Pivoting KMA mounting
brackets with attachment
points on all sides



Series 3400AG - snap-open along the inner radius - crossbars with molded-on autoglide grooves

Supplement part number with required radius. Example: 3400-100AG--0
 Pitch: 2.64 in. (67 mm) per link links/ft (m) = 4.55 (15)

Part Number		Weight	Glide Wing	Floor Guide
Crossbars	<i>Bi</i>	<i>Ba</i>	Single part	Single part
Every Link	in. (mm)	in. (mm)		
3400-05AG- <input type="text" value=""/> -0	2.95 (75)	3.74 (95)	≈1.27 (1.89)	AG-3400-OF AG-380-BF
3400-07AG- <input type="text" value=""/> -0	3.94 (100)	4.72 (120)	≈1.37 (2.04)	AG-3400-OF AG-380-BF

Choose from the radii below for all of the above sizes
 Radius (mm) Example: 3400-05AG--0

	100	125	150	200	250	300
<i>R</i>	3.94 (100)	4.92 (125)	5.91 (150)	7.87 (200)	9.84 (250)	11.81 (300)
<i>H</i>	7.87 (200)	7.32 (186)	7.32 (186)	7.32 (186)	7.32 (186)	7.32 (186)
<i>D</i>	9.17 (233)	18.70 (475)	22.44 (570)	30.71 (780)	39.76 (1010)	45.28 (1150)
<i>K</i>	34.29 (871)	44.84 (1139)	55.39 (1407)	73.86 (1876)	94.96 (2412)	108.15 (2747)

Special solutions for long travel autoglide - Version 02 - Self-guiding e-chain systems® 3400AG - Installation Dimensions



autoglide

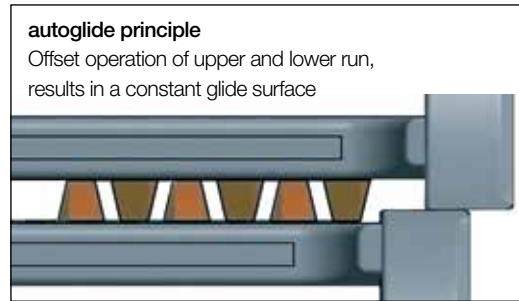
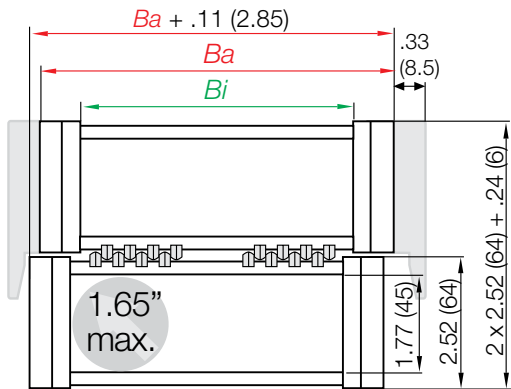

Gliding applications

Long travel lengths up to 230 ft. (70 m), Fill weights up to 3.36 to 5.38 lbs/ft (5.0 to 8.0 kg/m)

In case of travels between 19.7 ft. (6 m) and 32.8 ft. (10m) we recommend an self-supporting e-chain®.

NOTE: Systems of this type should be designed by our system design engineers.

Please contact igus® for assistance with your application.

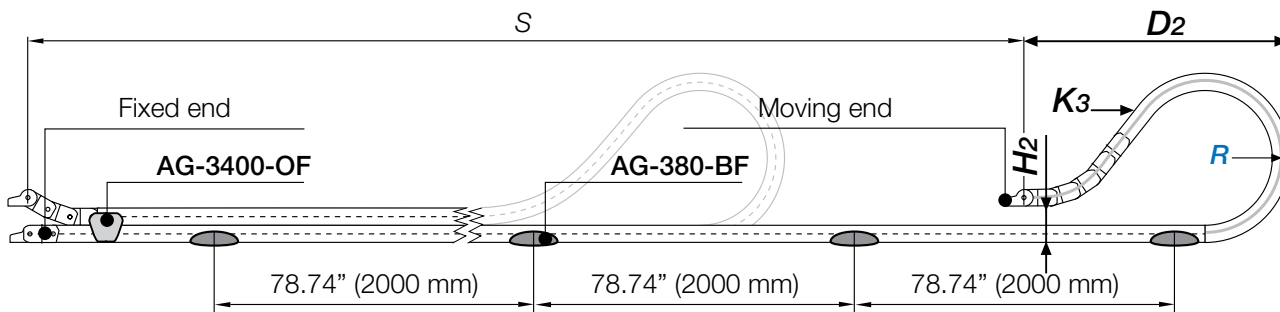

	3.94 (100)	4.92 (125)	5.91 (150)	7.87 (200)	9.84 (250)	11.81 (300)
R	3.94 (100)	4.92 (125)	5.91 (150)	7.87 (200)	9.84 (250)	11.81 (300)
H	7.87 (200)	7.32 (186)	7.32 (186)	7.32 (186)	7.32 (186)	7.32 (186)
D	9.17 (233)	18.70 (475)	22.44 (570)	30.71 (780)	39.76 (1010)	45.28 (1150)
K	34.29 (871)	44.84 (1139)	55.39 (1407)	73.86 (1876)	94.96 (2412)	108.15 (2747)

Legend

- S = Length of travel
- R = Bending radius
- H_{in} = Trough inner height
- H₂ = Mounting height
- D₂ = Overlength - long travels, gliding

Pitch per link = 2.64" (67 mm)
Links per ft (m) = 4.55 (15)
For center mount applications:
Chain length = S + K₃

Available Accessories



Optimized, cable-friendly interior separation program



Pivoting mounting brackets for gliding applications



Pivoting KMA mounting brackets with attachment points on all sides

PDF: igus.com/e-chain-pdfs
Product information: igus.com/e-chains

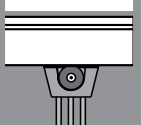
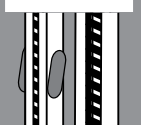
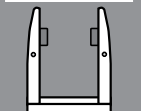
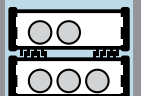

Smooth running:
Offset operation of upper
and lower run

Fast assembly:
"easy" design - simply
press cables in

Cost-effective:
Low price due to the
one-piece design

Secure guidance:
comb style
AUTOGLIDE crossbars

Universal:
Mounting bracket
with strain relief

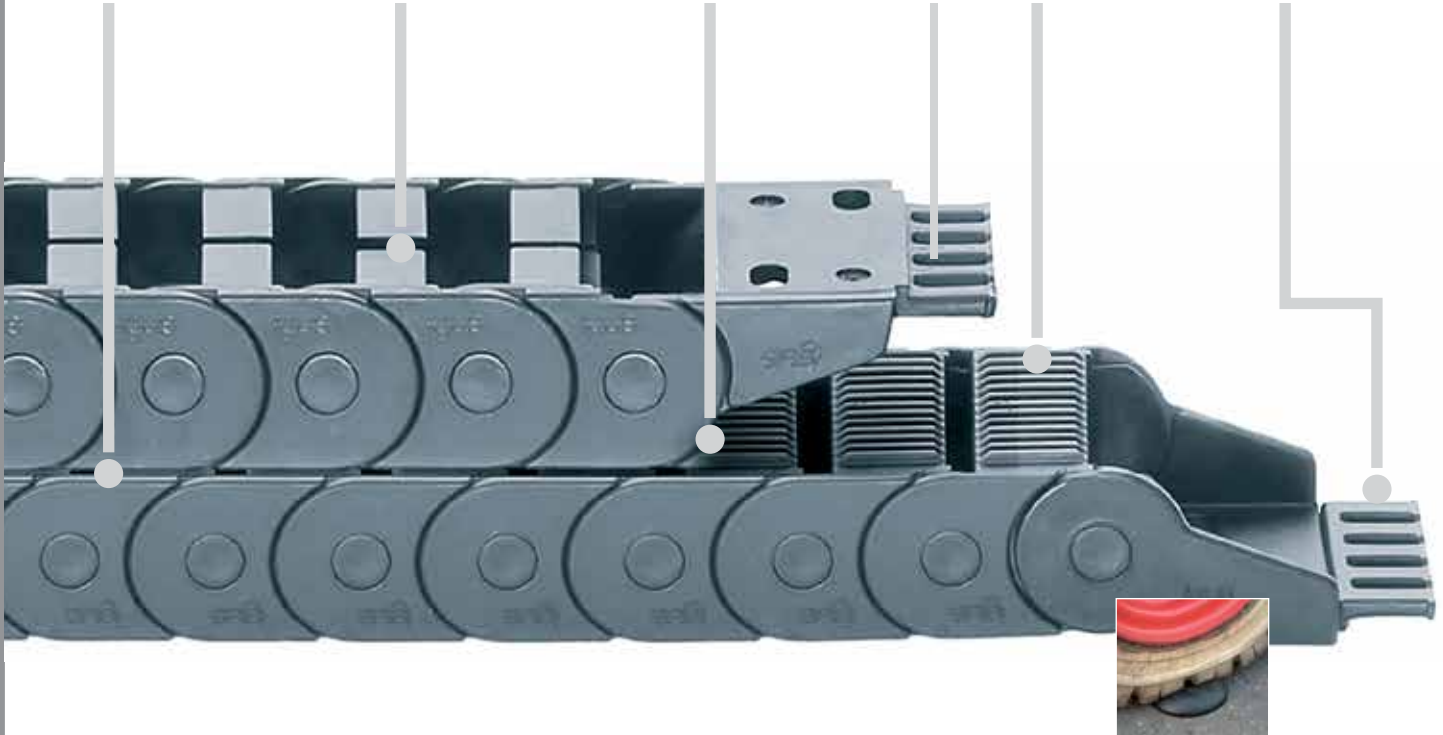

E-Z Chain along the outer radius, injection molded autoglide crossbars along the inner radius - Version 03

Version 03 is the quickly filled and cost-effective E-Z-Chain® with injection-molded autoglide crossbars in the inner radius. The crossbars are molded directly on the e-chain® link and are available in two sizes. The reduced installation time is one of the main features of the e-chains®. The elastic and rugged material igumid NB offers yet more reasons for application: Optimum elasticity, UL94-V2 classification and excellent suitability for cleanrooms. Their one-piece design makes E-Z Chain® attractive especially with regard to price.

- Doubly cost-effective. Elimination of guide troughs and economical, one-piece e-chain®
- Very quick assembly time - "easy"-design even on long travels
- "Easy"-design: Easy to fill - cables and hoses can be inserted without opening
- Single part design
- Small installation width, quiet operation
- UL94-V2 classifications

Typical industries and applications

- Industrial vehicles
- Long travels with easier filling
- Simple outdoor applications

Special solutions for long travel
 autoglide - Version 03 - Self-guiding e-chain systems®
 Technical Data - Order Examples



Part number structure

EA25-050-100-0-

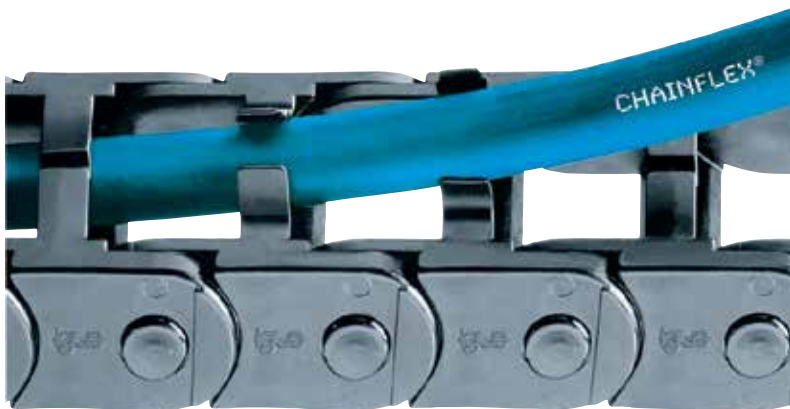

Simply push in the cables in the e-chain with your thumb - and it's ready!
 To remove simply pull out the cables from the e-chain®

Speed max. rolling	max. 3.28 ft/s (1 m/s)
Acceleration max. gliding	max. 3.28 ft/s ² (1 m/s ²)
Material - permitted temperature	igumid NB / -40°F (-40°C) up to +176°F (+80° C)
Flammability Class, igumid NB	VDE 0304 IIC UL94 HB

Technical Data



Details of material properties

► Chapter 1



Series EA16 - Simply press cables in (outer radius) - autoglide crossbars (inner radius)

Supplement part number with required radius. Example: EA16-4-065-0
 Pitch: 1.20 in. (30.5 mm) per link links/ft (m) = 10.06 (33)

Part Number		<i>Bi</i> in. (mm)	<i>Ba</i> in. (mm)
EA16-4-	<input type="text" value="065"/>	1.89 (48)	2.36 (60)
Choose from the radii below for the above size			
	<i>Radius</i> (mm)	Example: EA16-4- 065 -0	

	065	075	100
<i>R</i>	2.56 (065)	1.89 (075)	3.94 (100)
<i>H</i>	3.94 (100)	3.94 (100)	3.94 (100)
<i>D</i>	12.80 (325)	13.98 (355)	22.44 (570)
<i>K</i>	27.64 (702)	30.04 (763)	49.25 (1251)

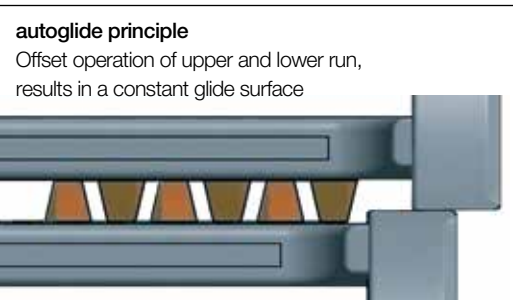
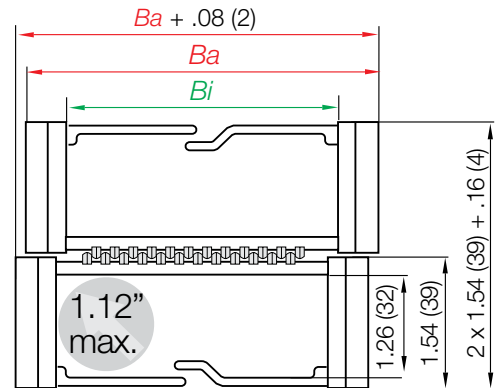

Pitch = 1.20 (30.5 mm)
 Links per ft (m) = 10.06 (33)
 Chain length = S + *K*₃

Gliding applications

Long travel lengths up to 65.6 ft. (20 m), Fill weights up to 0.27 lbs/ft (0.4 kg/m)

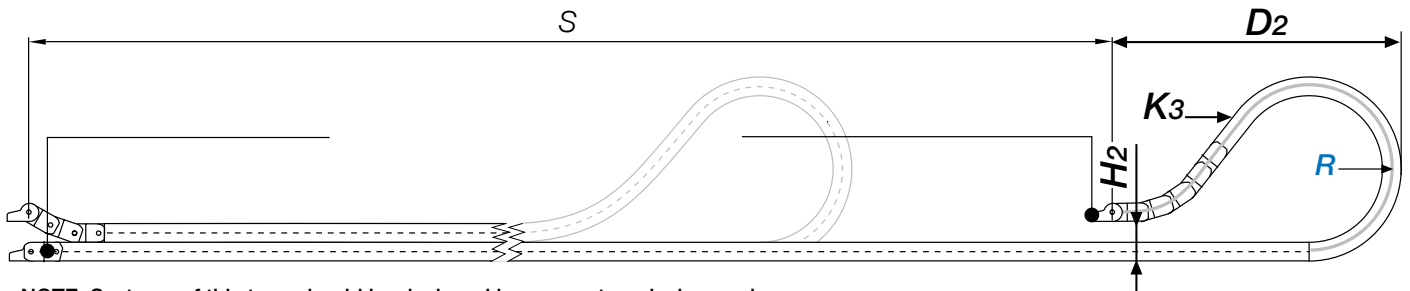

NOTE: Systems of this type should be designed by our system design engineers.
 Please contact igus® for assistance with your application.

<i>R</i>	2.56 (065)	1.89 (075)	3.94 (100)
<i>H</i>	3.94 (100)	3.94 (100)	3.94 (100)
<i>D</i>	12.80 (325)	13.98 (355)	22.44 (570)
<i>K</i>	27.64 (702)	30.04 (763)	49.25 (1251)

Special solutions for long travel autoglide - Version 03 - Self-guiding e-chain systems® EA25



autoglide



Series EA25 - Simply press cables in (outer radius) - autoglide crossbars (inner radius)

Supplement part number with required radius. Example: EA25-050-100-0
Pitch: .98 in. (25 mm) per link links/ft (m) = 12.24 (40)

Part Number	<i>Bi</i> in. (mm)	<i>Ba</i> in. (mm)
EA25-050- -0	1.97 (50)	2.36 (60)
Choose from the radii below for the above size		
	<i>Radius</i> (mm) Example: EA25-050- 100 -0	
	075	100
<i>R</i>	1.89 (075)	3.94 (100)
<i>H</i>	3.94 (100)	3.94 (100)
<i>D</i>	13.00 (330)	13.00 (330)
<i>K</i>	29.53 (750)	44.29 (1125)

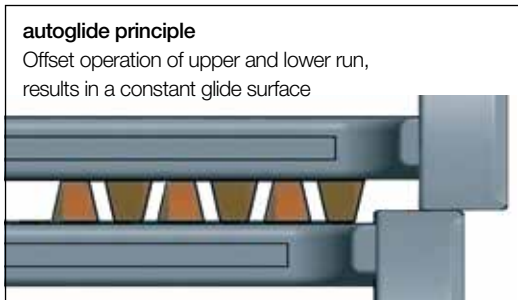
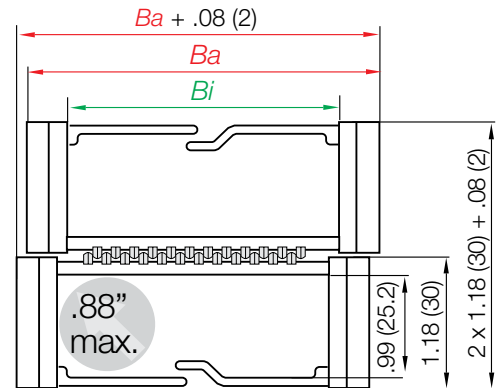

Pitch = .98 (25 mm)
Links per ft (m) = 12.24 (40)
Chain length = S + K_s

Gliding applications

Long travel lengths up to 65.6 ft. (20 m), Fill weights up to 0.27 lbs/ft (0.4 kg/m)

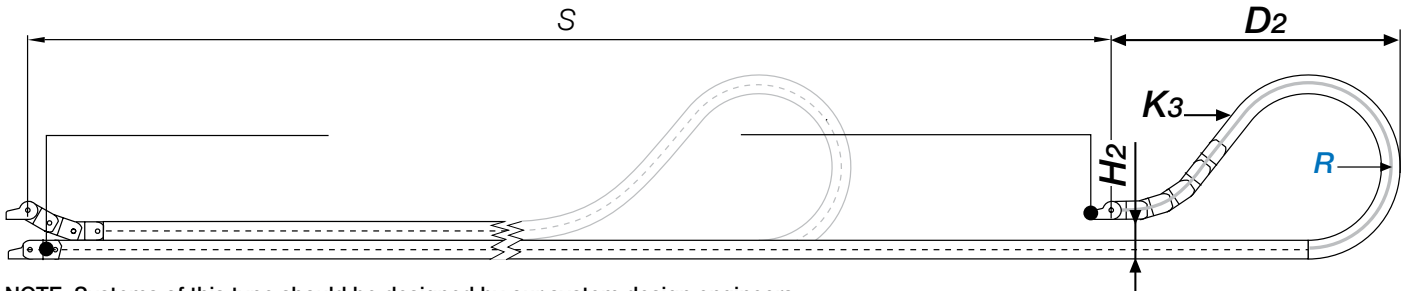

NOTE: Systems of this type should be designed by our system design engineers.
Please contact igus® for assistance with your application.

<i>R</i>	1.89 (075)	3.94 (100)
<i>H</i>	3.94 (100)	3.94 (100)
<i>D</i>	13.00 (330)	13.00 (330)
<i>K</i>	29.53 (750)	44.29 (1125)

Easy to install:
snap-open along the outer
radius

Practical:
traversable floor
guides

Safe on track:
assembled glide wing
feeds the e-chain®

Universal:
Mounting bracket
with strain relief



Special glide shoes provide safe guiding of the E2/000 - autoglide - Version 04

In this version, special plastic glide shoes are side-mounted on the e-chain® link every 39.4 to 78.7 inches (1,000 to 2,000 mm). The function of these gliding shoes resembles the leeboard used on sailboats. Some of these glide shoes are conceived in such a way that in contact they pivot upwards and enable the continuation of the travel. Similarly the glide shoes in autoglide go up and down, each according to its position as lower run or upper run of the e-chain®. They provide the precise lateral guidance and a smooth glide of the e-chain®. The glide shoes are assembled every 24th e-chain® link from the moving end. Up to 32.8 ft. (10 m) length without floor guides possible in the series 2400/2450/2480/2500.

Typical industries and applications

- Industrial vehicles
- Long travels with easier filling
- Simple outdoor applications



Part number structure
2500-05-150-0-AG



Order example | Part number structure



Order example for complete e-chain® Series 2500, color black, with mounting brackets and interior separation:

e-chain® 32.8 ft. (10 m)	Please indicate e-chain® length or number of links: 32.8 ft. (10 m) or 249 links (Number of links in the assembly must be deducted)	2500-05-150-0
e-chain® + glide wing	Assembly consists of 4 e-chain® links and 2 glide wings	2500-05-1500-AG
+ Floor guides	8 pieces (2 pieces every 6.56 ft. (2 m) from the half of travel)	AG-380-BF

Order text: 249 links 2500-05-150-0 + 10 units 2500-05-150-AG + Mounting bracket + Interior separation (optional)

Note: Lateral glide wings are assembled on every 24th e-chain® link.

Speed max. rolling	max. 1.64 ft/s (0.5 m/s)
Acceleration max. gliding	max. 3.28 ft/s ² (1 m/s ²)
Material - permitted temperature	igumid G / -40°F (-40°C) up to +248°F (+120° C)
Flammability Class, igumid G	VDE 0304 IIC UL94 HB

Technical Data



Details of material properties

► Chapter 1



Series 2400 shown

- Series 2400 - snap-open along the inner radius
- Series 2450 - snap-open along the outer radius - standard
- Series 2480 - snap-open along the inner radius, enclosed along the outer radius
- Series 2500 - snap-open along the inner radius, fully enclosed

Supplement part number with required radius. Example: 2500-05-150-0-AG
 Pitch: 1.81 in. (46 mm) per link links/ft (m) = 6.63 (22)

Part Number e-chain® / E-Tube	<i>Bi</i> in. (mm)	<i>Ba</i> in. (mm)	Floor Guide Single part
2400/2450/2480/2500-05- <input type="checkbox"/> -0-AG	2.24 (57)	2.87 (73)	AG-380-BF
2400/2450/2480/2500-07- <input type="checkbox"/> -0-AG	3.03 (77)	3.66 (93)	AG-380-BF
2400/2450/2480/2500-09- <input type="checkbox"/> -0-AG	3.50 (89)	4.13 (105)	AG-380-BF
2400/2450/2480/2500-10- <input type="checkbox"/> -0-AG	4.06 (103)	4.69 (119)	AG-380-BF
2400/2450/2480/2500-12- <input type="checkbox"/> -0-AG	4.92 (125)	5.55 (141)	AG-380-BF

Choose from the radii below for all of the above sizes
Radius (mm) Example: 2500-05-150-0-AG

	055*	075	100	125	150	175	200	225	250
<i>R</i>	2.17 (55)	2.95 (75)	3.94 (100)	4.92 (125)	5.91 (150)	6.89 (175)	7.87 (200)	8.86 (225)	9.84 (250)
<i>H</i>	4.33 (110)	5.91 (150)	3.94 (100)	3.94 (100)	3.94 (100)	3.94 (100)	3.94 (100)	3.94 (100)	3.94 (100)
<i>D_s²⁵</i>	5.59 (142)	6.38 (162)	14.96 (380)	17.32 (440)	23.23 (590)	29.72 (755)	37.40 (950)	40.94 (1040)	44.49 (1130)
<i>K</i>	19.92 (506)	23.54 (598)	36.22 (920)	41.65 (1058)	56.14 (1426)	70.63 (1794)	86.93 (2208)	95.98 (2438)	105.04 (2668)

*This radius for Series 2450/2480 available upon request. Please consult igus® for delivery times.

Special solutions for long travel autoglide - Version 04 - Self-guiding e-chain systems® 2400/2450/2480/2500 - Installation Dimensions



autoglide



Legend

- S = Length of travel
- R = Bending radius
- H_{in} = Trough inner height
- H₁ = *Mounting height
- D₁ = Overlength - long travels, gliding

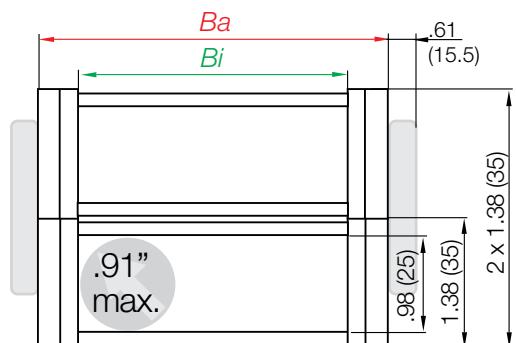

Gliding applications

Long travel lengths up to 65.6 ft. (20 m), Fill weights up to 1.08 lbs/ft (1.6 kg/m)
In case of travels less than 9.84 ft. (3 m) we recommend a self-supporting e-chain®.
Note: Lateral glide wings are assembled on every 24th e-chain® link.

Pitch per link = 1.81" (46 mm)
Links per ft (m) = 6.63 (22)
For center mount applications:
Chain length = $S + K_3$

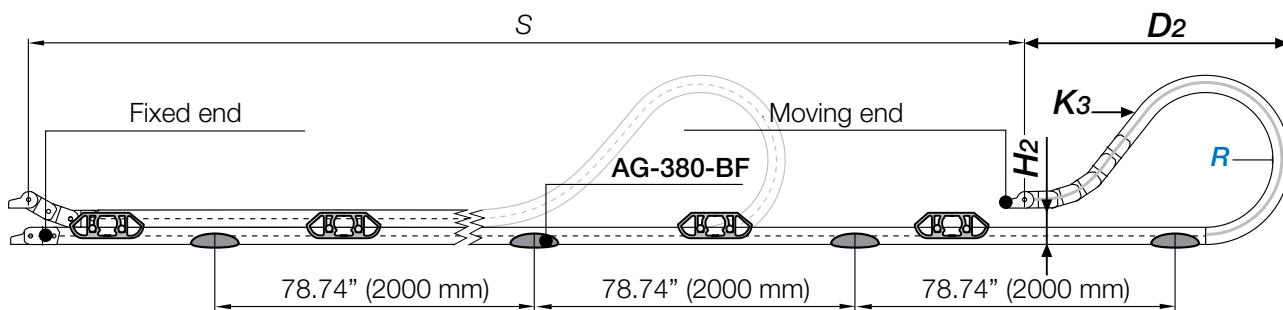

R	2.17 (55)	2.95 (75)	3.94 (100)	4.92 (125)	5.91 (150)	6.89 (175)	7.87 (200)	8.86 (225)	9.84 (250)
H ₁	4.33 (110)	5.91 (150)	3.94 (100)	3.94 (100)	3.94 (100)	3.94 (100)	3.94 (100)	3.94 (100)	3.94 (100)
D ₁ ²⁵	5.59 (142)	6.38 (162)	14.96 (380)	17.32 (440)	23.23 (590)	29.72 (755)	37.40 (950)	40.94 (1040)	44.49 (1130)
K ₃	19.92 (506)	23.54 (598)	36.22 (920)	41.65 (1058)	56.14 (1426)	70.63 (1794)	86.93 (2208)	95.98 (2438)	105.04 (2668)

*This radius for Series 2450/2480 available upon request. Please consult igus® for delivery times.

Available Accessories



Optimized, cable-friendly interior separation program



Pivoting mounting brackets for gliding applications



Pivoting KMA mounting brackets with attachment points on all sides

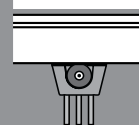
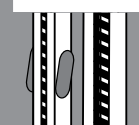
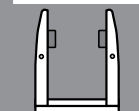
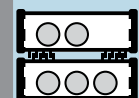

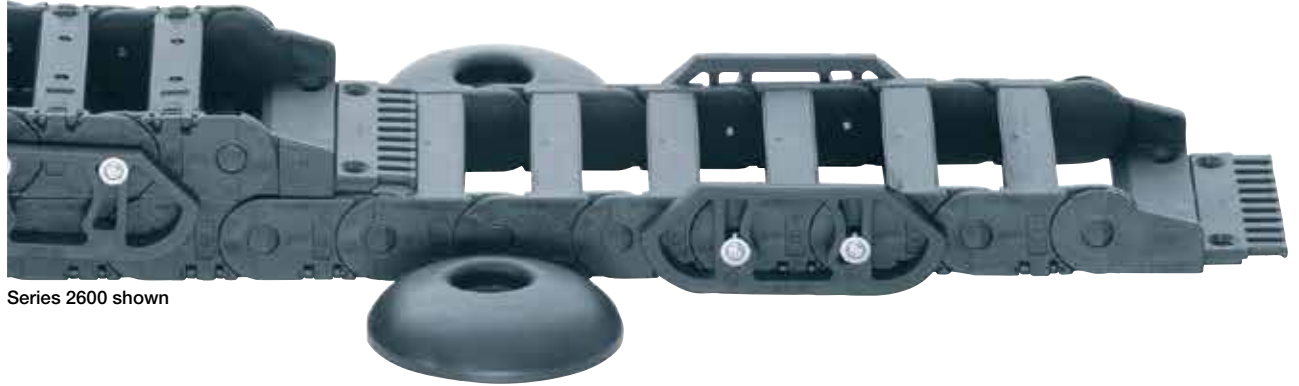

Series 2600 shown

- Series 2600 - snap-open along the inner radius
- Series 2650 - snap-open along the outer radius - standard
- Series 2680 - snap-open along the inner radius, enclosed along the outer radius
- Series 2700 - snap-open along the inner radius, fully enclosed

Supplement part number with required radius. Example: 2600-05-150-0-AG
 Pitch: 2.20 in. (56 mm) per link links/ft (m) = 5.45 (18)

Part Number e-chain® / E-Tube	<i>Bi</i> in. (mm)	<i>Ba</i> in. (mm)	Floor Guide Single part
2600/2650/2680/2700-05- <input type="checkbox"/> -0-AG	1.97 (50)	2.60 (66)	AG-380-BF
2600/2650/2680/2700-06- <input type="checkbox"/> -0-AG	2.56 (65)	3.19 (81)	AG-380-BF
2600/2650/2680/2700-07- <input type="checkbox"/> -0-AG	2.95 (75)	3.58 (91)	AG-380-BF
2600/2650/2680/2700-09- <input type="checkbox"/> -0-AG	3.54 (90)	4.17 (106)	AG-380-BF
2600/2650/2680/2700-10- <input type="checkbox"/> -0-AG	3.94 (100)	4.57 (116)	AG-380-BF
2600/2650/2680/2700-12- <input type="checkbox"/> -0-AG	4.92 (125)	5.55 (141)	AG-380-BF
2600/2650/2680/2700-15- <input type="checkbox"/> -0-AG	5.91 (150)	6.54 (166)	AG-380-BF
2600/2650/2680/2700-17- <input type="checkbox"/> -0-AG	6.89 (175)	7.64 (194)	AG-380-BF

Choose from the radii below for all of the above sizes
Radius (mm) Example: 2600-05-150-0-AG

	075*	100	125	150	175	200	250		
R	2.95 (75)	3.94 (100)	4.92 (125)	5.91 (150)	6.89 (175)	7.87 (200)	9.84 (250)		
H	5.91 (150)	6.54 (166)	6.54 (166)	6.54 (166)	6.54 (166)	6.54 (166)	6.54 (166)		
D²⁵	5.91 (150)	13.78 (350)	18.70 (475)	19.69 (500)	25.79 (655)	30.31 (770)	37.40 (950)		
K	24.33 (616)	33.07 (840)	44.09 (1120)	48.50 (1232)	61.73 (1568)	72.76 (1848)	90.39 (2296)		

*This radius for Series 2650/2680 available upon request. Please consult igus® for delivery times.

Special solutions for long travel autoglide - Version 04 - Self-guiding e-chain systems® 2600/2650/2680/2700 - Installation Dimensions



autoglide



Legend

- S = Length of travel
- R = Bending radius
- H_{in} = Trough inner height
- H = *Mounting height
- D = Overlength - long travels, gliding

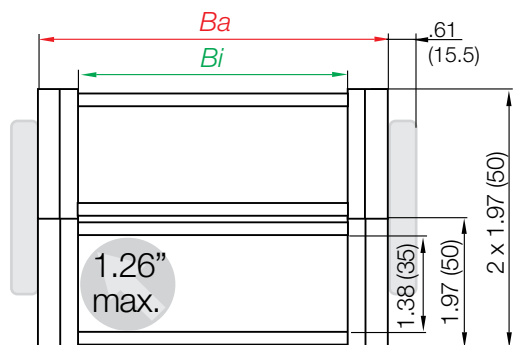

Gliding applications

Long travel lengths up to 98.4 ft. (30 m), Fill weights up to 1.34 lbs/ft (2.0 kg/m)
In case of travels less than 9.84 ft. (3 m) we recommend a self-supporting e-chain®.
Note: Lateral glide wings are assembled on every 24th e-chain® link.

Pitch per link = 2.20" (56 mm)
Links per ft (m) = 5.45 (18)
For center mount applications:
Chain length = $S + K_3$

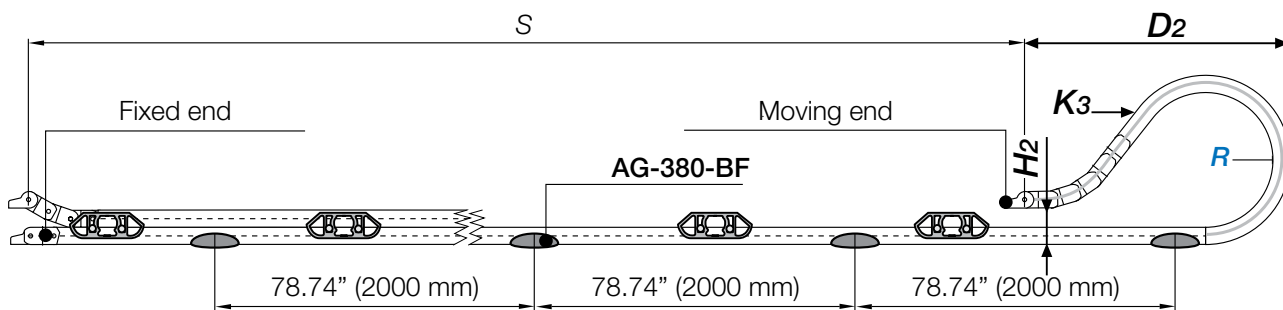

R	2.95 (75)	3.94 (100)	4.92 (125)	5.91 (150)	6.89 (175)	7.87 (200)	9.84 (250)
H	5.91 (150)	6.54 (166)	6.54 (166)	6.54 (166)	6.54 (166)	6.54 (166)	6.54 (166)
D ^{*25}	5.91 (150)	13.78 (350)	18.70 (475)	19.69 (500)	25.79 (655)	30.31 (770)	37.40 (950)
K	24.33 (616)	33.07 (840)	44.09 (1120)	48.50 (1232)	61.73 (1568)	72.76 (1848)	90.39 (2296)

*This radius for Series 2650/2680 available upon request. Please consult igus® for delivery times.

Available Accessories



Optimized, cable-friendly interior separation program



Pivoting mounting brackets for gliding applications



Pivoting KMA mounting brackets with attachment points on all sides

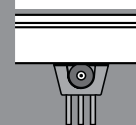
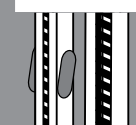
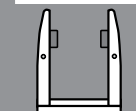
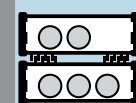

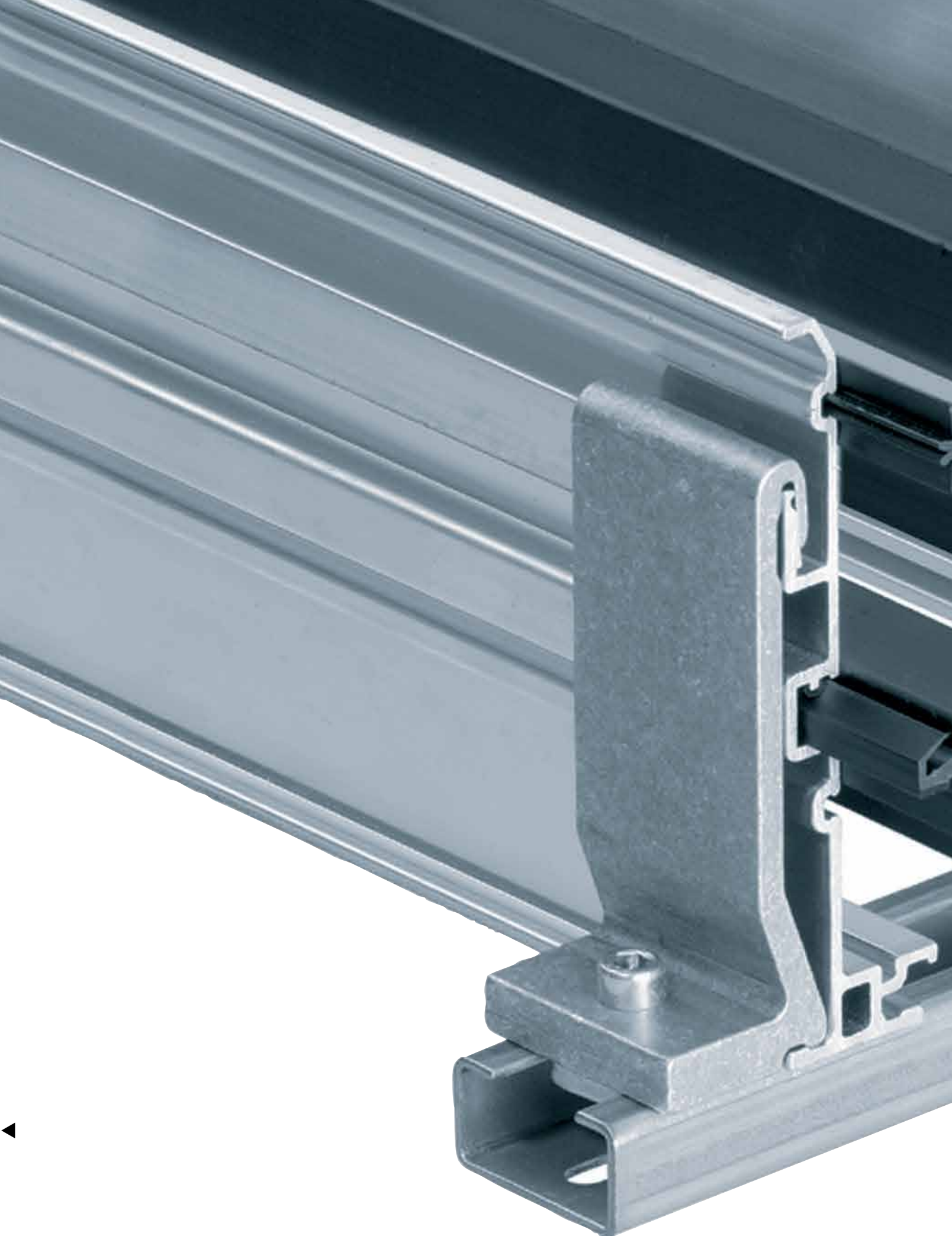

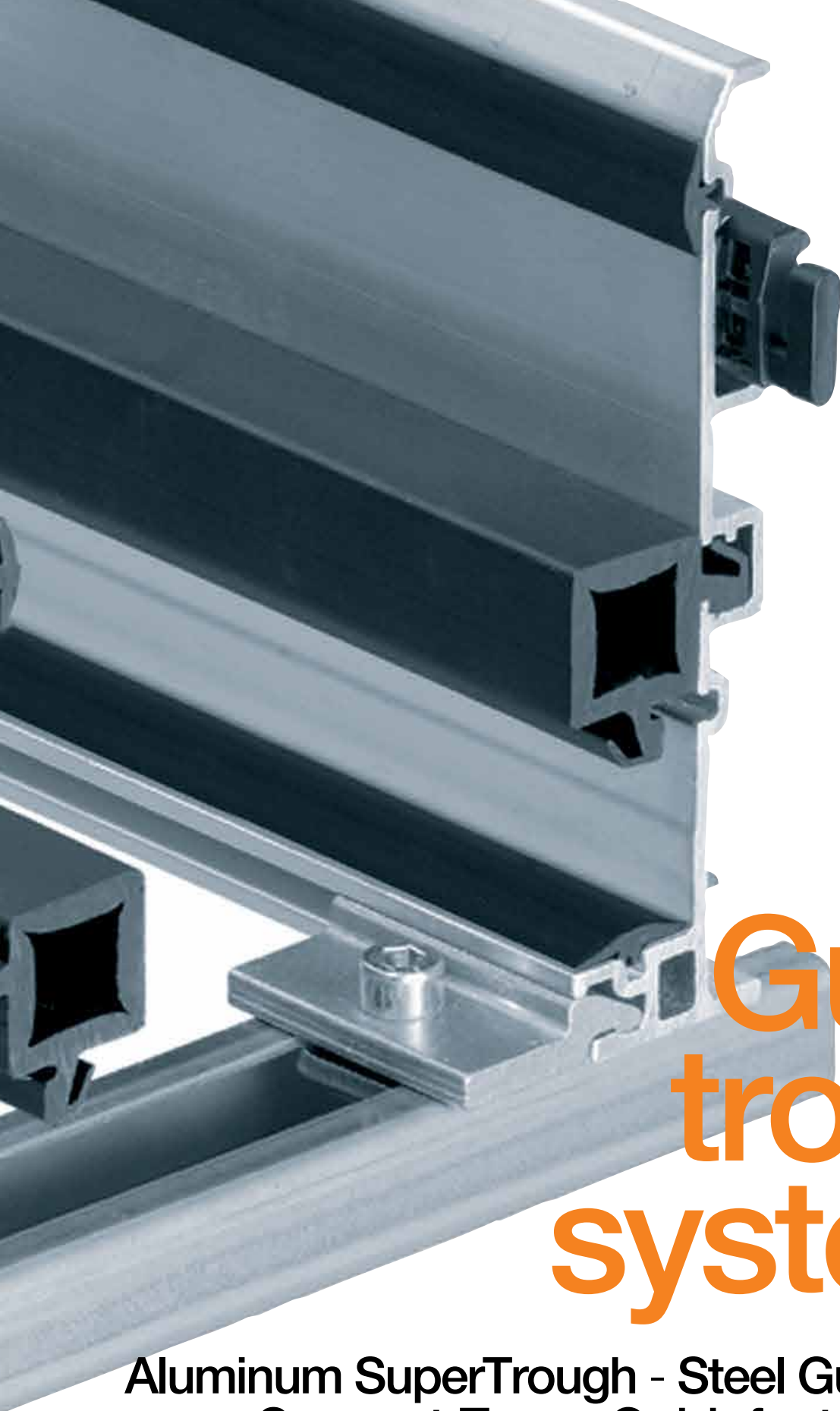

Guide trough systems

Aluminum SuperTrough - Steel Guide Trough |
Support Tray - Guidefast - Guidelite |

Guide Troughs - Aluminum and Steel

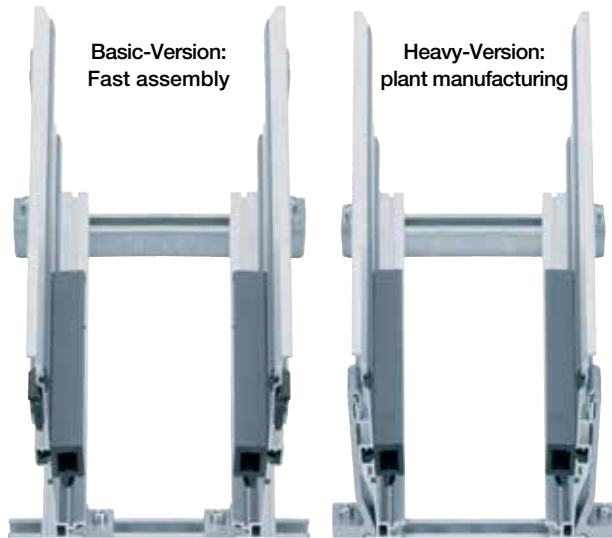

Aluminum SuperTrough - The igus® standard guide trough

- Huge program available for almost all igus®
- Very simple, modular assembly
- Side-mounted glide strips for wear protection in high-speed
- Corrosion resistant, seawater resistant aluminum profile
- Flexible assembly - Fastening on substructure independent of profile lengths and butt joints
- Plastic glide bar made of PE
- Bottom clamp can be mounted -inside or outside- directly on the bottom or on the profile rail
- Heavy duty brackets for high load applications (add on item)



Steel guide trough - stable and rugged for heavy duty applications

- Very stable and robust guide trough made of steel for high load applications
- Easy assembly due to installation set for joint and attachment surface connection
- Simple fastening directly on the ground or with profile rails
- Big range, two piece design, adjustable to e-chain® width
- Available in galvanized steel and stainless steel
- Low friction: glide bar made of PE
- Fixed end module, for fast and easy mounting - without drilling (add-on item)

Other Trough Options



For support of the lower run - Support tray tool kit

- Simple one-piece support trays
- Complete system, ready to install
- No more costly self-made designs
- Easy installation onto your machine, on profiles or wall-mount brackets



For crane girders and indoor cranes - Guidefast guide trough

- Save up to 80% installation time
- Fits virtually any standard crane girder
- Simplified installation, permanently installed cable can be fixed at the trough brackets
- With plastic glide bars for center fed applications



Realize long travels up to 492 ft - Guidelite - quick and cost-effective

- Simple one-piece support trays
- Complete system, ready to install
- No more costly self-made designs
- Easy installation onto your machine, on profiles or wall-mount brackets





Various guide trough systems are available



Hundreds of igus® Guide Trough in stock

We are always happy to advise you by telephone or on site. Special solutions provided by igus® often result in significant assembly cost savings.



Trough without glide bars:
e-chain® glides on top of itself



Trough with glide bars:
e-chain® glides on glide bars



Center mounted:
1/2 travel with glide bars
1/2 travel without glide bars

igus® guide troughs

Guide troughs are used for long travels. They allow for smooth low-friction operation in long travel applications. If the fixed end is installed in the center of the travel (center mounted), the e-chain® glides on itself for half the travel. For the other half we recommend glide bars, which are assembled in the trough and on which the e-chains® glide. igus® guide troughs are available from stock with these highly abrasion resistant polymer glide bars, which perform well with igus® e-chains® regarding noise, abrasion and friction.

Trough type

igus® offers guide troughs made of corrosion-resistant aluminum or steel. The trough type to be used depends on the application conditions and the requirements of the customer.

Glide bars

Glide bars made of igulen are optimally matched to the e-chain® material and achieve the lowest values of friction, noise and wear. Glide bars must be used if the fixed point is in the center of the travel. Refer to pictures below.

Delivery condition

The troughs are supplied in 6.56 ft (2 m) sections. The side parts (left and right) are installed on site at the required distance apart, depending on the width of the chain. The necessary width is shown in the table on the guide trough page of the respective chain chapter. The side parts of the trough can be bolted or welded directly to the attachment surface or connected to the base by means of screwing or welding or by using a special igus® installation set.

Guide trough systems can be ordered various ways: all the individual parts as separate components or completely assembled.

Customer-Supplied Guide Troughs

The dimensional data in this chapter consists of auxiliary dimensions for design and assembly. They apply exclusively to igus guide trough systems.

If the igus® e-chain® customer supplies the trough, all dimensions (including installation dimensions) must be obtained from igus. This is particularly important for one-piece guide troughs. The clearance between the guide trough and e-chain® is crucial and depends on the chain type, length and size, as well as the bending radius and the tolerance of the carrier and the attachment surface.

Since such guide troughs cannot be adjusted according to the application during the assembly process and cannot be readjusted in operation, careful calculation is required throughout this process.

For long travels, the upper run of the igus® e-chain® rests on the lower run. The upper run glides partially on the lower run and partially at the same height on the glide bar. The diagram below shows this. For lateral guidance, a guide trough is necessary. If the stationary mounting bracket and the fixed end of the cables and hoses can be placed in the center, the e-chain® length is calculated as follows: $L_k = S/2 + K_2$

The shortest e-chain® length is attained by the axial feeder module. The length of the e-chain® then corresponds to about half the travel distance. Depending on the technical data and the selected e-chain® the mounting point of the moving end of the e-chain® must be lowered on some units. In our system analysis for long travels we give exact details for your specific application.

Selection criteria

The following parameters are required for the design of a trough system:
Following parameters are required for the design of a trough system:

- e-chain® type (Series, width Bi , radius R)
- Travel and travel speed
- Fill weight
- Acceleration and/or lagging
- Lateral accelerations
- Environmental conditions

Design and installation of the guide trough

The guide trough is an important element in long travel applications. Usually, the height of the trough must be at least twice that of the e-chain® link height: $H_{ri} \geq 2 \times ha$. The sides must provide a chamfered opening. The trough inner width is the same as the e-chain® outer width, plus .16" (4 mm) $B_{ri} = Ba + .16 (4)$. Along the side of the trough, where the upper run cannot glide on the lower run, glide bars must be installed. We recommend the use of polymer glide bars from igus®. They are optimally matched to the e-chain® material and achieve the lowest values for friction, noise and wear. Guide troughs with and without glide bars can be obtained for almost all igus® e-chains®. **Important:**

When assembling the trough parts, the following points must be given particular attention:

- Properly align all trough parts upon installation
- All screw heads should be flush with the trough
- Smooth leveled transition between the end of the e-chain® and the glide bars
- Solid connection with the glide surface.

These points must be observed when using assembly-friendly igus® guide troughs.

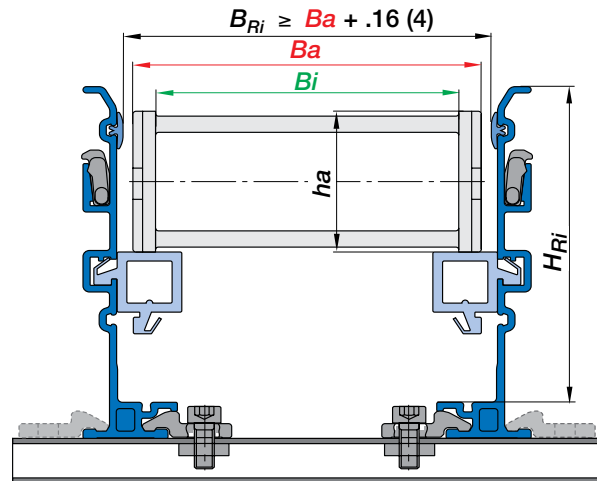
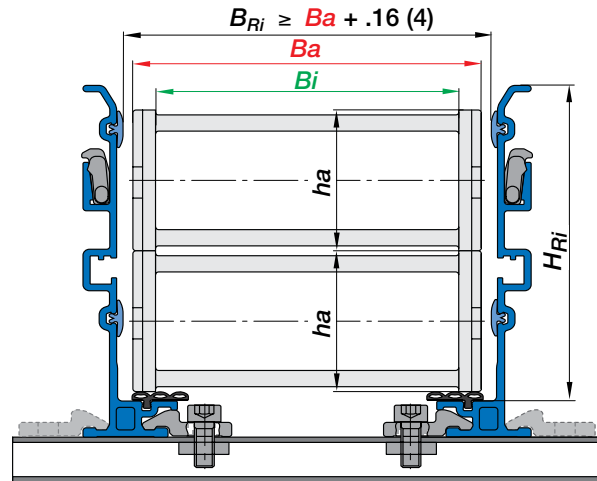

e-chain® length $L_k = S/2 + K_2$
 Inner trough height $H_{ri} \geq 2 \times ha$
 Inner width, Aluminum SuperTrough $B_{ri} = Ba + .16 (4)$
(Ba + 5 Steel guide trough)

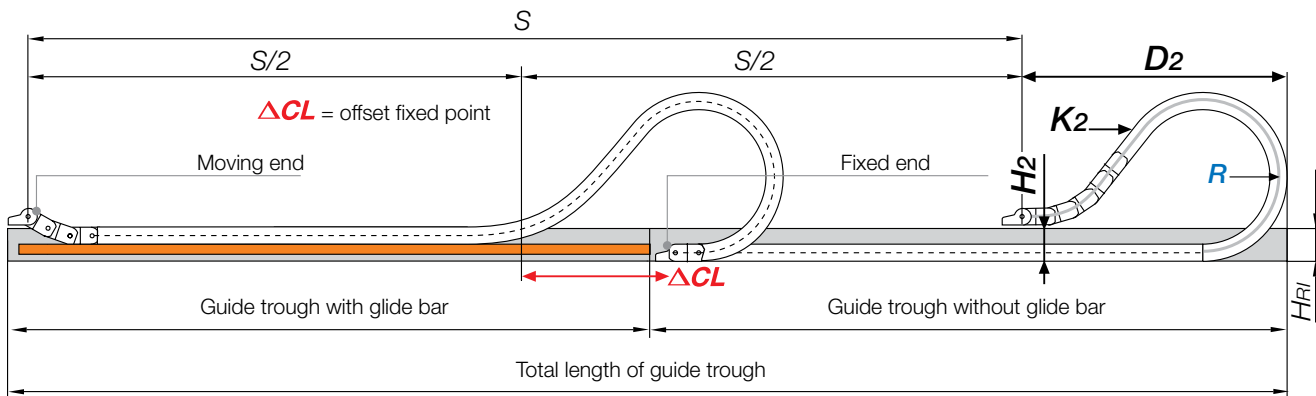

- | | | | | |
|--|---|---|---|---|
| | <ul style="list-style-type: none"> ● Trough set ● Installation set ● Glide bar ● Profile rail | <ul style="list-style-type: none"> Ba = Outer width e-chains® Bi = Inner width e-chains® R = Bending radius ΔCL = Offset fixed point S = Length of travel $S/2$ = Half length of travel | <ul style="list-style-type: none"> B_{ri} = Inner trough width B_{ra} = Outer trough width H_{ri} = Inner trough height H_{ra} = Outer trough height ha = Outer e-chain® height L_k = e-chain® length | <ul style="list-style-type: none"> H_2 = Mounting height (if the moving end is set lower) D_2 = Over length - long travels, gliding K_2 = Further add-on (if the moving end is set lower) H_f = Required clearance height |
|--|---|---|---|---|

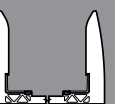
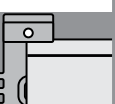
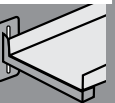

Profile rail Part No. 92-52-XX

- For all igus® Aluminum SuperTrough and Steel guide troughs
- With increased holding power - even for harsh applications
- Standard material: galvanized steel
Part No. CF-92-52G-XX (XX - length in mm)
- Profile rail available in galvanized steel. Optional:
Stainless steel material V2A, material 1.4301 (AISI 304).
For AISI 304 please add index "SS" to the Part No. CF-92-52GSS
- Length tolerances of ±5 mm possible!



Profile rail Part No. CF-92-52G -

With increased holding power also for harsh conditions

Assembly in front of the e-chain® - **CANNOT** be integrated into KMA mounting bracket

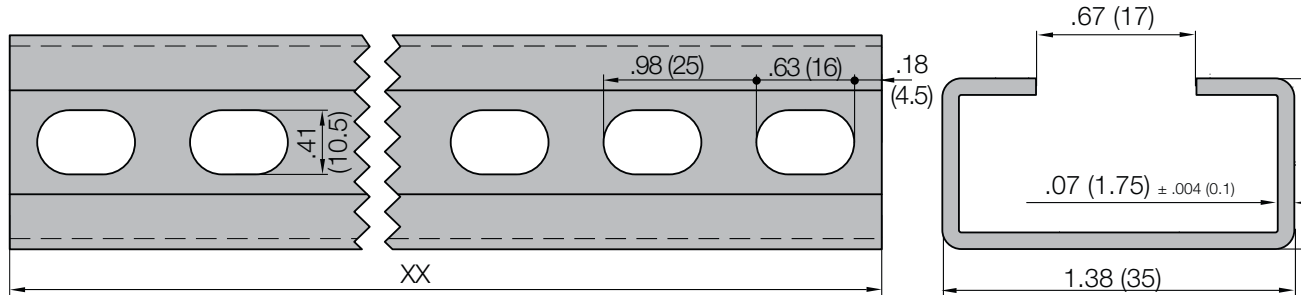

Profile rail Part No. CF-92-52G.XX - For all igus® Aluminum SuperTrough and Steel guide troughs



PDF: igus.com/e-chain-pdfs
Product information: igus.com/e-chains

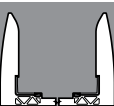
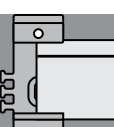
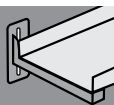

All types of installations are possible. Very long, "green systems" up to 2,018 ft. (615 m) help to reduce energy costs, and are comprised of igus® e-chains®, chainflex® cables and corresponding guide troughs. Mix-and-match components allow for maximum design flexibility, and all igus® e-chains® and chainflex® cables offer extended service lives, even in harsh weather, polluted environments, and dirty, dusty applications

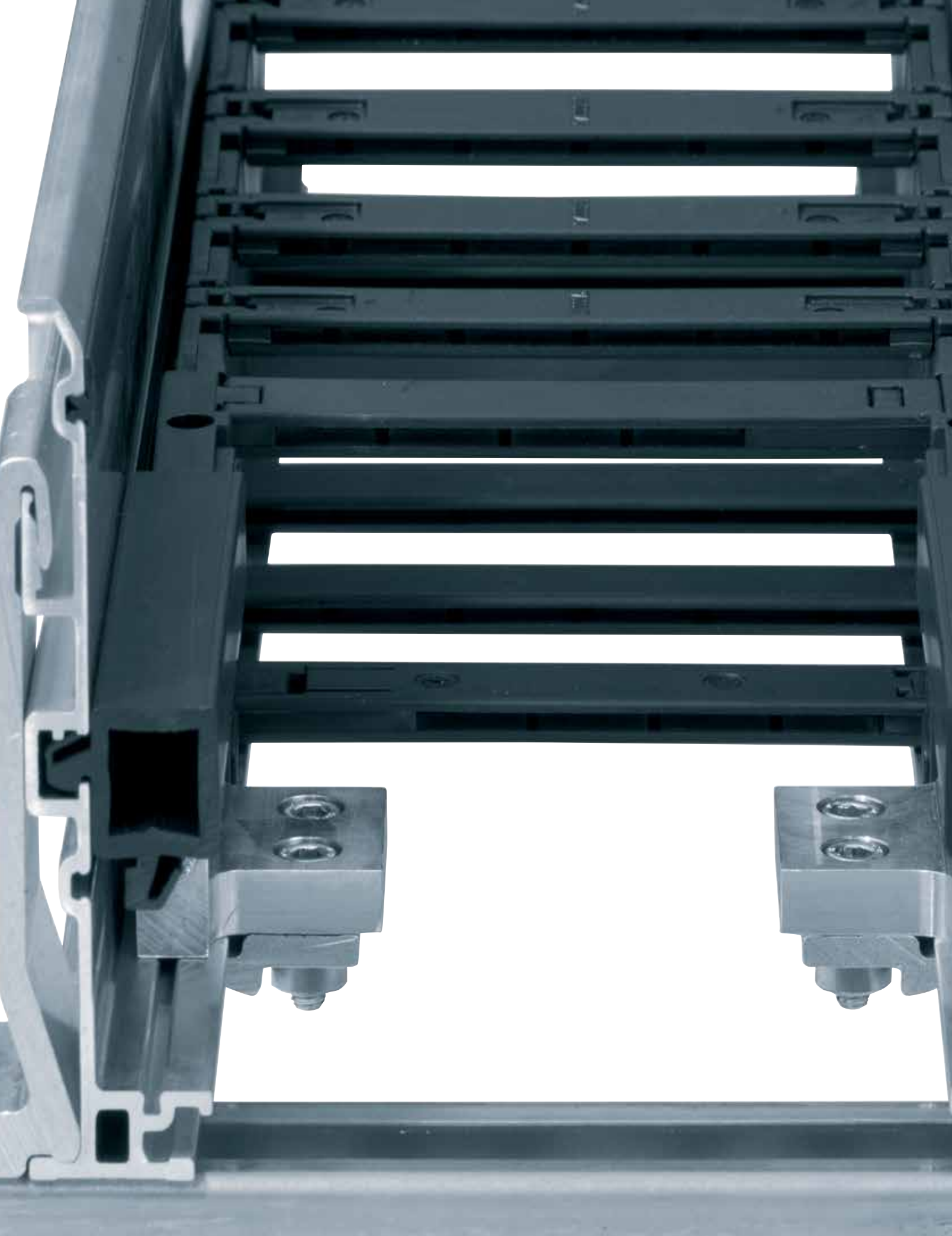



Aluminum SuperTrough

For general use



Advantages aluminium SuperTrough

- Huge range available for almost all igus® e-chains®
- Very simple, modular assembly
- Corrosion-resistant, seawater-resistant aluminium profile
- Flexible assembly
- Heavy-duty bracket option for high load applications:
you can configure the heavy-duty version online
 - ▶ www.igus.com/alu-guide
- Conductivity according to DIN EN 61537 - as standard
- Glide strips for wear protection at high-speed



When to use another guide trough:

- When a very tough guide trough made from steel is required for heavy-duty applications
 - ▶ **Steel guide troughs**

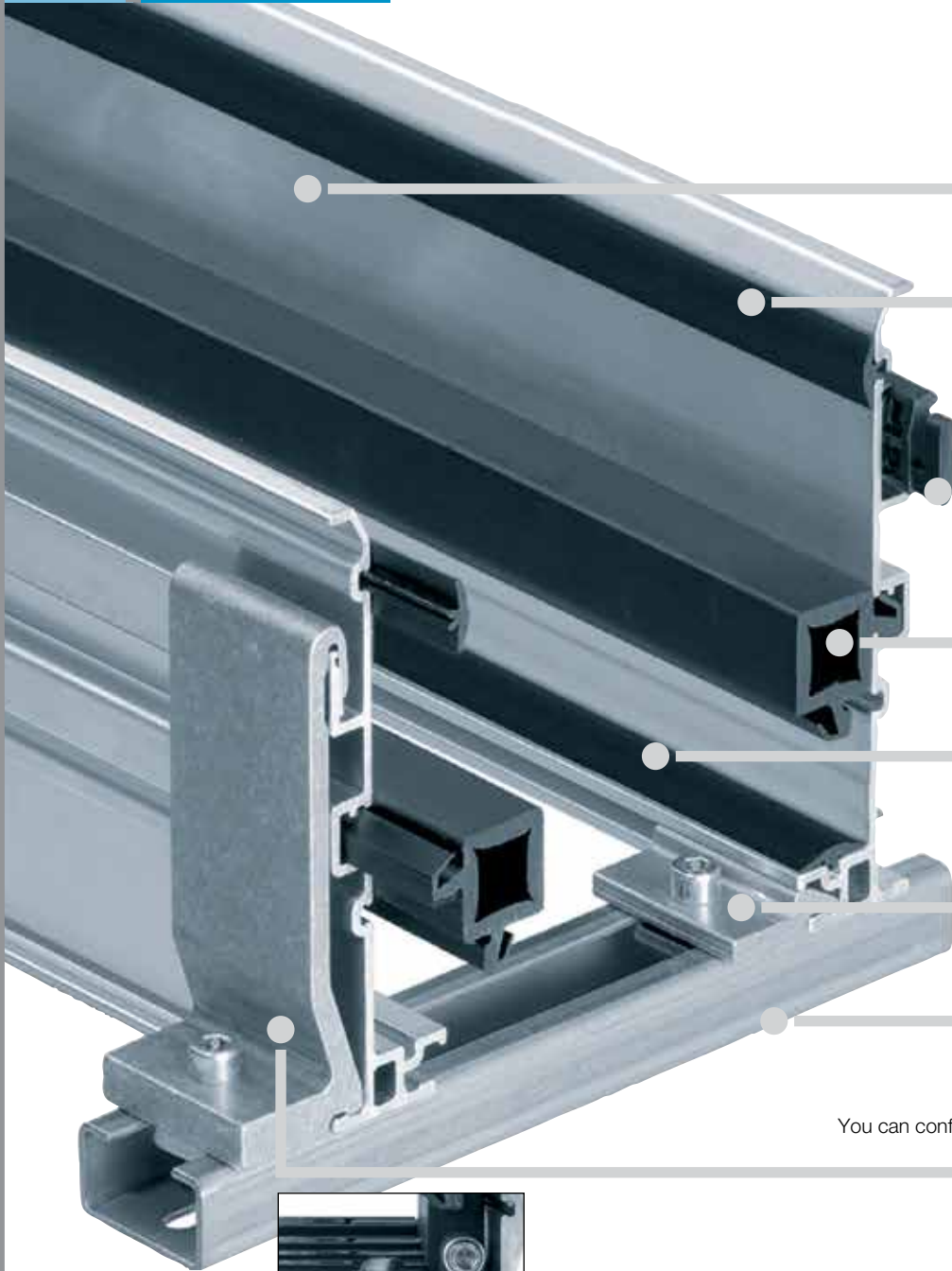

Huge program:
Aluminum profile (Standard: 6.56 ft. (2 m) section)
available for almost all igus® e-chains®
Seawater resistant and corrosion resistant

Wear-reducing: Glide strip
Protect from wear on the sides

Fast connection:
Interface connector Basic, plastic, easy
assembly, no tools needed

Wear-reducing
Plastic glide bar
Easy click-on assembly

Noise-reducing:
Silencer profile, rubber (add-on item)

Simple fastening: Bottom clamp Basic,
attached inwards or outwards, fast and easy

Simple fastening:
Profile rail, for bottom clamps

high load: Heavy-Duty bracket (add-on item)
You can configure the Heavy-Duty version at our online-catalog
► www.igus.com

Simple connection:
Fixed end module (add-on item),
for fast and easy mounting - without any drilling

Aluminum SuperTrough

The Aluminum SuperTrough is a modular guide trough system for long travels (gliding application). Aluminum SuperTrough is available in low cost basic versions and can be upgraded for Heavy-Duty applications. This modular usage makes it the igus® recommended standard trough system.

- Very simple, modular assembly
- Corrosion resistant, seawater resistant aluminum profile
- Flexible assembly - Fastening on substructure independent of profile lengths and butt joints
- Misalignment-free installation - No screwing or welding of the profiles required

Installation Guide PDF with detailed assembly information ► www.igus.com/installation-guide-pdf

Series Part No.	Outer trough height H_{Ra} (mm)	Installation set* Part No.	side part material
--------------------	--------------------------------------	-------------------------------	-----------------------



Basic version, Standard -
for general use

970-30-SL / 970-31-SL	3.03 (77)	960-30	aluminum
970-30-SL / 970-32-SL	3.03 (77)	960-30	aluminum
971-30-SL / 971-31-SL	3.43 (87)	960-30	aluminum
972-02-30-SL / 972-02-31-SL	4.61 (117)	960-30	aluminum
972-30-SL / 972-31-SL	4.61 (117)	960-30	aluminum
972-30-SL / 972-32-SL	4.61 (117)	960-30	aluminum
973-30-SL / 973-31-SL	5.67 (144)	960-50	aluminum
974-30-SL / 974-31-SL	7.24 (184)	960-50	aluminum
975-30-SL / 975-31-SL	9.29 (236)	960-50	aluminum



Heavy Duty version -
for rugged plant construction

You can configure the Heavy Duty version online with the respective e-chain® you've chosen

971-30-SL / 971-31-SL	3.43 (87)	971-50	aluminum
972-02-30-SL / 972-02-31-SL	4.61 (117)	972-50	aluminum
972-30-SL / 972-31-SL	4.61 (117)	972-50	aluminum
972-30-SL / 972-32-SL	4.61 (117)	972-50	aluminum
973-30-SL / 973-31-SL	5.67 (144)	973-50	aluminum
974-30-SL / 974-31-SL	7.24 (184)	974-50	aluminum
975-30-SL / 975-31-SL	9.29 (236)	975-50	aluminum

*The basic Installation sets are the standard for the Aluminum SuperTroughs. They can be fastened inside or outside and are recommended for most application areas. The basic clamping shoes are made of aluminum. The Heavy-Duty version is differentiated only by the type of the installation set. The part numbers of the channel side plates, slide bars, etc., are the same as the basic model. The Heavy-Duty installation set consists of a rugged aluminum bracket, fastened outside on the guide trough.

Aluminum SuperTrough - Size Overview

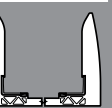
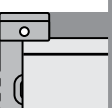
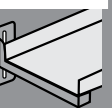
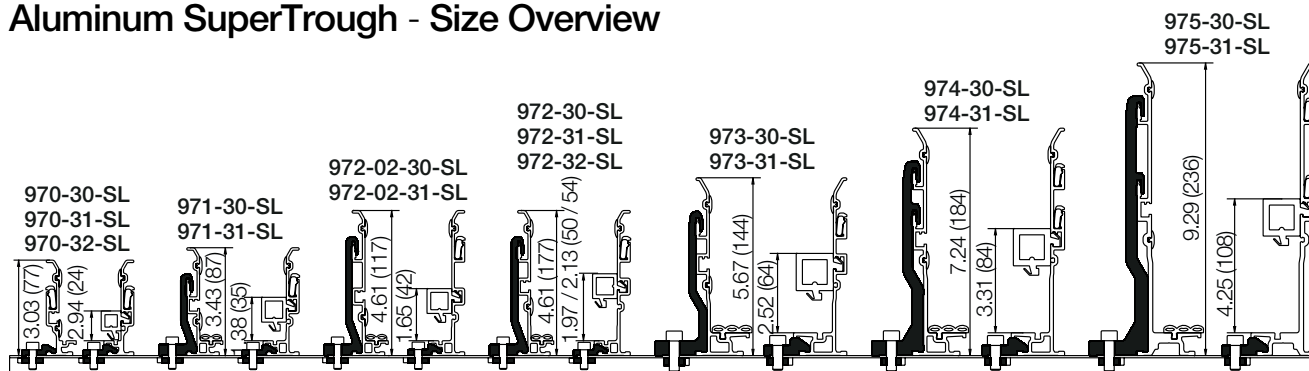

Components, trough

- 1 Trough side parts, aluminum, 2 m
- 2 Glide bar, plastic, 2 m
- 3 Glide strips, plastic, 2 m (without glide strips on request)
- 4 Optional: Silencer profile, rubber

Components, installation set

- A Bottom clamp, aluminum
- B Profile rail¹⁾, galvanized steel
- C Screw
- D Sliding nut
- E Interface connector, plastic

- Ba = Outer e-chain® width
- Bi = Inner e-chain® width
- ha = e-chain® outer height
- H_{Ri} = Inner trough height
- H_{Ra} = Outer trough height
- B_{Ri} = Inner trough width
- B_{Ra} = Outer trough width

$$H_{Ri} \geq 2 \times ha$$

$$B_{Ri} = Ba + 4$$

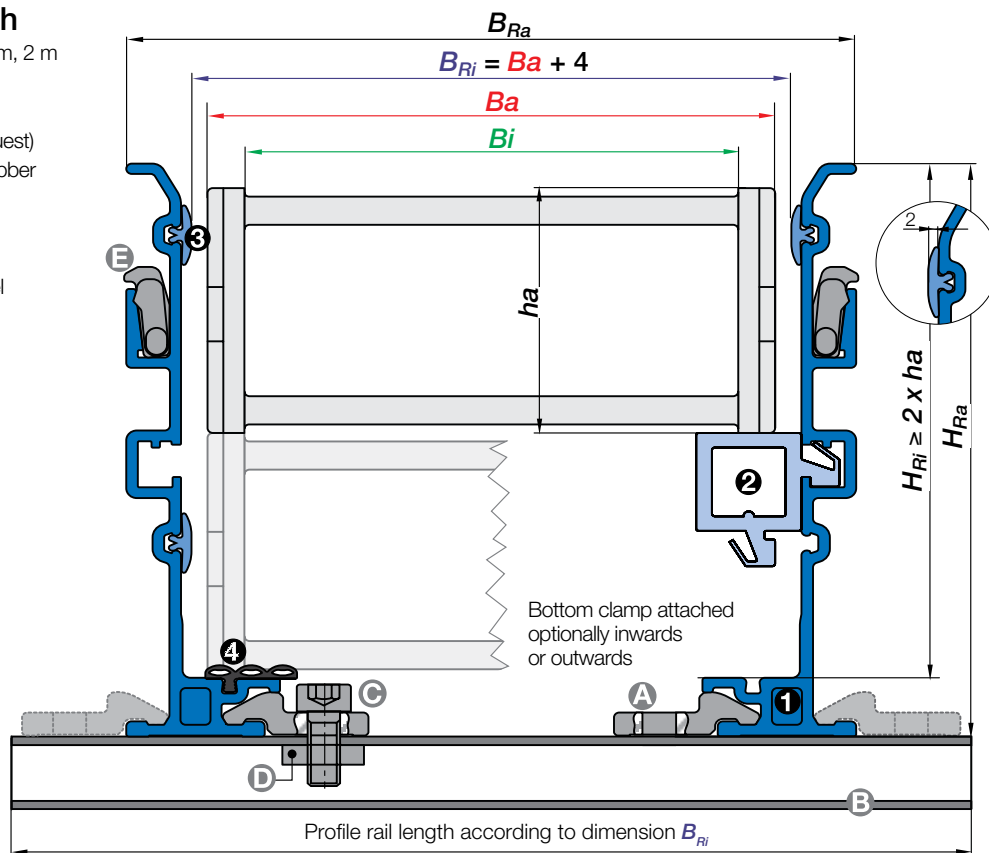

1) Profile rail also available in stainless steel V2A, material 1.4301 (AISI 304)

Aluminum SuperTrough | Features

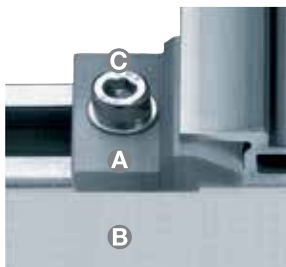
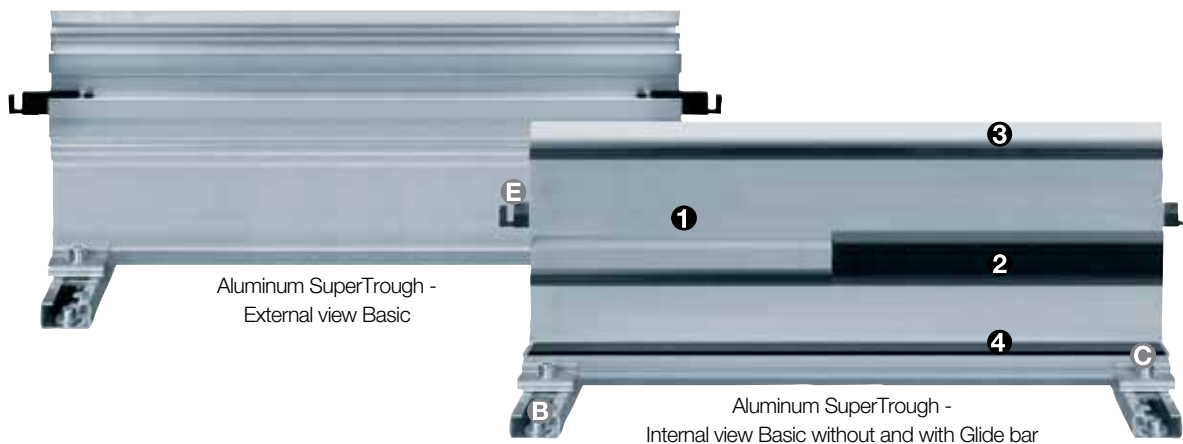

Simple fastening with Basic bottom clamp and profile rail

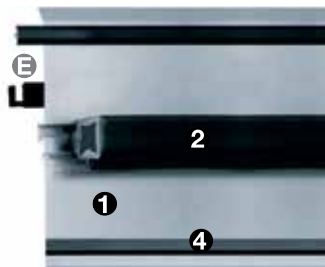

Wear-reducing with polymer glide bar and glide strip



Noise-reducing with silencer profile (add-on item)



Simple connection to the e-chain® with the fixed end module

Aluminum SuperTrough - Configured according to your requirements

Quick and easy assemble the right trough for your application

- Selection of the suitable guide trough according to the e-chain® Series and e-chain® width *Bi*
- Determine the feeding point of the cables
- Determine travel distance and thus the length of the required guide trough and the number of trough pieces. Standard length of a trough side plate: 78.7" (2000 mm). The length of the guide trough - for axial feeding - is calculated from half the travel length with and half the travel length without the glide bar
- Option: "Sound dampening" with silencer profile
- Number and selection of the assembly kit

There are two assembly kit options: Basic (standard), Heavy-Duty (for plant construction)

The quantity of the assembly kit is calculated from the number of the trough pieces + 1 kit:

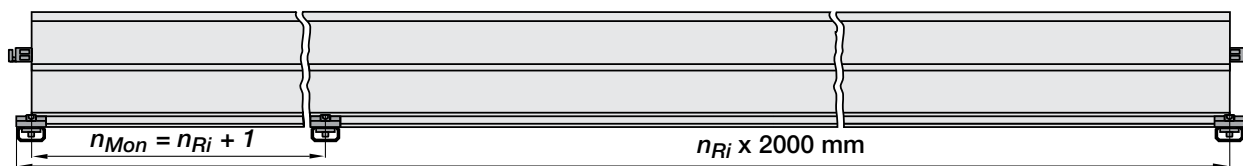

- The assembly kit matches the igus® profile rail option
- If you have opted for an e-chain® with KMA mounting brackets, we offer you a fixed-end module for the quick and simple fastening of the e-chain® in the trough without holes

Installation Guide-PDF with detailed assembly information

➤ www.igus.com/installation-guide-pdf

Order example Based on Part No. 973-30-SL / 973-31-SL



Order example: Length of travel 98.4 ft. (30 m) -

Center mounted for Series 3500-100-200-0 with $B_{Ri} = 124$

Guide trough set (set of 2 trough side parts, incl. glide strips) **without** glide bar

Order text: 52.5 ft. (16 m) guide trough without glide bar (8 x 6.56 ft. (2 m) sections)

Part No. 973-30-SL

Guide trough set (set of 2 trough side parts, incl. glide strips) **with** glide bar

Order text: 52.5 ft. (16 m) guide trough with glide bar (8 x 6.56 ft. (2 m) sections)

Part No. 973-31-SL

Installation set "Basic" complete (guide trough-sets + 1)

Order text: 17 installation sets "Basic"

Part No. 960-40-175

Module for the fixed end

Order text: 1 set

Part No. 973-80-5

Option: For an additional noise dampening with

silencer profile, please add Index A Example:

Part No. 973-30-SLA



Calculation - travel center mounted: Half travel length, rounded down to full 2 m sections = X m guide trough length without glide bars + X m guide trough length with glide bars + installation sets Basic (number of trough pieces + 1)

PDF: igus.com/e-chain-pdfs
Product information: igus.com/e-chains

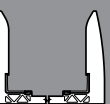
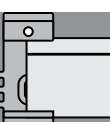
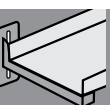

A quick fix for mounting the stationary end of an e-chain®



Optimized fixed end module

- Lighter more cost-effective than previous metal solutions
- Mounting bracket attachment on the Aluminum SuperTrough without drilling
- Fixed end module is clamped to the trough
- Save installation time
- Minimize errors from drilling your own holes
- Available for many E2, E4 and E6 Series e-chains®
- Stainless and cost-effective

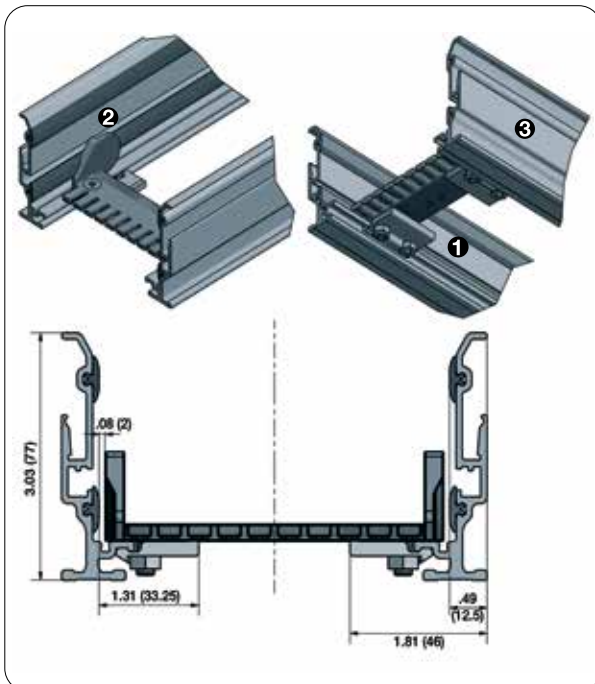
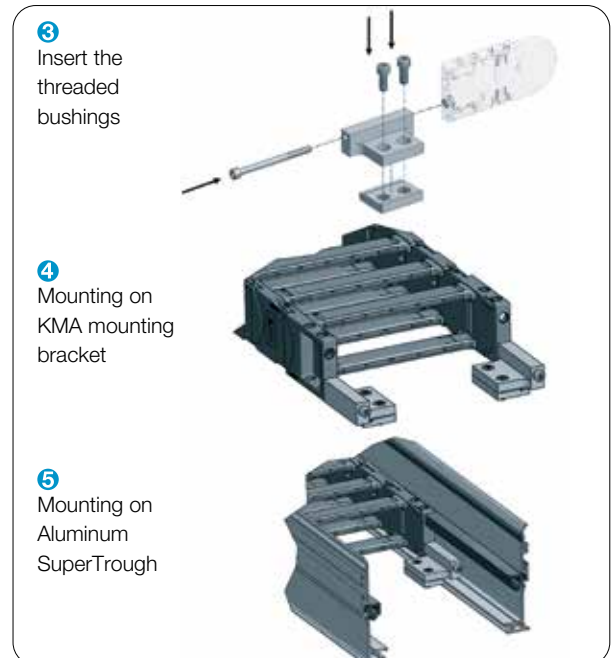
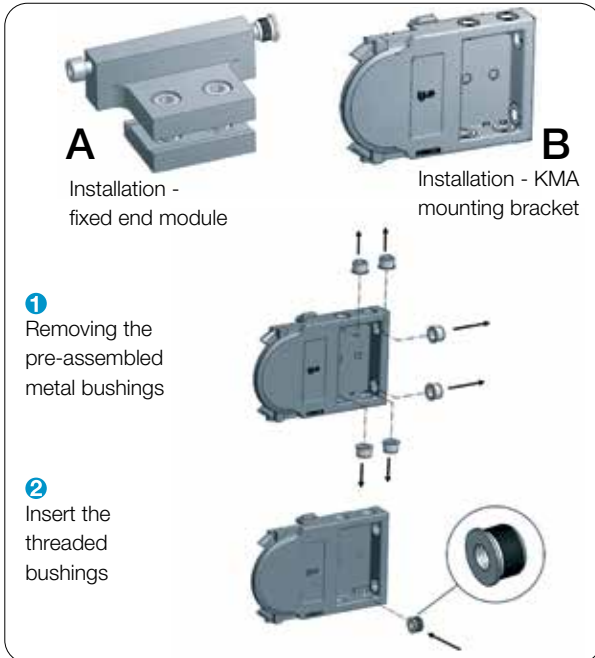

Fixed end clamp to attach the e-chain® into the smallest SuperTrough 970-30-SL

For mounting brackets from Series: 10, 15/R15, B15, 1500. The fixed end clamp enables quick and simple attachment by clamping onto the Aluminum SuperTrough without drilling

- Quick attachment of the e-chain® to the Aluminum SuperTrough
- The mounting point of the e-chain® can be changed quickly
- Minimize errors from drilling your own holes
- Available for many E2, E4 and E6 Series e-chains®
- Stainless and cost-effective

Fixed end clamp design:

- 1 Fixed end clamp 970-80
- 2 Mounting bracket
- 3 Aluminum SuperTrough 970-30-SL

Guide Trough Systems Aluminum SuperTrough Fixed End Module



Part No.	For Aluminum SuperTrough	For e-chain® Series	Application including inner width (Bi)	Mounting Bracket
970-80 ¹⁾	970-30-SL 970-31-SL	10, B15, 15/R15	.050	one-piece
970-80 ¹⁾	970-30-SL 970-32-SL	1500	.050	one-piece
971-80-4 ¹⁾	971-30-SL 971-31-SL	2500, 255	.07	KMA
972-80-4 ¹⁾	972-02-30-SL 972-02-31-SL	E4-28/R4-28, E4-31L/R4-31L	.06	KMA
972-80-4 ¹⁾	972-30-SL 972-31-SL	E4-32/H4-32/R4-32, E4-38L/R4-38L	.06	KMA
972-80-4 ¹⁾	972-30-SL 972-32-SL	2700, R58	.06	KMA
973-81-5 ¹⁾	973-30-SL 973-31-SL	E4-42/H4-42/R4-42, E4-48L/R4-48L	.10	KMA
973-80-5 ¹⁾	973-30-SL 973-31-SL	3500, R68	.100	KMA
974-81-5 ¹⁾	974-30-SL 974-31-SL	14040/14140/R18840, 14240/14340, E4-64L/R4-64L	.10	KMA
974-80-5 ¹⁾	974-30-SL 974-31-SL	E4-56/H4-56/R4-56	.10	KMA
975-80 ²⁾	975-30-SL 975-31-SL	E4-80/H4-80/R4-80	.10	KMA
975-81 ²⁾	975-30-SL 975-31-SL	15050/15150/R19850, 15250/15350	.10	KMA

1) Material: plastic 2) Material: Aluminum AlMg3, seawater resistant
Material screw kits: Standard steel, galvanized. Optional stainless steel: V4A, material 1.4571 (AISI 316Ti)



Fixed-end module - Simple fastening of the e-chain® without drilling

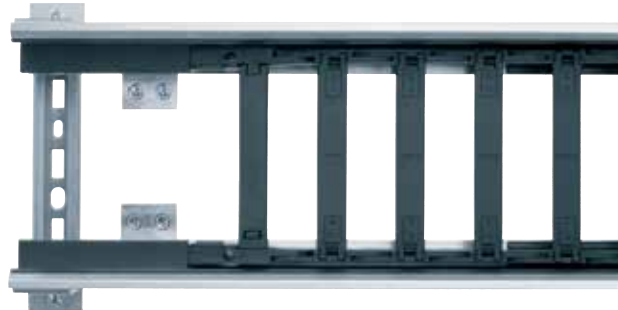

The igus® aluminum SuperTrough has been tested since 2005.
Test "Axis 1": Speed 4.92 ft/s (1.5 m/s), Travel: 59 ft (18m), Mileage to date: approximately 31,069 miles (50,000 km)

PDF: igus.com/e-chain-pdfs
Product information: igus.com/e-chains

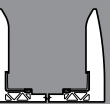
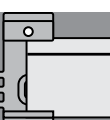
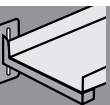

Installation Sets | Basic and Heavy Duty



Installation Set Basic

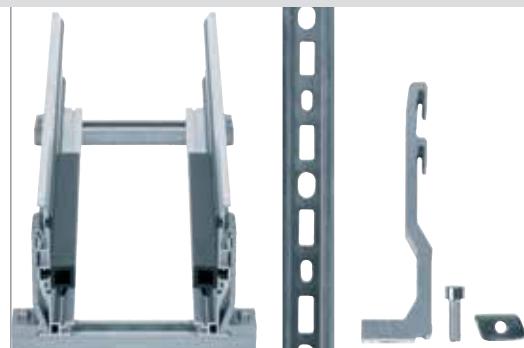

Installation Set Heavy Duty

Installation Set | Basic (Standard)



1 Pre-assemble clamp and screw



2 Clip in polymer connector on both sides of the designated support

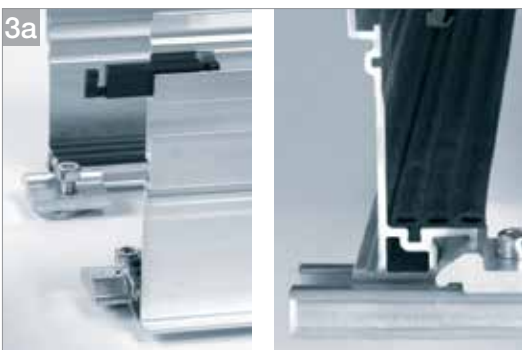

Fasten Basic assembly set inside 3a or outside 3b (Please check if the stability of the attachment is adequate). Please note: half the length of the assembly set and connector must protrude out of the trough. The glide nut should be well fastened in the profile rail

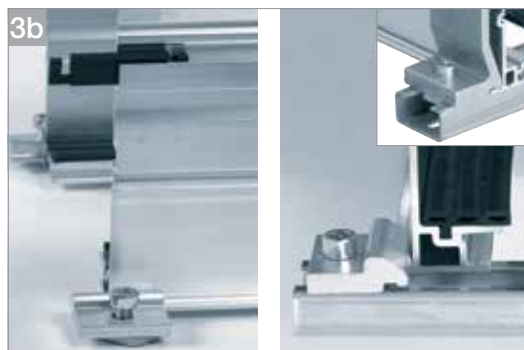

Installation Set | Heavy Duty (Alternative)



1 Pre-assemble heavy duty bracket and screw set 2 Fasten Heavy Duty assembly set outside. Please note: half the length of the assembly set and connector must protrude out of the trough.



Installing the silencer profile (optional)



Cut the rubber profile in accordance to the length of the trough, standard 6.56 ft. (2 m), and press it into the designated groove. (Pictured: although this shows the left hand side, the instructions are the same for the right hand side. To be repeated for each trough section.)

Connecting the trough sections



- ❶ Join the sides of the trough side parts by pushing them together (min. +.08 (2mm) gap!)
- ❷ + ❸ The pre-assembled parts join each trough section

Adjusting the tolerance and aligning trough sections



- ❶ Adjust the necessary minimum "chain/trough" tolerance of .08" (2mm) on both sides. Please note: the inner width B_2 of the trough decreases .08" (2mm) per side with the assembled glide strip (pictured)
- ❷ Test to ensure the e-chain[®] runs problem free and with low friction in the channel
- ❸ After adjusting the minimum tolerance and alignment of all trough sections, please tighten all trough connections. Pay attention to the correct installation direction of the sliding nut (see detail)
Starting torque of the assembly set's fixing bolts: M6: 10 Nm / M8: 23 Nm.

- ⚠ Please consider health & safety regulations while handling sheet metals.
- We recommend using protective Category II gloves to protect against cuts when handling the aluminum profiles.

PDF: igus.com/e-chain-pdfs
Product information: igus.com/e-chains

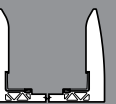
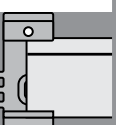
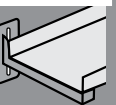

Part No. 970-30-SL and 970-31-SL - Trough Height: 3.03 in. (77 mm) Aluminum SuperTrough — Basic Version

For the following e-chains®/
E-Tubes

System E2 Series

● 10

● B15

Zipper Series

● 15/R15

B_a = Outer e-chain® width

B_i = Inner e-chain® width

h_a = e-chain® outer height

H_{Ri} = Inner trough height

H_{Ra} = Outer trough height

B_{Ri} = Inner trough width
depends on dim. B_a

B_{Ra} = Outer trough width

n_{Mon} = # of installation sets
(left/right)

n_{Ri} = # of trough set
(left/right)

! $H_{Ri} \geq 2 \cdot h_a$

■ $B_{Ri} \geq B_a + 4$

● = Guide trough

● = Glide bar

● = Installation set "Basic"

● = profile rail

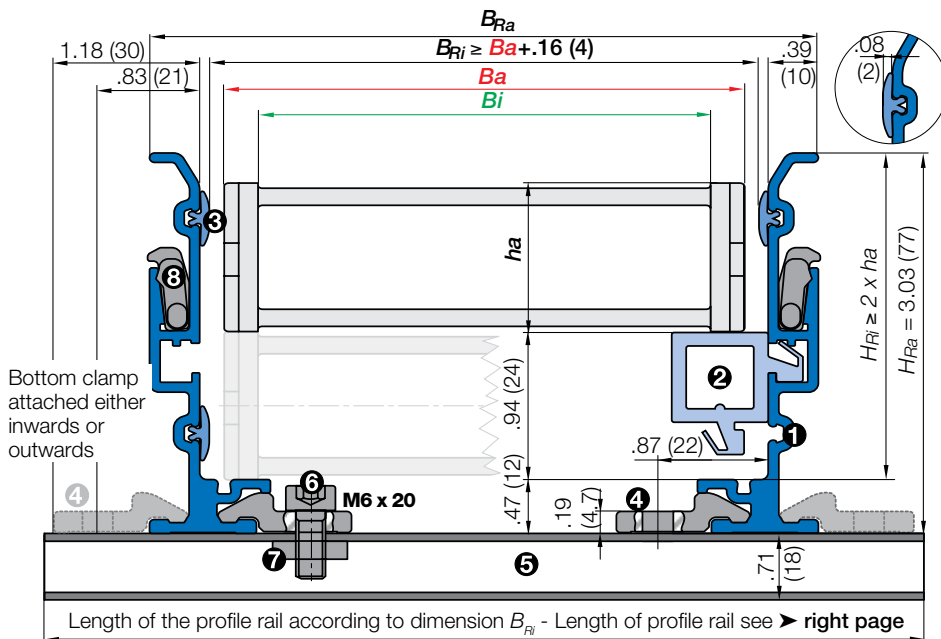

● **Components, trough "Basic":**

- ❶ Trough side parts, aluminum, 6.56 ft. (2m)
- ❷ Glide bar, plastic, 6.56 ft. (2m)
- ❸ Glide strips, plastic, 6.56 ft. (2m) (without glide strips on request)

- ❹ Bottom clamp, aluminum
- ❺ profile rail, steel galvanized
- ❻ Screw M6 x20
- ❼ Sliding nut M6
- ❽ Interface connector, plastic

● **Components, installation set "Basic":**

Basic Version: Components

Complete guide trough sets - description

Complete guide trough sets - description	Part No. (lbs)	Weight
Set of 2 trough side parts, incl. glide strips, without glide bars, 6.56 ft (2 m) sections	970-30-SL	9.26 lbs
Set of 2 trough side parts, incl. glide strips, with glide bars, 6.56 ft. (2m) sections	970-31-SL	10.8 lbs
1 Installation set "Basic" without profile rail	960-30	.13 lbs
1 Installation set "Basic" with profile rail	960-30-_____	

Single parts - description

1 Glide strip, individual, 6.56 ft. (2m) section	75-01	.13 lbs
1 Bottom clamp, individual	75-40	0.07 lbs
1 Interface connector, individual	75-60	
1 Screw M6 x 20, individual	M6X20SOCKETCAP	
1 Sliding nut M6, individual	ZBNUT-LG	
2 Glide bars, 6.56 ft. (2m) sections	81-79	
1 profile rail, individual	92-52G_____	.60 lbs/ft

Supplement Part No. with the indicated profile rail-length-index.

Example: 960-30-125 profile rail-length-index for your chosen trough inner width B_{Ri}

➤ See table on the right or the respective page for chosen series

Lengths of profile rail - Basic Version - Bottom Clamp attached either **inwards** or **outwards**

10			
e-chain® Width Index	B_{Ri} in. (mm)	Part No. attached inwards	Part No. attached outwards
-015	1.18 (30)	*	960-30-125
-025	1.57 (40)	*	960-30-150
-038	2.09 (53)	*	960-30-150
-050	2.56 (65)	960-30-125	960-30-175
-5	3.15 (80)	960-30-125	960-30-175
-6	3.86 (98)	960-30-150	960-30-200
-7	4.61 (117)	960-30-175	960-30-225

* upon request

B15			
e-chain® Width Index	B_{Ri} in. (mm)	Part No. attached inwards	Part No. attached outwards
-015	1.18 (30)	*	960-30-125
-025	1.57 (40)	*	960-30-150
-038	2.09 (53)	*	960-30-150
-050	2.56 (65)	960-30-125	960-30-175
-5	3.15 (80)	960-30-125	960-30-175
-6	3.86 (98)	960-30-150	960-30-200
-7	4.61 (117)	960-30-175	960-30-225

* upon request

15			
e-chain® Width Index	B_{Ri} in. (mm)	Part No. attached inwards	Part No. attached outwards
-015	1.18 (30)	*	960-30-125
-025	1.57 (40)	*	960-30-150
-038	2.09 (53)	*	960-30-150
-050	2.56 (65)	960-30-125	960-30-175
-5	3.15 (80)	960-30-125	960-30-175
-6	3.86 (98)	960-30-150	960-30-200
-7	4.61 (117)	960-30-175	960-30-225

* upon request

R15			
e-chain® Width Index	B_{Ri} in. (mm)	Part No. attached inwards	Part No. attached outwards
-025	1.57 (40)	*	960-30-150
-038	2.09 (53)	*	960-30-150
-063	3.15 (80)	*	960-30-175
-080	3.86 (98)	960-30-150	960-30-200

* upon request



e-chain® on the tower of the storage and retrieval unit for high-bay warehouses rolls off from one aluminum guide trough to the opposite one

PDF: igus.com/e-chain-pdfs
Product information: igus.com/e-chains

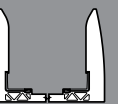
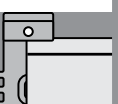
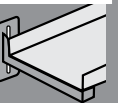

Part No. 970-30-SL and 970-32-SL - Trough Height: 3.03 in. (77 mm) Aluminum SuperTrough — Basic Version

For the following e-chains®/
E-Tubes

System E2 Series

- 1400/1450/1480/1500

System E4-1 Series

- E4-21

- B_a = Outer e-chain® width
- B_i = Inner e-chain® width
- h_a = e-chain® outer height
- H_{Ri} = Inner trough height
- H_{Ra} = Outer trough height
- B_{Ri} = Inner trough width ▶ depends on dim. B_a
- B_{Ra} = Outer trough width
- n_{Mon} = # of installation sets (left/right)
- n_{Ri} = # of trough set (left/right)
- ! $H_{Ri} \geq 2 \cdot h_a$
- ! $B_{Ri} \geq B_a + 4$
- = Guide trough
- = Glide bar
- = Installation set "Basic"
- = profile rail

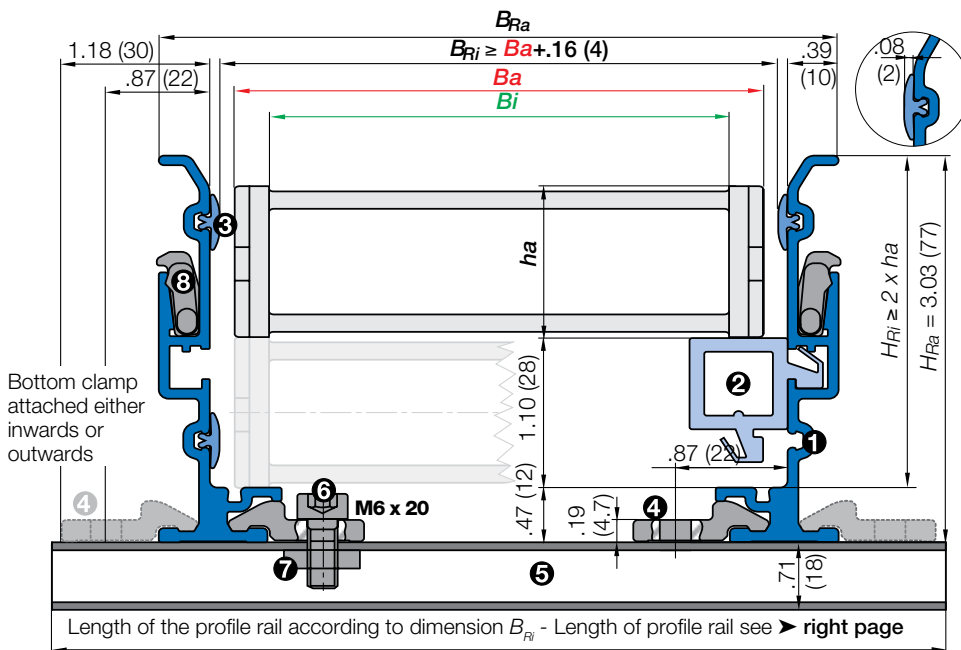

● **Components, trough "Basic":**

- 1 Trough side parts, aluminum, 6.56 ft. (2m)
- 2 Glide bar, plastic, 6.56 ft. (2m)
- 3 Glide strips, plastic, 6.56 ft. (2m) (without glide strips on request)

● **Components, installation set:**

- 4 Bottom clamp, aluminum
- 5 profile rail, steel galvanized
- 6 Screw M6 x20
- 7 Sliding nut M6
- 8 Interface connector, plastic



Basic Version: Components

Complete guide trough sets - description

Complete guide trough sets - description	Part No.	Weight
Set of 2 trough side parts, incl. glide strips, without glide bars, 6.56 ft (2 m) section	970-30-SL	9.26 lbs
Set of 2 trough side parts, incl. glide strips, with glide bars, 6.56 ft. (2m) section	970-32-SL	11.02 lbs
1 Installation set "Basic" without profile rail	960-30	.13 lbs
1 Installation set "Basic" with profile rail	960-30-___	

Single parts - description

Single parts - description	Part No.	Weight
1 Glide strip, individual, 6.56 ft. (2m) section	75-01	.13 lbs
1 Bottom clamp, individual	75-40	0.07 lbs
1 Interface connector, individual	75-60	
1 Screw M6 x 20, individual	M6X20SOCKETCAP	
1 Sliding nut M6, individual	ZBNUT-LG	
2 Glide bars, 6.56 ft. (2m) sections	81-79	
1 profile rail, individual	92-52G___	.60 lbs/ft

Supplement Part No. with the indicated profile rail-length-index.

Example: 960-30-125 profile rail-length-index for your chosen trough inner width B_{Ri}

▶ See table on the right or the respective page for chosen series

Lengths of profile rail - Basic Version - Bottom Clamp attached either **inwards** or **outwards**

1400/1500			
e-chain® Width Index	B_{Ri} in. (mm)	Part No. attached inwards	Part No. attached outwards
-015	1.30 (33)	*	960-30-125
-020	1.50 (38)	*	960-30-125
-025	1.69 (43)	*	960-30-150
-038	2.20 (56)	*	960-30-150
-050	2.68 (68)	960-30-125	960-30-175
-068	3.39 (86)	960-30-150	960-30-175
-080	3.86 (98)	960-30-150	960-30-200
-100	4.65 (118)	960-30-175	960-30-225
-125	5.63 (143)	960-30-200	960-30-250

E4-21			
e-chain® Width Index	B_{Ri} in. (mm)	Part No. attached inwards	Part No. attached outwards
-030	1.89 (48)	*	960-30-150
-040	2.28 (58)	960-30-125	960-30-150
-050	2.68 (68)	960-30-125	960-30-175
-060	3.07 (78)	960-30-125	960-30-175
-070	3.46 (88)	960-30-150	960-30-175
-080	3.86 (98)	960-30-150	960-30-200
-100	4.65 (118)	960-30-175	960-30-225
-120	5.43 (138)	960-30-200	960-30-225

* upon request

* upon request



Seawater resistant aluminum
SuperTrough in a RTG-crane. Long
travel with the E4/4 e-chain system®.

PDF: igus.com/e-chain-pdfs
Product information: igus.com/e-chains

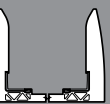
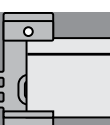
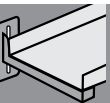

Part No. 971-30-SL and 971-31-SL - Trough Height: 3.42 in. (87 mm) Aluminum SuperTrough — Basic Version

For the following Series

System E2 Series:

- 2480

System E2 Tube Series:

- R48

igus®
e-chain system®

Telephone 1-800-521-2747

- B_a = Outer e-chain® width
- B_i = Inner e-chain® width
- h_a = e-chain® outer height
- H_{Ri} = Inner trough height
- H_{Ra} = Outer trough height
- B_{Ri} = Inner trough width ▶ depends on dim. B_a
- B_{Ra} = Outer trough width
- n_{Mon} = # of installation sets (left/right)
- n_{Ri} = # of trough set (left/right)
- ! $H_{Ri} \geq 2 \cdot h_a$
- ! $B_{Ri} \geq B_a + 4$
- = Guide trough
- = Glide bar
- = Installation set "Basic"
- = profile rail

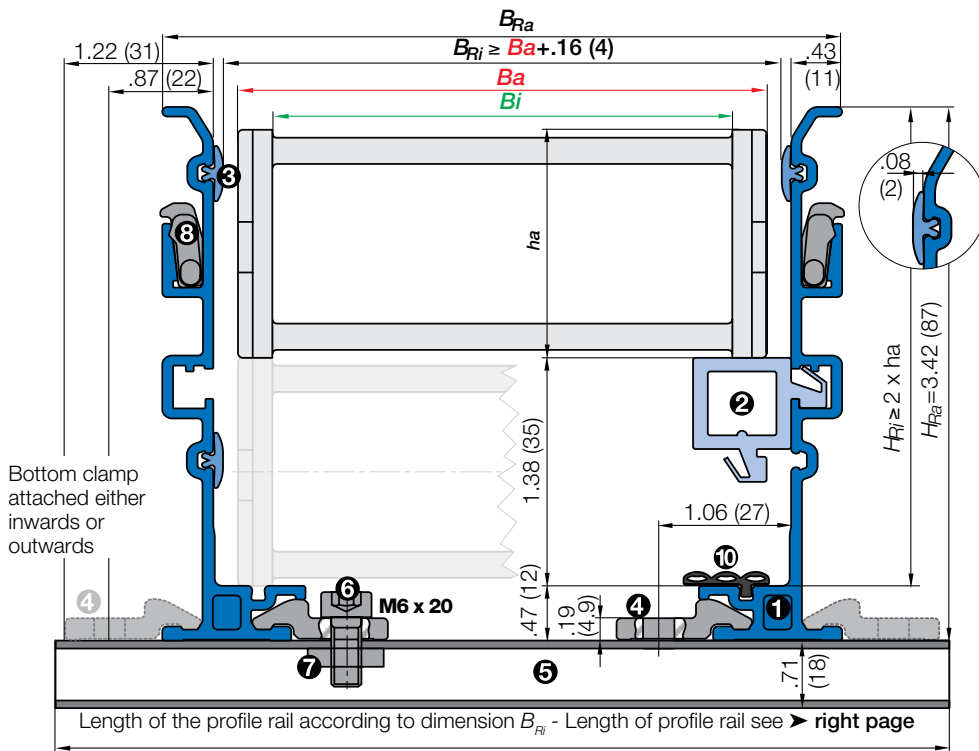

- **Components, trough:**
 - 1 Trough side parts, aluminum, 6.56 ft. (2m)
 - 2 Glide bar, plastic, 6.56 ft. (2m)
 - 3 Glide strips, plastic, 6.56 ft. (2m) (without glide strips on request)
 - 10 Optional: Silencer profile, rubber
- **Components, installation set:**
 - 4 Bottom clamp, aluminum
 - 5 profile rail, steel galvanized
 - 6 Screw M6 x 20
 - 7 Sliding nut M6
 - 8 Interface connector, plastic



Basic version: Aluminum SuperTrough components

Complete guide trough sets - description

Description	Part No.	Weight
Set of 2 trough side parts, incl. glide strips, without glide bars, 6.56 ft. (2m) section	971-30-SL	≈ 11.02 lbs
Set of 2 trough side parts, incl. glide strips, with glide bars, 6.56 ft. (2m) section	971-31-SL	≈ 14.11 lbs
1 Installation set "Basic" without profile rail	960-30	≈ .13 lbs
1 Installation set "Basic" with profile rail	960-30-___	

Single parts - description

1 Glide strip, individual, 6.56 ft. (2m) section	75-01	≈ .13 lbs
1 Bottom clamp, individual	75-40	≈ .07 lbs
1 Interface connector, individual	75-60	
1 Screw M6 x 20, individual	M6X20SOCKETCAP	
1 Sliding nut M6, individual	ZBNUT-LG	
2 Glide bar, 6.56 ft. (2m) sections	82-79	≈
1 profile rail, individual	92-52G ___	≈ .60 lbs/ft
Silencer profile	75-76-H	

Supplement Part No. with the indicated profile rail-length-index.

Example: 960-30-150 profile rail-length-index for your chosen trough inner width B_{Ri}

▶ See table on the right or the respective page for chosen series

Number of installation sets which have to be installed



Internet: igus.com
email: sales@igus.com
QuickSpec: igus.com/quickspec

Lengths of profile rail - Basic Version

Bottom Clamp can be attached either **inwards** or **outwards**

2400/2500				255				R48			
e-chain® Width Index	B _{Ri} in. (mm)	Part No. attached inwards	Part No. attached outwards	e-chain® Width Index	B _{Ri} in. (mm)	Part No. attached inwards	Part No. attached outwards	e-chain® Width Index	B _{Ri} in. (mm)	Part No. attached inwards	Part No. attached outwards
-02	1.77 (45)	*	960-30-150	-03	2.28 (58)	*	960-30-150	-025	1.57 (40)	*	960-30-150
-03	2.28 (58)	*	960-30-150	-05	3.03 (77)	960-30-125	960-30-175	-050	2.56 (65)	*	960-30-175
-05	3.03 (77)	960-30-125	960-30-175	-07	3.82 (97)	960-30-150	960-30-200	-075	3.54 (90)	960-30-150	960-30-200
-07	3.82 (97)	960-30-150	960-30-200	-10	4.84 (123)	960-30-175	960-30-225	-100	4.53 (115)	960-30-175	960-30-225
-09	4.29 (109)	960-30-175	960-30-225	* upon request				-130	5.71 (145)	960-30-200	960-30-250
-10	4.84 (123)	960-30-175	960-30-225					* upon request			
-12	5.71 (145)	960-30-200	960-30-250								

* upon request

For the "Heavy Duty" installation set:

Insert Part No. **971-50-____**

instead of **960-30-____**

on the right column "attached outwards"

PDF: igus.com/e-chain-pdfs
Product information: igus.com/e-chains

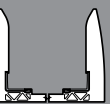
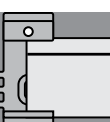
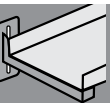

Heavy Duty Version - Installation Set Part No. 971-50

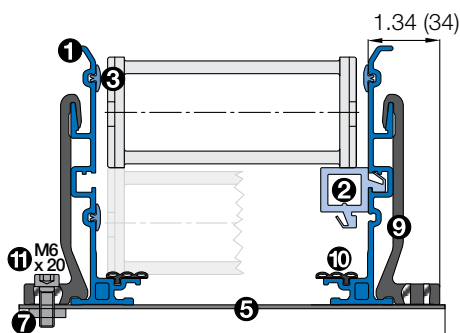

● Components, trough "Heavy Duty":

- ❶ Trough side parts, aluminum, 6.56 ft. (2m)
- ❷ Glide bar, plastic, 6.56 ft. (2m)
- ❸ Glide strips, plastic 6.56 ft. (2m)
(without glide strips on request)
- ❿ Optional: Silencer profile, rubber

● Components, installation set "Heavy Duty":

- ❺ profile rail, steel galvanized
- ❽ Sliding nut M6
- ❾ Heavy duty bracket, aluminum
- ❶❶ Screw M6 x 20



- = Guide trough
- = Glide bar
- = Installation set "Heavy duty"
- = profile rail

Note: Dimensions similar to Basic version!
Exception: Heavy duty bracket, see drawing

Part No. 972-02-30-SL and 972-02-31-SL
Trough Height: 4.61 in. (117 mm)
Aluminum SuperTrough — Basic Version

For the following Series

System E4-1 Series

- E4-28/R4-28

System E4-1 Light Series

- E4-31L

igus®
e-chain system®

Telephone 1-800-521-2747

- B_a = Outer e-chain® width
 - B_i = Inner e-chain® width
 - h_a = e-chain® outer height
 - H_{Ri} = Inner trough height
 - H_{Ra} = Outer trough height
 - B_{Ri} = Inner trough width ▶ depends on dim. B_a
 - B_{Ra} = Outer trough width
 - n_{Mon} = # of installation sets (left/right)
 - n_{Ri} = # of trough set (left/right)
- !** $H_{Ri} \geq 2 \cdot h_a$
 $B_{Ri} \geq B_a + 4$
- = Guide trough
 - = Glide bar
 - = Installation set "Basic"
 - = profile rail

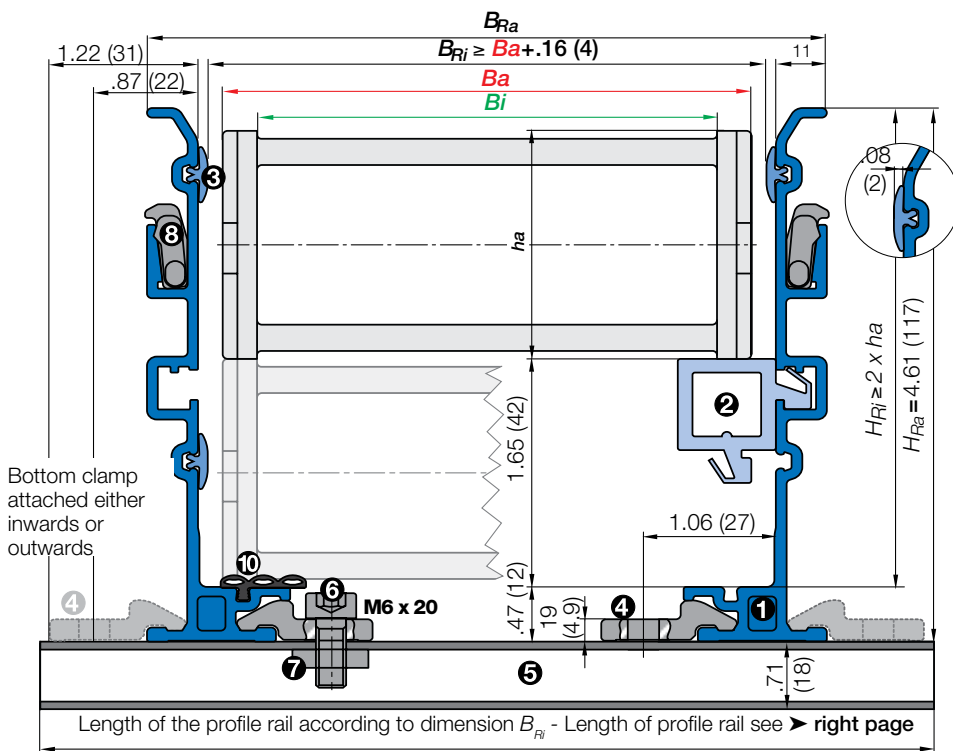

● **Components, trough:**

- 1 Trough side parts, aluminum, 6.56 ft. (2m)
- 2 Glide bar, plastic, 6.56 ft. (2m)
- 3 Glide strips, plastic, 6.56 ft. (2m) (without glide strips on request)
- 10 Optional: Silencer profile, rubber

● **Components, installation set:**

- 4 Bottom clamp, aluminum
- 5 profile rail, steel galvanized
- 6 Screw M6 x20
- 7 Sliding nut M6
- 8 Interface connector, plastic



Basic version: Aluminum SuperTrough components

Complete guide trough sets - description

Complete guide trough sets - description	Part No.	Weight
Set of 2 trough side parts, incl. glide strips, without glide bars, 6.56 ft. (2m) section	972-02-30-SL	≈ 13.23 lbs
Set of 2 trough side parts, incl. glide strips, with glide bars, 6.56 ft. (2m) section	972-02-31-SL	≈ 16.31 lbs
1 Installation set "Basic" without profile rail	960-30	≈ .13 lbs
1 Installation set "Basic" with profile rail	960-30-__	

Single parts - description

1 Glide strip, individual, 6.56 ft. (2m) section	75-01	≈ .13 lbs
1 Bottom clamp, individual	75.40	≈ .07 lbs
1 Interface connector, individual	75-60	
1 Screw M6 x 20, individual	M6X20SOCKETCAP	
1 Sliding nut M6, individual	ZBNUT-LG	
2 Glide bars, 6.56 ft. (2m) sections	82-79	≈
1 profile rail, individual	92-52G__	≈ .60 lbs/ft.
Silencer profile	75-67H	

Supplement Part No. with the indicated profile rail-length-index.

Example: 960-30-175 profile rail-length-index for your chosen trough inner width B_{Ri}

▶ See table on the right or the respective page for chosen series

Number of installation sets which have to be installed

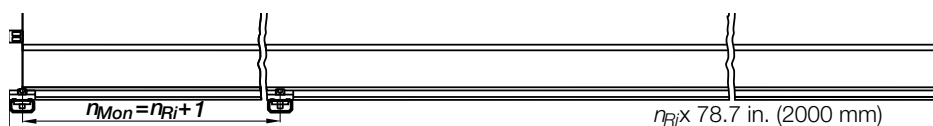

Internet: igus.com
email: sales@igus.com
QuickSpec: igus.com/quickspec

Guide Trough Systems Aluminum SuperTrough

Lengths of profile rail - Basic Version

Bottom Clamp can be attached either **inwards** or **outwards**



E4-28/R4-28				E4-31L			
e-chain® Width Index	B _{Ri} in. (mm)	Part No. attached inwards	Part No. attached outwards	e-chain® Width Index	B _{Ri} in. (mm)	Part No. attached inwards	Part No. attached outwards
-040	2.52 (64)	*	960-30-175	-040	2.28 (58)	*	960-30-150
-050	2.91 (74)	960-30-125	960-30-175	-050	2.68 (68)	*	960-30-175
-062	3.39 (86)	960-30-150	960-30-200	-062	3.15 (80)	960-30-150	960-30-175
-070	3.31 (94)	960-30-150	960-30-200	-075	3.66 (93)	960-30-150	960-30-200
-075	3.90 (99)	960-30-175	960-30-225	-087	4.13 (105)	960-30-175	960-30-200
-087	4.37 (111)	960-30-175	960-30-225	-100	4.65 (118)	960-30-175	960-30-225
-100	4.88 (124)	960-30-200	960-30-250	-112	5.12 (130)	960-30-200	960-30-225
-125	5.87 (149)	960-30-200	960-30-250	-125	5.63 (143)	960-30-200	960-30-250
-150	6.85 (174)	960-30-200	960-30-250	-150	6.61 (168)	960-30-225	960-30-275
-175	7.83 (199)	960-30-225	960-30-275	-162	7.09 (180)	960-30-250	960-30-275
-200	8.82 (224)	960-30-225	960-30-275	-175	7.60 (193)	960-30-250	960-30-300
-225	9.80 (249)	960-30-250	960-30-300				
-250	10.78 (274)	960-30-250	960-30-300				
-275	11.77 (299)	960-30-250	960-30-300				
-300	12.76 (324)	960-30-275	960-30-325				

* upon request

* upon request

PDF: igus.com/e-chain-pdfs
Product information: igus.com/e-chains

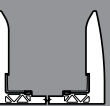
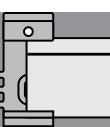
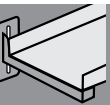

Heavy Duty Version - Installation Set Part No. 972-50

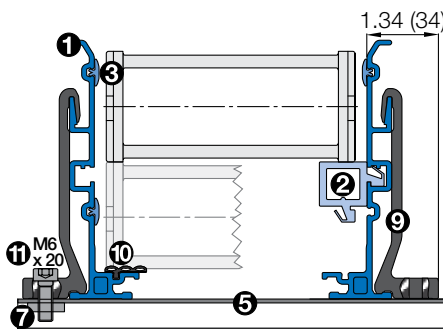

- **Components, trough "Heavy Duty":**
- ❶ Trough side parts, aluminum, 6.56 ft. (2m)
- ❷ Glide bar, plastic, 6.56 ft. (2m)
- ❸ Glide strips, plastic 6.56 ft. (2m)
(without glide strips on request)
- ❷ Optional: Silencer profile, rubber
- **Components, installation set "Heavy Duty":**
- ❺ profile rail, steel galvanized
- ❽ Sliding nut M6
- ❾ Heavy duty bracket, aluminum
- ❶ M6 x 20



- = Guide trough
- = Glide bar
- = Installation set "Heavy duty"
- = profile rail

• For the "Heavy Duty" installation set:
Insert Part No. **972-50-**_____ instead of **960-30-**_____ on the right column "attached outwards"

Part No. 972-30-SL and 972-31-SL Trough Height: 4.61 in. (117 mm) Aluminum SuperTrough — Basic Version

For the following Series

System E4-1 Series

- E4-32/H4-32/R4-32

System E4-1L Series:

- E4-38L/R4-38L

igus®
e-chain system®

Telephone 1-800-521-2747

- B_a = Outer e-chain® width
- B_i = Inner e-chain® width
- h_a = e-chain® outer height
- H_{Ri} = Inner trough height
- H_{Ra} = Outer trough height
- B_{Ri} = Inner trough width ▶ depends on dim. B_a
- B_{Ra} = Outer trough width
- n_{Mon} = # of installation sets (left/right)
- n_{Ri} = # of trough set (left/right)
- ! $H_{Ri} \geq 2 \cdot h_a$
- ! $B_{Ri} \geq B_a + 4$
- = Guide trough
- = Glide bar
- = Installation set "Basic"
- = profile rail

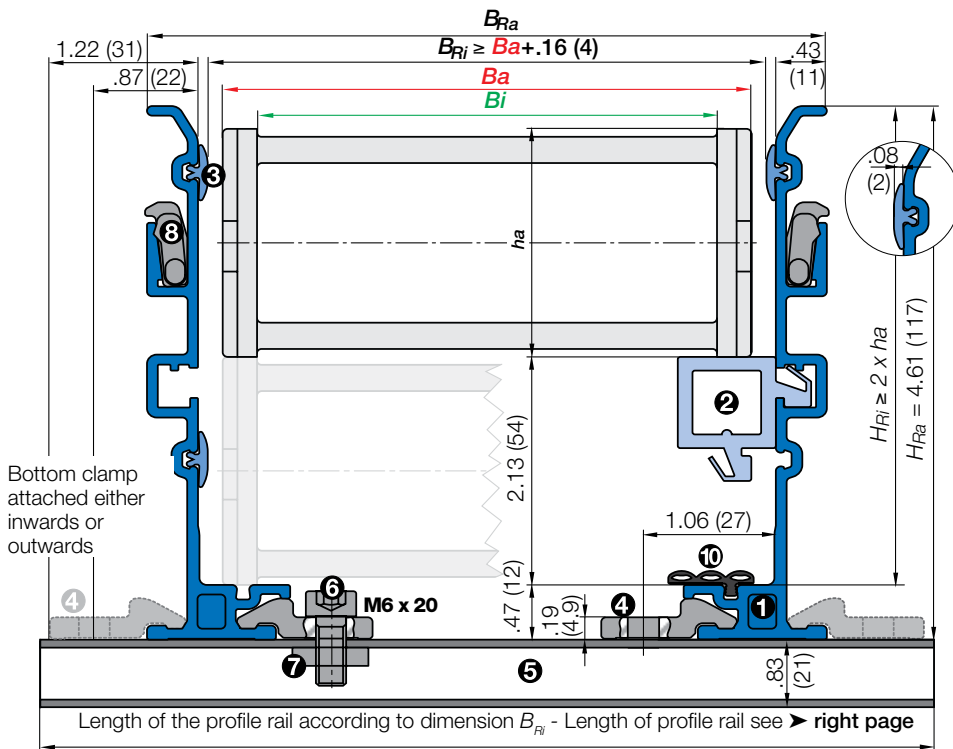

● **Components, trough:**

- 1 Trough side parts, aluminum, 6.56 ft. (2m)
- 2 Glide bar, plastic, 6.56 ft. (2m)
- 3 Glide strips, plastic, 6.56 ft. (2m) (without glide strips on request)
- 10 Optional: Silencer profile, rubber

● **Components, installation set:**

- 4 Bottom clamp, aluminum
- 5 profile rail, steel galvanized
- 6 Screw M6 x20
- 7 Sliding nut M6



Basic version: Aluminum SuperTrough components

Complete guide trough sets - description

Complete guide trough sets - description	Part No.	Weight
Set of 2 trough side parts, incl. glide strips, without glide bars, 6.56 ft. (2m) section	972-30-SL	≈ 13.23 lbs
Set of 2 trough side parts, incl. glide strips, with glide bars, 6.56 ft. (2m) section	972-31-SL	≈ 16.31 lbs
1 Installation set "Basic" without profile rail	960-30	≈ .13 lbs
1 Installation set "Basic" with profile rail	960-30-__	

Single parts - description

1 Glide strip, individual, 6.56 ft. (2m) section	75-01	≈ .13 lbs
1 Bottom clamp, individual	75.40	≈ .07 lbs
1 Interface connector, individual	75-60	
1 Screw M6 x 20, individual	M6X20SOCKETCAP	
1 Sliding nut M6, individual	ZBNUT-LG	
2 Glide bars, 6.56 ft. (2m) sections	82-79	≈
1 profile rail, individual	92-52__	≈ .60 lbs/ft.
Silencer profile	75-67H	

Supplement Part No. with the indicated profile rail-length-index.

Example: 960-30-150 profile rail-length-index for your chosen trough inner width B_{Ri}

▶ See table on the right or the respective page for chosen series

Number of installation sets which have to be installed



Internet: igus.com
email: sales@igus.com
QuickSpec: igus.com/quickspec

Guide Trough Systems Aluminum SuperTrough

Lengths of profile rail - Basic Version

Bottom Clamp can be attached either **inwards** or **outwards**

E4-32/H4-32/R4-32				E4-38L/R4-38L			
e-chain® Width Index	B _{Ri} in. (mm)	Part No. attached inwards	Part No. attached outwards	e-chain® Width Index	B _{Ri} in. (mm)	Part No. attached inwards	Part No. attached outwards
-05	3.03 (77)	960-30-125	960-30-175	-050	2.76 (70)	*	960-30-200
-06	3.74 (95)	960-30-150	960-30-200	-062	3.23 (82)	*	960-30-200
-07	4.02 (102)	960-30-150	960-30-200	-075	3.74 (95)	*	960-30-225
-087	4.49 (114)	960-30-175	960-30-225	-087	4.21 (107)	*	960-30-225
-10	5.00 (127)	960-30-175	960-30-225	-100	4.72 (120)	960-30-175	960-30-250
-11	5.31 (135)	960-30-200	960-30-250	-105	4.92 (125)	960-30-175	960-30-250
-112	5.51 (140)	960-30-200	960-30-250	-112	5.20 (132)	960-30-200	960-30-250
-12	5.98 (152)	960-30-200	960-30-250	-125	5.71 (145)	960-30-200	960-30-275
-137	6.50 (165)	960-30-225	960-30-275	-137	6.18 (157)	960-30-225	960-30-275
-15	6.97 (177)	960-30-225	960-30-275	-150	6.69 (170)	960-30-225	960-30-300
-162	7.48 (190)	960-30-250	960-30-300	-162	7.17 (182)	960-30-250	960-30-300
-17	7.68 (195)	960-30-250	960-30-300	-175	7.68 (195)	960-30-250	960-30-325
-18	7.95 (202)	960-30-250	960-30-300	-187	8.15 (207)	960-30-275	960-30-325
-187	8.46 (215)	960-30-275	960-30-325	-200	8.66 (220)	960-30-275	960-30-350
-20	8.94 (227)	960-30-275	960-30-325	-212	9.13 (232)	960-30-300	960-30-350
-212	9.45 (240)	960-30-300	960-30-350	-225	9.65 (245)	960-30-300	960-30-375
-23	9.92 (252)	960-30-300	960-30-350	-237	10.12 (257)	960-30-325	960-30-375
-237	10.43 (265)	960-30-325	960-30-375	-250	10.63 (270)	960-30-325	960-30-375
-25	10.91 (277)	960-30-325	960-30-375	-262	11.10 (282)	960-30-325	960-30-375
-262	11.42 (290)	960-30-350	960-30-400	-300	12.60 (320)	960-30-375	960-30-425
-28	11.89 (302)	960-30-350	960-30-400	*upon request			
-29	12.40 (315)	960-30-375	960-30-425				
-30	12.87 (327)	960-30-375	960-30-425				
-312	13.39 (340)	960-30-400	960-30-450				
-325	13.86 (352)	960-30-400	960-30-450				
-337	14.37 (365)	960-30-425	960-30-475				
-350	14.84 (377)	960-30-425	960-30-475				
-362	15.35 (390)	960-30-450	960-30-500				
-375	15.83 (402)	960-30-450	960-30-500				
-387	16.34 (415)	960-30-475	960-30-525				
-400	16.81 (427)	960-30-475	960-30-525				

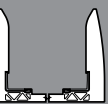
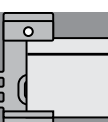
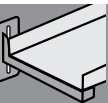

Heavy Duty Version - Installation Set Part No. 972-50

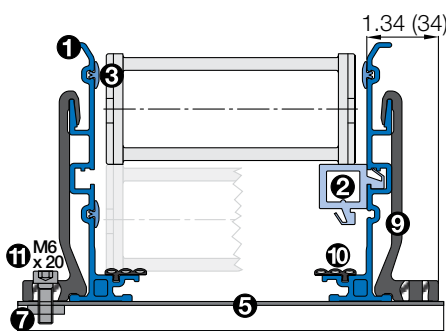

● Components, trough "Heavy Duty":

- ❶ Trough side parts, aluminum, 6.56 ft. (2m)
- ❷ Glide bar, plastic, 6.56 ft. (2m)
- ❸ Glide strips, plastic 6.56 ft. (2m)
(without glide strips on request)

- ❷ Optional: Silencer profile, rubber

● Components, installation set "Heavy Duty":

- ❺ profile rail, steel galvanized
- ❻ Sliding nut M6
- ❹ Heavy duty bracket, aluminum
- ❻ Screw M6 x 20



- = Guide trough
- = Glide bar
- = Installation set "Heavy duty"
- = profile rail

- For the "Heavy Duty" installation set:
Insert Part No. **972-50-___** instead of **960-30-___**
on the right column "attached outwards"

Note: Dimensions similar to Basic version!
Exception: Heavy duty bracket, see drawing

Part No. 972-30-SL and 972-32-SL Trough Height: 4.61 in. (117 mm) Aluminum SuperTrough — Basic Version

For the following Series

System E2 Series:

- 2700

System E2 Tube Series:

- R58

- B_a = Outer e-chain® width
- B_i = Inner e-chain® width
- h_a = e-chain® outer height
- H_{Ri} = Inner trough height
- H_{Ra} = Outer trough height
- B_{Ri} = Inner trough width \blacktriangleright depends on dim. B_a
- B_{Ra} = Outer trough width
- n_{Mon} = # of installation sets (left/right)
- n_{Ri} = # of trough set (left/right)
- !** $H_{Ri} \geq 2 \cdot h_a$
- !** $B_{Ri} \geq B_a + 4$

- = Guide trough
- = Glide bar
- = Installation set "Basic"
- = profile rail

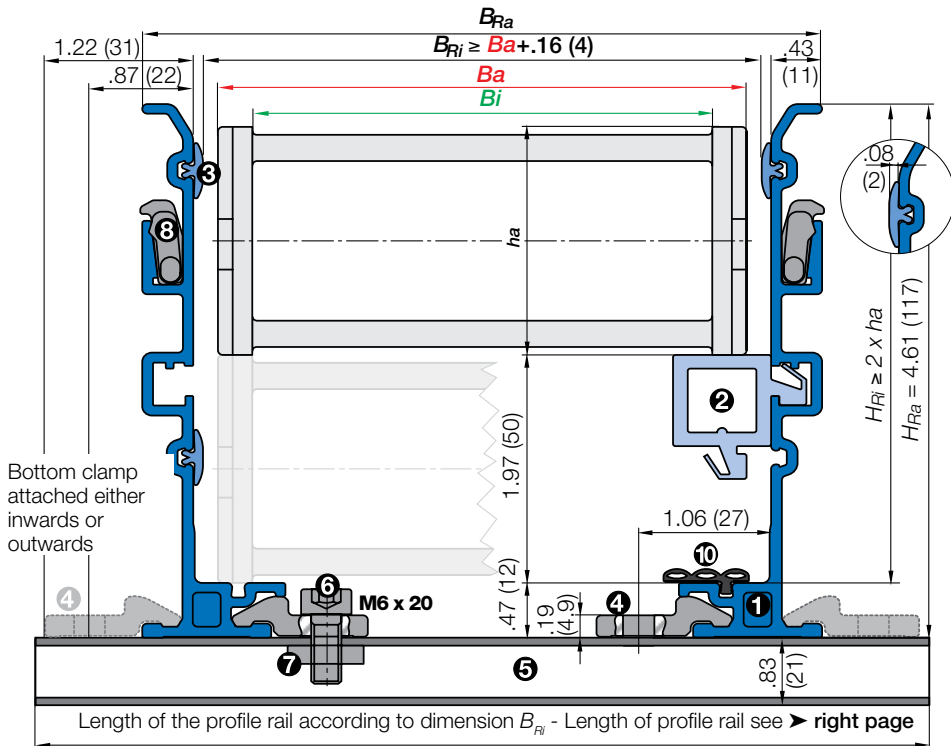

- **Components, trough:**
 - 1 Trough side parts, aluminum, 6.56 ft. (2m)
 - 2 Glide bar, plastic, 6.56 ft. (2m)
 - 3 Glide strips, plastic, 6.56 ft. (2m) (without glide strips on request)
 - 10 Optional: Silencer profile, rubber
- **Components, installation set:**
 - 4 Bottom clamp, aluminum
 - 5 profile rail, steel galvanized
 - 6 Screw M6 x 20
 - 7 Sliding nut M6



Basic version: Aluminum SuperTrough components

Complete guide trough sets - description

Description	Part No.	Weight
Set of 2 trough side parts, incl. glide strips, without glide bars, 6.56 ft. (2m) section	972-30-SL	≈ 13.23 lbs
Set of 2 trough side parts, incl. glide strips, with glide bars, 6.56 ft. (2m) section	972-32-SL	≈ 16.31 lbs
1 Installation set "Basic" without profile rail	960-30	≈ .13 lbs
1 Installation set "Basic" with profile rail	960-30-___	

Single parts - description

1 Glide strip, individual, 6.56 ft. (2m) section	75-01	≈ .13 lbs
1 Bottom clamp, individual	75-40	≈ .07 lbs
1 Interface connector, individual	75-60	
1 Screw M6 x 20, individual	M6X20SOCKETCAP	
1 Sliding nut M6, individual	ZBNUT-LG	
2 Glide bars, 6.56 ft. (2m) sections	82-79	≈
1 profile rail, individual	92-52 ___	≈ .60 lbs/ft.
Silencer profile	75-67H	

Supplement Part No. with the indicated profile rail-length-index.

Example: 960-30-150 profile rail-length-index for your chosen trough inner width B_{Ri}

\blacktriangleright See table on the right or the respective page for chosen series

Number of installation sets which have to be installed

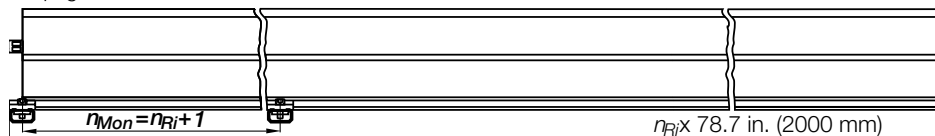

Lengths of profile rail - Basic Version

Bottom Clamp can be attached either **inwards** or **outwards**

2700				R58			
e-chain® Width Index	B_{Ri} in. (mm)	Part No. attached inwards	Part No. attached outwards	e-chain® Width Index	B_{Ri} in. (mm)	Part No. attached inwards	Part No. attached outwards
-05	2.76 (70)	*	960-30-175	-050	2.76 (70)	*	960-30-175
-06	3.35 (85)	960-30-150	960-30-200	-075	3.74 (95)	960-30-150	960-30-200
-07	3.74 (95)	960-30-150	960-30-200	-100	4.72 (120)	960-30-175	960-30-225
-09	4.33 (110)	960-30-175	960-30-225	-125	5.71 (145)	960-30-200	960-30-250
-10	4.72 (120)	960-30-175	960-30-225	-150	6.69 (170)	960-30-225	960-30-275
-12	5.71 (145)	960-30-200	960-30-250	-175	7.58 (195)	960-30-250	960-30-300
-15	6.69 (170)	960-30-225	960-30-275	-200	8.66 (220)	960-30-275	960-30-325
-17	7.79 (198)	960-30-250	960-30-300				



Stable guidance without oscillation. Because of the compact design of the aluminum SuperTrough the need for space along the travel path is small.

Travel 105 ft. (32 m) Crane operating speed 262 ft./min. (80 m/min).

Heavy Duty Version - Installation Set Part No. 972-50

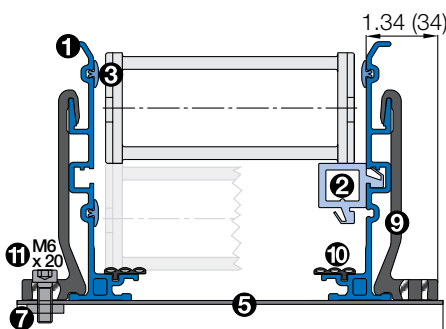

● Components, trough "Heavy Duty":

- ❶ Trough side parts, aluminum, 6.56 ft. (2m)
- ❷ Glide bar, plastic, 6.56 ft. (2m)
- ❸ Glide strips, plastic 6.56 ft. (2m)
(without glide strips on request)

❷ Optional: Silencer profile, rubber

● Components, installation set "Heavy Duty":

- ❺ profile rail, steel galvanized
- ❽ Sliding nut M6
- ❾ Heavy duty bracket, aluminum
- ❿ Screw M6 x 20



- = Guide trough
- = Glide bar
- = Installation set "Heavy duty"
- = profile rail

For the "Heavy Duty" installation set:
Insert Part No. **972-50-___** instead of **960-30-___**
on the right column "attached outwards"

Note: Dimensions similar to Basic version!
Exception: Heavy duty bracket, see drawing

PDF: igus.com/e-chain-pdfs
Product information: igus.com/e-chains

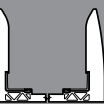
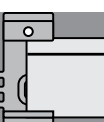
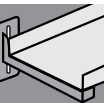

Part No. 973-30-SL and 973-31-SL Trough Height: 5.67 in. (144 mm)
Aluminum SuperTrough — Basic Version

For the following Series

System E2 Series:

- 3480

System E2 Tube Series:

- R68

System E4-1 Series

- E4-42/H4-42/R4-42

System E4-1L Series:

- E4-48L/R4-48L

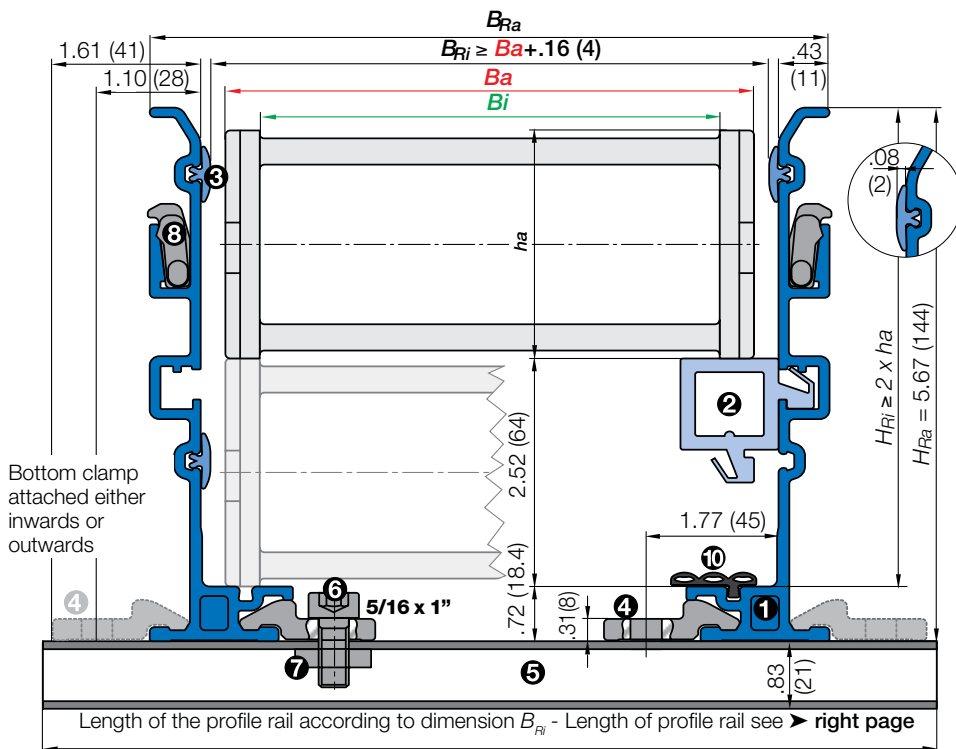

- B_a = Outer e-chain® width
- B_i = Inner e-chain® width
- h_a = e-chain® outer height
- H_{Ri} = Inner trough height
- H_{Ra} = Outer trough height
- B_{Ri} = Inner trough width \blacktriangleright depends on dim. B_a
- B_{Ra} = Outer trough width
- n_{Mon} = # of installation sets (left/right)
- n_{Ri} = # of trough set (left/right)
- $H_{Ri} \geq 2 \cdot h_a$
- $B_{Ri} \geq B_a + 4$
- = Guide trough
- = Glide bar
- = Installation set "Basic"
- = profile rail

● Components, trough:

- ① Trough side parts, aluminum, 6.56 ft. (2m)
- ② Glide bar, plastic, 6.56 ft. (2m)
- ③ Glide strips, plastic, 6.56 ft. (2m) (without glide strips on request)
- ⑩ Optional: Silencer profile, rubber

● Components, installation set:

- ④ Bottom clamp, aluminum
- ⑤ profile rail, steel galvanized
- ⑥ Screw 5/16 x 1"
- ⑦ Sliding nut 5/16



Basic version: Aluminum SuperTrough components

Complete guide trough sets - description	Part No.	Weight
Set of 2 trough side parts, incl. glide strips, without glide bars, 6.56 ft. (2m) section	973-30-SL	≈ 17.64 lbs
Set of 2 trough side parts, incl. glide strips, with glide bars, 6.56 ft. (2m) section	973-31-SL	≈ 23.81 lbs
1 Installation set "Basic" without profile rail	960-40	≈ .18 lbs
1 Installation set "Basic" with profile rail	960-40-___	
Single parts - description		
1 Glide strip, individual, 6.56 ft. (2m) section	75-01	≈ .13 lbs
1 Bottom clamp, individual	75.50	≈ .09 lbs
1 Interface connector, individual	75-60	
1 Screw 5/16 x 1", individual	82-55	
1 Sliding nut 5/16, individual	82-56	
2 Glide bars, 6.56 ft. (2m) sections	83-79	≈
1 profile rail, individual	92-52___	≈ .60 lbs/ft.
Silencer profile	75-68H	

Supplement Part No. with the indicated profile rail-length-index.

Example: 960-30-150 profile rail-length-index for your chosen trough inner width B_{Ri}

▶ See table on the right or the respective page for chosen series

Number of installation sets which have to be installed



igus® e-chain system®

Telephone 1-800-521-2747

Internet: igus.com
email: sales@igus.com
QuickSpec: igus.com/quickspec

Guide Trough Systems Aluminum SuperTrough

Lengths of profile rail - Basic Version

Bottom Clamp can be attached either **inwards** or **outwards**



Guide
Trough

3400/3500				E4-42/H4-42/R4-42				E4-48L/R4-48L			
e-chain® Width Index	Part No. B _{ri} in. (mm)	Part No. attached inwards	attached outwards	e-chain® Width Index	Part No. B _{ri} in. (mm)	Part No. attached inwards	attached outwards	e-chain® Width Index	Part No. B _{ri} in. (mm)	Part No. attached inwards	attached outwards
-050	2.91 (74)	*	960-40-200	-05	3.15 (80)	*	960-40-200	-050	2.91 (74)	*	960-30-200
-075	3.90 (99)	*	960-40-225	-06	3.86 (98)	*	960-40-225	-062	3.39 (86)	*	960-30-200
-100	4.88 (124)	960-40-175	960-40-250	-07	4.13 (105)	*	960-40-225	-075	3.90 (99)	*	960-30-225
-115	5.47 (139)	960-40-200	960-40-275	-087	4.65 (118)	960-40-175	960-40-250	-087	4.37 (111)	960-30-175	960-30-225
-125	5.87 (149)	960-40-200	960-40-275	-10	5.12 (130)	960-40-200	960-40-250	-100	4.88 (124)	960-30-175	960-30-250
-150	6.85 (174)	960-40-225	960-40-300	-11	5.43 (138)	960-40-200	960-40-275	-105	4.92 (125)	960-30-200	960-30-250
-175	7.83 (199)	960-40-250	960-40-325	-112	5.63 (143)	960-40-200	960-40-275	-112	5.35 (136)	960-30-200	960-30-250
-200	8.82 (224)	960-40-275	960-40-350	-12	6.10 (155)	960-40-225	960-40-275	-125	5.87 (149)	960-30-225	960-30-275
-225	9.80 (249)	960-40-300	960-40-375	-137	6.61 (168)	960-40-225	960-40-300	-137	6.34 (161)	960-30-225	960-30-275
-250	10.79 (274)	960-40-325	960-40-400	-15	7.09 (180)	960-40-250	960-40-300	-150	6.85 (174)	960-30-250	960-30-300
				-162	7.60 (193)	960-40-250	960-40-325	-162	7.32 (186)	960-30-250	960-30-300
				-17	7.80 (198)	960-40-250	960-40-325	-175	7.83 (199)	960-30-275	960-30-325
				-18	8.07 (205)	960-40-275	960-40-325	-200	8.82 (224)	960-30-300	960-30-350
				-187	8.58 (218)	960-40-275	960-40-350	-225	9.80 (249)	960-30-325	960-30-375
				-20	9.06 (230)	960-40-300	960-40-350	-237	10.28 (261)	960-30-325	960-30-375
				-212	9.57 (243)	960-40-300	960-40-375	-250	10.79 (274)	960-30-325	960-30-375
				-23	10.04 (255)	960-40-325	960-40-375	-262	11.10 (282)	960-30-325	960-30-375
				-237	10.55 (268)	960-40-325	960-40-400	-275	11.61 (295)	960-30-350	960-30-400
				-25	11.02 (280)	960-40-350	960-40-400	-287	12.09 (307)	960-30-350	960-30-400
				-262	11.54 (293)	960-40-350	960-40-425	-300	12.60 (320)	960-30-375	960-30-425
				-28	12.01 (305)	960-40-375	960-40-425	-312	13.07 (332)	960-30-375	960-30-425
				-29	12.52 (318)	960-40-375	960-40-450	-325	13.58 (345)	960-30-400	960-30-450
				-30	12.99 (330)	960-40-400	960-40-450	-337	14.06 (357)	960-30-400	960-30-450
				-312	13.50 (343)	960-40-400	960-40-475	-350	14.57 (370)	960-30-425	960-30-475
				-325	13.98 (355)	960-40-425	960-40-475	-362	15.04 (382)	960-30-450	960-30-475
				-337	14.49 (368)	960-40-425	960-40-500	-375	15.55 (395)	960-30-450	960-30-500
				-350	14.96 (380)	960-40-450	960-40-500	-387	16.02 (407)	960-30-450	960-30-500
				-362	15.47 (393)	960-40-450	960-40-525	-400	16.54 (420)	960-30-475	960-30-500
				-375	15.98 (406)	960-40-475	960-40-525				
				-387	16.46 (418)	960-40-475	960-40-550				
				-400	16.93 (430)	960-40-500	960-40-550				

R68			
e-chain® Width Index	Part No. B _{ri} in. (mm)	Part No. attached inwards	attached outwards
-050	2.83 (72)	*	960-40-200
-075	3.82 (97)	*	960-40-225
-100	4.80 (122)	960-40-175	960-40-250
-115	5.39 (137)	960-40-200	960-40-275
-125	5.79 (147)	960-40-200	960-40-275
-150	6.77 (172)	960-40-225	960-40-300
-175	7.76 (197)	960-40-250	960-40-325
-200	8.74 (222)	960-40-275	960-40-350
-225	9.72 (247)	960-40-300	960-40-375
-250	10.71 (272)	960-40-325	960-40-400

PDF: igus.com/e-chain-pdfs
Product information: igus.com/e-chains

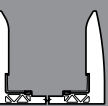
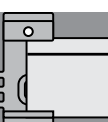
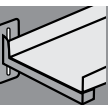

Heavy Duty Version - Installation Set Part No. 973-50

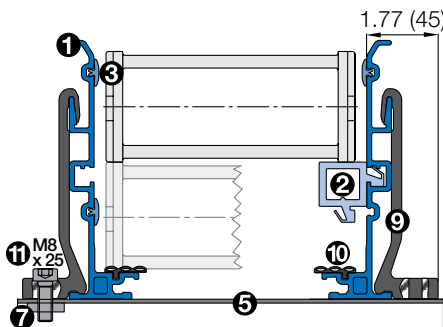

- **Components, trough "Heavy Duty":**
 - ① Trough side parts, aluminum, 6.56 ft. (2m)
 - ② Glide bar, plastic, 6.56 ft. (2m)
 - ③ Glide strips, plastic 6.56 ft. (2m)
(without glide strips on request)
 - ⑩ Optional: Silencer profile, rubber
- **Components, installation set "Heavy Duty":**
 - ⑤ profile rail, steel galvanized
 - ⑦ Sliding nut 5/16
 - ⑨ Heavy duty bracket, aluminum
 - ⑪ Screw 5/16 x 1"



- = Guide trough
- = Glide bar
- = Installation set "Heavy duty"
- = profile rail

For the "Heavy Duty" installation set:
Insert Part No. **973-50-_____** instead of **960-40-_____**
on the right column "attached outwards"

Note: Dimensions similar to Basic version!
Exception: Heavy duty bracket, see drawing

Part No. 974-30-SL and 974-31-SL Trough Height: 7.24 in. (184 mm)
Aluminum SuperTrough — Basic Version

For the following Series

- System E4-1 Series
 - E4-56/H4-56/R4-56
- System E4-1 Light Series
 - E4-64L
- System E4 Light Series:
 - 14040/14140/R18840
 - 14240/14340

igus® e-chain system®

Telephone 1-800-521-2747

- B_a = Outer e-chain® width
 - B_i = Inner e-chain® width
 - h_a = e-chain® outer height
 - H_{Ri} = Inner trough height
 - H_{Ra} = Outer trough height
 - B_{Ri} = Inner trough width \blacktriangleright depends on dim. B_a
 - B_{Ra} = Outer trough width
 - n_{Mon} = # of installation sets (left/right)
 - n_{Ri} = # of trough set (left/right)
- !** $H_{Ri} \geq 2 \cdot h_a$
 $B_{Ri} \geq B_a + 4$
- = Guide trough
 - = Glide bar
 - = Installation set "Basic"
 - = profile rail

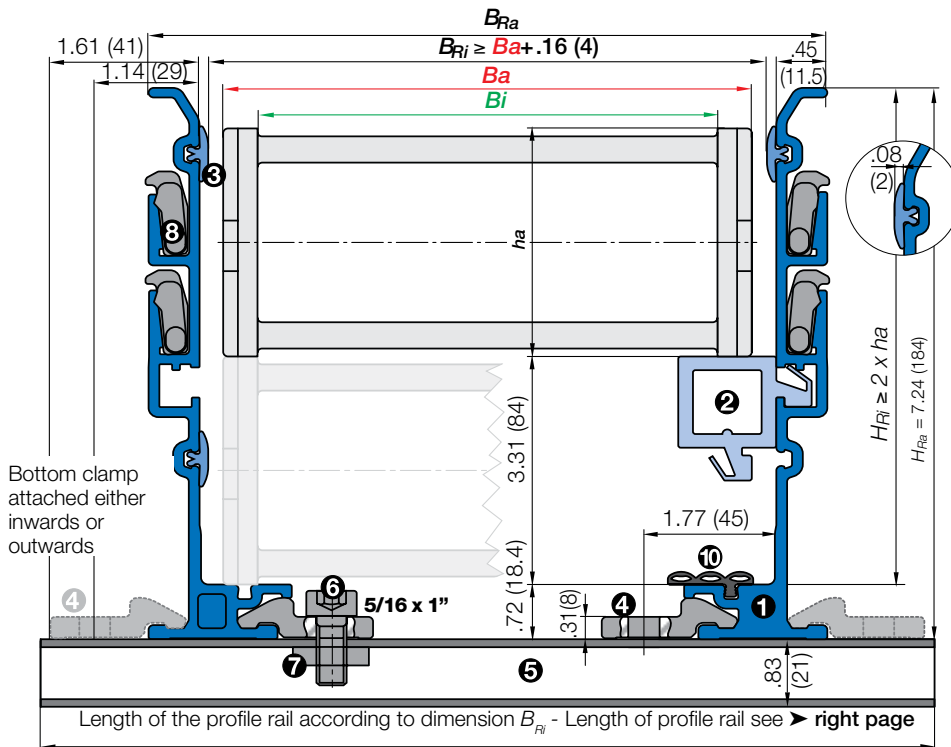

- **Components, trough:**
 - 1 Trough side parts, aluminum, 6.56 ft. (2m)
 - 2 Glide bar, plastic, 6.56 ft. (2m)
 - 3 Glide strips, plastic, 6.56 ft. (2m) (without glide strips on request)
 - 10 Optional: Silencer profile, rubber
- **Components, installation set:**
 - 4 Bottom clamp, aluminum
 - 5 profile rail, steel galvanized
 - 6 Screw 5/16 x 1"
 - 7 Sliding nut 5/16
 - 8 Interface connector, plastic



Basic version: Aluminum SuperTrough components

Complete guide trough sets - description	Part No.	Weight
Set of 2 trough side parts, incl. glide strips, without glide bars, 6.56 ft. (2m) section	974-30-SL	≈ 22.05 lbs
Set of 2 trough side parts, incl. glide strips, with glide bars, 6.56 ft. (2m) section	974-31-SL	≈ 28.22 lbs
1 Installation set "Basic" without profile rail	960-50	≈ .18 lbs
1 Installation set "Basic" with profile rail	960-50-_____	
Single parts - description		
1 Glide strip, individual, 6.56 ft. (2m) section	75-01	≈ .13 lbs
1 Bottom clamp, individual	75.50	≈ .09 lbs
1 Interface connector, individual	75-60	
1 Screw 5/16 x 1", individual	82-55	
1 Sliding nut 5/16, individual	82-56	
2 Glide bars, 6.56 ft. (2m) section	83-79	≈
1 profile rail, individual	92-52_____	≈ .60 lbs/ft.
Silencer profile	75-68H	

Supplement Part No. with the indicated profile rail-length-index.

Example: 960-30-150 profile rail-length-index for your chosen trough inner width B_{Ri}

\blacktriangleright See table on the right or the respective page for chosen series

Number of installation sets which have to be installed



Internet: igus.com
email: sales@igus.com
QuickSpec: igus.com/quickspec

E4-56/H4-56/R4-56			14240/14340			14040/14140/R18840			E4-64L						
E-Chain® Width Index	B_{R_1} in. (mm)	Part No. attached inwards	Part No. attached outwards	E-Chain® Width Index	B_{R_1} in. (mm)	Part No. attached inwards	Part No. attached outwards	E-Chain® Width Index	B_{R_1} in. (mm)	Part No. attached inwards	Part No. attached outwards	E-Chain® Width Index	B_{R_1} in. (mm)	Part No. attached inwards	Part No. attached outwards
-05	3.46 (88)	*	960-50-225	-05	3.15 (80)	*	960-50-200	-05	3.15 (80)	*	960-50-200	-087	4.61 (117)	960-50-175	960-50-225
-06	4.06 (103)	*	960-50-225	-06	3.86 (98)	*	960-50-225	-06	3.74 (95)	*	960-50-225	-100	5.12 (130)	960-50-225	960-50-275
-07	4.45 (113)	*	960-50-250	-07	4.13 (105)	*	960-50-225	-07	4.13 (105)	*	960-50-225	-150	7.09 (180)	960-50-275	960-50-325
-10	5.43 (138)	960-50-200	960-50-275	-087	4.65 (118)	960-50-175	960-50-250	-10	5.12 (130)	960-50-200	960-50-250	-200	9.05 (230)	960-50-250	960-50-300
-11	5.94 (151)	960-50-200	960-50-275	-10	5.12 (130)	960-50-200	960-50-250	-11	5.63 (143)	960-50-200	960-50-275				
-12	6.42 (163)	960-50-225	960-50-300	-11	5.43 (138)	960-50-200	960-50-275	-12	6.10 (155)	960-50-225	960-50-275				
-13	6.93 (176)	960-50-225	960-50-300	-112	5.63 (143)	960-50-200	960-50-275	-13	6.61 (168)	960-50-225	960-50-300				
-15	7.40 (188)	960-50-250	960-50-325	-12	6.10 (155)	960-50-225	960-50-275	-15	7.09 (180)	960-50-250	960-50-300				
-16	7.91 (201)	960-50-250	960-50-325	-137	6.61 (168)	960-50-225	960-50-300	-16	7.60 (193)	960-50-250	960-50-325				
-17	8.39 (213)	960-50-275	960-50-350	-15	7.08 (180)	960-50-250	960-50-300	-17	8.07 (205)	960-50-275	960-50-325				
-18	8.90 (226)	960-50-275	960-50-350	-162	7.60 (193)	960-50-250	960-50-325	-18	8.58 (218)	960-50-275	960-50-350				
-20	9.37 (238)	960-50-300	960-50-375	-17	7.79 (198)	960-50-250	960-50-325	-20	9.39 (230)	960-50-300	960-50-350				
-21	9.88 (251)	960-50-300	960-50-375	-18	8.07 (205)	960-50-275	960-50-325	-21	9.57 (243)	960-50-300	960-50-375				
-22	10.35 (263)	960-50-325	960-50-400	-187	8.58 (218)	960-50-275	960-50-350	-22	10.04 (255)	960-50-325	960-50-375				
-23	10.87 (276)	960-50-325	960-50-400	-20	9.05 (230)	960-50-300	960-50-350	-23	10.55 (268)	960-50-325	960-50-400				
-25	11.34 (288)	960-50-350	960-50-425	-212	9.57 (243)	960-50-300	960-50-375	-25	11.02 (280)	960-50-350	960-50-400				
-26	11.85 (301)	960-50-350	960-50-425	-23	10.04 (255)	960-50-325	960-50-375	-26	11.53 (293)	960-50-350	960-50-425				
-27	12.32 (313)	960-50-375	960-50-450	-237	10.55 (268)	960-50-325	960-50-400	-27	12.01 (305)	960-50-375	960-50-425				
-28	12.83 (326)	960-50-375	960-50-450	-25	11.02 (280)	960-50-350	960-50-400	-28	12.52 (318)	960-50-375	960-50-450				
-30	13.31 (338)	960-50-400	960-50-475	-262	11.54 (293)	960-50-350	960-50-425	-30	12.99 (330)	960-50-400	960-50-450				
-31	13.82 (351)	960-50-400	960-50-475	-28	12.01 (305)	960-50-375	960-50-425	-31	13.50 (343)	960-50-400	960-50-475				
-32	14.29 (363)	960-50-425	960-50-500	-29	12.52 (318)	960-50-375	960-50-450	-32	13.98 (355)	960-50-425	960-50-475				
-33	14.80 (376)	960-50-425	960-50-500	-30	12.99 (330)	960-50-400	960-50-450	-33	14.49 (368)	960-50-425	960-50-500				
-35	15.28 (388)	960-50-450	960-50-525	-312	13.50 (343)	960-50-400	960-50-475	-35	14.96 (380)	960-50-450	960-50-500				
-36	15.79 (401)	960-50-450	960-50-525	-325	13.98 (355)	960-50-425	960-50-475	-36	15.47 (393)	960-50-450	960-50-525				
-37	16.26 (413)	960-50-475	960-50-550	-337	14.49 (368)	960-50-425	960-50-500	-37	15.94 (405)	960-50-475	960-50-525				
-38	16.77 (426)	960-50-475	960-50-550	-350	14.96 (380)	960-50-450	960-50-500	-38	16.46 (418)	960-50-475	960-50-550				
-40	17.24 (438)	960-50-500	960-50-575	-362	15.47 (393)	960-50-450	960-50-525	-40	16.93 (430)	960-50-500	960-50-550				
-41	17.76 (451)	960-50-500	960-50-575	-375	15.94 (405)	960-50-475	960-50-525	-41	17.44 (443)	960-50-500	960-50-575				
-42	18.23 (463)	960-50-525	960-50-600	-387	16.46 (418)	960-50-475	960-50-550	-42	17.91 (455)	960-50-525	960-50-575				
-43	18.74 (476)	960-50-525	960-50-600	-400	16.93 (430)	960-50-500	960-50-550	-43	18.43 (468)	960-50-525	960-50-600				
-45	19.21 (488)	960-50-550	960-50-625					-45	18.90 (480)	960-50-550	960-50-600				
-46	19.72 (501)	960-50-550	960-50-625					-46	19.41 (493)	960-50-550	960-50-625				
-47	20.20 (513)	960-50-575	960-50-650					-47	19.88 (505)	960-50-575	960-50-625				
-48	20.71 (526)	960-50-575	960-50-650					-48	20.39 (518)	960-50-575	960-50-650				
-50	21.18 (538)	960-50-600	960-50-675					-50	20.87 (530)	960-50-600	960-50-650				
-51	21.69 (551)	960-50-600	960-50-675					-51	21.38 (543)	960-50-600	960-50-675				
-52	22.17 (563)	960-50-625	960-50-700					-52	21.85 (555)	960-50-625	960-50-675				
-53	22.68 (576)	960-50-625	960-50-700					-53	22.36 (568)	960-50-625	960-50-700				
-55	23.15 (588)	960-50-650	960-50-725					-55	22.83 (580)	960-50-650	960-50-700				
-60	25.12 (638)	960-50-700	960-50-775					-60	24.80 (630)	960-50-700	960-50-750				

PDF: igus.com/e-chain-pdfs
Product information: igus.com/e-chains

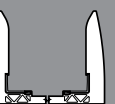
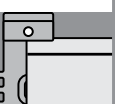
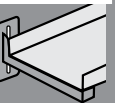

Heavy Duty Version - Installation Set Part No. 974-50

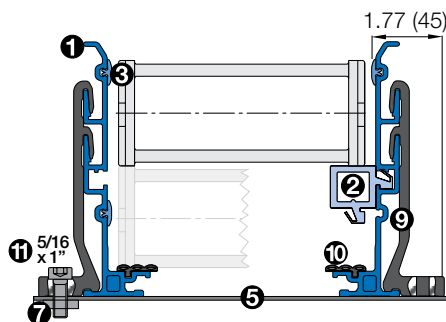

- **Components, trough "Heavy Duty":**
- ① Trough side parts, aluminum, 6.56 ft. (2m)
- ② Glide bar, plastic, 6.56 ft. (2m)
- ③ Glide strips, plastic 6.56 ft. (2m)
(without glide strips on request)
- ⑩ Optional: Silencer profile, rubber
- **Components, installation set "Heavy Duty":**
- ⑤ profile rail, steel galvanized
- ⑦ Sliding nut 5/16
- ⑨ Heavy duty bracket, aluminum
- ⑪ Screw 5/16 x 1"

Note: Dimensions similar to Basic version!
Exception: Heavy duty bracket, see drawing



- = Guide trough
- = Glide bar
- = Installation set "Heavy duty"
- = profile rail

For the "Heavy Duty" installation set:
Insert Part No. 974-50-____ instead of 960-50-____
on the right column "attached outwards"

Part No. 975-30-SL and 975-31-SL Trough Height: 9.29 in. (236 mm)
Aluminum SuperTrough — Basic Version

For the following Series

System E4-1 Series

- E4-80/H4-80/R4-80

System E4 Light Series:

- 15050/15150/R19850

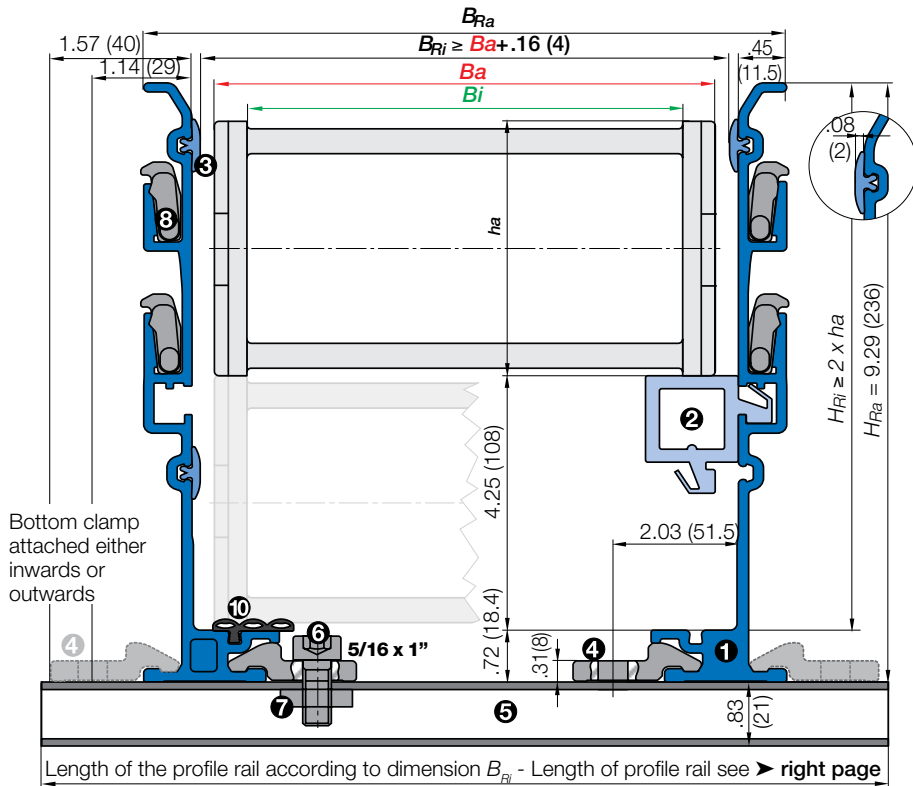

- B_a = Outer e-chain® width
 - B_i = Inner e-chain® width
 - h_a = e-chain® outer height
 - H_{Ri} = Inner trough height
 - H_{Ra} = Outer trough height
 - B_{Ri} = Inner trough width \blacktriangleright depends on dim. B_a
 - B_{Ra} = Outer trough width
 - n_{Mon} = # of installation sets (left/right)
 - n_{Ri} = # of trough set (left/right)
- !** $H_{Ri} \geq 2 \cdot h_a$
 $B_{Ri} \geq B_a + 4$
- = Guide trough
 - = Glide bar
 - = Installation set "Basic"
 - = profile rail

- **Components, trough:**
 - 1 Trough side parts, aluminum, 6.56 ft. (2m)
 - 2 Glide bar, plastic, 6.56 ft. (2m)
 - 3 Glide strips, plastic, 6.56 ft. (2m) (without glide strips on request)
 - 10 Optional: Silencer profile, rubber
- **Components, installation set:**
 - 4 Bottom clamp, aluminum
 - 5 profile rail, steel galvanized
 - 6 Screw 5/16 x 1"
 - 7 Sliding nut 5/16
 - 8 Interface connector, plastic



Basic version: Aluminum SuperTrough components

Complete guide trough sets - description

Description	Part No.	Weight
Set of 2 trough side parts, incl. glide strips, without glide bars, 6.56 ft. (2m) section	975-30-SL	≈ 30.87 lbs
Set of 2 trough side parts, incl. glide strips, with glide bars, 6.56 ft. (2m) section	975-31-SL	≈ 36.60 lbs
1 Installation set "Basic" without profile rail	960-50	≈ .18 lbs
1 Installation set "Basic" with profile rail	960-50-___	

Single parts - description

1 Glide strip, individual, 6.56 ft. (2m) section	75-01	≈ .13 lbs
1 Bottom clamp, individual	75.50	≈ .09 lbs
1 Interface connector, individual	75-60	
1 Screw 5/16 x 1" individual	82-55	
1 Sliding nut 5/16, individual	82-56	
2 Glide bars, 6.56 ft. (2m) section	83-79	≈
1 profile rail, individual	92-52-___	≈ .60 lbs/ft.
Silencer profile	75-68H	

Supplement Part No. with the indicated profile rail-length-index.

Example: 960-30-150 profile rail-length-index for your chosen trough inner width B_{Ri}

\blacktriangleright See table on the right or the respective page for chosen series

Number of installation sets which have to be installed

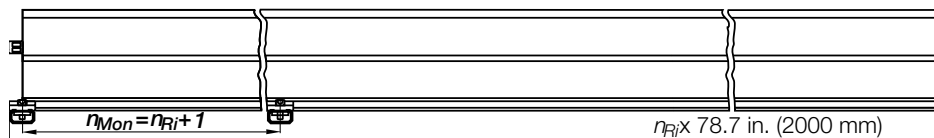

Telephone 1-800-521-2747

Internet: igus.com
email: sales@igus.com
QuickSpec: igus.com/quickspec

E4-80/H4-80/R4-80

e-chain® Width Index	Part No. B_{R1} in. (mm)	Part No. attached inwards	attached outwards
-05	4.09 (104)	*	960-50-225
-06	4.68 (119)	*	960-50-250
-07	5.08 (129)	*	960-50-250
-10	6.06 (154)	960-50-225	960-50-275
-11	6.57 (167)	960-50-225	960-50-300
-12	7.05 (179)	960-50-250	960-50-300
-13	7.56 (192)	960-50-250	960-50-325
-15	8.03 (204)	960-50-275	960-50-325
-16	8.54 (217)	960-50-275	960-50-350
-17	9.02 (229)	960-50-300	960-50-350
-18	9.53 (242)	960-50-300	960-50-375
-20	10.00 (254)	960-50-325	960-50-375
-21	10.51 (267)	960-50-325	960-50-400
-22	10.98 (279)	960-50-350	960-50-400
-23	11.50 (292)	960-50-350	960-50-425
-25	11.97 (304)	960-50-375	960-50-425
-26	12.48 (317)	960-50-375	960-50-450
-27	12.95 (329)	960-50-400	960-50-450
-28	13.46 (342)	960-50-400	960-50-475
-30	13.94 (354)	960-50-425	960-50-475
-31	14.45 (367)	960-50-425	960-50-500
-32	14.92 (379)	960-50-450	960-50-500
-33	15.43 (392)	960-50-450	960-50-525
-35	15.91 (404)	960-50-475	960-50-525
-36	16.42 (417)	960-50-475	960-50-550
-37	16.89 (429)	960-50-500	960-50-550
-38	17.40 (442)	960-50-500	960-50-575
-40	17.87 (454)	960-50-525	960-50-575
-41	18.39 (467)	960-50-525	960-50-600
-42	18.86 (479)	960-50-550	960-50-600
-43	19.37 (492)	960-50-550	960-50-625
-45	19.84 (504)	960-50-575	960-50-625
-46	20.35 (517)	960-50-575	960-50-650
-47	20.83 (529)	960-50-600	960-50-650
-48	21.34 (542)	960-50-600	960-50-675
-50	21.81 (554)	960-50-625	960-50-675
-51	22.32 (567)	960-50-625	960-50-700
-52	22.80 (579)	960-50-650	960-50-700
-53	23.31 (592)	960-50-650	960-50-725
-55	24.17 (604)	960-50-675	960-50-725
-60	25.75 (654)	960-50-725	960-50-775

15050/15150/R19850

e-chain® Width Index	Part No. B_{R1} in. (mm)	Part No. attached inwards	attached outwards
-05	3.31 (84)	*	960-50-200
-07	4.29 (109)	*	960-50-225
-10	5.28 (134)	*	960-50-250
-11	5.75 (146)	960-50-200	960-50-275
-12	6.26 (159)	960-50-225	960-50-275
-13	6.73 (171)	960-50-225	960-50-300
-15	7.24 (184)	960-50-250	960-50-300
-16	7.72 (196)	960-50-250	960-50-325
-17	8.23 (209)	960-50-275	960-50-325
-18	8.70 (221)	960-50-275	960-50-350
-20	9.21 (234)	960-50-300	960-50-350
-21	9.69 (246)	960-50-300	960-50-375
-22	10.20 (259)	960-50-325	960-50-375
-23	10.67 (271)	960-50-325	960-50-400
-25	11.18 (284)	960-50-350	960-50-400
-26	11.65 (296)	960-50-350	960-50-425
-27	12.16 (309)	960-50-375	960-50-425
-28	12.64 (321)	960-50-375	960-50-450
-30	13.15 (334)	960-50-400	960-50-450
-31	13.62 (346)	960-50-400	960-50-475
-32	14.13 (359)	960-50-425	960-50-475
-33	14.61 (371)	960-50-425	960-50-500
-35	15.12 (384)	960-50-450	960-50-500
-36	15.59 (396)	960-50-450	960-50-525
-37	16.10 (409)	960-50-475	960-50-525
-38	16.57 (421)	960-50-475	960-50-550
-40	17.07 (434)	960-50-500	960-50-550
-41	17.56 (446)	960-50-500	960-50-575
-42	18.07 (459)	960-50-525	960-50-575
-43	18.54 (471)	960-50-525	960-50-600
-45	19.06 (484)	960-50-550	960-50-600
-46	19.53 (496)	960-50-550	960-50-625
-47	20.04 (509)	960-50-575	960-50-625
-48	20.51 (521)	960-50-575	960-50-650
-50	21.02 (534)	960-50-600	960-50-650
-51	21.50 (546)	960-50-600	960-50-675
-52	22.01 (559)	960-50-625	960-50-675
-53	22.48 (571)	960-50-625	960-50-700
-55	22.99 (584)	960-50-650	960-50-700
-60	24.96 (634)	960-50-700	960-50-750

15250/15350

e-chain® Width Index	Part No. B_{R1} in. (mm)	Part No. attached inwards	attached outwards
-05	3.31 (84)	*	960-50-200
-06	4.02 (102)	*	960-50-225
-07	4.29 (109)	*	960-50-225
-087	4.76 (121)	*	960-50-250
-09	5.16 (131)	*	960-50-250
-10	5.28 (134)	*	960-50-250
-11	5.59 (142)	960-50-200	960-50-250
-112	5.79 (147)	960-50-200	960-50-275
-12	6.26 (159)	960-50-225	960-50-275
-137	6.73 (171)	960-50-225	960-50-300
-15	7.24 (184)	960-50-250	960-50-300
-162	7.76 (197)	960-50-250	960-50-325
-17	7.95 (202)	960-50-250	960-50-325
-18	8.23 (209)	960-50-275	960-50-325
-187	8.74 (222)	960-50-275	960-50-350
-20	9.21 (234)	960-50-300	960-50-350
-212	9.72 (247)	960-50-300	960-50-375
-23	10.20 (259)	960-50-325	960-50-375
-237	10.71 (272)	960-50-325	960-50-400
-25	11.18 (284)	960-50-350	960-50-400
-262	11.69 (297)	960-50-350	960-50-425
-28	12.16 (309)	960-50-375	960-50-425
-29	12.68 (322)	960-50-375	960-50-450
-30	13.15 (334)	960-50-400	960-50-450
-312	13.66 (347)	960-50-400	960-50-475
-325	14.13 (359)	960-50-425	960-50-475
-337	14.65 (372)	960-50-425	960-50-500
-350	15.12 (384)	960-50-450	960-50-500
-362	15.63 (397)	960-50-450	960-50-525
-375	16.10 (409)	960-50-475	960-50-525
-387	16.61 (422)	960-50-475	960-50-550
-400	17.09 (434)	960-50-500	960-50-550

Heavy Duty Version - Installation Set Part No. 975-50

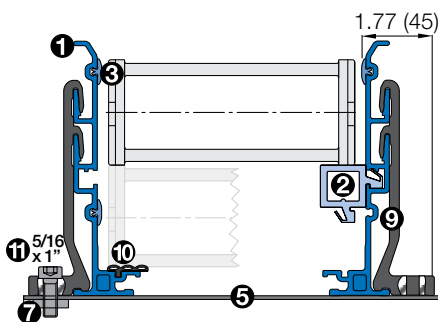

For the "Heavy Duty" installation set:
Insert Part No. **975-50-___** instead of **960-50-___**
on the right column "attached outwards"

● Components, trough "Heavy Duty":

- ❶ Trough side parts, aluminum, 6.56 ft. (2m)
- ❷ Glide bar, plastic, 6.56 ft. (2m)
- ❸ Glide strips, plastic 6.56 ft. (2m)
(without glide strips on request)
- ❿ Optional: Silencer profile, rubber

● Components, installation set "Heavy Duty":

- ❺ profile rail, steel galvanized
- ❽ Sliding nut 5/16
- ❾ Heavy duty bracket, aluminum
- ❾ Screw 5/16 x 1"

Note: Dimensions similar to Basic version!
Exception: Heavy duty bracket, see drawing



- = Guide trough
- = Glide bar
- = Installation set
"Heavy duty"
- = profile rail

PDF: igus.com/e-chain-pdfs
Product information: igus.com/e-chains

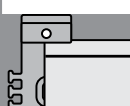
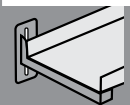





Steel guide trough

**Very tough for
heavy-duty applications**



Advantages of the steel guide trough

- Very tough guide trough for applications in tough environments
- Easy assembly due to installation set design
- Easy mounting directly to the profile rail
- Large range, 2-piece design, adjustable to e-chain[®] width
- Available in galvanised steel and stainless steel
- Low friction: Glide bar made of PE
- Fixed end module option, for fast and easy fitting without any drilling
- Conductivity according to DIN EN 61537 - as standard



When to use another guide trough:

- When a corrosion-resistant, seawater-resistant aluminium trough is required,
▶ **Aluminium SuperTroughs**

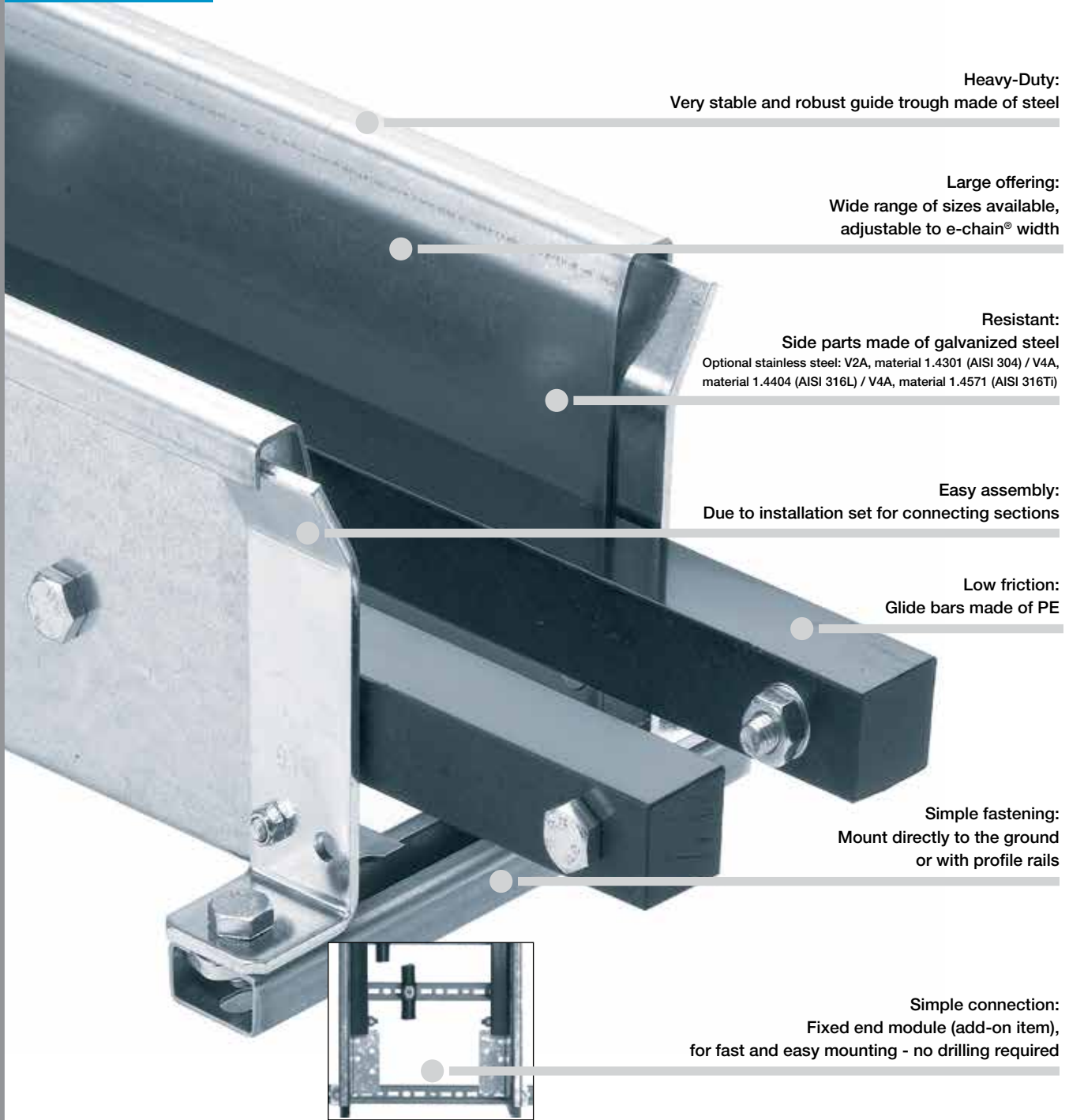

Heavy-Duty:
Very stable and robust guide trough made of steel

Large offering:
Wide range of sizes available,
adjustable to e-chain® width

Resistant:
Side parts made of galvanized steel
Optional stainless steel: V2A, material 1.4301 (AISI 304) / V4A,
material 1.4404 (AISI 316L) / V4A, material 1.4571 (AISI 316Ti)

Easy assembly:
Due to installation set for connecting sections

Low friction:
Glide bars made of PE

Simple fastening:
Mount directly to the ground
or with profile rails

Simple connection:
Fixed end module (add-on item),
for fast and easy mounting - no drilling required

Very stable and rugged for Heavy-Duty applications - Steel guide trough

If the igus® installation sets are used, the guide troughs are particularly easy to assemble. All steel guide troughs are constructed according to the same basic principle. On the following pages, you will find information about dimensions, weights and accessories according to the trough size. All sizes use a common profile rail on which the guide parts are assembled. The assembly brackets used vary in height only.

Installation Guide-PDF with detailed assembly information ► www.igus.com/installation-guide-pdf

Guide Trough Systems

Steel Guide Trough

Overview - Sizes



Steel guide troughs

Very stable and rugged for Heavy-Duty applications

Standard in Galvanized Steel

Optional in stainless steel:

V2A, material 1.4301 (AISI 304)

V4A, material 1.4404 (AISI 316L)

V4A, material 1.4571 (AISI 316Ti)

Trough Part No.	For e-chain® Series		Outer trough height H_{Ra} in. (mm)	Installation set* Part No.
	E2 Series	E4 Series		
92-30	2400/2500		2.76 (70)	92.50
	255			
95-30	2600/2700		3.94 (100)	95.50
	R58			
96-30		E4-28/R4-28	3.94 (100)	95.50
98-30		E4-32/H4-32/R4-32	5.12 (130)	93.50
93-30	3400/3500	E4-42/H4-42/R4-42	5.12 (130)	93.50
94-30		E4-56/H4-56/R4-56	6.69 (170)	94-50
		14040/14140/R18840		
		14240/14340		
94-14550-30		14550/14650/R19050	6.69 (170)	94-50
99-30		15050/15150/R19850	8.66 (220)	96-50
		15250/15350		
97-30		E4-112/H4-112/R4-112	11.81 (300)	98.50
		600/601/R608		
		1640/R1608		
90-30		800, 840	18.90 (480)	90.50

One-Piece Steel Trough - Only for series 10, 15 and B15 - Galvanized Steel only

91-10 - 91-71 ²⁾	1.89 (48)	-
-----------------------------	-----------	---

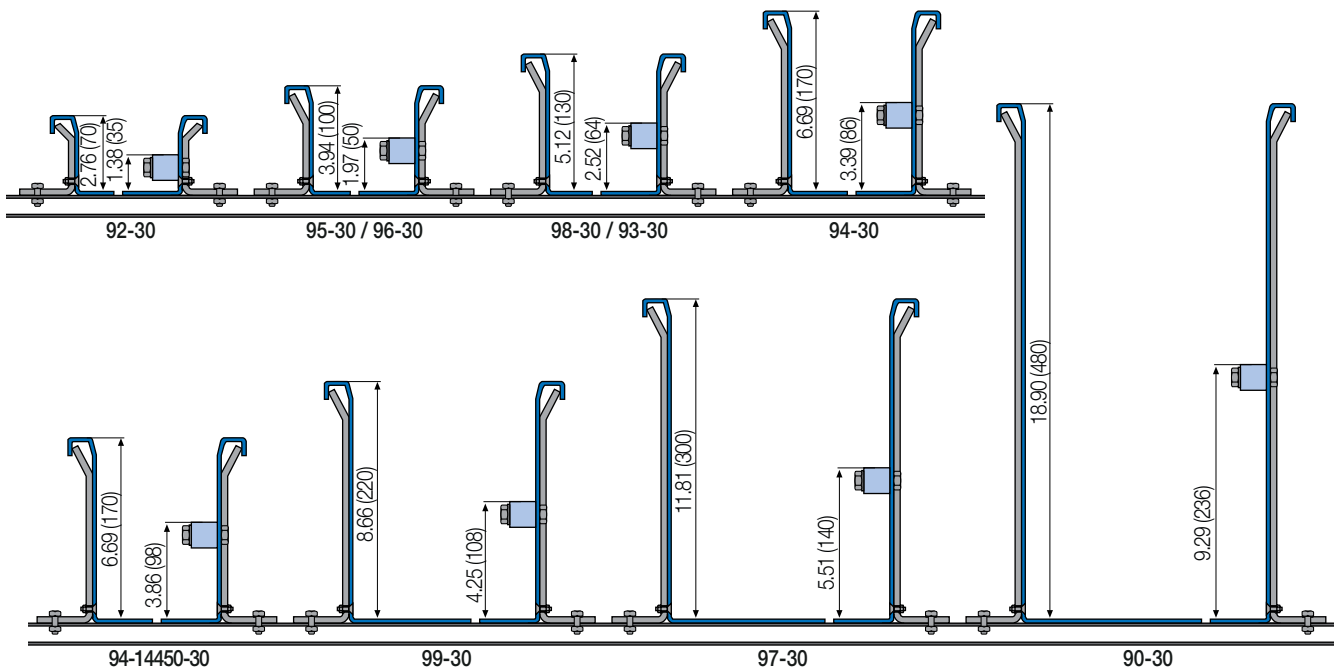

PDF: igus.com/e-chain-pdfs
 Product information: igus.com/e-chains

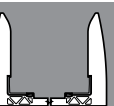
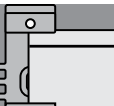
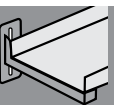

Components

- = Guide trough¹⁾
- = Glide bar
- = Installation set
- = Profile rail²⁾

- Ba** = Outer e-chain® width
- Bi** = Inner e-chain® width
- ha** = e-chain® outer height
- H_{Ri}** = Inner trough height
- H_{Ra}** = Outer trough height
- B_{Ri}** = Inner trough width
- B_{Ra}** = Outer trough width
- n_{Mon}** = Number of installation sets (left/right)
- n_{Ri}** = Number of trough sets (left/right)

H_{Ri} ≥ 2 x ha

B_{Ri} = Ba + 5

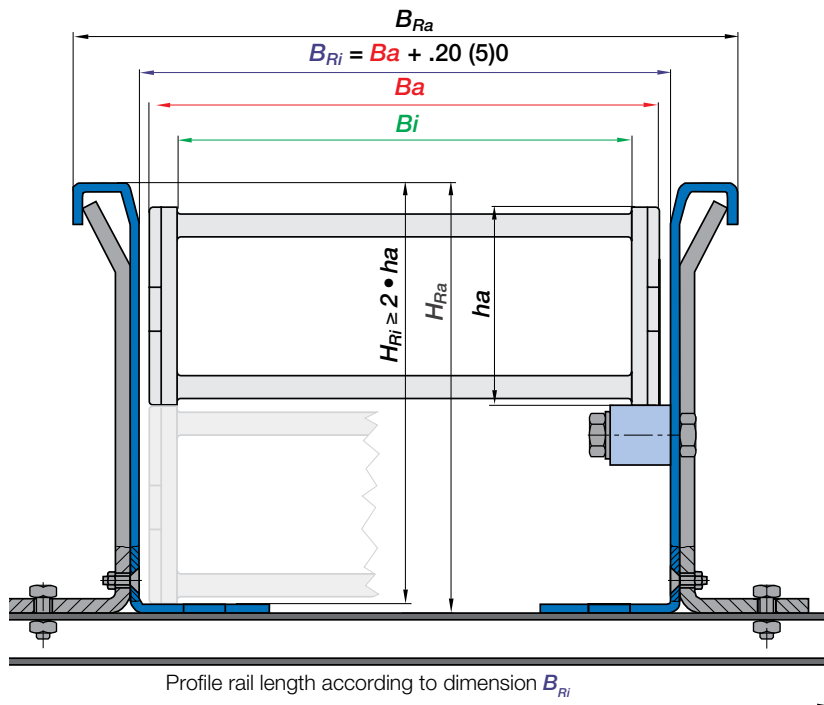

1) Guide trough side parts, galvanized steel. Optional stainless steel: V2A, material 1.4301 (AISI 304) / V4A, material 1.4404 (AISI 316L) / V4A, material 1.4571 (AISI 316Ti)
 2) Profile rail also available in stainless steel V2A, material 1.4301 (AISI 304)

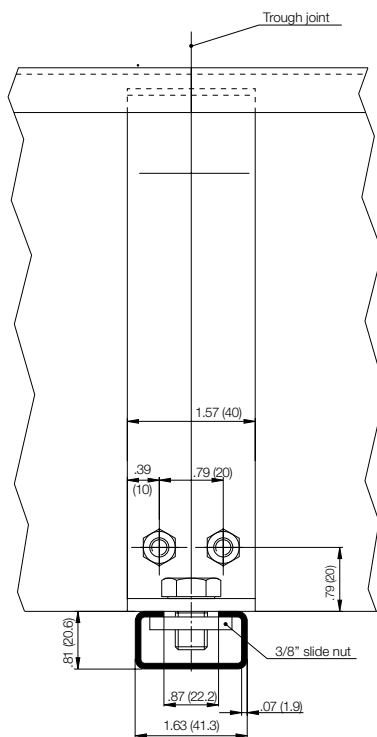

Side view of trough joint. All the dimensions, apart from the height, apply to all sizes.

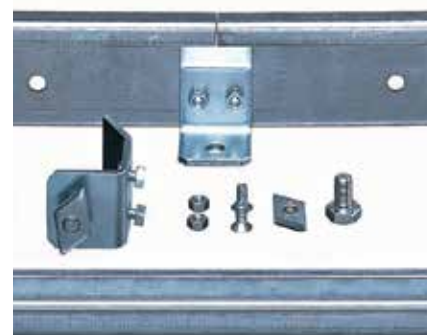

Installation set for joint and attachment surface connections, secure connection without misalignment and without welding.

Steel Guide Trough - Configured according to your requirements

Quick and easy assemble the right trough for your application

- Selection of the suitable guide trough according to the e-chain® Series and e-chain® width *Bi*
- Determine the feeding point of the cables
- Determine travel distance and thus the length of the required guide trough and the number of trough pieces. Standard length of a trough side plate: 78.7" (2000 mm). The length of the guide trough - for axial feeding - is calculated from half the travel length with and half the travel length without the glide bar
- Number and selection of the assembly kit

The quantity of the assembly kit is calculated from the number of the trough pieces + 1 kit:

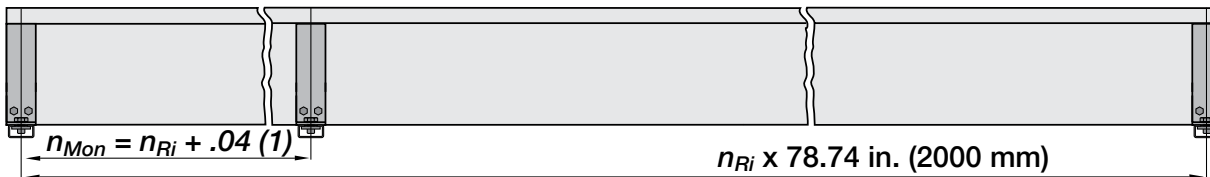

- The assembly kit matches the igus® profile rail option
- If you have opted for an e-chain® with KMA mounting brackets, we offer you a fixed-end module for the quick and simple fastening of the e-chain® in the trough without holes

Installation Guide-PDF with detailed assembly information
 ► www.igus.com/installation-guide-pdf

Order example Based on Part No. 94-30



Order example: Length of travel 98.4 ft. (30 m) -
 Center mounted for Series E4-56-20-300-0 with $B_{Ri} = 239$

Guide trough set (set of 2 trough side parts, incl. glide strips) without glide bar	Part No. 94-30
Order text: 52.5 ft. (16 m) guide trough without glide bar (8 x 6.56 ft. (2 m) sections)	
Guide trough set (set of 2 trough side parts, incl. glide strips) with glide bar	Part No. 94-31
Order text: 52.5 ft. (16 m) guide trough with glide bar (8 x 6.56 ft. (2 m) sections)	
Installation set "Basic" complete (guide trough-sets + 1)	Part No. 94-50-350
Order text: 17 installation sets "Basic"	
Module for the fixed end	Part No. 94-80-01
Order text: 1 set	



Calculation - travel center mounted: Half travel length, rounded down to full 2 m sections = X m guide trough length without glide bars + X m guide trough length with glide bars + installation sets Basic (number of trough pieces + 1)

PDF: igus.com/e-chain-pdfs
 Product information: igus.com/e-chains

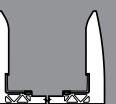
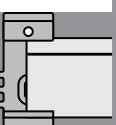
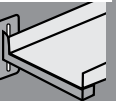

Fixed end module - Quick and simple fastening onto the steel guide trough

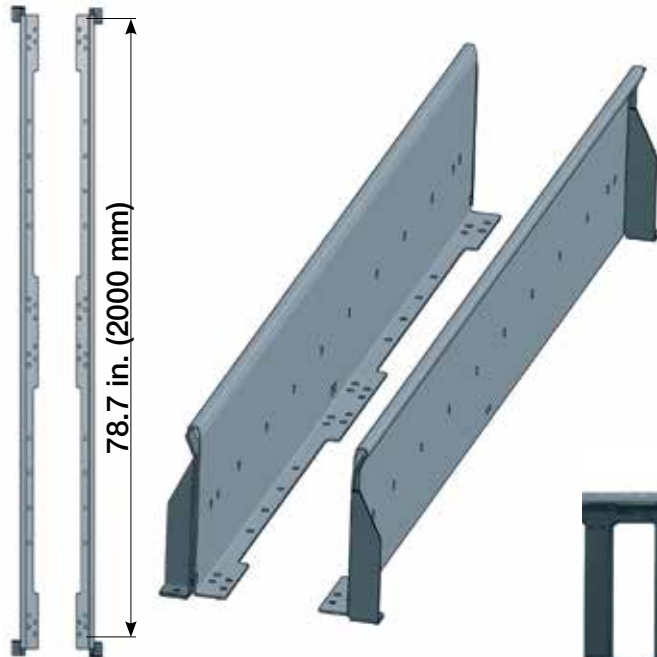

Until now, the steel trough had to be modified on site to fit the mounting brackets at the stationary end of the e-chain®. That is now history. With its prefabricated boreholes, the 78.7" (2,000 mm) long kit can be used for middle-feed, end-feed and opposed installation.

- ❶ Fast fixation of mounting brackets thanks to prefabricated boreholes
- ❷ Fast installation of profile rail for strain relief
- ❸ Fast bolting of glide bars

Industries: Power plants, coal conveyors, mining, composting plants, raw material storage, gypsum plants, etc.

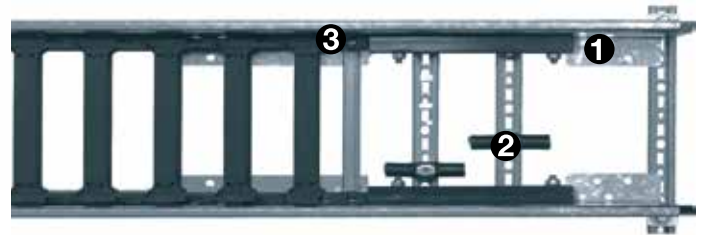

Part No.	For Steel Guide Troughs	For e-chain® Series
90-80-01*	90-30 90-31	800, 840
92-80-01*	92-30 92-31	2500, 255
93-80-01	93-30 93-31	3500, R68, E4-42/H4-42/R4-42, E4-48L/R4-48L
94-80-01	94-30 94-31	E4-56/H4-56/R4-56, 14040/14140 /R18840, 14240/14340
95-80-01*	95-30 95-31	2700
96-80-01	96-30 96-31	E4-80/H4-80/R4-80, 15050/5150/R19850
97-80-01	97-30 97-31	E4-32/H4-32/R4-32, E4-38L/R4-38L
98-80-01	98-30 98-31	E4-112/H4-112/R4-112, 1640/R1608
99-80-01	99-30 99-31	E4-28/R4-28
94-14550-80-01*	94-14550-30 94-14550-31	14550/14650/R19050

*Available upon request, please consult igus® for delivery time!



Fixed end module - length 78.7 in. (2000 mm)

Guide Trough Systems

Steel Guide Troughs - One-Piece - U-Shaped

Special solutions for Series 10, 15 and B15



One-piece guide troughs made of steel are available for the following Energy Chains®: Series 10, 15 and B15. These guide troughs are available from stock for outer chain widths up to 2.36 in. (60 mm). For wider e-chains® and Tubes, special solutions are possible with short lead times.

No installation sets are required for these trough sizes since the guide troughs consist of a one-piece U-profile. The joint connection with this type of guide trough is specified individually for every application.

For the following Series

System E2 Series:

● 10

● B15

System Zipper Series:

● 15

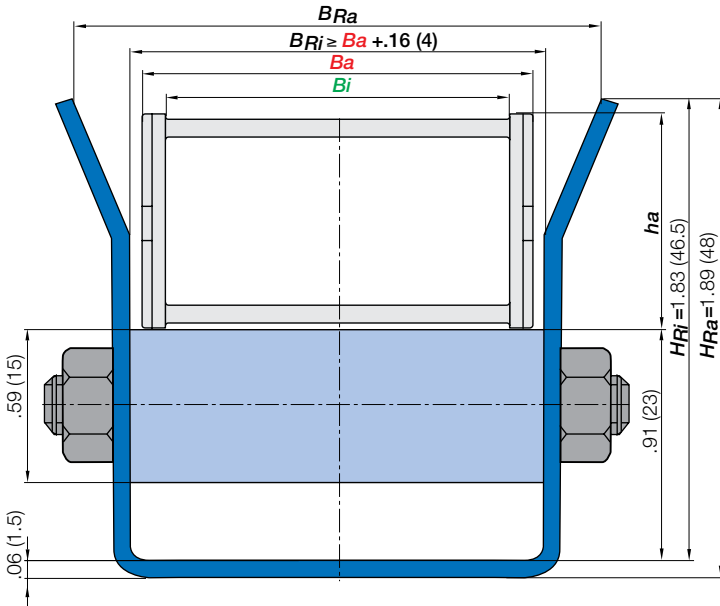

- B_a = Outer e-chain® width
- B_i = Inner e-chain® width
- h_a = e-chain® outer height
- H_{Ri} = Inner trough height
- H_{Ra} = Outer trough height
- B_{Ri} = Inner trough width
- B_{Ra} = Outer trough width



Dimensions Guide troughs 91-10 – 91-71

For Series	Part No.	B_{Ra} in. (mm)	B_{Ri} in. (mm)	Weight lbs/ft (kg/m)
10-015/15-015/B15-015				
Trough without glide bar 6.56 ft. (2m section)	91-10	1.59 (40.5)	1.18 (30)	1.01 (1.50)
Glide bar 6.56 ft. (2m section)	91-11	1.59 (40.5)	1.18 (30)	.30 (.45)
10-025/15-025/B15-025				
Trough without glide bar 6.56 ft. (2m section)	91-20	1.99 (50.5)	1.57 (40)	1.11 (1.65)
Glide bar 6.56 ft. (2m section)	91-21	1.99 (50.5)	1.57 (40)	.38 (.57)
10-038/15-038/B15-038				
Trough without glide bar 6.56 ft. (2m section)	91-30	2.46 (62.5)	2.05 (52)	1.21 (1.80)
Glide bar 6.56 ft. (2m section)	91-31	2.46 (62.5)	2.05 (52)	.46 (.68)
10-050/15-050/B15-050				
Trough without glide bar 6.56 ft. (2m section)	91-40	2.85 (72.5)	2.44 (62)	1.28 (1.90)
Glide bar 6.56 ft. (2m section)	91-41	2.85 (72.5)	2.44 (62)	.61 (.91)
10-5/15-5/B15-5				
Trough without glide bar 6.56 ft. (2m section)	91-50	3.60 (91.5)	3.19 (81)	1.52 (2.26)
Glide bar 6.56 ft. (2m section)	91-51	3.60 (91.5)	3.19 (81)	.84 (1.25)
10-6/15-6/B15-6				
Trough without glide bar 6.56 ft. (2m section)	91-60	4.27 (108.5)	3.86 (98)	1.83 (2.72)
Glide bar 6.56 ft. (2m section)	91-61	4.27 (108.5)	3.86 (98)	.91 (1.35)
10-7/15-7/B15-7				
Trough without glide bar 6.56 ft. (2m section)	91-70	5.06 (128.5)	4.65 (118)	2.13 (3.17)
Glide bar 6.56 ft. (2m section)	91-71	5.06 (128.5)	4.65 (118)	1.14 (1.70)

Trough material in general: St 1203 galvanized

PDF: igus.com/e-chain-pdfs
Product information: igus.com/e-chains

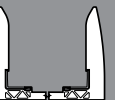
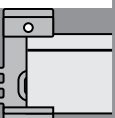
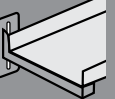

Part No. 92-30 - Trough Height: 2.76 in. (70 mm)

For the following Series

System E2/000 Series:

● 2400/2500

● 255

System E2 Tube Series:

● R48

igus®
e-chain system®

Telephone 1-800-521-2747

- B_a = Outer e-chain® width
- B_i = Inner e-chain® width
- h_a = e-chain® outer height
- H_{Ri} = Inner trough height
- H_{Ra} = Outer trough height
- B_{Ri} = Inner trough width ▶ depends on dim. B_a
- B_{Ra} = Outer trough width
- n_{Mon} = # of installation sets (left/right)
- n_{Ri} = # of trough set (left/right)
- ! $H_{Ri} \geq 2 \cdot h_a$
- $B_{Ri} \geq B_a + 5$
- = Guide trough
- = Glide bar
- = Installation set "Basic"
- = profile rail

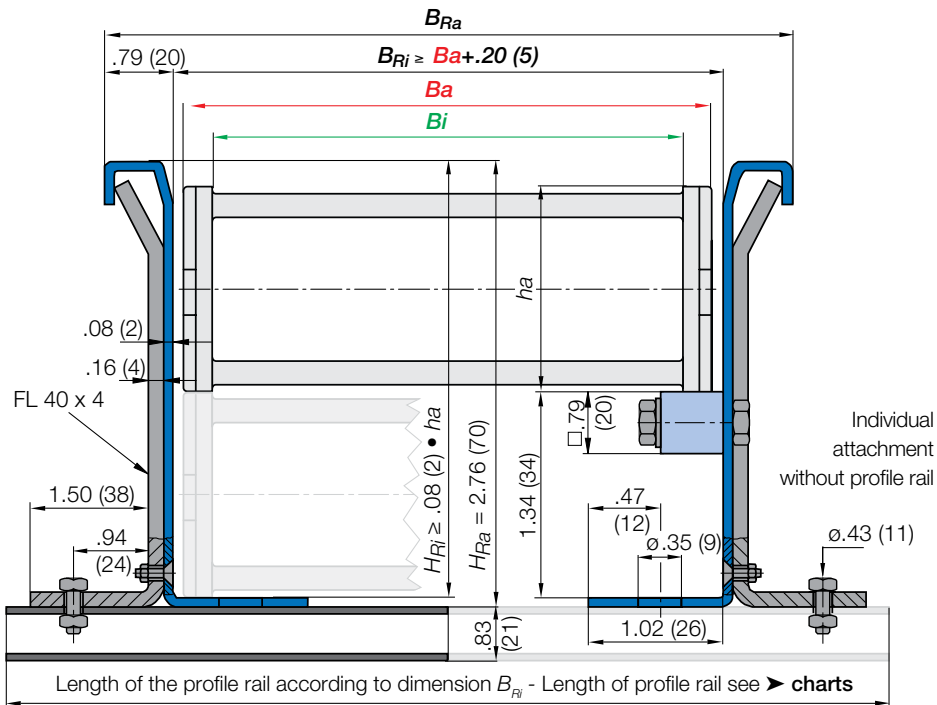

Steel Guide Trough components - Sets and single parts

Complete guide trough sets - description	Part No.	Weight lbs
Set of 2 trough side parts without glide bars, each 6.56 ft. (2m)	92-30	19.85
1 Installation set "Basic" with profile rail	92-50-___	
1 Installation set "Basic" without profile rail	92-50	.84
1 Glide bar set with hardware, each 6.56 ft. (2m) + 22 bolts	92-01	4.52

Single parts - description

1 profile rail, individual	92-52-___	.60 lbs/ft.
1 Clamping brackets, 2 pcs	92-51	.31
4 Flat-head screws M6 x 20	92-53	
4 Lock nuts M6	92-55	
2 3/8 Slide nuts	92-56	
2 Hex-head bolts 3/8 x 3/4	92-57	
Glide bar hardware only, 22 pcs.	92-21	1.21

Supplement Part No. with the indicated profile rail-length-index. **Example: 92-50-175**
profile rail-length-index for your chosen trough inner width B_{Ri} ▶ **opposite page**

Design sketch: Number of installation sets which have to be installed

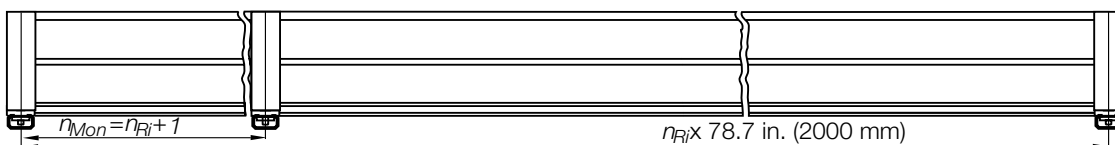

Internet: igus.com
email: sales@igus.com
QuickSpec: igus.com/quickspec

Part No. Installation set: Steel Guide Trough with profile rail (depending on the width)

2400/2500			255		
Width Index	B_{Rl} in. (mm)	Part No. Installation set	Width Index	B_{Rl} in. (mm)	Part No. Installation set
-02	1.81 (46)	*	-03	2.32 (59)	92-50-175
-03	2.32 (59)	92-50-175	-05	3.07 (78)	92-50-200
-05	3.07 (78)	92-50-200	-07	3.86 (98)	92-50-225
-07	3.86 (98)	92-50-225	-10	4.88 (124)	92-50-250
-09	4.33 (110)	92-50-225			
-10	4.88 (124)	92-50-250			
-12	5.75 (146)	92-50-275			



igus® steel guide trough used in a robotics application

PDF: igus.com/e-chain-pdfs
 Product information: igus.com/e-chains

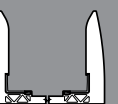
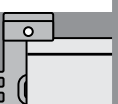
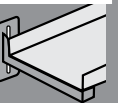

For the following Series

- System E2/000 Series:
 - 2600/2700
- System E2 Tube Series:
 - R58

Part No. **95-30** - Trough Height: 3.94 in. (100 mm)

- B_a = Outer e-chain® width
- B_i = Inner e-chain® width
- h_a = e-chain® outer height
- H_{Ri} = Inner trough height
- H_{Ra} = Outer trough height
- B_{Ri} = Inner trough width ▶ depends on dim. B_a
- B_{Ra} = Outer trough width
- n_{Mon} = # of installation sets (left/right)
- n_{Ri} = # of trough set (left/right)
- ! $H_{Ri} \geq 2 \cdot h_a$
- $B_{Ri} \geq B_a + 5$
- = Guide trough
- = Glide bar
- = Installation set "Basic"
- = profile rail

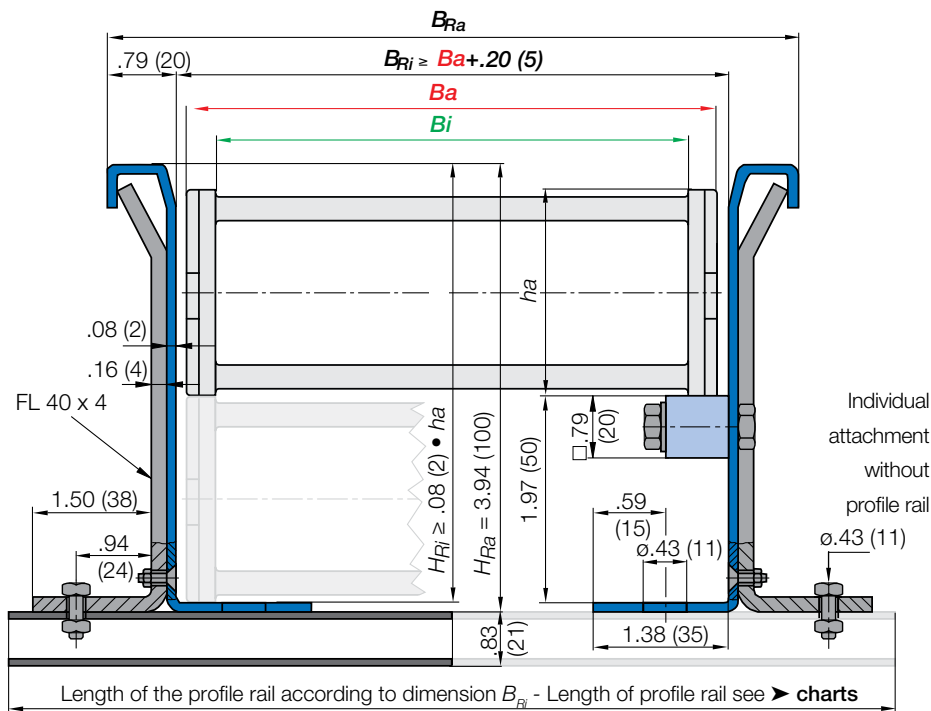

Steel Guide Trough components - Sets and single parts

Complete guide trough sets - description	Part No.	Weight lbs
Set of 2 trough side parts without glide bars, each 6.56 ft. (2m)	95-30	23.81
1 Installation set "Basic" with profile rail	95-50-___	
1 Installation set "Basic" without profile rail	95-50	1.01
1 Glide bar set with hardware, each 6.56 ft. (2m) + 22 bolts	92-01	4.52

Single parts - description

1 profile rail, individual	92-52-___	.60 lbs/ft
1 Clamping brackets, 2 pcs	95-51	.40
4 Flat-head screws M6 x 20	92-53	
4 Lock nuts M6	92-55	
2 3/8 Slide nuts	92-56	
2 Hex-head bolts 3/8 x 3/4	92-57	
Glide bar hardware only, 22 pcs	92-21	1.21

Supplement Part No. with the indicated profile rail-length-index. **Example: 95-50-175**
profile rail-length-index for your chosen trough inner width B_{Ri} ▶ **opposite page**

Design sketch: Number of installation sets which have to be installed

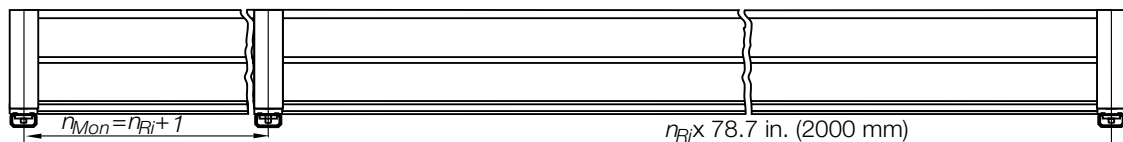

Part No. Installation set: Steel Guide Trough with profile rail (depending on the width)

2600/2700			R58		
Width Index	B_{Ri} in. (mm)	Part No. Installation set	Width Index	B_{Ri} in. (mm)	Part No. Installation set
-05	2.80 (71)	95-50-200	-050	2.80 (71)	95-50-200
-06	3.39 (86)	95-50-200	-075	3.78 (96)	95-50-225
-07	3.78 (96)	95-50-225	-100	4.76 (121)	95-50-250
-09	4.37 (111)	95-50-225	-125	5.75 (146)	95-50-275
-10	4.76 (121)	95-50-250	-150	6.73 (171)	95-50-300
-12	5.75 (146)	95-50-275	-175	7.72 (196)	95-50-325
-15	6.73 (171)	95-50-300	-200	8.70 (221)	95-50-350
-17	7.83 (199)	95-50-300			



igus® steel guide trough used in a shelf conveyor application, Series E2/000 and chainflex® cables

PDF: igus.com/e-chain-pdfs
 Product information: igus.com/e-chains

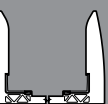
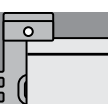
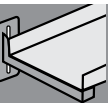

For the following Series

- System E4-1 Series
 - E4-28/R4-28
- System E4-1 Light Series
 - E4-31L/R4-31L

Part No. **96-30** - Trough Height: 3.94 in. (100 mm)

- B_a = Outer e-chain® width
- B_i = Inner e-chain® width
- h_a = e-chain® outer height
- H_{Ri} = Inner trough height
- H_{Ra} = Outer trough height
- B_{Ri} = Inner trough width ▶ depends on dim. B_a
- B_{Ra} = Outer trough width
- n_{Mon} = # of installation sets (left/right)
- n_{Ri} = # of trough set (left/right)
- ! $H_{Ri} \geq 2 \cdot h_a$
- $B_{Ri} \geq B_a + 5$
- = Guide trough
- = Glide bar
- = Installation set "Basic"
- = profile rail

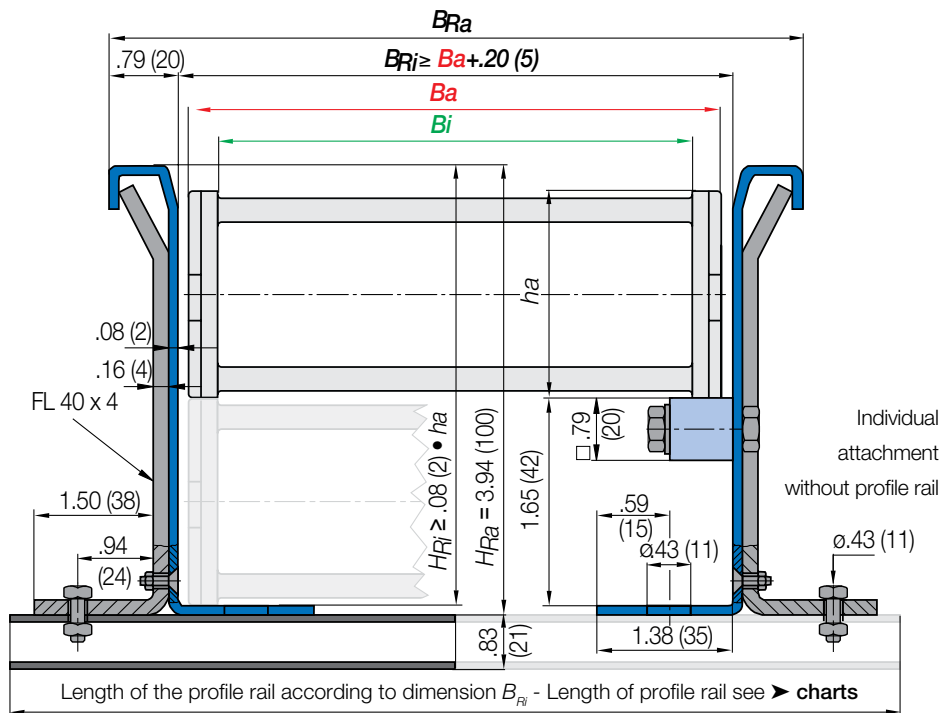

Steel Guide Trough components - Sets and single parts

Complete guide trough sets - description	Part No.	Weight lbs
Set of 2 trough side parts without glide bars, each 6.56 ft. (2m)	96-30	23.81
1 Installation set "Basic" with profile rail	95-50-___	
1 Installation set "Basic" without profile rail	96-50	1.01
1 Glide bar set with hardware, each 6.56 ft. (2m) + 22 bolts	92-01	4.52

Single parts - description

1 profile rail, individual	92-52-___	.60 lbs/ft
1 Clamping brackets, 2 pcs	95-51	.40
4 Flat-head screws M6 x 20	92-53	
4 Lock nuts M6	92-55	
2 3/8 Slide nuts	92-56	
2 Hex-head bolts 3/8 x 3/4	92-57	
Glide bar hardware only, 22 pcs	92-21	1.21

Supplement Part No. with the indicated profile rail-length-index. **Example: 95-50-175**
profile rail-length-index for your chosen trough inner width B_{Ri} ▶ **opposite page**

Design sketch: Number of installation sets which have to be installed

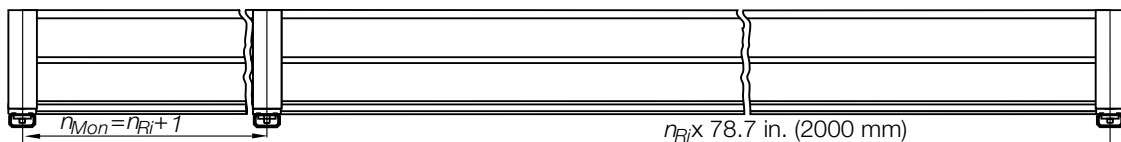

Part No. Installation set: Steel Guide Trough with profile rail (depending on the width)

E4-28/R4-28			E4-31L/R4-31L		
Width Index	B_{Ri} in. (mm)	Part No. Installation set	Width Index	B_{Ri} in. (mm)	Part No. Installation set
-040	2.56 (65)	*	-040	2.32 (59)	*
-050	2.95 (75)	95-50-200	-050	2.72 (69)	*
-062	3.43 (87)	95-50-200	-062	3.19 (81)	95-50-200
-070	3.74 (95)	95-50-200	-075	3.70 (94)	95-50-200
-075	3.94 (100)	95-50-225	-087	4.17(106)	95-50-225
-100	4.92 (125)	95-50-250	-100	4.69 (119)	95-50-225
-125	5.91 (150)	95-50-275	-112	5.16 (131)	95-50-250
-150	6.89 (175)	95-50-300	-125	5.67 (144)	95-50-250
-175	7.87 (200)	95-50-325	-150	6.65 (169)	95-50-275
-200	8.86 (225)	95-50-350	-162	7.13 (181)	95-50-300
-225	9.84 (250)	95-50-375	-175	7.64 (194)	95-50-300
-250	10.83 (275)	95-50-400	*upon request		
-275	11.81 (300)	95-50-425			
-300	12.80 (325)	95-50-450			

*upon request



Lightweight and high stability: igus® e-chain® tames stiff hydraulic hoses

PDF: igus.com/e-chain-pdfs
Product information: igus.com/e-chains

AL

ST

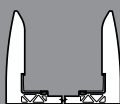
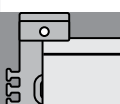
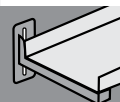

For the following Series

System E4-1 Series

- E4-32/H4-320/R4-32

System E4-1 Light Series:

- E4-38L/R4-38L

Part No. **98-30** - Trough Height: 5.12 in. (130 mm)

- Ba** = Outer e-chain® width
- Bi** = Inner e-chain® width
- ha** = e-chain® outer height
- H_{Ri}** = Inner trough height
- H_{Ra}** = Outer trough height
- B_{Ri}** = Inner trough width ▶ depends on dim. **Ba**
- B_{Ra}** = Outer trough width
- n_{Mon}** = # of installation sets (left/right)
- n_{Ri}** = # of trough set (left/right)
- ! **H_{Ri} ≥ 2 • ha**
- **B_{Ri} ≥ Ba + 5**
- = Guide trough
- = Glide bar
- = Installation set "Basic"
- = profile rail

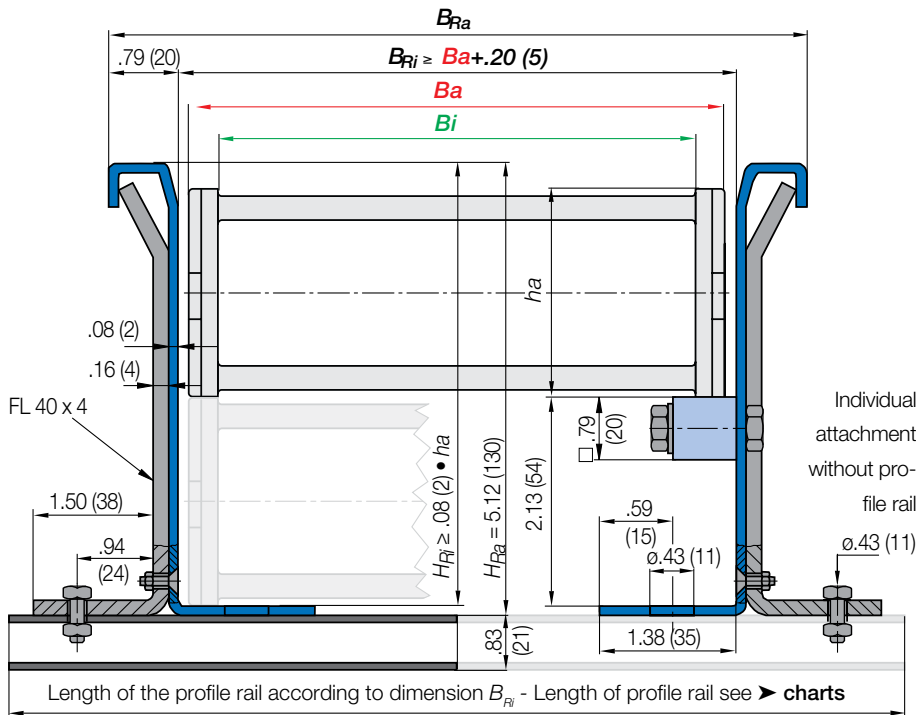

Steel Guide Trough components - Sets and single parts

Complete guide trough sets - description	Part No.	Weight lbs
Set of 2 trough side parts without glide bars, each 6.56 ft. (2m)	98-30	28.22
1 Installation set "Basic" with profile rail	93-50-____	
1 Installation set "Basic" without profile rail	93-50	1.19
1 Glide bar set with hardware, each 6.56 ft. (2m) + 22 bolts	92-01	4.52

Single parts - description	Part No.	Weight lbs
1 profile rail, individual	92-52-____	.60 lbs/ft
1 Clamping brackets, 2 pcs	93-51	.49
4 Flat-head screws M6 x 20	92-53	
4 Lock nuts M6	92-55	
2 3/8 Slide nuts	92-56	
2 Hex-head bolts 3/8 x 3/4	92-57	
Glide bar hardware only, 22 pcs	93-21	1.21

Supplement Part No. with the indicated profile rail-length-index. **Example: 93-50-175**
profile rail-length-index for your chosen trough inner width **B_{Ri}** ▶ **opposite page**

Design sketch: Number of installation sets which have to be installed

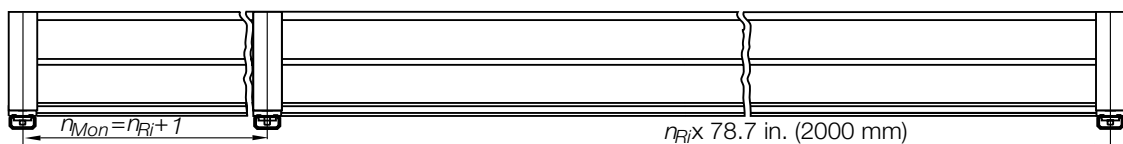

Part No. Installation set: Steel Guide Trough with profile rail (depending on the width)

E4-32/H4-32/R4-32			E4-38L/R4-38L		
Width Index	B _{Ri} in. (mm)	Part No. Installation set	Width Index	B _{Ri} in. (mm)	Part No. Installation set
-05	3.15 (78)	93-50-200	-050	2.80 (71)	93-50-200
-06	3.86 (96)	93-50-225	-062	3.27 (83)	93-50-200
-07	4.13 (103)	93-50-225	-075	3.78 (96)	93-50-225
-087	4.61 (115)	93-50-225	-087	4.25 (108)	93-50-225
-10	5.12 (128)	93-50-250	-100	4.76 (121)	93-50-250
-11	5.43 (136)	93-50-250	-105	4.96 (126)	93-50-250
-112	5.59 (141)	93-50-250	-112	5.24 (133)	93-50-250
-12	6.10 (153)	93-50-275	-125	5.75 (146)	93-50-275
-137	6.57 (166)	93-50-275	-137	6.22 (158)	93-50-275
-15	7.09 (178)	93-50-300	-150	6.73 (171)	93-50-300
-162	7.56 (191)	93-50-300	-162	7.21 (183)	93-50-300
-17	7.80 (196)	93-50-325	-175	7.72 (196)	93-50-325
-18	8.07 (203)	93-50-325	-187	8.19 (208)	93-50-325
-187	8.54 (216)	93-50-325	-200	8.70 (221)	93-50-350
-20	9.06 (228)	93-50-350	-212	9.17 (233)	93-50-350
-212	9.53 (241)	93-50-350	-225	9.69 (246)	93-50-375
-23	10.04 (253)	93-50-375	-237	10.16 (258)	93-50-375
-237	10.51 (266)	93-50-375	-250	10.67 (271)	93-50-400
-25	11.02 (278)	93-50-400	-262	11.14 (283)	93-50-400
-262	11.50 (291)	93-50-400	-300	12.64 (321)	93-50-450
-28	12.01 (303)	93-50-425			
-29	12.48 (316)	93-50-425			
-30	12.99 (328)	93-50-450			
-312	13.46 (341)	93-50-450			
-325	13.98 (353)	93-50-475			
-337	14.45 (366)	93-50-475			
-350	14.96 (378)	93-50-500			
-362	15.43 (391)	93-50-500			
-375	15.94 (403)	93-50-525			
-387	16.42 (416)	93-50-525			
-400	16.93 (428)	93-50-550			



igus® System E4 with extension link at a ship loader for the coal unloading.
 Travel 344.5 ft.(105 m), speed 787 ft/min (240 m/min), load 35.6 lbs/ft (53 kg/m)

PDF: igus.com/e-chain-pdfs
 Product information: igus.com/e-chains

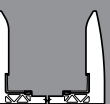
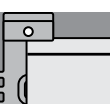
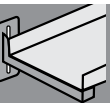

For the following Series

System E2/000 Series:

- 3400/3500

System E2 Tube Series:

- R68

System E4-1 Series

- E4-42/H4-42/R4-42

System E4-1 Light Series:

- E4-48L/R4-48L

Part No. **93-30** - Trough Height: 5.12 in. (130 mm)

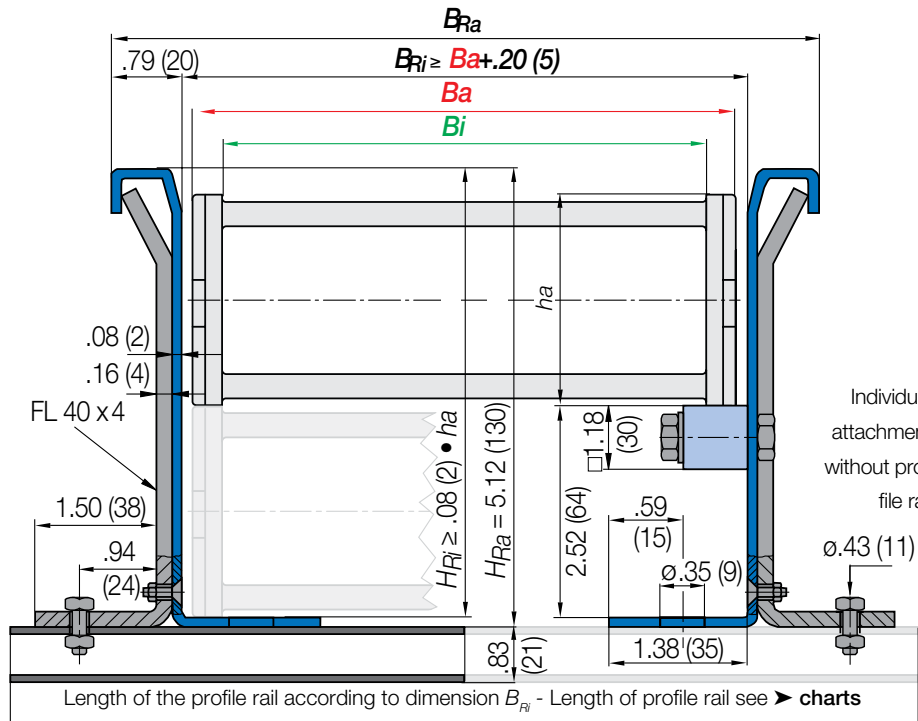

- Ba** = Outer e-chain® width
- Bi** = Inner e-chain® width
- ha** = e-chain® outer height
- H_{Ri}** = Inner trough height
- H_{Ra}** = Outer trough height
- B_{Ri}** = Inner trough width > depends on dim. **Ba**
- B_{Ra}** = Outer trough width
- n_{Mon}** = # of installation sets (left/right)
- n_{Ri}** = # of trough set (left/right)
- ! **H_{Ri} ≥ 2 • ha**
- **B_{Ri} ≥ Ba + 5**
- = Guide trough
- = Glide bar
- = Installation set "Basic"
- = profile rail

Steel Guide Trough components - Sets and single parts

Complete guide trough sets - description	Part No.	Weight lbs
Set of 2 trough side parts without glide bars, each 6.56 ft. (2m)	93-30	28.22
1 Installation set "Basic" with profile rail	93-50-___	
1 Installation set "Basic" without profile rail	93-50	1.19
1 Glide bar set with hardware, each 6.56 ft. (2m) + 22 bolts	93-01	9.95

Single parts - description	Part No.	Weight lbs
1 profile rail, individual	92-52-___	.60 lbs/ft.
1 Clamping brackets, 2 pcs	93-51	.49
4 Flat-head screws M6 x 20	92-53	
4 Lock nuts M6	92-55	
2 3/8 Slide nuts	92-56	
2 Hex-head bolts 3/8 x 3/4	92-57	
Glide bar hardware only, 22 pcs	93-21	2.67

Supplement Part No. with the indicated profile rail-length-index. **Example: 93-50-175**
profile rail-length-index for your chosen trough inner width **B_{Ri}** > **opposite page**

Design sketch: Number of installation sets which have to be installed

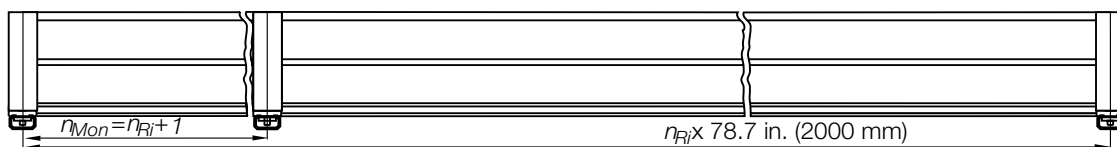

Part No. Installation set: Steel Guide Trough with profile rail (depending on the width)

3400/3500			E4-42/H4-42/R4-42			E4-48L/R4-48L		
Width Index	B_{Ri} in. (mm)	Part No. Installation set	Width Index	B_{Ri} in. (mm)	Part No. Installation set	Width Index	B_{Ri} in. (mm)	Part No. Installation set
-075	3.94 (100)	93-50-225	-05	3.19 (81)	93-50-200	-050	2.95 (75)	93-50-200
-115	5.51 (140)	93-50-250	-06	3.90 (99)	93-50-225	-062	3.43 (87)	93-50-200
-175	7.87 (200)	93-50-300	-07	4.17 (106)	93-50-225	-075	3.94 (100)	93-50-225
			-087	4.69 (119)	93-50-250	-087	4.41 (112)	93-50-225
			-10	5.16 (131)	93-50-250	-100	4.92 (125)	93-50-250
			-11	5.47 (139)	93-50-250	-105	5.11 (130)	93-50-250
			-112	5.67 (144)	93-50-275	-112	5.39 (137)	93-50-250
			-12	6.14 (156)	93-50-275	-125	5.91 (150)	93-50-275
			-137	6.65 (169)	93-50-300	-137	6.38 (162)	93-50-275
			-15	7.12 (181)	93-50-300	-150	6.89 (175)	93-50-300
			-162	7.64 (194)	93-50-325	-162	7.36 (187)	93-50-300
			-17	7.83 (199)	93-50-325	-175	7.87 (200)	93-50-325
			-18	8.11 (206)	93-50-325	-200	8.86 (225)	93-50-350
			-187	8.62 (219)	93-50-350	-225	9.84 (250)	93-50-375
			-20	9.09 (231)	93-50-350	-237	10.31 (262)	93-50-375
			-212	9.61 (244)	93-50-375	-250	10.83 (275)	93-50-400
			-23	10.08 (256)	93-50-375	-262	11.30 (287)	93-50-400
			-237	10.59 (269)	93-50-400	-300	12.80 (325)	93-50-450
			-25	11.06 (281)	93-50-400			
			-262	11.57 (294)	93-50-425			
			-28	12.05 (306)	93-50-425			
			-29	12.56 (319)	93-50-450			
			-30	13.03 (331)	93-50-450			
			-312	13.54 (344)	93-50-475			
			-325	14.01 (356)	93-50-475			
			-337	14.52 (369)	93-50-500			
			-350	15.00 (381)	93-50-500			
			-362	15.51 (394)	93-50-525			
			-375	16.02 (407)	93-50-525			
			-387	16.50 (419)	93-50-550			
			-400	16.97 (431)	93-50-550			

R68		
Width Index	B_{Ri} in. (mm)	Part No. Installation set
-050	2.87 (73)	93-50-200
-075	3.86 (98)	93-50-225
-100	4.84 (123)	93-50-250
-115	5.43 (138)	93-50-250
-125	5.83 (148)	93-50-275
-150	6.81 (173)	93-50-300
-175	7.80 (198)	93-50-325
-200	8.78 (223)	93-50-350
-225	9.76 (248)	93-50-375
-250	10.75 (273)	93-50-400



Travel up to 639.7 ft. (195 m) with the igus® System E4, safely guided in an igus® steel trough

PDF: igus.com/e-chain-pdfs
Product information: igus.com/e-chains

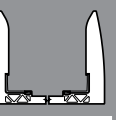
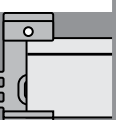
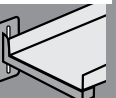

For the following Series

- System E4-1 Series
 - E4-56/H4-56/R4-56
- System E4-1 Light Series
 - E4-64L/R4-64L
- System E4 Light Series:
 - 14040/14140/R18840
 - 14240/14340

- B_a = Outer e-chain® width
- B_i = Inner e-chain® width
- h_a = e-chain® outer height
- H_{Ri} = Inner trough height
- H_{Ra} = Outer trough height
- B_{Ri} = Inner trough width ▶ depends on dim. B_a
- B_{Ra} = Outer trough width
- n_{Mon} = # of installation sets (left/right)
- n_{Ri} = # of trough set (left/right)
- ! $H_{Ri} \geq 2 \cdot h_a$
- $B_{Ri} \geq B_a + 5$
- = Guide trough
- = Glide bar
- = Installation set "Basic"
- = profile rail

Part No. 94-30 - Trough Height: 6.69 in. (170 mm)

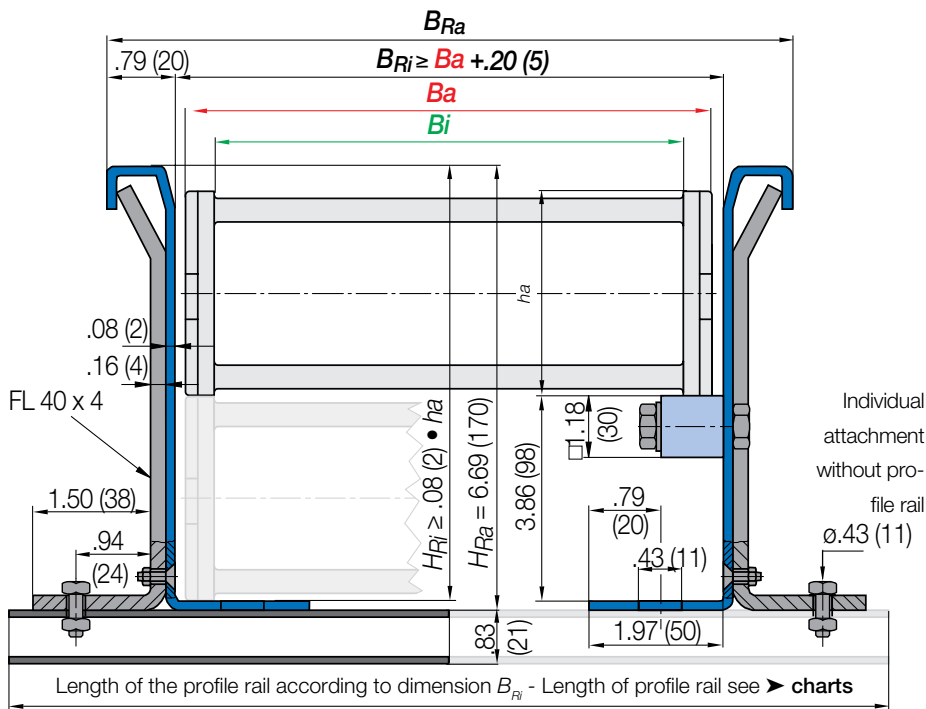

Steel Guide Trough components - Sets and single parts

Complete guide trough sets - description	Part No.	Weight lbs
Set of 2 trough side parts without glide bars, each 6.56 ft. (2m)	94-30	37.04
1 Installation set "Basic" with profile rail	94-50-___	
1 Installation set "Basic" without profile rail	94-50	1.41
1 Glide bar set with hardware, each 6.56 ft. (2m) + 22 bolts	93-01	4.30

Single parts - description	Part No.	Weight lbs
1 profile rail, individual	92-52-___	.60 lbs/ft
1 Clamping brackets, 2 pcs	94-51	.60
4 Flat-head screws M6 x 20	92-53	
4 Lock nuts M6	92-55	
2 3/8 Slide nuts	92-56	
2 Hex-head bolts 3/8 x 3/4	92-57	
Glide bar hardware only, 22 pcs	93-21	2.65

Supplement Part No. with the indicated profile rail-length-index. **Example: 94-50-175**
profile rail-length-index for your chosen trough inner width B_{Ri} ▶ **opposite page**

Design sketch: Number of installation sets which have to be installed

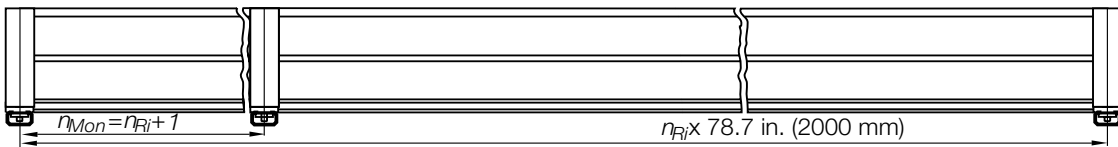

Part No. Installation set: Steel Guide Trough with profile rail (depending on the width)

E4-56/H4-56/R4-56			14040/14140/R18840			14240/14340			E4-64L/R4-64L		
Width Index	B_{Ri} in. (mm)	Part No. Installation set	Width Index	B_{Ri} in. (mm)	Part No. Installation set	Width Index	B_{Ri} in. (mm)	Part No. Installation set	Width Index	B_{Ri} in. (mm)	Part No. Installation set
-05	3.50 (89)	*	-05	3.19 (81)	*	-05	3.19 (81)	*	-087	4.65 (118)	94-50-225
-06	4.23 (104)	94-50-225	-06	3.78 (96)	*	-06	3.90 (99)	*	-100	5.16 (131)	94-50-250
-07	4.49 (114)	94-50-225	-07	4.17 (106)	94-50-225	-07	4.17 (106)	94-50-225	-150	7.13 (181)	94-50-300
-08	4.76 (121)	94-50-225	-10	5.16 (131)	94-50-250	-087	4.65 (118)	94-50-250	-200	9.09 (231)	94-50-350
-10	5.47 (139)	94-50-250	-11	5.63 (143)	94-50-275	-10	5.16 (131)	94-50-250			
-11	5.98 (152)	94-50-275	-12	6.14 (156)	94-50-275	-11	5.47 (139)	94-50-250			
-12	6.46 (164)	94-50-275	-13	6.61 (168)	94-50-300	-112	5.63 (143)	94-50-275			
-13	6.97 (177)	94-50-300	-15	7.13 (181)	94-50-300	-12	6.14 (156)	94-50-275			
-15	7.44 (189)	94-50-300	-16	7.60 (193)	94-50-325	-137	6.61 (168)	94-50-300			
-16	7.95 (202)	94-50-325	-17	8.11 (206)	94-50-325	-15	7.12 (181)	94-50-300			
-17	8.42 (214)	94-50-325	-18	8.58 (218)	94-50-350	-162	7.60 (193)	94-50-325			
-18	8.94 (227)	94-50-350	-20	9.09 (231)	94-50-350	-17	7.83 (199)	94-50-325			
-20	9.41 (239)	94-50-350	-21	9.57 (243)	94-50-375	-18	8.11 (206)	94-50-325			
-21	9.92 (252)	94-50-375	-22	10.08 (256)	94-50-375	-187	8.58 (218)	94-50-350			
-22	10.39 (264)	94-50-375	-23	10.55 (268)	94-50-400	-20	9.09 (231)	94-50-350			
-23	10.91 (277)	94-50-400	-25	11.06 (281)	94-50-400	-212	9.57 (243)	94-50-375			
-25	11.38 (289)	94-50-400	-26	11.54 (293)	94-50-425	-23	10.08 (256)	94-50-375			
-26	11.89 (302)	94-50-425	-27	12.05 (306)	94-50-425	-237	10.55 (268)	94-50-400			
-27	12.36 (314)	94-50-425	-28	12.52 (318)	94-50-450	-25	11.06 (281)	94-50-400			
-28	12.87 (327)	94-50-450	-30	13.03 (331)	94-50-450	-262	11.54 (293)	94-50-425			
-30	13.35 (339)	94-50-450	-31	13.50 (343)	94-50-475	-28	12.05 (306)	94-50-425			
-31	13.86 (352)	94-50-475	-32	14.02 (356)	94-50-475	-29	12.52 (318)	94-50-450			
-32	14.33 (364)	94-50-475	-33	14.49 (368)	94-50-500	-30	13.03 (331)	94-50-450			
-33	14.84 (377)	94-50-500	-35	15.00 (381)	94-50-500	-312	13.50 (343)	94-50-475			
-35	15.31 (389)	94-50-500	-36	15.47 (393)	94-50-525	-325	14.02 (356)	94-50-475			
-36	15.82 (402)	94-50-525	-37	15.98 (406)	94-50-525	-337	14.49 (368)	94-50-500			
-37	16.30 (414)	94-50-525	-38	16.46 (418)	94-50-550	-350	15.00 (381)	94-50-500			
-38	16.81 (427)	94-50-550	-40	16.97 (431)	94-50-550	-362	15.47 (393)	94-50-525			
-40	17.28 (439)	94-50-550	-41	17.44 (443)	94-50-575	-375	15.98 (406)	94-50-525			
-41	17.79 (452)	94-50-575	-42	17.95 (456)	94-50-575	-387	16.46 (418)	94-50-550			
-42	18.27 (464)	94-50-575	-43	18.43 (468)	94-50-600	-400	16.97 (431)	94-50-550			
-43	18.78 (477)	94-50-600	-45	18.94 (481)	94-50-600						
-45	19.25 (489)	94-50-600	-46	19.41 (493)	94-50-625						
-46	19.76 (502)	94-50-625	-47	19.92 (506)	94-50-625						
-47	20.24 (514)	94-50-625	-48	20.59 (518)	94-50-650						
-48	20.75 (527)	94-50-650	-50	20.91 (531)	94-50-650						
-50	21.22 (539)	94-50-650	-51	21.38 (543)	94-50-675						
-51	21.73 (552)	94-50-675	-52	21.89 (556)	94-50-675						
-52	22.20 (564)	94-50-675	-53	22.36 (568)	94-50-700						
-53	22.72 (577)	94-50-700	-55	22.87 (581)	94-50-700						
-55	23.19 (589)	94-50-700	-60	24.84 (631)	94-50-750						
-60	25.28 (639)	94-50-750									



590.5 ft. (180 m) travel, 20.2 lbs/ft (30 kg/m) fill weight.
Two igus® E4 Rol e-chains®

PDF: igus.com/e-chain-pdfs
Product information: igus.com/e-chains

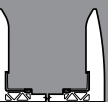
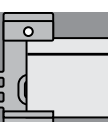
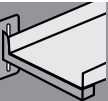

For the following Series

System E4 Light Series:

- 14550/14650/R19050

Part No. **94-14550-30** - Trough Height: 6.69 in. (170 mm)

- B_a = Outer e-chain® width
- B_i = Inner e-chain® width
- h_a = e-chain® outer height
- H_{Ri} = Inner trough height
- H_{Ra} = Outer trough height
- B_{Ri} = Inner trough width ▶ depends on dim. B_a
- B_{Ra} = Outer trough width
- n_{Mon} = # of installation sets (left/right)
- n_{Ri} = # of trough set (left/right)
- ! $H_{Ri} \geq 2 \cdot h_a$
- $B_{Ri} \geq B_a + 5$
- = Guide trough
- = Glide bar
- = Installation set "Basic"
- = profile rail

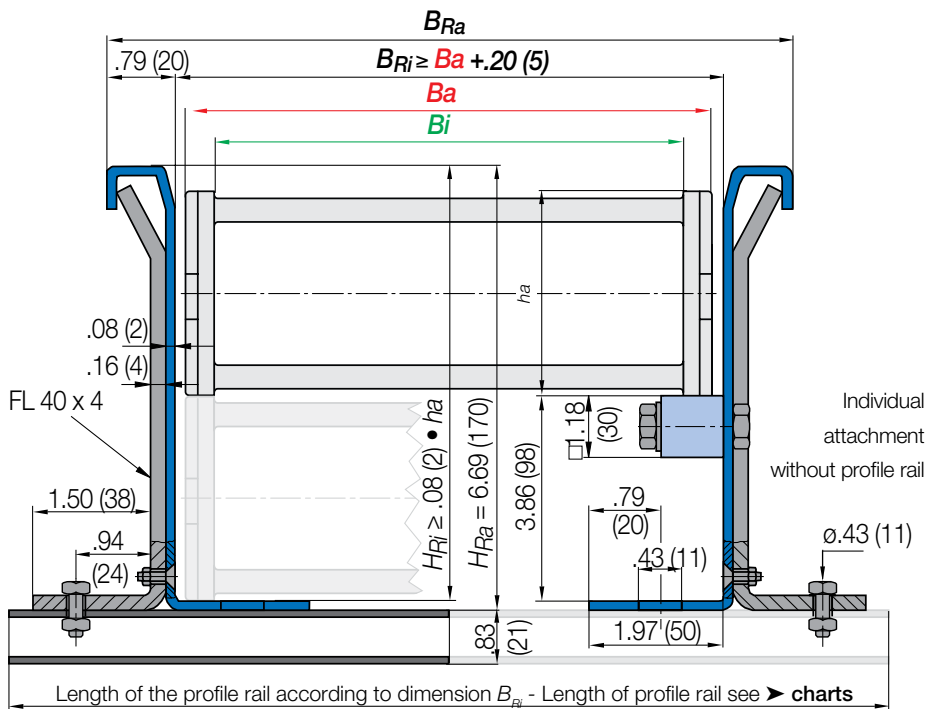

Steel Guide Trough components - Sets and single parts

Complete guide trough sets - description	Part No.	Weight lbs
Set of 2 trough side parts without glide bars, each 6.56 ft. (2m)	94-14550-30	37.04
1 Installation set "Basic" with profile rail	94-50-___	
1 Installation set "Basic" without profile rail	94-50	1.41
1 Glide bar set with hardware, each 6.56 ft. (2m) + 22 bolts	93-01	4.30

Single parts - description

1 profile rail, individual	92-52-___	.60 lbs/ft
1 Clamping brackets, 2 pcs	94-51	.60
4 Flat-head screws M6 x 20	92-53	
4 Lock nuts M6	92-55	
2 3/8 Slide nuts	92-56	
2 Hex-head bolts 3/8 x 3/4	92-57	
Glide bar hardware only, 22 pcs	93-21	2.65

Supplement Part No. with the indicated profile rail-length-index. **Example: 94-50-175**
profile rail-length-index for your chosen trough inner width B_{Ri} ▶ **opposite page**

Design sketch: Number of installation sets which have to be installed

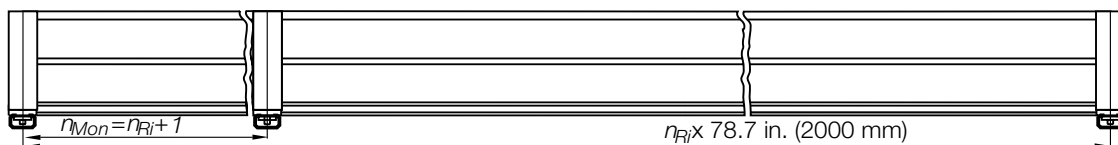

Part No. Installation set: Steel Guide Trough with profile rail (depending on the width)

14550/14650/R19050

Width Index	B_{ri} in. (mm)	Part No. Installation set
-05	3.19 (81)	*
-06	3.78 (96)	*
-07	4.17 (106)	94-50-225
-10	5.16 (131)	94-50-250
-11	5.63 (143)	94-50-275
-12	6.14 (156)	94-50-275
-13	6.61 (168)	94-50-300
-15	7.13 (181)	94-50-300
-16	7.60 (193)	94-50-325
-17	8.11 (206)	94-50-325
-18	8.58 (218)	94-50-350
-20	9.09 (231)	94-50-350
-21	9.57 (243)	94-50-375
-22	10.08 (256)	94-50-375
-23	10.55 (268)	94-50-400
-25	11.06 (281)	94-50-400
-26	11.54 (293)	94-50-425
-27	12.05 (306)	94-50-425
-28	12.52 (318)	94-50-450
-30	13.03 (331)	94-50-450
-31	13.50 (343)	94-50-475
-32	14.02 (356)	94-50-475
-33	14.49 (368)	94-50-500
-35	15.00 (381)	94-50-500
-36	15.47 (393)	94-50-525
-37	15.98 (406)	94-50-525
-38	16.46 (418)	94-50-550
-40	16.97 (431)	94-50-550
-41	17.44 (443)	94-50-575
-42	17.95 (456)	94-50-575
-43	18.43 (468)	94-50-600
-45	18.94 (481)	94-50-600
-46	19.41 (493)	94-50-625
-47	19.92 (506)	94-50-625
-48	20.59 (518)	94-50-650
-50	20.91 (531)	94-50-650
-51	21.38 (543)	94-50-675
-52	21.89 (556)	94-50-675
-53	22.36 (568)	94-50-700
-55	22.87 (581)	94-50-700
-60	24.84 (631)	94-50-750



System E4 with extension links, long travel application on board West Navigator (Norway)

PDF: igus.com/e-chain-pdfs
 Product information: igus.com/e-chains

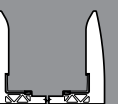
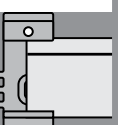
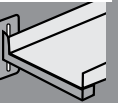

For the following Series

System E4-1 Series

- E4-80/H4-80/R4-80

System E4 Light Series:

- 15050/15150/R19850
- 15250/15350

- B_a = Outer e-chain® width
- B_i = Inner e-chain® width
- h_a = e-chain® outer height
- H_{Ri} = Inner trough height
- H_{Ra} = Outer trough height
- B_{Ri} = Inner trough width ▶ depends on dim. B_a
- B_{Ra} = Outer trough width
- n_{Mon} = # of installation sets (left/right)
- n_{Ri} = # of trough set (left/right)
- ! $H_{Ri} \geq 2 \cdot h_a$
- $B_{Ri} \geq B_a + 5$
- = Guide trough
- = Glide bar
- = Installation set "Basic"
- = profile rail

Part No. 99-30 - Trough Height: 8.66 in. (220 mm)

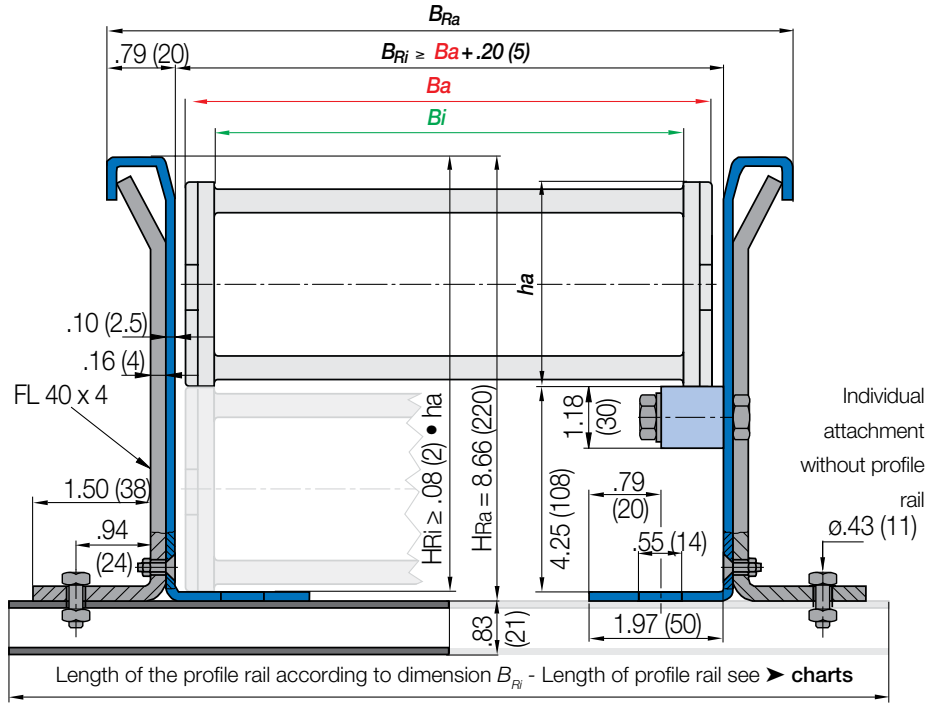

Steel Guide Trough components - Sets and single parts

Complete guide trough sets - description	Part No.	Weight lbs
Set of 2 trough side parts without glide bars, each 6.56 ft. (2m)	99-30	43.66
1 Installation set "Basic" with profile rail	96-50-___	
1 Installation set "Basic" without profile rail	96-50	1.63
1 Glide bar set with hardware, each 6.56 ft. (2m) + 22 bolts	93-01	9.95

Single parts - description	Part No.	Weight lbs
1 profile rail, individual	92-52-___	.60 lbs/ft
1 Clamping brackets, 2 pcs	96-51	.69
4 Flat-head screws M6 x 20	92-53	
4 Lock nuts M6	92-55	
2 3/8 Slide nuts	92-56	
2 Hex-head bolts 3/8 x 3/4	92-57	
Glide bar hardware only, 22 pcs	93-21	2.67

Supplement Part No. with the indicated profile rail-length-index. Example: 96-50-175
profile rail-length-index for your chosen trough inner width B_{Ri} ▶ opposite page

Design sketch: Number of installation sets which have to be installed

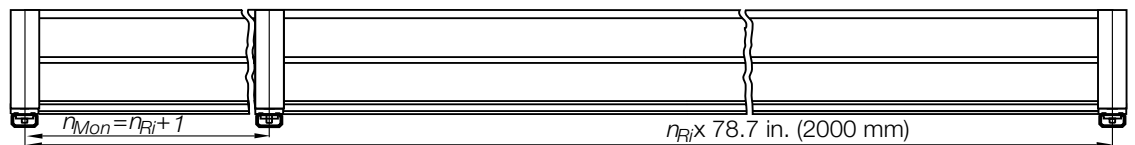

Part No. Installation set: Steel Guide Trough with profile rail (depending on the width)

E4-80/H4-80/R4-80			15050/15150/R19850			15250/15350		
Width Index	B _{Ri} in. (mm)	Part No. Installation set	Width Index	B _{Ri} in. (mm)	Part No. Installation set	Width Index	B _{Ri} in. (mm)	Part No. Installation set
-05	4.13 (105)	96-50-225	-05	3.35 (85)	*	-05	3.35 (85)	*
-06	4.72 (120)	96-50-250	-07	4.33 (110)	96-50-225	-06	4.06 (103)	96-50-225
-07	5.12 (130)	96-50-250	-10	5.31 (135)	96-50-250	-07	4.33 (110)	96-50-225
-10	6.10 (155)	96-50-275	-11	5.83 (148)	96-50-275	-087	4.80 (122)	96-50-250
-11	6.61 (168)	96-50-300	-12	6.30 (160)	96-50-275	-09	5.20 (132)	96-50-250
-12	7.09 (180)	96-50-300	-13	6.81 (173)	96-50-300	-10	5.31 (135)	96-50-250
-13	7.60 (193)	96-50-325	-15	7.28 (185)	96-50-300	-11	5.63 (143)	96-50-275
-15	8.07 (205)	96-50-325	-16	7.80 (198)	96-50-325	-112	5.83 (148)	96-50-275
-16	8.58 (218)	96-50-350	-17	8.27 (210)	96-50-325	-12	6.30 (160)	96-50-275
-17	9.06 (230)	96-50-350	-18	8.78 (223)	96-50-350	-137	6.77 (172)	96-50-300
-18	9.57 (243)	96-50-375	-20	9.25 (235)	96-50-350	-15	7.28 (185)	96-50-300
-20	10.04 (255)	96-50-375	-21	9.76 (248)	96-50-375	-162	7.80 (198)	96-50-325
-21	10.55 (268)	96-50-400	-22	10.24 (260)	96-50-375	-17	7.99 (203)	96-50-325
-22	11.02 (280)	96-50-400	-23	10.75 (273)	96-50-400	-18	8.27 (210)	96-50-325
-23	11.54 (293)	96-50-425	-25	11.22 (285)	96-50-400	-187	8.78 (223)	96-50-350
-25	12.01 (305)	96-50-425	-26	11.73 (298)	96-50-425	-20	9.25 (235)	96-50-350
-26	12.52 (318)	96-50-450	-27	12.20 (310)	96-50-425	-212	9.76 (248)	96-50-375
-27	12.99 (330)	96-50-450	-28	12.72 (323)	96-50-450	-23	10.24 (260)	96-50-375
-28	13.50 (343)	96-50-475	-30	13.19 (335)	96-50-450	-237	10.75 (273)	96-50-400
-30	13.98 (355)	96-50-475	-31	13.70 (348)	96-50-475	-25	11.22 (285)	96-50-400
-31	14.49 (368)	96-50-500	-32	14.17 (360)	96-50-475	-262	11.73 (298)	96-50-425
-32	14.96 (380)	96-50-500	-33	14.69 (373)	96-50-500	-28	12.20 (310)	96-50-425
-33	15.47 (393)	96-50-525	-35	15.16 (385)	96-50-500	-29	12.72 (323)	96-50-450
-35	15.94 (405)	96-50-525	-36	15.67 (398)	96-50-525	-30	13.19 (335)	96-50-450
-36	16.46 (418)	96-50-550	-37	16.14 (410)	96-50-525	-312	13.70 (348)	96-50-475
-37	16.93 (430)	96-50-550	-38	16.65 (423)	96-50-550	-325	14.17 (360)	96-50-475
-38	17.44 (443)	96-50-575	-40	17.13 (435)	96-50-550	-337	14.69 (373)	96-50-500
-40	17.91 (455)	96-50-575	-41	17.63 (448)	96-50-575	-350	15.16 (385)	96-50-500
-41	18.43 (468)	96-50-600	-42	18.11 (460)	96-50-575	-362	15.67 (398)	96-50-525
-42	18.90 (480)	96-50-600	-43	18.62 (473)	96-50-600	-375	16.14 (410)	96-50-525
-43	19.41 (493)	96-50-625	-45	19.09 (485)	96-50-600	-387	16.65 (423)	96-50-550
-45	19.88 (505)	96-50-625	-46	19.61 (498)	96-50-625	-400	17.13 (435)	96-50-550
-46	20.39 (518)	96-50-650	-47	20.08 (510)	96-50-625			
-47	20.87 (530)	96-50-650	-48	20.59 (523)	96-50-650			
-48	21.38 (543)	96-50-675	-50	21.06 (535)	96-50-650			
-50	21.85 (555)	96-50-675	-51	21.57 (548)	96-50-675			
-51	22.36 (568)	96-50-700	-52	22.04 (560)	96-50-675			
-52	22.83 (580)	96-50-700	-53	22.56 (573)	96-50-700			
-53	23.35 (593)	96-50-725	-55	23.03 (585)	96-50-700			
-55	23.82 (605)	96-50-725	-60	25.00 (635)	96-50-750			
-60	25.79 (655)	96-50-775						

*upon request

*upon request

PDF: igus.com/e-chain-pdfs
Product information: igus.com/e-chains

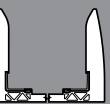
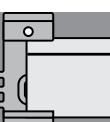
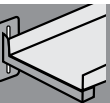

For the following Series

- System E4-1 Series:
 - E4-112/H4-112/R4-112
- System E4 Series:
 - 600/601/R608
- System E4 Light Series:
 - 1640/R1608

- B_a = Outer e-chain® width
- B_i = Inner e-chain® width
- h_a = e-chain® outer height
- H_{Ri} = Inner trough height
- H_{Ra} = Outer trough height
- B_{Ri} = Inner trough width ▶ depends on dim. B_a
- B_{Ra} = Outer trough width
- n_{Mon} = # of installation sets (left/right)
- n_{Ri} = # of trough set (left/right)
- ! $H_{Ri} \geq 2 \cdot h_a$
- $B_{Ri} \geq B_a + 5$
- = Guide trough
- = Glide bar
- = Installation set "Basic"
- = profile rail

Part No. 97-30 - Trough Height: 11.81 in. (300 mm)

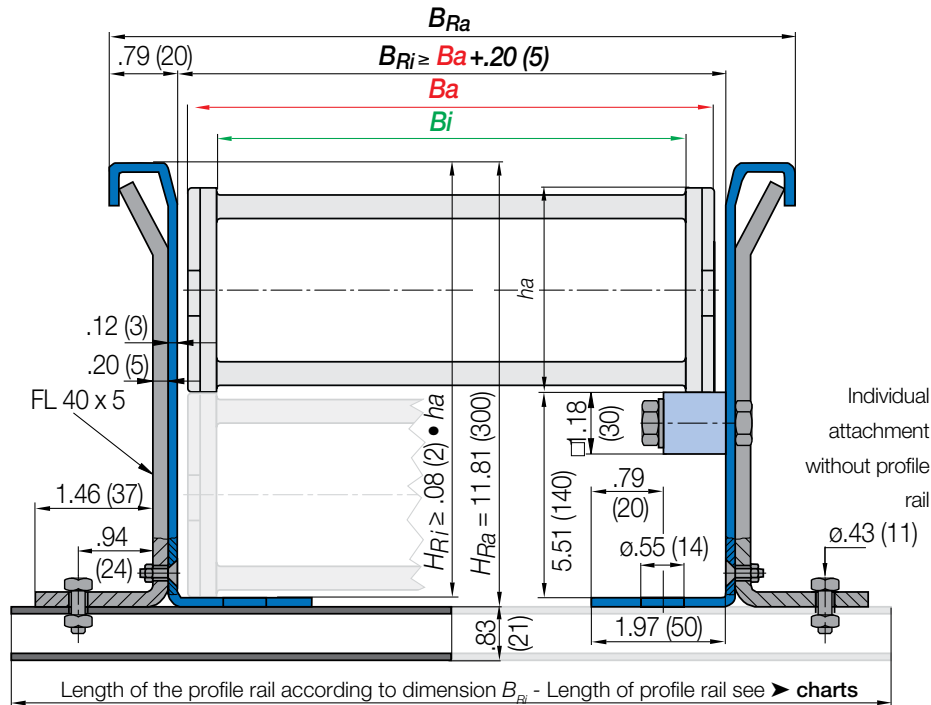

Steel Guide Trough components - Sets and single parts

Complete guide trough sets - description	Part No.	Weight lbs
Set of 2 trough side parts without glide bars, each 6.56 ft. (2m)	97-30	60.42
1 Installation set "Basic" with profile rail	97-50-____	
1 Installation set "Basic" without profile rail	97-50	2.47
1 Glide bar set with hardware, each 6.56 ft. (2m) + 22 bolts	93-01	9.95

Single parts - description

1 profile rail, individual	92-52-____	.60 lbs/ft
1 Clamping brackets, 2 pcs	97-51	1.12
4 Flat-head screws M6 x 20	98-52	
4 Lock nuts M8	98-53	
2 3/8 Slide nuts	92-56	
2 Hex-head bolts 3/8 x 3/4	92-57	
Glide bar hardware only, 22 pcs	93-21	2.67

Supplement Part No. with the indicated profile rail-length-index. **Example: 94-50-175**
profile rail-length-index for your chosen trough inner width B_{Ri} ▶ **opposite page**

Design sketch: Number of installation sets which have to be installed

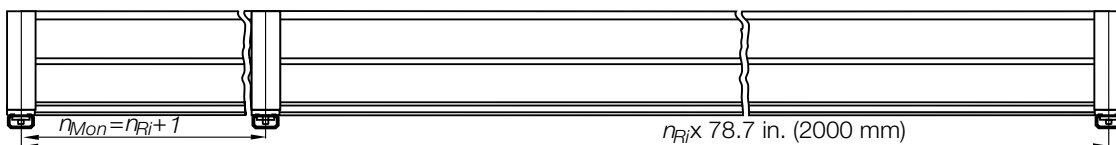

Part No. Installation set: Steel Guide Trough with profile rail (depending on the width)

E4-112/H4-112/R4-112			600/601/R608			1640/1608		
Width Index	B_{Ri} in. (mm)	Part No. Installation set	Width Index	B_{Ri} in. (mm)	Part No. Installation set	Width Index	B_{Ri} in. (mm)	Part No. Installation set
-05	4.21 (107)	97-50-225	-20	10.12 (257)	97-50-375	-05	3.50 (89)	*
-06	4.80 (122)	97-50-250	-25	12.09 (307)	97-50-425	-06	4.09 (104)	97-50-225
-07	5.20 (132)	97-50-250	-30	14.06 (357)	97-50-475	-07	4.49 (114)	97-50-250
-10	6.18 (157)	97-50-275	-32	14.84 (377)	97-50-500	-10	5.47 (139)	97-50-275
-11	6.65 (169)	97-50-300	-35	16.02 (407)	97-50-525	-11	5.94 (151)	97-50-275
-12	7.17 (182)	97-50-300	-40	17.99 (457)	97-50-575	-12	6.46 (164)	97-50-300
-13	7.64 (194)	97-50-325	-45	19.96 (507)	97-50-625	-13	6.93 (176)	97-50-300
-15	8.15 (207)	97-50-325	-50	21.93 (557)	97-50-675	-15	7.44 (189)	97-50-325
-16	8.62 (219)	97-50-350	-55	23.90 (607)	97-50-725	-16	7.91 (201)	97-50-325
-17	9.13 (232)	97-50-350	-60	25.87 (657)	97-50-775	-17	8.43 (214)	97-50-350
-18	9.61 (244)	97-50-375				-18	8.90 (226)	97-50-350
-20	10.12 (257)	97-50-375				-20	9.41 (239)	97-50-375
-21	10.59 (269)	97-50-400				-21	9.88 (251)	97-50-375
-22	11.10 (282)	97-50-400				-22	10.39 (264)	97-50-400
-23	11.57 (294)	97-50-425				-23	10.87 (276)	97-50-400
-25	12.09 (307)	97-50-425				-25	11.38 (289)	97-50-425
-26	12.56 (319)	97-50-450				-26	11.85 (301)	97-50-425
-27	13.07 (332)	97-50-450				-27	12.36 (314)	97-50-450
-28	13.54 (344)	97-50-475				-28	12.83 (326)	97-50-450
-30	14.06 (357)	97-50-475				-30	13.35 (339)	97-50-475
-31	14.53 (369)	97-50-500				-31	13.82 (351)	97-50-475
-32	15.04 (382)	97-50-500				-32	14.33 (364)	97-50-500
-33	15.51 (394)	97-50-525				-33	14.80 (376)	97-50-500
-35	16.02 (407)	97-50-525				-35	15.31 (389)	97-50-525
-36	16.50 (419)	97-50-550				-36	15.79 (401)	97-50-525
-37	17.01 (432)	97-50-550				-37	16.30 (414)	97-50-550
-38	17.48 (444)	97-50-575				-38	16.77 (426)	97-50-550
-40	17.99 (457)	97-50-575				-40	17.28 (439)	97-50-575
-41	18.46 (469)	97-50-600				-41	17.76 (451)	97-50-575
-42	18.98 (482)	97-50-600				-42	18.27 (464)	97-50-600
-43	19.45 (494)	97-50-625				-43	18.74 (476)	97-50-600
-45	19.96 (507)	97-50-625				-45	19.25 (489)	97-50-625
-46	20.43 (519)	97-50-650				-46	19.72 (501)	97-50-625
-47	20.94 (532)	97-50-650				-47	20.24 (514)	97-50-650
-48	21.42 (544)	97-50-675				-48	20.71 (526)	97-50-650
-50	21.93 (557)	97-50-675				-50	21.22 (539)	97-50-675
-51	22.40 (569)	97-50-700				-51	21.69 (551)	97-50-675
-52	22.91 (582)	97-50-700				-52	22.20 (564)	97-50-700
-53	23.39 (594)	97-50-725				-53	22.68 (576)	97-50-700
-55	23.90 (607)	97-50-725				-55	23.19 (589)	97-50-725
-60	25.87 (657)	97-50-775				-60	25.16 (639)	97-50-775

*upon request

*upon request



Rig skidding application on the Claymore, North Sea

PDF: igus.com/e-chain-pdfs
Product information: igus.com/e-chains

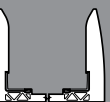
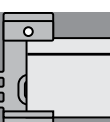
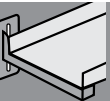

Part No. **90-30** - Trough Height: 18.90 in. (480 mm)

For the following Series

System E4 Series:

- 800

System E4-1 Series

- 840

igus®
e-chain system®

Telephone 1-800-521-2747

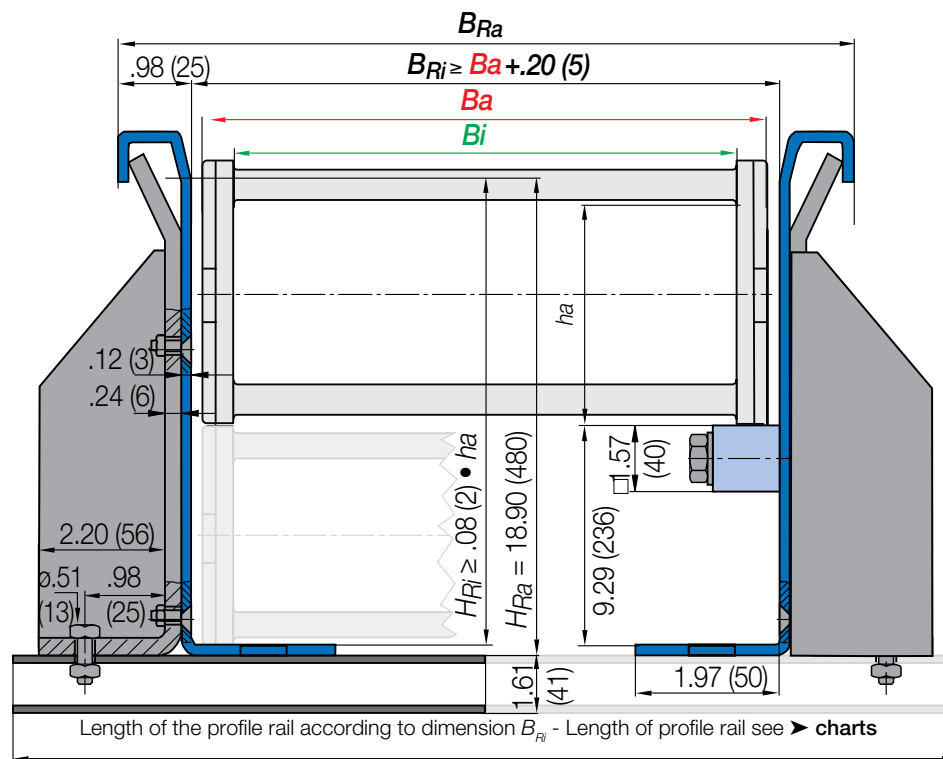

- B_a** = Outer e-chain® width
- B_i** = Inner e-chain® width
- h_a** = e-chain® outer height
- H_{Ri}** = Inner trough height
- H_{Ra}** = Outer trough height
- B_{Ri}** = Inner trough width > depends on dim. **B_a**
- B_{Ra}** = Outer trough width
- n_{Mon}** = # of installation sets (left/right)
- n_{Ri}** = # of trough set (left/right)
- ! **H_{Ri} ≥ 2 • h_a**
- ! **B_{Ri} ≥ B_a + 5**
- = Guide trough
- = Glide bar
- = Installation set "Basic"
- = profile rail

Steel Guide Trough components - Sets and single parts

Complete guide trough sets - description	Part No.	Weight lbs
Set of 2 trough side parts without glide bars, each 6.56 ft. (2m)	90-30	
1 Installation set "Basic" with profile rail	90-50-_____	
1 Installation set "Basic" without profile rail	90-50	
1 Glide bar set with hardware, each 6.56 ft. (2m) + 22 bolts	90-01	

Single parts - description

1 profile rail, individual	Special part
1 Clamping brackets, 2 pcs	90-51
4 Flat-head screws M8 x 25	92-53
4 Lock nuts M6	92-55
2 3/8 Slide nuts	92-56
2 Hex-head bolts 3/8 x 3/4	92-57
Glide bar hardware only, 22 pcs.	92-21

Supplement Part No. with the indicated profile rail-length-index. **Example: 90-50-200**
profile rail-length-index for your chosen trough inner width **B_{Ri}** > **opposite page**

Design sketch: Number of installation sets which have to be installed

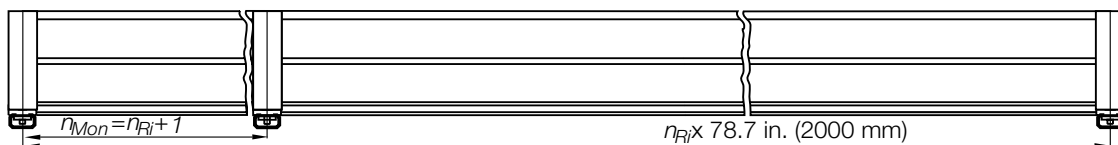

Internet: igus.com
email: sales@igus.com
QuickSpec: igus.com/quickspec

Part No. Installation set: Steel Guide Trough with profile rail (depending on the width)

800			840		
Width Index	B_{Ri} in. (mm)	Part No. Installation set	Width Index	B_{Ri} in. (mm)	Part No. Installation set
-20	10.43 (265)	90-50-450	-13	6.49 (165)	90-50-350
-25	12.40 (315)	90-50-500	-15	7.01 (178)	90-50-350
-30	14.37 (365)	90-50-550	-16	7.48 (190)	90-50-375
-32	15.35 (390)	90-50-575	-17	7.99 (203)	90-50-375
-35	16.34 (415)	90-50-600	-18	8.46 (215)	90-50-400
-40	18.31 (465)	90-50-650	-20	8.98 (228)	90-50-400
-45	20.27 (515)	90-50-700	-21	9.45 (240)	90-50-425
-50	22.24 (565)	90-50-750	-22	9.96 (253)	90-50-425
-55	24.21 (615)	90-50-800	-23	10.43 (265)	90-50-450
-60	26.18 (665)	90-50-850	-25	10.94 (278)	90-50-450
			-26	11.42 (290)	90-50-475
			-27	11.93 (303)	90-50-475
			-28	12.40 (315)	90-50-500
			-30	12.91 (328)	90-50-500
			-31	13.39 (340)	90-50-525
			-32	13.90 (353)	90-50-525
			-33	14.37 (365)	90-50-550
			-35	14.88 (378)	90-50-550
			-36	15.35 (390)	90-50-575
			-37	15.87 (403)	90-50-575
			-38	16.34 (415)	90-50-600
			-40	16.85 (428)	90-50-600
			-41	17.32 (440)	90-50-625
			-42	17.83 (453)	90-50-625
			-43	18.31 (465)	90-50-650
			-45	18.82 (478)	90-50-650
			-46	19.29 (490)	90-50-675
			-47	19.80 (503)	90-50-675
			-48	20.20 (513)	90-50-700
			-50	20.79 (528)	90-50-700
			-51	21.26 (540)	90-50-725
			-52	21.77 (553)	90-50-725
			-53	22.24 (565)	90-50-750
			-55	22.76 (578)	90-50-750
			-60	26.18 (665)	90-50-800



Assembling of an E4 e-chain® Series 800 in an igus® steel guide trough

PDF: igus.com/e-chain-pdfs
 Product information: igus.com/e-chains

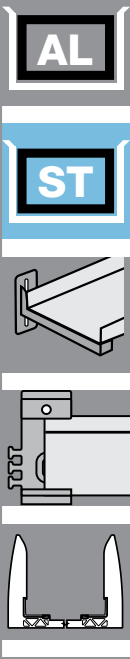

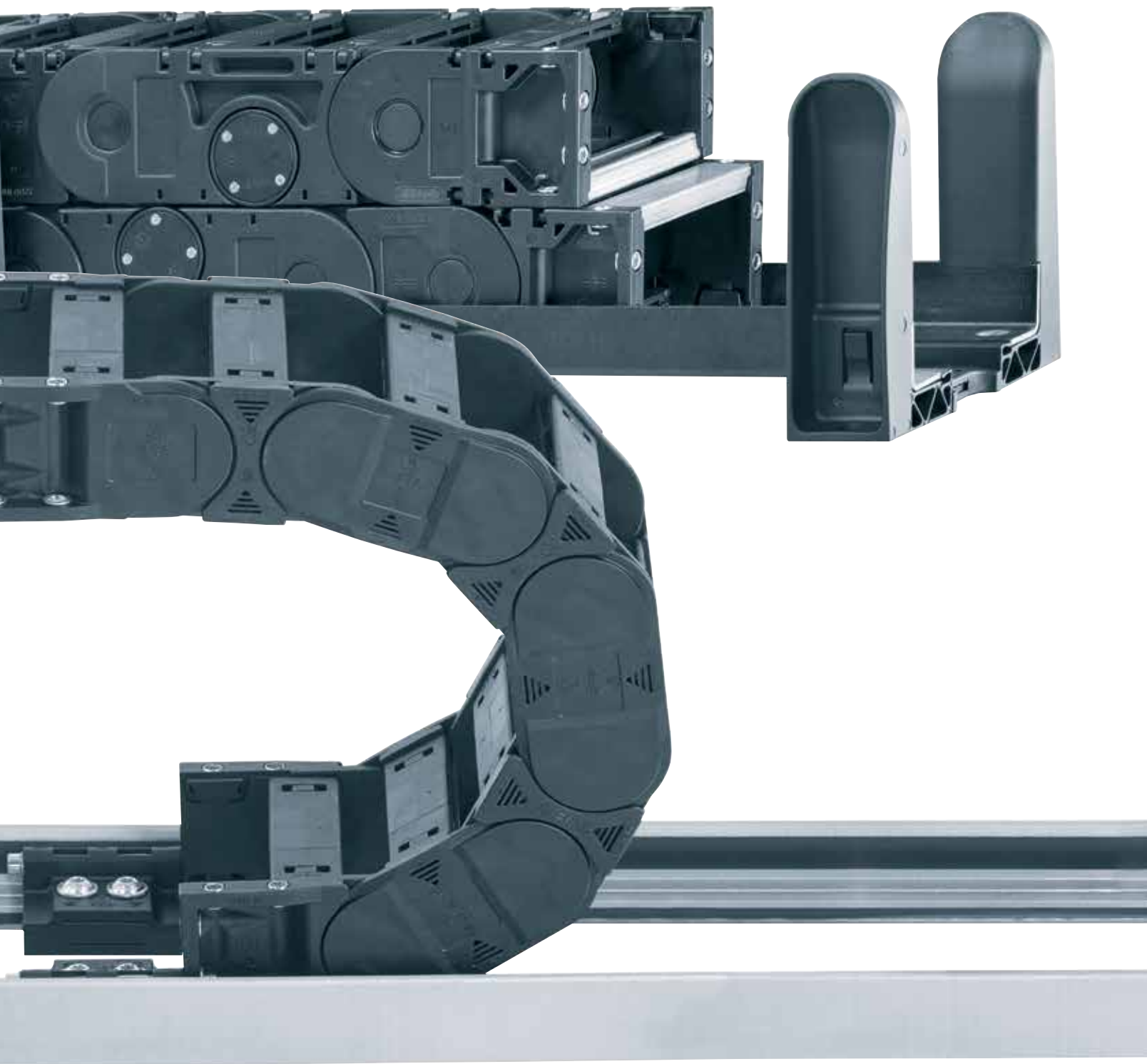

Other guide trough systems

Steel support tray

Aluminum support tray

guidefast

guidelite



Steel Support Tray

Introduction - Advantages

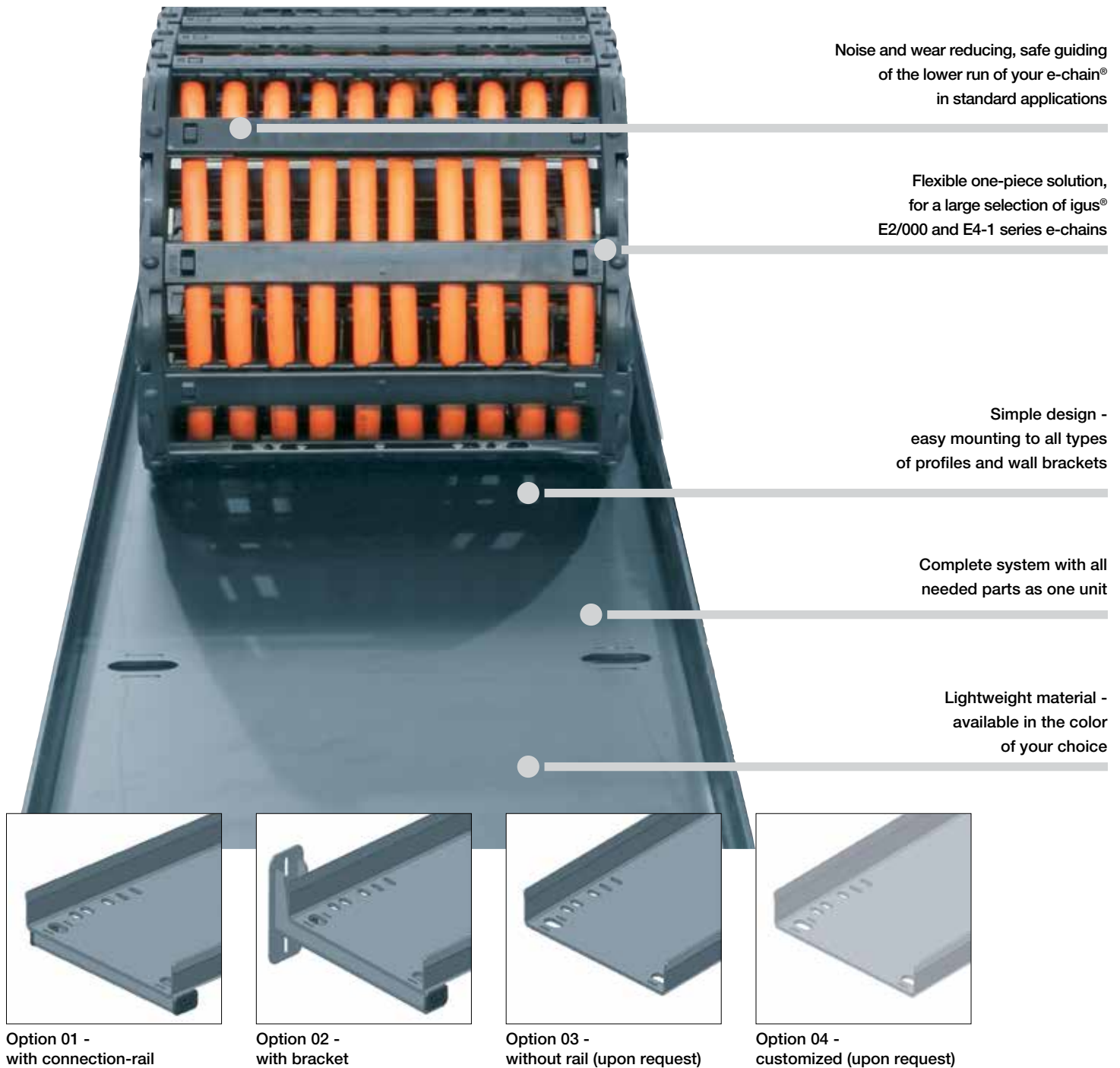

For support of the lower run - Support tray tool kit

Simple one-piece support trays for the lower e-chain® run, according with your requirements and specification. Your width, height and color - we supply the fitting e-chain®, together with the support tray system. Ready to install onto your machine or application. Save on procurement and design time.

- Complete system, ready to install
- No more costly self-made designs
- Easy installation onto your machine, on profiles or wall-mount brackets
- igus® support tray - in 2 types and 4 options available
- For many widths available from stock, with many mounting possibilities

Steel Support Tray Selection Table



Support Tray - Type 01 for Series:

- 2400/2450/2480/2500
- 2600/2650/2680/2700
- E4-21
- E4-28/R4-28
- E4-31L/R4-31L
- E4-32/H4-32/R4-32
- E4-38L/R4-38L
- E6-29/R6-29
- E6-35
- E6-40/R6-40
- E61-29

Support tray Part No.	Width e-chain®*	Outer trough width B_{Ra} in. (mm)	Inner trough width B_{Ri} in. (mm)	Material
S9-010/011-05-XXXX-0	-05 / -050	3.50 (89)	3.15 (80)	Steel, black
S9-010/011-07-XXXX-0	-07 / -070	4.49 (114)	4.13 (105)	Steel, black
S9-010/011-10-XXXX-0	-10 / -100	5.47 (139)	5.12 (130)	Steel, black
S9-010/011-15-XXXX-0	-15 / -150	7.28 (185)	6.89 (175)	Steel, black

*depends on width-index



Support Tray - Type 02 for Series:

- 3400/3450/3480/3500
- E4-42/H4-42/R4-42
- E4-48L/R4-48L
- E4-56/H4-56/R4-56
- E4-80/H4-80/R4-80
- 14040/14140/R18840
- 14240/14340
- 14550/14650/19050
- 15050/15150/R19850
- 15250/15350
- E6-52/R6-52
- E6-62
- E6-80

Support tray Part No.	Width e-chain®*	Outer trough width B_{Ra} in. (mm)	Inner trough width B_{Ri} in. (mm)	Material
S9-020/021-10-XXXX-0	-10 / -100	6.57 (167)	6.14 (156)	Steel, black
S9-020/021-15-XXXX-0	-15 / -150	8.54 (217)	8.11 (206)	Steel, black
S9-020/021-20-XXXX-0	-20 / -200	10.51 (267)	10.08 (256)	Steel, black
S9-020/021-25-XXXX-0	-25 / -250	12.48 (317)	12.05 (306)	Steel, black

*depends on width-index



Support tray with bracket for easy mounting on your application

For the following Series

System E2/000 Series:

● 2400/2450/2480/2500

● 2600/2650/2680/2700

System E4-1 Series:

● E4-21

● E4-28/R4-28

● E4-32/H4-32/R4-28

System E4-1 Light Series:

● E4-38L/R4-38L

System E6 Series:

● E6-29/R6-29

● E6-35

● E6-40/R6-40

Features & Benefits

- 1 Support Tray Type 01 - Standard length from stock
3.28 ft. (1 m) and 6.56 ft. (2 m)
- 2 All connection rails 38.4" (975 mm)
- 3 Bracket available for easy mounting on your application

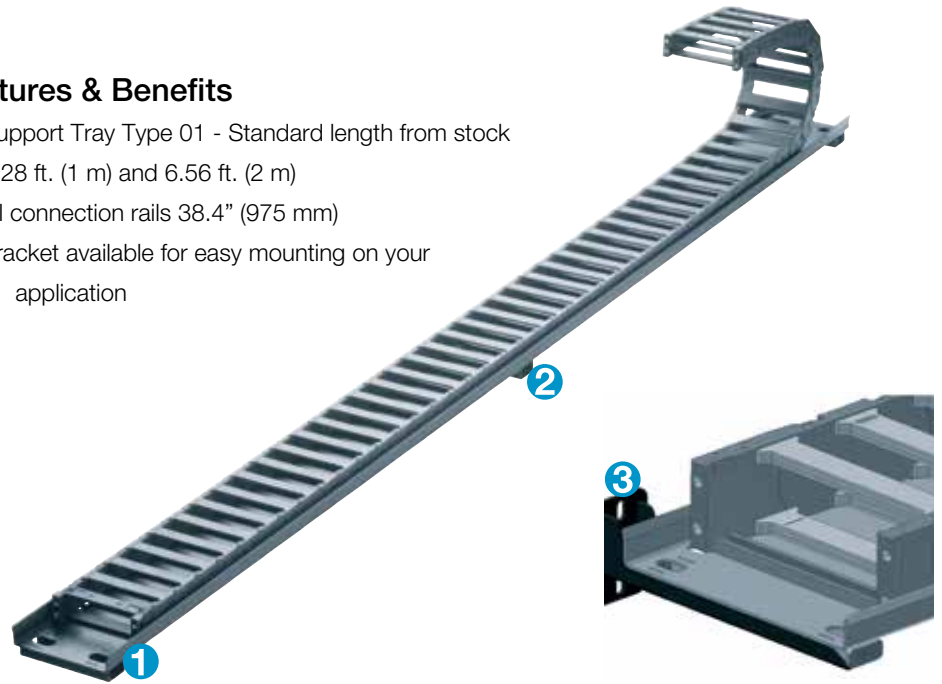

Product Range*

System	Suitable for the following series ▼	Widths- index	B _{Ra} in. (mm)	B _{Ri} in. (mm)	Part No. Support-tray, single	Part No. Support-tray with bracket	Part No. single bracket
E2/000	2400/2450/2480/2500	-05	3.50 (89)	3.15 (80)	S9-010-05-XXXX-0	S9-011-05-XXXX-0	907-724-05
		-07	4.49 (114)	4.13 (105)	S9-010-07-XXXX-0	S9-011-07-XXXX-0	907-724-07
		-10	5.47 (139)	5.12 (130)	S9-010-10-XXXX-0	S9-011-10-XXXX-0	907-724-10
E2/000 E4-1 E4-1 Light	2600/2650/2680/2700 E4-32/H4-32/R4-32 E4-38L/R4-38L	-05	3.50 (89)	3.15 (80)	S9-010-05-XXXX-0	S9-011-05-XXXX-0	907-724-05
		-07	4.49 (114)	(105)	S9-010-07-XXXX-0	S9-011-07-XXXX-0	907-724-07
		-10	5.47 (139)	(130)	S9-010-10-XXXX-0	S9-011-10-XXXX-0	907-724-10
		-15	7.28 (185)	6.89 (175)	S9-010-15-XXXX-0	S9-011-15-XXXX-0	907-724-15
E4-1 E6 E6 E6-1	E4-21 E6-29/R6-29 E6-35 E61-29	-050	3.50 (89)	3.15 (80)	S9-010-05-XXXX-0	S9-011-05-XXXX-0	907-724-05
		-070	4.49 (114)	4.13 (105)	S9-010-07-XXXX-0	S9-011-07-XXXX-0	907-724-07
		-100	5.47 (139)	5.12 (130)	S9-010-10-XXXX-0	S9-011-10-XXXX-0	907-724-10
E4-1 E6	E4-28/R4-28 E6-40/R6-40	-050	3.50 (89)	3.15 (80)	S9-010-05-XXXX-0	S9-011-05-XXXX-0	907-724-05
		-070	4.49 (114)	4.13 (105)	S9-010-07-XXXX-0	S9-011-07-XXXX-0	907-724-07
		-100	5.47 (139)	5.12 (130)	S9-010-10-XXXX-0	S9-011-10-XXXX-0	907-724-10
		-150	7.28 (185)	6.89 (175)	S9-010-15-XXXX-0	S9-011-15-XXXX-0	907-724-15

Please replace [XXXX] by the standard lengths 1000 or 2000 mm available from stock!

*The lengths and widths mentioned here are available from stock in the standard black color. For other lengths, widths and colors, please contact igus®.

Mounting holes of the trough system

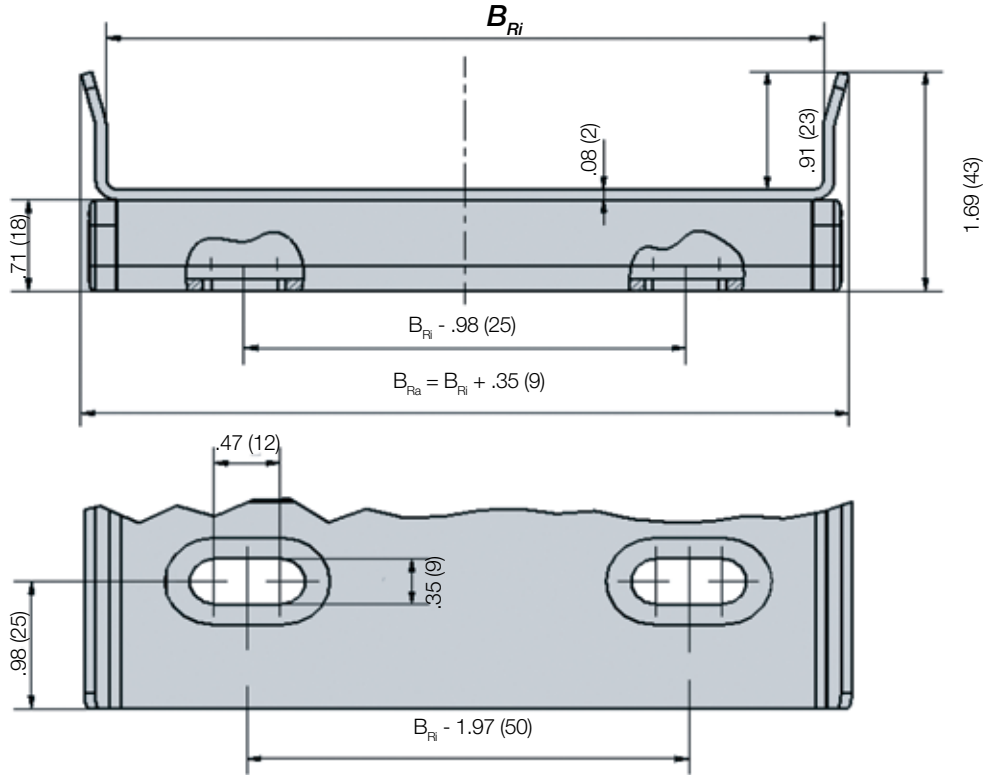

Standard lengths from stock 3.28 ft. and 6.56 ft. (1 m and 2 m) - All connection rails 38.4" (975 mm)
78.7 (2000)



Part No. structure without bracket 39.4" (1000 mm)

S9-	010-	07-	1000-	0
-----	------	-----	-------	---

- Color, powdered black
- Length 1000 mm
- e-chain®- width
- without bracket
- Support tray

Part No. structure with bracket 78.7" (2000 mm)

S9-	011-	07-	2000-	0
-----	------	-----	-------	---

- Color, powdered black
- Length 2000 mm
- e-chain®- width
- with bracket
- Support tray

Bracket - Type 01

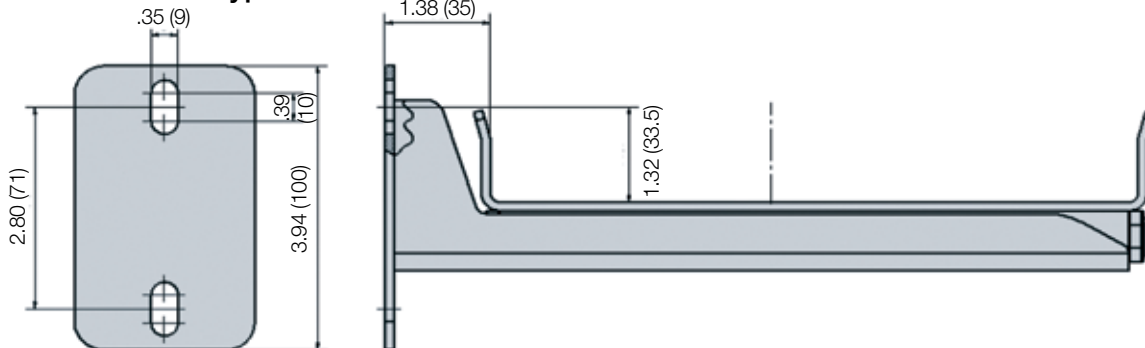

PDF: igus.com/e-chain-pdfs
Product information: igus.com/e-chains

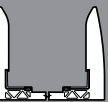
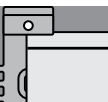
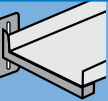

For the following Series

System E2/000 Series:

- 3400/3450/3480/3500

System E4-1 Series:

- E4-42/H4-42/R4-42
- E4-56/H4-56/R4-56
- E4-80/H4-80/R4-80

System E4-1 Light Series:

- E4-48L/R4-48L

System E4/Light Series:

- 14040/14140/R18840
- 14240/14340
- 14550/14650/19050
- 15050/15150/R19850
- 15250/15350

System E6 Series:

- E6-52/R6-52
- E6-62
- E6-80

Features & Benefits

- 1 Support Tray Type 01 - Standard length from stock 3.28 ft. (1 m) and 6.56 ft. (2 m)
- 2 All connection rails 38.4" (975 mm)
- 3 Bracket available for easy mounting on your application

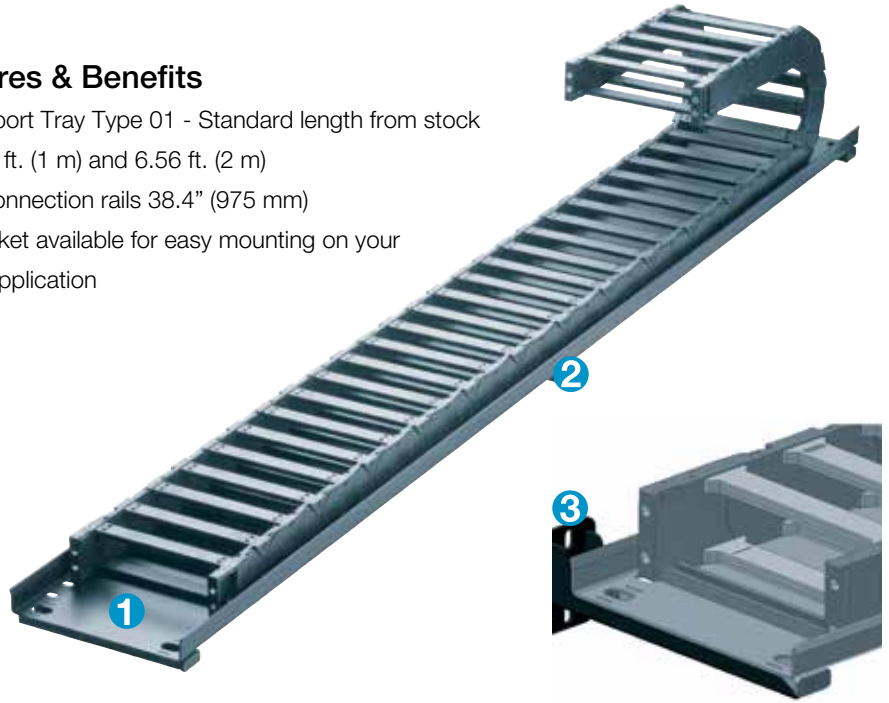

Product Range*

System	Suitable for the following series ▼	Widths-index	B _{Ra} in. (mm)	B _{Ri} in. (mm)	Part No. Support-tray, single	Part No. Support-tray with bracket	Part No. single bracket
E4-1	E4-42/H4-42/R4-42 E4-56/H4-56/R4-56 E4-80/H4-80/R4-80	-10	6.57 (167)	6.14 (156)	S9-020-10-XXXX-0	S9-021-10-XXXX-0	907-759-10-0
		-15	8.54 (217)	8.11 (206)	S9-020-15-XXXX-0	S9-021-15-XXXX-0	907-759-15-0
		-20	10.51 (267)	10.08 (256)	S9-020-20-XXXX-0	S9-021-20-XXXX-0	907-759-20-0
		-25	12.48 (317)	12.05 (306)	S9-020-25-XXXX-0	S9-021-25-XXXX-0	907-759-25-0
E4-1 Light E4/light	E4-42/H4-42/R4-42 14040/14140/R18840 14240/14340 14550/14650/19050 15050/15150/R19850						
E6	E6-62, E6-80						
E4/00 E6	3400/3450/3480/3500 E6-52/R6-52	-100	6.57 (167)	6.14 (156)	S9-020-10-XXXX-0	S9-021-10-XXXX-0	907-759-10
		-150	8.54 (217)	8.11 (206)	S9-020-15-XXXX-0	S9-021-15-XXXX-0	907-759-15
		-200	10.51 (267)	10.08 (256)	S9-020-20-XXXX-0	S9-021-20-XXXX-0	907-759-20
		-250	12.48 (317)	12.05 (306)	S9-020-25-XXXX-0	S9-021-25-XXXX-0	907-759-25

Please replace **XXXX** by the standard lengths 1000 or 2000 mm available from stock!

*The lengths and widths mentioned here are available from stock in the standard black color. For other lengths, widths and colors, please contact igus®.



Mounting holes of the trough system

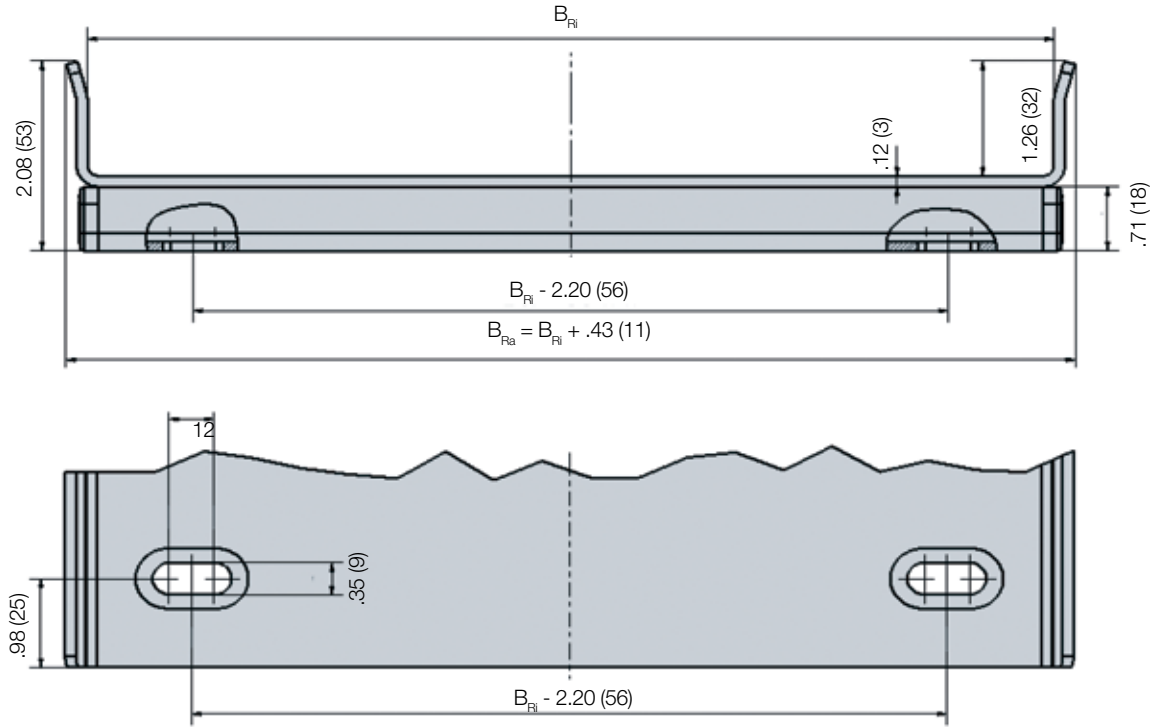

Standard lengths from stock 3.28 ft. and 6.56 ft. (1 m and 2 m) - All connection rails 38.4" (975 mm)

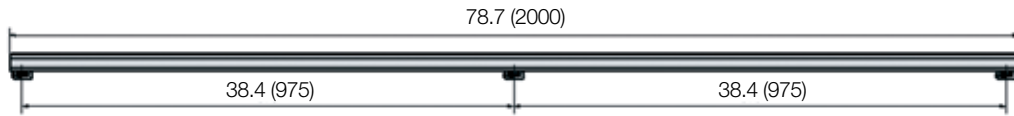

Part No. structure without bracket 39.4" (1000 mm)

S9-	020-	20-	1000-	0
-----	------	-----	-------	---

- Color, powdered black
- Length 1000 mm
- e-chain®- width
- without bracket
- Support tray

Part No. structure with bracket 78.7" (2000 mm)

S9-	021-	20-	2000-	0
-----	------	-----	-------	---

- Color, powdered black
- Length 2000 mm
- e-chain®- width
- with bracket
- Support tray

Bracket - Type 02

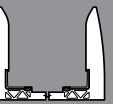
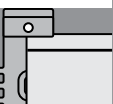
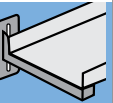
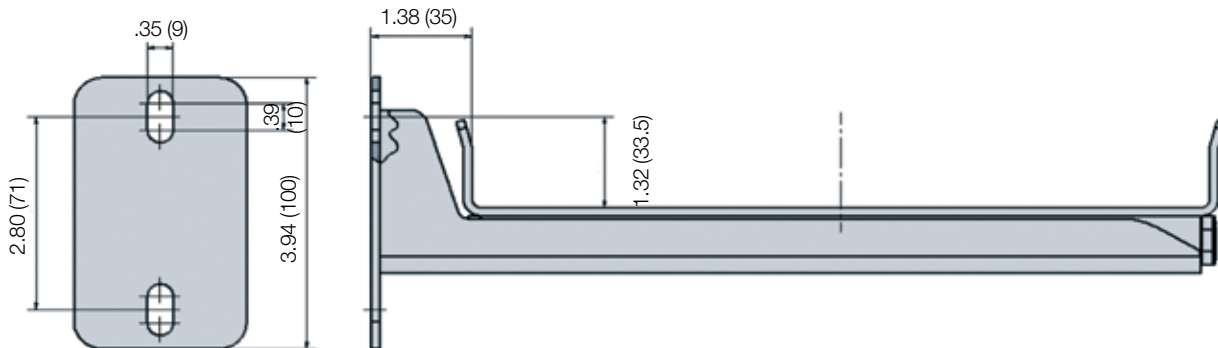

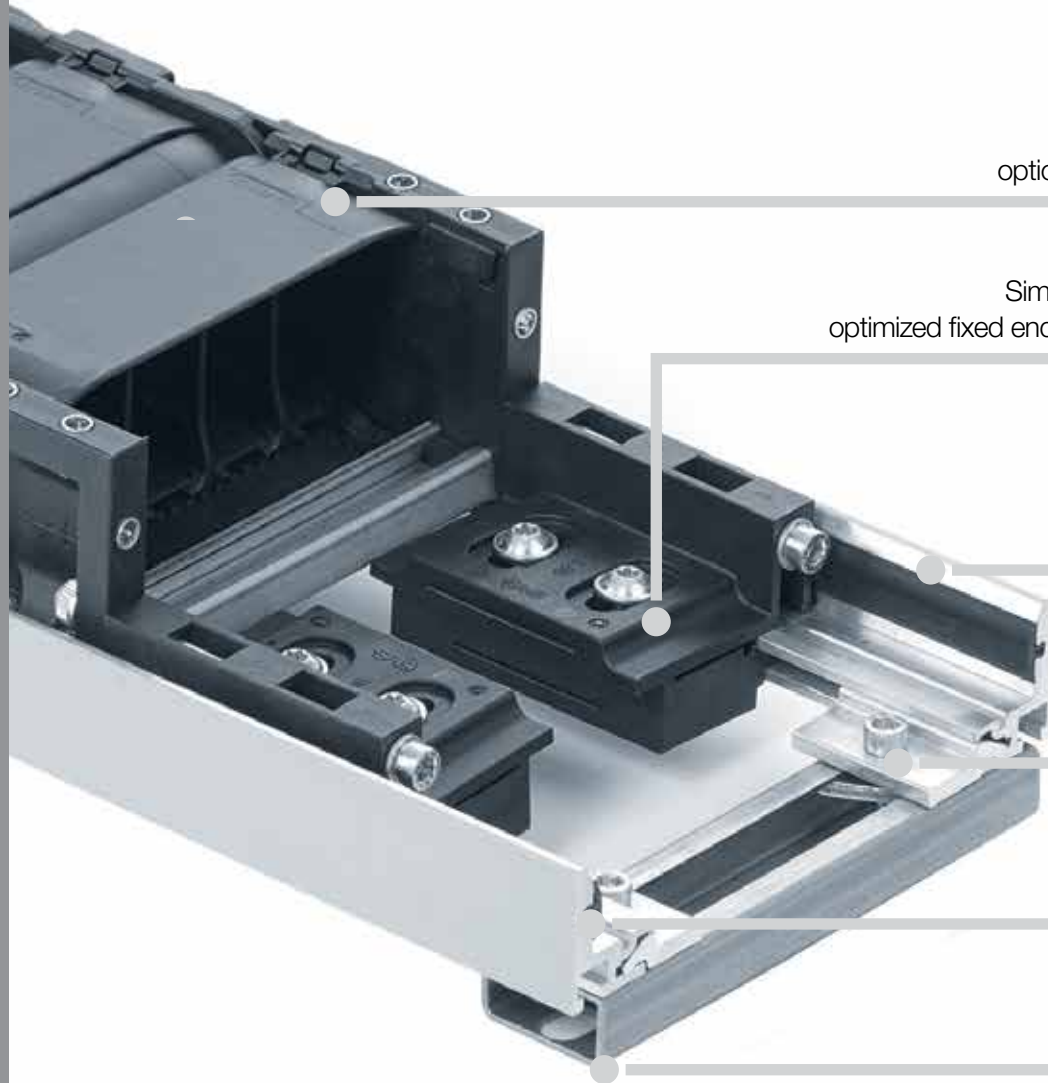

Noise-reducing:
optional rubber silencer profile

Simple e-chain® connection:
optimized fixed end module made of plastic

Wear-reducing:
glide strips protect from
wear on the sides

Easy installation:
with standard clamps,
basic version

Corrosion-resistant:
seawater-resistant
aluminum profile

Variable widths:
easy adaptation of the
width to a profile rail

The flexible construction kit to support the lower run - aluminum support tray

The design of this aluminum support tray emulates the igus® aluminum SuperTrough. This modular construction kit covers the standard sizes of our e-chains®. Because of its flexible width adjustment using installation sets with profile rails, the aluminum support tray is used with various e-chains® series and widths. A support trough consists of 2 trough side pieces with 2m length. Standard installation sets can be used, just as for the aluminum SuperTrough.

- Corrosion-resistant, seawater-resistant aluminum profile
- Wear-reducing glide strips integrated as standard
- Quiet movement of the e-chain® with optional silencer profile
- Simple assembly on flexible width profile rails with basic clamps
- e-chain® easily connects to aluminum support tray using plastic fixed end modules
- Open guide trough design, debris can fall through
- Conductivity according to DIN EN 61537 - as standard

Aluminum Support Tray Selection Table



Part No. without silencer profile	Part No. with silencer profile	Outer height H_{Ra} in. (mm)	Part No. installation set	Side part material
 <p>Aluminum support tray available with and without silencer profile</p> <p>For the following systems:</p> <ul style="list-style-type: none"> ● E2/000 ● R2-1 ● E4-1L ● E4-1 ● E6-1 ● E6 				
9AT-35-SL	9AT-35-SLA	1.38 (35)	960AT-30-XXX*	aluminum

*XXX = profile rail length



Available from stock. Ready to ship in 24 - 48hrs.*

*The delivery times indicated correspond to the average time until the ordered goods are dispatched.



An aluminum support tray consists of two 2 trough side pieces each with 6.56 ft. (2m) long

PDF: igus.com/e-chain-pdfs
Product information: igus.com/e-chains

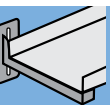

Components, guide troughs and components, mounting kits

Components

- ❶ Trough side parts, aluminum, 6.56 ft. (2m)
- ❷ Glide strip, plastic, 6.56 ft (2m)
- ❸ Optional: rubber silencer profile

- A Bottom clamp, aluminum
- B Profile rail¹⁾, galvanized steel
- C Allen wrench
- D Sliding nut

- Ba = e-chain® outer width
- Bi = e-chain® inner width
- ha = e-chain® outer height
- H_{Ri} = Trough inner height
- H_{Ra} = Trough outer height
- B_{Ri} = Trough inner width
- B_{Ra} = Trough outer width

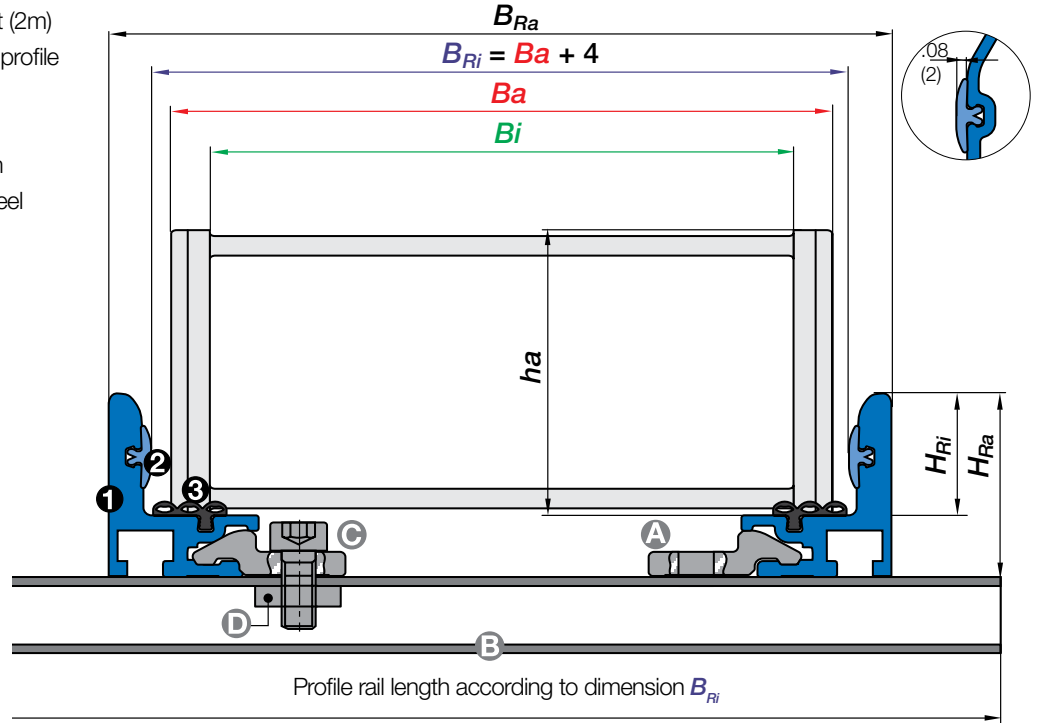

1) Profile rail also available in 304 stainless steel. Material 1.4301 (AISI 304)

Aluminum support tray | Features

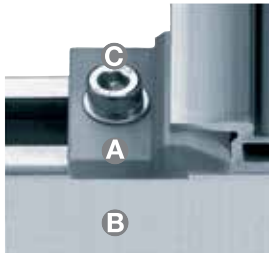

Simple fastening with basic bottom clamp and profile rail

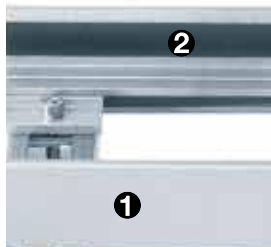

Wear-reducing glide strips



Noise-reducing with silencer profile option



Simple connection to the e-chain® with the fixed end module

Order example | Based on Part No. 9AT-35-SLA



Order key
guide trough

9AT-35-SLA

- Trough system
- Aluminum support tray
- Outer height
- With glide strip
- With silencer profile



Order key
installation set 960AT-30-125

- Installation set
- Size of bottom clamp
- Length of Profile rail

Quick and simple fixing onto the support tray

Fixed end module - to attach the e-chain® into the aluminum support tray

- Mounting bracket attachment on the aluminum support tray without drilling
- Fixed end module is clamped to the trough
- Save installation time
- Minimize errors from drilling holes
- Stainless and cost-effective

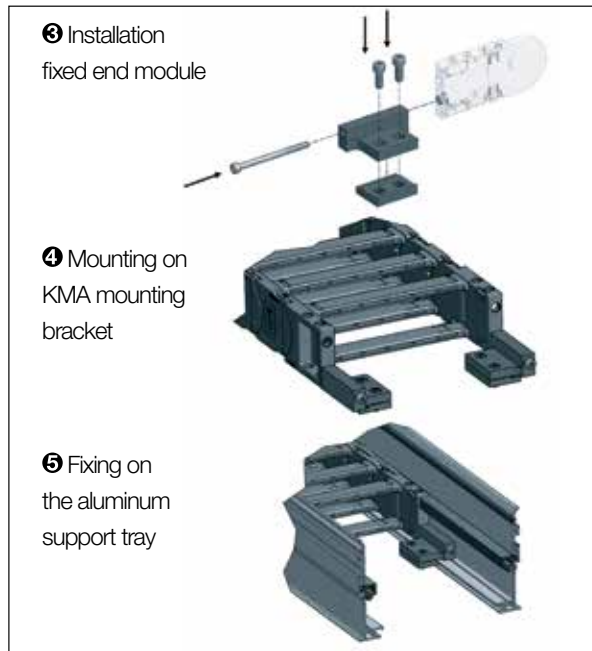
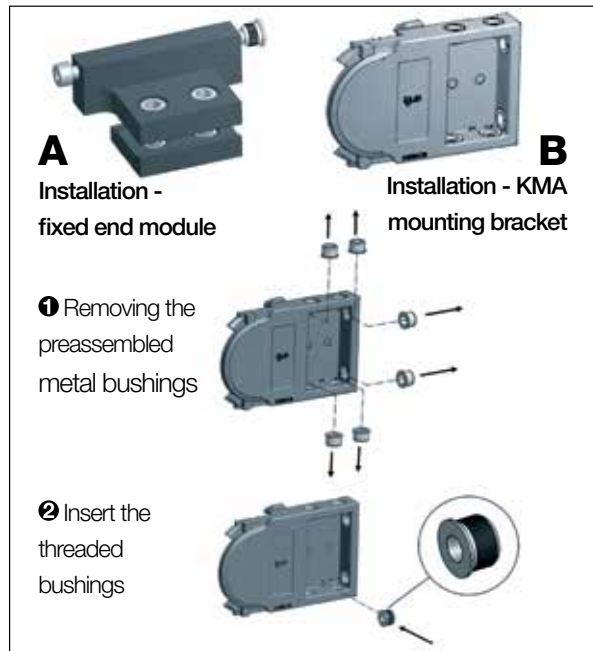

Fixed end module | Fixed end clamp | Product range

Series	For aluminum support tray	For e-chain® series	From inner width <i>Bi</i> in. (mm)	Mounting bracket
971-80-4 ¹⁾	9AT-35-SL 9AT-35-SLA	2400/2500/2450/2480, E6-29, EF61-29/E61-29	.003 (.07)	KMA
972-80-4 ¹⁾	9AT-35-SL 9AT-35-SLA	E4-28/R4-28, E4-31L/R4-31L, E6-35, E61-35	.002 (.06)	KMA
972-80-4 ¹⁾	9AT-35-SL 9AT-35-SLA	E4-32/H4-32/R4-32, E4-38L/R4-38L, E6-40/R6-40, E61-40	.002 (.06)	KMA
972-80-4 ¹⁾	9AT-35-SL 9AT-35-SLA	2600/2700/2650/2680	.002 (.06)	KMA

More series available upon request

1) Material: plastic. Material screw kits: standard steel, galvanized. Option: 316 stainless steel, material 1.4571 (AISI 316Ti), standard steel, galvanized.

Available from stock. Ready to ship in 24 - 48hrs.*

*The delivery times indicated correspond to the average time until the ordered goods are dispatched.

PDF: igus.com/e-chain-pdfs
Product information: igus.com/e-chains

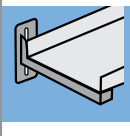



For the following
igus® series

E2/000

● 2400/2500/2450/2480

● 2600/2700/2650/2680

E4-1L

● E4-31L/R4-31L

● E4-38L/R4-38L

E4-1

● E4-28/R4-28

● E4-32/H4-32/R4-32

E6-1

● EF61-29/E61-29

● E61-35

● E61-40

E6

● E6-29

● E6-35

● E6-40/R6-40

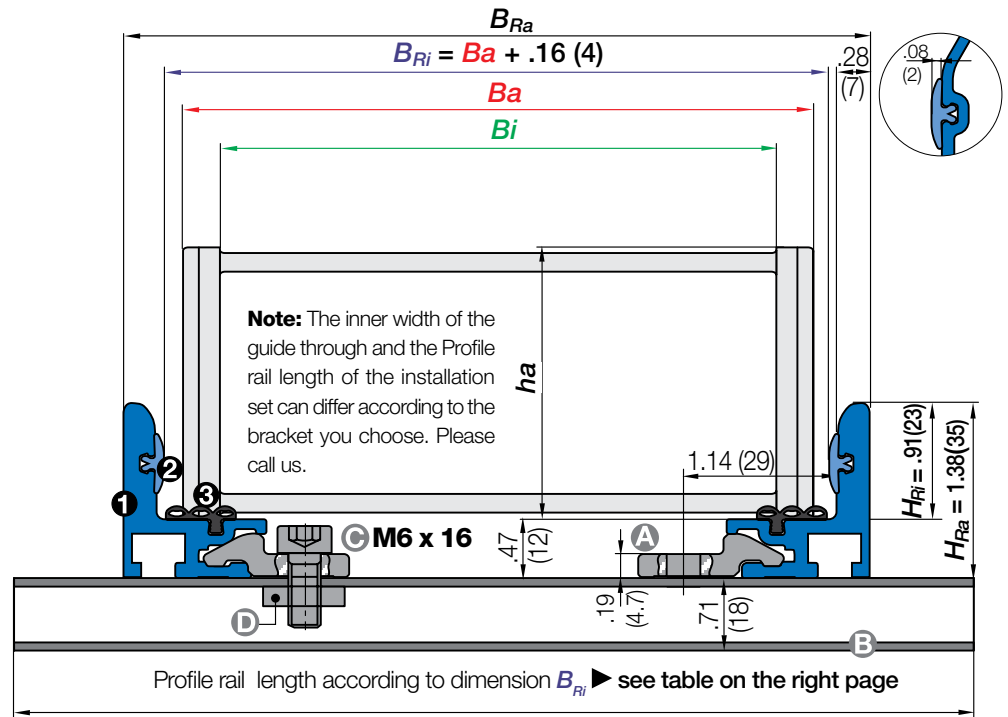

Aluminum support tray | Full set

Trough side parts sets - consisting of part ① | ② | ③

	Part No.	Weight
1 set of 2 trough side parts, incl. glide strips, without silencer profile, 6.56 ft. (2m) section	9AT-35-SL	≈ 3.470kg
1 set of 2 trough side parts, incl. glide strips, with silencer profile, 6.56 ft. (2m) section	9AT-35-SLA	≈ 3.714kg

Installation sets A | B | C | D

	Part No.	Weight
1 installation set without Profile rail	960-30	upon request
1 installation set with Profile rail (Profile rail length according to dimension B_{Ri})	960AT-30-XXX*	upon request

*Please add the Profile rail length **XXX** as shown on the tables on the right page. Example: 960AT-30-150

Aluminum support tray | Components as individual parts

Individual parts, trough

	Part No.	Weight
① 1 trough side part, individual, 6.56 ft. (2m) section	9AT-35-11	≈ 1.673kg
② 1 glide strip, plastic, individual, 6.56 ft. (2m) section	75-01	≈ 0.062kg
③ 1 silencer profile, rubber, individual, 6.56 ft. (2m) section (optional for an additional noise dampening)	75-67-H-2000	≈ 0.122kg

Individual parts, installation set

	Part No.	Weight
A 1 bottom clamp, individual	75-40	≈ 0.03kg
B 1 Profile rail, individual (Profile rail length according to dimension B_{Ri})	92-52-XXX-E*	≈ 0.90kg/m
C 1 screw M6 x 16, individual	MAT 0040209 / M6 x16	
D 1 glide nut, individual	MAT 0040057 / M6	

Additional option for simple fastening of the e-chain® without drilling

Part No.
971-80-4 / 972-80-4

Aluminum Support Tray

Profile Rail Lengths

For aluminum support tray with fixed end module



Support
Tray

2400 / 2500 / 2450 / 2480

Width Index	B_{Ri} in. (mm)	Part No. attached inwards
-07	3.82 (97)	960AT-30-150
-09	4.29 (109)	960AT-30-175
-10	4.84 (123)	960AT-30-175
-12	5.71 (145)	960AT-30-200

2600 / 2700 / 2650 / 2680

Width Index	B_{Ri} in. (mm)	Part No. attached inwards
-06	3.35 (85)	960AT-30-150
-07	3.74 (95)	960AT-30-150
-09	4.33 (110)	960AT-30-175
-10	4.72 (120)	960AT-30-175
-12	5.71 (145)	960AT-30-200
-15	6.69 (170)	960AT-30-225
-17	7.79 (198)	960AT-30-250

E4-38L / R4-38L

Width Index	B_{Ri} in. (mm)	Part No. attached inwards
-062	3.23 (82)	960AT-30-150
-075	3.74 (95)	960AT-30-150
-087	4.21 (107)	960AT-30-175
-100	4.72 (120)	960AT-30-175
-105	4.92 (125)	960AT-30-175
-112	5.20 (132)	960AT-30-200
-125	5.71 (145)	960AT-30-200
-137	6.18 (157)	960AT-30-225
-150	6.69 (170)	960AT-30-225
-162	7.17 (182)	960AT-30-250
-175	7.68 (195)	960AT-30-250
-187	8.15 (207)	960AT-30-275
-200	8.66 (220)	960AT-30-275
-212	9.13 (232)	960AT-30-300
-225	9.65 (245)	960AT-30-300
-237	10.12 (257)	960AT-30-325
-250	10.63 (270)	960AT-30-325
-262	11.10 (282)	960AT-30-325
-275	11.61 (295)	960AT-30-350
-287	12.09 (307)	960AT-30-350
-300	12.60 (320)	960AT-30-375
-312	13.07 (332)	960AT-30-375
-325	13.58 (345)	960AT-30-400
-337	14.06 (357)	960AT-30-400
-350	14.57 (370)	960AT-30-425
-362	15.04 (382)	960AT-30-450
-375	15.55 (395)	960AT-30-450
-387	16.02 (407)	960AT-30-450
-400	16.54 (420)	960AT-30-475

E4-28/R4-28

Width Index	B_{Ri} in. (mm)	Part No. attached inwards
-062	3.39 (86)	960AT-30-150
-070	3.31 (94)	960AT-30-150
-075	3.90 (99)	960AT-30-175
-087	4.37 (111)	960AT-30-175
-100	4.88 (124)	960AT-30-200
-125	5.87 (149)	960AT-30-200
-150	6.85 (174)	960AT-30-200
-175	7.83 (199)	960AT-30-225
-200	8.82 (224)	960AT-30-225
-225	9.80 (249)	960AT-30-250
-250	10.78 (274)	960AT-30-250
-275	11.77 (299)	960AT-30-250
-300	12.76 (324)	960AT-30-275

E4-32 / H4-32 / R4-32

Width Index	B_{Ri} in. (mm)	Part No. attached inwards
-06	3.74 (95)	960AT-30-150
-07	4.02 (102)	960AT-30-150
-087	4.49 (114)	960AT-30-175
-10	5.00 (127)	960AT-30-175
-11	5.31 (135)	960AT-30-200
-112	5.51 (140)	960AT-30-200
-12	5.98 (152)	960AT-30-200
-137	6.50 (165)	960AT-30-225
-15	6.97 (177)	960AT-30-225
-162	7.48 (190)	960AT-30-250
-17	7.68 (195)	960AT-30-250
-18	7.95 (202)	960AT-30-250
-187	8.46 (215)	960AT-30-275
-20	8.94 (227)	960AT-30-275
-212	9.45 (240)	960AT-30-300
-23	9.92 (252)	960AT-30-300
-237	10.43 (265)	960AT-30-325
-25	10.91 (277)	960AT-30-325
-262	11.42 (290)	960AT-30-350
-28	11.89 (302)	960AT-30-350
-29	12.40 (315)	960AT-30-375
-30	12.87 (327)	960AT-30-375
-312	13.39 (340)	960AT-30-400
-325	13.86 (352)	960AT-30-400
-337	14.37 (365)	960AT-30-425
-350	14.84 (377)	960AT-30-425
-362	15.35 (390)	960AT-30-450
-375	15.83 (402)	960AT-30-450
-387	16.34 (415)	960AT-30-475
-400	16.81 (427)	960AT-30-475

E4-31L / R4-31L

Width Index	B_{Ri} in. (mm)	Part No. attached inwards
-062	3.15 (80)	960AT-30-150
-075	3.66 (93)	960AT-30-150
-087	4.13 (105)	960AT-30-175
-100	4.65 (118)	960AT-30-175
-112	5.12 (130)	960AT-30-200
-125	5.63 (143)	960AT-30-200
-137	6.10 (155)	960AT-30-225
-150	6.61 (168)	960AT-30-225
-162	7.09 (180)	960AT-30-250
-175	7.60 (193)	960AT-30-250
-187	8.07 (205)	960AT-30-275
-200	8.58 (218)	960AT-30-275

E6-40 / R6-40/ E61-40

Width Index	B_{Ri} in. (mm)	Part No. attached inwards
-062	3.39 (86)	960AT-30-150
-070	3.70 (94)	960AT-30-150
-075	3.90 (99)	960AT-30-150
-087	4.37 (111)	960AT-30-175
-100	4.88 (124)	960AT-30-175
-125	5.87 (149)	960AT-30-200
-150	6.85 (174)	960AT-30-225
-175	7.83 (199)	960AT-30-250
-200	8.82 (224)	960AT-30-275
-225	9.80 (249)	960AT-30-300
-250	10.78 (274)	960AT-30-325
-275	11.77 (299)	960AT-30-350
-300	12.76 (324)	960AT-30-375

E6-29 /R6-29 / EF61-29 / E61-29

Width Index	B_{Ri} in. (mm)	Part No. attached inwards
-070	3.54 (90)	960AT-30-150
-080	3.94 (100)	960AT-30-150
-090	4.33 (110)	960AT-30-175
-100	4.72 (120)	960AT-30-175
-110	5.12 (130)	960AT-30-200
-120	5.51 (140)	960AT-30-200

E6-35/ E61-35

Width Index	B_{Ri} in. (mm)	Part No. attached inwards
-060	3.31 (84)	960AT-30-150
-070	3.70 (94)	960AT-30-150
-080	4.09 (104)	960AT-30-150
-090	4.49 (114)	960AT-30-175
-100	4.88 (124)	960AT-30-175
-110	5.28 (134)	960AT-30-200
-120	5.67 (144)	960AT-30-200

PDF: igus.com/e-chain-pdfs
Product information: igus.com/e-chains

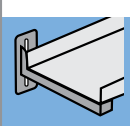

Guidefast Guide Trough

Introduction - Advantages

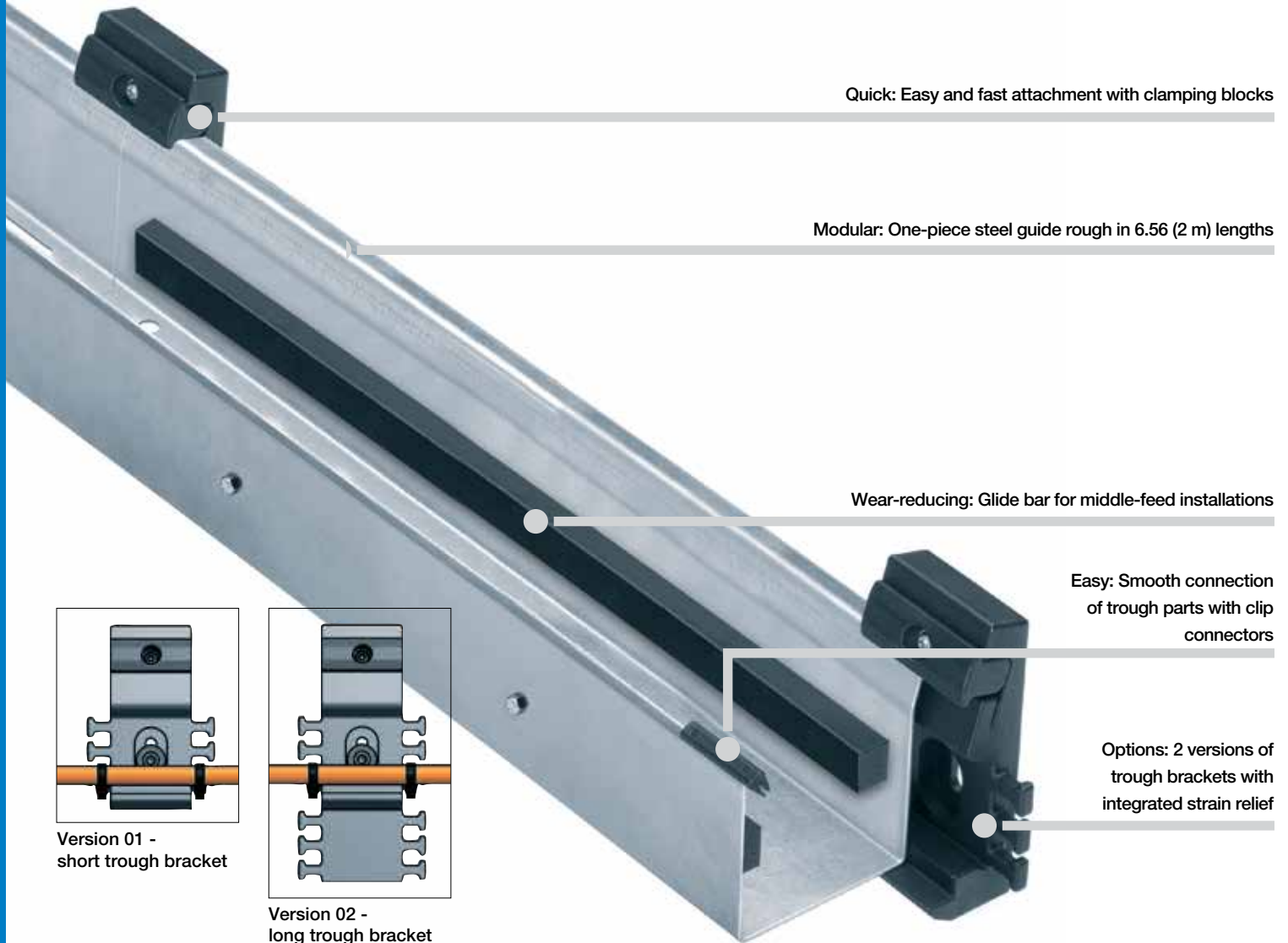

Quick: Easy and fast attachment with clamping blocks

Modular: One-piece steel guide rough in 6.56 (2 m) lengths

Wear-reducing: Glide bar for middle-feed installations

Easy: Smooth connection of trough parts with clip connectors

Options: 2 versions of trough brackets with integrated strain relief

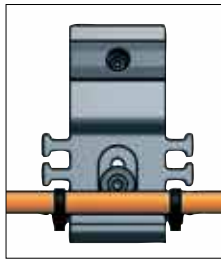

Version 01 - short trough bracket

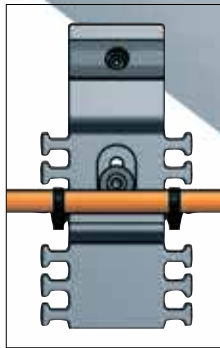

Version 02 - long trough bracket

Quickly installed as a modular kit solution for crane girders and indoor cranes

The guidefast guide trough is mounted on the side of the crane girder, in case of installation on crane girders, the welding of brackets onto the girder can be omitted. Installation time is kept very short, the guide trough is only attached to the previously installed brackets and then fixed with clamping blocks. The small amount of different components and trough design contribute to a simple installation.

- Save up to 80% installation time compared to standard trough systems
- Fits virtually any standard crane girder
- 2 versions of brackets with integrated strain relief for assembly of static cables on the crane girder - possible $\pm .20$ " (5 mm) vertical adjustment of brackets
- Standard trough length of 6.56 ft. (2.0 m) - with or without glide bar
- Suitable for any side-mounted application - not only on cranes
- Easy to install due to preassembled hole patterns of e-chain® brackets
- Standard material: galvanized steel, optional: stainless steel V2A, material 1.4301 (AISI 304) or black powder coating
- Long-term tested to withstand vibration and rough environment

Typical industries and applications

- Crane manufacturers (mainly indoor cranes)
- Applications where the lateral installation of the guide trough is beneficial

Guidefast Guide Trough Selection Table



Guidefast - without glide bar for E2/000 Series:

- 1500
- 2500
- 2700

Trough profile Part No.	For E2/000 e-chain®	Inner trough width B_{Rl} in. (mm)	Complete width in. (mm)	Material
GF91-30-025-2000	1500-025-	1.67 (42.5)	3.19 (81)	Galvanized steel*
GF91-30-050-2000	1500-050-	2.66 (67.5)	4.17 (106)	Galvanized steel*
GF92-30-03-2000	2500-03-	2.28 (58)	3.80 (96.5)	Galvanized steel*
GF92-30-05-2000	2500-05-	3.03 (77)	4.55 (115.5)	Galvanized steel*
GF92-30-07-2000	2500-07-	3.82 (97)	5.33 (135.5)	Galvanized steel*
GF92-30-09-2000	2500-09-	4.29 (109)	5.73 (145.5)	Galvanized steel*
GF92-30-10-2000	2500-10-	4.84 (123)	6.36 (161.5)	Galvanized steel*
GF95-30-05-2000	2700-05-	2.76 (70)	4.27 (108.5)	Galvanized steel*
GF95-30-07-2000	2700-07-	3.89 (96)	5.26 (133.5)	Galvanized steel*
GF95-30-10-2000	2700-10-	4.72 (120)	6.24 (158.5)	Galvanized steel*

*Standard material: Galvanized steel. Also available as stainless steel version V2A, material 1.4301 (AISI 304) or black powder coating



Guidefast - with glide bar for E2/000 Series:

- 1500
- 2500
- 2700

Support tray Part No.	For E2/000 e-chain®	Inner trough width B_{Rl} in. (mm)	Complete width in. (mm)	Material
GF91-31-025-2000	1500-025-	1.67 (42.5)	3.19 (81)	Galvanized steel*
GF91-31-050-2000	1500-050-	2.66 (67.5)	4.17 (106)	Galvanized steel*
GF92-31-03-2000	2500-03-	2.28 (58)	3.80 (96.5)	Galvanized steel*
GF92-31-05-2000	2500-05-	3.03 (77)	4.55 (115.5)	Galvanized steel*
GF92-31-07-2000	2500-07-	3.82 (97)	5.33 (135.5)	Galvanized steel*
GF92-31-09-2000	2500-09-	4.29 (109)	5.73 (145.5)	Galvanized steel*
GF92-31-10-2000	2500-10-	4.84 (123)	6.36 (161.5)	Galvanized steel*
GF95-31-05-2000	2700-05-	2.76 (70)	4.27 (108.5)	Galvanized steel*
GF95-31-07-2000	2700-07-	3.89 (96)	5.26 (133.5)	Galvanized steel*
GF95-31-10-2000	2700-10-	4.72 (120)	6.24 (158.5)	Galvanized steel*



Support tray with bracket for easy mounting on your application

For the following Series

System E2/000 Series:

- 1500
- 2500
- 2700

Components - Set guidefast guide trough

- ❶ Trough profile, 6.56 ft. (2 m) section
- ❷ Glide bar, 6.56 ft. (2 m) section, optional
- ❸ Clip connector, Part No. 908-467

Components - Set trough bracket

- ❶ Version 01 - short trough bracket
- ❷ Version 02 - long trough bracket
- ❸ Clamping blocks, Part No. G9-2-10

Ba = Outer e-chain® width

Bi = Inner e-chain® width

ha = e-chain® outer height

B_{Ri} = Inner trough width = $B_{Ri} = Ba + 4$

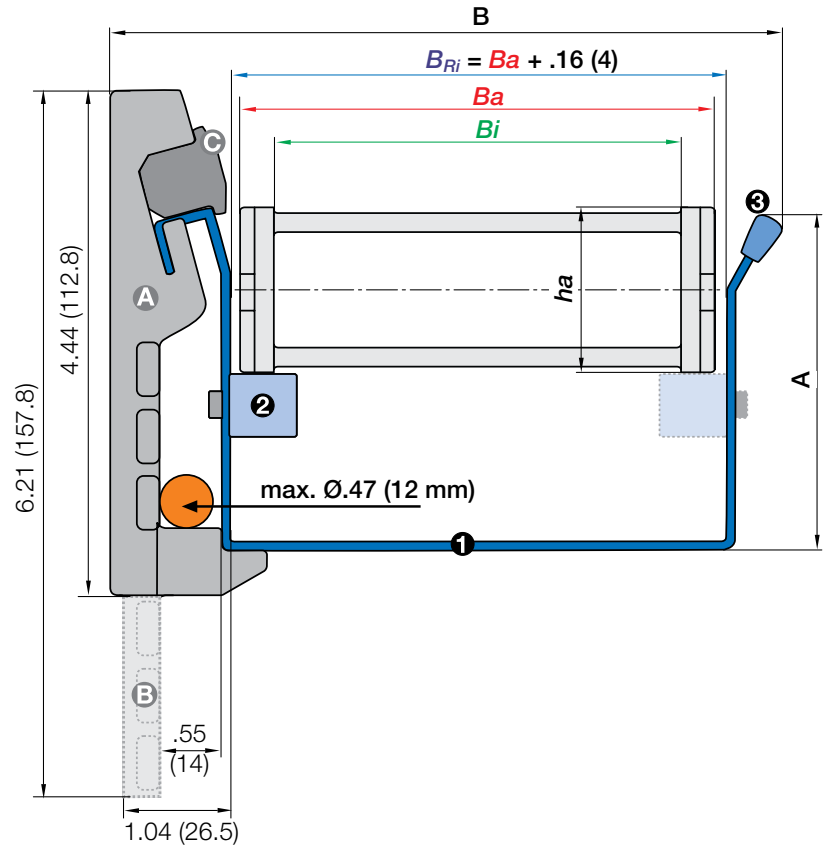

2 Versions of trough brackets with integrated strain relief

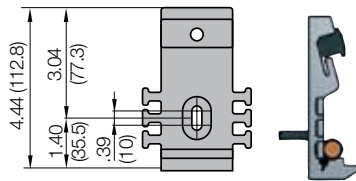

Version 01 - short trough bracket Part No. GF9.2.12 with integrated strain relief, possible ± .20" (5 mm) vertical adjustment

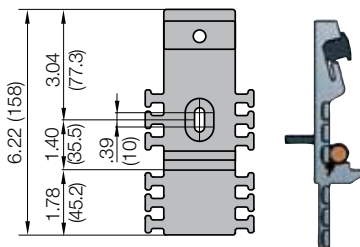

Version 02 - long trough bracket Part No. GF9-2-11 with integrated strain relief, possible ± .20" (5 mm) vertical adjustment

Guidefast Guide Trough Product Range



Guide-
fast

For E2/000 e-chain®	Trough Profile* without glide bar <small>includes clip connectors</small>	Trough profile* with glide bar	Short Bracket Version 01 <small>includes clamping blocks</small>	Long Bracket Version 02	Inner trough width B_{Ri}	Dim. A in. (mm)	Dim. B in. (mm)
1500-025- ▶	GF91-30-025-2000	GF91-31-025-2000	GF9-2-12	GF9-2-11	1.67 (42.5)	2.40 (61)	3.19 (81)
1500-050- ▶	GF91-30-050-2000	GF91-31-050-2000	GF9-2-12	GF9-2-11	2.66 (67.5)	2.40 (61)	4.17 (106)
2500-03- ▶	GF92-30-03-2000	GF92-31-03-2000	GF9-2-12	GF9-2-11	2.28 (58)	2.95 (75)	3.82 (97)
2500-05- ▶	GF92-30-05-2000	GF92-31-05-2000	GF9-2-12	GF9-2-11	3.03 (77)	2.95 (75)	4.55 (115.5)
2500-07- ▶	GF92-30-07-2000	GF92-31-07-2000	GF9-2-12	GF9-2-11	3.82 (97)	2.95 (75)	5.33 (135.5)
2500-09- ▶	GF92-30-09-2000	GF92-31-09-2000	GF9-2-12	GF9-2-11	4.29 (109)	2.95 (75)	5.83 (148)
2500-10- ▶	GF92-30-10-2000	GF92-31-10-2000	GF9-2-12	GF9-2-11	4.84 (123)	2.95 (75)	6.36 (161.5)
2700-05- ▶	GF95-30-05-2000	GF95-31-05-2000	GF9-2-12	GF9-2-11	2.76 (70)	4.13 (105)	4.27 (108.5)
2700-07- ▶	GF95-30-07-2000	GF95-31-07-2000	GF9-2-12	GF9-2-11	3.89 (96)	4.13 (105)	5.26 (133.5)
2700-10- ▶	GF95-30-10-2000	GF95-31-10-2000	GF9-2-12	GF9-2-11	4.72 (120)	4.13 (105)	6.24 (158.5)

*Standard material: Galvanized steel. Also available as stainless steel version V2A, material 1.4301 (AISI 304) or black powder coating

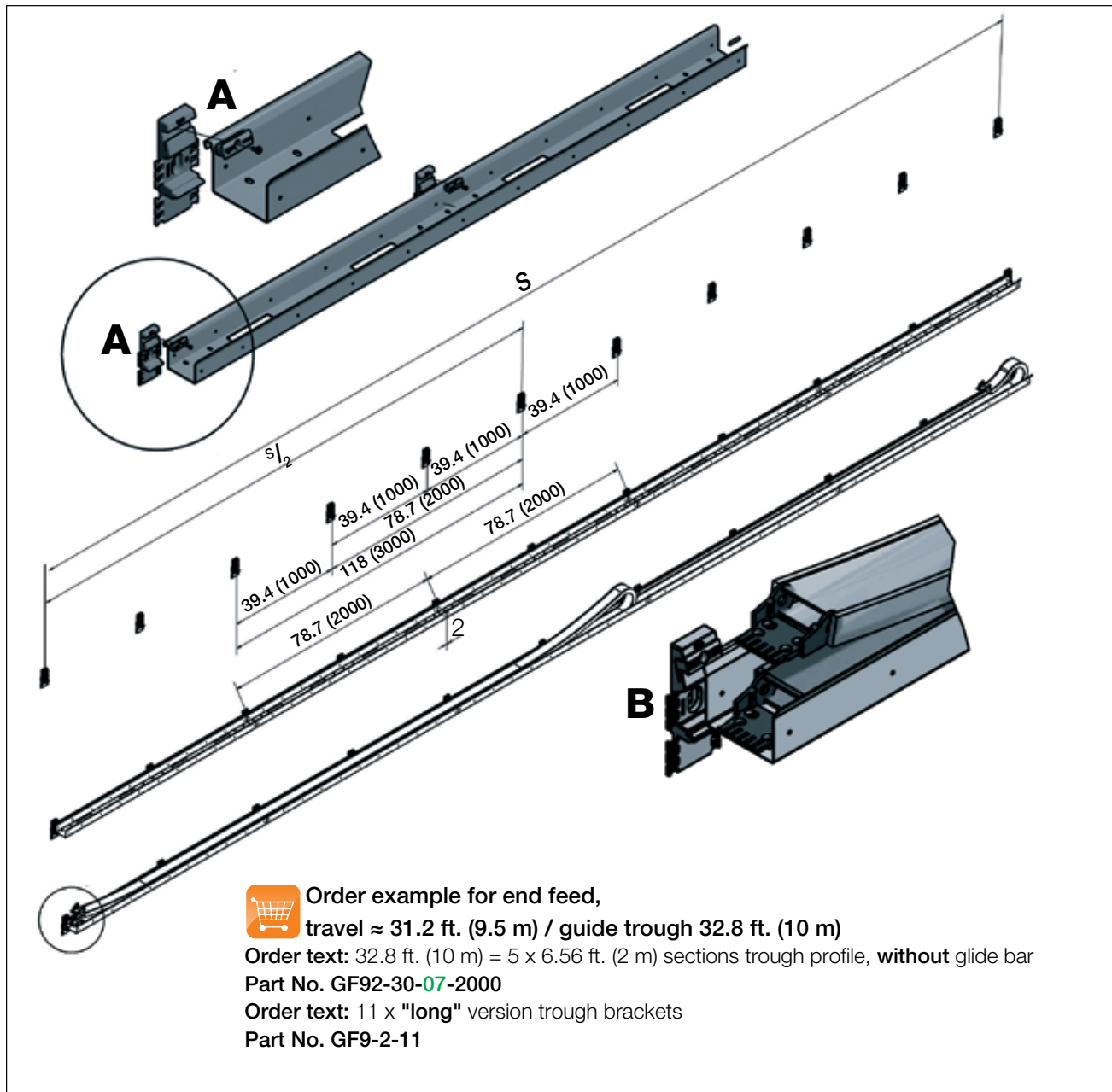

PDF: igus.com/e-chain-pdfs
 Product information: igus.com/e-chains

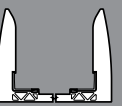
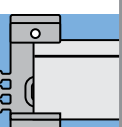
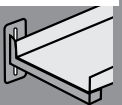

Guidelite Guide Trough

Introduction - Advantages

Corrosion-resistant:
Made completely from plastic components

Cost-effective:
Construction kit solution with e-chain®

Save time:
Easy and fast assembly

2 Versions installation sets:
01) with crossbar for a fixed width or
02) profile rail for a larger range of widths

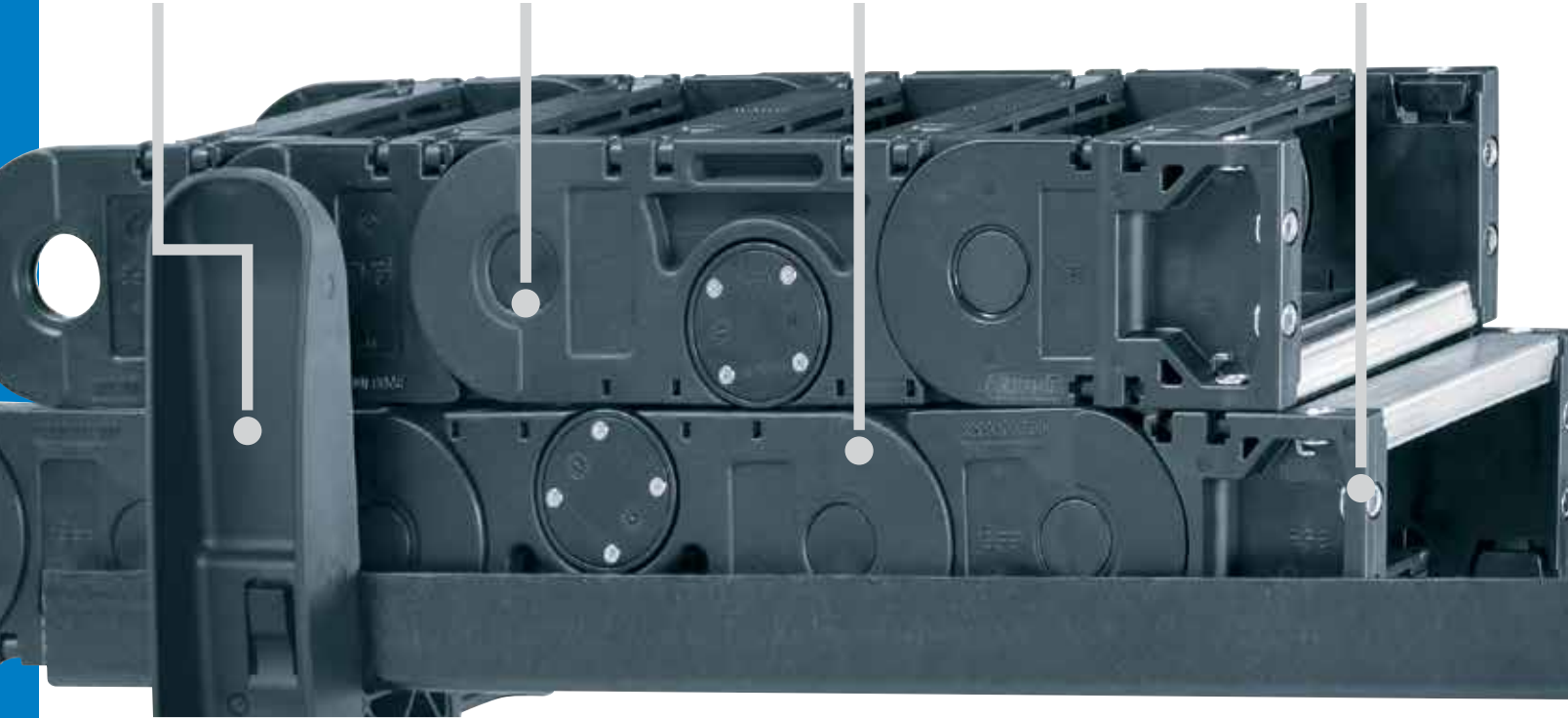

Realize long travels up to 492 ft. (150 m), quick and cost-effective - Guidelite

As construction kit system primarily for slow applications with low cycle counts. The lower run of the e-chain® is guided in two L-shaped guide rails made from fiberglass reinforced plastics. The upper run of the e-chain® is partially guided by guide angle brackets that are installed at distances of 3.28 ft. (1m). One option to obtain the correct width is to install clip-on crossbars (Version 01) between the retainers. This greatly simplifies the installation since no retroactive adjustments are needed. Another option, which facilitates a greater range of widths, is to mount the guide angle brackets on a profile rail (Version 02).

- Save up to 80% installation time compared to standard trough systems
- Saving time through fast assembly
- Very lightweight polymer components - more quieter than troughs made from steel
- Cost-effective
- Corrosion-resistant
- Gliding application: maximum speed 3.28 ft/s (1 m/s)
- Unsupported application (Guidelite as support tray): maximum speed 16.41 ft/s (5 m/s)
(Higher speeds can be attained. Please contact us for details)
- Construction kit solution

Typical industries and applications

- Watering cars (irrigation of potted plants)
- For applications with low number of cycles, low speed and additional load
- As cost-effective support tray for unsupported applications

Guidelite Guide Trough Selection Table



Guidelite - Version 01

Installation set with crossbar, standard

Fixed width due to clip-on crossbars, no retroactive adjustments needed

Part No.
Assembly set - Guide Angles
9GL-64-50-450-XX

For e-chain®
Series
• 2500 • 2700 • 3500 • E4-21 • E4-28 • E4-32



Guidelite - Version 02

Installation set with profile rail

Guide angle brackets are assembled on a profile rail for a larger range of widths

Part No.
Assembly set - Guide Angles
9GL-64-50-450-XX

For e-chain®
Series
• 1500 • 2500 • 2700 • 3500 • E4-21 • E4-28 • E4-32



E2/000 Rol e-chain® in a Guidelite guide trough of an irrigation plant

For the following Series

System E2/000 Series:

- 2500
- 2700
- 3500

System E4-1 Series:

- E4-21
- E4-28
- E4-32

Components - Version 01

- ❶ Guide angles
- ❷ Plastic guide rail
- ❸ Crossbar, clip-on

Ba = Outer e-chain® width

Bi = Inner e-chain® width

BB = Length of crossbar

A = Outer guide angle distance

B = Inner guide angle distance

Dimension *B* must always be .04" to .16" (1 to 4 mm) larger than the *Ba* of the e-chain®

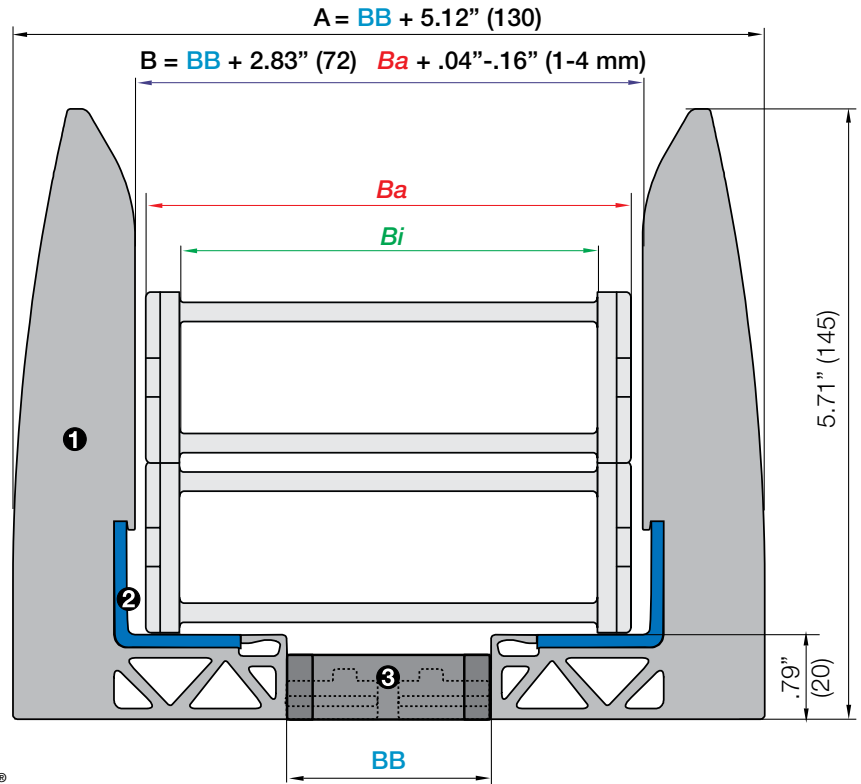

guidelite | Version 01

Description	Part No.
Installation set with crossbar for a fixed width, consisting of 2 x plastic guide rails + 1 x crossbar	9GL-64-50-450-XX (XX = crossbar width-index)
Set plastic guide rails (left and right) in specified lengths: standard 78.7" (2000 mm)	9GL-64-30-2000
Feed module that guides the upper run of the e-chain® down, 78.7" (2000 mm)	9GL-64-80-Series-450-XX (XX = crossbar width-index)
Only for Series 2700R and 3500R Rol e-chain® with center feed	
Please add the crossbar width-index XX as shown on the tables on the right page. Example: 9GL-64-50-450-05	

Feed principles

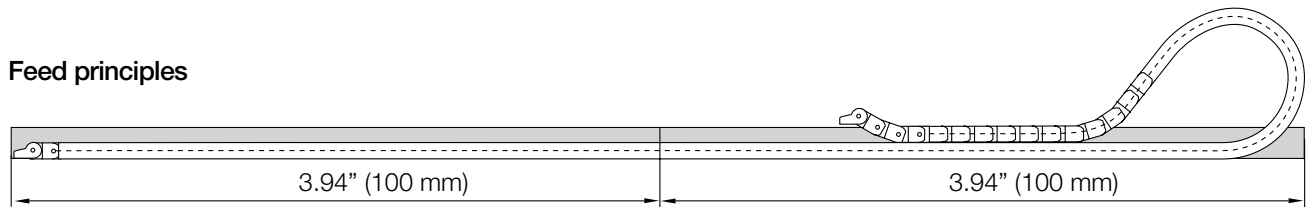

End feed is recommended for all e-chains® in combination with guidelite

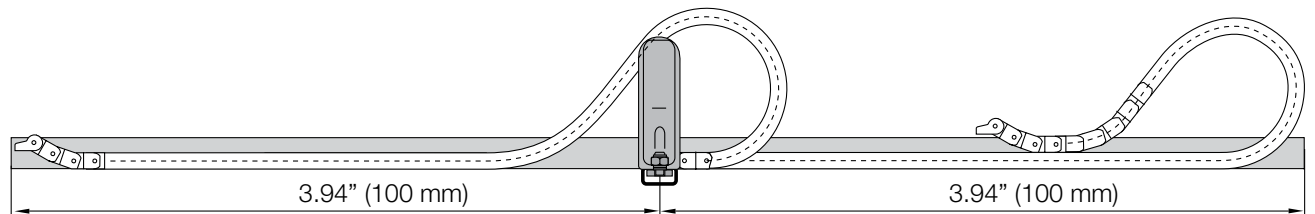

Center feed is only used with Rol e-chains® of Series 2700R and Series 3500R.

Please use the feed module 9GL-64-80 of Series 450-XX, which guides the upper run of the e-chain® down.

More information and assembly instructions ► www.igus.com/guidelite

Part No. Installation Set	For e-chain® Series	For Rol e-chain® Series	Length of Crossbar BB		Outer guide angle Distance A		Inner guide angle Distance B	
			in.	(mm)	in.	(mm)	in.	(mm)
9GL-64-50-450-05	2500-10-R-0	-	1.97	(50)	7.09	(180)	4.80	(122)
9GL-64-50-450-12	2700-17-R-0	2700R-17-R-0	4.92	(125)	10.04	(255)	7.76	(197)
9GL-64-50-450-05	3500-100-R-0	3500R-100-R-0	1.97	(50)	7.09	(180)	4.80	(122)
9GL-64-50-450-06	3500-115-R-0	3500R-115-R-0	2.56	(65)	7.68	(195)	5.39	(137)
9GL-64-50-450-07	3500-125-R-0	3500R-125-R-0	2.95	(75)	8.07	(205)	5.79	(147)
9GL-64-50-450-10	3500-150-R-0	3500R-150-R-0	3.94	(100)	9.06	(230)	6.77	(172)
9GL-64-50-450-12	3500-175-R-0	3500R-175-R-0	4.92	(125)	10.04	(255)	7.76	(197)
9GL-64-50-450-15	3500-200-R-0	3500R-200-R-0	5.91	(150)	11.02	(280)	8.74	(222)
9GL-64-50-450-17	3500-225-R-0	3500R-225-R-0	6.89	(175)	12.01	(305)	9.72	(247)
9GL-64-50-450-20	3500-250-R-0	3500R-250-R-0	7.87	(200)	12.99	(330)	10.71	(272)
9GL-64-50-450-06	E4-21-120-R-0	-	2.56	(65)	7.68	(195)	5.39	(137)
9GL-64-50-450-05	E4-28-100-R-0	-	1.97	(50)	7.09	(180)	4.80	(122)
9GL-64-50-450-07	E4-28-125-R-0	-	2.95	(75)	8.07	(205)	5.79	(147)
9GL-64-50-450-05	E4-32-097-R-0	-	1.97	(50)	7.09	(180)	4.80	(122)
9GL-64-50-450-06	E4-32-112-R-0	-	2.56	(65)	7.68	(195)	5.39	(137)

Dimension B must always be .04" to .16" (1 to 4 mm) larger than the **Ba** of the e-chain®



Ideal for outdoor applications - UV resistant, corrosion-free, allows dirt to pass through

PDF: igus.com/e-chain-pdfs
Product information: igus.com/e-chains

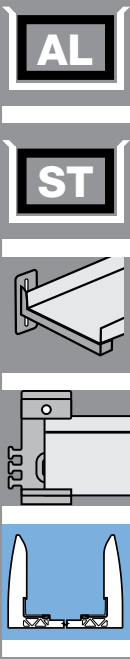

For the following Series

System E2/000 Series:

- 1500
- 2500
- 2700
- 3500

System E4-1 Series:

- E4-21
- E4-28
- E4-32

Components - Version 02

- 1 Guide angles
- 2 Plastic guide rail
- 4 Screwset M8
- 5 C-profile

B_{RA} = Outer e-chain® width

B_I = Inner e-chain® width

B_{RA} = Outer guide angle distance

B_{RI} = Inner guide angle distance

B_{RI} = B_A + 2

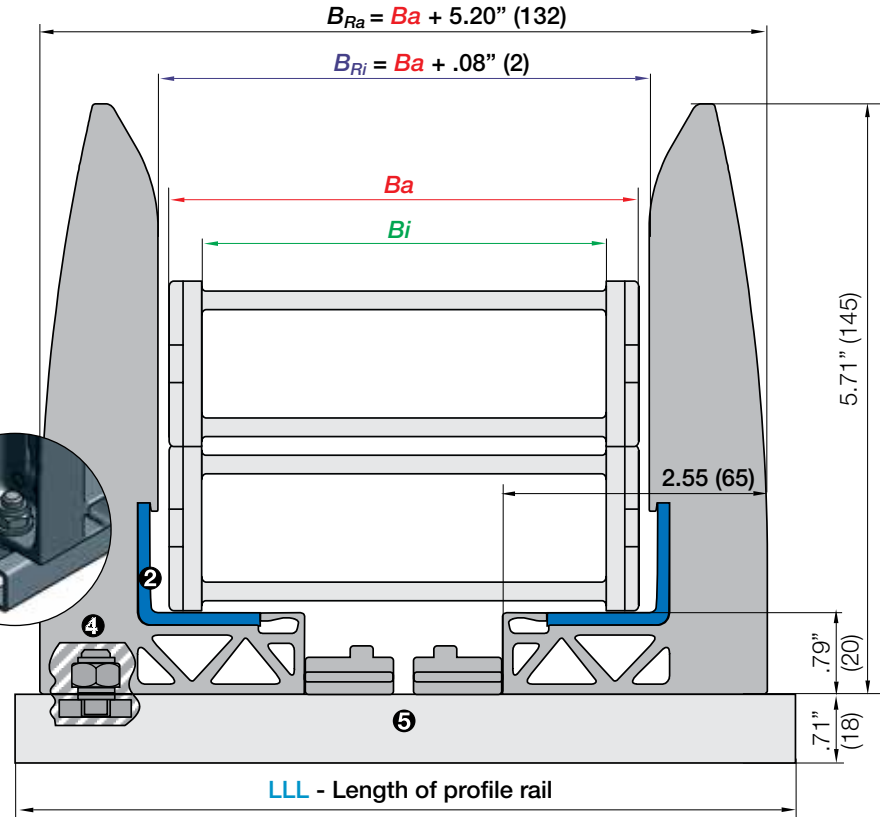
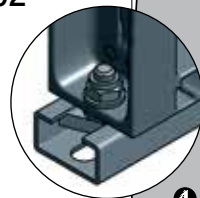

guidelite | Version 02

Description	Part No.
Installation set with profile rail consisting of	9GL-64-50-LLL
2 x plastic guide rails + 1 x profile rail + Screwsets M8	(LLL = Length of profile rail)
Set plastic guide rails (left and right)	9GL-64-30-2000
in specified lengths: standard 78.7" (2000 mm)	
Feed module that guides the upper run of the e-chain® down, 78.7" (2000 mm)	9GL-64-80-Series-LLL
Only for Series 2700R and 3500R Rol e-chain® with center feed	(LLL = Length of profile rail)
Please add the profile rail length LLL as shown on the tables on the right page. Example: 9GL-64-50-175	

Feed principles

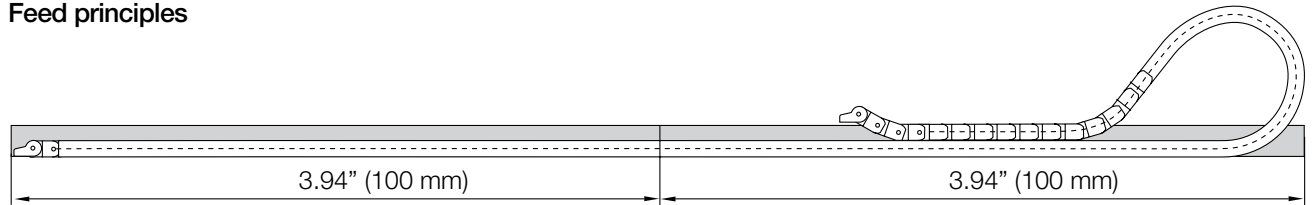

End feed is recommended for all e-chains® in combination with guidelite

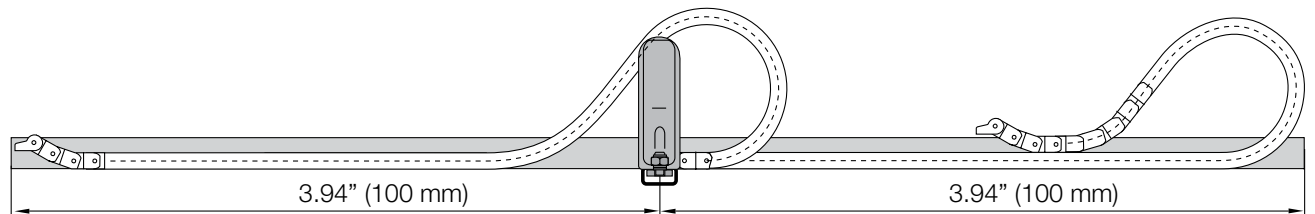

Center feed is only used with Rol e-chains® of Series 2700R and Series 3500R.

Please use the feed module 9GL-64-80 of Series 450-XX, which guides the upper run of the e-chain® down.

More information and assembly instructions ► www.igus.com/guidelite

Part No-Installation Set	For e-chain® Series	For Rol e-chain® Series
1500		
9GL-64-50-150	1500-068-R-0	-
9GL-64-50-175	1500-080-R-0	-
9GL-64-50-175	1500-100-R-0	-
9GL-64-50-200	1500-125-R-0	-
2500		
9GL-64-50-150	2500-05-R-0	-
9GL-64-50-175	2500-07-R-0	-
9GL-64-50-175	2500-09-R-0	-
9GL-64-50-200	2500-10-R-0	-
9GL-64-50-225	2500-12-R-0	-
2700		
9GL-64-50-150	2700-06-R-0	2700R-06-R-0
9GL-64-50-175	2700-07-R-0	2700R-07-R-0
9GL-64-50-175	2700-09-R-0	2700R-09-R-0
9GL-64-50-200	2700-10-R-0	2700R-10-R-0
9GL-64-50-225	2700-12-R-0	2700R-12-R-0
9GL-64-50-250	2700-15-R-0	2700R-15-R-0
9GL-64-50-275	2700-17-R-0	2700R-17-R-0
3500		
9GL-64-50-175	3500-075-R-0	3500R-075-R-0
9GL-64-50-200	3500-100-R-0	3500R-100-R-0
9GL-64-50-200	3500-115-R-0	3500R-115-R-0
9GL-64-50-225	3500-125-R-0	3500R-125-R-0
9GL-64-50-250	3500-150-R-0	3500R-150-R-0
9GL-64-50-275	3500-175-R-0	3500R-175-R-0
9GL-64-50-300	3500-200-R-0	3500R-200-R-0
9GL-64-50-325	3500-225-R-0	3500R-225-R-0
9GL-64-50-350	3500-250-R-0	3500R-250-R-0
E4-21		
9GL-64-50-150	E4-21-060-R-0	-
9GL-64-50-150	E4-21-070-R-0	-
9GL-64-50-175	E4-21-080-R-0	-
9GL-64-50-175	E4-21-090-R-0	-
9GL-64-50-175	E4-21-100-R-0	-
9GL-64-50-200	E4-21-110-R-0	-
9GL-64-50-200	E4-21-120-R-0	-

Part No-Installation Set	For e-chain® Series	For Rol e-chain® Series
E4-28		
9GL-64-50-150	E4-28-062-R-0	-
9GL-64-50-175	E4-28-070-R-0	-
9GL-64-50-175	E4-28-075-R-0	-
9GL-64-50-175	E4-28-087-R-0	-
9GL-64-50-200	E4-28-100-R-0	-
9GL-64-50-225	E4-28-125-R-0	-
9GL-64-50-250	E4-28-150-R-0	-
9GL-64-50-275	E4-28-175-R-0	-
9GL-64-50-300	E4-28-200-R-0	-
9GL-64-50-325	E4-28-225-R-0	-
9GL-64-50-350	E4-28-250-R-0	-
9GL-64-50-375	E4-28-275-R-0	-
9GL-64-50-400	E4-28-300-R-0	-
E4-32		
9GL-64-50-150	E4-32-05-R-0	-
9GL-64-50-175	E4-32-06-R-0	-
9GL-64-50-175	E4-32-07-R-0	-
9GL-64-50-175	E4-32-087-R-0	-
9GL-64-50-200	E4-32-09-R-0	-
9GL-64-50-200	E4-32-10-R-0	-
9GL-64-50-200	E4-32-11-R-0	-
9GL-64-50-200	E4-32-112-R-0	-
9GL-64-50-225	E4-32-12-R-0	-
9GL-64-50-225	E4-32-137-R-0	-
9GL-64-50-250	E4-32-15-R-0	-
9GL-64-50-275	E4-32-162-R-0	-
9GL-64-50-275	E4-32-17-R-0	-
9GL-64-50-275	E4-32-18-R-0	-
9GL-64-50-275	E4-32-187-R-0	-
9GL-64-50-300	E4-32-200-R-0	-
9GL-64-50-300	E4-32-212-R-0	-
9GL-64-50-325	E4-32-23-R-0	-
9GL-64-50-325	E4-32-237-R-0	-
9GL-64-50-350	E4-32-25-R-0	-
9GL-64-50-350	E4-32-262-R-0	-
9GL-64-50-375	E4-32-28-R-0	-
9GL-64-50-375	E4-32-29-R-0	-
9GL-64-50-400	E4-32-30-R-0	-

Please note: the smallest possible inner width of the guide trough is 2.83 (72 mm).

PDF: igus.com/e-chain-pdfs
Product information: igus.com/e-chains

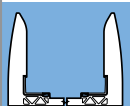
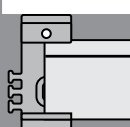
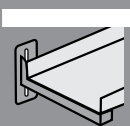

↑
igus



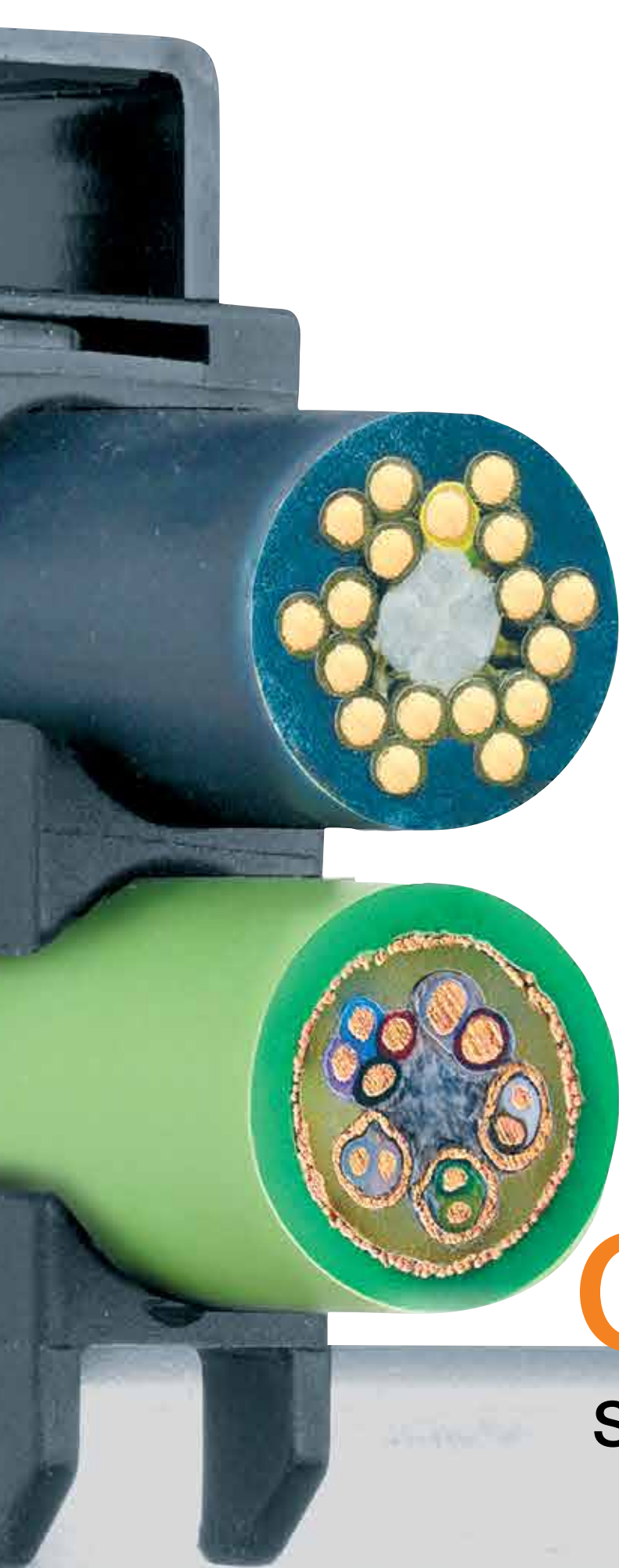

igus[®]
Chainfix
Strain relief systems

igus® Chainfix strain relief. Flexible and fast assembled.

Strain relief from igus® is specifically developed for use in e-chains® and dynamic applications. The combination of chainflex® cable materials and the plastic strain relief components of igus® Chainfix are designed to achieve long life of the cables and maximum holding power. For a wide variety of applications igus® Chainfix is the best solution in terms of costs and benefits. igus® Chainfix strain relief components are installed in applications around the world.



Available from stock. Orders ship as early as today.*

*On average 90% of orders ship the same day..



3D-CAD files, configurators, PDF ► www.igus.com/chainfix

Chainfix Strain Relief systems

Overview

Profile rail - standard and for heavy-duty applications



- Standard profile rail Part No. CF-92-42KMA (can be integrated into KMA)
- Profile rail Part No. CF-92-52G for increased holding force (mounting in front of e-chain®)

Steel and stainless steel clamps - for maximum holding force



- CFX* Single, double, triple clamps with standard base
- CFXL* Single, double, triple clamps with wide base for maximum holding force
- Clamp stacker and saddle elements
- chainfix multi-clamps*

chainfix tiwrap plates - universal, bolted or clip-on

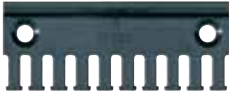

- Option 1A: tiwrap plates as individual parts "Series 2000" + cable tiwraps
- Option 1B: tiwrap plates as individual parts "Series 3000" + cable tiwraps

chainfix tiwrap plates - optional variants

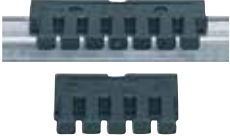

- Option 1: tiwrap plates with clip-on connection for profile rail
- Option 2: integrated strain relief for R series E2 e-tubes
- Option 3: tiwrap plates for fixed crossbars
- Option 4: tiwrap plates for openable crossbars

CFU honeycomb strain relief - assembled in seconds



- Simply insert cables and hoses into honeycomb and close - strain relief for different cables in one slot

Strain relief separators - with integrated teeth



- For easy strain relief with cable tiwraps

CFV - stepped strain relief for use outside of the e-chain® section



- Easy strain relief for cables, even in fully enclosed e-tubes (with strain relief teeth, stepped)

CFN - chainfix nuggets for Profile rail and top-hat (DIN) rail



- Option 1: simple and universal cable attachment for cable diameters of .79" (20 mm) and 1.18" (30 mm)
- Option 2: fastened by clipping onto standard top-hat (DIN) rail

CFB - strain relief connector system, modular and customizable



- CFB polymer strain relief connector system, for many cables in a very confined space

*Standard material: galvanised steel. Also available as stainless steel version (stainless steel material: 1.4301/AISI 304)

Chainfix Strain Relief Selection Guide

	CFX Clamp, standard	CFXL Clamp, for increased holding force	CFU Honeycomb strain relief	CFN Nugget	Strain relief separator	CFV Stepped strain relief	Strain relief can be clipped onto mounting brackets / KMA
E1							
E1-17-021-	-	-	-	-	-	-	-
E-Z chain®							
E03	-	-	-	-	-	-	-
E04	-	-	-	-	-	-	-
E045/Z045	-	-	-	-	-	-	-
E06/Z06	-	-	-	-	-	-	-
E065/Z065	-	-	-	-	-	-	-
E08/Z08	-	-	-	-	-	-	-
E14/Z14	-	-	-	-	-	-	-
E200/Z200	X ¹⁾	-	-	-	-	-	-
E16/Z16	-	-	-	-	-	-	-
E26/Z26	X ¹⁾	-	-	-	-	-	-
E300/Z300	X ¹⁾	-	-	-	-	-	-
zipper							
047	-	-	-	-	-	-	-
07/R07	-	-	-	-	-	-	-
09/R09	-	-	-	-	-	-	-
15/R15	-	-	-	-	-	-	-
17/R17	-	-	-	-	-	-	-
E2 micro							
03	-	-	-	-	-	-	-
04	-	-	-	-	-	-	-
045	-	-	-	-	-	-	-
B07	-	-	-	-	-	-	-
06	-	-	-	-	-	-	-
B09	-	-	-	-	-	-	-
08	-	-	-	-	-	-	-
E2 mini							
10	-	-	-	-	-	-	-
11-031	-	-	-	-	-	-	-
11-080	-	-	-	-	-	-	-
11-1/11-2	-	-	-	-	-	-	-
14	-	-	-	-	-	-	-
B15/B15i	-	-	-	-	-	-	-
B17/B17i	-	-	-	-	-	-	-
F17	-	-	-	-	-	-	-
E2-1 micro							
E2-10	-	-	-	-	-	-	-
E2-15	-	-	-	-	-	-	-

Chainfix Strain Relief Selection Guide

e-chain® Series / System	CFX Clamp, standard	CFXL Clamp, for increased holding force	CFU Honeycomb strain relief	CFN Nugget	Strain relief separator	CFV Stepped strain relief	Strain relief can be clipped onto mounting brackets / KMA
E2/000							
1400/1500	X ¹⁾	X ¹⁾	–	–	21-1-Z	–	–
1450/1480	X ¹⁾	X ¹⁾	–	–	21-1-Z	–	–
2400/2500	X ¹⁾	X ¹⁾	–	–	2020-Z	–	–
2450/2480	X ¹⁾	X ¹⁾	–	–	2020-ZR	–	–
2600/2700	X	X ¹⁾	–	X	262-Z	CFV-42-C	–
2650/2680	X	X ¹⁾	–	X	–	CFV-42-C	–
3400/3500	X	X ¹⁾	CFU	X	301-Z	CFV-42-C	–
3450/3480	X	X ¹⁾	CFU	X	34501-Z	CFV-42-C	–
255	–	–	–	–	–	–	–
E2 R100							
R117/118	X ¹⁾	X ¹⁾	–	–	–	–	–
R157/158	X ¹⁾	X ¹⁾	–	–	1585-01-Z	–	–
R167/168	X ¹⁾	X ¹⁾	CFU	–	1685-01-Z	–	–
E2 R							
R48	X ¹⁾	X ¹⁾	–	–	481-ZR	–	–
R58	X ¹⁾	X ¹⁾	–	–	–	–	–
R68	X ¹⁾	X ¹⁾	CFU	–	–	–	–
R2-1							
R2-75	X ¹⁾	X ¹⁾	–	–	–	CFV-80-C	–
RX							
RX32	–	–	–	–	–	–	X
RX40	–	–	–	–	–	–	X
RX48	–	–	–	–	–	–	
RX56	–	–	–	–	–	–	
E4-1L							
E4-31L/R4-31L	X ¹⁾	X ¹⁾	–	–	31-Z	CFV-31-N15	–
E4-38L/R4-38L	X	X ¹⁾	–	X	–	CFV-42-C	–
E4-48L/R4-48L	X	X ¹⁾	CFU	X	–	CFV-42-C	–
E4-64L	X	X ¹⁾	–	X	–	CFV-42-C	–
E4-1							
E4-21	X ¹⁾	X ¹⁾	–	–	T2103-Z	–	–
E4-28/R4-28	X ¹⁾	X ¹⁾	–	–	28-Z / 28-ZT	–	–
E4-32/H4-32/R4-32	X	X ¹⁾	–	X	–	CFV-42-C	–
E4-42/H4-42/R4-42	X	X ¹⁾	CFU	X	–	CFV-42-C	–
E4-56/H4-56/R4-56	X	X ¹⁾	–	X	–	CFV-80-C	–
E4-80/H4-80/R4-80	X	X ¹⁾	–	X	–	CFV-80-C	–
E4-112	X ¹⁾	X ¹⁾	–	–	–	–	–
E4-162	X ¹⁾	X ¹⁾	–	–	–	–	–
800	X ¹⁾	X ¹⁾	–	–	–	–	–
840	X ¹⁾	–	–	–	–	–	–

Tiewrap plate Series 2000	Tiewrap plate Series 3000	Tiewrap plate with clip-on connection for profile rail	Tiewrap plate for fixed crossbars	Tiewrap plate for openable crossbars	Tiewrap plate for triflex® R and triflex® 2)	Tiewrap plate for E2 e-tubes	Tiewrap plate/teeth directly moulded on the mounting bracket	CFB Strain relief connector system
20XX-ZB	-	-	-	-	-	-	X	-
20XX-ZB	-	-	-	-	-	-	X	-
20XX-ZB	-	-	2050-Z	-	-	-	-	-
20XX-ZB	-	-	-	-	-	-	-	-
20XX-ZB	30XX-ZB	30XX-ZC	2050-Z	2050-Z	-	-	-	-
-	30XX-ZB	30XX-ZC	-	2050-Z ³⁾	-	-	-	-
-	30XX-ZB	30XX-ZC	30XX-Z	30XX-ZS	-	-	-	-
-	30XX-ZB	30XX-ZC	-	30XX-ZS ³⁾	-	-	-	-
20XX-ZB	-	-	-	-	-	-	-	-
20XX-ZB	-	-	-	-	-	-	-	-
-	-	-	-	-	-	-	-	-
-	-	-	-	-	-	-	-	-
20XX-ZB	-	-	-	-	-	-	-	-
-	-	-	-	-	-	5850-Z	-	-
-	-	-	-	-	-	30XX-Z	-	-
-	30XX-ZB	30XX-ZC	-	-	-	-	-	-
-	-	-	-	-	-	-	-	X
-	-	-	-	-	-	-	-	X
-	-	-	-	-	-	-	-	X
-	-	-	-	-	-	-	-	X
-	-	-	-	-	-	-	-	-
-	30XX-ZB	30XX-ZC	-	3850-ZS	-	-	-	X
-	30XX-ZB	30XX-ZC	-	3850-ZS	-	-	-	X
-	30XX-ZB	30XX-ZC	-	3850-ZS	-	-	-	X
20XX-ZB	-	-	-	-	-	-	-	-
20XX-ZB	-	-	-	2050-Z	-	-	-	-
-	30XX-ZB	30XX-ZC	-	3850-ZS	-	-	-	X
-	30XX-ZB	30XX-ZC	-	3850-ZS	-	-	-	X
-	30XX-ZB	30XX-ZC	-	45XX-ZS	-	-	-	X
-	30XX-ZB	30XX-ZC	-	45XX-ZS	-	-	-	X
-	30XX-ZB	-	-	45XX-ZS	-	-	-	X
-	30XX-ZB	-	-	-	-	-	-	X
-	30XX-ZB	-	-	-	-	-	-	-
-	-	-	-	-	-	-	-	-

2) You'll find on the product page of each e-chain® series 3) Half e-tube only = recommended strain relief for selected e-chain®

Chainfix Strain Relief Selection Guide

e-chain® Series / System	CFX Clamp, standard	CFXL Clamp, for increased holding force	CFU Honeycomb strain relief	CFN Nugget	Strain relief separator	CFV Stepped strain relief	Strain relief can be clipped onto mounting brackets / KMA
E4/light							
14040/14140/18840	X	X ¹⁾	–	X	–	–	–
14240/14340	X	X ¹⁾	–	X	–	–	–
14550/14650/19050	X	X ¹⁾	–	X	–	–	–
15050/15150/19850	X	X ¹⁾	–	–	–	–	–
15250/15350	X	X ¹⁾	–	–	–	–	–
1640/R1608	X	X ¹⁾	–	–	–	–	–
T3							
T3-29	–	–	–	–	E6-29-02-Z	–	20XX-ZB
E3							
E3-10	–	–	–	–	–	–	E3-00-020
E3-15	–	–	–	–	–	–	E3-00-020
E3-22	–	–	–	–	–	–	E3-00-020
E6-1							
E61-29/EF61-29	X ¹⁾	X ¹⁾	–	–	E6-29-02-Z	–	–
E61-35	X ¹⁾	X ¹⁾	–	–	E6-35-02-Z	–	–
E61-40	X	X ¹⁾	–	X	E6-40-02-Z	–	–
E61-52	X	X ¹⁾	–	X	–	–	–
E6							
E6-29	X ¹⁾	X ¹⁾	–	–	E6-29-02-Z	–	–
R6-29	X ¹⁾	X ¹⁾	–	–	–	–	–
E6-35	X ¹⁾	X ¹⁾	–	–	E6-35-02-Z	–	–
E6-40	X	X ¹⁾	–	X	E6-40-02-Z	–	–
E6-52	X	X ¹⁾	–	X	–	–	–
R6-52	X	X ¹⁾	–	X	–	–	–
E6-62	X	X ¹⁾	–	X	–	–	–
E6-80L	X	X ¹⁾	–	X	–	–	–
triflex® R							
TRC	X ¹⁾	X ¹⁾	–	–	–	–	–
TRC	X ¹⁾	X ¹⁾	–	–	–	–	–
TRCF	X ¹⁾	X ¹⁾	–	–	–	–	–
TRL	X ¹⁾	X ¹⁾	–	–	–	–	–
TRLF	X ¹⁾	X ¹⁾	–	–	–	–	–
triflex®							
E-Z triflex®	X ¹⁾	–	–	–	–	–	–
triflex®	X ¹⁾	–	–	–	–	–	–

Tiewrap plate Series 2000	Tiewrap plate Series 3000	Tiewrap plate with clip-on connection for profile rail	Tiewrap plate for fixed crossbars	Tiewrap plate for openable crossbars	Tiewrap plate for triflex® R and triflex® 2)	Tiewrap plate for E2 e-tubes	Tiewrap plate/teeth directly moulded on the mounting bracket	CFB Strain relief connector system
-	30XX-ZB	30XX-ZC	-	45XX-ZS	-	-	-	X
-	30XX-ZB	30XX-ZC	-	3850-ZS	-	-	-	X
-	30XX-ZB	30XX-ZC	-	45XX-ZS	-	-	-	X
-	30XX-ZB	30XX-ZC	-	45XX-ZS	-	-	-	X
-	30XX-ZB	30XX-ZC	-	3850-ZS	-	-	-	X
-	30XX-ZB	-	-	45XX-ZS	-	-	-	-
-	-	-	-	-	-	-	-	-
-	-	-	-	-	-	-	-	-
-	-	-	-	-	-	-	-	-
-	-	-	-	-	-	-	-	-
20XX-ZB	-	-	-	-	-	-	-	-
20XX-ZB	-	-	-	-	-	-	-	X
20XX-ZB	-	-	-	-	-	-	-	X
-	30XX-ZB	30XX-ZC	-	2050-Z	-	-	-	X
20XX-ZB	-	-	-	-	-	-	-	-
20XX-ZB	-	-	-	-	-	-	-	-
20XX-ZB	-	-	-	-	-	-	-	X
20XX-ZB	-	-	-	-	-	-	-	X
-	30XX-ZB	30XX-ZC	-	2050-Z	-	-	-	X
-	30XX-ZB	30XX-ZC	-	-	-	-	-	X
-	30XX-ZB	30XX-ZC	-	3850-ZS	-	-	-	X
-	30XX-ZB	30XX-ZC	-	45XX-ZS	-	-	-	X
-	-	-	-	-	-	-	-	-
-	-	-	-	-	-	-	-	-
-	-	-	-	-	-	-	-	-
-	-	-	-	-	-	-	-	-
-	-	-	-	-	-	-	-	-
-	-	-	-	-	E33X-XX-2	-	-	-
-	-	-	-	-	33X-XX	-	-	-

2) You'll find on the product page of each e-chain® series 3) Half e-tube only  = recommended strain relief for selected e-chain®

Chainfix Strain Relief - Overview

igus® chainfix strain relief system



CFX - clamps

Tiewrap plates - bolted, clip-on

CFU - lean honeycomb strain relief



Recommended standard for the following e-chains®:

E4, E6, for all KMA* with Profile rail

*Polymer metal mounting bracket

easy chain®, E2/000, E2 e-tubes, E4, E6

E2.48, 3400/3500, 3450/3480, R68, R167/168, R2.48, E4.48L/R4.48L, E4.42/H4.42/R4.42, E61.52, E6.52/R6.52



When to use this strain relief?

Standard for high accelerations, loads and demanding applications. For many cables, large cable diameters and stacked cables. For long travels, cranes, offshore, machine tools, high speeds and hydraulic cables.

Standard for many applications at medium and low accelerations. For unsupported, gliding, hanging and standing applications in general machinery and machine tools. For cables side by side. Also available as an individual part, for example in control cabinets etc.

Assembled in seconds - CFU honeycomb strain relief. Strain relief with honeycomb structure, openable from both sides. Simply insert cables and hoses into the honeycomb and close. Strain relief for different cables in one slot. Also suitable for gliding applications.



When not to use it:

No limitation

For large cable diameters

For high loads

Properties

Assembly time index

+

+

+++

Adjustable tensile strength

++

-

+

Price Index



Modularity

yes

yes

yes

Dynamics

high to very high

high

medium

Price index

●●● low

●●● medium

●●● high

+++ = best suitability

+ = good suitability

+ - = suitable

- = limited suitability

Chainfix Strain Relief - Overview



CFN nuggets

Strain relief separators

CFV - strain relief element

CFB - strain relief connector system

For all KMA* with Profile rail or top-hat (DIN) rail

*Polymer metal mounting bracket

E2/000, E2 e-tubes, E6, T3

E2/000, R2.1, E4.1L, E4.1

E4, E6, for all KMA* with Profile rail

*Polymer metal mounting bracket

Cost-effective, fast strain relief for simple applications with small spaces and medium accelerations. Also available as single parts for fixed applications, such as in cabinets, etc.

Combination of separator and strain relief, ideal for small spaces. For applications with medium accelerations. For small cables diameters. Ideal for e-tubes. For machine tools and automation.

For both e-chains® and e-tubes. Stepped strain relief for use outside of the e-chain® cross section - even with different connectors. Easy to retrofit. Simple installation into top-hat (DIN) rail or Profile rail on KMA mounting brackets.

Space-saving, modular strain relief with many cables in confined spaces. For applications with high accelerations and loads e.g., in machine tools.

For high loads

For high loads

For high loads

No limitation

+ -

-



yes

high

+

-



yes

high

+ +

-



yes

medium

+ -

+



yes (special fabrication)

high to very high

Standard Profile rails Part No. CF-92-42KMA

- For all igus® CFX clamps and KMA- mounting brackets with profile rail host-option
- Standard material: galvanized steel **Part No. CF-92-42KMA**
- Also available as stainless steel version (Material stainless steel: 1.4301)
please add Index **SS**, example: **Part No. CF-92-42KMSS**

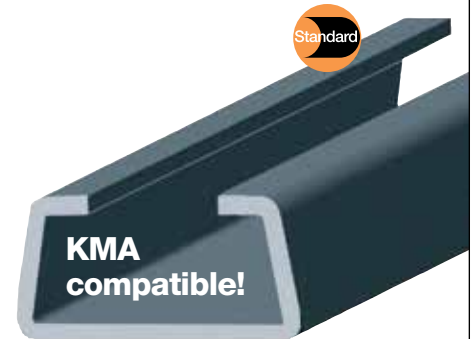

Standard profile rail Part No. CF-92-42KMA For conventional applications
Can be integrated into KMA with profile rail host-option!

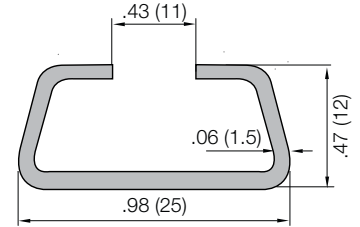
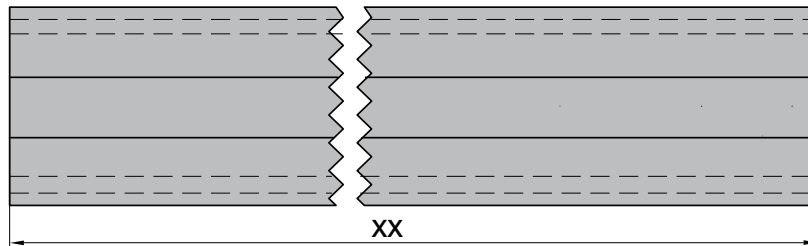
**Optional - For Heavy-Duty applications****Profile rail Part No. CF-92-52G**

- For all igus® CFXL clamps
- With increased holding power - even for harsh applications
- Standard material: galvanized steel **Part No. CF-92-52G**
- Also available as stainless steel version (Material stainless steel: 1.4301)
please add Index **SS**, example: **Part No. CF-92-52GSS**



Profile rail Part No. CF-92-52G With increased holding power for harsh conditions
Assembly in front of the e-chain® - CAN NOT be integrated into KMA mounting bracket!

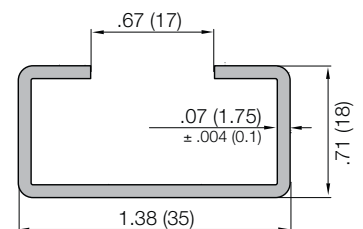
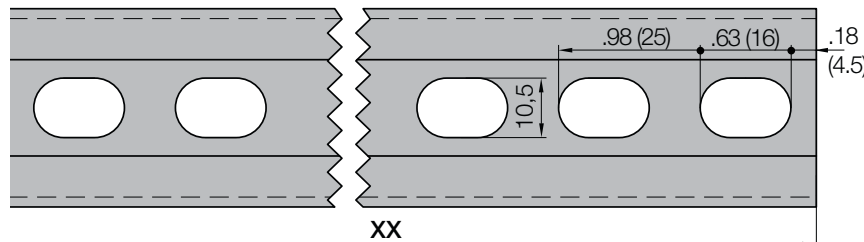

Three times higher tensile strength than other industry-standard clamps

We have tested three different strain relief types:

- A. Standard, hot-dipped galvanized steel strain relief clamp with single and double impact-resistant polymer saddle clamp elements (Part No. CF14-1-Z, standard elements)
- B. Standard strain relief housings (as used in A) with igumid G clamp saddles (Part No. CFY14-1)
- C. igus® Chainfix strain relief elements (Part No. CFX14-1)

Results:

Strain relief element “A” saddle clamps loosen at 225 lbs (1,000 N) of pull force. The resulting diagonal position of the saddle clamp distorts the screw.

Strain relief element “B” saddle clamps loosen at 393 lbs (1,750 N) of pull force. The improved igumid G saddle clamps attempt to hold the cable, causing the outer jacket to “peel.”

Strain relief element “C”, igus® new Chainfix system, saddle clamps loosen and slant 5° at 393 lbs (1,750 N). At 562 lbs (2,500 N) of pull force, the cable jacket bunches up behind the clamp and, at 787 lbs (3,500 N) of pull force, the clamps loosen completely and the cable becomes inoperative.

Conclusion:

The tensile strength of the “Chainfix” line of strain relief elements developed by igus® is more than three times higher than the tensile strength of standard strain relief elements.

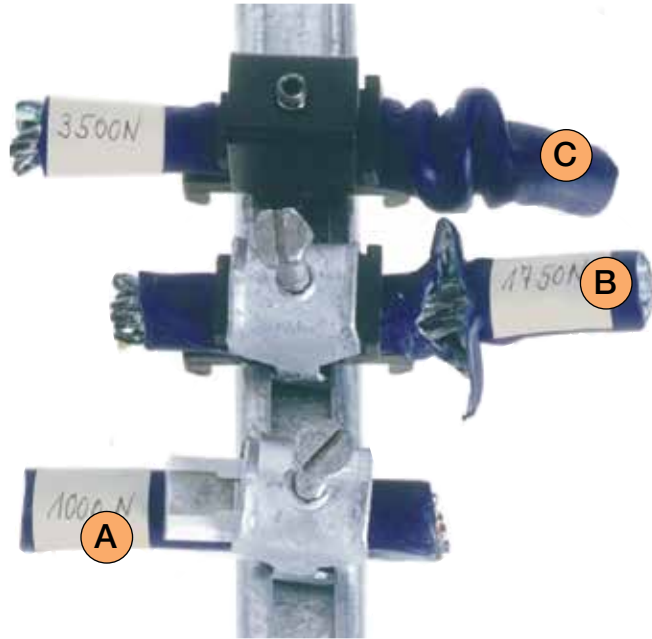

Test example with cable diameter .41” (10.5 mm)

Tiewrap Plate 2070-ZB with one cable tie

Result: tensile force 65 lbs (290 N)

Chainfix Clip CFC-12-M

Result: tensile force 79 lbs (350 N)



Pull Force Test for igus Tiewrap Plates with Cable Tiewraps

Results:

Two tiewraps are more stable than one tiewrap. If one cable tiewrap is used, **the breaking force is approximately 79 lbs (350 N)**. If the cable is secured with **two** cable tiewraps, **the breaking force increases to 187 lbs (830 N)**, i.e. pull force resistance more than doubles when using two cable tiewraps.

Technical data:

Tiewrap plates: 2100-ZB/3100-ZB
 Cable: CF130-07-12
 Cable tiewrap: CFB-001





To be integrated into
KMA mounting bracket

For up to three cables
over one another

Reduced installation
height, space saving

Excellent durability for
dynamic applications

Chainfix clamps - more secure, faster assembled

- Integration with KMA mounting brackets and profile rail host-option
- Easy to read the part number and lateral marking of the correct installation direction
- Reduced installation height due to optimal housing height
(compared to conventional clamps up to 15 mm)
- Space- and time-saving assembly
- Delivery options for complete systems with cables and preassembled strain relief
- Improved base for easy fit on the profile rail
- Setscrews, tightened with Allen wrench, for easy installation
- Durability for dynamic applications through improved stacker elements:
optimized stacker saddles, held by retaining lugs
- The long contact surface of the stacker elements improves the clamp's stability
- The high rigidity of the stacker elements significantly increases the reliability
- Built-in ribs to the stacker elements - no disconnection of cables from the strain relief
- Optional: CFXL clamps with increased holding power for Heavy-Duty applications

NOTE: (CFXL are always assembled **in front** of the e-chain® -

CAN NOT be integrated into KMA mounting brackets with profile rail host option!)

Strain Relief Elements for e-chains® and e-tubes with igus® Chainfix Clamps and Saddle Clamp Elements

The Chainfix clamp system design has proven itself as effective, life-prolonging strain relief for igus® e-chain systems®.

Product range and materials

- Steel clamp: clamp and screw black painted steel
- Stainless steel clamp: clamp and screw: blank (material 1.4301)
- Stacker elements: bottom saddle and stacker saddle (material igumid G)
- Profile rail: steel (material galvanized steel) or stainless steel (material 1.4301) available

Features of the igus® Chainfix Clamps

- Improved housing foot clamp for easy fit into profile rail
- Newly developed housing with reduced overall height
- Black housing and setscrews for attractive appearance
- Setscrews, tightened with Allen wrench, for easy installation

Features of the igus® Saddle Clamps

- Long support surface for improved stability
- Inherently high material rigidity for increased reliability
- Integrated ribbing to keep cables/hoses firmly strain relieved

Installation Height

If the e-chain® glides on itself over long travel distances, the screw heads of the strain relief on the fixed end must be at least .39 (10 mm) below the e-chain® link height. Our clamp housing with setscrews reduces the overall height by up to .59 (15 mm) compared to conventional clamp housings. In the case of unsupported e-chains®, the strain relief elements may be used with no problems.

Please note:

- Ideally, the cables/hoses should be strain relieved at both ends of the e-chain®. At the very least, they must be strain relieved at the moving end of the e-chain®.
- When using Chainfix clamps on profile rail in the mounting bracket for the Series: E4-32/H4-32/R4-32, 280/290/R770, 2828/2928/R7728, 28/29/R77, a shortened bottom saddle must be used. For shortened bottom saddles supplement Part No. with index "K" = Example: **Part No. CFX12-1K**

For Series:

System E2/000

- 2400/2500/2450/2480
- 2600/2700/2650/2680
- 3400/3500/3450/3480

System E4-1

- E4-32/H4-32/R4-32
- E4-42/H4-42/R4-42
- E4-56/H4-56/R4-56
- E4-80/H4-80/R4-80
- E4-112/H4-112/R4-112

System E4-1/light

- E4-38L/R4-38L
- E4-48L/R4-48L

System E4/light

- 14040/14140/R18840
- 14240/14340
- 14550/14650/19050
- 15050/15150/R19850
- 15250/15350

System E6

- E6-40
- E6-52 / R6-52
- E6-62
- E6-80L
- E6-80

PDF: igus.com/e-chain-pdfs
Product information: igus.com/e-chains



CFX - Chainfix housing with reduced height



KMA mounting bracket with integrated profile rail and Chainfix clamps



Improved housing foot clamp for easy fit into profile rail

*Add and "M" to the end of the part number for this series

Chainfix Strain Relief CFX Clamps For use inside the KMA Bracket

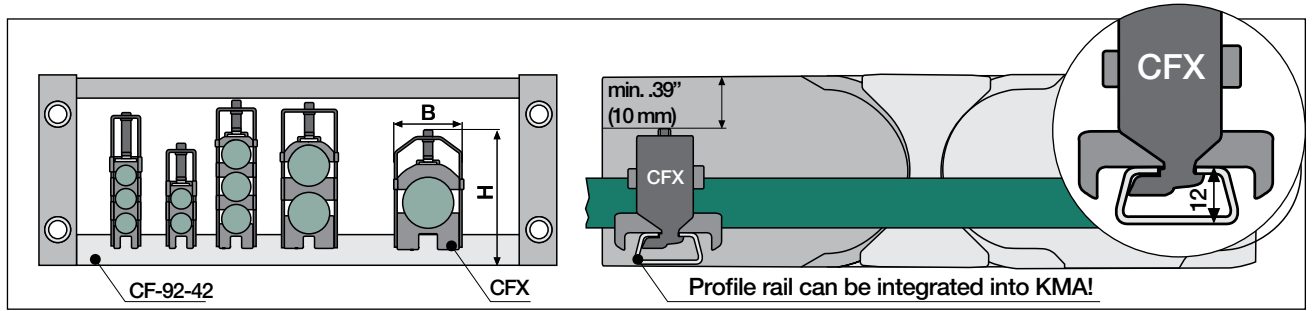

The dimensions given for H in the tables are based on the maximum cable diameter. Cables with smaller diameters may result in lower overall clamp housing heights.



Single clamp housing,
including top/bottom saddle clamps

Part No. Steel	Part No. Stainless Steel	For cable diameters		B ⁺²	H
		in.	(ø mm)		
CFX12-1	CFX12-1E	.24-.47	(6 – 12)	.63 (16)	1.57 (40)
CFX14-1	CFX14-1E	.47-.55	(12 – 14)	.71 (18)	1.97 (50)
CFX16-1	CFX16-1E	.55-.63	(14 – 16)	.79 (20)	2.05 (52)
CFX18-1	CFX18-1E	.63-.71	(16 – 18)	.87 (22)	2.13 (54)
CFX20-1	CFX20-1E	.71-.79	(18 – 20)	.94 (24)	2.20 (56)
CFX22-1	CFX22-1E	.79-.87	(20 – 22)	1.02 (26)	2.28 (58)
CFX26-1	CFX26-1E	.87-1.02	(22 – 26)	1.18 (30)	2.64 (67)
CFX30-1	CFX30-1E	1.02-1.18	(26 – 30)	1.34 (34)	2.80 (71)
CFX34-1	CFX34-1E	1.18-1.34	(30 – 34)	1.50 (38)	2.95 (75)
CFX38-1	CFX38-1E	1.34-1.50	(34 – 38)	1.65 (42)	3.11 (79)
CFX42-1	CFX42-1E	1.50-1.65	(38 – 42)	1.81 (46)	3.27 (83)



Ribbed strain relief saddle
clamps withstands increased pull
forces for long-term durability



Double clamp housing,
including top/bottom saddle clamps
and one stacker saddle clamp

Part No. Steel	Part No. Stainless Steel	For cable diameters		B ⁺²	H
		in.	(mm)		
CFX12-2	CFX12-2E	.24-.47	(6 – 12)	.63 (16)	2.83 (72)
CFX14-2	CFX14-2E	.47-.55	(12 – 14)	.71 (18)	2.91 (74)
CFX16-2	CFX16-2E	.55-.63	(14 – 16)	.79 (20)	3.07 (78)
CFX18-2	CFX18-2E	.63-.71	(16 – 18)	.87 (22)	3.23 (82)
CFX20-2	CFX20-2E	.71-.79	(18 – 20)	.94 (24)	3.38 (86)
CFX22-2	CFX22-2E	.79-.87	(20 – 22)	1.02 (26)	3.54 (90)
CFX26-2	CFX26-2E	.87-1.02	(22 – 26)	1.18 (30)	4.29 (109)
CFX30-2	CFX30-2E	1.02-1.18	(26 – 30)	1.34 (34)	4.61 (117)
CFX34-2	CFX34-2E	1.18-1.34	(30 – 34)	1.50 (38)	4.92 (125)



Triple clamp housing,
including top/bottom
saddle clamps and two
stacker saddle clamps

Part No. Steel	For cable diameters		B ⁺²	H
	in.	(ø mm)		
CFX12-3	.24-.47	(6 – 12)	.63 (16)	3.94 (100)
CFX14-3	.47-.55	(12 – 14)	.71 (18)	3.78 (96)
CFX16-3	.55-.63	(14 – 16)	.79 (20)	4.02 (102)
CFX18-3	.63-.71	(16 – 18)	.87 (22)	4.25 (108)
CFX20-3	.71-.79	(18 – 20)	.94 (24)	4.49 (114)
CFX22-3	.79-.87	(20 – 22)	1.02 (26)	4.72 (120)



Chainfix Strain Relief

CFXL Clamps

For use outside the KMA Bracket

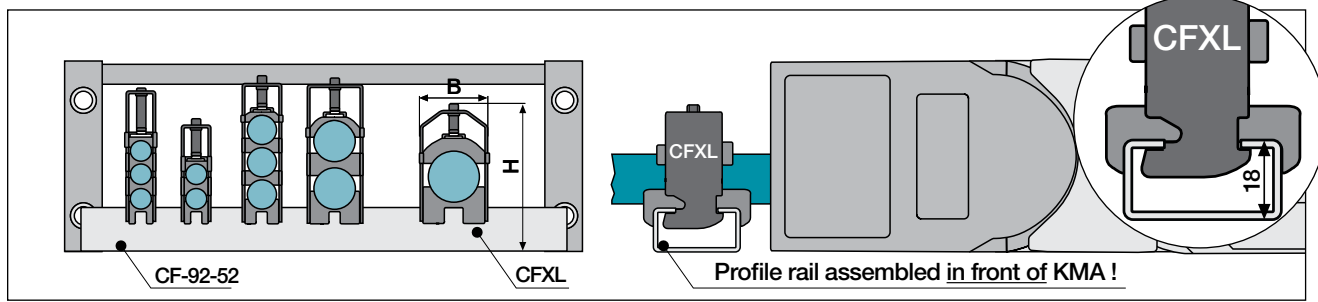

The dimensions given for H in the tables are based on the maximum cable diameter. Cables with smaller diameters may result in lower overall clamp housing heights. Tightening torque 1.5 Nm for CFXL clamps



Single clamp housing, including top/bottom saddle clamps

CFXL - clamps with wide base for increased holding power
Suitable for profile rails CF-92-52-XX - profile rail assembled in front of KMA!
CANNOT be integrated into the KMA mounting bracket!

Part No. Steel	Part No. Stainless Steel	For cable diameters		B ⁺²	H
		in.	(ø mm)		
CFXL12-1	CFXL12-1E	.24-.47	(6 – 12)	.63 (16)	2.36 (60)
CFXL14-1	CFXL14-1E	.47-.55	(12 – 14)	.71 (18)	2.20 (56)
CFXL16-1	CFXL16-1E	.55-.63	(14 – 16)	.79 (20)	2.28 (58)
CFXL18-1	CFXL18-1E	.63-.71	(16 – 18)	.87 (22)	2.36 (60)
CFXL20-1	CFXL20-1E	.71-.79	(18 – 20)	.94 (24)	2.44 (62)
CFXL22-1	CFXL22-1E	.79-.87	(20 – 22)	1.02 (26)	2.52 (64)
CFXL26-1	CFXL26-1E	.87-1.02	(22 – 26)	1.18 (30)	2.87 (73)
CFXL30-1	CFXL30-1E	1.02-1.18	(26 – 30)	1.34 (34)	3.03 (77)
CFXL34-1	CFXL34-1E	1.18-1.34	(30 – 34)	1.50 (38)	3.19 (81)
CFXL38-1	CFXL38-1E	1.34-1.50	(34 – 38)	1.65 (42)	3.35 (85)
CFXL42-1	CFXL42-1E	1.50-1.65	(38 – 42)	1.81 (46)	3.50 (89)



Ribbed strain relief saddle clamps withstands increased pull forces for long-term durability



Double clamp housing, including top/bottom saddle clamps and one stacker saddle clamp

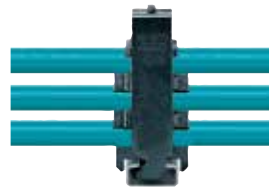

Triple clamp housing, including top/bottom saddle clamps and two stacker saddle clamps

Part No. Steel	Part No. Stainless Steel	For cable diameters		B ⁺²	H
		in.	(ø mm)		
CFXL12-2	CFXL12-2E	.24-.47	(6 – 12)	.63 (16)	3.07 (78)
CFXL14-2	CFXL14-2E	.47-.55	(12 – 14)	.71 (18)	3.15 (80)
CFXL16-2	CFXL16-2E	.55-.63	(14 – 16)	.79 (20)	3.31 (84)
CFXL18-2	CFXL18-2E	.63-.71	(16 – 18)	.87 (22)	3.39 (86)
CFXL20-2	CFXL20-2E	.71-.79	(18 – 20)	.94 (24)	3.62 (92)
CFXL22-2	CFXL22-2E	.79-.87	(20 – 22)	1.02 (26)	3.39 (86)
CFXL26-2	CFXL26-2E	.87-1.02	(22 – 26)	1.18 (30)	4.53 (115)
CFXL30-2	CFXL30-2E	1.02-1.18	(26 – 30)	1.34 (34)	4.84 (123)
CFXL34-2	CFXL34-2E	1.18-1.34	(30 – 34)	1.50 (38)	5.16 (131)

Part No. Steel	For cable diameters in.	(ø mm)	B ⁺²	H
CFXL14-3	.47-.55	(12 – 14)	.71 (18)	4.02 (102)
CFXL16-3	.55-.63	(14 – 16)	.79 (20)	4.25 (108)
CFXL18-3	.63-.71	(16 – 18)	.87 (22)	4.49 (114)
CFXL20-3	.71-.79	(18 – 20)	.94 (24)	4.72 (120)
CFXL22-3	.79-.87	(20 – 22)	1.02 (26)	4.96 (126)

PDF: igus.com/e-chain-pdfs
Product information: igus.com/e-chains



Characteristics of igus® Chainfix clamps - stacker elements

- Built-in ribs for security of cables in the strain relief
- Optimized stacker saddles, retained by ① locking spring and with ② spring grooves for a simplified and precise installation
- Conventional stacker saddles
- Long contact surface improves the clamp's stability
- More secure due to high stiffness
- Suitable for CFX and CFXL clamps



CGXX | Bottom saddles to slide into the clamp housing as single part

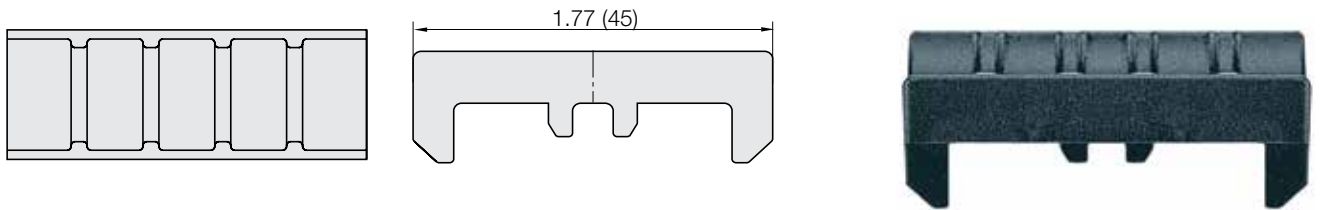

CDXX | Conventional stacker saddles for all for all double and triple clamps as single part

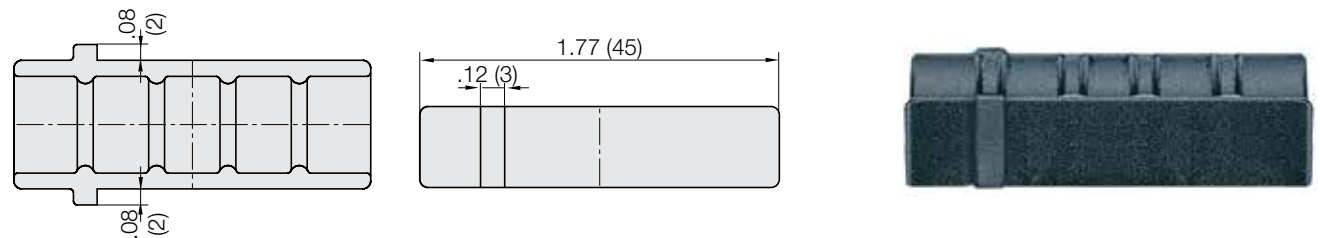

CD-XX-C | Optimized stacker saddles for all double and triple clamps as single part

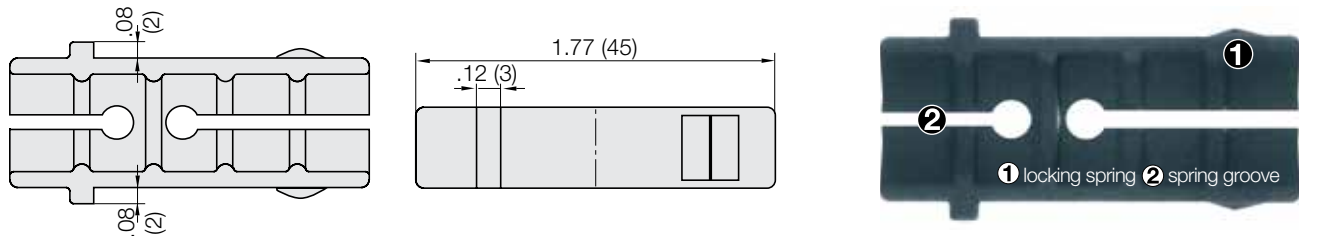

Part No. Clamp	CGXX bottom saddle for singles	CDXX stacker saddle for doubles & triples	CD-XX-C optimized stacker saddle for doubles & triples	Diameter	
				in.	(mm)
CFX / CFXL12-1	CG12	CD12	—	.24-.47	(6 – 12)
CFX / CFXL14-1	CG14	CD14	CD-14-C	.47-.55	(12 – 14)
CFX / CFXL16-1	CG16	CD16	CD-16-C	.55-.63	(14 – 16)
CFX / CFXL18-1	CG18	CD18	CD-18-C	.63-.71	(16 – 18)
CFX / CFXL20-1	CG20	CD20	CD-20-C	.71-.79	(18 – 20)
CFX / CFXL22-1	CG22	CD22	CD-22-C	.79-.87	(20 – 22)
CFX / CFXL26-1	CG26	CD26	CD-26-C	.87-1.02	(22 – 26)
CFX / CFXL30-1	CG30	CD30	CD-30-C	1.02 -1.18	(26 – 30)
CFX / CFXL34-1	CG34	CD34	CD-34-C	1.18 -1.34	(30 – 34)
CFX / CFXL38-1	CG38	—	—	1.34-1.50	(34 – 38)
CFX / CFXL42-1	CG42	—	—	1.50-1.65	(38 – 42)

Please note: When using chainfix clamps on profile rail in the mounting bracket for Series E4-32/H4-32/R4-32, 280/290/ R770, 2828/2928/R7728, 28/29/R77 a shortened bottom saddle has to be used.



The Part No. for this is "K", Example: **Part No. CFX12-1K**

Characteristics of igus® Chainfix Multi-Clamps

The proven Chainfix clamps now even more versatile. New parts offer numberless solutions to assemble.

- New universal strain relief
- Save assembly time and space
- Compact and modular
- For small outer diameters
- Cost-effective

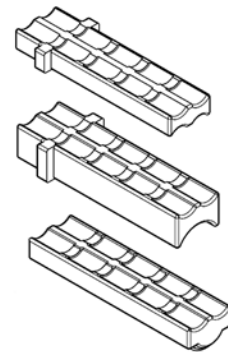
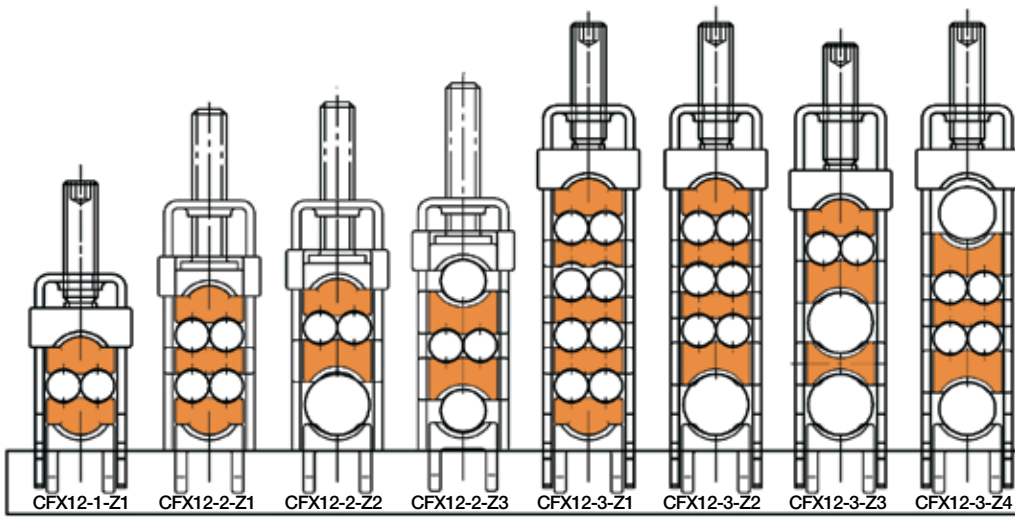

New universal saddle clamps

Part No.	Part No. trays as single parts				For cables	
	CDA-4/4-8	CD-4/4	CD-4/4-8	CD-12	Max. Diameter	
					in.	(mm)
CFX12-1-Z1	X (2-piece)	–	–	–	.24	(6)
CFX12-2-Z1	X (2-piece)	X (1-piece)	–	–	.24	(6)
CFX12-2-Z2	X (1-piece)	–	X (1-piece)	–	.24 + .47	(6 + 12)
CFX12-2-Z3	–	–	X (2-piece)	–	.24 + .31	(6 + 8)
CFX12-3-Z1	X (2-piece)	X (3-piece)	–	–	.24	(6)
CFX12-3-Z2	X (1-piece)	X (2-piece)	X (1-piece)	–	.24 + .47	(6 + 12)
CFX12-3-Z3	X (1-piece)	–	X (1-piece)	X (1-piece)	.24 + .47	(6 + 12)
CFX12-3-Z4	–	X (1-piece)	X (2-piece)	–	.24 + .39	(6 + 10)

For stainless-steel version please insert index **SS** Example: Part No. CFX-12-3-Z1**SS**

Standard material steel zinc-coated

PDF: igus.com/e-chain-pdfs
Product information: igus.com/e-chains



Characteristics of igus® chainfix tiewrap plate Series 2000

Option 1A: Tiewrap plate as single part

- Available as individual component
- Screwed on KMA* with profile rail (*polymer metal mounting bracket)
- Can be stacked onto the mounting bracket
- Can be used at the end of the e-chain® or within electrical cabinets
- Accessory for igus® e-chain systems®

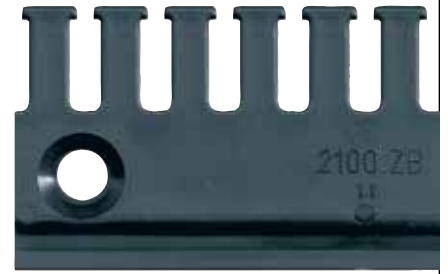

For Series:

E-Z Chain®

- E200/Z200

System E2/000

- 1400/1500/1450/1480
- 2400/2500/2450/2480
- 255

System E2 Tubes

- R117/R118
- R48

System E4-1

- E4-21

System E6

- E6-29/R6-29
- E6-35
- E6-40

System E6-1

- E61-29

Tiewrap plates as an individual part

Available as an individual component or can be fixed onto a mounting bracket with the use of a profile rail.

Series 2000

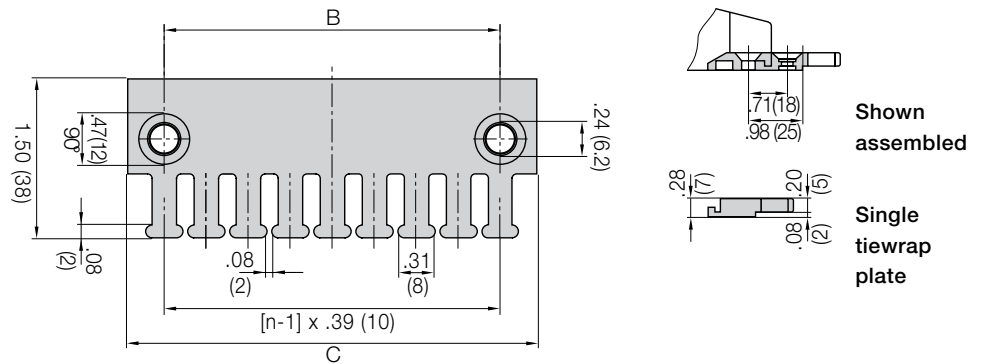

Tiewrap Plates	n Number of Teeth	Dimension C	Dimension B	
2020-ZB	3	1.18 (30)	.59 (15)	
2030-ZB	4	1.57 (40)	.79 (20)	
2040-ZB	5	1.97 (50)	1.18 (30)	
2050-ZB	6	2.36 (60)	1.57 (40)	
2070-ZB	8	3.15 (80)	2.36 (60)	
2090-ZB	9	3.54 (90)	2.76 (70)	= 2030-ZB + 2040-ZB combined
2100-ZB	10	3.94 (100)	3.15 (80)	
2125-ZB	12	4.72 (120)	3.94 (100)	= 2050-ZB x 2 pieces combined

If used with KMA brackets with profile rail please add "KMA" to the end of the part number.

Example: 2020-ZBKMA

Cable tiewraps as individual parts

Cable tiewraps 100 pieces/bag	Width x Length		Maximum Ø		Tensile Strength	
	in.	(mm)	in.	(mm)	lbs	(N)
CFB-001	.19 x 5.91	(4.8 x 150)	1.42	(36)	50	(222)

Characteristics of igus® chainfix tiewrap plate Series 3000

Option 1B: Tiewrap plate as single part

- Available as individual component
- Screwed on KMA* with profile rail (*polymer metal mounting bracket)
- Can be stacked onto the mounting bracket
- Can be used at the end of the e-chain® or within electrical cabinets
- Accessory for igus® e-chain systems®

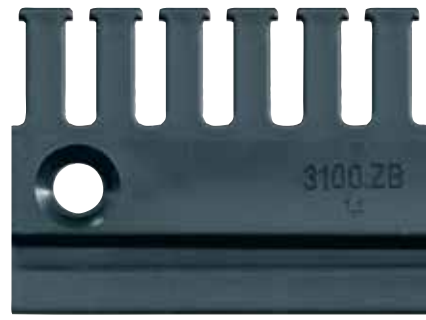

Tiewrap plates as an individual part

Available as an individual component or can be fixed onto a mounting bracket with the use of a profile rail.

Series 3000

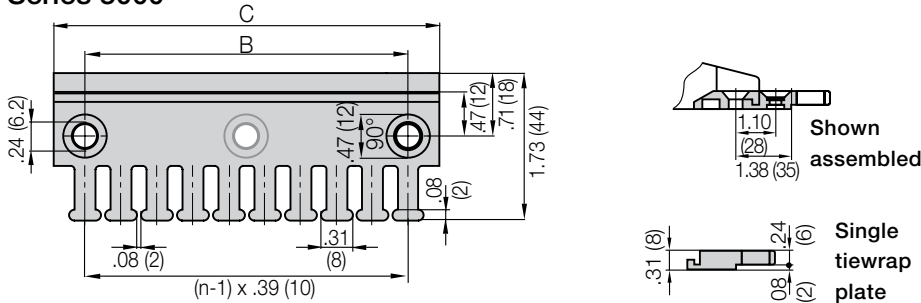

Tiewrap Plate	n Number of Teeth	C Overall Width in. (mm)	B Bore Width in. (mm)	Center Bore
3050-ZB	5	1.97 (50)	1.18 (30)	no
3075-ZB	7	2.95 (75)	2.16 (55)	no
3100-ZB	10	3.94 (100)	3.15 (80)	no
3115-ZB	11	4.53 (115)	3.74 (95)	no
3125-ZB	12	4.92 (125)	4.13 (105)	no
3150-ZB	15	5.91 (150)	5.12 (130)	no
3175-ZB	17	6.89 (175)	6.10 (155)	no
3200-ZB	20	7.87 (200)	7.09 (180)	yes
3225-ZB	22	8.86 (225)	8.07 (205)	yes
3250-ZB	25	9.84 (250)	9.06 (230)	yes

If used with KMA brackets with profile rail please add "KMA" to the end of the part number.

Example: 3050-ZBKMA

Cable tiewraps as individual parts

Cable tiewraps 100 pieces/bag	Width x Length		Maximum Ø		Tensile Strength	
	in.	(mm)	in.	(mm)	lbs	(N)
CFB-001	.19 x 5.91	(4.8 x 150)	1.42	(36)	50	(222)



For Series:

E-Z Chain®

- E26/Z26
- E300/Z300

System E2/000

- 2600/2700/2650/2680
- 3400/3500/3450/3480

System E4-1

- E4-32/H4-32/R4-32
- E4-42/H4-42/R4-42
- E4-56/H4-56/R4-56
- E4-80/H4-80/R4-80
- E4-112/H4-112/R4-112

● 800

● 840

System E4-1 Light

● E4-38L/R4-38L

● E4-48L/R4-48L

System E4/light

● 14040/14140/R18840

● 15050/15150/R19850

● 14240/14340

● 1640

System E6

● E6-52/R6-52

● E6-62

● E6-80L / E6-80



Characteristics of igus® Chainfix tiewrap plate

Option 1: With clip-on connection for the profile rail

- Can be clipped onto KMA profile rail
- Easy to assemble without any screws
- Easy to remove with screwdriver
- Can be used at the end of the e-chain® or within electrical cabinets
- Accessory for igus® e-chain systems®



Option 1 - Tiewrap plate for profile rail

Part No.	Number of Teeth	Width of Strain Relief	
		in.	(mm)
3050-ZC	5	1.97	(50)
3075-ZC	7	2.95	(75)



Tiewrap plates for profile rail

For all mounting brackets
with profile rail option

Characteristics of igus® Chainfix tiewrap plate

Option 2: integrated strain relief for E2 e-tubes - Series R

- Strain relief is hidden within the e-tube
- Easy to assemble without any screws
- Can be used at the end of the e-chain® or within electrical cabinets
- Accessory for igus® e-chain systems®



Option 2 - Tiewrap plate for E2 e-tubes Series R

Part No. fixed crossbar	Width		Number of teeth	For Series
	in.	(mm)		
3050-Z	1.97	(50)	5	R68
3075-Z	2.95	(75)	7	R68
5850-Z	1.81	(46)	4	R58



e-tubes Series R

- R58
- R68

Characteristics of igus® Chainfix tiewrap plates

Option 3: for fixed crossbars

- Can be fitted to fixed and opening crossbars
- For use with various cable assemblies
- Strain relief on two levels
- Easy to assemble without any screws
- Accessory for igus® e-chain systems®



Option 3 - Tiewrap plate for fixed crossbars

Part No. fixed crossbar	Width		Number of teeth	For Series
	in.	(mm)		
2050-Z	2.36	(60)	6	E/Z200, 2400/2500, 2600/2700
3050-Z	1.97	(50)	5	3400/3500
3075-Z	2.91	(74)	7	3400/3500



For Series:

E-Z Chain®

- E200/Z200

System E2/000

- 2600/2700/2650/2680
- 3400/3500/3450/3480

PDF: igus.com/e-chain-pdfs
Product information: igus.com/e-chains



Characteristics of igus® Chainfix tiewrap plates

Option 4: for opening crossbars

- Can be fitted to fixed and opening crossbars
- For use with various cable assemblies
- Strain relief on two levels
- Easy to assemble without any screws
- Accessory for igus® e-chain systems®



Option 4 - Tiewrap plate for opening crossbars

Part No. opening crossbar	Width		Number of teeth	For Series
	in.	(mm)		
2050-Z	2.36	(60)	6	2600/2700/2650, E4-28, E61-52, E6-52
3035-ZS	1.38	(35)	3	3400/3500/3450
3050-ZS	1.97	(50)	5	3400/3500/3450
3075-ZS	2.91	(74)	7	3400/3500/3450
3850-ZS	1.89	(48)	5	E4/H4/R4-32, E4/H4/R4-42, 14240/14340, 15250/15350, E61-62, E6-62
4550-ZS	1.89	(48)	5	E4/H4/R4-56, E4/H4/R4-.80, E4/R4-.112, 14040/14140/R18840, 14550/14650/19050 15050/15150/R19850, E61-80, E6-80L, E6-80, 1640/R1608
4575-ZS	2.91	(74)	7	E4/H4/R4-56, E4/H4/R4-80, E4/R4-112, 14040/14140/R18840, 14550/14650/19050 15050/15150/R19850, E61-80, E6-80L, E6-80, 1640/R1608
C622-100-ZS	3.15	(80)	8	E4-38L, E4-48L



For Series:

System E2/000

- 2600-2700/2650
- 3400/3500/3450

System E4-1

- E4-28
- E4-32/H4-32/R4-32
- E4-42/H4-42/R4-42
- E4-56/H4-56/R4-56
- E4-80/H4-80/R4-80
- E4-112/R4-112

System E4-1L

- E4-38L
- E4-48L

System E4/light

- 14040/14140/R18840
- 14240/14340
- 14550/14650/R19050
- 15050/15150/R19850
- 15250/15350
- 1640/R1608

System E6

- E6-52/R6-52
- E6-62
- E6-80L
- E6-80

System E6-1

- E61-52

Assembled in seconds - honeycomb strain relief CFU

- Up to 80% faster strain relief for different cables in one slot
- Simply insert cables and hoses into the honeycomb and close
- Easy to make changes - add or remove cables/hoses
- Simplified parts
- Can be used in gliding applications



CFU - Honeycomb strain relief design



Strain relief of different cables in one slot, openable on both sides. Black anodized aluminum rails with side recesses for easier assembly

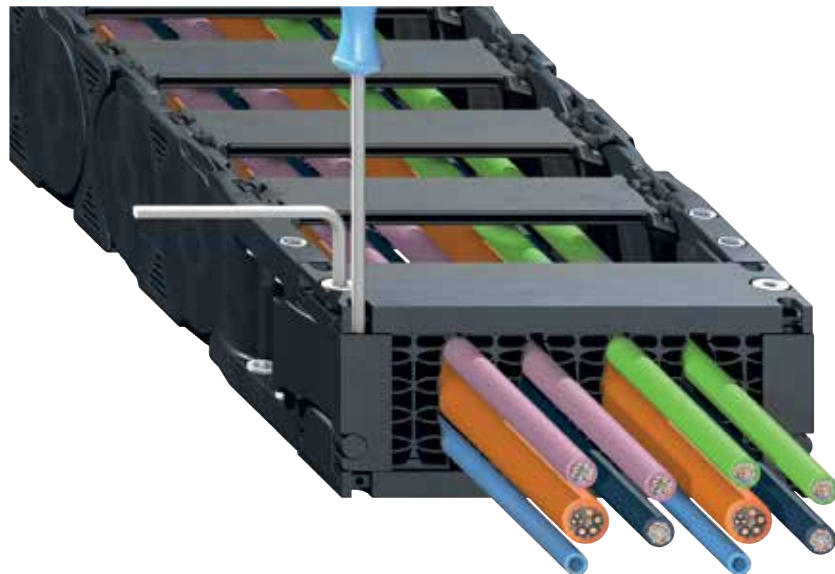

Strain relief can be screwed in from above or below. Compact design is smaller than the mounting bracket of the e-chain® at the fixed end, meaning it can also be used for long travels



For Series:

E2.1

- E2.48

E2/000

- 3400/3500/3450/3480

E2R

- R68

R2.1

- R2.48

E2R

- R68

E4.1L

- E4.48L/R4.48L

E4.1

- E4.42/H4.42/R4.42

E6.1

- E61.52

E6

- E6.52/R6.52



reddot design award
winner 2018



More (technical) information
on request or online
▶ www.igus.com/CFU



Characteristics of igus® strain relief separators - Separator with integrated strain relief teeth

- For the use in the first or last chain link
- Accessory for igus® e-chain systems®
- Easy to assemble without any screws
- For restricted space conditions
- The number of **teeth** is dependent upon the selection of cable (diameter, type) and available space



Strain relief separator with integrated teeth

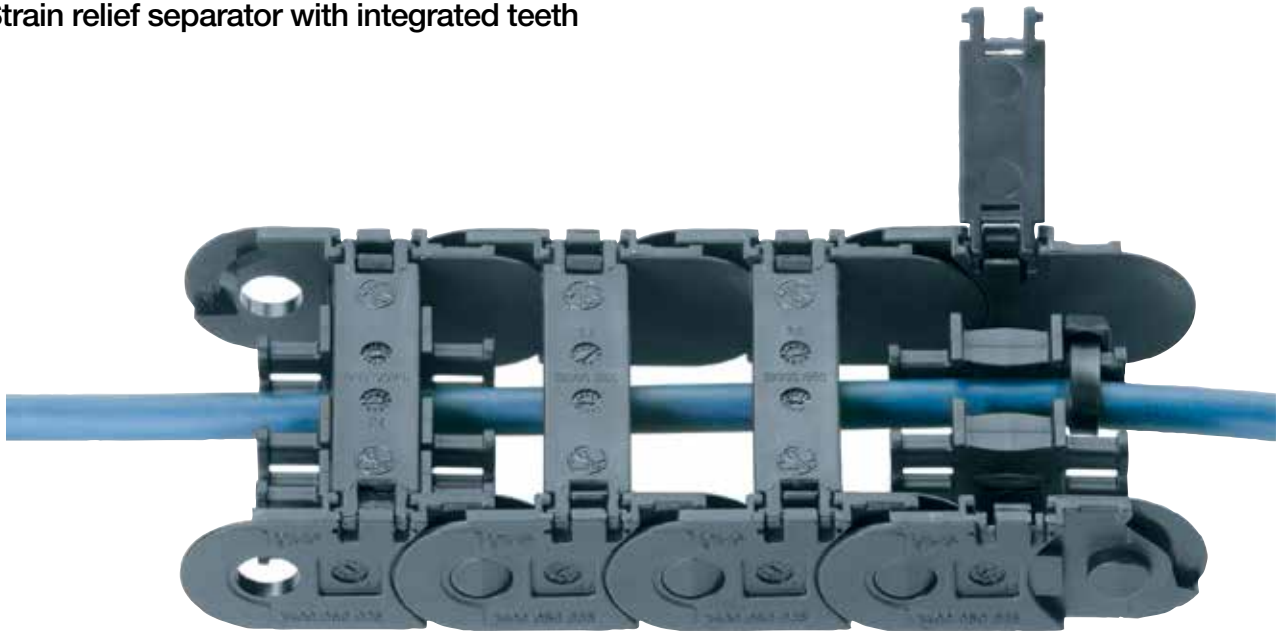

Strain relief separators are assembled either at the first or last e-chain® link. For an intermediate strain relief they can alternatively be assembled in the e-chain®.

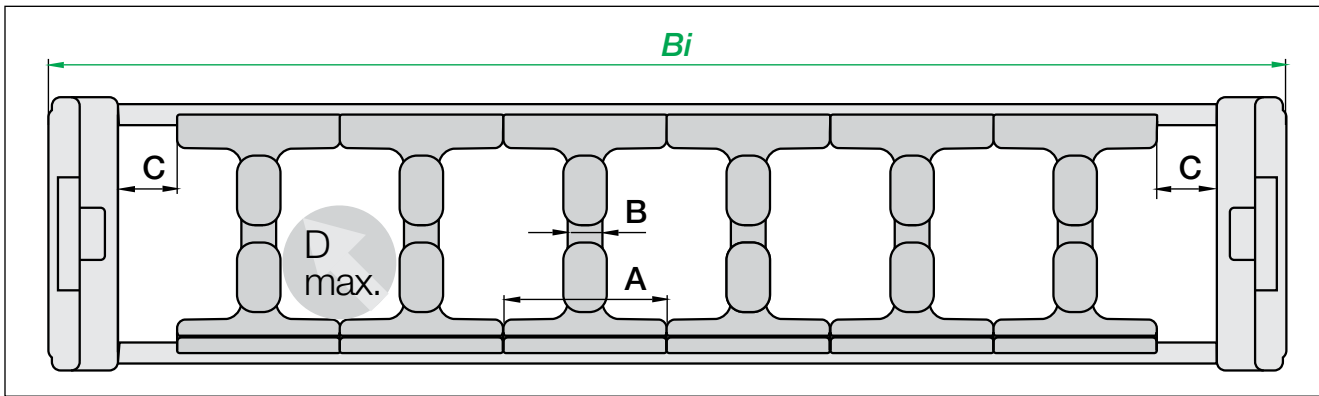

For Series	Part No. Strain Relief Separator	Number Of Teeth	Dimension A		Dimension B		Dimension C Min. distance L/R		Dimension D max. cable Ø	
			in.	(mm)	in.	(mm)	in.	(mm)	in.	(mm)
E2/000 System										
1400/1500	21-1-Z	2	.39	(10)	.16	(4)	-	-	.24	(6)
2400/2500	2020-Z	2	.39	(10)	.16	(4)	-	-	.24	(6)
2450/2480	2020-ZR	2	.39	(10)	.16	(4)	-	-	.24	(6)
2600/2700	262-Z	3	.39	(10)	.16	(4)	-	-	.24	(6)
3400/3500	301-Z	3	.71	(18)	.16	(4)	-	-	.55	(14)
3450/3480	34501-Z	3	.55	(14)	.16	(4)	-	-	.39	(10)
E2 R100 System										
R157/R158	1585-01-Z	3	.87	(22)	.16	(4)	-	-	.71	(18)
R167/R168	1685-01-Z	4	.87	(22)	.16	(4)	-	-	.71	(18)
E2 R System										
R48	481-ZR	2	.39	(10)	.14	(3.5)	.39	(10)	.26	(6.5)
E4-1L System										
E4-31L/R4-31L	31-Z	4	.35	(9)	.16	(4)	.24	(6)	.24	(6)
E4-48L/R4-48L	48-Z	4	.55	(14)	.18	(4.5)	.31	(8)	.79	(20)
E4-48L/R4-48L	48-ZS	4	.55	(14)	.18	(4.5)	.31	(8)	.79	(20)
E4-1 System										
E4-21	T2103-Z	2	.31	(8)	.16	(4)	.51	(13)	.16	(4)
E4-28	28-Z	2	.39	(10)	.16	(4)	-	-	.24	(6)
R4-28	28-ZT	2	.39	(10)	.16	(4)	.59	(15)	.24	(6)
T3 System										
T3-29	E6-29-02-Z	2	.31	(8)	.16	(4)	.47	(12)	.16	(4)
E6 / E6-1 System										
E6-29/E61-29	E6-29-02-Z	2	.31	(8)	.16	(4)	.47	(12)	.16	(4)
R6-29	E6-29-02-Z	2	.31	(8)	.16	(4)	.47	(12)	.16	(4)
E6-35/E61-35	E6-35-02-Z	3	.31	(8)	.16	(4)	.47	(12)	.16	(4)
E6-40/E61-40	E6-40-02-Z	3	.51	(13)	.16	(4)	-	-	.31	(8)

For Series:

System E2/000

- 1400/1500
- 2400/2500
- 2450/2480
- 2600/2700
- 3400/3500
- 3450/3480

System E2 R100

- R157/R158
- R167/R168

System E2 R

- R48

System E4-1L

- E4-31L / R4-31L
- E4-48L / R4-48L

System E4-1

- E4-21
- E4-28/R4-28

System T3

- T3-29

System E6-1

- E61-29 / EF61-29
- E61-35
- E61-40

System E6

- E6-29
- R6-29
- E6-35
- E6-40

PDF: igus.com/e-chain-pdfs
Product information: igus.com/e-chains



For Series E2/000

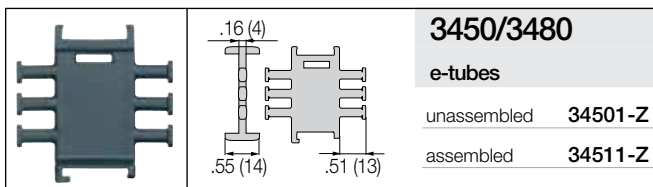
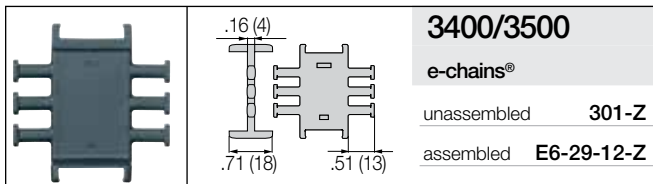
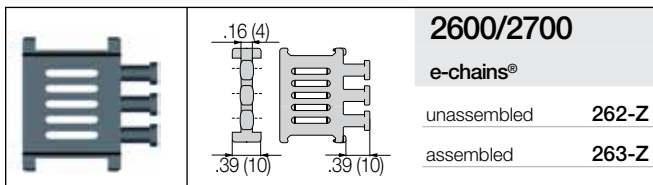
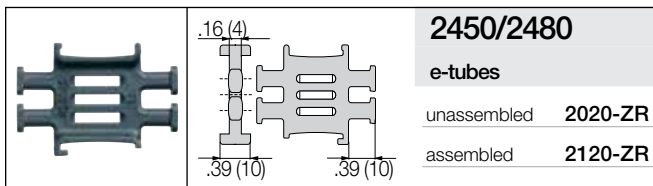
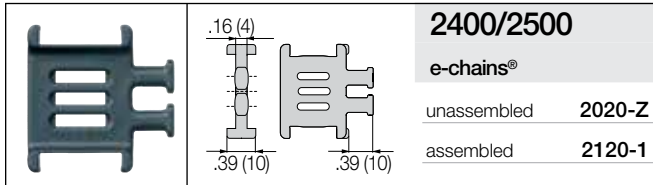
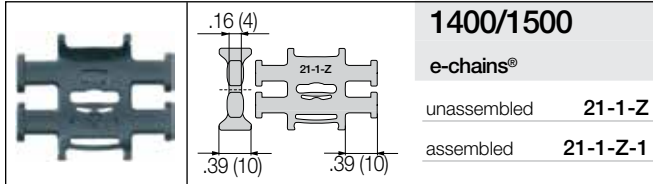

For Series R100 e-tubes

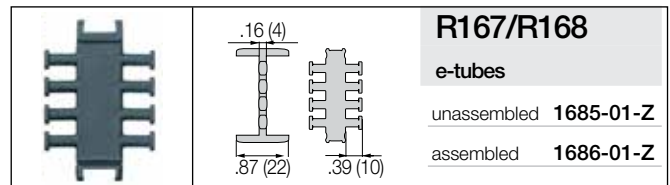
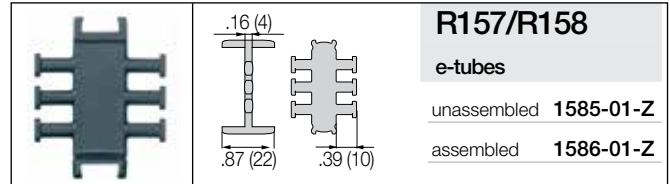

For Series R E2 e-tubes

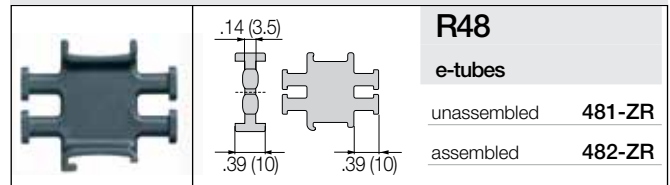

For Series E4-1L

		<p>E4-31L / R4-31L e-chains® / e-tubes</p> <p>unassembled 31-Z assembled 31-Z-1</p>
--	--	--

		<p>E4-48L / R4-48L e-chains® / e-tubes</p> <p>unassembled 48-Z assembled 48-Z-1</p>
--	--	--

		<p>E4-48L / R4-48L e-chains® / e-tubes</p> <p>unassembled 48-ZS assembled 48-ZS-1</p>
--	--	--

For Series E4-1

		<p>E4-21 e-chains®</p> <p>unassembled T2103-Z assembled T2113-Z</p>
--	--	--

		<p>E4-28 e-chains®</p> <p>unassembled 28-Z assembled 28-Z-1</p>
--	--	--

		<p>R4-28 e-chains®</p> <p>unassembled 28-ZT assembled 28-ZT-1</p>
--	--	--

For Series T3

		<p>T3-29 e-chains®</p> <p>unassembled E6-29-02-Z assembled E6-29-12-Z</p>
--	--	--

For Series E6-1 / E6 / R6

		<p>E6-29/E61-29 e-chains®</p> <p>unassembled E6-29-02-Z assembled E6-29-12-Z</p>
--	--	---

		<p>R6-29 e-tubes</p> <p>unassembled R6-29-02-Z assembled R6-29-12-Z</p>
--	--	--

		<p>E6-35/E61-35 e-chains®</p> <p>unassembled E6-35-02-Z assembled E6-35-12-Z</p>
--	--	---

		<p>E6-40 / E61-40 e-chains®</p> <p>unassembled E6-40-02-Z assembled E6-40-12-Z</p>
--	--	---



CFV strain relief element - for stepped strain relief for use outside of the e-chain® section

- Easy strain relief for cables, even in fully enclosed tubes and with different connectors
- For e-chains® and e-tubes
- Easy to retrofit
- Simple installation into KMA mounting brackets or top-hat (DIN) rail 15 (TS92-31)

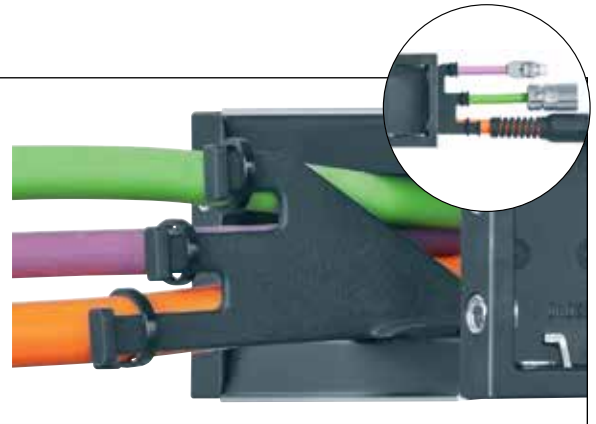

Part No.	For series	Inner height <i>hi</i>		For use in
		in.	(mm)	
CFV-31-N15	E4-31L/R4-31L	1.22	(31)	Top-hat (DIN) rail 15 (TS92-31)
CFV-R2-26-Z	R2-26	1.02	(26)	KMA*
CFV-R2-40-Z	R2-40	1.57	(40)	KMA*
CFV-42-C	2600/2700/2650/2680 3400/3500/3450/3480 E4-32/H4-32/R4-32 E4-42/H4-42/R4-42 E4-38L/R4-38L E4-48L/R4-48L	1.38 1.77 1.26 1.65 1.50 1.89	(35) (45) (32) (42) (38) (48)	KMA* KMA* KMA* KMA* KMA* KMA*
CFV-80-C	R2-75 E4-64L E4-56/H4-56/R4-56 E4-80/H4-80/R4-80	2.95 2.52 2.20 3.15	(75) (64) (56) (80)	KMA* KMA* KMA* KMA*

*KMA = plastic metal mounting bracket

For Series:

System E2/000

- 2600/2700
- 2650/2680
- 3400/3500
- 3450/3480

System R2-1

- R2-26
- R2-40
- R2-75

System E4-1

- E4-32/H4-32/R4-32
- E4-42/H4-42/R4-42
- E4-56/H4-56/R4-56
- E4-80/H4-80/R4-80

System E4-1 Light

- E4-31L/R4-31L
- E4-38L/R4-38L
- E4-48L/R4-48L
- E4-64L



CFV stepped strain relief element easily clipped in from above

Characteristics of igus® Chainfix nuggets for profile rails

- Universal cable attachment in profile rail
- Simple strain relief - pre-attached cable tiewraps
- Minimum space required
- Easy to assemble without any screws and tools
- Adjustable to every e-chain® filling



Option 1 - CFN nuggets for profile rail

Part No. Nugget	For profile rails	Cable Diameter Max.		Dimension A	
		in.	(mm)	in.	(mm)
CFN-20	92-42.../92-42...E	.79	(20)	.43	(10.8)
CFN-30-52	92-42.../92-42...E	1.18	(30)	.65	(16.4)

For Series:

For profile rail

- For all mounting brackets with profile rail option

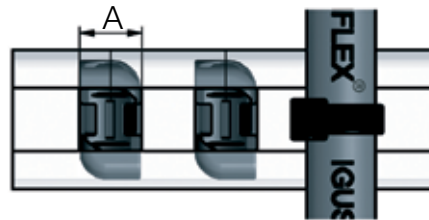
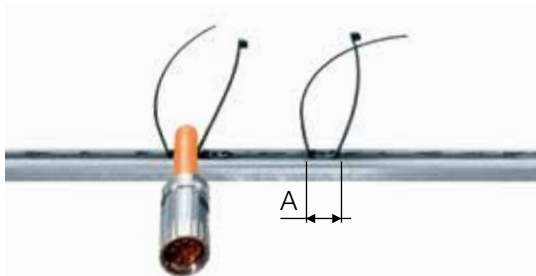

Option 2 - CFN nuggets for top-hat (DIN) rail

Part No. Nugget	For top-hat DIN rail	Cable Diameter Max.		Dimension A	
		in.	(mm)	in.	(mm)
CFN-20-N35	Top-hat (DIN) rail 35	.79	(20)	.43	(10.8)

For Series:

For top-hat (DIN) rail

- Top-hat (DIN) rail 35

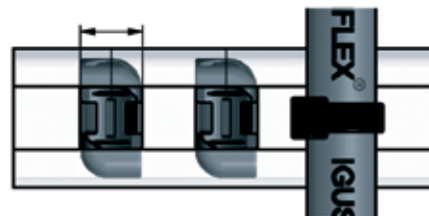
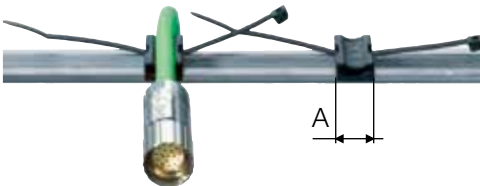

Characteristics of the modular igus® CFB: Polymer strain relief connector system to be mounted onto the profile rail

- Customized strain relief solutions can be offered
- 2 variations available
- Fast assembly by standard screw connection
- Can be mounted in the mounting bracket or in front of the e-chain®
- Customized production from 1 piece
- Low priced and effective



CFB 907-881- Polymer strain relief connector system

Parts List Description	Part No.	Quantity
① Outer fixing block	CFB20-1	N x 2
② Clamping bar	907-881-1-XXX	2
③ Threaded bolt with plate	907-825-2-LLL	2
④ Hexagon nut M8	MAT 0040012	2
⑤ Profile rail (part of KMA)	92-42-KMA	1
⑥ Strain relief block	Customer specific	1

Order key

907-881-XXX-N



N = Number of layers fixing blocks ①
 XXX= Bi - 3 mm (mounting bracket)
 Part No. with version 881



**Please contact igus®
for individual design**

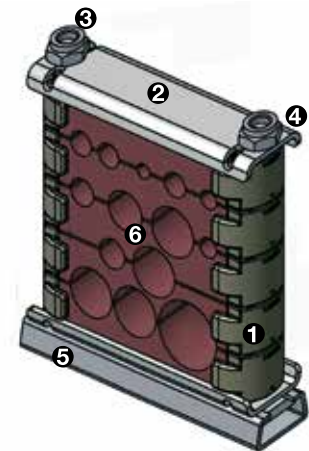

CFB 907-825- Polymer strain relief connector system

Parts List Description	Part No.	Quantity
① Outer fixing block	CFB20-1	N x 2
② Inner fixing block	CFB20-2	N
③ Clamping bar	907-825-1-XXX	2
④ Threaded bolt with plate	907-825-2-LLL	3
⑤ Hexagon nut M8	MAT 0040012	3
⑥ Profile rail (part of KMA)	92-42-KMA	1
⑦ Strain relief block	Customer specific	1
⑧ Strain relief block	Customer specific	1

Order key

907-825-XXX-N



N = number of layers fixing blocks ① + ②
 XXX= Bi - mm (mounting bracket)
 Part No. with version 825



**Please contact igus®
for individual design**

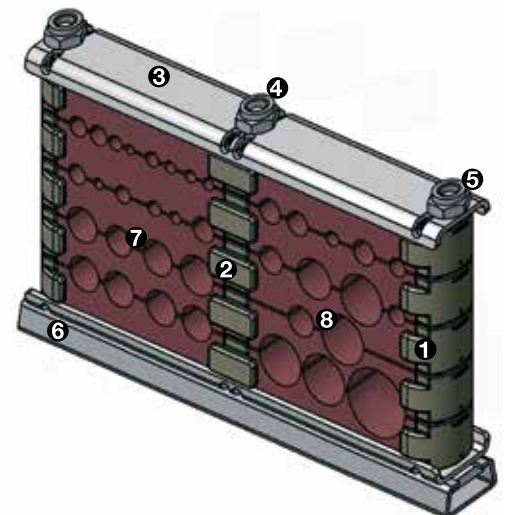

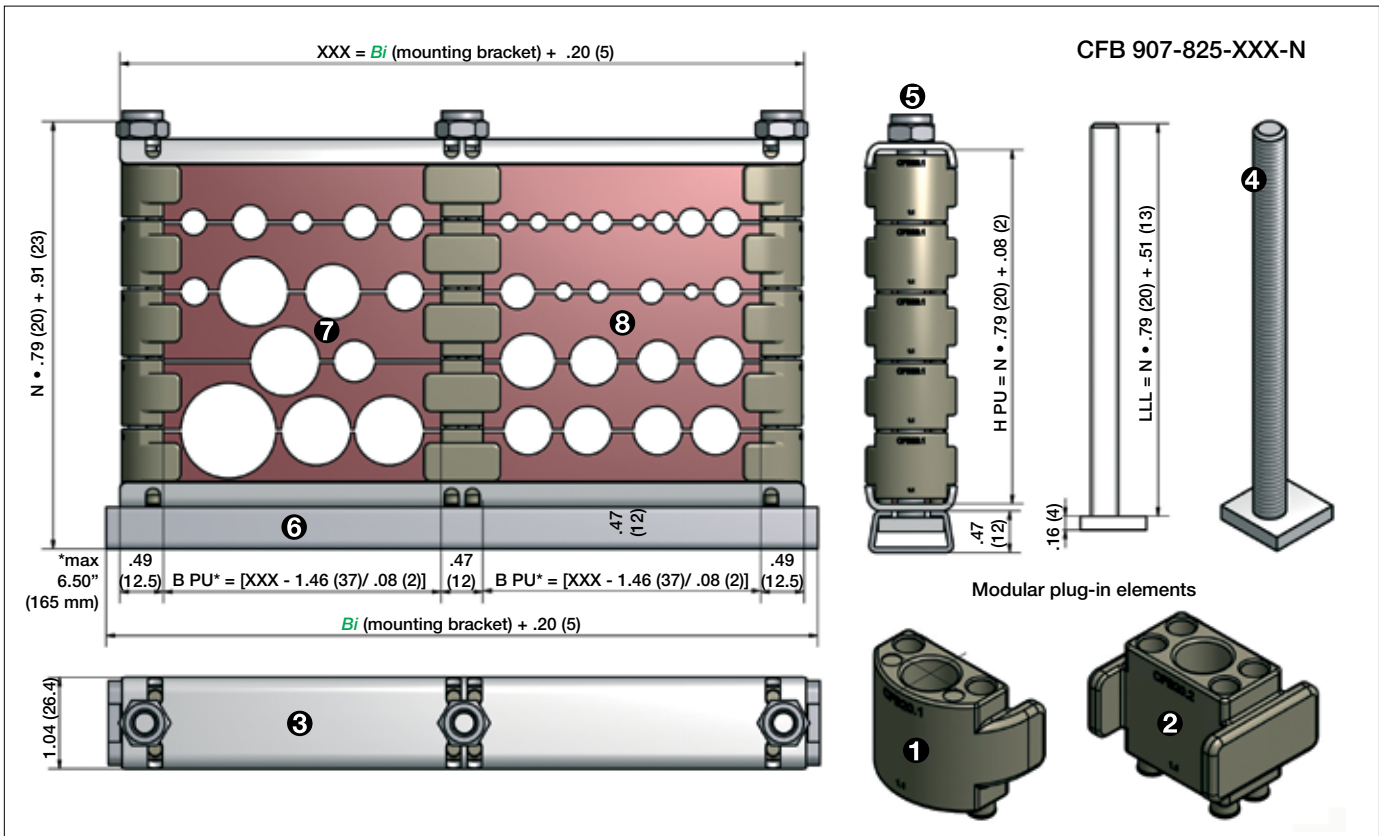
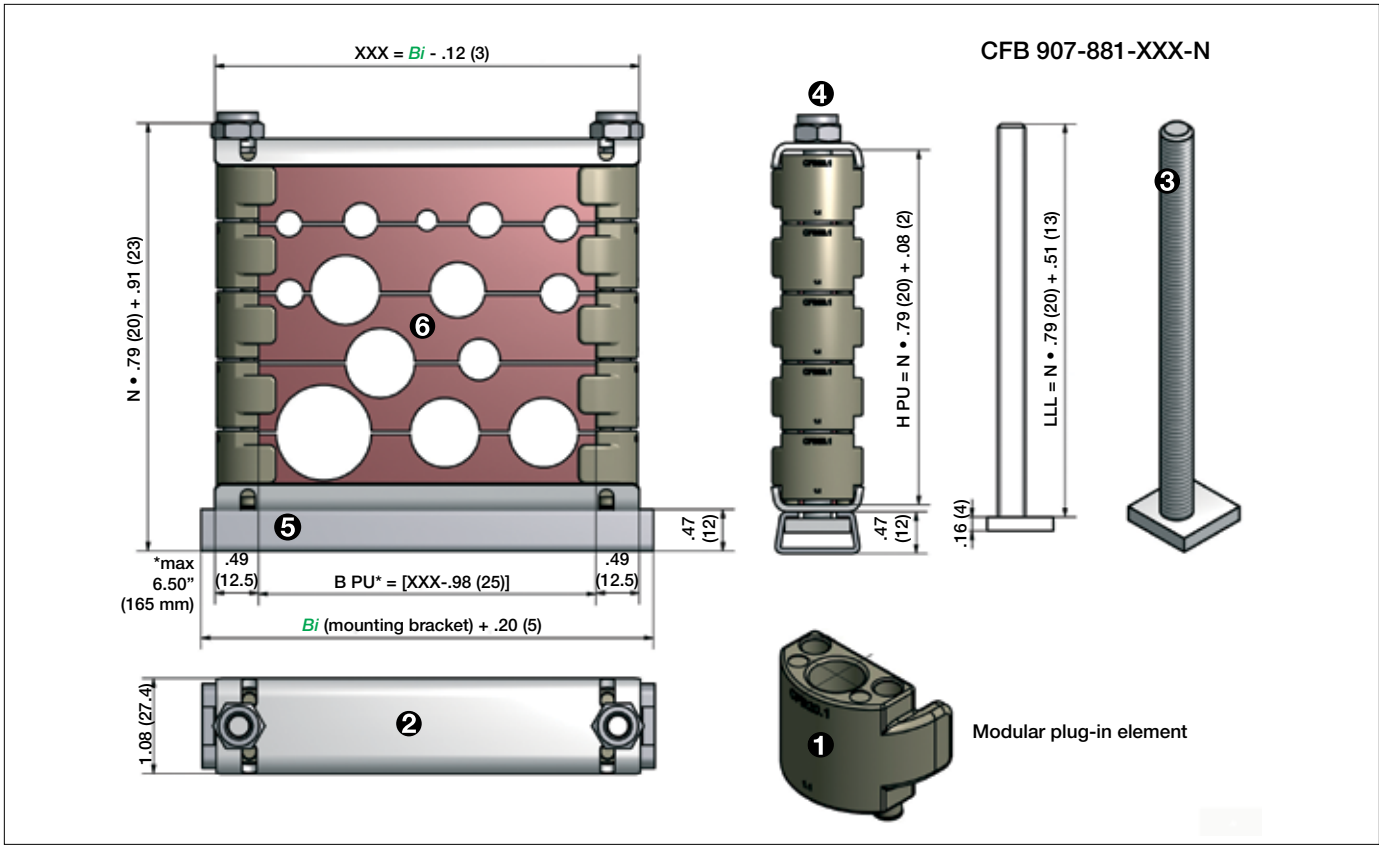

Delivery time upon request

igus® strain relief block for small hoses and cables

- Modular system for great adaptability
- No hose damage
- Space-saving design
- Hoses and cables can be installed together in the same e-chain®
- Accommodation of hose diameters from .17 to .55 (4.3 to 14 mm)
- Easy installation - pressing the hose into the locating notch provides reliable fastening without hardware

The modules accommodate hoses from .17 to .55 (4.3 to 14 mm), 3 x .17 (3 x 4.3 mm) hoses can be fitted on top of each in module CFS-4.3 and 2 hoses can be fitted directly on top of each other in one notch using module CFS-6. The modules have a width of 1.08 (27.5), are inserted into the base plate and then fastened in position with M4 countersunk-head screws. The exception is module CFS-55.9 which offers the capacity for 5 x .35 (5 x 9 mm) hoses with twice the width. The base plate and cover plate are available in widths ranging from 2.95 to 9.45 (75 to 240 mm). The height of the spacers and modules is .63 (16 mm). Several layers can be installed directly above one another.

Part No. Block	Hose Ø mm	Number of Hoses	Width	
			in.	(mm)
CFS-4.3	.17 (4.3)	4 – 12	1.08	(27.5)
CFS-6	.24 (6)	3 – 6	1.08	(27.5)
CFS-9	.35 (9)	2	1.08	(27.5)
CFS-55.9	.35 (9)	5	2.16	(55.0)
CFS-10	.39 (10)	2	1.08	(27.5)
CFS-14	.55 (14)	1	1.08	(27.5)

Part No. Base Plate	Part No. Cover Plate	Width	
		in.	(mm)
CFSU-75	CFS-P-75	2.95	(75)
CFSU-102.5	CFS-P-102.5	4.04	(102.5)
CFSU-130	CFS-P-130	5.12	(130)
CFSU-185	CFS-P-185	7.28	(185)
CFSU-212	CFS-P-212	8.34	(212)
CFSU-240	CFS-P-240	9.45	(240)

Part No. Spacer	Height	
	in.	(mm)
CFSD-16	.63	(16)
CFSD-12	.47	(12)

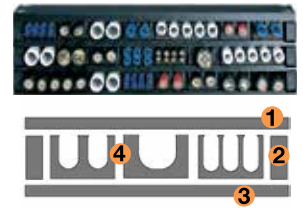

- 1 Cover plate
- 2 Spacers
- 3 Base plate
- 4 Grid-dimensioned modules
W = 1.08 (27.5 mm)
H = .63 (16 mm)



igus®
e-chain system®

Telephone 1-800-521-2747

Internet: igus.com
email: sales@igus.com
QuickSpec: igus.com/quickspec

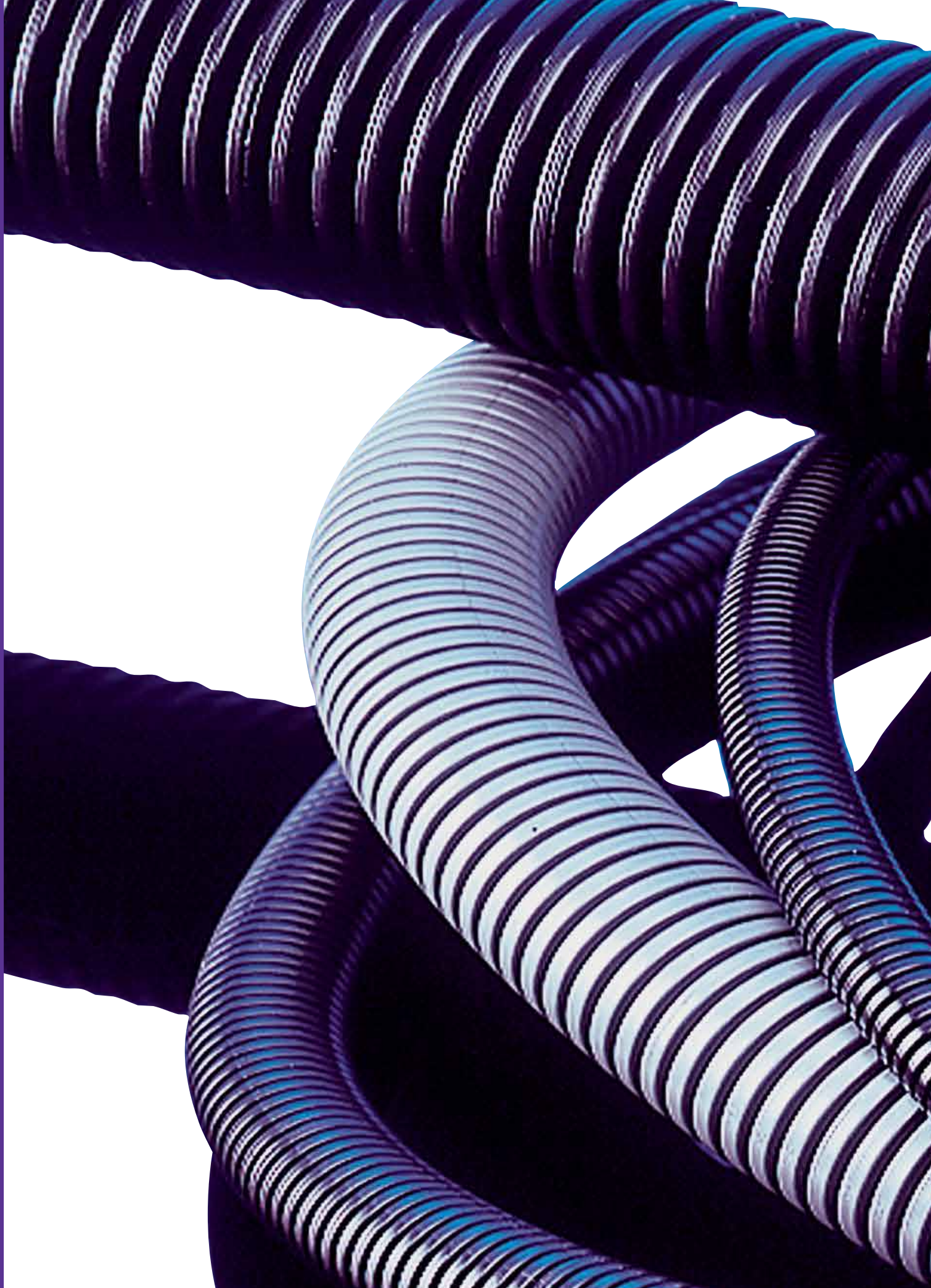



PMA

PMA Overview

PMAFLEX | Conduits | Cable protection



Product	Description
PMA conduits	
PACOF	Flexible, medium, split
PPCOF	Very flexible, medium, split
LN	Two-part lock nuts
LNO	One-piece split connectors
VCS	Flexible, heavy
PIS/PIH	Highly flexible, medium
CYL	Very flexible, medium

PMAFIX | Connectors | Safety and sealing systems



Product	Description
PMA connectors	
IP66 - stat., IP54 dyn.	Universal safety clip
IP68 - stat., IP67 dyn.	Oval clip
PMAFIX / PMAFLEX	Connectors
PMAFIX connectors VW	90° elbow, PG
PMAFIX connectors VA	45° elbow, metric & PG
PMAFIX connectors VN	Straight, metric
PMAFIX connectors VN	Straight, PG
PMAFIX connectors VB	90° curved elbow, metric & PG
PMAFIX connectors VO	Flange 90°

PMA | Accessories



Product	Description
PMA accessories	
PMAFIX FH-O	One-piece system support
PMA VH	System supports
PMA GPS	One-piece system supports
PMA MN	Hexagonal lock nuts, metric & PG
PMA SGB	Tube clamps
PMA 514	Plug screws, metric & PG

PMA Protective Corrugated Tubing

Tubes, connectors, system supports, and accessories

PMA - corrugated conduits, connectors, system support, and accessories

- Wide range of tubes
- Long service life of the tubes especially through millions of reverse bending cycles
- UL-recognized products available
- PMAFIX safety locking system

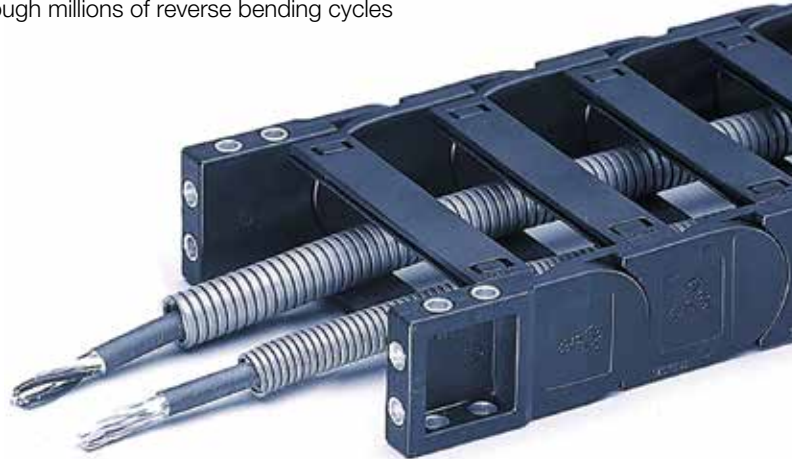

igus® E-Chain® System E4 combined with PMAFLEX protective tubing and igus Chainflex® CF9

PMA-Program - Wide selection of tubes and systems

The PMA cable protection system is applied wherever the mechanical protection of electrical wires and cables is required. Very flexible types of conduits are especially suitable for the additional protection of leads in E-Chain systems® if required. By combining technical excellence with rigorous international safety standards, PMA meets the demands of industry worldwide - specializing in applications from the machine building industries to high tech manufacturing; heavy plant and vehicle construction; fiber optics, solar energy and robotic applications with high speed and millions of reversed bending cycles.

PMAFLEX - Conduits

PMAFLEX covers different conduit types for a variety of applications in cable protection. The **PMAFLEX** range offers conduits for technically demanding applications and special requirements. Conduit sizes range from 4.5 mm to 125 mm diameters, from lightweight to heavyweight, and pliable to highly flexible. Standard colors are black and grey. Many conduits are specially approved, e.g. CSA, UL Recognition, NF, SNCF, DB, etc.

PMAFIX- Connectors

The designation **PMAFIX** describes a very large range of connectors for PMA conduits with the patented PMA safety clip system. Connectors are available for ingress protection IP66 and IP68. IP66 connectors are fitted with a pre-installed universal safety clip which ensures a quick "push-in" installation. IP68 connectors for increased requirements will be delivered with a special conduit seal cap.<?>



PMA COFLEX Conduit PACOF - medium, flexible, split

The PMA COFLEX conduit type PACOF has been created for retrofit and pre-loomed applications. New cables can be added to existing arrangements without the need for re-wiring or re-threading within the building of machines and installations. This product is suitable for vehicle manufacturing and building construction. Split connectors and locknuts are available for this product group.

Temperature range:

-40°F to +221°F (-40°C to +105°C), or a short time up to +320°F (+160°C)

Features:

- specially modified PA6 (polyamide 6)
- good closure up to IP50
- self-extinguishing
- halogen-free and cadmium-free

Chemical resistance:

- fuels
- mineral oils
- fats
- alkalis
- weak acids and bases, etc.

Part No. structure

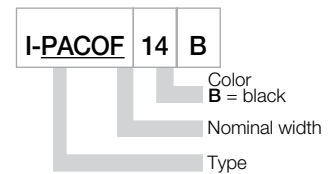

Part No. (Black)	Conduit size		Inside diameter d1 (mm)	Outside diameter d2 (mm)	Radius (stat.) (mm)	PU (m)
	Nominal	Metric				
I-PACOF-07B	7	10	5.6	10.0	30	50
I-PACOF-10B	10	12	8.5	12.8	33	50
I-PACOF-12B	12	16	11.0	15.6	35	50
I-PACOF-17B	17	20	15.5	21.1	45	50
I-PACOF-23B	23	25	22.1	28.4	70	50
I-PACOF-29B	29	32	27.2	34.5	120	50
I-PACOF-36B	36	40	32.0	42.4	145	30
I-PACOF-48B	48	50	43.9	54.1	150	30
I-PACOF-70B	70	80	66.0	80.0	220	10

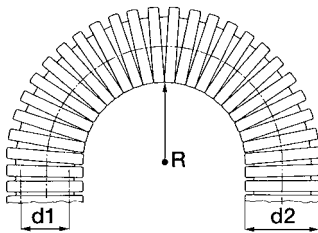

** *stat. R* = lowest recommended bending radius for static (fixed) installation

**I-PACOF -
is suitable for
static use only!**



PMA COFLEX Conduit PPCOF - medium, very flexible, split

The PMA COFLEX conduit type PPCOF has been created for retrofit and pre-loomed applications. New cables can be added to existing arrangements without the need for re-wiring or re-threading within the building of machines and installations. This product is suitable for vehicle manufacturing and building construction. Split connectors and locknuts are available for this product group.

Temperature range:

-4°F to +221°F (-20 °C to +105 °C), or a short time up to +275°F (+135°C)

Features:

- specially modified polypropylene
- good closure up to IP50
- self-extinguishing,

Chemical resistance:

- fuels
- mineral oils
- fats
- alkalis
- acids, etc.

Part No. structure

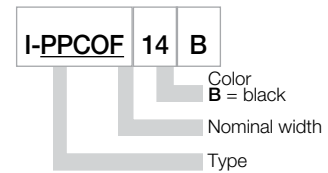

Part No. (Black)	Conduit size		Inside diameter d1 (mm)	Outside diameter d2 (mm)	Radius (stat.) (mm)	PU (m)
	Nominal	Metric				
I-PPCOF-07B	7	10	5.9	10	25	50
I-PPCOF-10B	10	12	8.5	12.8	28	50
I-PPCOF-12B	12	16	11.0	15.6	35	50
I-PPCOF-17B	17	20	15.1	21.1	45	50
I-PPCOF-23B	23	25	21.1	28.4	60	50
I-PPCOF-29B	29	32	26.6	34.5	100	50
I-PPCOF-36B	36	40	31.8	42.4	120	30
I-PPCOF-48B	45	50	43.9	54.1	140	30

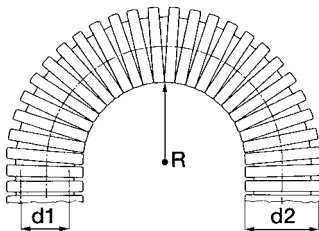

** *stat. R* = lowest recommended bending radius for static (fixed) installation

igus®
e-chain system®

Telephone 1-800-521-2747

Internet: igus.com
 email: sales@igus.com
 QuickSpec: igus.com/quickspec



LN - Two-part Lock Nut - metric

These split counter nuts are ideal in conjunction with TN fittings for the smooth re-installation and repair in machinery and plant construction. In addition, this product is becoming increasingly important in automotive construction and in building installation technology.

Temperature range:

-22°F to +212°F (-30 °C to +100 °C), or a short time up to +266°F (+130°C)

Features:

- specially formulated polyamide
- self-extinguishing
- free of halogen, cadmium and phosphor
- very good impact strength

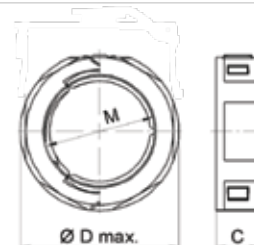

PMA-COFIX LN: Two-part lock nut, metric

Part No. Black	Thread M metric	Fits PMA COFLEX LNO		Outer diameter (mm)	Width C (mm)
I-BLN-M16	M16 x 1.5	I-BLNO-M160	I-BLNO-M162	21.5	8.0
I-BLN-M20	M20 x 1.5	I-BLNO-M202	I-BLNO-M207	29.5	8.0
I-BLN-M25	M25 x 1.5	I-BLNO-M257	I-BLNO-M253	35.5	9.0
I-BLN-M32	M32 x 1.5	I-BLNO-M323	I-BLNO-M329	44.5	12.0
I-BLN-M40	M40 x 1.5	I-BLNO-M409	I-BLNO-M406	53.5	15.0
I-BLN-M50	M50 x 1.5	I-BLNO-M508		69.5	15.0



LNO - One-piece split connector, straight

These split lock nuts are used in conjunction with the connectors TN for repairs or where cable protection systems are installed after wiring has taken place in the machine building and installation industry. Further, these products will be used increasingly in the vehicle building and building construction.

Temperature range:

-22°F to +212°F (-30 °C to +100 °C), or a short time up to +266°F (+130°C)

Features:

- specially formulated polyamide
- IP50
- self-extinguishing
- free of halogen, cadmium and phosphor
- very good impact strength



PMA-COFIX LNO: one-piece split connector

Part No. Black	Thread metric	Fits conduit size		Thread length g (mm)	Overall length L (mm)
		NW	metric		
I-BLNO-M160	M16 x 1.5	12	16	13.0	36.5
I-BLNO-M162	M16 x 1.5	12	16	13.0	39.5
I-BLNO-M202	M20 x 1.5	12	16	13.0	39.5
I-BLNO-M207	M20 x 1.5	17	20	13.0	43.5
I-BLNO-M257	M25 x 1.5	17	20	14.0	44.5
I-BLNO-M253	M25 x 1.5	23	25	14.0	52.5
I-BLNO-M323	M32 x 1.5	23	25	17.0	56.0
I-BLNO-M329	M32 x 1.5	29	32	17.0	61.0
I-BLNO-M409	M40 x 1.5	29	32	21.0	65.0
I-BLNO-M406	M40 x 1.5	34	40	22.0	74.5
I-BLNO-M508	M50 x 1.5	48	50	22.0	80.5

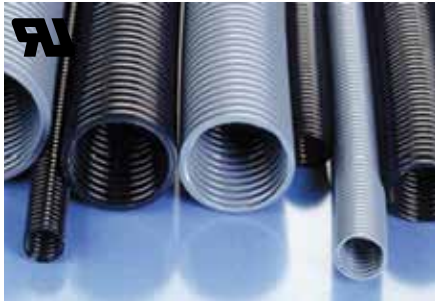

PMAFLEX Conduits VCS - flexible, heavy

PMAFLEX VCS heavy conduit is characterized by high impact resistance at low temperatures and good weather resistance. These conduits find their application primarily in railway vehicle undercarriages, but are also well-suited to static applications in general construction of machinery or installations.

Temperature range:

-58°F to +221°F (-50 °C to +105 °C), or a short time up to +302°F (+150°C)

Features:

- specially modified PA6 (polyamide 6) for cold impact
- excellent mechanical properties also at low temperatures
- self-extinguishing
- halogen-free and cadmium-free

Chemical resistance:

- fuels
- mineral oils
- fats
- alkalis
- weak acids and bases, etc.

Part No. structure

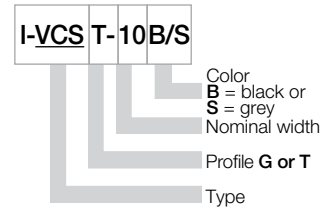

Part No. black	Part No. grey*	Conduit size NW	Conduit size metric	Inside diameter (mm)	Outside diameter (mm)	Radius (stat.)** (mm)	PU (m)
I-VCST-07B	I-VCST-07S	7	10	6.0	10.0	20	100
I-VCST-10B	I-VCST-10S	10	12	9.2	13.0	25	50
I-VCST-12B	I-VCST-12S	12	16	11.8	15.8	30	50
I-VCST-17B	I-VCST-17S	17	20	16.0	21.2	40	50
I-VCSG-17B	I-VCSG-17S	17	20	15.2	21.2	40	50
I-VCSG-23B	I-VCSG-23S	23	25	22.0	28.5	50	50
I-VCSG-29B	I-VCSG-29S	29	32	27.7	34.4	60	50
I-VCSG-36B	I-VCSG-36S	36	40	35.8	42.4	70	30
I-VCSG-48B	I-VCSG-48S	48	50	46.8	54.4	80	30
I-VCSG-56B	I-VCSG-56S	56	68	56.1	67.2	150	30
I-VCSG-70B	I-VCSG-70S	70	80	66.5	80.0	200	10
I-VCSG-95B	I-VCSG-95S	95	106	91.0	106.0	300	10

*Grey part is a special order, call igus® for availability

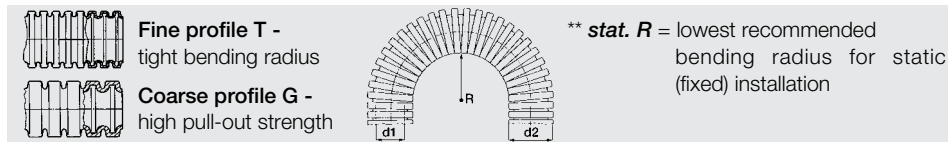

I-VCST/VCSG - is suitable for static use only!



PMAFLEX Conduits PIS/PIH - highly flexible, medium

These highly flexible products are used primarily in automation applications and for connections subject to intense movements in general machinery construction. Their outstanding material properties make these conduits especially suitable for outdoor applications where they are exposed to intensive sunlight (UV).

Temperature range:

-58°F to +203°F (-50 °C to +95 °C), or a short time up to +302°F (+150°C)

Features:

- specially modified polyamide 12
- **PIS: medium-wall (nominal width 07 to 48**
- **PIH: heavy-wall (nominal width 56 to 125)**
- self-extinguishing
- halogen-free and cadmium-free
- good mechanical properties also at low temperatures

Chemical resistance:

- fuels
- mineral oils
- fats
- alkalis
- acids etc.

Part No. structure

I-PIS T-48B/S

Color
B = black or
S = grey
 Nominal width
 Profile **T** or **G**
 Type

Part No. black	Part No. grey*	Conduit size NW	Conduit size metric	Inside diameter (mm)	Outside diameter (mm)	Radius stat.**/dyn.*** (mm)	PU (m)
I-PIST-07B	I-PIST-07S	7	10	6.2	10.0	15 / 40	50
I-PIST-10B	I-PIST-10S	10	12	9.6	13.0	20 / 50	50
I-PIST-12B	I-PIST-12S	12	16	11.9	15.8	25 / 65	50
I-PIST-17B	I-PIST-17S	17	20	16.4	21.1	30 / 65	50
I-PIST-23B	I-PIST-23S	23	25	22.6	28.4	35 / 90	50
I-PIST-29B	I-PIST-29S	29	32	29.0	34.3	45 / 110	50
I-PIST-36B	I-PIST-36S	36	40	36.5	42.5	60 / 165	30
I-PIST-48B	I-PIST-48S	48	50	47.5	54.5	70 / 180	30
I-PISG-17B	-	17	20	15.2	21.1	30 / 80	50
I-PISG-23B	I-PISG-23S	23	25	21.7	28.4	40 / 100	50
I-PISG-29B	I-PISG-29S	29	32	27.4	34.3	50 / 120	50
I-PISG-36B	I-PISG-36S	36	40	35.8	42.3	60 / 180	30
I-PISG-48B	I-PISG-48S	48	50	46.7	54.2	70 / 200	30
I-PIHG-56B	I-PIHG-56S	56	68	56.3	67.2	110 / 270	30
I-PIHG-70B	I-PIHG-70S	70	80	67.2	79.6	150 / 350	30
I-PIHG-95B	I-PIHG-95S	95	106	91.3	106.0	170 / 450	30
I-PIHG-125B	I-PIHG-125S	125	146	126.5	146.5	350 / 580	20

*Grey part is a special order, call igus® for availability

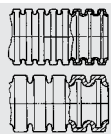

Fine profile T -
tight bending radius

Coarse profile G -
high pull-out strength

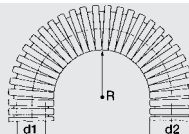

** *stat. R* = lowest recommended bending radius for static (fixed) installation

*** *dyn. R* = lowest recommended bending radius for dynamic (flexible) installation

I-PIS/PIH is recommended for highly flexible application



PMAFLEX Conduits CYL - very flexible, medium, economy

PMA CYL ECONOMY conduit exhibits very good flexibility and is also suitable for low temperature applications. These conduits are used primarily in construction of machinery and equipment.

Temperature range:

-40°F to +221°F (-40 °C to +105 °C), or a short time up to +302°F (+150°C)

Features:

- specially modified polyamide 6/6.6 for cold impact
- good impact strength also at low temperatures
- self-extinguishing
- halogen-free and cadmium-free

Chemical resistance:

- fuels
- mineral oils
- fats
- alkalis
- weak acids and bases, etc.

Part No. structure

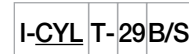

Color
B = black or
S = grey
 Nominal width
 Profile **T** or **G**
 Type

Part No. black	Part No. grey*	Conduit size NW	Conduit size metric	Inside diameter (mm)	Outside diameter (mm)	Radius (stat.)** (mm)	PU (m)
I-CYLT-07B	I-CYLT-07S	7	10	6.2	10.0	15	50
I-CYLT-10B	I-CYLT-10S	10	12	9.6	13.0	20	50
I-CYLT-12B	I-CYLT-12S	12	16	12.0	15.8	30	50
I-CYLT-17B	I-CYLT-17S	17	20	16.2	21.2	40	50
I-CYLT-23B	I-CYLT-23S	23	25	22.6	28.5	40	50
I-CYLT-29B	I-CYLT-29S	29	32	29.0	34.5	50	50
I-CYLT-36B	I-CYLT-36S	36	40	36.5	42.5	60	30
I-CYLT-48B	I-CYLT-48S	48	50	47.5	54.5	70	30
I-CYLG-23B	I-CYLG-23S	23	25	21.9	28.5	45	50
I-CYLG-29B	I-CYLG-29S	29	32	27.6	34.5	55	50
I-CYLG-36B	I-CYLG-36S	36	40	36.0	42.5	60	30
I-CYLG-48B	I-CYLG-48S	48	50	47.0	54.5	70	30
I-CYLG-56B	-	56	68	56.3	67.2	120	30
I-CYLG-70B	-	70	80	68.0	80.0	160	30
I-CYLG-95B	-	95	106	91.9	106.0	210	10
I-CYLG-125B	-	125	146	126.5	146.5	450	6

*Grey part is a special order, call igus® for availability

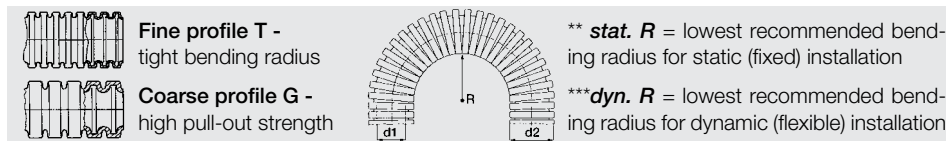

I-CYLT/CYLG - is recommended for static use!
 (moderate dynamic application possible)

igus®
 e-chain system®

Telephone 1-800-521-2747

Internet: igus.com
 email: sales@igus.com
 QuickSpec: igus.com/quickspec

IP66 - static, IP54 dynamic - universal safety clip

- One piece Fitting, sealing by cone
- Easy “push-in” installation
- Pre-installed safety clip AFN2
- Fits any type of conduit profile (T and G)
- Excellent pull-out strength
- Re-opening for safety reasons only possible with a screwdriver
- Clip pre-installed in all IP66 connectors

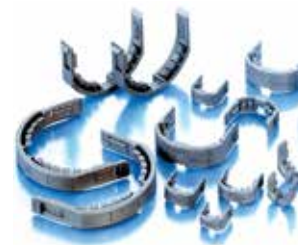

Installation



1 Push in conduit with a slight twist (open using screwdriver on conduit side)



2 Pull back slightly to ensure the locking mechanism is fully engaged



3 To re-open use a screwdriver

IP68 - static - oval clip

- High sealing through additional seal cap
- For highest dynamic applications
- Fits any type of conduit profile (T and G)
- Excellent pull-out strength
- Re-opening for safety reasons only possible with a screwdriver



Installation



A Conduit,
B Seal cap,
C Connector,
D Oval clip,
E flat gasket (or O-ring seal)



2 Push seal cap onto end of conduit to achieve IP68



For ease of installation moisten seal cap with water or grease



4 Push conduit with seal cap fully into connector. This guarantees PMA's unique IP68/67 rating*



5 Install retaining oval clip

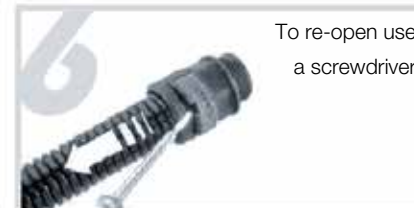

6 To re-open use a screwdriver

* For safety reasons, oval clip will not fit if seal cap is not fully installed.

Ensure to follow O-ring manufacturers guidelines when using O-rings for sealing purposes.

PMAFIX - Connectors

The designation **PMAFIX** describes a very large range of connectors for PMA conduits with the patented PMA safety clip system. Connectors are available for ingress protection IP66 and IP68. IP66 connectors are fitted with a preinstalled universal safety clip which ensures a quick "push-in" installation. IP68 connectors for increased requirements will be delivered with a special conduit seal cap.

Table 1 - PMAFIX / PMAFLEX conduit code

Nominal width	PMA code
7	M
10	0
12	2
17	7
23	3
29	9
36	6
48	8

Table 2 - Thread codes

Thread metric	PMA code	Thread PG	PMA code
M12 x 1.5	M12	PG07	P07
M16 x 1.5	M16	PG09	P09
M20 x 1.5	M20	PG11	P11
-	-	PG13.5	P13
M25 x 1.5	M25	PG16	P16
M32 x 1.5	M32	PG21	P21
M40 x 1.5	M40	PG29	P29
M50 x 1.5	M50	PG36	P36
M63 x 1.5	M63	PG42	P42
		PG48	P48

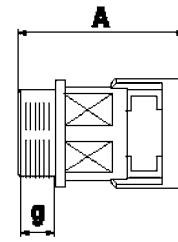

g = Thread length
A = Overall length

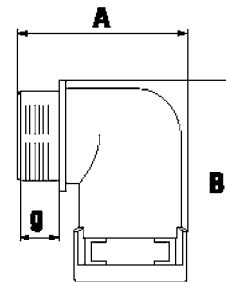

g = Thread length
A x B = External dimensions

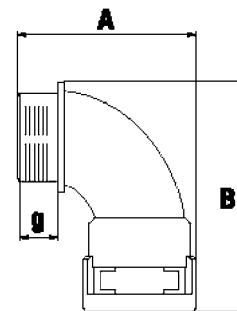

g = Thread length
A x B = External dimensions

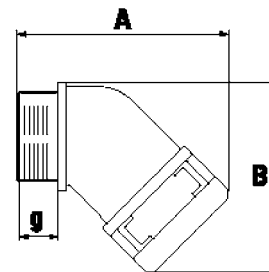

g = Thread length
A x B = External dimensions

igus®
e-chain system®

Telephone 1-800-521-2747

Internet: igus.com
email: sales@igus.com
QuickSpec: igus.com/quickspec

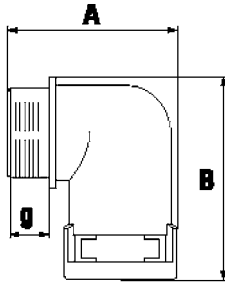

g = Thread length

A x B = External dimensions

PMAFIX Connectors VW - 90° elbow, PG

These PMAFIX connectors are used in a wide range of applications. Together with PMAFLEX conduits they offer the highest grade of safety and sealing.

Temperature range:

-40°F to +221°F (-40 °C to +105 °C), or a short time up to +320°F (+160°C)

Content of delivery IP66:

Fitting with pre-assembled universal safety clips (AFN2)

Content of delivery IP68:

Fitting with oval clips (OVN2), conduit and thread seal (NVN3, SVN4)

Features:

- high grade formulated polyamide
- excellent impact strength
- self-extinguishing
- free of halogen, phosphor and cadmium

Part No. IP66	Part No. IP68	Thread	Fits to conduit size:		Thread metric	External length [mm]	dim. [mm]
			PG	NW			
I-__VWD-PG07MGT-11	I-__VWV-PG07M	7	7	10	(11.0)	32.0 x 35.0	
I-__VWD-PG070GT-11	I-__VWV-PG070	7	10	12	(11.0)	34.0 x 39.5	
I-__VWD-PG09MGT-11	—	9	7	10	(11.0)	32.0 x 36.5	
I-__VWD-PG090GT-11	I-__VWV-PG090	9	10	12	(11.0)	34.0 x 39.5	
I-__VWD-PG092GT-11	I-__VWV-PG092	9	12	16	(11.0)	38.5 x 44.5	
I-__VWD-PG11MGT-11	—	11	7	10	(11.0)	32.0 x 38.0	
I-__VWD-PG110GT-11	I-__VWV-PG110	11	10	12	(11.0)	34.0 x 41.0	
I-__VWD-PG112GT-11	I-__VWV-PG112	11	12	16	(11.0)	38.5 x 46.0	
I-__VWD-PG13MGT-11	—	13.5	7	10	(11.0)	32.0 x 39.5	
I-__VWD-PG130GT-11	I-__VWV-PG130	13.5	10	12	(11.0)	34.0 x 42.5	
I-__VWD-PG132GT-11	I-__VWV-PG132	13.5	12	16	(11.0)	38.5 x 47.5	
I-__VWD-PG137GT-11	I-__VWV-PG137	13.5	17	20	(11.0)	43.5 x 58.5	
I-__VWD-PG167GT-11	I-__VWV-PG167	16	17	20	(11.0)	43.5 x 58.5	
I-__VWD-PG213GT	I-__VWV-PG213	21	23	25	(11.0)	54.0 x 67.0	
I-__VWD-PG299GT	I-__VWV-PG299	29	29	32	(12.0)	61.5 x 74.5	
I-__VWD-PG366GT	I-__VWV-PG366	36	36	40	(13.0)	72.0 x 98.0	
I-__VWD-PG488GT	I-__VWV-PG488	48	48	50	(13.0)	85.5 x 111.0	

Fill in the blank with either "B" to order black or "S" to order grey*

For smaller conduit sizes NW 07 to NW 12 appropriate standard elbows of type VB are available

*Grey part is a special order, call igus® for availability

Part No. structure PG

I-B/SVWD PG213GT

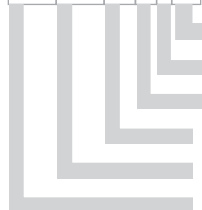

Universal
safety clip
NW conduit
Thread size
PG thread
Type

B = black or
S = grey



PMAFIX Connectors VA - 45° elbow, metric & PG

These PMAFIX connectors are used in a wide range of applications. Together with PMAFLEX conduits they offer the highest grade of safety and sealing.

Temperature range:

-40°F to +221°F (-40 °C to +105 °C), or a short time up to +320°F (+160°C)

Content of delivery IP66:

Fitting with pre-assembled universal safety clips (AFN2)

Content of delivery IP68:

Fitting with oval clips (OVN2), conduit and thread seal (NVN3, SVN4)

Features:

- high grade formulated polyamide
- excellent impact strength
- self-extinguishing
- free of halogen, phosphor and cadmium

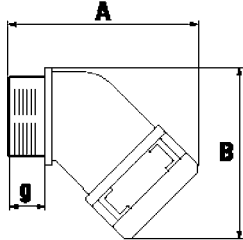

g = Thread length

A x B = External dimensions

Part No. IP66	Part No. IP68	Thread metric	Fits to conduit size:		Thread length [mm]	External dim. [mm]
			NW	metric		
I-__VAD-M120GT	—	M12 x 1.5	10	12	11.0	43.5 x 37.0
I-__VAD-M160GT	I-__VAV-M160	M16 x 1.5	10	12	11.0	43.5 x 38.0
I-__VAD-M162GT	I-__VAV-M162	M16 x 1.5	12	16	11.0	48.0 x 40.0
I-__VAD-M202GT	I-__VAV-M202	M20 x 1.5	12	16	11.0	48.0 x 41.5
I-__VAD-M207GT	I-__VAV-M207	M20 x 1.5	17	20	11.0	55.5 x 51.5
I-__VAD-M253GT	I-__VAV-M253	M25 x 1.5	23	25	12.0	65.0 x 58.5
I-__VAD-M329GT	I-__VAV-M329	M32 x 1.5	29	32	15.0	73.5 x 66.5
I-__VAD-M406GT	I-__VAV-M406	M40 x 1.5	36	40	19.0	92.5 x 85.5
I-__VAD-M506GT	I-__VAV-M506	M50 x 1.5	36	40	19.0	100.0 x 89.5
I-__VAD-M508GT	I-__VAV-M508	M50 x 1.5	48	50	19.0	100.0 x 96.0
I-__VAD-M638GT	I-__VAV-M638	M63 x 1.5	48	50	19.0	100.0 x 104.0

Part No. IP66	Part No. IP68	Thread PG	Fits to conduit size:		Thread length [mm]	External dim. [mm]
			NW	metric		
I-__VAD-P090GT	I-__VAV-P090	9	10	12	11.0	43.5 x 37.0
I-__VAD-P112GT	I-__VAV-P112	11	12	16	11.0	48.0 x 40.0
I-__VAD-P132GT	I-__VAV-P132	13.5	12	16	11.0	48.0 x 41.5
I-__VAD-P137GT	I-__VAV-P137	13.5	17	20	11.0	55.0 x 50.0
I-__VAD-P167GT	I-__VAV-P167	16	17	20	11.0	55.0 x 51.5
I-__VAD-P213GT	I-__VAV-P213	21	23	25	12.0	67.0 x 59.0
I-__VAD-P299GT	I-__VAV-P299	29	29	32	12.0	69.0 x 67.0
I-__VAD-P366GT	I-__VAV-P366	36	36	40	13.0	86.0 x 86.0
I-__VAD-P488GT	I-__VAV-P488	48	48	50	13.0	93.0 x 99.0

Fill in the blank with either "B" to order black or "S" to order grey*

*Grey part is a special order, call igus® for availability

Part No. structure metric

Part No. structure PG

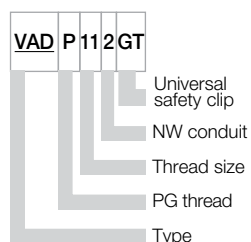
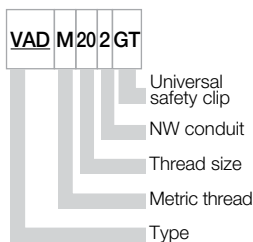

igus®
e-chain system®

Telephone 1-800-521-2747

Internet: igus.com
email: sales@igus.com
QuickSpec: igus.com/quickspec



PMAFIX Connectors VN - straight, metric

These PMAFIX connectors are used in a wide range of applications. Together with PMAFLEX conduits they offer the highest grade of safety and sealing.

Temperature range:

-40°F to +221°F (-40 °C to +105 °C), or a short time up to +320°F (+160°C)

Content of delivery IP66:

Fitting with pre-assembled universal safety clips (AFN2)

Content of delivery IP68:

Fitting with oval clips (OVN2), conduit and thread seal (NVN3, SVN4)

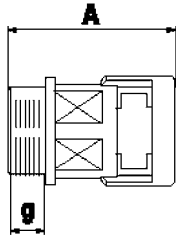

Features:

- high grade formulated polyamide
- excellent impact strength
- self-extinguishing
- free of halogen, phosphor and cadmium

Part No. IP66	Part No. IP68	Thread metric	Fits to conduit size:		Thread length [mm]	Overall length [mm]
			NW	metric		
I-_VND-M12MGT	I-_VNV-M12M	M12 x 1.5	7	10	11.0	34.5
I-_VND-M120GT	I-_VNV-M120	M12 x 1.5	10	12	11.0	36.5
I-_VND-M160GT	I-_VNV-M160	M16 x 1.5	10	12	11.0	36.5
I-_VND-M162GT	I-_VNV-M162	M16 x 1.5	12	16	11.0	39.5
I-_VND-M202GT	I-_VNV-M202	M20 x 1.5	12	16	11.0	39.5
I-_VND-M207GT	I-_VNV-M207	M20 x 1.5	17	20	11.0	47.5
I-_VND-M257GT	I-_VNV-M257	M25 x 1.5	17	20	12.0	48.5
I-_VND-M253GT	I-_VNV-M253	M25 x 1.5	23	25	12.0	52.0
I-_VND-M323GT	I-_VNV-M323	M32 x 1.5	23	25	15.0	55.5
I-_VND-M329GT	I-_VNV-M329	M32 x 1.5	29	32	15.0	56.0
I-_VND-M409GT	I-_VNV-M409	M40 x 1.5	29	32	19.0	60.0
I-_VND-M406GT	I-_VNV-M406	M40 x 1.5	36	40	19.0	72.5
I-_VND-M506GT	I-_VNV-M506	M50 x 1.5	36	40	19.0	72.0
I-_VND-M508GT	I-_VNV-M508	M50 x 1.5	48	50	19.0	72.5
I-_VND-M638GT	I-_VNV-M638	M63 x 1.5	48	50	19.0	72.0

Fill in the blank with either "B" to order black or "S" to order grey*

*Grey part is a special order, call igus® for availability

Part No. structure metric

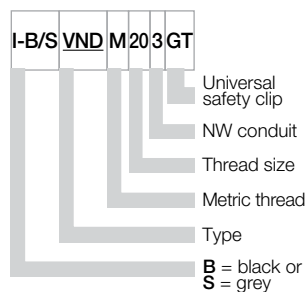



PMAFIX Connectors VN - straight, PG

These PMAFIX connectors are used in a wide range of applications. Together with PMAFLEX conduits they offer the highest grade of safety and sealing.

Temperature range:

-40°F to +221°F (-40 °C to +105 °C), or a short time up to +320°F (+160°C)

Content of delivery IP66:

Fitting with pre-assembled universal safety clips (AFN2)

Content of delivery IP68:

Fitting with oval clips (OVN2), conduit and thread seal (NVN3, SVN4)

Features:

- high grade formulated polyamide
- excellent impact strength
- self-extinguishing
- free of halogen, phosphor and cadmium

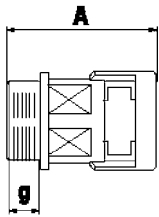

Part No. IP66	Part No. IP68	Thread PG	Fits to conduit size: NW	metric	Thread length [mm]	Overall length [mm]
I-__VND-P07MGT-11	I-__VNV-P07M	7	7	10	11.0	34.5
I-__VND-P070GT-11	I-__VNV-P070	7	10	12	11.0	36.5
I-__VND-P072GT-11	—	7	12	16	11.0	39.0
I-__VND-P09MGT-11	I-__VNV-P09M	9	7	10	11.0	34.5
I-__VND-P090GT-11	I-__VNV-P090	9	10	12	11.0	36.5
I-__VND-P092GT-11	I-__VNV-P092	9	12	16	11.0	39.0
I-__VND-P097GT-11	I-__VNV-P097	9	17	20	11.0	47.5
I-__VND-P11MGT-11	I-__VNV-P11M	11	7	10	11.0	34.5
I-__VND-P110GT-11	I-__VNV-P110	11	10	12	11.0	36.5
I-__VND-P112GT-11	I-__VNV-P112	11	12	16	11.0	39.0
I-__VND-P117GT-11	I-__VNV-P117	11	17	20	11.0	47.5
I-__VND-P13MGT-11	—	13.5	7	10	11.0	34.5
I-__VND-P130GT-11	I-__VNV-P130	13.5	10	12	11.0	36.5
I-__VND-P132GT-11	I-__VNV-P132	13.5	12	16	11.0	39.0
I-__VND-P137GT-11	I-__VNV-P137	13.5	17	20	11.0	47.5
I-__VND-P160GT-11	—	16	10	12	11.0	36.5
I-__VND-P162GT-11	I-__VNV-P162	16	12	16	11.0	39.0
I-__VND-P167GT-11	I-__VNV-P167	16	17	20	11.0	47.5
I-__VND-P163GT-11	I-__VNV-P163	16	23	25	11.0	51.0
I-__VND-P213GT	I-__VNV-P213	21	23	25	12.0	52.0
I-__VND-P299GT	I-__VNV-P299	29	29	32	12.0	53.0
I-__VND-P296GT	I-__VNV-P296	29	36	40	12.0	67.5
I-__VND-P366GT	I-__VNV-P366	36	36	40	13.0	66.0
I-__VND-P368GT	—	36	48	50	13.0	68.5
I-__VND-P428GT	I-__VNV-P428	42	48	50	13.0	68.5
I-__VND-P488GT	I-__VNV-P488	48	48	50	13.0	66.5

Fill in the blank with either "B" to order black or "S" to order grey*

*Grey part is a special order, call igus® for availability

Part No. structure PG

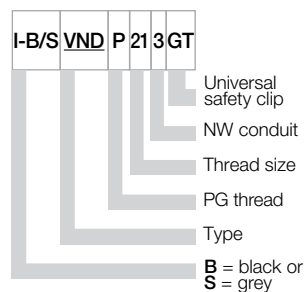

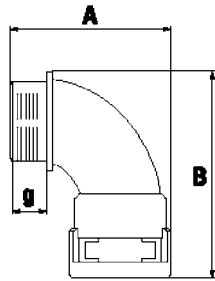

g = Thread length

A x B = External dimensions

PMAFIX Connectors VB - 90° curved elbow, metric & PG

These PMAFIX connectors are used in a wide range of applications. Together with PMAFLEX conduits they offer the highest grade of safety and sealing.

Temperature range:

-40°F to +221°F (-40 °C to +105 °C), or a short time up to +320°F (+160°C)

Content of delivery IP66:

Fitting with pre-assembled universal safety clips (AFN2)

Content of delivery IP68:

Fitting with oval clips (OVN2), conduit and thread seal (NVN3, SVN4)

Features:

- high grade formulated polyamide
- excellent impact strength
- self-extinguishing
- free of halogen, phosphor and cadmium

Part No. IP66	Part No. IP68	Thread metric	Fits to conduit size:		Thread length [mm]	External dim. [mm]
			NW	metric		
I-_VBD-M207GT	I-_VBV-M207	M20 x 1.5	17	20	11.0	47.5 x 73.0
I-_VBD-M257GT	I-_VBV-M257	M25 x 1.5	17	20	12.0	48.5 x 76.0
I-_VBD-M253GT	I-_VBV-M253	M25 x 1.5	23	25	12.0	57.5 x 83.0
I-_VBD-M323GT	I-_VBV-M323	M32 x 1.5	23	25	15.0	61.0 x 87.5
I-_VBD-M329GT	I-_VBV-M329	M32 x 1.5	29	32	15.0	70.5 x 93.0
I-_VBD-M409GT	I-_VBV-M409	M40 x 1.5	29	32	19.0	74.5 x 98.5
I-_VBD-M406GT	I-_VBV-M406	M40 x 1.5	36	40	19.0	85.0 x 121.0
I-_VBD-M506GT	I-_VBV-M506	M50 x 1.5	36	40	19.0	85.0 x 125.0
I-_VBD-M508GT	I-_VBV-M508	M50 x 1.5	48	50	19.0	98.5 x 130.0
I-_VBD-M638GT	I-_VBV-M638	M63 x 1.5	48	50	19.0	98.5 x 138.0

Part No. IP66	Part No. IP68	Thread metric	Fits to conduit size:		Thread length [mm]	External dim. [mm]
			NW	metric		
I-_VBD-P167GT	I-_VBV-P167	16	17	20	11.0	47.4 x 73.0
I-_VBD-P213GT	I-_VBV-P213	21	23	25	12.0	57.5 x 85.0
I-_VBD-P299GT	I-_VBV-P299	29	29	32	12.0	67.5 x 96.0
I-_VBD-P366GT	I-_VBV-P366	36	36	40	13.0	79.0 x 123.0
I-_VBD-P488GT	I-_VBV-P488	48	48	50	13.0	92.5 x 135.0

Fill in the blank with either "B" to order black or "S" to order grey*

*Grey part is a special order, call igus® for availability

For smaller conduit sizes NW 07 to NW 12 appropriate standard elbows of type VW are available

Part No. structure metric

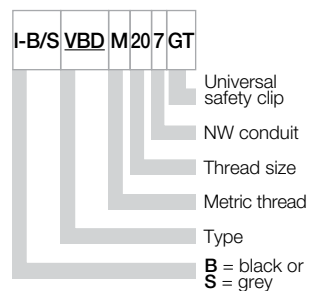

Part No. structure PG

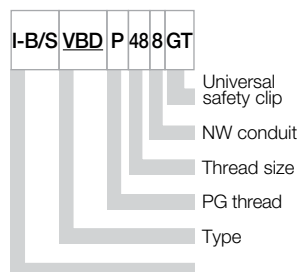



PMAFIX Connectors VO - Flange 90°

These PMAFIX connectors are used in a wide range of applications. Together with PMAFLEX conduits they offer the highest grade of safety and sealing.

Content of delivery IP66:

Fitting with pre-assembled universal safety clips (AFN2), flange seal (FG04)

Content of delivery IP68:

Fitting with oval clips (OVN2), conduit and thread seal (NVN3, FG04)

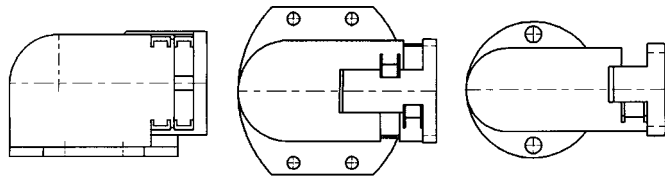

Part No. IP66	Part No. IP68	Fits to conduit size:		Dimensions width x length x depth	Fixing screws
		NW	metric		
I-_VOD-P167GT	I-_VOV-P167	17	20	46.0 x 66.0 x 35.5	2 x M5
I-_VOD-P213GT	I-_VOV-P213	23	25	65.5 x 70.0 x 43.0	2 x M6
I-_VOD-P299GT	I-_VOV-P299	29	32	67.0 x 78.0 x 49.5	4 x M6
I-_VOD-P366GT	I-_VOV-P366	36	40	85.0 x 102.0 x 65.5	4 x M6
I-_VOD-P488GT	I-_VOV-P488	48	50	86.0 x 119.0 x 77.5	4 x M6

Fill in the blank with either "B" to order black or "S" to order grey*

*Grey part is a special order, call igus® for availability

Part No. structure PG

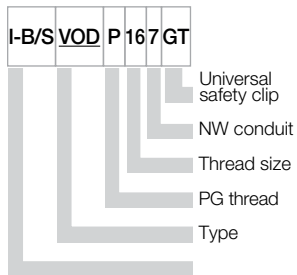

igus®
e-chain system®

Telephone 1-800-521-2747

Internet: igus.com
 email: sales@igus.com
 QuickSpec: igus.com/quickspec

**PMAFIX FH-0 - One-piece system supports**

The one-piece PMAFIX system support is designed for fixation of PMAFIX conduits. This product can be used in all machine and installation applications for easy assembly of the PMA system.

Temperature range:

-40°F to +221°F (-40 °C to +105 °C), or a short time up to +320°F (+160°C)

Features:

- high grade formulated polyamide
- excellent impact strength
- self-extinguishing
- free of halogen, phosphor and cadmium

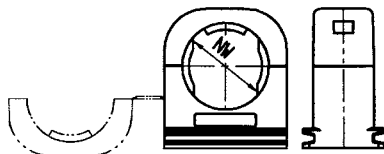

Part No. black	Part No. grey	Fits to conduit size:		Dimensions width x length x depth	Fixing screw
		NW	metric		
I-BFH-07-0	I-SFH-07-0	7	10	17.0 x 21.5 x 20.0	1 x M4
I-BFH-10-0	I-SFH-10-0	10	12	20.5 x 24.5 x 20.0	1 x M5
I-BFH-12-0	I-SFH-12-0	12	16	24.0 x 27.0 x 20.0	1 x M5
I-BFH-17-0	I-SFH-17-0	17	20	30.0 x 34.0 x 20.0	1 x M6
I-BFH-23-0	I-SFH-23-0	23	25	38.5 x 42.0 x 20.0	1 x M6
I-BFH-29-0	I-SFH-29-0	29	32	45.5 x 48.0 x 20.0	1 x M6
I-BFH-36-0	I-SFH-36-0	36	40	55.5 x 56.0 x 20.0	1 x M6
I-BFH-48-0	I-SFH-48-0	48	50	67.5 x 68.0 x 20.0	1 x M6

**PMAFIX VH - System supports**

These PMAFIX system supports are designed for support and guidance of PMA conduits with fine or coarse profile and can be used in all machine building and installation applications. The system is safe against turning/movement and offers maximum security with the additional safety clip, variable assembly due to six hole fastening and optimal strain relief due to integrated rib.

Temperature range:

-40°F to +221°F (-40 °C to +105 °C), or a short time up to +320°F (+160°C)

Features:

- high grade formulated polyamide
- excellent impact strength
- self-extinguishing
- free of halogen, phosphor and cadmium

Part No. Support only	Part No. Locking clip	Part No. Complete	Fits to conduit size:		Dimensions width x length x depth	Fixing screw
			NW	metric		
I-BVH-07	BVH-07-020	BVH-07-000	7	10	17.0 x 21.5 x 20.0	1 x M4
I-BVH-10	BVH-10-020	BVH-10-000	10	12	20.5 x 24.5 x 20.0	1 x M5
I-BVH-12	BVH-12-020	BVH-12-000	12	16	24.0 x 27.0 x 20.0	1 x M5
I-BVH-17	BVH-17-020	BVH-17-000	17	20	35.0 x 36.0 x 36.0	6 x M5
I-BVH-23	BVH-23-020	BVH-23-000	23	25	35.0 x 44.0 x 36.0	6 x M5
I-BVH-29	BVH-29-020	BVH-29-000	29	32	46.0 x 52.0 x 40.0	6 x M5
I-BVH-36	BVH-36-020	BVH-36-000	36	40	53.0 x 58.0 x 60.0	6 x M5
I-BVH-48	BVH-48-020	BVH-48-000	48	50	66.0 x 72.0 x 60.0	6 x M5



PMAFIX GPS - One-piece System supports for stacking

The PMAFIX system supports for stacking are specially designed for increased mechanical requirements in the traction and heavy machine building industries. The one-piece systems supports offer a clasp for easy pre-mounting and final assembly. Fixation in standard rails type C and strain relief due to gripping around the conduit. In addition these products are partially stackable.

Temperature range:

-40°F to +221°F (-40 °C to +105 °C), or a short time up to +320°F (+160°C)

Features:

- high grade formulated polyamide
- excellent impact strength
- self-extinguishing
- free of halogen, phosphor and cadmium

Stacking options

The following nominal widths can be combined for stacking:

- NW 17 with NW23
- NW 29 with NW 36
- NW 48 with NW 56

Part No. fine profile	Fits to conduit size			Dimensions		
	NW	metric	DIN-NW	width	height	depth
BGPS-17	17	20	2	70.0	45.0	30.0
BGPS-23	23	25	2	70.0	45.0	30.0
BGPS-29	29	32	3	85.0	60.0	30.0
BGPS-36	36	40	3	85.0	60.0	30.0
BGPS-48	48	50	4	115.0	90.0	30.0
BGPS-56	56	-	4	115.0	90.0	30.0



PMA MN - Hexagonal Lock Nuts, metric & PG

These hexagonal lock nuts are suitable for a wide range of applications. High torque guarantees a safe connection of the system. Made of reinforced polyamide glass fiber

Temperature range:

-40°F to +221°F (-40 °C to +105 °C), or a short time up to +302°F (+150°C)

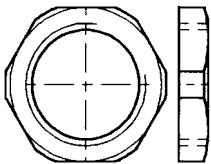

Part No. black	Part No. grey	Fits to thread: metric	Wrench size	Dimensions height
I-BMN-M12	I-GMN-M12	M12 x 1.5	17.0	5.0
I-BMN-M16	I-GMN-M16	M16 x 1.5	22.0	5.0
I-BMN-M20	I-GMN-M20	M20 x 1.5	27.0	6.0
I-BMN-M25	I-GMN-M25	M25 x 1.5	32.0	6.0
I-BMN-M32	I-GMN-M32	M32 x 1.5	41.0	7.0
I-BMN-M40	I-GMN-M40	M40 x 1.5	50.0	7.0
I-BMN-M50	I-GMN-M50	M50 x 1.5	60.0	8.0
I-BMN-M63	I-GMN-M63	M63 x 1.5	75.0	8.0

Part No. black	Part No. grey	Fits to thread: PG	Wrench size	Dimensions height
I-BMN-07	I-GMN-07	7	19.0	5.0
I-BMN-09	I-GMN-09	9	22.0	5.0
I-BMN-11	I-GMN-11	11	24.0	5.3
I-BMN-13	I-GMN-13	13.5	27.0	6.3
I-BMN-16	I-GMN-16	16	30.0	6.3
I-BMN-21	I-GMN-21	21	36.0	7.0
I-BMN-29	I-GMN-29	29	46.0	7.0
I-BMN-36	I-GMN-36	36	60.0	8.0
I-BMN-48	I-GMN-48	48	70.0	8.0

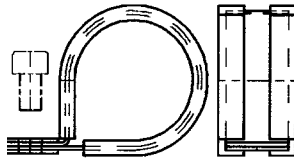

PMA SGB - Tube clamps

These tube clamps are used for the mounting and smooth connection to the PMA conduits in the general machine and installation applications. They are especially suitable for the mounting of static conduits.

Temperature range: -58°F to +221°F (-50 °C to +105 °C)

Features:

- galvanized steel according to DIN 3016
- Elastomer free of halogen

Part No.	Fits to conduit size		Dimensions width [mm]	Fixing screw
	NW	metric		
I-SGB-07	7	10	13.0	1 x M4
I-SGB-09	10	12	13.0	1 x M4
I-SGB-11	12	16	13.0	1 x M4
I-SGB-16	17	20	16.0	1 x M5
I-SGB-21	23	25	16.0	1 x M5
I-SGB-29	29	32	19.0	1 x M6
I-SGB-36	36	40	19.0	1 x M6
I-SGB-48	48	50	19.0	1 x M6



PMA 514 - Plug Screws, metric & PG

These plug screws are suitable for an accurate termination where no thread holes in casing and distribution boxes are needed.

Temperature range: -4°F to +212°F (-20 °C to +100 °C), or a short time up to +302°F (+150°C)

Features:

- product with metric thread: PA-GF
- product with PG thread: PS
- free of halogen, phosphor and cadmium
- IP54

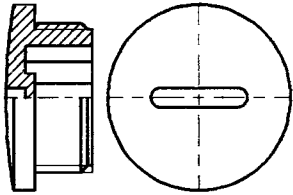

Part No.	Fits to thread metric	Outside Ø [mm]	Total length [mm]	Thread length [mm]
I-514-M12	M12 x 1.5	15.0	8.0	6.0
I-514-M16	M16 x 1.5	20.0	9.0	6.0
I-514-M20	M20 x 1.5	24.0	9.5	6.0
I-514-M25	M25 x 1.5	30.0	11.5	8.0
I-514-M32	M32 x 1.5	37.0	12.0	8.0
I-514-M40	M40 x 1.5	46.0	13.0	8.0
I-514-M50	M50 x 1.5	56.0	15.0	10.0
I-514-M63	M63 x 1.5	70.0	17.0	12.0

Part No.	Fits to thread PG	Outside Ø [mm]	Total length [mm]	Thread length [mm]
I-514-07	7	15.0	8.0	6.0
I-514-09	9	19.0	9.5	6.5
I-514-11	11	22.0	10.0	6.5
I-514-13	13.5	25.0	10.0	6.5
I-514-16	16	27.0	10.0	6.5
I-514-21	21	33.0	12.0	8.0
I-514-29	29	44.0	11.5	8.0
I-514-36	36	55.0	14.0	10.0
I-514-48	48	68.0	16.0	12.0

PMA Connectors - Accessories





PMA

igus®
e-chain system®

Telephone 1-800-521-2747

Internet: igus.com
email: sales@igus.com
QuickSpec: igus.com/quickspec





11.23

Standard Corrugated Conduits						
Products		CYL PA6	VCS PA6	PIS PA12	FH	VH
Tube size: metric	width [mm]	Very flexible, medium wall corrugated conduits	Flexible, very heavy corrugated conduits	Highly flexible medium wall corrugated conduits	PMACLIP - one-piece system support	PMACLIP two-piece system support
10	07	CYLT-07* -	VCST-07* -	PIST-07* -	*FH-07-0	*VH-17-000
12	10	CYLT-10* -	VCST-10* -	PIST-10* -	*FH-10-0	*VH-23-000
16	12	CYLT-12* -	VCST-12* -	PIST-12* -	*FH-12-0	*VH-29-000
20	17	CYLT-17* -	VCST-17* VCSG-17*	PIST-17* PISG-17*	*FH-17-0	*VH-36-000
25	23	CYLT-23* CYLG-23*	- VCSG-23*	PIST-23* PISG-23*	*FH-23-0	*VH-48-000
32	29	CYLT-29* CYLG-29*	- VCSG-29*	PIST-29* PISG-29*	*FH-29-0	
40	36	CYLT-36* CYLG-36*	- VCSG-36*	PIST-36* PISG-36*	*FH-36-0	
50	48	CYLT-48* CYLG-48*	- VCSG-48* VCSG-56* VCSG-70* VCSG-95*	PIST-48* PISG-48*	*FH-48-0	

* = replaced by "B" for black or "S" for gray

T or D = fine profile

G = coarse profile

Standard Corrugated Conduits						
Products		CYL PA6	VCS PA6	PIS PA12	FH	VH
Tube size: metric	width [mm]	Very flexible, medium wall corrugated conduits	Flexible, very heavy corrugated conduits	Highly flexible medium wall corrugated conduits	PMACLIP - one-piece system support	PMACLIP two-piece system support
10	07	CYLT-07* -	VCST-07* -	PIST-07* -	*FH-07-0	*VH-17-000
12	10	CYLT-10* -	VCST-10* -	PIST-10* -	*FH-10-0	*VH-23-000
16	12	CYLT-12* -	VCST-12* -	PIST-12* -	*FH-12-0	*VH-29-000
20	17	CYLT-17* -	VCST-17* VCSG-17*	PIST-17* PISG-17*	*FH-17-0	*VH-36-000
25	23	CYLT-23* CYLG-23*	- VCSG-23*	PIST-23* PISG-23*	*FH-23-0	*VH-48-000
32	29	CYLT-29* CYLG-29*	- VCSG-29*	PIST-29* PISG-29*	*FH-29-0	
40	36	CYLT-36* CYLG-36*	- VCSG-36*	PIST-36* PISG-36*	*FH-36-0	
50	48	CYLT-48* CYLG-48*	- VCSG-48* VCSG-56* VCSG-70* VCSG-95*	PIST-48* PISG-48*	*FH-48-0	

* = replaced by "B" for black or "S" for gray







T or D = fine profile

G = coarse profile

JUMBO Corrugated Conduits PMAGRIP					
Products		PIHG PA12	BGG	BGO	SGS
Tube size: Width [mm]		Highly flexible medium wall corrugated conduits	PMAGRIP- straight	PMAGRIP- 90° angle	PMAGRIP- tube clamps
56		PIHG-56*	*GG-56	*GO-56	SGS-56
70		PIHG-70*	*GG-70	*GO-70	SGS-70
95		PIHG-95*	*GG-95	*GO-95	SGS-95
125		PIHG-125*	*GG-125	-	SGS-125

PMA Connectors - Accessories

PMA

PMAFIX							
Products		IP66 - VN 90° angle	IP66 - VA 45° angle	IP66 - VW 90° angle	IP66 - VB 90° elbow angle	IP68 - VNZ straight with strain relief	MN
Thread Typ		PMAFIX straight	PMAFIX 45° angle	PMAFIX 90° angle	PMAFIX 90° elbow angle	Straight with strain relief	PMA hexagonal lock nuts
M12x1.5		*VND-M12MGT	–	*VWD-M12MGT	–	–	*MN-M12
M12x1.5		*VND-M120GT	*VAD-M120GT	*VWD-M120GT	–	–	*MN-M12
M16x1.5		*VND-M162GT	*VAD-M162GT	*VWD-M162GT	–	*VNZ-M162S	*MN-M16
M20x1.5		*VND-M207GT	*VAD-M207GT	*VWD-M207GT	*VBD-M207GT	*VNZ-M207S	*MN-M20
M25x1.5		*VND-M253GT	*VAD-M253GT	*VWD-M253GT	*VBD-M253GT	*VNZ-M253S	*MN-M25
M32x1.5		*VND-M329GT	*VAD-M329GT	*VWD-M329GT	*VBD-M329GT	*VNZ-M329S	*MN-M32
M40x1.5		*VND-M406GT	*VAD-M406GT	*VWD-M406GT	*VBD-M406GT	*VNZ-M406S	*MN-M40
M50x1.5		*VND-M508GT	*VAD-M508GT	*VWD-M508GT	*VBD-M508GT	*VNZ-M508S	*MN-M50

* = replaced by "B" for black or "S" for gray

PMAFIX						
Products		IP66 - VOD 90° flange	IP66 - VY Y-distribution piece	IP66 - FT/VT T-distribution piece	IP66 - FV V-distribution piece	SGB
Tube size: metric	width [mm]	PMAFIX flange 90°	PMAFIX Y-distribution piece	PMAFIX T-distribution piece	PMAFIX V-distribution piece	PMAFIX-tube clamps
10	07	–	–	–	–	SGB-07
12	10	–	*VYD-100707GT	*FTD-101010GT	*FVD-100707GT	SGB-09
16	12	–	*VYD-121010GT	*FTD-121212GT	*FVD-121010GT	SGB-11
20	17	*VOD-P167GT	*VYD-171212GT	*FTD-171717GT	*FVD-171212GT	SGB-16
25	23	*VOD-P213GT	*VYD-231717GT	*FTD-232323GT	*FVD-231717GT	SGB-21
32	29	*VOD-P299GT	*VYD-292323GT	*FTD-292929GT	–	SGB-29
40	36	*VOD-P366GT	*VYD-362929GT	*FTD-363636GT	–	SGB-36
50	48	*VOD-P488GT	*VYD-483636GT	–	–	SGB-48

* = replaced by "B" for black or "S" for gray

PMAFIX - Order Example

XXXX-10 07 07 XX



PMAFIX - Distribution Piece

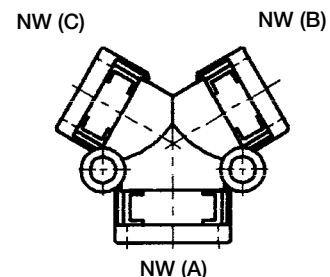
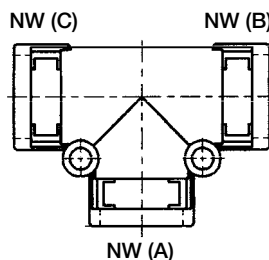
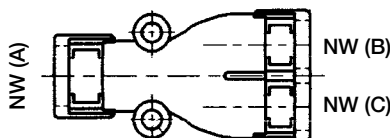

igus®
e-chain system®

Telephone 1-800-521-2747

Internet: igus.com
email: sales@igus.com
QuickSpec: igus.com/quickspec

General Index

Design

Designing with igus®	1.4
Application Examples	1.5
Chain Length calculation, camber	1.8
System Analysis	1.9

Applications

Unsupported – Short Travels	1.11
Unsupported Charts	1.15
Gliding – Long Travels	1.21
Vertical Hanging	1.25
Vertical Standing	1.27
Zig-Zag / leftband	1.28
Side-Mounted	1.29
Rotary Motion	1.31
Twisterchain, twisterband, e-spool	1.34

Cable and Hose Packages

General Rules	1.35
Strain Relief	1.39

Technical Data & Standards

Technical Data	1.41
ESD & ATEX	1.43
Cleanroom & ESD	1.45
Dirt Environments	1.46
Material Data/ igumid® G	1.47
Colors	1.47
Chemical Resistance	1.48
Standards and Certification	1.49

readychain & readycable

readychain®	1.50
readycable	1.59

igus® Assembly Service

Assembly Service	1.61
------------------	------

e-chain® by Series

e-rib

EL.00.23.0	2.11
EL.01.29.0	2.12
EL.00.36.0	2.13
EL.00.48.0	2.14

E1 e-chain®

E1-10	2.23
E1-17	2.24
E1-18	2.25
E1-20	2.26

SnapChain

TE14-50 / TZ14-50	2.30
TE26-120 / TZ26-120	2.32

Office chain

ZF14	2.37
------	------

E-Z chain®

E03	2.47
E04	2.51
E045 / Z045	2.55
E06 / Z06	2.61
E065/Z065	2.65
E08 / Z08	2.71
E14 / Z14	2.75
E200 / Z200	2.79
E16 / Z16	2.85
E26 / Z26	2.89
E300 / Z300	2.95

Zipper Chain

047	3.7
07	3.11
R07	3.15
09	3.19
R09	3.23
15	3.27
R15	3.33
17	3.39
R17	3.45

E-2 Micro

03	4.7
04	4.11
05	4.15
045	4.19
06	4.23
E2-10 / E2i-10 / E2C-10	4.27
B07	4.33

B09	4.37
E2-15 / E2i-15 / E2C-15	4.41
08	4.47

E2 Mini e-chains®

10	4.57
11.031	4.63
11.080	4.67
11.1/11.2	4.71
14	4.75
B15 / B15i	4.79
B17 / B17i	4.85
F17	4.91

E2/000 e-chains®

1400 / 1500	4.103
1450 / 1480	4.113
2400 / 2500	4.121
2450 / 2480	4.131
2600 / 2700	4.141
2650 / 2680	4.151
3400 / 3500	4.161
3450 / 3480	4.171
255	4.181

R100 tubes

R117 / R118	5.9
R157 / R158	5.15
R167 / R168	5.23

R tubes

R48	5.33
R58	5.41
R68	5.49

R2.1 tubes

R2.75	5.61
-------	------

RX tubes

RX32	5.73
RX40	5.77
RX48	5.81
RX56	5.85

E4-1 e-chain®	
E4-21	6.9
E4-28	6.15
E4-32	6.27
E4-42	6.41
E4-56	6.57
E4-80	6.73
E4-112	6.89
E4-162	6.103
600 / 601 / R608	6.109
800	6.117
840	6.123
E4-350	6.131

E4-1 Light e-chain®	
E4-31L / R4-31L	6.143
E4-38L / R4-38L	6.153
E4-48L / R4-48L	6.165
E4-64L	6.179

E4/light e-chain®	
14040 / 14140 / R18840	6.193
14240 / 14340	6.205
14550 / 14650 / R19050	6.217
15050 / 15150 / R19850	6.227
15250 / 15350	6.241
1640 / R1608	6.251

T3 e-chain®	
T3-29	7.11

E3 e-chain®	
E3-10	7.23
E3-15	7.27
E3-22	7.31

E6-1 e-chain®	
EF61.29	7.41
E61-29	7.41
E61.35	7.47
E61.40	7.53
E61.52	7.61

E6 e-chain®	
E6-29	7.71
R6-29	7.77
E6-35	7.81
E6-40	7.87

R6-40	7.93
E6-52	7.97
R6-52	7.103
E6-62	7.107
E6-80	7.115
E6-80L	7.125

e-skin	
SK28	7.141
SK40	7.145

TH3	
TH3.25	7.153
TH3.45	7.159

triflex® R	
TRC	8.13
TRE	8.15
TRCF	8.17
TRL	8.19
TRLF	8.21

Cable management systems	
Cobots	8.39
RSE linear	8.47
RS modular	8.53
RSP pneumatic	8.57
RSE wheel	8.63
RSEL linear	8.69

E-Z triflex®	
E331	8.90
E332	8.91
E333	8.93

triflex®	
331/351	8.103
332/352	8.104
333/353	8.105

twisterchain®	
2208	8.115
TC-32	8.117
TC-42	8.119
TC-56	8.121

twisterband	
TB12	8.137

TB20	8.137
TB29	8.137
TB30	8.137

twisterband HD	
TBHD30	8.141
TBHD42	8.141

Special Solutions	
e-spool	9.7
liftband	9.26
guidelok p / p.s	9.32
guidelok horizontal	9.38
basic flizz®	9.42
micro flizz®	9.46
isense - predictive maintenance	9.56
PPDS	9.72
Modular projects	9.76

e-chains® for long travels	
E4/4HD	9.87
P4	9.117
rol e-chain®	9.139
autoglide	9.155

Guide Trough	
Super-aluminum trough	9.197
Steel trough	9.223
Support tray	9.247
guidefast	9.257
guidelite	9.261

Strain Relief	
Clamps	10.17
Tiewrap plates	10.21
CFU Honeycomb strain relief	10.25
Strain relief separators	10.27
Strain relief element	10.31
Chainfix nuggets	10.32
Strain relief connector system	10.33

PMA Tubing	
PACOF	11.5
PPCOF	11.6
LN / LNO	11.7
VCS	11.8
PIS/PIH	11.9
CYL	11.10

igus[®] locations



igus® worldwide

igus® Offices	10 Canada	20 Estonia	28 Ireland	39 Mexico
igus® Distributors	igus® Office Canada Suite 100-180 Bass Pro Mills Dr Vaughan, ON L4K 5W4 Phone +1 905 7608448 Fax +1 905 7608688 webmaster@igus.com	igus® OÜ Lõotsa 4A Tallinn 11415 Phone +372 667 5600 Fax +372 667 5601 info@igus.ee	igus® Ireland Caswell Rd Northampton NN4 7PW Phone +44-1604 677240 Fax +44-1604 677242 sales@igus.ie	igus® México S. de R.L. de C.V. Boulevard Aeropuerto Miguel Alemán 160 Int. 135 Col. Corredor Industrial Toluca Lerma Lerma, Estado de México C.P. 52004 Phone +52 728284 3185 Fax +52 728284 3187 fmarquez@igus.com
1 Germany	11 Chile	21 Finland	29 Israel	40 Middle East (except of UAE)
igus® GmbH Spicher Str. 1a 51147 Köln P.O. Box 90 61 23 51127 Köln Phone 02203 9649-0 Fax 02203 9649-222 info@igus.de, www.igus.de	Vendortec Avda. Los Pajaritos 3195, Oficina 1410 Edificio Centro Maipú Maipú - Santiago Phone +56 22 710 58 25 +56 23 245 02 00 ventas@vendortec.cl	OEM Finland OY Fiskarsinkatu 3 20750 Turku PL 9, 20101 Turku Phone +358 20 7499499 Fax +358 20 7499456 info@oem.fi	Conlog LTD P.O. Box 3265 17 Hamefalssim Str. Industrial Zone Kiryat Arie Petach-Tikva 49130 Phone +972 3 9269595 Fax +972 3 9233367 conlog@conlog.co.il	JISig Middle East FZE FF07, Jebel Ali Free Zone PO Box- 17483 Dubai, United Arab Emirates Phone +971 4222 1185 Fax +971 4222 1186 info@jisigus.com
2 Argentina	12 China	22 France	30 Italy	41 Myanmar
Borintech SRL Av. Elcano 4971 C1427CIH Buenos Aires Phone +5411 4556 1000 Fax +5411 4556 1000 igus@borintech.com	igus® Shanghai Co., Ltd. No.50, North Huancheng Road Fengxian district Shanghai 201401 P. R. China Phone +86 21 8036 6999 Fax +86 21 8036 6116 cnmaster@igus.net	igus® SARL 49, avenue des Pépinières Parc Médicis 94260 Fresnes Phone +33 1 49840404 Fax +33 1 49840394 info@igus.fr	igus® S.r.l. Via delle Rovedine, 4 23899 Robbiate (LC) Phone +39 039 5906.1 Fax +39 039 5906.222 igusitalia@igus.it	Sea Lion Co. Ltd. 181 Bo Myat Tun St Botataung Yangon 11161 Myanmar Phone +95 1 29 97 97 Fax +95 1 20 27 51 zaw.m.thant@sealionmyanmar.com
3 Australia	13 Colombia	23 Greece	31 Japan	42 Netherlands
Treotham Automation Pty. Ltd. 14 Sydenham Road Brookvale NSW 2100 Phone +61 2 9907-1788 Fax +61 2 9907-1778 info@treotham.com.au	Productos SAS Calle 33A, #21-09 Bogotá Phone +57 1 561 2959 ext. 113 igus@igus.com.co	J. & E. Papadopoulos S.A. 12 Polidefkous str Piraeus, 185 40 Phone +30 210 4113133 Fax +30 210 4116781 sales@papadopoulos-sa.com	igus® k.k. Arcacentral 15F, 1-2-1 Kinshi, Sumida-ku Tokyo JAPAN Zip 130-0013 Phone +81 358 192030 Fax +81 358 192055 info@igus.co.jp	igus® B.V. Sterrenbergweg 9 3769 BS Soesterberg Phone +31 346 353932 Fax +31 346 353849 info@igus.nl
4 Austria	14 Costa Rica	23 Greece	32 Kenya	42 Netherlands – dry-tech®
igus® polymer Innovationen GmbH Photo-Play-Straße 1 4860 Lenzing Phone +43 7662 57763 Fax +43 7662 57751 igus-austria@igus.de	Enesa Equipos Neumaticos S.A. Del Colegio Marista 100 este, 200 sur, 25 este Urbanizacion Ciruelas Alajuela, Costa Rica Phone +506 2440-2393 Fax +506 2440-2393 equiposneumaticos@enesa.net	Chrismotor s.a. 71, Sp. Patsi str. 118 55 Athens Phone +30 210 34 25574 Fax +30 210 3425595 info@chrismotor.gr	Mantrad Ltd. Sterling House, 1st. Floor Moi Avenue, Mombasa Phone + 254 722 706 830 Fax + 254 720 765 566 info@mantrad.co.ke	Elcee B.V. Kamerlingh Onnesweg 28 NL-3316 GL Dordrecht Phone +31 (0)78-654 47 77 Fax +31 (0)78-654 47 33 info@elcee.nl
5 Belarus	15 Croatia	24 Hong Kong	33 Latvia	43 Nigeria
SOOO Hennlich Biryuzova street, 4/5, office 1012 220073 Minsk Republik Belarus Phone +375 17 258 88 28 Fax +375 17 373 39 26 info@hennlich.by	Hennlich, Industrijska d. o. o. Stupničkoobreška 17 Stupnički Obrež 10255 Gornji Stupnik Phone +385 1 3874334 Fax +385 1 3874336 hennlich@hennlich.hr	Sky Top Enterprises Ltd. Room 1806 ; Block C; Wah Tat Industrial Center; Wah Sing Street; Kwai Chung Hong Kong Phone +852 23318928 Fax +852 24269738 info@skytopy.com.cn	Techvitas SIA Daugavas iela 38-3 Mārupe, LV-2167 Phone +372 667 5600 Fax +372 667 5601 i_igusLettland_G@igus.de	Deepee Industrials Ltd. 11 Ishaga Road Surulere Lagos Phone +234 803 3899107 ovoachinike@deepeeindustrials.com
6 Belgium/Luxembourg	16 Czech Republic	25 Hungary	34 Lebanon	44 New Zealand
igus® B.V.B.A. Jagersdreef 4A 2900 Schoten Phone +32 3 330 13 60 Fax +32 3 313 79 91 info@igus.be	HENNLICH s.r.o. Českolipská 9 412 01 Litoměřice Phone e-chains® +420 416 711332 Phone Plain bearings +420 416 711339 Fax +420 416 711999 lin-tech@hennlich.cz	igus® Hungária Kft. Ipari Park u.10. 1044 Budapest Phone +36 1 3066486 Fax +36 1 4310374 info@igus.hu	Mecanix Shops SAL Horsh Tablet - Ste Rita blvd P.O.Box: 55384 Beirut Phone +961 1 486701 Fax +961 1 490929 sales@mecanixshops.com	Treotham Automation Pty Ltd. Stocking Distributor 13c Vogler Drive Wiri Auckland 2104 Phone +64 9 278 6577 Fax +64 9 278 6578 info@treotham.co.nz
7 Bosnia + Herzegovina	17 Denmark	26 India	35 Lithuania	45 Norway
HENNLICH industrijska tehnika d.o.o. Tvornička 3 (Energoinvest-zgrada C&O) BiH-71210 Iliđa - Sarajevo Phone +387 33 451 439 Fax +387 33 451 439 info@hennlich.ba	igus® ApS Lysholt Alle 8 DK-7100 Vejle Phone +45 86 603373 Fax +45 86 60 32 73 info@igus.dk	igus® (India) Pvt. Ltd. 36/1, Sy No. 17/3 Euro School Road, Dodda Nekkundi Industrial Area, - 2nd Stage Mahadevapura Post Bangalore 560048 Phone +91 80 68127800 Fax +91 80 68127802 info-in@igus.net	Hitech UAB Terminalo g. 3 54469 Biruliškiu k. (Kauno LEZ) Kauno raj. Phone +370 37 323271 Fax +370 37 203273 info@hitech.lt	ASI Automattik AS Sankt Hallvards vei 3, port 8 3414 Lierstranda Phone +47 9006 1100 info@asiflex.no
8 Brazil	18 Ecuador	27 Indonesia	36 Macedonia, Albania, Kosovo	46 Peru
igus® do Brasil Ltda. Rua Antônio Christi, nº 611 Parque Industrial III – FAZGRAN Jundiá – CEP 13213-183 – SP Phone +55 11 3531-4487 Fax +55 11 3531-4488 vendas@igus.com.br	Ecuainsetec Yugoeslavia N34-110 y Azuay Quito Phone +593 2 2253757 Fax +593 2 2461833 info@ecuainsetec.com.ec	PT igus® Indonesia Headquarter Indonesia Taman Tekno BSD Sektor XI, Blok L1 No. 15 Tangerang Selatan 15314 Phone +62 21 7588 1933 Fax +62 21 7588 1932 info@igus.co.id	Hennlich doo Beograd Radomira Markovića 1/3 11222 Beograd Phone +381 11 63 098 17 Fax +381 11 63 098 20 office@hennlich.rs	PROIGUS S.A.C. Calle Bolivar 388/of. 203 Miraflores Lima 18 – Perú Phone +51 1 2414370 Fax +51 1 2428608 profacoventas@profaco.com
9 Bulgaria	19 Egypt	37 Malaysia	38 Morocco	47 Pakistan
igus® EOOD 2, Lui Ayer str., fl.4, off. 4 1404 Sofia, Bulgaria Phone +359 2 850 8409 Fax +359 2 850 8409 info@igus.bg	IEE International Company for Electrical Engineering 2nd floor, 25 Orabi St Down Town, Cairo Phone +202 25767370 Fax +202 25767375 sales@iee-egypt.com	igus® Malaysia Sdn Bhd Suite 1601-1, Level 16, Tower 2, Wisma AmFirst, Jalan SS 7/15 (Jalan Stadium), 47301 Kelana Jaya, Selangor Phone +603 7803 0618 Fax +603 7886 1328 info@igus.my	AFIT 5, Rue Amir Abdelkader 20300 Casablanca Phone +212 522 633769 Fax +212 522 618351 souria.vu@premium.net.ma	GEMS International Trading 501, Windsong Place, Block 7&8, K.C.H.S, Off Shaheed-e-Millat Rd. Karachi - 75350 Phone +92 21 34531505 marketing@gemsinter.com
9 Bulgaria				48 Philippines
Hennlich OOD, BG 4003 Plovdiv, Bulgaria 147A, Brezovsko shose Str., Rota center, fl. 3 Phone +359 32 511 326 Fax +359 32 621 929 office@hennlich.bg				Silicon Exponents Corp. Unit 1-B, 8414 LMN Bldg. Dr. A. Santos Avenue Brgy.BF Homes Sucat Parañaque City 1700 Philippines Phone +63 2 8250 126/135 Fax +63 2 8250 141 ryemrigor@sieplus.ph

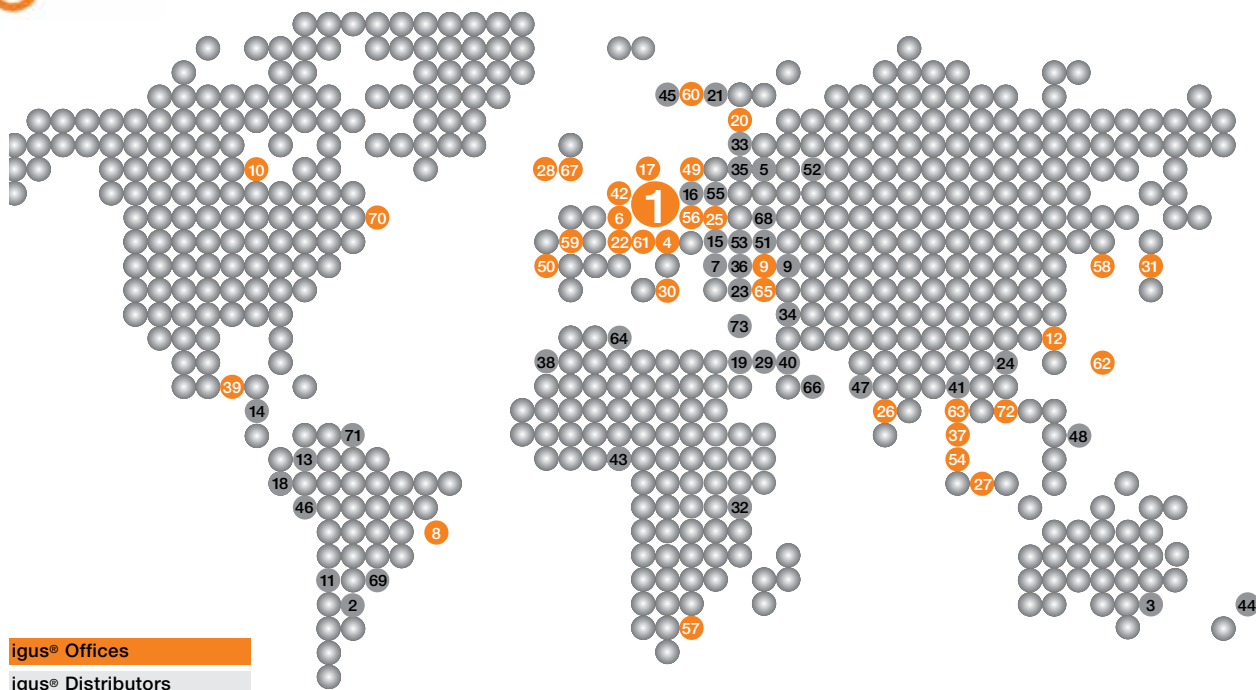

igus® Offices

igus® Distributors

49 Poland

igus® Sp. z o.o.
ul. Działkowa 121C
02-234 Warszawa
Phone +48 22 8635770
Fax +48-22 8636169
info@igus.pl

50 Portugal

igus® Lda.
R. Eng. Ezequiel
Campos, 239
4100-231 Porto
Phone +351 22 6109000
Fax +351 22 8328321
info@igus.pt

51 Romania

Hennlich SRL
Str. Patria, Nr17
310106 Arad
Phone +40 257 211119
Fax +40 257 211021
igus@hennlich.ro

52 Russia

OOO Hennlich
Room 14
Naberezhnaya reki Lazuri, 15A
170028 Tver
Russian Federation
Phone +7 4822 787 180
Fax +7 4822 787 180, add. 380
hennlich@hennlich.ru

53 Serbia + Montenegro

Hennlich doo Beograd
Radomira Markovica 1/3
11222 Beograd / Srbija
Phone +381 11 63 098 17
Fax +381 11 63 098 20
office@hennlich.rs

54 Singapore-ASEAN HQ

igus® Singapore Pte Ltd
84 Genting Lane
#06-03 Axxel Innovation Centre
Singapore 349584
Phone +65 6487 1411
info@igus.com.sg

55 Slovakia

Hennlich s.r.o.
Na Bystricku 16
SK-036 01 Martin

56 Slovenia

igus® d.o.o.
Tržaška c. 134
1000 Ljubljana
Slovenija
Mob. +386 (0)30 601 610
info@igus.si

56 Slovenia

Hennlich, d. o. o.
Industrijska tehnika
Podnart 33
SI-4244 Podnart
Phone +386 4 53206-10
Fax +386 4 53206-20
info@hennlich.si

57 South Africa

igus® Pty. Ltd.
Unit 29
Midline Business Park
Cnr Le Roux & Richards Drive
Midrand 1682
Phone +27 11312-1848
Fax +27 11312-1594
sales.sa@igus.de

58 South Korea

igus® Korea Co. Ltd.
613-14 Namchondong,
Namdonggu
Incheon City, 405-846
Phone +82 32 82129-11
Fax +82 32 82129-13
info@igus.kr

59 Spain

igus® S.L.U.
Ctra. Llobatona, 6
Poligono Noi del Sucre
08840 Viladecans – BCN
Phone +34 936 473950
Fax +34 936 473951
igus.es@igus.es

60 Sweden

igus® AB
Berga Allé 1
254 52 Helsingborg
Phone +46 42 329270
Fax +46 42 211585
info@igusab.se

60 Sweden – the-chain

OEM Automatic AB
Box 1011 Dalagatan 4
573 28 Tranås
Phone +46 75 2424100
Fax +46 75 2424159
info@oemautomatic.se

60 Sweden – dry-tech®

Colly Components AB
Raseborgsgatan 9
P.O. Box 76
164 94 Kista
Phone +46 8 7030100
Fax +46 8 7039841
info@me.colly.se

61 Switzerland

igus® Schweiz GmbH
Winkelstr. 5
4622 Egerkingen
Phone +41 62 388 97 97
Fax +41 62 388 97 99
info@igus.ch

62 Taiwan

igus® Taiwan Company Ltd.
5F, No. 35, 24th Road
Taichung Industrial Park
Taichung 40850
Phone +886 4 2358-1000
Fax +886 4 2358-1100
info@igus.tw

63 Thailand

igus® Thailand Co., Ltd
1340 Soi Bangkok-Nonthaburi 30,
Bangkok-Nonthaburi Rd.,
Bangsue, Bangsue
Bangkok 10800
Phone +66 (0)2 587 4899
Fax +66 (0)2 587 4898
info@igus.co.th

64 Tunisia

BOUDRANT
53, Avenue de Carthage
1000 Tunis – Tunisia
Phone +216 71340244
Fax +216 71348910
info@boudrant.com.tn

65 Turkey

igus® Turkey
Güzeller Org. San. Bölğ.
Galvano Teknik San. Sit.
Cumhuriyet Cad. 2/32
P.K. 41400 Gebze / Kocaeli
Phone +90 262 502 14 08
Fax +90 262 502 14 19
info@igus.com.tr

65 Turkey

HIDREL Hidrolik Elemanlar
Sanayi ve Ticaret A.S.
Percemli Sk. No. 7
Tünel Mevkii
34420 Karaköy / Istanbul
Phone +90 212 2494881
Fax +90 212 2920850
info@hidrel.com.tr

66 UAE + Oman

Unigroup FZE
Plot of Land M6-01
Sharjah Airport Free Zone
P.O. Box 120300
Sharjah - U.A.E.
Phone +971 6 5578386
Fax +971 6 5578387
automation@unigroup.ae

67 United Kingdom

igus®
Caswell Rd
Northampton NN4 7PW
Phone +44 1604 677240
sales@igus.co.uk

68 Ukraine

Hennlich Ukraine LLC (HQ)
Kramatorska Street 15
84100 Sloviansk City,
Donetsky Region
Phone +38 06262 33540
hennlich@hennlich.com.ua

68 Ukraine

Cominpro GmbH
Romena Rollana 12,
Office 100
61058 Kharkov
Phone +380 57 7174914
Fax +380 57 7174914
cominpro@gmail.com

69 Uruguay

Larrique Rulemanes SA
Galicia 1204
Montevideo-Uruguay
Phone +598 29021773
Fax +598-29084824
larrique@larrique.com.uy

70 USA

igus® inc.
257 Ferris Avenue
P.O. Box 14349
East Providence
RI 02914
Phone +1 401 4382200
Fax +1 401 4387270
webmaster@igus.com

71 Venezuela

Neumatica Rotonda C.A.
Prolong Av. Michelena
C.C. Atlas Locales B-10 y
B-11
Valencia, Edo. Carabobo
Phone +58 241 832.64.64
+58 241 832.32.50
+58 241 838.88.19
Fax +58 241 832.62.83
ventas@neumaticar.com

72 Vietnam

igus® Vietnam Company Ltd
177 Huynh Lan Khanh Street,
Ward 2
District Tan Binh, HCM City,
Vietnam
Phone +84 28 3636 4189
info@igus.vn

73 Zypern

G.C.V. Spare Parts & Services Ltd (HQ)
Industrial Area Anatoliko
8068 Pafos
Phone +357 26 812444
Fax +357 26 812447
igus@gcv-parts.com

9001:2015

igus® is certified in accordance with ISO 9001:2015 and IATF 16949:2016 in the field of energy supply systems, cables and harnessing, as well as plastic bearings.

igus.com

Shop online 24/7!

More catalogs and brochures online –

www.igus.com/downloads

No minimum order quantities, no surcharges.

100,000 products available from stock.

IN THE USA:

257 Ferris Avenue

East Providence, RI 02914

Tel.: 1-800-521-2747

Fax: 1-401-438-7270

IN MEXICO

Igus Mexico S. de R.L de C.V

Bldv. Aeropuerto 160 Int 135

Col. Corredor Industrial Toluca-Lerma

Toluca, C.P 52004

Tel.: (52) 728-284-3185

Fax: (52) 722-271-4274

IN CANADA:

180 Bass Pro Mills Drive, Suite 100

Concord, Ontario

Canada L4K 0B9

Tel.: 1-800-965-2496

Fax: 1-905-760-8688

We also offer over 1,400 types of motion cables.

Call or email us for your copy of our chainflex® cable catalog.

sales@igus.com

Refer to our website for a complete list of our sales locations.



igus plastics